



User's Guide

LTE Series

Default Login Details

LAN IP Address	http://192.168.11
Login	admin
Password	See the Zyxel Device label

Version 1.00_2.00 Ed 4, 3/2020

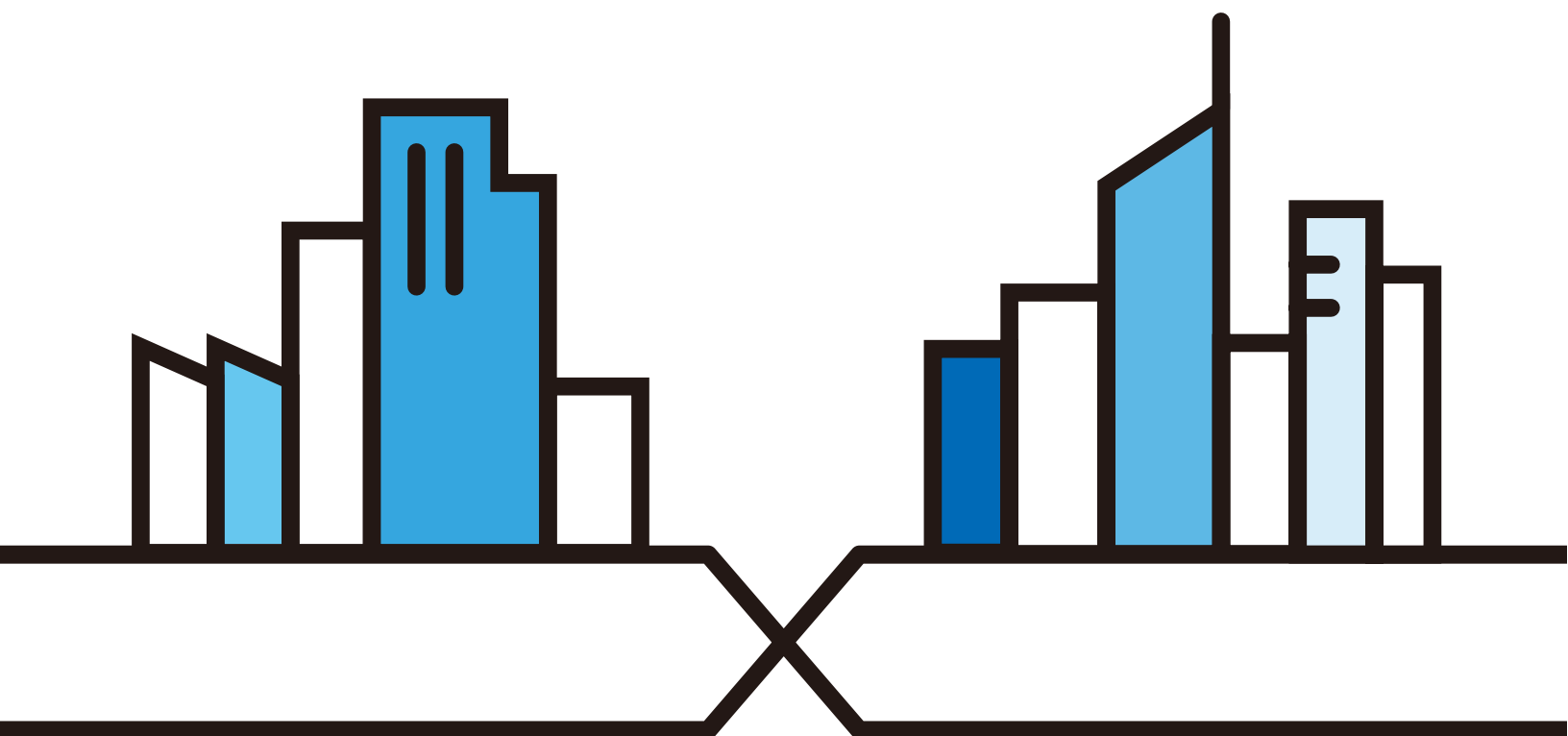

IMPORTANT!

READ CAREFULLY BEFORE USE.

KEEP THIS GUIDE FOR FUTURE REFERENCE.

This is a series User's Guide. Screenshots and graphics in this book may differ slightly from what you see due to differences in your product firmware or your computer operating system. Every effort has been made to ensure that the information in this manual is accurate.

Related Documentation

- Quick Start Guide

The Quick Start Guide shows how to connect the Zyxel Device.

- More Information

Go to support.zyxel.com to find other information on the Zyxel Device.



Document Conventions

Warnings and Notes

These are how warnings and notes are shown in this guide.

Warnings tell you about things that could harm you or your Zyxel Device.







Note: Notes tell you other important information (for example, other things you may need to configure or helpful tips) or recommendations.

Syntax Conventions

- The LTE device in this user's guide may be referred to as the "Zyxel Device" in this guide.
- Product labels, screen names, field labels and field choices are all in **bold** font.
- A right angle bracket (>) within a screen name denotes a mouse click. For example, **Network Setting > Routing > DNS Route** means you first click **Network Setting** in the navigation panel, then the **Routing** submenu and finally the **DNS Route** tab to get to that screen.

Icons Used in Figures

Figures in this user guide may use the following generic icons. The Zyxel Device icon is not an exact representation of your Zyxel Device.

Zyxel Device 	Generic Router 	Switch 
Server 	Firewall 	USB Storage Device 
Printer 		

Contents Overview

User's Guide	15
Introduction	16
The Web Configurator	35
Quick Start	44
Tutorials	48
Technical Reference	70
Connection Status	71
Broadband	83
Wireless	99
Home Networking	131
Routing	154
Network Address Translation (NAT)	162
Dynamic DNS Setup	175
USB Service	179
Firewall	184
MAC Filter	195
Parental Control	197
Certificates	201
Voice	210
Log	223
Traffic Status	226
ARP Table	229
Routing Table	231
WLAN Station Status	234
VoIP Status	236
Cellular WAN Status	239
System	244
User Account	245
Remote Management	248
TR-069 Client	253
Time Settings	255
E-mail Notification	258
Log Setting	261
Firmware Upgrade	264
Backup/Restore	266
Diagnostic	269
Troubleshooting	271

Appendices278

Table of Contents

Document Conventions	3
Contents Overview	4
Table of Contents	6
Part I: User's Guide	15
Chapter 1	
Introduction	16
1.1 Overview	16
1.2 Application for the Zyxel Device	18
1.2.1 WAN Priority (LTE3301-PLUS / LTE5388-M804 / LTE5398-M904 / LTE3316-M604)	20
1.3 Manage the Zyxel Device	20
1.4 Good Habits for Managing the Zyxel Device	20
1.5 Front and Bottom Panels	21
1.5.1 LEDs (Lights)	24
1.5.2 Panel Ports & Buttons	28
1.5.3 Turning On/Off WiFi	29
1.5.4 The RESET Button	31
1.6 Wall Mounting	33
Chapter 2	
The Web Configurator	35
2.1 Overview	35
2.1.1 Access the Web Configurator	35
2.2 Web Configurator Layout	37
2.2.1 Settings Icon	37
2.2.2 Widget Icon	42
Chapter 3	
Quick Start	44
3.1 Overview	44
3.2 Quick Start Setup	44
3.3 Time Zone	44
3.4 The Internet Connection Setup	45
3.4.1 Successful Internet Connection	45
3.4.2 Unsuccessful Internet Connection	46

3.5 Quick Start Setup-Wireless	46
3.6 Quick Start Setup-Finish	47
Chapter 4	
Tutorials	48
4.1 Overview	48
4.2 Set Up a Wireless Network Using WPS	48
4.2.1 Push Button Configuration (PBC)	49
4.2.2 PIN Configuration	50
4.3 Connect to the Zyxel Device's WiFi Network	51
4.4 Use Multiple SSIDs on the Zyxel Device	54
4.4.1 Configure Security Settings of Multiple SSIDs	54
4.5 Make a VoIP/VoLTE Phone Call	58
4.6 Configure a Firewall Rule	59
4.7 Configure MAC Filter	60
4.8 Upgrade Firmware on the Zyxel Device	61
4.9 Back up a Configuration File	62
4.10 Restore Configuration	62
4.11 Connect to the Internet	63
4.12 Configure DHCP	64
4.12.1 Add Devices to Your Static DHCP List	64
4.13 Configure Static Route for Routing to Another Network	65
4.14 Access the Zyxel Device Using DDNS	68
4.14.1 Register a DDNS Account on www.dyndns.org	68
4.14.2 Configure DDNS on Your Zyxel Device	68
4.14.3 Test the DDNS Settings	69
Part II: Technical Reference.....	70
Chapter 5	
Connection Status.....	71
5.1 Connection Status Overview	71
5.1.1 Connectivity	71
5.1.2 System Info	72
5.1.3 Cellular Info	74
5.1.4 WiFi Settings	78
5.1.5 Guest WiFi Settings	79
5.1.6 LAN	81
Chapter 6	
Broadband.....	83

6.1 Overview	83
6.1.1 What You Can Do in this Chapter	83
6.1.2 What You Need to Know	84
6.1.3 Before You Begin	84
6.2 Broadband	84
6.2.1 Add/Edit Internet Connection	85
6.3 WAN Backup	89
6.4 Ethernet WAN	90
6.5 Cellular WAN	91
6.6 Cellular SIM Configuration	92
6.7 Cellular Band Configuration	93
6.8 Cellular PLMN Configuration	94
6.9 IP Passthrough	97

Chapter 7

Wireless 99

7.1 Overview	99
7.1.1 What You Can Do in this Chapter	99
7.1.2 What You Need to Know	99
7.2 General Settings	100
7.2.1 No Security	102
7.2.2 More Secure (WPA2-PSK)	103
7.3 Guest/More AP	104
7.4 More AP Edit	105
7.5 MAC Authentication	108
7.6 WPS	110
7.7 WMM	112
7.8 Others Screen	113
7.9 WLAN Scheduler	115
7.9.1 Add/Edit Rules	116
7.10 Channel Status	117
7.11 Technical Reference	118
7.11.1 WiFi Network Overview	118
7.11.2 Additional Wireless Terms	120
7.11.3 WiFi Security Overview	120
7.11.4 Signal Problems	122
7.11.5 BSS	122
7.11.6 Preamble Type	123
7.11.7 WiFi Protected Setup (WPS)	123

Chapter 8

Home Networking 131

8.1 Overview	131
--------------------	-----

8.1.1 What You Can Do in this Chapter	131
8.1.2 What You Need To Know	131
8.2 LAN Setup	132
8.3 Static DHCP	136
8.3.1 Before You Begin	136
8.4 UPnP	138
8.5 Technical Reference	139
8.6 Turn on UPnP in Windows 7 Example	140
8.6.1 Auto-discover Your UPnP-enabled Network Device	141
8.7 Turn on UPnP in Windows 10 Example	144
8.7.1 Auto-discover Your UPnP-enabled Network Device	146
8.8 Web Configurator Easy Access in Windows 7	149
8.9 Web Configurator Easy Access in Windows 10	151
Chapter 9	
Routing	154
9.1 Overview	154
9.2 Configure Static Route	154
9.2.1 Add/Edit Static Route	155
9.3 DNS Route	157
9.3.1 Add/Edit DNS Route	157
9.4 Policy Route	158
9.4.1 Add/Edit Policy Route	160
9.5 RIP Overview	161
9.5.1 RIP	161
Chapter 10	
Network Address Translation (NAT)	162
10.1 Overview	162
10.1.1 What You Can Do in this Chapter	162
10.1.2 What You Need To Know	162
10.2 Port Forwarding Overview	163
10.2.1 Port Forwarding	164
10.2.2 Add/Edit Port Forwarding	164
10.3 Port Triggering	166
10.3.1 Add/Edit Port Triggering Rule	168
10.4 DMZ	169
10.5 ALG	170
10.6 Address Mapping	171
10.6.1 Address Mapping Screen	171
10.6.2 Add New Rule Screen	172
10.7 Sessions	173

Chapter 11	
Dynamic DNS Setup	175
11.1 DNS Overview	175
11.1.1 What You Can Do in this Chapter	175
11.1.2 What You Need To Know	175
11.2 DNS Entry	176
11.2.1 Add/Edit DNS Entry	176
11.3 Dynamic DNS	177
Chapter 12	
USB Service	179
12.1 USB Service Overview	179
12.1.1 What You Need To Know	179
12.1.2 Before You Begin	180
12.2 USB Service	180
12.2.1 Add New Share	182
12.2.2 The Add New User Screen	183
Chapter 13	
Firewall	184
13.1 Overview	184
13.1.1 What You Need to Know About Firewall	184
13.2 Firewall	185
13.2.1 What You Can Do in this Chapter	185
13.3 Firewall General Settings	185
13.4 Protocol (Customized Services)	187
13.4.1 Add Customized Service	187
13.5 Access Control (Rules)	188
13.5.1 Add New ACL Rule Screen	189
13.6 DoS	191
13.7 Firewall Technical Reference	192
13.7.1 Firewall Rules Overview	192
13.7.2 Guidelines For Security Enhancement With Your Firewall	193
13.7.3 Security Considerations	193
Chapter 14	
MAC Filter	195
14.1 MAC Filter Overview	195
14.2 MAC Filter	195
14.2.1 Add New Rule	196
Chapter 15	
Parental Control	197

15.1 Overview	197
15.2 The Parental Control Screen	197
15.2.1 Add New Parental Control Rule	199
Chapter 16	
Certificates	201
16.1 Certificates Overview	201
16.1.1 What You Can Do in this Chapter	201
16.2 Local Certificates	201
16.2.1 Create Certificate Request	202
16.2.2 View Certificate Request	203
16.3 Trusted CA	205
16.4 Import Trusted CA Certificate	206
16.5 View Trusted CA Certificate	206
16.6 Certificates Technical Reference	207
16.6.1 Verify a Certificate	208
Chapter 17	
Voice	210
17.1 Overview	210
17.1.1 What You Can Do in this Chapter	210
17.2 Voice Mode	210
17.3 SIP	211
17.3.1 SIP Account	211
17.3.2 SIP Account Entry Edit	212
17.3.3 SIP Service Provider	215
17.3.4 Provider Entry Edit	215
17.4 Phone	219
17.5 Call Rule	219
17.6 Call History	220
17.6.1 Call History Screen	220
17.6.2 Call Summary Screen	221
Chapter 18	
Log	223
18.1 Log Overview	223
18.1.1 What You Can Do in this Chapter	223
18.1.2 What You Need To Know	223
18.2 System Log	224
18.3 Security Log	224
Chapter 19	
Traffic Status	226

19.1 Traffic Status Overview	226
19.1.1 What You Can Do in this Chapter	226
19.2 WAN Status	226
19.3 LAN Status	227
Chapter 20	
ARP Table.....	229
20.1 ARP Table Overview	229
20.1.1 How ARP Works	229
20.2 ARP Table	230
Chapter 21	
Routing Table.....	231
21.1 Routing Table Overview	231
21.2 Routing Table	231
Chapter 22	
WLAN Station Status	234
22.1 WLAN Station Status Overview	234
Chapter 23	
VoIP Status.....	236
23.1 VoIP Status Screen	236
Chapter 24	
Cellular WAN Status	239
24.1 Cellular WAN Status Overview	239
24.2 Cellular WAN Status	239
Chapter 25	
System.....	244
25.1 System Overview	244
25.2 System	244
Chapter 26	
User Account.....	245
26.1 User Account Overview	245
26.2 User Account	245
26.2.1 User Account Add/Edit	246
Chapter 27	
Remote Management.....	248
27.1 Overview	248

27.2 MGMT Services	248
27.3 MGMT Services for IP Passthrough	249
27.4 Trust Domain	250
27.5 Add Trust Domain	251
27.6 Trust Domain for IP Passthrough	251
27.7 Add Trust Domain	252
Chapter 28	
TR-069 Client.....	253
28.1 Overview	253
28.2 TR-069 Client	253
Chapter 29	
Time Settings.....	255
29.1 Time Settings Overview	255
29.2 Time	255
Chapter 30	
E-mail Notification	258
30.1 E-mail Notification Overview	258
30.2 E-mail Notification	258
30.2.1 E-mail Notification Edit	259
Chapter 31	
Log Setting	261
31.1 Log Setting Overview	261
31.2 Log Setting	261
Chapter 32	
Firmware Upgrade	264
32.1 Overview	264
32.2 Firmware Upgrade	264
Chapter 33	
Backup/Restore	266
33.1 Backup/Restore Overview	266
33.2 Backup/Restore	266
33.3 Reboot	267
Chapter 34	
Diagnostic.....	269
34.1 Diagnostic Overview	269
34.2 Ping/TraceRoute/Nslookup Test	269

Chapter 35
Troubleshooting.....271

- 35.1 Overview 271
- 35.2 Power and Hardware Connections 271
- 35.3 Zyxel Device Access and Login 272
- 35.4 Internet Access 273
- 35.5 USB Device Connection 275
- 35.6 UPnP 275
- 35.7 SIM Card 276
- 35.8 Cellular Signal 276

Part III: Appendices 278

- Appendix A Customer Support 279
- Appendix B IPv6..... 285
- Appendix C Legal Information 292

Index300

PART I

User's Guide

CHAPTER 1

Introduction

1.1 Overview

Zyxel Device refers to these models as outlined below.

- LTE3301-PLUS
- LTE7240-M403
- LTE7461-M602
- LTE7480-M804
- LTE7480-S905
- LTE7490-M904
- LTE5388-M804
- LTE5398-M904
- LTE3316-M604

The following table describes the feature differences of the Zyxel Device by model.

Table 1 Zyxel Device Comparison Table

	LTE3301-PLUS	LTE7240-M403	LTE7461-M602	LTE7480-M804
2.4G WLAN	√	√	√	√
5G WLAN	√	-	-	-
LTE Speed	300/50 Mbps	150/50 Mbps (FDD-LTE)	400/150 Mbps (FDD-LTE)	600/100 Mbps
	Note: These are the theoretical downlink/uplink rates. LTE speed is affected by strength of signal, network congestion, LTE band(s) or frequency(-ies) to which your Zyxel Device is connected, and so forth.			
Gigabit Ethernet Port	√	√	√	√
Ethernet WAN	Convert the fourth LAN port to work as a WAN port.	-	-	-
IP Passthrough	Available when the fourth LAN port doesn't act as an Ethernet WAN port.	√	√	√
USB for File Sharing	√	√	√	-
External Antennas	√	-	-	-
PoE Injector	-	√	√	-
Wall Mount	-	√	√	√
Pole Mount	-	-	√	√
Firmware Version	1.00	2.00	2.00	1.00

Table 2 Zyxel Device Comparison Table

	LTE7480-S905	LTE7490-M904	LTE5388-M804	LTE5398-M904	LTE3316-M604
2.4G WLAN	V	V	V	V	V
5G WLAN	-	-	V	V	V
LTE Speed	573/15.1 Mbps (TDD-LTE config. #2)	1200/150 Mbps	600/100 Mbps	1200/150 Mbps	300/50 Mbps
	Note: These are the theoretical downlink/uplink rates. LTE speed is affected by strength of signal, network congestion, LTE band(s) or frequency(-ies) to which your Zyxel Device is connected, and so forth.				
Gigabit Ethernet Port	V	V	V	V	V
Ethernet WAN	-	-	Convert the first LAN port to work as a WAN port.	Convert the first LAN port to work as a WAN port.	Convert the first LAN port to work as a WAN port.
IP Passthrough	V	V	Available when the first LAN port doesn't act as an Ethernet WAN port.	Available when the first LAN port doesn't act as an Ethernet WAN port.	Available when the first LAN port doesn't act as an Ethernet WAN port.
USB for File Sharing	V	-	V	V	-
External Antennas	-	-	-	-	-
PoE Injector	V	-	-	-	-
Wall Mount	V	V	-	-	V
Pole Mount	V	V	-	-	-
Firmware Version	2.00	1.00	1.00	1.00	2.00

The Zyxel Device is an LTE (Long Term Evolution) router that supports (but not limited to) the following:

- WAN Backup (LTE3301-PLUS / LTE5388-M804 / LTE5398-M904 / LTE3316-M604)
- Gigabit Ethernet connection
- DHCP (Dynamic Host Configuration Protocol) server
- NAT (Network Address Translation)
- DMZ (Demilitarized Zone)
- Port Forwarding/Triggering
- ALG (Application Layer Gateway)
- Embedded Bridge/Router mode
- Dynamic DNS (Domain Name System) for the first APN (Access Point Name)
- Static/Dynamic Route setting for RIP (Routing Information Protocol)
- Remote Management under Bridge mode
- Address Resolution Protocol (ARP)
- Firewall that uses Stateful Packet Inspection (SPI) technology
- Protects against Denial of Service (DoS) attacks
- Filter of LAN MAC address, LAN IP address and URLs
- Local and remote device management

- Firmware upgrade via TR-069 and Web Configurator

The embedded Web-based Configurator enables straightforward management and maintenance. Just insert the SIM card (with an active data plan) and make the hardware connections. See the Quick Start Guide for how to do the hardware installation, wall/pole mounting, and Internet setup.

1.2 Application for the Zyxel Device

Wireless WAN

The Zyxel Device can connect to the Internet through a 2G/3G/4G LTE SIM card to access a wireless WAN connection. Just insert a SIM card into the SIM card slot at the bottom of the Zyxel Device.

Note: You must insert the SIM card into the card slot before turning on the Zyxel Device.

You can install two external antennas to improve your wireless WAN signal strength. See [Table 1 on page 16](#) for the feature differences.

Wireless LAN (WiFi)

Wireless clients can connect to the LTE Device to access network resources and the Internet. Your LTE Device supports WiFi Protected Setup (WPS), which allows you to quickly set up a wireless network with strong security.

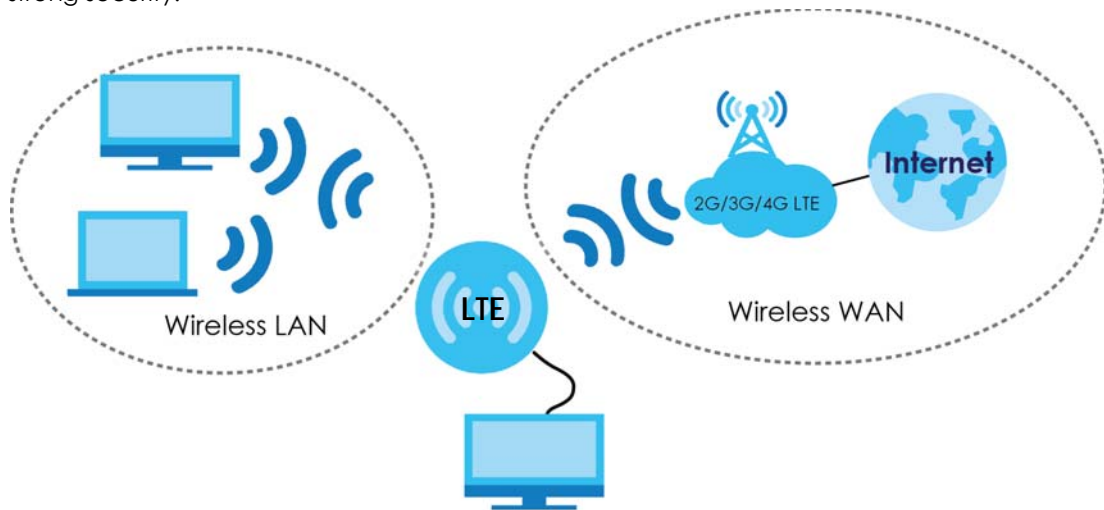

Internet Access

Your Zyxel Device provides shared Internet access by connecting to an LTE network. A computer can connect to the Zyxel Device's PoE injector or a LAN port for configuration via the Web Configurator. See [Table 1 on page 16](#) for the feature differences.

Figure 1 Zyxel Device's Internet Access Application

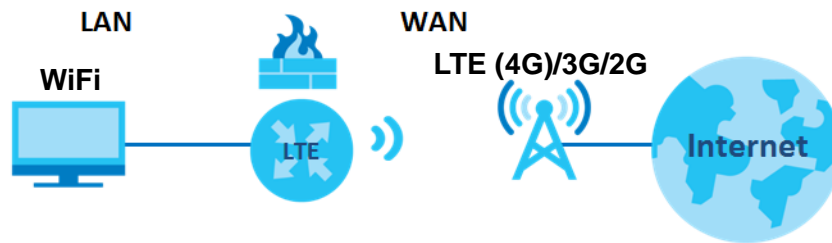

Carrier Aggregation (LTE7480-M804 / LTE7490-M904/ LTE5388-M804 / LTE5398-M904 / LTE3316-M604)

Carrier Aggregation (CA) is a technology to deliver high downlink data rates by combining more than one carrier in the same or different bands together.

Figure 2 Zyxel Device's CA Application

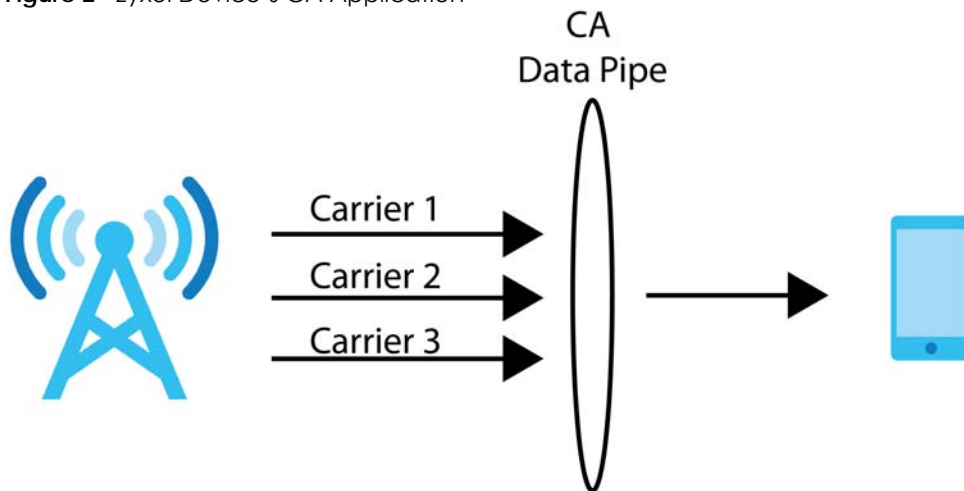

Ethernet WAN (LTE3301-PLUS / LTE5388-M804 / LTE5398-M904 / LTE3316-M604)

If you have another broadband modem or router available, you can use the Ethernet WAN port and then connect it to the broadband modem or router. This way, you can access the Internet via an Ethernet connection and still use the Firewall function on the Zyxel Device.

Note: For LTE3301-PLUS, convert LAN port number four as a WAN port first. See [Section 6.4 on page 90](#) for more information about the **Network Setting > Broadband > Ethernet WAN** screen.

Note: For LTE5388-M804 / LTE5398-M904 / LTE3316-M604, convert LAN port number one as a WAN port first. See [Section 6.4 on page 90](#) for more information about the **Network Setting > Broadband > Ethernet WAN** screen.

Figure 3 Zyxel Device's Internet Access Application: Ethernet WAN

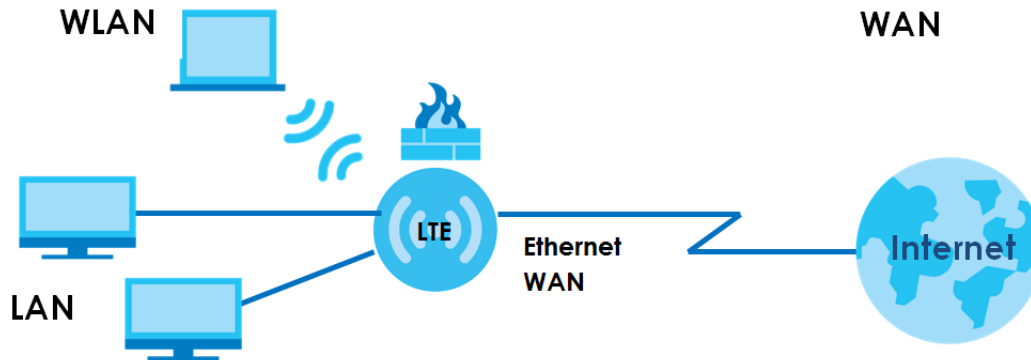

1.2.1 WAN Priority (LTE3301-PLUS / LTE5388-M804 / LTE5398-M904 / LTE3316-M604)

The WAN connection priority is as follows:

- 1 Ethernet WAN
- 2 Cellular WAN (3G/4G)

1.3 Manage the Zyxel Device

Use the Web Configurator for management of the Zyxel Device using a (supported) web browser.

1.4 Good Habits for Managing the Zyxel Device

Do the following things regularly to make the Zyxel Device more secure and to manage the Zyxel Device more effectively.

- Change the password. Use a password that's not easy to guess and that consists of different types of characters, such as numbers and letters.
- Write down the password and put it in a safe place.
- Back up the configuration (and make sure you know how to restore it). Refer to [Section 33.2 on page 266](#). Restoring an earlier working configuration may be useful if the Zyxel Device becomes unstable or even crashes. If you forget your password to access the Web Configurator, you will have to reset the Zyxel Device to its factory default settings. If you backed up an earlier configuration file, you would not have to totally re-configure the Zyxel Device. You could simply restore your last configuration. Write down any information your ISP provides you.

1.5 Front and Bottom Panels

The LED indicators are located on the front (LTE7240-M403 / LTE3301-PLUS / LTE5388-M804 / LTE5398-M904 / LTE3316-M604)/ the bottom panel (LTE7461-M602 / LTE7480-M804 / LTE7480-S905 / LTE7490-M904)/ the rear panels (LTE5388-M804 / LTE5398-M904 / LTE3316-M604).

Front & Top Panels

Figure 4 Front Panel (LTE3301-PLUS)

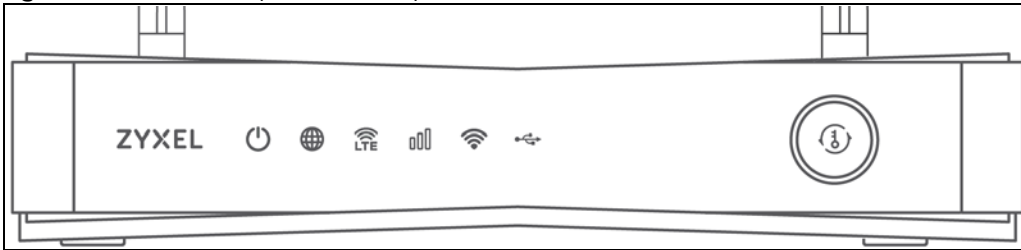

Figure 5 Front Panel (LTE7240-M403)



Figure 6 Front Panel (LTE5388-M804 / LTE5398-M904)

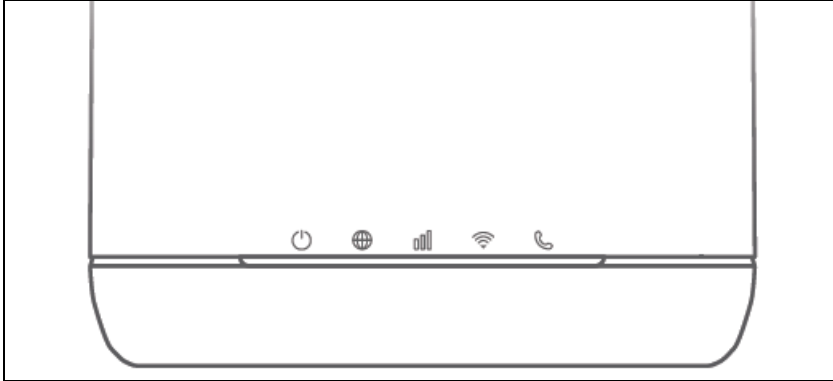

Figure 7 Top Panel (LTE5388-M804 / LTE5398-M904)

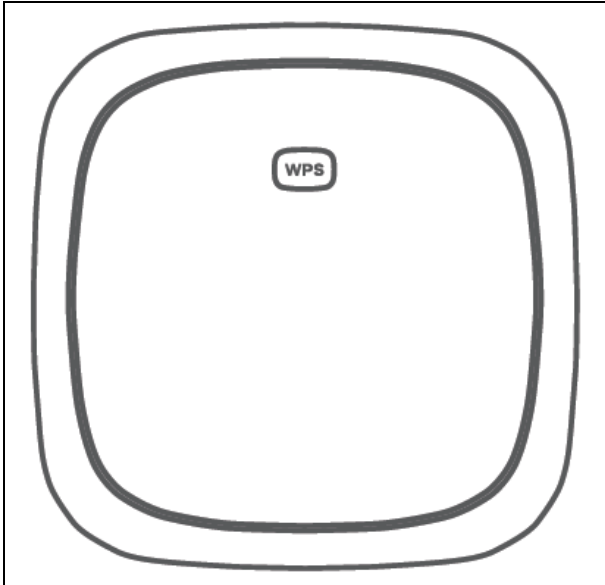
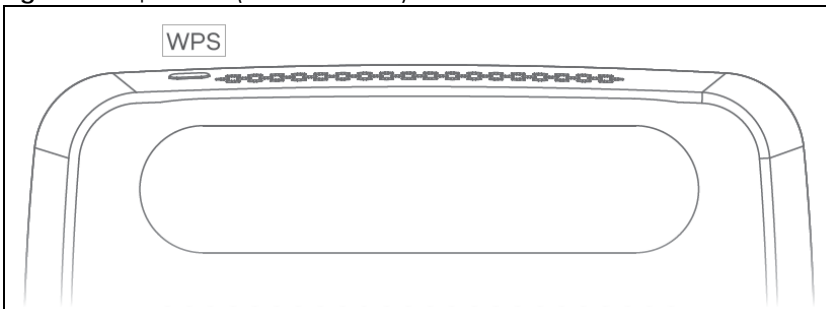

Figure 8 Front Panel (LTE3316-M604)



Figure 9 Top Panel (LTE3316-M604)



Bottom / Rear /Side Panels

Figure 10 Rear Panel (LTE3301-PLUS)

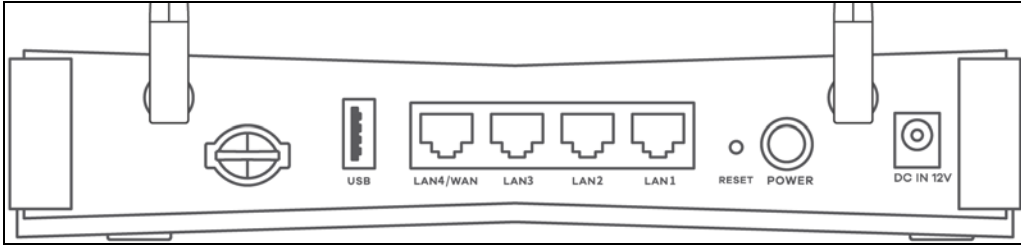

Figure 11 Bottom Panel (LTE7240-M403)



Figure 12 Bottom Panel (LTE7461-M602 / LTE7480-M804 / LTE7480-S905 / LTE7490-M904)



Figure 13 Rear Panel (LTE5388-M804 / LTE5398-M904)

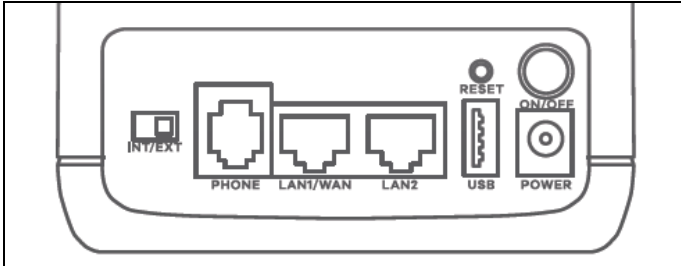

Figure 14 Bottom Panel (LTE5388-M804 / LTE5398-M904)

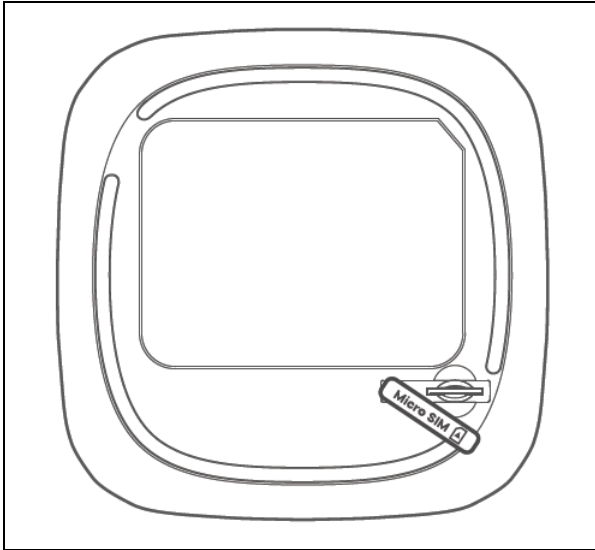

Figure 15 Rear Panel (LTE3316-M604)

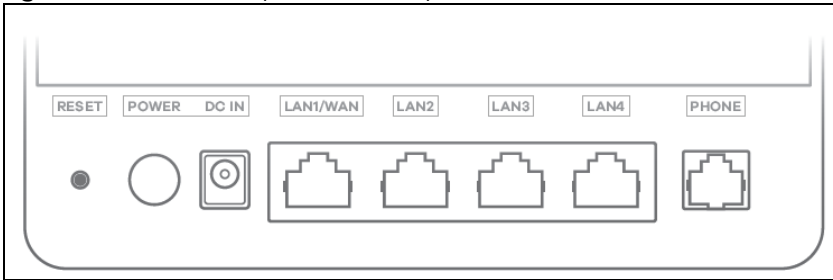
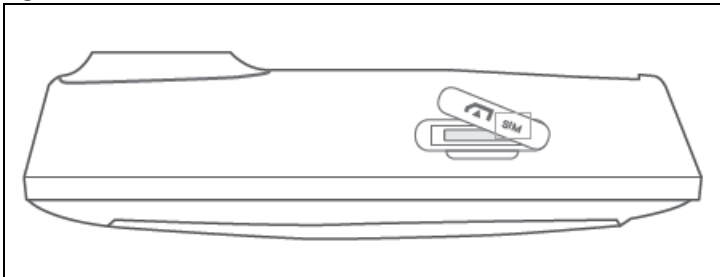

Figure 16 Side Panel (LTE3316-M604)



1.5.1 LEDs (Lights)

None of the LEDs are on if the Zyxel Device is not receiving power.

Table 3 LTE3301-PLUS LED Descriptions

LED	COLOR	STATUS	DESCRIPTION
POWER	White	On	The Zyxel Device is receiving power and ready for use.
		Blinking	The Zyxel Device is booting or self-testing.
		Off	The Zyxel Device is not receiving power.
Internet	White	On	There is Internet connection.
		Blinking	The Zyxel Device is sending or receiving IP traffic.
		Off	There is no Internet connection.

Table 3 LTE3301-PLUS LED Descriptions (continued)

LED	COLOR	STATUS	DESCRIPTION
LTE/3G	White	On	The Zyxel Device is registered and successfully connected to a 4G network.
		Blinking (slow)	The Zyxel Device is connected to a 3G network.
		Blinking (fast)	The Zyxel Device is trying to connect to a 3G/4G network.
		Off	There is no service.
	Green	On	The Zyxel Device has an Ethernet connection on the WAN.
		Off	There is no Ethernet connection on the WAN.
Signal Strength	Green	On	The signal strength is excellent.
	Amber	On	The signal strength is fair.
	Red	On	The signal strength is poor.
		Blinking	There is no SIM card inserted, no signal, or the signal strength is below the poor level.
		Off	The SIM card is invalid, or the PIN code is not correct.
WLAN	Green	On	The 2.4 GHz wireless network is activated.
		Blinking (slow)	The Zyxel Device is setting up a WPS connection with a 2.4 GHz wireless client.
		Blinking (fast)	The Zyxel Device is communicating with 2.4 GHz wireless clients.
	White	On	The 5 GHz wireless network is activated.
		Blinking (slow)	The Zyxel Device is setting up a WPS connection with a 5 GHz wireless client.
		Blinking (fast)	The Zyxel Device is communicating with 2.4 GHz and 5 GHz wireless clients.
		Off	The wireless network is not activated.
USB	White	On	The Zyxel Device recognizes a USB connection through the USB port.
		Blinking	The Zyxel Device is sending/receiving data to/from the USB device connected to it.
		Off	The Zyxel Device does not detect a USB connection through the USB port.

Note: Blinking (slow) means the LED blinks once per second. Blinking (fast) means the LED blinks once per 0.5 second.

Table 4 LTE7240-M403 LED Descriptions

LED	COLOR	STATUS	DESCRIPTION
POWER	Green	On	The Zyxel Device is receiving power and ready for use.
		Blinking	The Zyxel Device is booting or self-testing.
		Off	The Zyxel Device is not receiving power.
ETHERNET	Green	On	The Zyxel Device has a successful 10/100/1000 Mbps Ethernet connection with a device on the Local Area Network (LAN).
		Off	The Zyxel Device does not have an Ethernet connection with the LAN.

Table 4 LTE7240-M403 LED Descriptions (continued)

LED	COLOR	STATUS	DESCRIPTION
LTE/3G/2G	Green	On	The Zyxel Device is registered and successfully connected to a 4G network.
		Blinking (slow)	The Zyxel Device is connected to a 3G/2G network.
		Blinking (fast)	The Zyxel Device is trying to connect to a 4G/3G/2G network.
		Off	There is no service.
WLAN	Green	On	The wireless network is activated.
		Off	The wireless network is not activated.
Signal Strength	Green	On	The signal strength is excellent.
	Orange	On	The signal strength is fair.
	Red	On	The signal strength is poor.
		Blinking	There is no SIM card inserted, the SIM card is invalid, the PIN code is not correct.
		Off	There is no signal or the signal strength is below the poor level.

Note: Blinking (slow) means the LED blinks once per second. Blinking (fast) means the LED blinks once per 0.2 second.

Table 5 LTE7461-M602 / LTE7480-M804 / LTE7480-S905 / LTE7490-M904 LED Descriptions

COLOR	STATUS	DESCRIPTION
Red	Blinking	The Zyxel Device is booting or self-testing.
	On	The Zyxel Device encountered an error.
Green	Blinking	The Zyxel Device is trying to connect to the Internet.
	On	The Zyxel Device is connected to the Internet.
Amber	Blinking	The Zyxel Device WiFi is on.

Table 6 LTE5388-M804 / LTE5398-M904 LED Descriptions

LED	COLOR	STATUS	DESCRIPTION
Power/System or USB	Green	On	The Zyxel Device is receiving power and ready for use.
		Blinking	The Zyxel Device is booting.
		Off	The Zyxel Device is not receiving power.
	Blue	On	The Zyxel Device is sending/receiving data to/from the USB device connected to it.
		Off	The Zyxel Device does not detect a USB connection through the USB port.
Internet/SMS	Green	On	There is Internet connection.
		Blinking	There is a new SMS message.
		Off	There is no Internet connection.
LTE/3G Signal Strength	Green	On	The signal strength is excellent.
	Orange	On	The signal strength is fair.
	Red	On	The signal strength is poor.
		Blinking	There is no LTE/3G signal or the signal strength is below the poor level.

Table 6 LTE5388-M804 / LTE5398-M904 LED Descriptions (continued)

LED	COLOR	STATUS	DESCRIPTION
WiFi/WPS	Green	On	The WiFi AP is activated.
		Blinking (fast)	Data is being transmitted and received.
		Blinking (slow)	The WPS is activated.
Voice	Green	On	A telephone connected to the PHONE port has its receiver off the hook.
		Blinking	The Zyxel Device is receiving an incoming call.
		Off	A telephone connected to the PHONE port has its receiver on the hook.
LAN	Green	On	The Zyxel Device recognizes an Ethernet cable through the LAN port.
		Blinking	The Zyxel Device is sending/receiving data through the LAN.
		Off	The wireless network is not activated.

Table 7 LTE3316-M604 LED Descriptions

LED	COLOR	STATUS	DESCRIPTION
Power	White	On	The Zyxel Device is receiving power and functioning properly.
		Blinking	The Zyxel Device is in the process of starting up or default restoring.
		Off	The Zyxel Device is not receiving power.
Internet	White	On	The Zyxel Device's WAN connection is ready, but there is no traffic.
		Blinking	The Zyxel Device is transmitting and receiving data through the WAN.
		Off	The WAN connection is not ready, or has failed.
LTE/3G Signal Strength	White	On	The Zyxel Device is successfully connected to a 4G network.
		Blinking	The Zyxel Device is successfully connected to a 3G network.
	Green	On	The Zyxel Device is successfully connected to an Ethernet WAN network.
Signal Strength	Green	On	The signal strength is good.
	Orange	On	The signal strength is fair.
	Red	On	The signal strength is poor.
		Blinking	A valid SIM card is inserted, but no signal is detected.
WLAN/WPS	White	On	This indicates either 5G and 2.4G wireless LAN are both on or the 5G wireless LAN is on.
		Blinking	This indicates either 5G and 2.4G WPS are both on or the 5G WPS is on.
	Green	On	The 2.4G wireless LAN is on, but the Zyxel Device is not sending/receiving data through the wireless LAN.
		Blinking	The Zyxel Device is ready and the 2.4G WPS is on.

Table 7 LTE3316-M604 LED Descriptions (continued)

LED	COLOR	STATUS	DESCRIPTION
Voice	White	On	A telephone connected to the PHONE port has its receiver on the hook.
		Blinking	The Zyxel Device is receiving an incoming call.
		Off	A telephone connected to the PHONE port has its receiver off the hook.
LAN	Green	On	A 10/100 Mbps LAN connection is ready.
		Blinking	The Zyxel Device is sending/receiving data at 10/100 Mbps through a LAN port.
		Off	The wireless network is not activated.
	Orange	On	A 1000 Mbps LAN connection is ready.
		Blinking	The Zyxel Device is sending/receiving data at 1000 Mbps through a LAN port.
		Off	The wireless network is not activated.

1.5.2 Panel Ports & Buttons

The connection ports are located on the bottom/rear panels.

The following table describes the items on the bottom panel.

Table 8 Panel Ports and Buttons

LABELS	DESCRIPTION
ANT1-ANT2	Install the external antennas to strengthen the cellular signal.
USB	The USB port of the Zyxel Device is used for file sharing.
LAN/Ethernet	Connect a computer via the PoE injector for configuration. Connect the PoE injector to a power outlet to start the device.
LAN/WAN	For LTE5388-M804 / LTE5398-M904 / LTE3316-M604, connect an RJ45 cable to a modem to connect to the Internet when using a LAN port as a WAN port.
LAN	For LTE5388-M804 / LTE5398-M904 / LTE3316-M604, connect an RJ45 cable to a computer to connect to the internal network In using a LAN port.
WiFi	Press the WLAN (WiFi) button for more than five seconds to enable the wireless function. To set up a WiFi connection between the Zyxel Device and a wireless client, press the WPS button for longer than five seconds for LTE5388-M804 / LTE5398-M904, and press the WPS button for two seconds for LTE3316-M604.
WPS	After the wireless function is enabled, press the WLAN button for more than one second but less than five seconds to quickly set up a secure wireless connection between the Zyxel Device and a WPS-compatible client. To enable WPS, press the WPS button for less than five seconds for LTE5388-M804 / LTE5398-M904, and press the WPS button for more than five seconds for LTE3316-M604.
RESET	Press the button for more than five seconds to return the Zyxel Device to the factory defaults.
POWER Button	Press the POWER button after the power adapter is connected to start the Zyxel Device.
POWER /DC IN	Connect the power adapter and press the POWER button to start the Zyxel Device.
Reboot	Press the RESET button for more than 2 seconds but less than 5 seconds, it will cause the system to reboot.

Table 8 Panel Ports and Buttons (continued)

LABELS	DESCRIPTION
SIM card	Insert a micro-SIM card into the slot with the chip facing down and the beveled corner in the top left corner.
PHONE	For LTE5388-M804 / LTE5398-M904 / LTE3316-M604, the phone port is used for VoIP and VoLTE.
INT/EXT	For LTE5388-M804 / LTE5398-M904, the internal/external switch is used for selecting between the internal or external LTE antenna.

1.5.3 Turning On/Off WiFi

Use the **WPS** or **WiFi/WPS** button on the Zyxel Device to turn on or turn off the wireless network.

Note: Use the WiFi function of the LTE7461-M602 / LTE7480-M804 / LTE7480-S905 / LTE7490-M904 for configuration (for example, connect to the LTE Ally app of your mobile device to find the optimal LTE signal strength and manage your LTE7461-M602 / LTE7480-M804 / LTE7480-S905 / LTE7490-M904).

Figure 17 LTE3301-PLUS WiFi/WPS Button

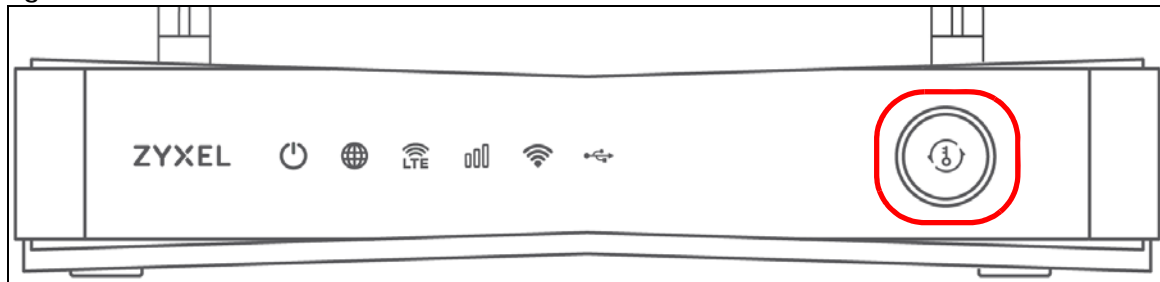

Figure 18 LTE7240-M403 WiFi Button

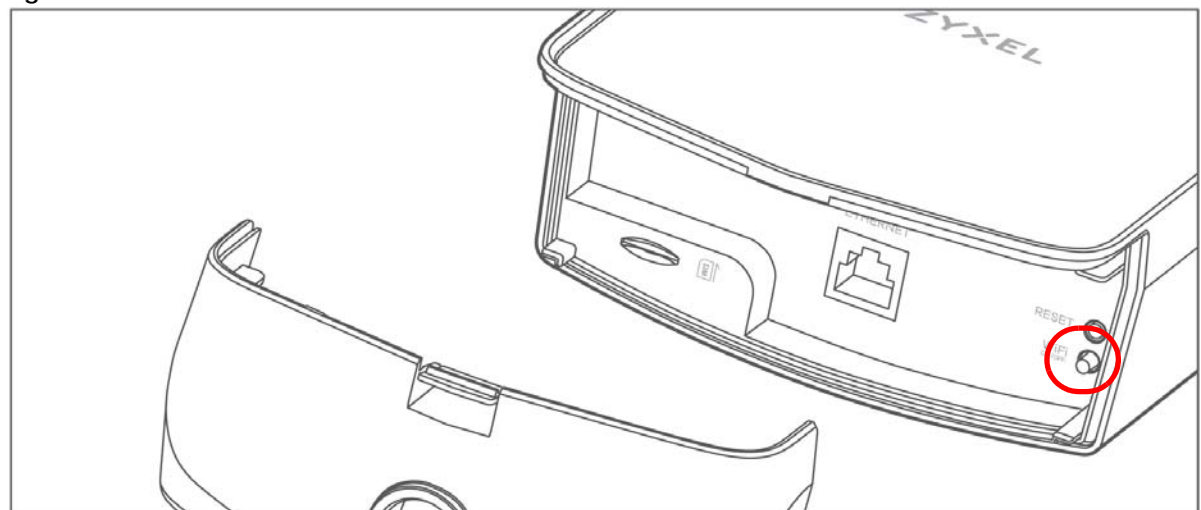

Figure 19 LTE7461-M602 / LTE7480-M804 / LTE7480-S905 / LTE7490-M904 WiFi Button

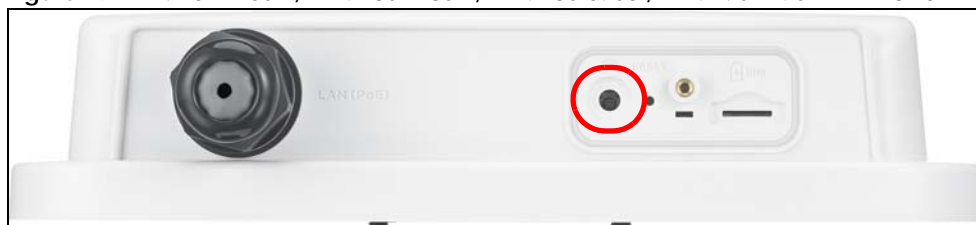

Figure 20 LTE5388-M804 / LTE5398-M904 WPS button

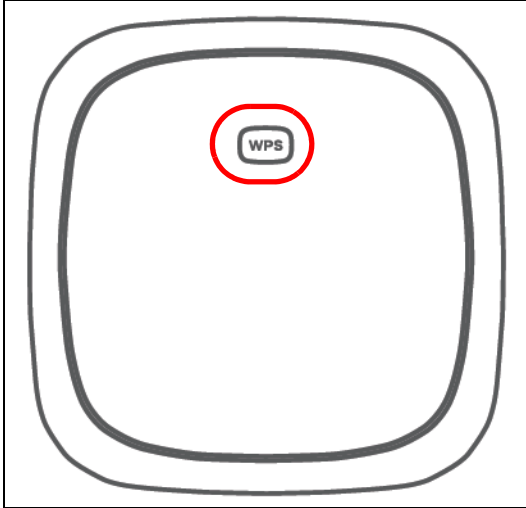
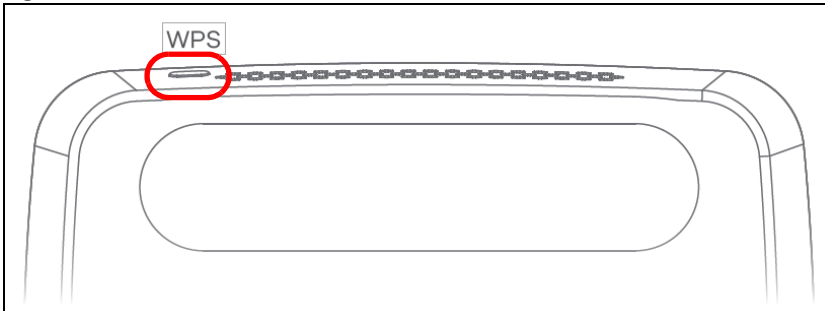

Figure 21 LTE3316-M604 WPS button



To turn on WiFi:

- Make sure the **POWER** LED is on and not blinking. Press the **WiFi** or **WiFi/WPS** button for more than 5 seconds and release it.

For LTE3301-PLUS:

Once WiFi is turned on, the **WLAN** LED turns green/white.

For LTE7240-M403:

Once WiFi is turned on, the **WLAN** LED shines green.

For LTE7461-M602 / LTE7480-M804 / LTE7480-S905 / LTE7490-M904:

Once WiFi is turned on, the LED blinks amber.

For LTE5388-M804 / LTE5398-M904:

Once WiFi is turned on, the LED turns green.

- Make sure the **POWER** LED is on and not blinking. Press the **WiFi** or **WiFi/WPS** button for 2 seconds.

For LTE3316-M604:

Once WiFi is turned on, the **WLAN** LED turns green/white.

To activate WPS (WiFi must be already on):

You can also quickly set up a secure wireless connection between the Zyxel Device and a WPS-compatible client by adding one device at a time.

- Press the **WiFi** or **WiFi/WPS** button for more than 1 second but less than 5 seconds and release it (pressing more than 5 seconds will turn off WiFi). Press the WPS button on another WPS-enabled device within range of the Zyxel Device.

For LTE3301-PLUS:

Once a wireless connection is ready, the **WLAN** LED turns green/white.

For LTE7240-M403:

Once a wireless connection is ready, the **WLAN** LED shines green.

For LTE7461-M602 / LTE7480-M804 / LTE7480-S905 / LTE7490-M904:

Once a wireless connection is ready, the LED blinks amber.

For LTE5388-M804 / LTE5398-M904:

Once a wireless connection is ready, the **WPS** LED blinks green.

- Press the **WiFi** or **WiFi/WPS** button for more than 5 second of the Zyxel Device and release it. Press the WPS button on another WPS-enabled device within range of the Zyxel Device.

For LTE3316-M604:

Once a wireless connection is ready, the **WPS** LED blinks green/white.

To turn off the wireless network:

- Press the **WiFi** or **WiFi/WPS** button for more than 5 seconds.

For LTE3301-PLUS:

The **WLAN** LED turns off when the wireless network is off.

For LTE7240-M403:

The **WLAN** LED turns off when the wireless network is off.

For LTE7461-M602 / LTE7480-M804 / LTE7480-S905 / LTE7490-M904:

The amber LED turns off when the wireless network is off.

For LTE5388-M804 / LTE5398-M904 / LTE3316-M604:

The **WLAN** LED turns off when the wireless network is off.

- Press the **WiFi** or **WiFi/WPS** button for 2 seconds.

For LTE3316-M604:

The **WLAN** LED turns off when the wireless network is off.

1.5.4 The RESET Button

If you forget your password or cannot access the Web Configurator, you will need to use the **RESET** button of the Zyxel Device as shown in the following figure to reload the factory-default configuration file. This means that you will lose all configurations that you had previously saved. The password will be reset to the default (see the Zyxel Device label) and the IP address will be reset to **192.168.1.1**.

Figure 22 Reset Button (LTE3301-PLUS)

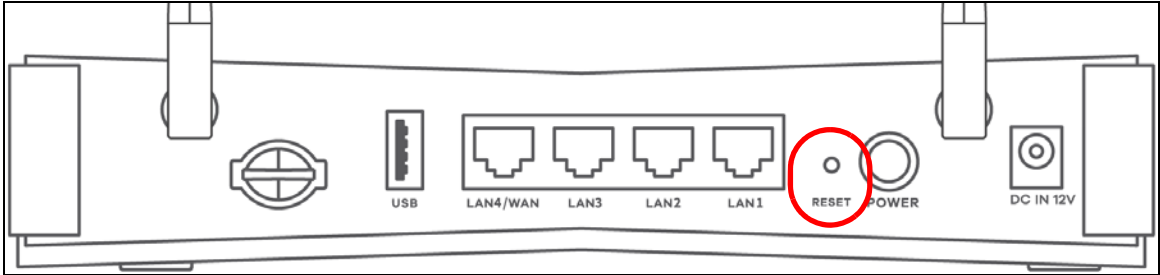

Figure 23 Reset Button (LTE7240-M403)

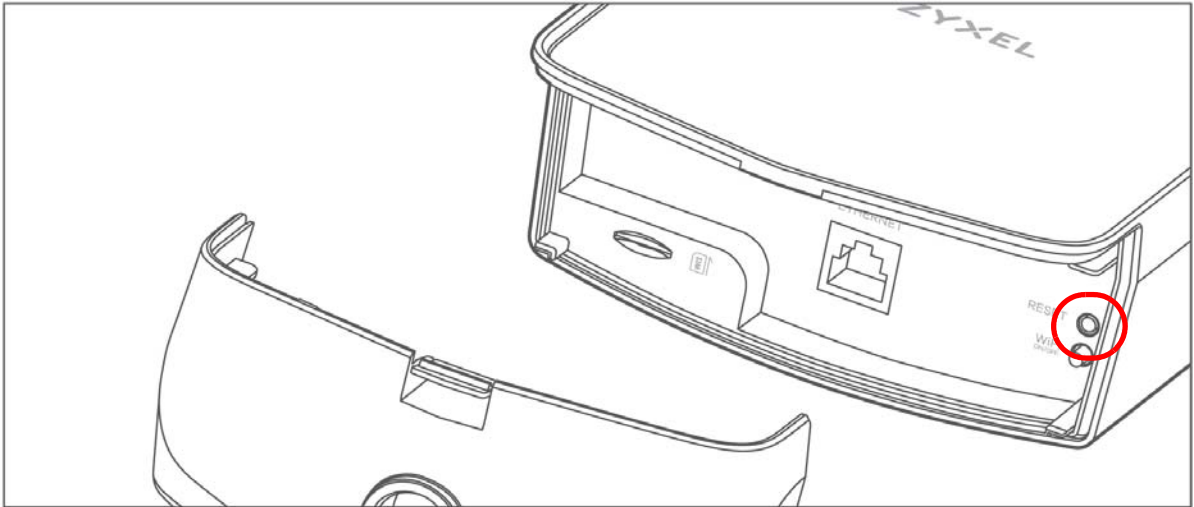

Figure 24 Reset Button (LTE7461-M602 / LTE7480-M804 / LTE7480-S905 / LTE7490-M904)



Figure 25 Reset Button (LTE5388-M804 / LTE5398-M904)

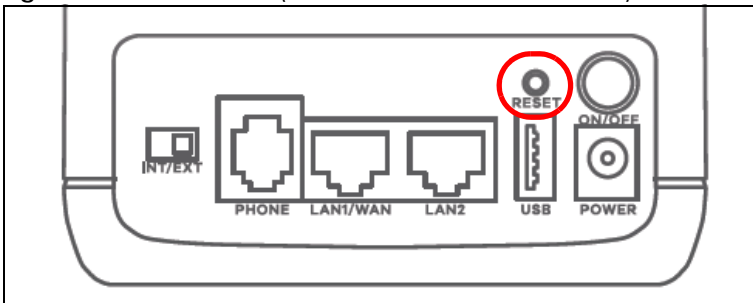
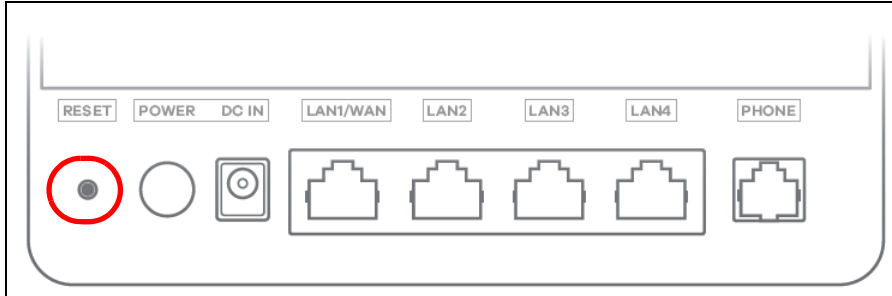

Figure 26 Reset Button (LTE3316-M604)

- 1 Make sure the Zyxel Device is connected to power and **POWER** LED is on.
- 2 To set the Zyxel Device back to the factory default settings, press the **RESET** button for 5 seconds.

Note: If you press the **RESET** button for more than 2 seconds but less than 5 seconds, it will cause the system to reboot.

1.6 Wall Mounting

Please refer to the installation guide below for the wall mounting procedures of the LTE3316-M604. You may need screw anchors if mounting on a concrete or brick wall.

Table 9 Wall Mounting Information

Distance between holes	100 mm
M4 Screws	Two
Screw anchors (optional)	Two

Do the following to attach your Zyxel Device to a wall.

- 1 Select a position free of obstructions on a wall strong enough to hold the weight of the device.
- 2 Mark two holes on the wall at the appropriate distance apart for the screws.

Be careful to avoid damaging pipes or cables located inside the wall when drilling holes for the screws.

Do not wall mount the Zyxel Device over a height of 2 m.

- 3 If using screw anchors, drill two holes for the screw anchors into the wall. Push the anchors into the full depth of the holes, then insert the screws into the anchors. Do not insert the screws all the way in - leave a small gap of about 0.5 cm.

If not using screw anchors, use a screwdriver to insert the screws into the wall. Do not insert the screws all the way in - leave a gap of about 0.5 cm.

- 4 Make sure the screws are fastened well enough to hold the weight of the Zyxel Device with the connection cables.

- Align the holes on the back of the Zyxel Device with the screws on the wall. Hang the Zyxel Device on the screws.

Figure 27 Wall Mounting Example

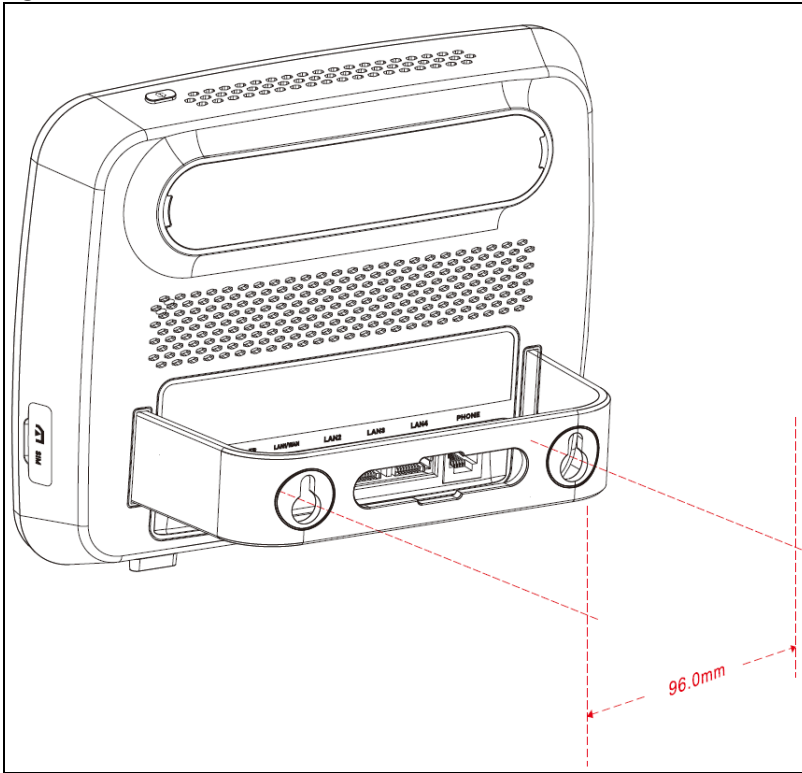
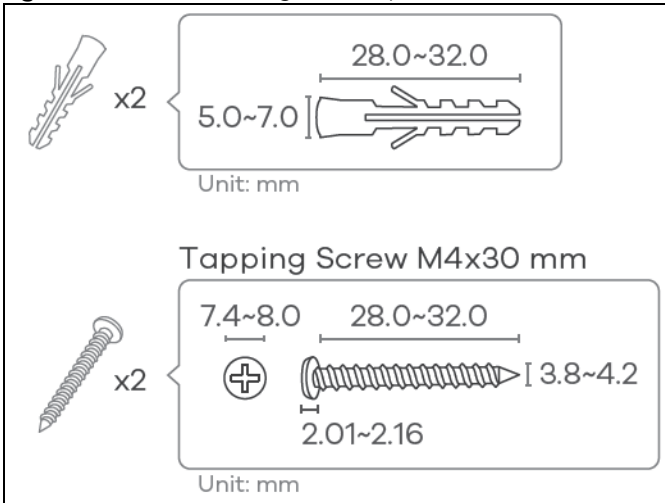

Figure 28 Wall Mounting Screw Specifications



CHAPTER 2

The Web Configurator

2.1 Overview

The Web Configurator is an HTML-based management interface that allows easy system setup and management via Internet browser. Use a browser that supports HTML5, such as Internet Explorer 11, Mozilla Firefox, or Google Chrome. The recommended screen resolution is 1024 by 768 pixels.

In order to use the Web Configurator you need to allow:

- Web browser pop-up windows from your Zyxel Device.
- JavaScript (enabled by default).
- Java permissions (enabled by default).

2.1.1 Access the Web Configurator

- 1 Make sure your Zyxel Device hardware is properly connected (refer to the Quick Start Guide).
- 2 Launch your web browser. If the Zyxel Device does not automatically re-direct you to the login screen, go to <http://192.168.1.1>.
- 3 A password screen displays. Select the language you prefer (upper right).
- 4 To access the Web Configurator and manage the Zyxel Device, type the default username **admin** and the randomly assigned default password (see the Zyxel Device label) in the **Login** screen and click **Login**. If you have changed the password, enter your password and click **Login**.

Figure 29 Password Screen

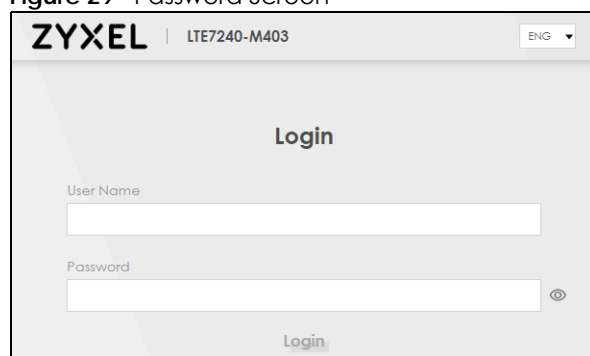

The screenshot shows the login interface of the Zyxel Web Configurator. At the top left, the Zyxel logo and device model 'LTE7240-M403' are displayed. A language dropdown menu is set to 'ENG'. The central heading is 'Login'. Below this, there are two input fields: 'User Name' and 'Password'. The 'Password' field includes a small eye icon to toggle password visibility. At the bottom center, there is a 'Login' button.

Note: The first time you enter the password, you will be asked to change it. Make sure the new password must contain at least one uppercase letter, one lowercase letter and one number.

- 5 The **Connection Status** screen appears. Use this screen to configure basic Internet access and wireless settings.

Figure 30 Connection Status

The screenshot displays the ZyXEL web configurator interface for the LTE5388-M804 device. The interface is organized into several sections:

- Connectivity:** A diagram showing a globe (WAN) with a red 'X' over it, indicating a connection down status. It is connected to a laptop (LAN) with a green checkmark, which is also connected to another laptop (Guest WiFi).
- System Info:**
 - Model Name: LTE5388-M804
 - Firmware Version: 1.00(ABSQ.0)b1
 - System Uptime: 0 days 1 hours 5 mins 16 secs
 - LAN MAC Address: 98:0D:67:99:63:54
 - WAN Status: Connection down
- Cellular Info:**
 - SIM Card Status: None
- WiFi Settings:**
 - 2.4G WiFi: Name: Zyxel_6355, Password: [Redacted]
 - 5G WiFi: Name: Zyxel_6355_5G, Password: [Redacted]
- Guest WiFi Settings:**
 - 2.4G WiFi: Name: Zyxel_6355_gues t1, Password: [Redacted]
 - 5G WiFi: Name: Zyxel_6355_gues t1_5G, Password: [Redacted]
- LAN:**
 - IP Address: 192.168.1.1
 - Subnet Mask: 255.255.255.0
 - IP Address Range: 192.168.1.2 ~ 192.168.1.254
 - DHCP: Enabled
 - Lease Time: 1 days 0 hours 0 mins

2.2 Web Configurator Layout

Figure 31 Screen Layout

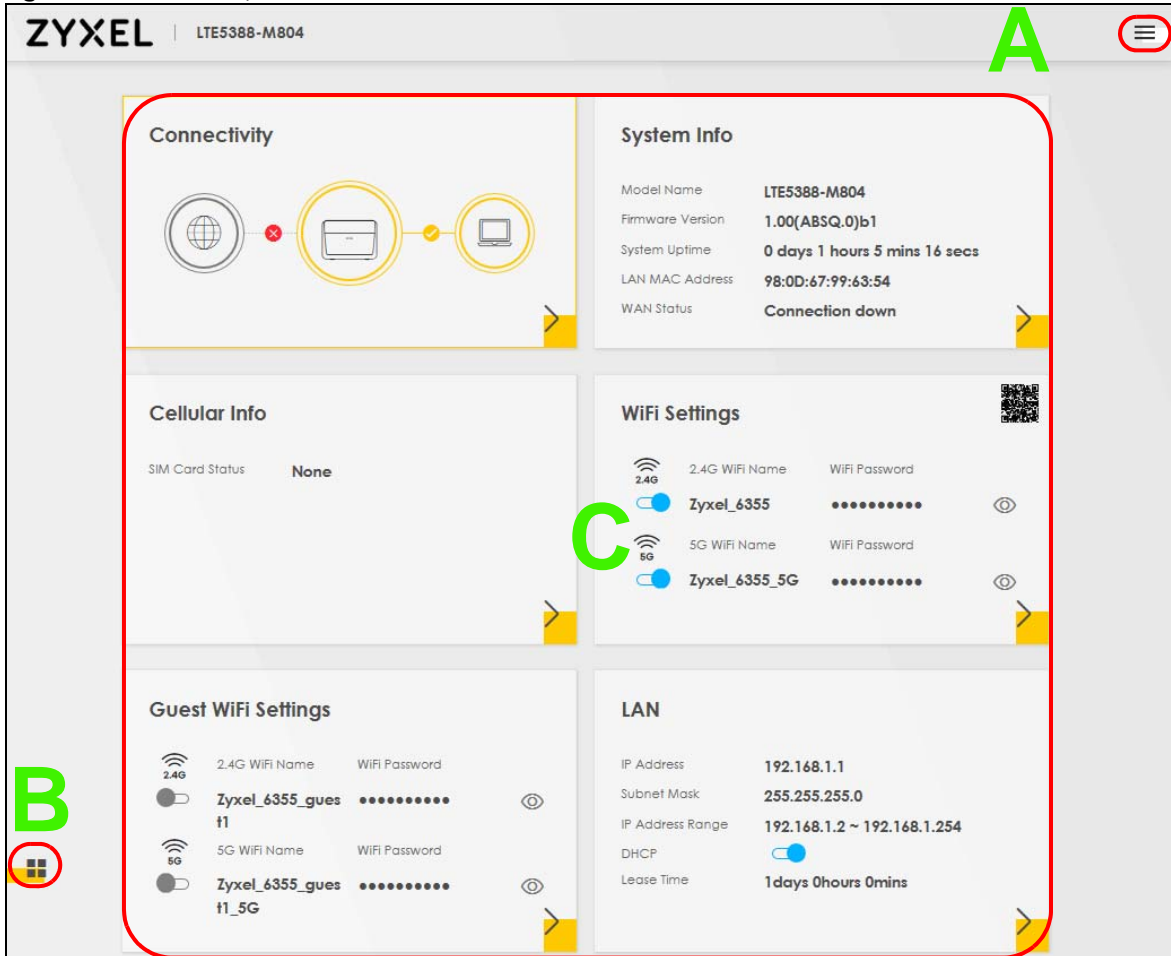

As illustrated above, the main screen is divided into these parts:

- A - Settings Icon (Navigation Panel & Side Bar)
- B - Widget Icon
- C - Main Window

2.2.1 Settings Icon

Click this icon (☰) to see the side bar and navigation panel.

2.2.1.1 Side Bar







The side bar provides some icons on the right hand side.

Figure 32 Side Bar

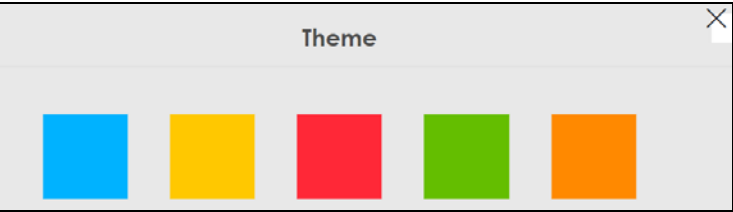

The icons provide the following functions.

Table 10 Web Configurator Icons in the Title Bar

ICON	DESCRIPTION
 <p>Wizard</p>	<p>Wizard: Click this icon to open screens where you can configure the Zyxel Device's time zone and wireless settings. See Chapter 3 on page 44 for more information about the Wizard screens.</p>
 <p>Theme</p>	<p>Theme: Click this icon to select a color that you prefer and apply it to the Web Configurator.</p> 
 <p>Language</p>	<p>Language: Select the language you prefer.</p>
 <p>Restart</p>	<p>Restart: Click this icon to reboot the Zyxel Device without turning the power off.</p>
 <p>Logout</p>	<p>Logout: Click this icon to log out of the Web Configurator.</p>

2.2.1.2 Navigation Panel

Use the menu items on the navigation panel to open screens to configure Zyxel Device features. The following tables describe each menu item.

Table 11 Navigation Panel Summary

LINK	TAB	FUNCTION
Home		Use this screen to configure basic Internet access and wireless settings. This screen also shows the network status of the Zyxel Device and computers/devices connected to it.
Network Setting		
Broadband	Broadband	Use this screen to view and configure ISP parameters, WAN IP address assignment, and other advanced properties.
	WAN Backup	Use this screen to configure your Zyxel Device's Internet settings if the cellular connection is down.
	Ethernet WAN	Use this screen to convert the LAN port as WAN port, or restore the WAN port to LAN port.
	Cellular WAN	Use this screen to configure an LTE WAN connection that includes the Access Point Name (APN) provided by your service provider.
	Cellular SIM	Use this screen to enter a PIN for your SIM card to prevent others from using it.
	Cellular Band	Use this screen to configure the LTE frequency bands that can be used for Internet access as provided by your service provider.
	Cellular PLMN	Use this screen to view available PLMNs and select your preferred network.
	Cellular IP Passthrough	Use this screen to enable IP Passthrough mode (bridge mode). Note: This screen is not available when the fourth LAN port acts as an Ethernet WAN port. See Table 1 on page 16 for the feature differences of the Zyxel Devices.
Wireless	General	Use this screen to configure the wireless LAN settings and WLAN authentication/security settings.
	Guest/More AP	Use this screen to configure multiple BSSs on the Zyxel Device.
	MAC Authentication	Use this screen to block or allow wireless traffic from wireless devices of certain SSIDs and MAC addresses to the Zyxel Device.
	WPS	Use this screen to configure and view your WPS (WiFi Protected Setup) settings.
	WMM	Use this screen to enable or disable WiFi MultiMedia (WMM).
	Others	Use this screen to configure advanced wireless settings.
	WLAN Scheduler	Use this screen to create rules to schedule the times to permit Internet traffic from each wireless network interfaces.
	Channel Status	Use this screen to scan wireless LAN channel noises and view the results.
Home Networking	LAN Setup	Use this screen to configure LAN TCP/IP settings, and other advanced properties.
	Static DHCP	Use this screen to assign specific IP addresses to individual MAC addresses.
	UPnP	Use this screen to turn UPnP and UPnP NAT-T on or off.

Table 11 Navigation Panel Summary (continued)

LINK	TAB	FUNCTION
Routing	Static Route	Use this screen to view and set up static routes on the Zyxel Device.
	DNS Route	Use this screen to forward DNS queries for certain domain names through a specific WAN interface to its DNS server(s).
	Policy Route	Use this screen to configure policy routing on the Zyxel Device.
	RIP	Use this screen to configure Routing Information Protocol to exchange routing information with other routers.
NAT	Port Forwarding	Use this screen to make your local servers visible to the outside world.
	Port Triggering	Use this screen to change your Zyxel Device's port triggering settings.
	DMZ	Use this screen to configure a default server which receives packets from ports that are not specified in the Port Forwarding screen.
	ALG	Use this screen to enable or disable SIP ALG.
	Address Mapping	Use this screen to change your Zyxel Device's IP address mapping settings.
	Sessions	Use this screen to limit the number of NAT sessions each client can use.
DNS	DNS Entry	Use this screen to view and configure DNS routes.
	Dynamic DNS	Use this screen to allow a static hostname alias for a dynamic IP address.
USB	USB Service	Use this screen to enable file sharing via the Zyxel Device.
Security		
Firewall	General	Use this screen to configure the security level of your firewall.
	Protocol	Use this screen to add Internet services and configure firewall rules.
	Access Control	Use this screen to enable specific traffic directions for network services.
	DoS	Use this screen to activate protection against Denial of Service (DoS) attacks.
MAC Filter	MAC Filter	Use this screen to block or allow traffic from devices of certain MAC addresses to the Zyxel Device.
Parental Control	Parental Control	Use this screen to define time periods and days during which the Zyxel Device performs parental control and/or block web sites with the specific URL.
Certificates	Local Certificates	Use this screen to view a summary list of certificates and manage certificates and certification requests.
	Trusted CA	Use this screen to view and manage the list of the trusted CAs.
Voice	Voice Mode	Use this screen to enable the Voice Mode on the Zyxel Device.
	SIP	Use this screen to set up information about your SIP account.
	Phone	Use this screen to change settings that depend on the country you are in.
	Call Rule	Use this screen to add, edit, or remove speed-dial numbers for outgoing calls.
	Call History	Use this screen to view a call history list.
System Monitor		

Table 11 Navigation Panel Summary (continued)

LINK	TAB	FUNCTION
Log	System Log	Use this screen to view the status of events that occurred to the Zyxel Device. You can export or email the logs.
	Security Log	Use this screen to view all security related events. You can select the level and category of the security events in their proper drop-down list window. Levels include: <ul style="list-style-type: none"> • Emergency • Alert • Critical • Error • Warning • Notice • Informational • Debugging Categories include: <ul style="list-style-type: none"> • Account • Attack • Firewall • MAC Filter
Traffic Status	WAN	Use this screen to view the status of all network traffic going through the WAN port of the Zyxel Device.
	LAN	Use this screen to view the status of all network traffic going through the LAN ports of the Zyxel Device.
VoIP Status	VoIP Status	Use this screen to view VoIP registration, current call status and phone numbers.
ARP table	ARP table	Use this screen to view the ARP table. It displays the IP and MAC address of each DHCP connection.
Routing Table	Routing Table	Use this screen to view the routing table on the Zyxel Device.
WAN Station Status	WAN Station Status	Use this screen to view the wireless stations that are currently associated to the Zyxel Device's wireless LAN.
Cellular WAN Status	Cellular Statistics	Use this screen to look at the cellular Internet connection status.
Maintenance		
System	System	Use this screen to set the Zyxel Device name and Domain name.
User Account	User Account	Use this screen to change the user password on the Zyxel Device.
Remote Management	MGMT Services	Use this screen to enable specific traffic directions for network services.
	MGMT Services for IP Passthrough	Use this screen to enable various approaches to access this Zyxel Device remotely from a WAN and/or LAN connection.
	Trust Domain	Use this screen to view a list of public IP addresses which are allowed to access the Zyxel Device through the services configured in the Maintenance > Remote Management screen.
	Trust Domain for IP Passthrough	Use this screen to enable public IP addresses to access this Zyxel Device remotely from a WAN and/or LAN connection.
TR-069 Client	TR-069 Client	Use this screen to configure your Zyxel Device to be managed remotely by an Auto Configuration Server (ACS) using TR-069.
Time	Time	Use this screen to change your Zyxel Device's time and date.
Email Notification	Email Notification	Use this screen to configure up to two mail servers and sender addresses on the Zyxel Device.

Table 11 Navigation Panel Summary (continued)

LINK	TAB	FUNCTION
Log Setting	Log Setting	Use this screen to change your Zyxel Device's log settings.
Firmware Upgrade	Firmware Upgrade	Use this screen to upload firmware to your Zyxel Device.
Backup/Restore	Backup/Restore	Use this screen to backup and restore your Zyxel Device's configuration (settings) or reset the factory default settings.
Reboot	Reboot	Use this screen to reboot the Zyxel Device without turning the power off.
Diagnostic	Ping&Traceroute &Nslookup	Use this screen to identify problems with the DSL connection. You can use Ping, TraceRoute, or Nslookup to help you identify problems.

2.2.1.3 Dashboard

Use the menu items in the navigation panel on the right to open screens to configure the Zyxel Device's features.

Figure 33 Navigation Panel

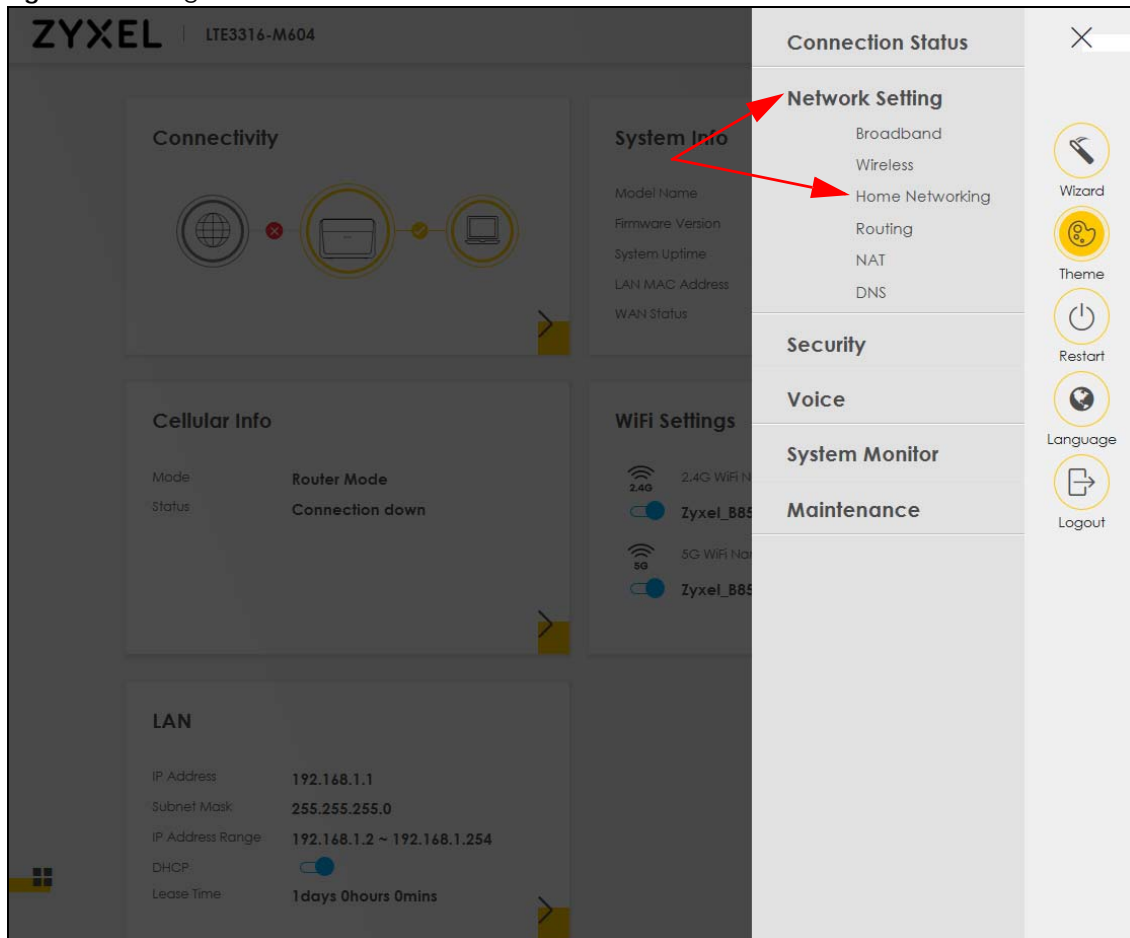

2.2.2 Widget Icon

Click this icon () in the lower left corner to arrange the screen order.

Figure 34 Widget Icon



Select a block and hold it to move around. Click the Check icon (☑) in the lower left corner to save the changes.

Figure 35 The Screen Oder

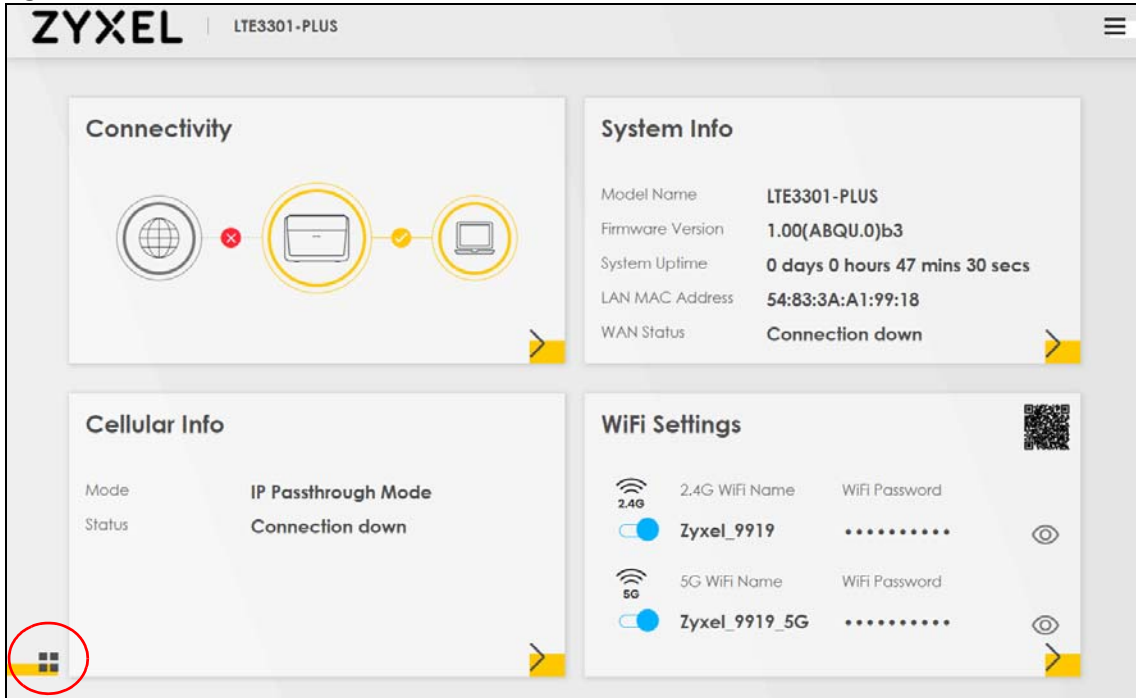
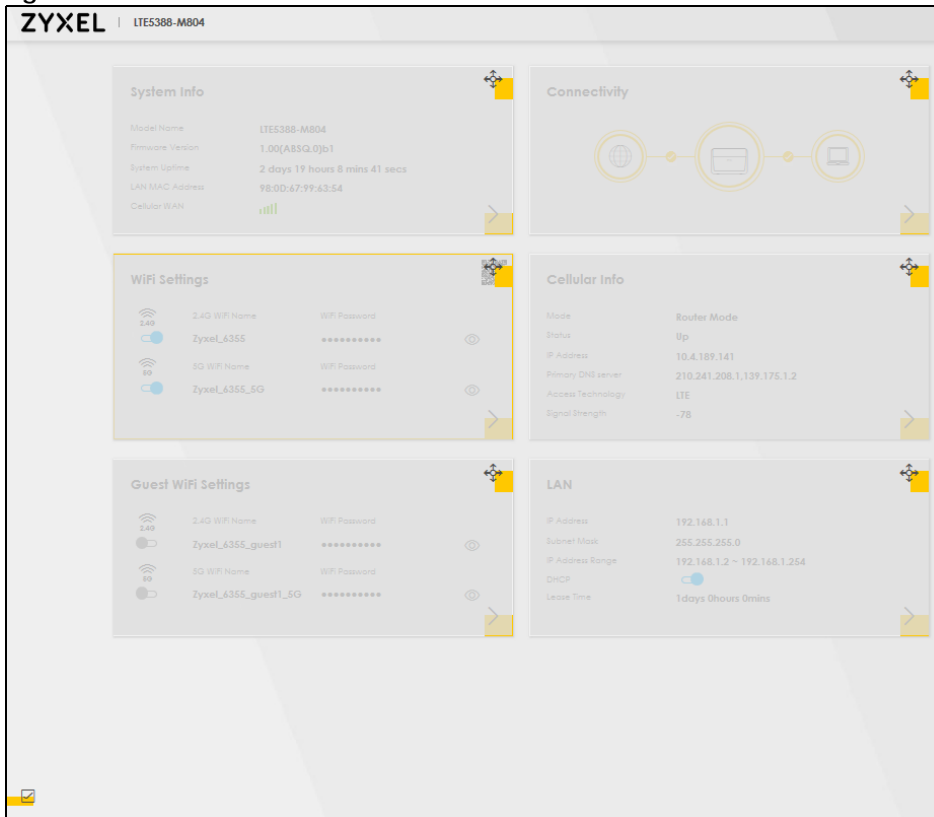

CHAPTER 3

Quick Start

3.1 Overview

Use the **Wizard** screens to configure the Zyxel Device's time zone and wireless settings.

Note: See the technical reference chapters (starting on [Chapter 5 on page 71](#)) for background information on the features in this chapter.

3.2 Quick Start Setup

You can click the **Wizard** icon in the side bar to open the **Wizard** screens. See [Section 2.2.1.1 on page 37](#) for more information about the side bar. After you click the **Wizard** icon, the following screen appears. Click **Let's Go** to proceed with settings on time zone and wireless networks. It will take you a few minutes to complete the settings on the **Wizard** screens. You can click **Skip** to leave the **Wizard** screens.

Figure 36 Wizard - Home

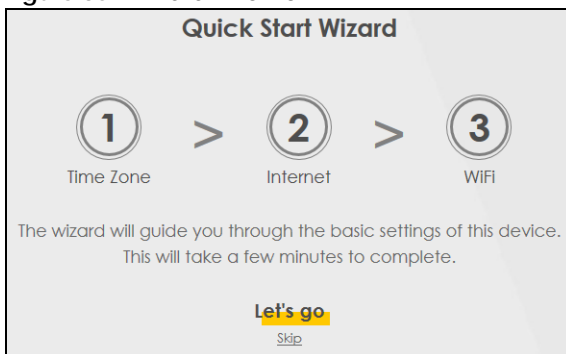

3.3 Time Zone

Select the time zone of your location. Click **Next**.

Figure 37 Wizard - Time Zone

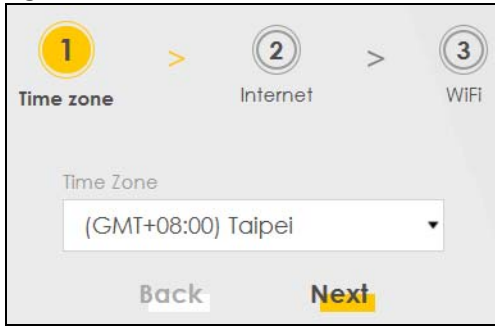

3.4 The Internet Connection Setup

Select the Internet connection mode of the Zyxel Device. Click **Next** to continue.

Figure 38 Wizard - Internet

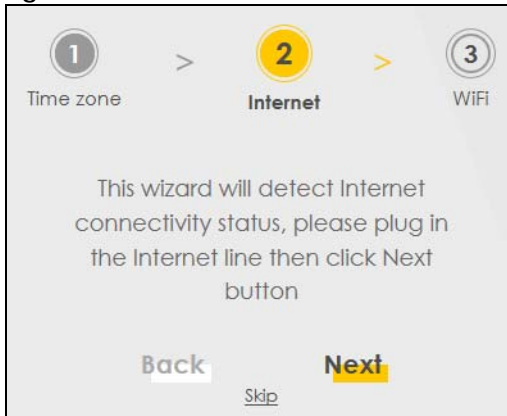

3.4.1 Successful Internet Connection

The Zyxel Device has Internet access.

Figure 39 Wizard - Successful Internet Connection



3.4.2 Unsuccessful Internet Connection

The Zyxel Device didn't detect a WAN connection.

Figure 40 Wizard - Internet Connection is down



3.5 Quick Start Setup-Wireless

Turn WiFi on or off. If you keep it on, record the **WiFi Name** and **Password** in this screen so you can configure your wireless clients to connect to the Zyxel Device. If you want to show or hide your WiFi password, click the Eye icon (👁).

Figure 41 Wizard - Wireless

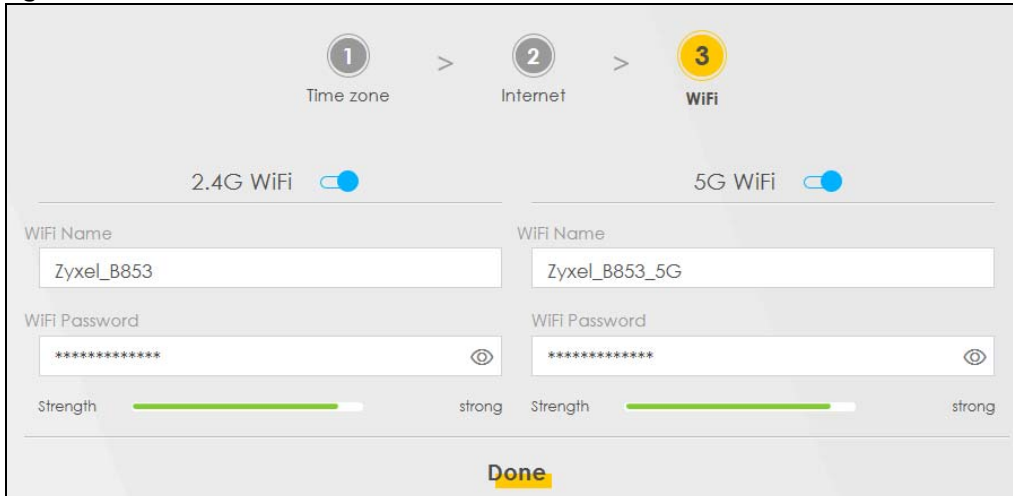

Note: You can also enable the wireless service using any of the following methods:
 Click **Network Setting > Wireless** to open the **General** screen. Then select **Enable** in the **Wireless** field. Or, Press the **WiFi** button located under the **RESET** button (see [Section 1.5.4 on page 31](#) for the location and for how long the wireless function is turned on) for one second.

3.6 Quick Start Setup-Finish

Your Zyxel Device saves your settings and attempts to connect to the Internet.

CHAPTER 4

Tutorials

4.1 Overview

This chapter provides tutorials for setting up your Zyxel Device.

- [Set Up a Wireless Network Using WPS](#)
- [Connect to the Zyxel Device's WiFi Network](#)
- [Use Multiple SSIDs on the Zyxel Device](#)
- [Make a VoIP/VoLTE Phone Call](#)
- [Configure a Firewall Rule](#)
- [Configure MAC Filter](#)
- [Upgrade Firmware on the Zyxel Device](#)
- [Back up a Configuration File](#)
- [Restore Configuration](#)
- [Connect to the Internet](#)
- [Configure DHCP](#)
- [Configure Static Route for Routing to Another Network](#)
- [Access the Zyxel Device Using DDNS](#)

4.2 Set Up a Wireless Network Using WPS

This section gives you an example of how to set up wireless network using WPS. This example uses the Zyxel Device as the AP and a WPS-enabled Android smartphone as the wireless client.

There are two WPS methods for creating a secure connection via the web configurator or utility. This tutorial shows you how to do both.

- **Push Button Configuration (PBC)** - create a secure wireless network simply by pressing a button. See [Section 4.2.1 on page 49](#). This is the easier method.
- **PIN Configuration** - create a secure wireless network simply by entering a wireless client's PIN (Personal Identification Number) in the Zyxel Device's interface. See [Section 4.2.2 on page 50](#). This is the more secure method, since one device can authenticate the other.

4.2.1 Push Button Configuration (PBC)

- 1 Make sure that your Zyxel Device is turned on. Make sure the wireless LAN is turned on by pressing the **WiFi/WPS** button for two seconds, and that the device is placed within range of your notebook (for LTE3316-M604). For more information about WiFi/WPS settings, see [Section 1.5.3 on page 29](#).
- 2 WPS is enabled by default on the Zyxel Device. If not, log into the Zyxel Device's Web Configurator and press the **Push Button** in the **Configuration > Network Setting > Wireless > WPS** screen. You can either press the WPS button on the Zyxel Device's top/side panel or press **WPS** in the screen.
- 3 Go to your phone settings and turn on WiFi. Open the WiFi networks list and tap WPS Push Button or the WPS icon ().

Note: It doesn't matter which button is pressed first. You must press the second button within two minutes of pressing the first one.

The Zyxel Device sends the proper configuration settings to the wireless client. This may take up to two minutes. Then the wireless client is able to communicate with the Zyxel Device securely.

The following figure shows you an example to set up wireless network and security by pressing a button on both Zyxel Device and wireless client (the Android smartphone in this example).

Figure 42 Example WPS Process: PBC Method

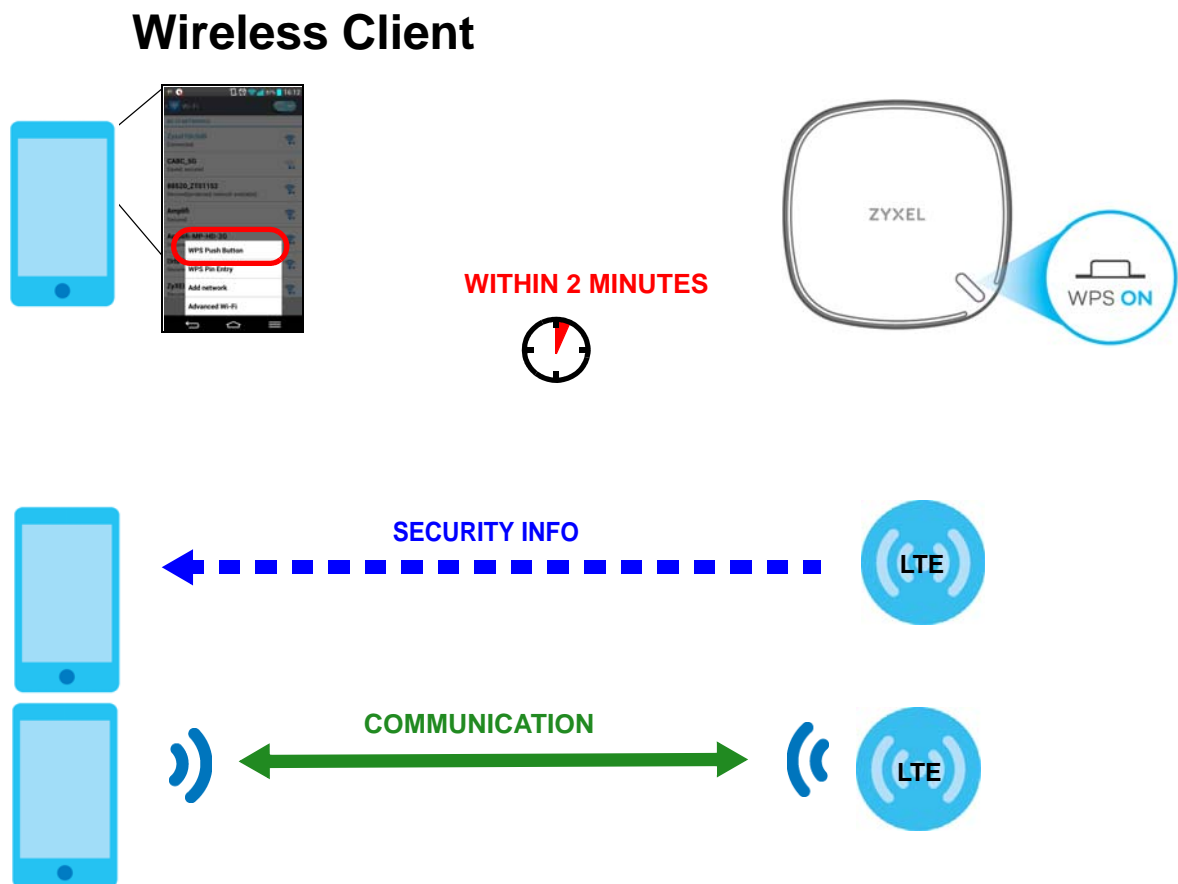

4.2.2 PIN Configuration

When you use the PIN configuration method, you need to check the client's PIN number and use the Zyxel Device's configuration interface.

- 1** Go to your phone settings and turn on WiFi. Open the WiFi networks list and tap WPS PIN Entry to get a PIN number.
- 2** Enter the client's PIN number in the **PIN** field in the **Configuration > Network Setting > Broadband > Cellular SIM** screen on the Zyxel Device.
- 3** Click **Start** button (or the button next to the PIN field) on the Zyxel Device's **Cellular SIM** screen within two minutes.

The Zyxel Device authenticates the wireless client and sends the proper configuration settings to the wireless client. This may take up to two minutes. Then the wireless client is able to communicate with the Zyxel Device securely.

The following figure shows you the example to set up wireless network and security on Zyxel Device and wireless client (ex. the Android smartphone in this example) by using PIN Method.

Figure 43 Example WPS Process: PIN Method

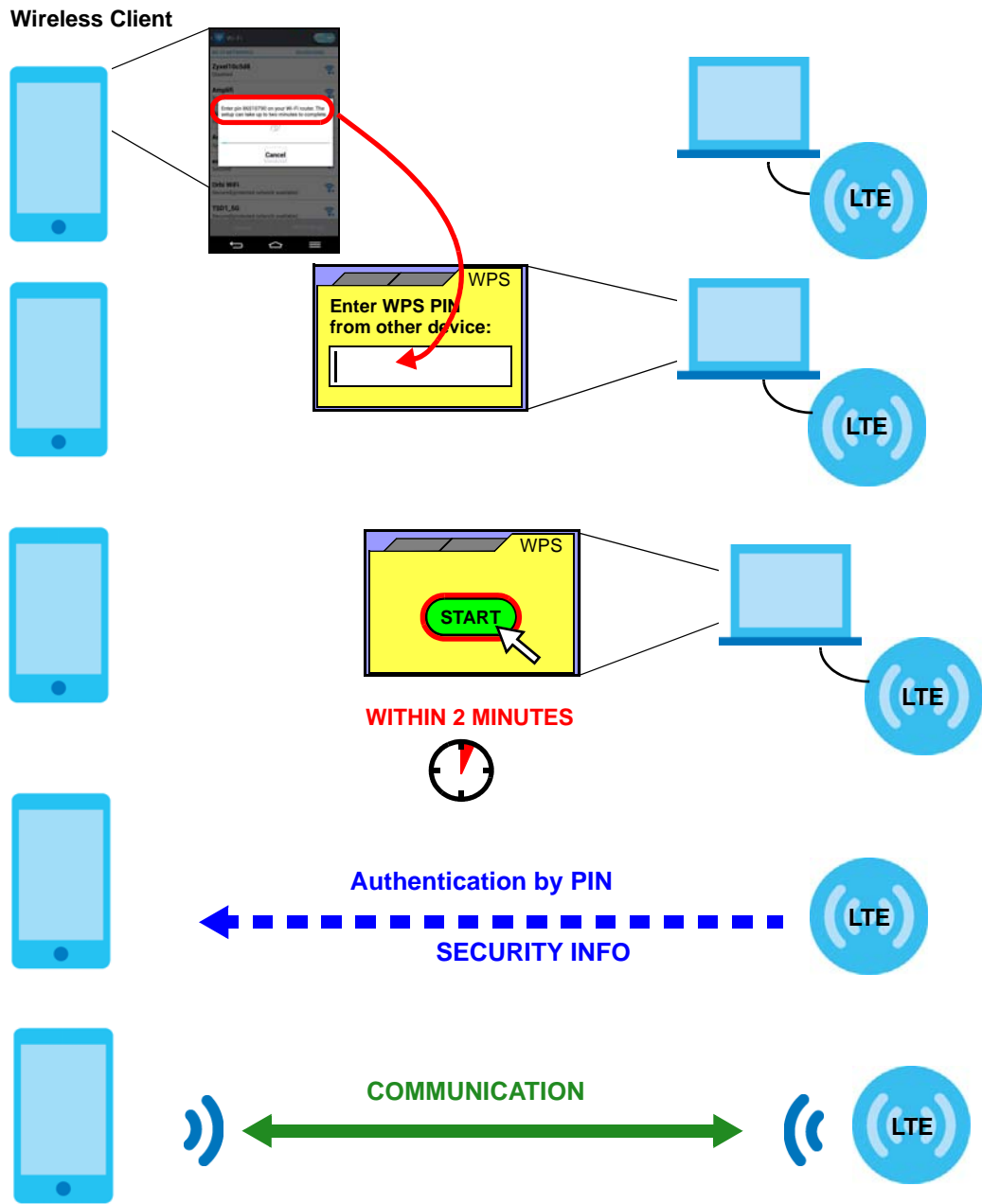

4.3 Connect to the Zyxel Device's WiFi Network

In this example, you've configured the Zyxel Device's WiFi Network to the following settings.

SSID	SSID_Example
------	--------------

Channel	6
Security	WPA2-PSK (Pre-Shared Key: ThisismyWPA-PSKpre-sharedkey)

Note: In this example, we use a Windows 7 laptop that has a built-in wireless adapter as the wireless client.

- 1 The Zyxel Device supports IEEE 802.11b, IEEE 802.11g, and IEEE 802.11n wireless clients. Make sure that your notebook or computer's wireless adapter supports one of these standards.
- 2 Click the WiFi icon in your computer's system tray.

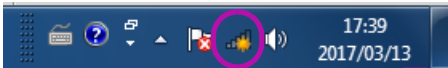

- 3 The **Wireless Network Connection** screen displays. Click the refresh button to update the list of the available wireless APs within range.
- 4 Select **SSID_Example** and click **Connect**.

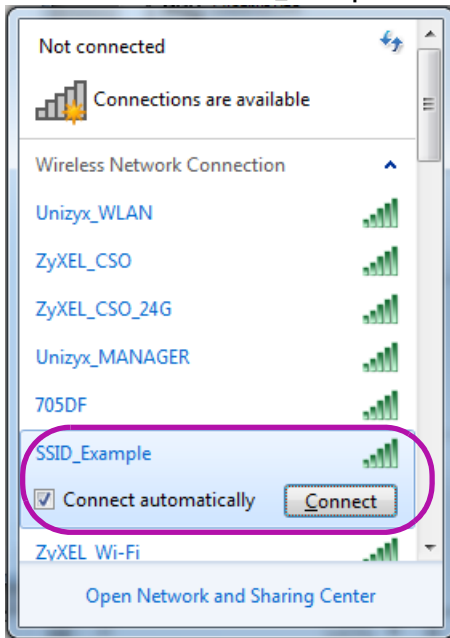

- 5 The following screen displays if WPS is enabled on the Zyxel Device but you didn't press the WPS button. Click **Connect using a security key instead**.

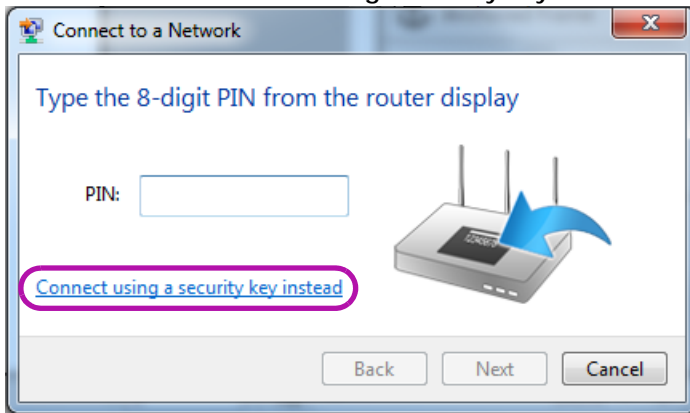

- 6 Type the security key in the following screen. Click **OK**.

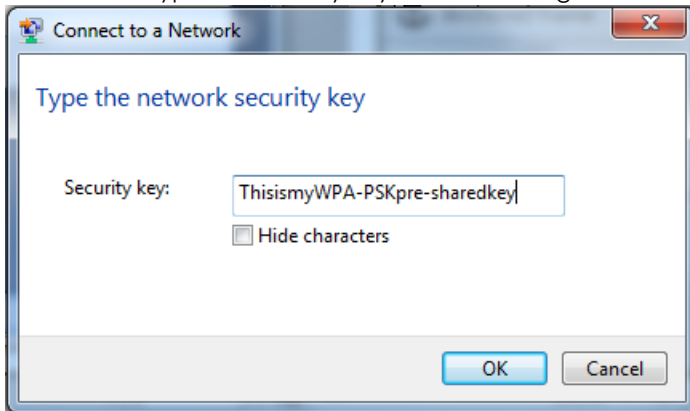

- 7 Check the status of your wireless connection in the screen below.



- 8 If the wireless client keeps trying to connect to or acquiring an IP address from the Zyxel Device, make sure you entered the correct security key.

If the connection has limited or no connectivity, make sure the DHCP server is enabled on the Zyxel Device.

If your connection is successful, open your Internet browser and enter <http://www.zyxel.com> or the URL of any other website in the address bar. If you are able to access the web site, your wireless connection is successfully configured.

4.4 Use Multiple SSIDs on the Zyxel Device

You can configure more than one SSID on a Zyxel Device. See [Section 7.3 on page 104](#).

This allows you to configure multiple independent wireless networks on the Zyxel Device as if there were multiple APs (virtual APs). Each virtual AP has its own SSID, and wireless security type. That is, each SSID on the Zyxel Device represents a different access point/wireless network to wireless clients in the network.

Clients can associate only with the SSIDs for which they have the correct security settings. Clients using different SSIDs can access the Internet and the wired network behind the Zyxel Device (such as a printer).

For example, you may set up three wireless networks (**A**, **B** and **C**) in your office. **A** is for workers, **B** is for guests and **C** is specific to a VoIP device in the meeting room.

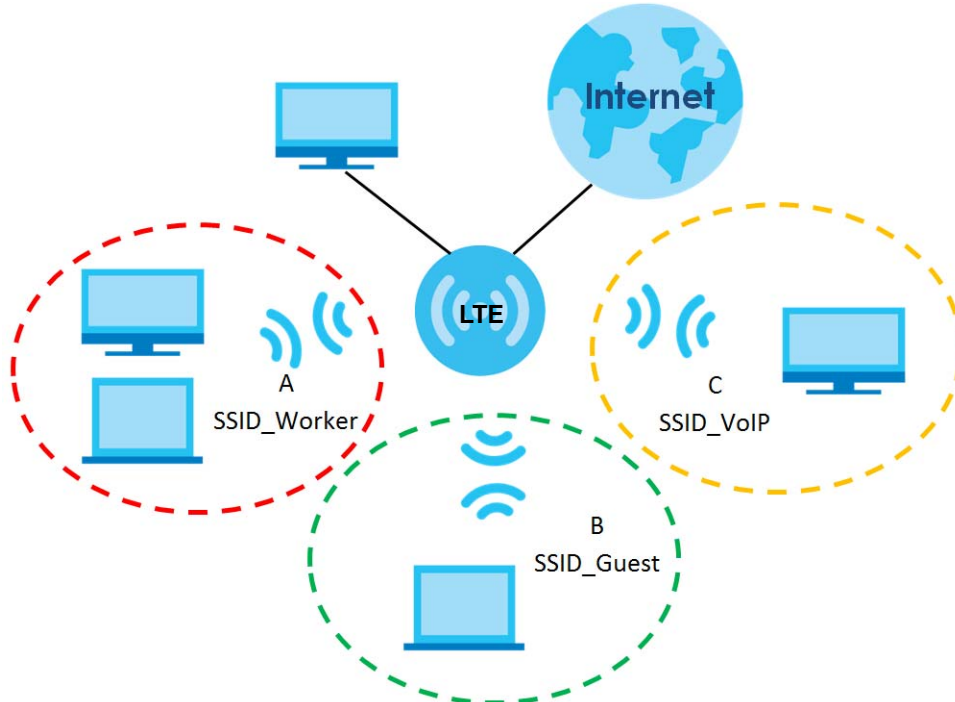



4.4.1 Configure Security Settings of Multiple SSIDs

The Zyxel Device is in router mode by default.

This example shows you how to configure the SSIDs with the following parameters on your Zyxel Device.

SSID	SECURITY TYPE	KEY
SSID_Worker	WPA2-PSK WPA Compatible	DoNotStealMyWirelessNetwork
SSID_VoIP	WPA-PSK	VoIPOnly12345678
SSID_Guest	WPA-PSK	keyexample123

- 1 Connect your computer to the LAN port of the Zyxel Device using an Ethernet cable.
- 2 The default IP address of the Zyxel Device is "192.168.1.1". In this case, your computer must have an IP address in the range between "192.168.1.2" and "192.168.1.254".
- 3 Click **Start > Run** on your computer in Windows. Type "cmd" in the dialog box. Enter "ipconfig" to show your computer's IP address. If your computer's IP address is not in the correct range then see [Section 7.3 on page 104](#) for information on changing your computer's IP address.
- 4 After you've set your computer's IP address, open a web browser such as Internet Explorer and type "http://192.168.1.1" as the web address in your web browser.
- 5 Use "admin" as the user name and "1234" (default) as the password and click **Login**.
- 6 Go to **Configuration > Network Setting > Wireless > Guest/More AP**. Click the **Modify/Edit** icon of the first entry to configure wireless and security settings for **SSID_Worker**.

#	Status	SSID	Security	Guest WLAN	Modify
1	🔒	Zyxel_B853_guest1	WPA2-Personal	N/A	
2	🔒	Zyxel_B853_guest2	WPA2-Personal	N/A	
3	🔒	Zyxel_B853_guest3	WPA2-Personal	N/A	

- 7 Configure the screen as follows. In this example, you enable **Intra-BSS Traffic** for **SSID_Worker** to allow wireless clients in the same wireless network to communicate with each other. Click **OK**.

Wireless Network Setup

Wireless

Security Level

Wireless Network Name:

Hide SSID

Guest WLAN

Max. Upstream Bandwidth: Kbps

Max. Downstream Bandwidth: Kbps

Note

(1) Max. Upstream Bandwidth: This field allows you to configure the maximum bandwidth of this SSID to WAN.
 (2) Max. Downstream Bandwidth: This field allows you to configure the maximum bandwidth of WAN to this SSID.
 (3) If Max. Upstream/Downstream Bandwidth is empty, the device sets the value automatically
 (4) Using Max. Upstream/Downstream Bandwidth will significantly decrease the wireless performance.

BSSID: 9A:0D:67:5C:88:53

SSID Subnet:

Security Level

No Security More Secure (Recommended)

Security Mode:

Generate password automatically

Enter 8-63 ASCII characters or 64 hexadecimal digits [0-9, "A-F"].

Password:

Strength: strong

8 Click the **Modify/Edit** icon of the second entry to configure wireless and security settings for **SSID_VoIP**.

General **Guest/More AP** MAC Authentication WPS WMM Others Channel Status

This device can enable up to 4 wireless networks to work at the same time. Assign a name and a security level (if needed) to start the 2nd, 3rd, and 4th wireless network services.

#	Status	SSID	Security	Guest WLAN	Modify
1		SSID_Worker	WPA2-Personal	N/A	
2		Zyxel_B853_guest2	WPA2-Personal	N/A	
3		Zyxel_B853_guest3	WPA2-Personal	N/A	

9 Configure the screen as follows. In this example, you do not enable **Intra-BSS Traffic** for **SSID_VoIP**. Click **OK**.

Wireless Network Setup

Wireless

Security Level

Wireless Network Name

Hide SSID

Guest WLAN

Max. Upstream Bandwidth Kbps

Max. Downstream Bandwidth Kbps

Note

(1) Max. Upstream Bandwidth: This field allows you to configure the maximum bandwidth of this SSID to WAN.
 (2) Max. Downstream Bandwidth: This field allows you to configure the maximum bandwidth of WAN to this SSID.
 (3) If Max. Upstream/Downstream Bandwidth is empty, the device sets the value automatically
 (4) Using Max. Upstream/Downstream Bandwidth will significantly decrease the wireless performance.

BSSID 9A:0D:67:5D:B8:53

SSID Subnet

Security Level

No Security More Secure
(Recommended)

Cancel

- 10 Click the **Modify/Edit** icon of the third entry to configure wireless and security settings for **SSID_Guest**.

General **Guest/More AP** MAC Authentication WPS WMM Others Channel Status

This device can enable up to 4 wireless networks to work at the same time. Assign a name and a security level (if needed) to start the 2nd, 3rd, and 4th wireless network services.

#	Status	SSID	Security	Guest WLAN	Modify
1		SSID_Worker	WPA2-Personal	N/A	
2		SSID_VoIP	WPA2-Personal	N/A	
3		ZyxeL_B853_guest3	WPA2-Personal	N/A	

- 11 Configure the screen as follows. In this example, you enable **Intra-BSS Traffic** for **SSID_Guest** to allow wireless clients in the same wireless network to communicate with each other. Click **OK**.

Wireless Network Setup

Wireless

Security Level

Wireless Network Name

Hide SSID

Guest WLAN

Max. Upstream Bandwidth Kbps

Max. Downstream Bandwidth Kbps

Note

(1) Max. Upstream Bandwidth: This field allows you to configure the maximum bandwidth of this SSID to WAN.
(2) Max. Downstream Bandwidth: This field allows you to configure the maximum bandwidth of WAN to this SSID.
(3) If Max. Upstream/Downstream Bandwidth is empty, the device sets the value automatically
(4) Using Max. Upstream/Downstream Bandwidth will significantly decrease the wireless performance.

BSSID

SSID Subnet

Security Level

No Security More Secure
(Recommended)

▼

Security Mode

Generate password automatically
Enter 8-63 ASCII characters or 64 hexadecimal digits [0-9], [A-F].

Password

Strength strong

👉

Cancel OK

4.5 Make a VoIP/VoLTE Phone Call

You can make phone calls over the VoIP/VoLTE via the Zyxel Device.

- 1 For VoIP, make sure a SIM card is installed on the Zyxel Device to have Internet access. For VoLTE (Vo3G), contact your ISP to make sure that your SIM card supports VoLTE (Vo3G).
- 2 Log into the Web Configurator.
- 3 Go to the **Configuration > Voice > Voice Mode** screen.
- 4 Select **Enable** in the **Voice Mode** screen to activate the VoIP/VoLTE service. Click **Apply**.

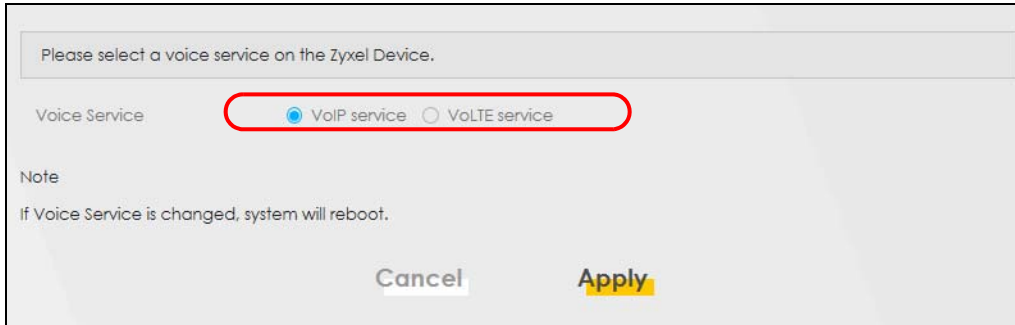

- 5 Connect an analog telephone to a **PHONE** port to make phone calls over the VoIP/VoLTE.

4.6 Configure a Firewall Rule

You can enable the firewall to protect your LAN computers from malicious attacks from the Internet if you want to allow specific traffic in from the Internet.

- 1 Click **Configuration > Security > Firewall** to open the **General** screen.
- 2 Select **IPv4 Firewall/IPv6 Firewall** to enable the firewall, and click **Apply**.

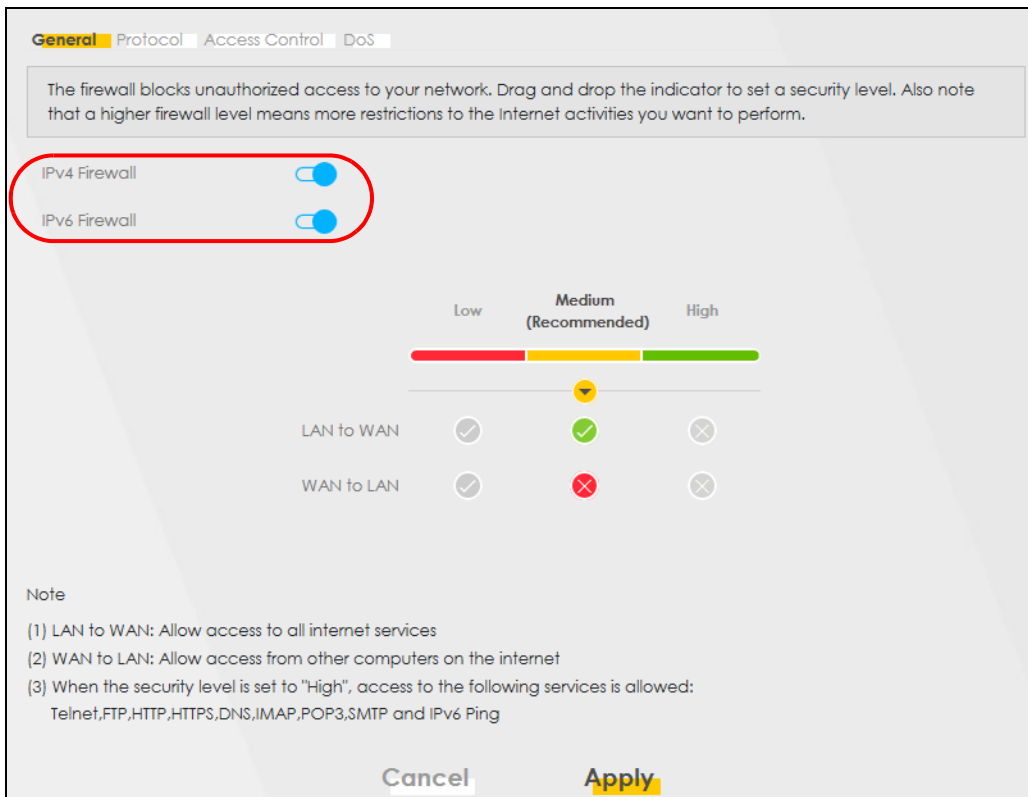

- 3 Open the **Access Control** screen to create a rule.
- 4 Click **Add New ACL Rule** to set up a rule.

- **Filter Name:** Enter a name to identify the firewall rule.
 - **Source IP Address:** Enter the IP address of the computer that initializes traffic for the application or service.
 - **Select Destination IP Address:** Enter the IP address of the computer to which traffic for the application or service is entering.
 - **Protocol:** Select the protocol (**TCP**, **UDP** or **ICMP**) used to transport the packets.
 - **Custom Source Port:** Enter the port number/range of the source that define the traffic type.
 - **Custom Destination Port:** Enter the port number/range of the destination that define the traffic type.
- 5 Select **Enable Rate Limit** to activate the rules you created. Click **OK**.

The screenshot shows the 'Add New ACL Rule' configuration interface. The fields are as follows:

- Filter Name: [Empty text box]
- Order: 1
- Select Source IP Address: Specific IP Address
- Source IP Address: [Empty text box] [/(prefix length)]
- Select Destination Device: Specific IP Address
- Destination IP Address: [Empty text box] [/(prefix length)]
- IP Type: IPv4
- Select Service: Specific Service
- Protocol: ALL
- Custom Source Port: Range 1 - 1
- Custom Destination Port: Range 1 - 1
- Policy: ACCEPT
- Direction: WAN to LAN
- Enable Rate Limit:
- Rate Limit: [Empty text box] packet(s) per Minute [1-512]
- Scheduler Rules: [Empty dropdown menu]

Buttons: Cancel, OK (highlighted in yellow), Add New Rule (highlighted in yellow).

4.7 Configure MAC Filter

You can block certain web features and specific website addresses.

- 1 Go to the **Configuration > Security > MAC Filter** screen. Click **Add New Rule**.
- 2 Type the **Host Name** and the corresponding **MAC Address** that you want to block in the **MAC Filter** screen.
- 3 Select the **Active** check box and click **Apply**.

MAC Filter

Enable MAC filters and add the MAC addresses of LAN client in your home or office network to the following table, if you wish to allow or deny them to access your network. Sometimes, MAC Filter is considered a method to increase the security of your network.

MAC Address Filter Enable Disable (Settings are invalid when disable)

MAC Restrict Mode Allow Deny

[+ Add New Rule](#)

Set	Active	Host Name	MAC Address	Delete
1	<input checked="" type="checkbox"/>	<input type="text"/>	<input type="text"/>	
2	<input checked="" type="checkbox"/>	<input type="text"/>	<input type="text"/>	

Note
Only devices listed here are granted access to the network

[Cancel](#) [Apply](#)

4.8 Upgrade Firmware on the Zyxel Device

Upload the router firmware to the Zyxel Device for feature enhancements.

- 1 Download the firmware file at www.zyxel.com in a compressed file. Decompress the file.
- 2 Go to the **Maintenance > Firmware Upgrade** screen.
- 3 Click **Browse** and select a .bin file to upload. Click **Upload**.

Firmware Upgrade

Firmware Upgrade is where you can update the device with newly released features by upgrading the latest firmware. You can download the latest firmware file from the manufacturer website of this device.

Upgrade Firmware

Restore Default Settings After Firmware Upgrade

Current Firmware Version: 2.00(ABMP.1)C0

File Path [Browse...](#) [Upload](#)

Do Online Firmware Upgrade

[Check for Latest Firmware Now](#)

- 4 This process may take up to two minutes to finish. After two minutes, log in again and check your new firmware version in the **Status** screen.

4.9 Back up a Configuration File

Back up a configuration file in case you want to return to your previous settings.

- 1 Go to the **Maintenance > Backup/Restore** screen.
- 2 Click **Backup** in the **Backup Configuration** section, and a configuration file will be saved to your computer.

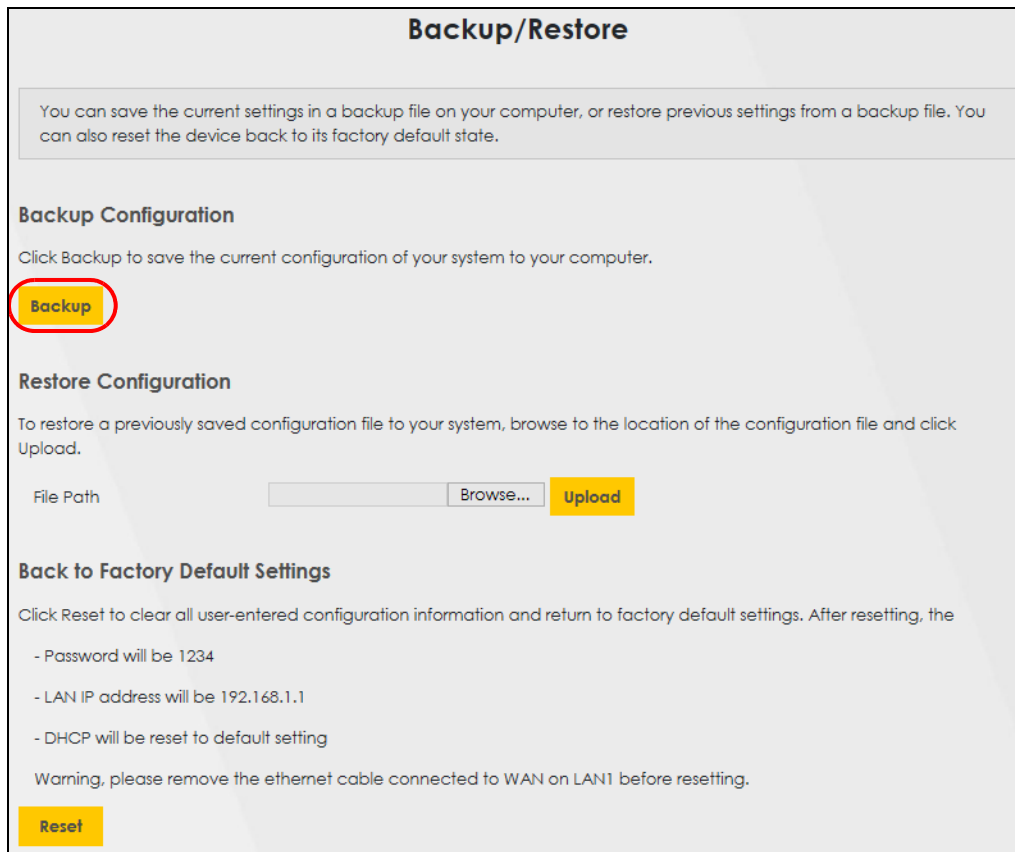

Backup/Restore

You can save the current settings in a backup file on your computer, or restore previous settings from a backup file. You can also reset the device back to its factory default state.

Backup Configuration

Click Backup to save the current configuration of your system to your computer.

Backup

Restore Configuration

To restore a previously saved configuration file to your system, browse to the location of the configuration file and click Upload.

File Path

Back to Factory Default Settings

Click Reset to clear all user-entered configuration information and return to factory default settings. After resetting, the

- Password will be 1234
- LAN IP address will be 192.168.1.1
- DHCP will be reset to default setting

Warning, please remove the ethernet cable connected to WAN on LAN1 before resetting.

4.10 Restore Configuration

You can upload a previously saved configuration file from your computer to your Zyxel Device to restore that previous configuration.

- 1 Go to the **Maintenance > Backup/Restore** screen.
- 2 Click **Browse** in **Restore Configuration** section, and select the configuration file that you want to upload. Click **Upload**.

Backup/Restore

You can save the current settings in a backup file on your computer, or restore previous settings from a backup file. You can also reset the device back to its factory default state.

Backup Configuration

Click Backup to save the current configuration of your system to your computer.

Backup

Restore Configuration

To restore a previously saved configuration file to your system, browse to the location of the configuration file and click Upload.

File Path Browse... **Upload**

Back to Factory Default Settings

Click Reset to clear all user-entered configuration information and return to factory default settings. After resetting, the

- Password will be 1234
- LAN IP address will be 192.168.1.1
- DHCP will be reset to default setting

Warning, please remove the ethernet cable connected to WAN on LAN1 before resetting.

Reset

- 3 The Zyxel Device will restart automatically after the configuration file is successfully uploaded. Wait for one minute before logging into the Zyxel Device again.

4.11 Connect to the Internet

This section gives you an example on how to connect to the Internet.

- 1 Insert the SIM Card into your Zyxel Device SIM slot. Make sure this SIM has an active data plan with your Internet Service Provider (ISP).
- 2 Connect your Zyxel Device to your computer, and log into the Web Configurator.
- 3 If your SIM has a PIN Code, enter this code in the **Broadband > Cellular SIM** screen.
- 4 Use the **Home** screen to check the **Internet Status (IPv4)** or **Internet Status (IPv6)**. If it shows **Connected** this means your Internet connection is up.

4.12 Configure DHCP

You can enable the DHCP (Dynamic Host Configuration Protocol) in your Zyxel Device to assign IP addresses and DNS servers to systems that support DHCP client capability. DHCP allows clients to obtain TCP/IP configuration at start-up from a server.

The following figure shows how **Client A** uses DHCP to join the Zyxel Device's network. First Client A searches for an available DHCP, and sends a **DHCP Discover** broadcast message asking for an IP address to connect to. Then the DHCP selects an IP address from its pool of IP addresses for Client A. The DHCP sends a **DHCP Offer** including the IP address selected and a lease time, which is the period of time Client A will be able to use this IP address. After Client A has received DHCP offers for an IP address, it chooses one and sends out a **DHCP Request** including the IP address it chose. Finally the DHCP confirms through a **DHCP Ack (Acknowledge)** message that the host can use the IP address for the previously specified lease time.

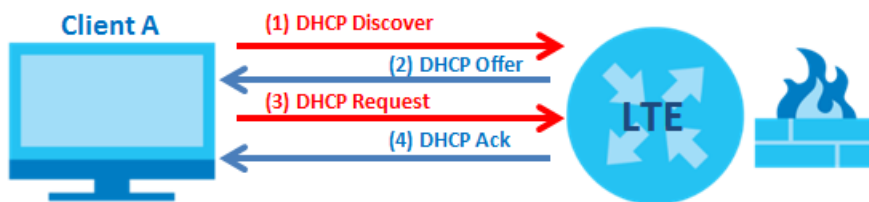

To configure the DHCP in your Zyxel Device:

- 1 Log into the Zyxel Device's Web Configurator.
- 2 Click **Network Setting > Home Networking > LAN Setup**.
- 3 Select **Enable DHCP Server State**.
- 4 Enter a range of addresses from which your DHCP will assign to devices in your network.

Note: Do not include the Zyxel Device's LAN IP address in your range of addresses.

- 5 Type the **DHCP Server Lease Time**, the period of time (in minutes) a device can use one of the IP addresses from the DHCP pool. The lease time helps recycle unused IP addresses so that other can use them again. Click **Apply**.

4.12.1 Add Devices to Your Static DHCP List

IP addresses from the DHCP pool can be reused after they have completed their lease time. Add your devices to your Static DHCP List so they have the same IP address everytime they connect to your network.

To add a device to your Static DHCP List:

- 1 Log into the Zyxel Device's Web Configurator.
- 2 Go to **Network Setting > Home Networking > Static DHCP** screen.

- 3 Click **Static DHCP Configuration** in the Static DHCP Configuration screen.
- 4 Select **Active** and type the **IP address** you want to assign to your device.
- 5 Type the **MAC Address** of your device to which the LTE7460 assigns the IP address and click **OK**.

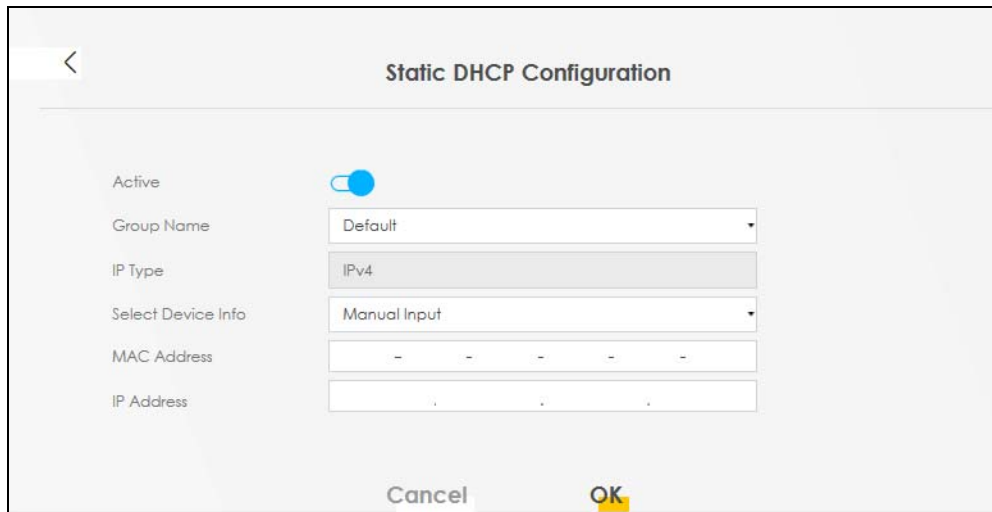

The screenshot displays the 'Static DHCP Configuration' interface. It features a back arrow in the top left corner. The title 'Static DHCP Configuration' is centered at the top. Below the title, there is a list of configuration options:

- Active:** A blue toggle switch is turned on.
- Group Name:** A dropdown menu showing 'Default'.
- IP Type:** A dropdown menu showing 'IPv4'.
- Select Device Info:** A dropdown menu showing 'Manual Input'.
- MAC Address:** A text input field with five dashes as a placeholder.
- IP Address:** A text input field with four dots as a placeholder.

At the bottom of the screen, there are two buttons: 'Cancel' on the left and 'OK' on the right, which is highlighted with a yellow cursor.

4.13 Configure Static Route for Routing to Another Network

In order to extend your Intranet and control traffic flowing directions, you may connect a router to the Zyxel Device's LAN. The router may be used to separate two area networks. This tutorial shows how to configure a static routing rule for two network routings.

In the following figure, router **R** is connected to the Zyxel Device's LAN. **R** connects to two networks, **N1** (192.168.1.x/24) and **N2** (192.168.10.x/24). If you want to send traffic from computer **A** (in **N1** network) to

computer **B** (in **N2** network), the traffic is sent to the Zyxel Device's WAN default gateway by default. In this case, **B** will never receive the traffic.

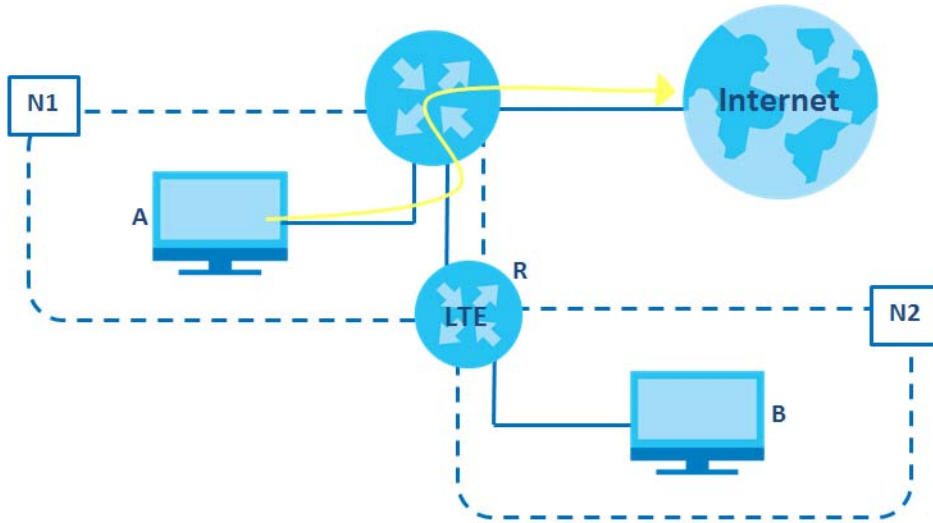

You need to specify a static routing rule on the Zyxel Device to specify **R** as the router in charge of forwarding traffic to **N2**. In this case, the Zyxel Device routes traffic from **A** to **R** and then **R** routes the traffic to **B**.

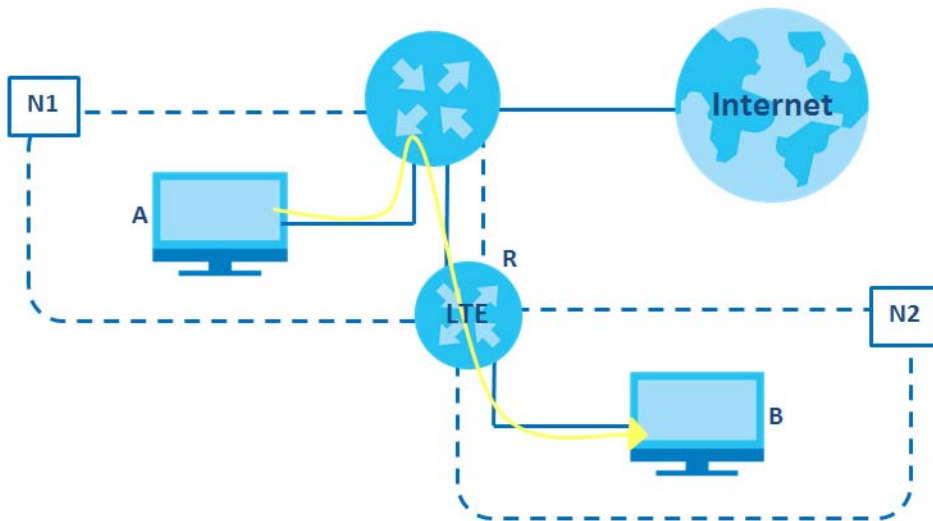

This tutorial uses the following example IP settings:

Table 12 IP Settings in this Tutorial

DEVICE / COMPUTER	IP ADDRESS
The Zyxel Device's LAN	192.168.1.1
A	192.168.1.34
R's N1	192.168.1.253
R's N2	192.168.10.2
B	192.168.10.33

To configure a static route to route traffic from **N1** to **N2**:

- 1 Log into the Zyxel Device's Web Configurator.
- 2 Go to **Network Setting > Routing > Static Route** screen.
- 3 Click **Add New Static Route** in the Static Route screen.
- 4 Configure the Static Route Setup screen using the following settings:
 - 4a Type 192.168.10.2 and subnet mask 255.255.255.0 for the destination, N2.
 - 4b Type 192.168.1.253 (R's N1 address) in the **Gateway IP Address** field.
 - 4c Click **OK**.

Now **B** should be able to receive traffic from **A**. You may need to additionally configure **B**'s firewall settings to allow specific traffic to pass through.

The screenshot displays the 'Add New Static Route' configuration interface. It includes a back arrow in the top left, a title 'Add New Static Route', and several configuration options:

- Active:** A toggle switch that is turned on (blue).
- Route Name:** An empty text input field.
- IP Type:** A dropdown menu set to 'IPv4'.
- Destination IP Address:** A text input field with a yellow border, containing four dots representing a dotted IP address.
- Subnet Mask:** A text input field with three dots representing a dotted subnet mask.
- Use Gateway IP Address:** A toggle switch that is turned on (blue).
- Gateway IP Address:** A text input field with three dots representing a dotted IP address.
- Use Interface:** A dropdown menu set to 'Default'.

Below the fields is a **Note** section with the text: "The input range of the Gateway IP Address must be in the same range of the Use Interface." At the bottom of the screen are two buttons: **Cancel** and **OK**.

4.14 Access the Zyxel Device Using DDNS

If you connect your Zyxel Device to the Internet and it uses a dynamic WAN IP address, it is inconvenient for you to manage the device from the Internet. The Zyxel Device's WAN IP address changes dynamically. Dynamic DNS (DDNS) allows you to access the Zyxel Device using a domain name.

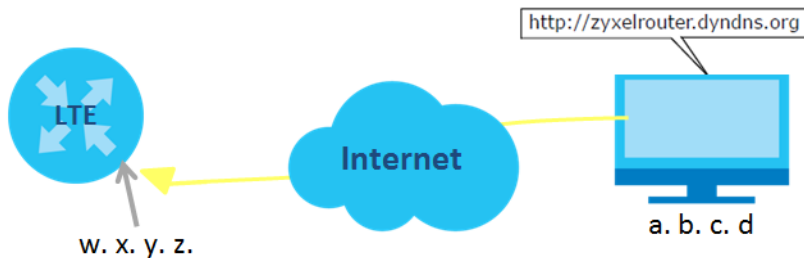

To use this feature, you have to apply for DDNS service at www.dyndns.org.

This tutorial covers:

- Registering a DDNS Account on www.dyndns.org
- Configuring DDNS on Your Zyxel Device
- Testing the DDNS Setting

Note: If you have a private WAN IP address, then you cannot use DDNS.

4.14.1 Register a DDNS Account on www.dyndns.org

- 1 Open a browser and type <http://www.dyndns.org>.
- 2 Apply for a user account. This tutorial uses **UserName1** and **12345** as the username and password.
- 3 Log into www.dyndns.org using your account.
- 4 Add a new DDNS host name. This tutorial uses the following settings as an example.
 - Hostname: **zyxelrouter.dyndns.org**
 - Service Type: **Host with IP address**
 - IP Address: Enter the WAN IP address that your Zyxel Device is currently using. You can find the IP address on the Zyxel Device's Web Configurator **Home** page.
- 5 Then you will need to configure the same account and host name on the Zyxel Device later.

4.14.2 Configure DDNS on Your Zyxel Device

Configure the following settings in the **Network Setting > DNS > Dynamic DNS** screen.

- Select Enable **Dynamic DNS**.
- Select www.DynDNS.com as **Service Provider**.
- Type zyxelrouter.dyndns.org in the **Host Name** field.

- Type the user name (UserName1) and password (12345).

DNS Entry **Dynamic DNS**

Dynamic DNS can update your current dynamic IP into a hostname. Use the settings to set up dynamic DNS information.

Dynamic DNS Setup

Dynamic DNS Enable Disable (Settings are invalid when disable)

Service Provider

Host Name

Username

Password

Enable Wildcard Option

Enable Off Line Option (Only applies to custom DNS)

Dynamic DNS Status

User Authentication Result

Last Updated Time

Current Dynamic IP

Cancel Apply

Click **Apply**.

4.14.3 Test the DDNS Settings

Now you should be able to access the Zyxel Device from the Internet. To test this:

- 1 Open a web browser on the computer (using the IP address a.b.c.d) that is connected to the Internet.
- 2 Type <http://zyxelrouter.dyndns.org> and press [Enter].
- 3 The Zyxel Device's login page should appear. You can then log into the Zyxel Device and manage it.

PART II

Technical Reference

CHAPTER 5

Connection Status

5.1 Connection Status Overview

After you log into the Web Configurator, the **Connection Status** screen appears. You can configure basic Internet access and wireless settings in this screen. It also shows the network status of the Zyxel Device and computers/devices connected to it.

5.1.1 Connectivity

Use this screen to view the network connection status of the Zyxel Device and its clients.

Figure 44 Connectivity

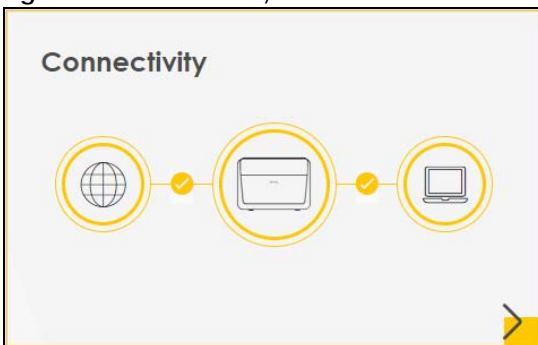

Click the Arrow icon () to view IP addresses and MAC addresses of the wireless and wired devices connected to the Zyxel Device.

Figure 45 Connectivity: Connected Devices



You can change the icon and name of a connected device. Place your mouse within the device block, and an Edit icon () will appear. Click the Edit icon, and you'll see there are several icon choices for you to select. Enter a name in the **Device Name** field for a connected device. Click to enable () **Internet Blocking** for a connected device. Click **Save** to save your changes.

Figure 46 Connectivity: Edit



5.1.2 System Info

Use this screen to view the basic system information of the Zyxel Device.

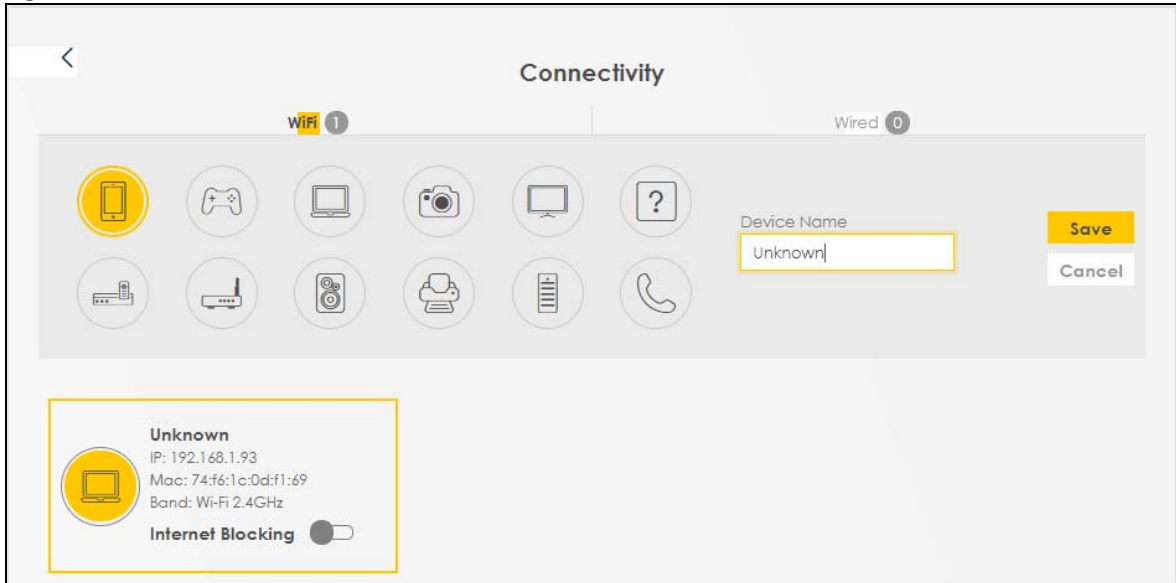
Figure 47 System Info

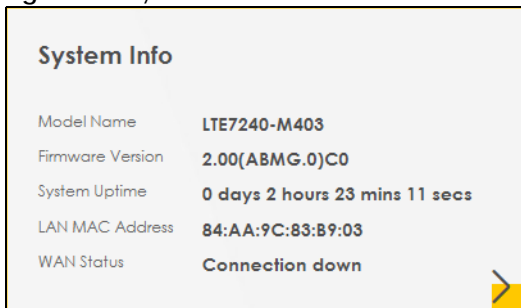

Click the Arrow icon (➤) to view more information on the status of your firewall and interfaces (WAN, LAN, and WLAN).

Figure 48 System Info: Detailed Information

System Info

Host Name: LTE5388-M804
 Model Name: LTE5388-M804
 Serial number: S190Z44004654
 Firmware Version: 1.00[ABSQ.0]b1
 System Uptime: 0 days 2 hours 35 mins 6 secs

Interface Status

WAN LAN2 Cellular USB WLAN 2.4G WLAN 5G
 - 1000M/Full No Device 144 Mbps 1732 Mbps

WAN Information (No WAN)	WLAN Information	2.4GHz	5GHz
LAN Information	MAC Address	98:0D:67:99:63:55	98:0D:67:99:63:56
IP Address: 192.168.1.1	Status	On	On
Subnet Mask: 255.255.255.0	SSID	Zyxel_6355	Zyxel_6355_5G
IPv6 Address: N/A	Channel	Auto(Current 0)	Auto(Current 0)
IPv6 Link Local Address: fe80::9a0d:67ff:fe99:6354	Security	WPA2-Personal	WPA2-Personal
DHCP: Server	802.11 Mode	802.11b/g/n Mixed	802.11a/n/ac Mixed
Security	WPS	On	On
Firewall: Disable			

Each field is described in the following table.

Table 13 System Info: Detailed Information

LABEL	DESCRIPTION
Host Name	This field displays the Zyxel Device system name. It is used for identification.
Model Name	This shows the model number of your Zyxel Device.
Serial Number	This field displays the serial number of the Zyxel Device.
Firmware Version	This is the current version of the firmware inside the Zyxel Device.
System Up Time	This field displays how long the Zyxel Device has been running since it last started up. The Zyxel Device starts up when you plug it in, when you restart it (Maintenance > Reboot), or when you reset it.
Interface Status	
Virtual ports are shown here. You can see the ports in use and their transmission rate.	
WAN Information (These fields display when you have a WAN connection.)	
Mode	This field displays the current mode of your Zyxel Device.
IP Address	This field displays the current IP address of the Zyxel Device in the WAN.
IP Subnet Mask	This field displays the current subnet mask in the WAN.
IPv6 Address	This field displays the current IPv6 address of the Zyxel Device in the WAN.
Primary DNS server	This field displays the first DNS server address assigned by the ISP.
Secondary DNS server	This field displays the second DNS server address assigned by the ISP.
Primary DNSv6 server	This field displays the first DNS server IPv6 address assigned by the ISP.

Table 13 System Info: Detailed Information (continued)

LABEL	DESCRIPTION
Secondary DNSv6 server	This field displays the second DNS server IPv6 address assigned by the ISP.
LAN Information	
IP Address	This is the current IP address of the Zyxel Device in the LAN.
Subnet Mask	This is the current subnet mask in the LAN.
DHCP	This field displays what DHCP services the Zyxel Device is providing to the LAN. The possible values are: Server - The Zyxel Device is a DHCP server in the LAN. It assigns IP addresses to other computers in the LAN. Relay - The Zyxel Device acts as a surrogate DHCP server and relays DHCP requests and responses between the remote server and the clients. None - The Zyxel Device is not providing any DHCP services to the LAN.
Security	
Firewall	This displays the firewall's current security level.
WLAN Information	
MAC Address	This shows the wireless adapter MAC (Media Access Control) Address of the wireless interface.
Status	This displays whether the WLAN is activated.
SSID	This is the descriptive name used to identify the Zyxel Device in a wireless LAN.
Channel	This is the channel number currently used by the wireless interface.
Security	This displays the type of security mode the wireless interface is using in the wireless LAN.
802.11 Mode	This displays the type of 802.11 mode the wireless interface is using in the wireless LAN.
WPS	This displays whether WPS is activated on the wireless interface.

5.1.3 Cellular Info

Use this screen to view the LTE connection details and LTE signal strength value that you can use as reference for positioning the Zyxel Device, as well as SIM card and module information.

Figure 49 Cellular Info



Cellular Info	
Mode	IP Passthrough Mode
Status	Up
IP Address	10.204.58.202
Primary DNS server	210.241.208.1, 139.175.1.1
Access Technology	LTE
Signal Strength	-71

Click the Arrow icon () to view the more information on the LTE connection.

Figure 50 Cellular Info: Detailed Information

Cellular Info	
Module Information	
IMEI	351964110000165
Module SW Version	EG12EAPAR01A05M4G
SIM Status	
SIM Card Status	Available
IMSI	466011801891892
ICCID	89886018157708842319
PIN Protection	Disable
PIN Remaining Attempts	3
IP Passthrough Status	
IP Passthrough Enable	Disable
Cellular Status	
Cellular Status	Up
Data Roaming	Disable
Operator	Far EastOne
PLMN	46601
Service Information	
Access Technology	LTE
Band	LTE_BC7
RSI	-53
Cell ID	56410647
Physical Cell ID	23
UL Bandwidth [MHz]	20
DL Bandwidth [MHz]	20
RFCN	3250
RSRP	-80
RSRQ	-9
RSCP	N/A
EcNo	N/A
TAC	59242
LAC	N/A
RAC	N/A
BSIC	N/A
SINR	19

The following table describes the labels in this screen.

Table 14 Cellular Info: Detailed Information

LABEL	DESCRIPTION
Module Information	
IMEI	This shows the International Mobile Equipment Identity of the Zyxel Device.
Module SW Version	This shows the software version of the LTE module.
SIM Status	
SIM Card Status	This displays the SIM card status: None - the Zyxel Device does not detect that there is a SIM card inserted. Available - the SIM card could either have or doesn't have PIN code security. Locked - the SIM card has PIN code security, but you did not enter the PIN code yet. Blocked - you entered an incorrect PIN code too many times, so the SIM card has been locked; call the ISP for a PUK (Pin Unlock Key) to unlock the SIM card. Error - the Zyxel Device detected that the SIM card has errors.
IMSI	This displays the International Mobile Subscriber Identity (IMSI) of the installed SIM card. An IMSI is a unique ID used to identify a mobile subscriber in a mobile network.
ICCID	Integrated Circuit Card Identifier (ICCID). This is the serial number of the SIM card.
PIN Protection	A PIN (Personal Identification Number) code is a key to a SIM card. Without the PIN code, you cannot use the SIM card. Shows Enable if the service provider requires you to enter a PIN to use the SIM card. Shows Disable if the service provider lets you use the SIM without inputting a PIN.
PIN Remaining Attempts	This is how many more times you can try to enter the PIN code before the ISP blocks your SIM card.
IP Passthrough Status	

Table 14 Cellular Info: Detailed Information

LABEL	DESCRIPTION
IP Passthrough Enable	This displays if IP Passthrough is enabled on the Zyxel Device. IP Passthrough allows a LAN computer on the local network of the Zyxel Device to have access to web services using the public IP address. When IP Passthrough is configured, all traffic is forwarded to the LAN computer and will not go through NAT.
IP Passthrough Mode	This displays the IP Passthrough mode. This displays Dynamic and the Zyxel Device will allow traffic to be forwarded to the first LAN computer requesting an IP address from the Zyxel Device. This displays Fixed and the Zyxel Device will allow traffic to be forwarded to a specific LAN computer on the local network of the Zyxel Device.
Cellular Status	
Cellular Status	This displays the status of the cellular Internet connection.
Data Roaming	This displays if data roaming is enabled on the Zyxel Device. 4G roaming is to use your Zyxel Device in an area which is not covered by your service provider. Enable roaming to ensure that your Zyxel Device is kept connected to the Internet when you are traveling outside the geographical coverage area of the network to which you are registered.
Operator	This displays the name of the service provider.
PLMN	This displays the PLMN number.
Service Information	
Access Technology	This displays the type of the mobile network (such as LTE, UMTS, GSM) to which the Zyxel Device is connecting.
Band	This displays the current LTE band of your Zyxel Device (WCDMA2100).
RSSI	This displays the strength of the 3G/LTE signal strength between an associated cellular station and the Zyxel Device.
Cell ID	This shows the cell ID, which is a unique number used to identify the Base Transceiver Station to which the Zyxel Device is connecting. The value depends on the Current Access Technology: <ul style="list-style-type: none"> • For GPRS, it is the Cell Identity as specified in 3GPP-TS.25.331. • For UMTS, it is the Cell Identity as defined in SIB3 3GPP-TS.25.331, 3GPP-TS.24.008. • For LTE, it is the 28-bit binary number Cell Identity as specified in SIB1 in 3GPP-TS.36.331. The value is '0' (zero) or 'N/A' if there is no network connection.
Physical Cell ID	This shows the Physical Cell ID (PCI), which are queries and replies between the Zyxel Device and the mobile network it is connecting to. The normal range is 1 to 504.
UL Bandwidth (MHz)	This shows the LTE channel bandwidth from device to base station. According to 3GPP specifications, the bandwidths defined by the standard are 1.4, 3, 5, 10, 15, and 20 MHz. The wider the bandwidth the higher the throughput.
DL Bandwidth (MHz)	This shows the LTE channel bandwidth from base station to LTE device. According to 3GPP specifications, the bandwidths defined by the standard are 1.4, 3, 5, 10, 15, and 20 MHz. The wider the bandwidth the higher the throughput.

Table 14 Cellular Info: Detailed Information

LABEL	DESCRIPTION
RFCN	<p>This displays the Radio Frequency Channel Number of DL carrier frequency used by the mobile network to which the Zyxel Device is connecting.</p> <p>The value depends on the Current Access Technology:</p> <ul style="list-style-type: none"> For GPRS, it is the ARFCN (Absolute Radio-Frequency Channel Number) as specified in 3GPP-TS.45.005. For UMTS, it is the UARFCN (UTRA Absolute Radio-Frequency Channel Number) as specified in 3GPP-TS.25.101. For LTE, it is the EARFCN (E-UTRA Absolute Radio-Frequency Channel Number) as specified in 3GPP-TS.36.101. <p>The value is '0' (zero) or 'N/A' if there is no network connection.</p>
RSRP	<p>This displays the Reference Signal Receive Power (RSRP), which is the average received power of all Resource Element (RE) that carry cell-specific Reference Signals (RS) within the specified bandwidth.</p> <p>The received RSRP level of the connected E-UTRA cell, in dBm, is as specified in 3GPP-TS.36.214. The reporting range is specified in 3GPP-TS.36.133.</p> <p>An undetectable signal is indicated by the lower limit, example -140 dBm.</p> <p>This parameter is for LTE only. The normal range is -30 to -140. The value is -140 if the Current Access Technology is not LTE. The value is 'N/A' if there is no network connection.</p>
RSRQ	<p>This displays the Reference Signal Receive Quality (RSRQ), which is the ratio of RSRP to the E-UTRA carrier RSSI and indicates the quality of the received reference signal.</p> <p>The received RSRQ level of the connected E-UTRA cell, in 0.1 dB, is as specified in 3GPP-TS.36.214. An undetectable signal is indicated by the lower limit, example -240.</p> <p>This parameter is for LTE only. The normal range is -30 to -240. The value is -240 if the Current Access Technology is not LTE. The value is 'N/A' if there is no network connection.</p>
RSCP	<p>This displays the Received Signal Code Power, which measures the power of channel used by the Zyxel Device.</p> <p>The received signal level, in dBm, is of the CPICH channel (Ref. 3GPP TS 25.133). An undetectable signal is indicated by the lower limit, example -120 dBm.</p> <p>This parameter is for UMTS only. The normal range is -30 to -120. The value is -120 if the Current Access Technology is not UMTS. The value is 'N/A' if there is no network connection.</p>
EcNo	<p>This displays the ratio (in dB) of the received energy per chip and the interference level.</p> <p>The measured EcNo is in 0.1 dB and is received in the downlink pilot channel. An undetectable signal is indicated by the lower limit, example -240 dB.</p> <p>This parameter is for UMTS only. The normal range is -30 to -240. The value is -240 if the Current Access Technology is not UMTS or there is no network connection.</p>
TAC	<p>This displays the Tracking Area Code (TAC), which is used to identify the country of a mobile subscriber.</p> <p>The physical cell ID of the connected E-UTRAN cell, is as specified in 3GPP-TS.36.101.</p> <p>This parameter is for LTE only. The value is '0' (zero) or 'N/A' if the Current Access Technology is not LTE or there is no network connection.</p>
LAC	<p>This displays the 2-octet Location Area Code (LAC), which is used to identify a location area within a PLMN.</p> <p>The LAC of the connected cell is as defined in SIB 1 [3GPP-TS.25.331]. The concatenation of PLMN ID (MCC+MNC) and LAC uniquely identifies the LAI (Location Area ID) [3GPP-TS.23.003].</p> <p>This parameter is for UMTS or GPRS. The value is '0' (zero) if the Current Access Technology is not UMTS or GPRS. The value is 'N/A' if there is no network connection.</p>

Table 14 Cellular Info: Detailed Information

LABEL	DESCRIPTION
RAC	<p>This displays the RAC (Routing Area Code), which is used in mobile network "packet domain service" (PS) to identify a routing area within a location area.</p> <p>In a mobile network, it uses LAC (Location Area Code) to identify the geographical location for the old 3G voice only service, and use RAC to identify the location of data service like HSDPA or LTE.</p> <p>The RAC of the connected UTRAN cell is as defined in SIB 1 [3GPP-TS.25.331]. The concatenation of PLMN ID (MCC+MNC), LAC, and RAC uniquely identifies the RAI (Routing Area ID) [3GPP-TS.23.003].</p> <p>This parameter is for UMTS or GPRS. The value is '0' (zero) if the Current Access Technology is not UMTS or GPRS. The value is 'N/A' if there is no network connection.</p>
BSIC	<p>The Base Station Identity Code (BSIC), which is a code used in GSM to uniquely identify a base station.</p> <p>This parameter is for GPRS only. The value is '0' (zero) if the Current Access Technology is not GPRS. The value is 'N/A' if there is no network connection.</p>
SINR	This displays the Signal to Interference plus Noise Ratio (SINR) in dB. This is also a measure of signal quality and used by the UE (User Equipment) to calculate the Channel Quality Indicator (CQI) that it reports to the network. A negative value means more noise than signal.
CQI	This displays the Channel Quality Indicator (CQI). It is an indicator carrying the information on how good/bad the communication channel quality is.
MCS	MCS stands for modulation coding scheme. The base station selects MCS based on current radio conditions. The higher the MCS the more bits can be transmitted per time unit.
RI	This displays the Rank Indication, one of the control information that a UE will report to eNodeB (Evolved Node-B) on either PUCCH (Physical Uplink Control Channel) or PUSCH (Physical Uplink Shared Channel) based on uplink scheduling.
PMI	<p>This displays the Precoding Matrix Indicator (PMI).</p> <p>PMI is for transmission modes 4 (closed loop spatial multiplexing), 5 (multi-user MIMO), and 6 (closed loop spatial multiplexing using a single layer).</p> <p>PMI determines how cellular data are encoded for the antennas to improve downlink rate.</p>

5.1.4 WiFi Settings



Use this screen to enable or disable the main wireless network. When the switch turns blue () , the function is enabled. Otherwise, it's not. You can use this screen or the QR code on the upper right corner to check the SSIDs (WiFi network name) and passwords of the main wireless networks. If you want to show or hide your WiFi passwords, click the Eye icon () .

Figure 51 WiFi Settings



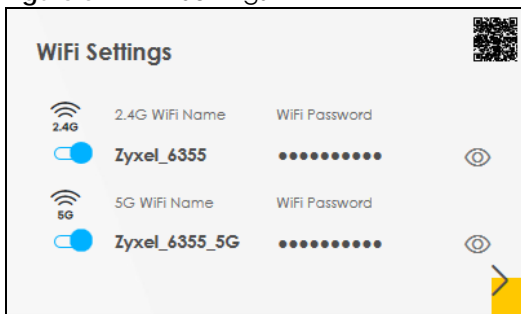
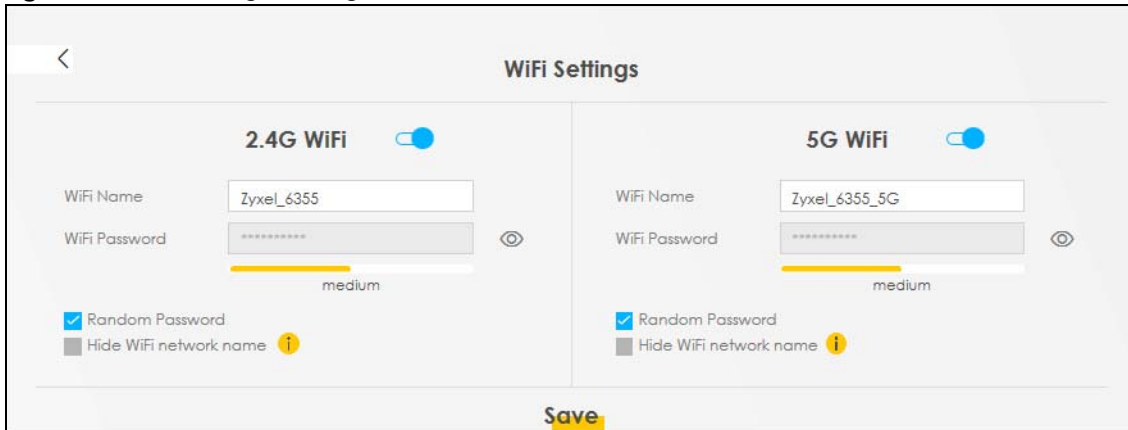

Click the Arrow icon (➤) to configure the SSIDs and/or passwords for your main wireless networks. Click the Eye icon (👁) to display the characters as you enter the WiFi Password.

Figure 52 WiFi Settings: Configuration



Each field is described in the following table.

Table 15 WiFi Settings: Configuration

LABEL	DESCRIPTION
2.4G / 5G WiFi	Click this switch to enable or disable the 2.4 GHz / 5 GHz wireless network. When the switch turns blue  , the function is enabled. Otherwise, it's not.
WiFi Name	The SSID (Service Set IDentity) identifies the service set with which a wireless device is associated. Wireless devices associating to the access point (AP) must have the same SSID. Enter a descriptive name (up to 32 English keyboard characters) for the wireless LAN.
WiFi Password	If you selected Random Password , this field displays a pre-shared key generated by the Zyxel Device. If you did not select Random Password , you can manually type a pre-shared key from 8 to 64 case-sensitive keyboard characters.
	Click the Eye icon to show or hide the password for your wireless network. When the Eye icon is slashed  , you'll see the password in plain text. Otherwise, it's hidden.
Random Password	Select this option to have the Zyxel Device automatically generate a password. The WiFi Password field will not be configurable when you select this option.
Hide WiFi network name	Select this check box to hide the SSID in the outgoing beacon frame so a station cannot obtain the SSID through scanning using a site survey tool. Note: Disable WPS in the Network Setting > Wireless > WPS screen to hide the SSID.
Save	Click Save to save your changes.

5.1.5 Guest WiFi Settings



Use this screen to enable or disable the guest wireless network. When the switch turns blue () , the function is enabled. Otherwise, it's not. You can use this screen or the QR code on the upper right corner to check the SSIDs (WiFi network name) and passwords of the guest wireless networks. If you want to show or hide your WiFi passwords, click the Eye icon ().

Figure 53 Guest WiFi Settings



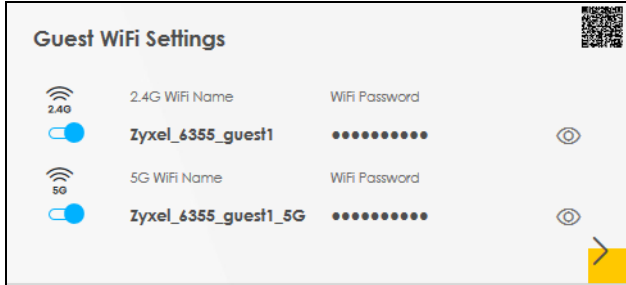
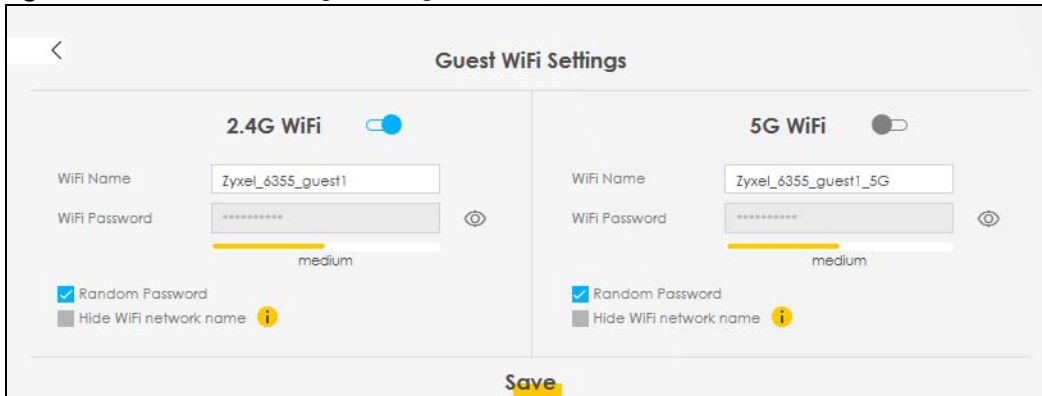

Click the Arrow icon (➔) to configure the SSIDs and/or passwords for the guest wireless networks. Click the Eye icon (👁) to display the characters as you enter the WiFi Password.

Figure 54 Guest WiFi Settings: Configuration



Each field is described in the following table.

Table 16 Guest WiFi Settings: Configuration

LABEL	DESCRIPTION
2.4G / 5G WiFi	Click this switch to enable or disable the 2.4 GHz / 5 GHz wireless network. When the switch turns blue  , the function is enabled. Otherwise, it's not.
WiFi Name	The SSID (Service Set IDentity) identifies the service set with which a wireless device is associated. Wireless devices associating to the access point (AP) must have the same SSID. Enter a descriptive name (up to 32 English keyboard characters) for the wireless LAN.
WiFi Password	If you selected Random Password , this field displays a pre-shared key generated by the Zyxel Device. If you did not select Random Password , you can manually type a pre-shared key from 8 to 64 case-sensitive keyboard characters.
	Click the Eye icon to show or hide the password for your wireless network. When the Eye icon is slashed  , you'll see the password in plain text. Otherwise, it's hidden.
Random Password	Select this option to have the Zyxel Device automatically generate a password. The WiFi Password field will not be configurable when you select this option.
Hide WiFi network name	Select this check box to hide the SSID in the outgoing beacon frame so a station cannot obtain the SSID through scanning using a site survey tool. Note: Disable WPS in the Network Setting > Wireless > WPS screen to hide the SSID.
Save	Click Save to save your changes.

5.1.6 LAN

Use this screen to view the LAN IP address, subnet mask, and DHCP settings of your Zyxel Device.

Figure 55 LAN

LAN

IP Address **192.168.1.1**

Subnet Mask **255.255.255.0**

IP Address Range **192.168.1.2 ~ 192.168.1.254**

DHCP

Lease Time **1 days 0 hours 0 mins**

Click the Arrow icon () to configure the LAN IP settings and DHCP setting for your Zyxel Device.

Figure 56 LAN Setup

LAN

LAN IP Setup

IP Address 192 . 168 . 1 . 1

Subnet Mask 255 . 255 . 255 . 0

IP Addressing Values

Beginning IP Address 192 . 168 . 1 . 2

Ending IP Address 192 . 168 . 1 . 254

DHCP Server State

DHCP Server Lease Time 1 days 0 hours 0 minutes

Save

Each field is described in the following table.

Table 17 Status Screen

LABEL	DESCRIPTION
LAN IP Setup	
IP Address	Enter the LAN IPv4 IP address you want to assign to your Zyxel Device in dotted decimal notation, for example, 192.168.1.1 (factory default).
Subnet Mask	Type the subnet mask of your network in dotted decimal notation, for example 255.255.255.0 (factory default). Your Zyxel Device automatically computes the subnet mask based on the IP Address you enter, so do not change this field unless you are instructed to do so.
IP Addressing Values	
Beginning IP Address	This field specifies the first of the contiguous addresses in the IP address pool.
Ending IP Address	This field specifies the last of the contiguous addresses in the IP address pool.
DHCP Server State	

Table 17 Status Screen (continued)

LABEL	DESCRIPTION
DHCP Server Lease Time	This is the period of time DHCP-assigned addresses is used. DHCP automatically assigns IP addresses to clients when they log in. DHCP centralizes IP address management on central computers that run the DHCP server program. DHCP leases addresses, for a period of time, which means that past addresses are "recycled" and made available for future reassignment to other systems.
Days/Hours/Minutes	Enter the lease time of the DHCP server.
Save	Click Save to save your changes.

CHAPTER 6

Broadband

6.1 Overview

This chapter discusses the Zyxel Device's **Broadband** screens. Use these screens to configure your Zyxel Device for Internet access.

A WAN (Wide Area Network) connection is an outside connection to another network or the Internet. It connects your private networks, such as a LAN (Local Area Network) and other networks, so that a computer in one location can communicate with computers in other locations.

Figure 57 LAN and WAN

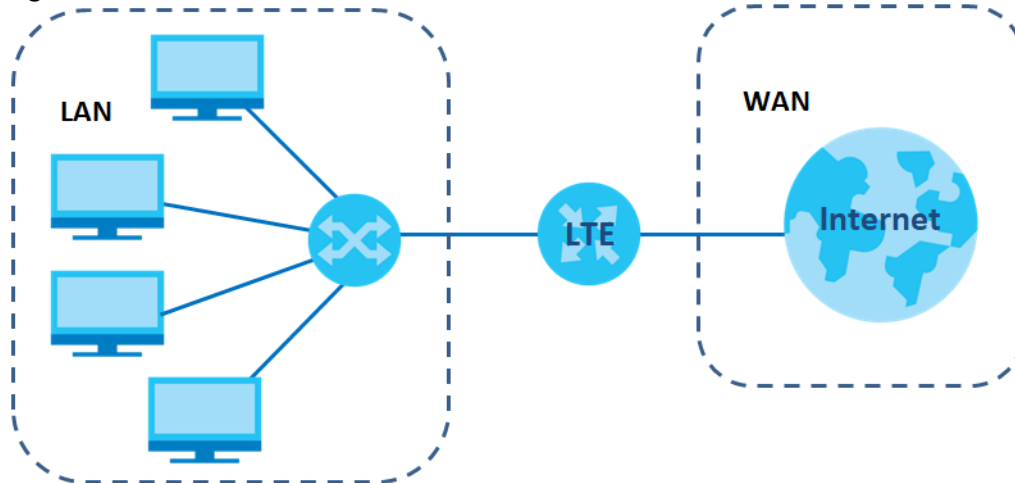

6.1.1 What You Can Do in this Chapter

- Use the **Broadband** screen to view a WAN interface. You can also configure the WAN settings on the Zyxel Device for Internet access ([Section 6.2 on page 84](#)).
- Use the **WAN Backup** screen to configure your Zyxel Device's WAN backup settings ([Section 6.3 on page 89](#)).
- Use the **Ethernet WAN** screen to convert LAN port number four as a WAN port or restore the Ethernet WAN port to a LAN port ([Section 6.4 on page 90](#)).
- Use the **Cellular WAN** screen to configure an LTE WAN connection ([Section 6.5 on page 91](#)).
- Use the **Cellular SIM** screen to enter the PIN of your SIM card ([Section 6.6 on page 92](#)).
- Use the **Cellular Band** screen to view or edit an LTE WAN interface. You can also configure the WAN settings on the Zyxel Device for Internet access ([Section 6.2 on page 84](#)).
- Use the **Cellular PLMN** screen to display available Public Land Mobile Networks ([Section 6.8 on page 94](#)).

- Use the **Cellular IP Passthrough** screen to configure an LTE WAN connection ([Section 6.9 on page 97](#)).

Table 18 WAN Setup Overview

LAYER-2 INTERFACE		INTERNET CONNECTION		
CONNECTION	DSL LINK TYPE	MODE	ENCAPSULATION	CONNECTION SETTINGS
Ethernet	N/A	Routing	IPoE	WAN IPv4/IPv6 IP address, NAT, DNS server and routing feature.

6.1.2 What You Need to Know

The following terms and concepts may help as you read this chapter.

WAN IP Address

The WAN IP address is an IP address for the Zyxel Device, which makes it accessible from an outside network. It is used by the Zyxel Device to communicate with other devices in other networks. The ISP dynamically assigns it each time the Zyxel Device tries to access the Internet.

APN

Access Point Name (APN) is a unique string which indicates an LTE network. An APN is required for LTE stations to enter the LTE network and then the Internet.

6.1.3 Before You Begin

You may need to know your Internet access settings such as LTE APN, WAN IP address and SIM card's PIN code if the **INTERNET** light on your Zyxel Device is off. Get this information from your service provider.

6.2 Broadband

Use this screen to change your Zyxel Device's Internet access settings. The summary table shows you the configured WAN services (connections) on the Zyxel Device. Use information provided by your ISP to configure WAN settings.

Click **Network Setting > Broadband** to access this screen.

Figure 58 Network Setting > Broadband

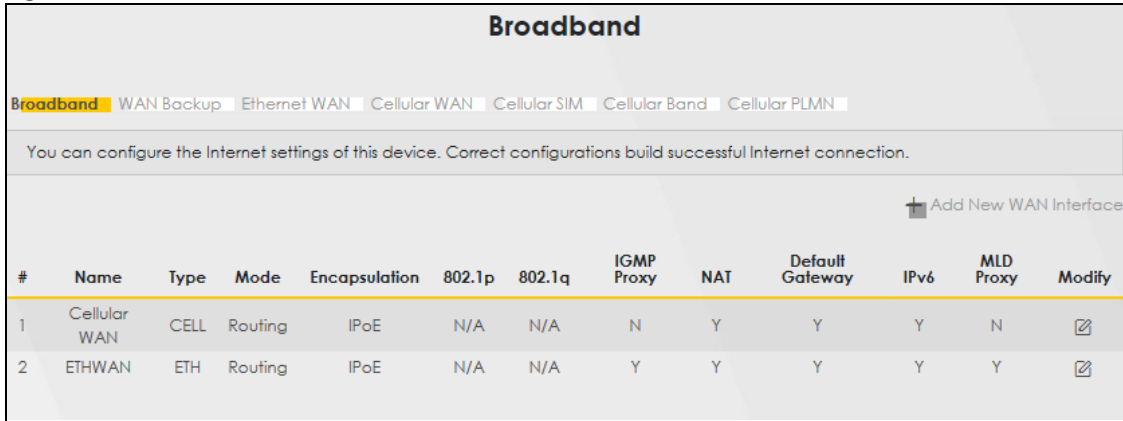

#	Name	Type	Mode	Encapsulation	802.1p	802.1q	IGMP Proxy	NAT	Default Gateway	IPv6	MLD Proxy	Modify
1	Cellular WAN	CELL	Routing	IPoE	N/A	N/A	N	Y	Y	Y	N	
2	ETHWAN	ETH	Routing	IPoE	N/A	N/A	Y	Y	Y	Y	Y	

The following table describes the labels in this screen.

Table 19 Network Setting > Broadband

LABEL	DESCRIPTION
#	This is the index number of the entry.
Name	This is the service name of the connection.
Type	This shows whether it is a cellular or Ethernet connection.
Mode	This shows the connection is in routing mode.
Encapsulation	This is the method of encapsulation used by this connection.
802.1p	This indicates the 802.1p priority level assigned to traffic sent through this connection. This displays N/A when there is no priority level assigned.
802.1q	This indicates the VLAN ID number assigned to traffic sent through this connection. This displays N/A when there is no VLAN ID number assigned.
IGMP Proxy	This shows whether the Zyxel Device act as an IGMP proxy on this connection.
NAT	This shows whether NAT is activated or not for this connection.
Default Gateway	This shows whether the Zyxel Device use the WAN interface of this connection as the system default gateway.
IPv6	This shows whether IPv6 is activated or not for this connection. IPv6 is not available when the connection uses the bridging service.
MLD Proxy	This shows whether Multicast Listener Discovery (MLD) is activated or not for this connection. MLD is not available when the connection uses the bridging service.
Modify	Click the Edit or Modify icon to configure the WAN connection. Click the Delete icon to remove the WAN connection.

6.2.1 Add/Edit Internet Connection

Click the **Edit** or **Modify** icon to open the following screen. Use this screen to configure a WAN connection.

Figure 59 Network Setting > Broadband > Add/Edit New WAN Interface

Edit WAN Interface

General

Name: Cellular WAN

Type: [Empty]

Mode: Routing

Encapsulation: IPoE

IPv4/IPv6 Mode: IPv4 IPv6 DualStack

VLAN

802.1p: 0

802.1q: [Empty] [1~4094]

MTU

MTU: 1500

IP Address

Obtain an IP Address Automatically

Static IP Address

DNS Server

Obtain DNS Info Automatically

Use Following Static DNS Address

Routing Feature

NAT: IGMP Proxy:

Apply as Default Gateway: Fullcone NAT:

DHCPC Options

Request Options

option 43 option 120 option 121

Sent Options

option 60

Vendor ID: [Empty]

option 61

IAID: [Empty]

DUID: [Empty]

option 125

IPv6 Address

Obtain an IPv6 Address Automatically

Static IPv6 Address

IPv6 DNS Server

Obtain IPv6 DNS Info Automatically

Use Following Static IPv6 DNS Address

IPv6 Routing Feature

MLD Proxy: Apply as Default Gateway:

Cancel Apply

The following table describes the labels in this screen.

Table 20 Network Setting > Broadband > Add/Edit New WAN Interface

LABEL	DESCRIPTION
General	Click this switch to enable or disable the interface. When the switch goes to the right <input checked="" type="checkbox"/> , the function is enabled. Otherwise, it is not.
Name	This is the service name of the connection.
Type	This shows the type of the connection the Zyxel Device is currently associated with.
Mode	This shows the connection is in Routing or Bridge mode. If the Zyxel Device is in routing mode, your ISP gives you one IP address only and you want multiple computers to share an Internet account.

Table 20 Network Setting > Broadband > Add/Edit New WAN Interface (continued)





LABEL	DESCRIPTION
Encapsulation	This is the method of encapsulation used by this connection.
IPv4/IPv6 Mode	This shows IPv4 IPv6 DualStack . IPv4 IPv6 DualStack allows the Zyxel Device to run IPv4 and IPv6 at the same time.
VLAN	Click this switch to enable or disable VLAN on this WAN interface. When the switch goes to the right  , the function is enabled. Otherwise, it is not.
802.1p	IEEE 802.1p defines up to 8 separate traffic types by inserting a tag into a MAC-layer frame that contains bits to define class of service. Select the IEEE 802.1p priority level (from 0 to 7) to add to traffic through this connection. The greater the number, the higher the priority level.
802.1q	Type the VLAN ID number (from 1 to 4094) for traffic through this connection.
MTU	
MTU	Enter the MTU (Maximum Transfer Unit) size for this traffic.
IP Address	
Obtain an IP Address Automatically	A static IP address is a fixed IP that your ISP gives you. A dynamic IP address is not fixed; the ISP assigns you a different one each time you connect to the Internet. Select this if you have a dynamic IP address.
Static IP Address	Select this option if the ISP assigned a fixed IP address.
IP Address	Enter the static IP address provided by your ISP.
Subnet Mask	Enter the subnet mask provided by your ISP.
Gateway IP Address	Enter the gateway IP address provided by your ISP.
DNS Server	
	Select Obtain DNS Info Automatically if you want the Zyxel Device to use the DNS server addresses assigned by your ISP. Select Use Following Static DNS Address if you want the Zyxel Device to use the DNS server addresses you configure manually.
Primary DNS Server	Enter the first DNS server address assigned by the ISP.
Secondary DNS Server	Enter the second DNS server address assigned by the ISP.
Routing Feature	
NAT	Click this switch to activate or deactivate NAT on this connection. When the switch goes to the right  , the function is enabled. Otherwise, it is not.
IGMP Proxy	Internet Group Multicast Protocol (IGMP) is a network-layer protocol used to establish membership in a Multicast group - it is not used to carry user data. Click this switch to have the Zyxel Device act as an IGMP proxy on this connection. When the switch goes to the right  , the function is enabled. Otherwise, it is not. This allows the Zyxel Device to get subscribing information and maintain a joined member list for each multicast group. It can reduce multicast traffic significantly.
Apply as Default Gateway	Click this switch to have the Zyxel Device use the WAN interface of this connection as the system default gateway. When the switch goes to the right  , the function is enabled. Otherwise, it is not.

Table 20 Network Setting > Broadband > Add/Edit New WAN Interface (continued)

LABEL	DESCRIPTION
Fullcone NAT	<p>Click this switch to enable or disable fullcone NAT on this connection. When the switch goes to the right , the function is enabled. Otherwise, it is not.</p> <p>This field is available only when you activate NAT.</p> <p>In fullcone NAT, the Zyxel Device maps all outgoing packets from an internal IP address and port to a single IP address and port on the external network. The Zyxel Device also maps packets coming to that external IP address and port to the internal IP address and port.</p>
DHCP Options	
Request Options	<p>Select Option 43 to have the Zyxel Device automatically add vendor specific information in the DHCP packets to request the vendor specific options from the DHCP server.</p> <p>Select Option 120 to have the Zyxel Device get the IP address or a fully-qualified domain name of SIP server from DHCP.</p> <p>Select Option 121 to have the Zyxel Device push static routes to clients.</p>
Sent Options	
option 60	Select this and enter the device identity you want the Zyxel Device to add in the DHCP discovery packets that go to the DHCP server.
Vendor ID	Enter the Vendor Class Identifier, such as the type of the hardware or firmware.
option 61	Select this and enter any string that identifies the device.
IAID	Enter the Identity Association Identifier (IAID) of the device, for example, the WAN connection index number.
DUID	Enter the hardware type, a time value and the MAC address of the device.
option 125	Select this to have the Zyxel Device automatically generate and add vendor specific parameters in the DHCP discovery packets that go to the DHCP server.
IPv6 Address	
Obtain an IPv6 Address Automatically	Select Obtain an IPv6 Address Automatically if you want to have the Zyxel Device use the IPv6 prefix from the connected router's Router Advertisement (RA) to generate an IPv6 address.
Static IPv6 Address	Select Static IPv6 Address if you have a fixed IPv6 address assigned by your ISP. When you select this, the following fields appear.
IPv6 Address	Enter an IPv6 IP address that your ISP gave to you for this WAN interface.
Prefix Length	Enter the address prefix length to specify how many most significant bits in an IPv6 address compose the network address.
IPv6 Default Gateway	Enter the IP address of the next-hop gateway. The gateway is a router or switch on the same segment as your Zyxel Device's interface(s). The gateway helps forward packets to their destinations.
IPv6 DNS Server	
Obtain IPv6 DNS Info Automatically	Select Obtain IPv6 DNS Info Automatically to have the Zyxel Device get the IPv6 DNS server addresses from the ISP automatically.
Use Following Static IPv6 DNS Address	Select Use Following Static IPv6 DNS Address to have the Zyxel Device use the IPv6 DNS server addresses you configure manually.
Primary DNS Server	Enter the first IPv6 DNS server address assigned by the ISP.
Secondary DNS Server	Enter the second IPv6 DNS server address assigned by the ISP.
IPv6 Routing Feature	

Table 20 Network Setting > Broadband > Add/Edit New WAN Interface (continued)

LABEL	DESCRIPTION
MLD Proxy Enable	Select this check box/option to have the Zyxel Device act as an MLD proxy on this connection. This allows the Zyxel Device to get subscription information and maintain a joined member list for each multicast group. It can reduce multicast traffic significantly.
Apply as Default Gateway	Select this option to have the Zyxel Device use the WAN interface of this connection as the system default gateway.
Cancel	Click Cancel to exit this screen without saving.
Apply	Click Apply to save your changes.

6.3 WAN Backup

Use this screen to configure your Zyxel Device's Internet settings if the wired connection is down. You can use an alternative network, and assign an IP address to verify the accessibility of the Internet and the time interval allowed between each connection check.

Click **Network Setting > Broadband > WAN Backup** to display the following screen.

Figure 60 Network Setting > Broadband > WAN Backup

The following table describes the fields in this screen.

Table 21 Network Setting > Broadband > WAN Backup

LABEL	DESCRIPTION
WAN Backup Enable	Select Enable to have the Zyxel Device use the cellular connection as your WAN or a backup when the wired WAN connection fails.
Primary WAN	This field displays the connection the Zyxel Device would use first when the wired WAN connection fails. You can choose Ethernet or Cellular as the primary WAN connection for your Zyxel Device.

Table 21 Network Setting > Broadband > WAN Backup (continued)

LABEL	DESCRIPTION
The Destination for Connection Check	Configure this field to test your Zyxel Device's WAN accessibility. Type the IP address of a reliable nearby computer (for example, your ISP's DNS server address). Note: If you activate either traffic redirect or dial backup, you must configure at least one IP address here. When using a WAN backup connection, the Zyxel Device periodically pings the addresses configured here and uses the other WAN backup connection (if configured) if there is no response.
Connection Check Interval	When the Zyxel Device is using a lower priority connection (usually a WAN backup connection), it periodically checks to whether or not it can use a higher priority connection. Type the number of seconds (30 recommended) for the Zyxel Device to wait between checks. Allow more time if your destination IP address handles lots of traffic.
Check Fail Limit	Type the number of times (2 recommended) that your Zyxel Device may ping the IP addresses configured in the WAN Backup Enable field without getting a response before switching to a WAN backup connection (or a different WAN backup connection).
Cancel	Click Cancel to exit this screen without saving.
Apply	Click Apply to save your changes.

6.4 Ethernet WAN

Use this screen to have a LAN port act as an Ethernet WAN port. You can restore it back from a WAN port to a LAN port. Click the switch to set up the configuration. When the switch goes to the right, the LAN port acts as an Ethernet WAN port. Otherwise, the LAN port remains as a LAN port. The Ethernet WAN connection has priority over the DSL connection. Click **Apply** to save your changes back to the Zyxel Device.

Click **Network Setting > Broadband > Ethernet WAN** to display the following screen.

Figure 61 Network Setting > Broadband > Ethernet WAN

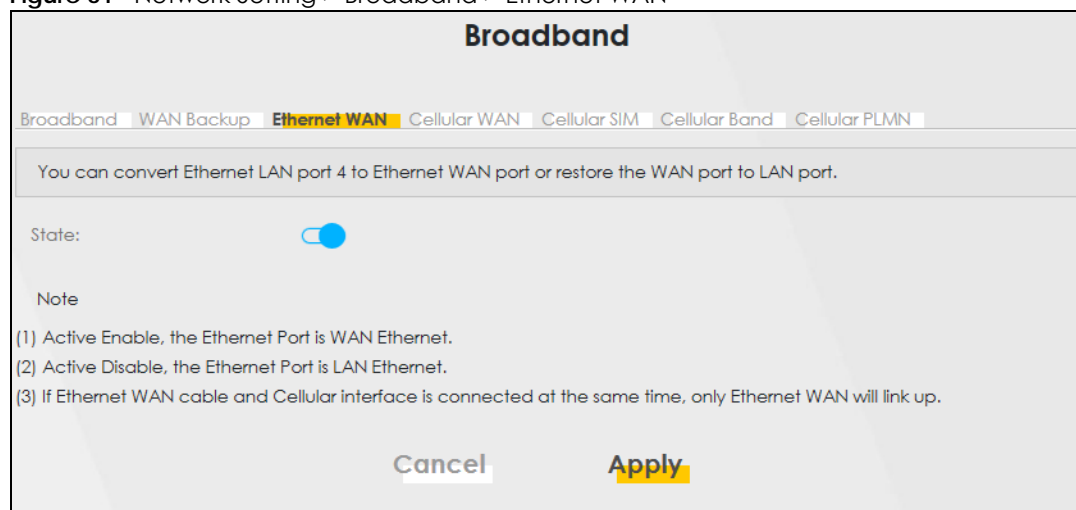

6.5 Cellular WAN

Click **Network Setting > Broadband > Cellular WAN** to display the following screen. Use this screen to enable data roaming and network monitoring when the Zyxel Device cannot ping a base station.

Note: APN information can be obtained from the service provider.
 Roaming charges may apply when **Data Roaming** is enabled.
Automatic APN Mode is not supported when operating in 3G only mode.

Figure 62 Network Setting > Broadband > Cellular WAN

Broadband | Ethernet WAN | **Cellular WAN** | Cellular SIM | Cellular Band | Cellular PLMN | Cellular IP Passthrough

Configure an LTE connection, including the Access Point Name (APN) provided by your service provider.

Antenna

Antenna Select: External

Note: LTE antenna select Automatic/External/Internal.

Roaming

Data Roaming:

Note: Roaming charges may apply when **Data Roaming** is enabled.

APN Settings

APN Manual Mode:

APN:

Username: (Optional)

Password: (Optional)

Authentication Type: PAP

PDP Type: IPv4/IPv6

Note: (1) APN information can be obtained from the service provider.
 (2) **Automatic APN Mode** is not supported when operating in 3G only mode.

Cancel Apply

The following table describes the fields in this screen.

Table 22 Network Setting > Broadband > Cellular WAN

LABEL	DESCRIPTION
Antenna	
Antenna Select	Select between External or Internal Antenna for your Zyxel Device.
Roaming	
Data Roaming	Click this to enable (<input checked="" type="checkbox"/>) data roaming on the Zyxel Device. 4G roaming is to use your mobile device in an area which is not covered by your service provider. Enable roaming to ensure that your Zyxel Device is kept connected to the Internet when you are traveling outside the geographical coverage area of the network to which you are registered.

Table 22 Network Setting > Broadband > Cellular WAN (continued)

LABEL	DESCRIPTION
APN Settings	
APN Manual Mode	Disable this to have the Zyxel Device configure the APN (Access Point Name) of an LTE network automatically. Otherwise, Click this to enable (<input type="radio"/>) and enter the APN manually in the field below.
APN	This field allows you to display the Access Point Name (APN) in the profile. Enter the Access Point Name (APN) provided by your service provider. Connections with different APNs may provide different services (such as Internet access or MMS (Multi-Media Messaging Service)) and charging method. You can enter up to 30 printable ASCII characters. Spaces are allowed.
Username	This field allows you to display the user name in the profile. Type the user name (up to 31 printable ASCII characters) given to you by your service provider.
Password	This field allows you to set the password in the profile. Type the password (up to 31 printable ASCII characters) associated with the user name above.
Authentication Type	Select the type of authentication method peers use to connect to the Zyxel Device in LTE connections. In Password Authentication Protocol (PAP) peers identify themselves with a user name and password. In Challenge Handshake Authentication Protocol (CHAP) additionally to user name and password the Zyxel Device sends regular challenges to make sure an intruder has not replaced a peer. Otherwise select PAP/CHAP or None .
PDP Type	Select IPv4 if you want the Zyxel Device to run IPv4 (Internet Protocol version 4 addressing system) only. Select IPv4/IPv6 if you want the Zyxel Device to run both IPv4 and IPv6 (Internet Protocol version 4 and 6 addressing system) at the same time.
Apply	Click this to save your changes.
Cancel	Click this to exit this screen without saving.

6.6 Cellular SIM Configuration

Enter a PIN for your SIM card to prevent others from using it.

Entering the wrong PIN code 3 consecutive times locks the SIM card after which you need a PUK (Personal Unlocking Key) from the service provider to unlock it.

Click **Network Setting > Broadband > Cellular SIM**. The following screen opens.

Figure 63 Network Setting > Broadband > Cellular SIM

Enter a PIN for your SIM card to prevent others from using it.

PIN Management

PIN Protection

PIN

Attempts remaining: 2

Note

(1) The PIN is automatically saved in the Zyxel Device.
 (2) Entering the wrong PIN exceeding a set number of times will lock the SIM card.

Cancel **Apply**

Note: The PIN is automatically saved in the Zyxel Device.
 Entering the wrong PIN exceeding a set number of times will lock the SIM card.

The following table describes the fields in this screen.

Table 23 Network Setting > Broadband > Cellular SIM

LABEL	DESCRIPTION
PIN Management	
PIN Protection	A PIN (Personal Identification Number) code is a key to a SIM card. Without the PIN code, you cannot use the SIM card. Click to enable () if the service provider requires you to enter a PIN to use the SIM card. Click to disable if the service provider lets you use the SIM without inputting a PIN.
PIN	If you enabled PIN verification, enter the 4-digit PIN code (0000 for example) provided by your ISP. If you enter the PIN code incorrectly too many times, the ISP may block your SIM card and not let you use the account to access the Internet.
Attempts Remaining	This is how many more times you can try to enter the PIN code before the ISP blocks your SIM card.
Apply	Click Apply to save your changes.
Cancel	Click Cancel to return to the previous screen without saving.

6.7 Cellular Band Configuration

Either select **Auto** to have the Zyxel Device connect to an available network using the default settings on the SIM card or select the type of the network (**4G**, **3G**, or **2G**) to which you want the Zyxel Device to connect.

Click **Network Setting > Broadband > Cellular Band**. The following screen opens.

Figure 64 Network Setting > Broadband > Cellular Band

The following table describes the fields in this screen.

Table 24 Network Setting > Broadband > Cellular Band

LABEL	DESCRIPTION
Access Technology	
Preferred Access Technology	Select the type of the network (4G , 3G , or 2G) to which you want the Zyxel Device to connect and click Apply to save your settings. Otherwise, select Auto to have the Zyxel Device connect to an available network using the default settings on the SIM card. If the currently registered mobile network is not available or the mobile network's signal strength is too low, the Zyxel Device switches to another available mobile network.
Band Management	
Band Auto Selection	Select the LTE bands to use for the Zyxel Device's WAN connection. Click to enable () automatic LTE frequency band selection as provided by your service provider. Otherwise, select disabled.
Apply	Click this to save your changes.
Cancel	Click this to exit this screen without saving.

6.8 Cellular PLMN Configuration

Each service provider has its own unique Public Land Mobile Network (PLMN) number. Either select **PLMN Auto Selection** to have the Zyxel Device connect to the service provider using the default settings on the SIM card or manually view available PLMNs and select your service provider.

Click **Network Setting > Broadband > Cellular PLMN**. The screen appears as shown next.

Figure 65 Network Setting > Broadband > Cellular PLMN

The following table describes the labels in this screen.

Table 25 Network Setting > Broadband > Cellular PLMN

LABEL	DESCRIPTION
PLMN Management	
PLMN Auto Selection	Click to enable (<input checked="" type="checkbox"/>) and have the Zyxel Device automatically connect to the first available mobile network. Select disabled to display the network list and manually select a preferred network.
Apply	Click Apply to save your changes back to the Zyxel Device.
Cancel	Click Cancel to exit this screen without saving.

After selecting to disable the following warning appears. Click **OK** to continue.

Figure 66 Network Setting > Broadband > Cellular PLMN > Manual Scan Warning

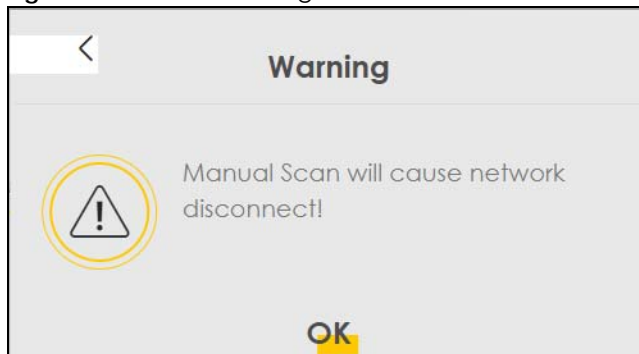

Click **Scan** to check for available PLMNs in the area surrounding the Zyxel Device, and then display them in the network list. Select from the network list and click **Apply**.

Figure 67 Network Setting > Broadband > Cellular PLMN > Manual Scan

Cellular PLMN Configuration

PLMN Management

PLMN Auto Selection

Scan

#	Status	Name	Type	PLMN
<input type="radio"/>	Available	FET	LTE	46601
<input type="radio"/>	Current	FET	UMTS	46601
<input type="radio"/>	Forbidden	TWM	UMTS	46697
<input type="radio"/>	Available	Chunghwa	UMTS	46692
<input type="radio"/>	Available	Chunghwa	LTE	46692
<input type="radio"/>	Forbidden	T Star	LTE	46689
<input type="radio"/>	Forbidden	TWM	LTE	46697
<input type="radio"/>	Forbidden	466 05	GPRS	46605
<input type="radio"/>	Forbidden	466 05	LTE	46605
<input type="radio"/>	Forbidden	T Star	UMTS	46689

Cancel
Apply

The following table describes the labels in this screen.

Table 26 Network Setting > Broadband > Cellular PLMN > Manual Scan

LABEL	DESCRIPTION
#	Click the radio button so the Zyxel Device connects to this ISP.
Status	This shows Current to show the ISP the Zyxel Device is currently connected to. This shows Forbidden to indicate the Zyxel Device cannot connect to this ISP. This shows Available to indicate an available ISP your Zyxel Device can connect to.
Name	This shows the ISP name.
Type	This shows the type of network the ISP provides.
PLMN	This shows the PLMN number.
Apply	Click Apply to save your changes back to the Zyxel Device.
Cancel	Click Cancel to exit this screen without saving.

6.9 IP Passthrough

Enable **IP Passthrough** to allow Internet traffic to go to a LAN computer behind the Zyxel Device without going through NAT.

Click **Network Setting > Broadband > IP Passthrough** to display the following screen.

Note: This screen is not available when the fourth LAN port acts as an Ethernet WAN port. See [Table 1 on page 16](#) for the feature differences of the Zyxel Devices.

Figure 68 Network Setting > Broadband > IP Passthrough

Enable **IP Passthrough** to allow internet traffic to go to a LAN computer behind the Zyxel Device without going through NAT.

IP Passthrough Management

IP Passthrough

Passthrough Mode Fixed

Passthrough to fixed MAC

Note
Changing the **IP Passthrough** settings may affect the network setting of client devices.

Cancel Apply

Note: Changing the **IP Passthrough** settings may affect the network setting of client devices. After selecting to enable the following warning appears. Click **OK** to continue.

Figure 69 Network Setting > Broadband > Cellular IP Passthrough > Enable Warning

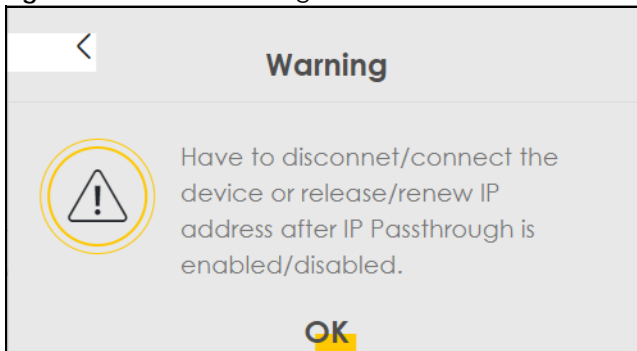

The following table describes the fields in this screen.

Table 27 Network Setting > Broadband > IP Passthrough

LABEL	DESCRIPTION
IP Passthrough Management	
IP Passthrough	IP Passthrough allows a LAN computer on the local network of the Zyxel Device to have access to web services using the public IP address. When IP Passthrough is configured, all traffic is forwarded to the LAN computer and will not go through NAT.

Table 27 Network Setting > Broadband > IP Passthrough (continued)

LABEL	DESCRIPTION
Passthrough Mode	Select Dynamic to allow traffic to be forwarded to any LAN computer on the local network of the Zyxel Device. Select Fixed to allow traffic to be forwarded to a specific LAN computer on the local network of the Zyxel Device. Note: This field will show upon enabling IP Passthrough in the previous field.
Passthrough to fixed MAC	Enter the MAC address of a LAN computer on the local network of the Zyxel Device upon selecting Fixed in the previous field. Note: This field will show upon selecting Fixed in the previous field.
Apply	Click this to save your changes.
Cancel	Click this to exit this screen without saving.

CHAPTER 7

Wireless

7.1 Overview

This chapter describes the Zyxel Device's **Network Setting > Wireless** screens. Use these screens to set up your Zyxel Device's WiFi network and security settings.

7.1.1 What You Can Do in this Chapter

This section describes the Zyxel Device's **Wireless** screens. Use these screens to set up your Zyxel Device's WiFi connection.

- Use the **General** screen to enable the Wireless LAN, enter the SSID and select the WiFi security mode ([Section 7.2 on page 100](#))
- Use the **Guest/More AP** screen to set up multiple wireless networks on your Zyxel Device ([Section 7.3 on page 104](#)).
- Use the **MAC Authentication** screen to allow or deny wireless clients based on their MAC addresses from connecting to the Zyxel Device ([Section 7.5 on page 108](#)).
- Use the **WPS** screen to enable or disable WPS, view or generate a security PIN (Personal Identification Number) ([Section 7.6 on page 110](#)).
- Use the **WMM** screen to enable WiFi MultiMedia (WMM) to ensure quality of service in WiFi networks for multimedia applications ([Section 7.7 on page 112](#)).
- Use the **Others** screen to configure WiFi advanced features, such as the RTS/CTS Threshold ([Section 7.8 on page 113](#)).
- Use the **WLAN Scheduler** screen to create rules to schedule the times to permit Internet traffic from each wireless network interfaces ([Section 7.9 on page 115](#)).
- Use the **Channel Status** screen to scan the number of accessing points and view the results ([Section 7.10 on page 117](#)).

7.1.2 What You Need to Know

Wireless Basics

"Wireless" is essentially radio communication. In the same way that walkie-talkie radios send and receive information over the airwaves, wireless networking devices exchange information with one another. A wireless networking device is just like a radio that lets your computer exchange information with radios attached to other computers. Like walkie-talkies, most wireless networking devices operate at radio frequency bands that are open to the public and do not require a license to use. However, wireless networking is different from that of most traditional radio communications in that there are a number of wireless networking standards available with different methods of data encryption.

Finding Out More

See [Section 7.11 on page 118](#) for advanced technical information on WiFi networks.

7.2 General Settings

Use this screen to enable the Wireless LAN, enter the SSID and select the wireless security mode. We recommend that you select **More Secure** to enable **WPA2-PSK** data encryption.

Note: If you are configuring the Zyxel Device from a computer connected by WiFi and you change the Zyxel Device's SSID, channel or security settings, you will lose your wireless connection when you press **Apply**. You must change the wireless settings of your computer to match the new settings on the Zyxel Device.

Click **Network Setting > Wireless** to open the **General** screen.

Figure 70 Network Setting > Wireless > General

General Guest/More AP MAC Authentication WPS WMM Others Channel Status

A Wireless network name (also known as SSID) and a security level are basic elements to start a wireless service. It is recommended to set a security level other than no security to protect your data from unauthorized access or damage via wireless network.

Wireless Network Setup

Band: 2.4GHz
 Wireless:
 Channel: Auto (Current: 1)
 Bandwidth: 20MHz
 Control Sideband: None

Wireless Network Settings

Wireless Network Name: Zyxel_B853
 Max Clients: 32
 Hide SSID ⓘ
 Multicast Forwarding
 Max. Upstream Bandwidth: _____ Kbps
 Max. Downstream Bandwidth: _____ Kbps

Note

(1) Max. Upstream Bandwidth: This field allows you to configure the maximum bandwidth of this SSID to WAN.
 (2) Max. Downstream Bandwidth: This field allows you to configure the maximum bandwidth of WAN to this SSID.
 (3) If Max. Upstream/Downstream Bandwidth is empty, the device sets the value automatically.
 (4) Using Max. Upstream/Downstream Bandwidth will significantly decrease the wireless performance.

BSSID: 98:0D:67:5D:B8:53

Security Level

No Security More Secure (Recommended)

Security Mode: WPA2-PSK
 Generate password automatically
 Enter 8-63 ASCII characters or 64 hexadecimal digits ("0-9", "A-F").
 Password: [masked] ⓘ
 Strength: strong

Cancel Apply

The following table describes the general wireless LAN labels in this screen.

Table 28 Network Setting > Wireless > General

LABEL	DESCRIPTION
WiFi Network Setup	
Band	This shows the WiFi band which this radio profile is using. 2.4GHz is the frequency used by IEEE 802.11b/g/n WiFi clients while 5GHz is used by IEEE 802.11a/ac WiFi clients.
WiFi	Click Enable to enable the wireless LAN in this field.
Channel	Use Auto to have the Zyxel Device automatically determine a channel to use.

Table 28 Network Setting > Wireless > General (continued)

LABEL	DESCRIPTION
Bandwidth	Select whether the Zyxel Device uses a WiFi channel width of 20MHz , 40MHz or 20/40MHz . A standard 20MHz channel offers transfer speeds of up to 150Mbps whereas a 40MHz channel uses two standard channels and offers speeds of up to 300Mbps. 40MHz (channel bonding or dual channel) bonds two adjacent radio channels to increase throughput. The WiFi clients must also support 40MHz. It is often better to use the 20MHz setting in a location where the environment hinders the WiFi signal. Select 20MHz if you want to lessen radio interference with other WiFi devices in your neighborhood or the WiFi clients do not support channel bonding.
Control Sideband	This is available for some regions when you select a specific channel and set the Bandwidth field to 40MHz . Set whether the control channel (set in the Channel field) should be in the Lower or Upper range of channel bands.
WiFi Network Settings	
WiFi Network Name	The SSID (Service Set IDentity) identifies the service set with which a WiFi device is associated. WiFi devices associating to the access point (AP) must have the same SSID. Enter a descriptive name (up to 32 English keyboard characters) for the wireless LAN.
Max Clients	Specify the maximum number of clients that can connect to this network at the same time.
Hide SSID	Select this check box to hide the SSID in the outgoing beacon frame so a station cannot obtain the SSID through scanning using a site survey tool. This check box is grayed out if the WPS function is enabled in the Network > Wireless > WPS screen.
Multicast Forwarding	Select this check box to allow the Zyxel Device to convert wireless multicast traffic into wireless unicast traffic.
Max. Upstream Bandwidth	Specify the maximum rate for upstream wireless traffic to the WAN from this WLAN in kilobits per second (Kbps).
Max. Downstream Bandwidth	Specify the maximum rate for downstream wireless traffic to this WLAN from the WAN in kilobits per second (Kbps).
BSSID	This shows the MAC address of the wireless interface on the Zyxel Device when wireless LAN is enabled.
Security Level	
Security Mode	Select More Secure (WPA2-PSK) to add security on this WiFi network. The WiFi clients which want to associate to this network must have the same WiFi security settings as the Zyxel Device. When you select to use a security, additional options appears in this screen. Or you can select No Security to allow any client to associate with this network without any data encryption or authentication. See the following sections for more details about this field.
Cancel	Click Cancel to restore your previously saved settings.
Apply	Click Apply to save your changes.

7.2.1 No Security

Select **No Security** to allow wireless stations to communicate with the access points without any data encryption or authentication.

Note: If you do not enable any WiFi security on your Zyxel Device, your network is accessible to any wireless networking device that is within range.

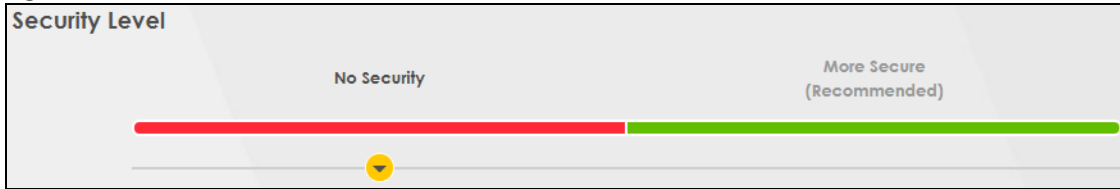
Figure 71 Wireless > General: No Security

The following table describes the labels in this screen.

Table 29 Wireless > General: No Security

LABEL	DESCRIPTION
Security Level	Choose No Security to allow all WiFi connections without data encryption or authentication.

7.2.2 More Secure (WPA2-PSK)

The WPA2-PSK security mode is a newer, more robust version of the WPA encryption standard. It offers slightly better security, although the use of PSK makes it less robust than it could be. Using a Pre-Shared Key (PSK), both the Zyxel Device and the connecting client share a common password in order to validate the connection.

Click **Network Setting > Wireless** to display the **General** screen. Select **More Secure** as the security level. **WPA2-PSK** is the default **Security Mode**.

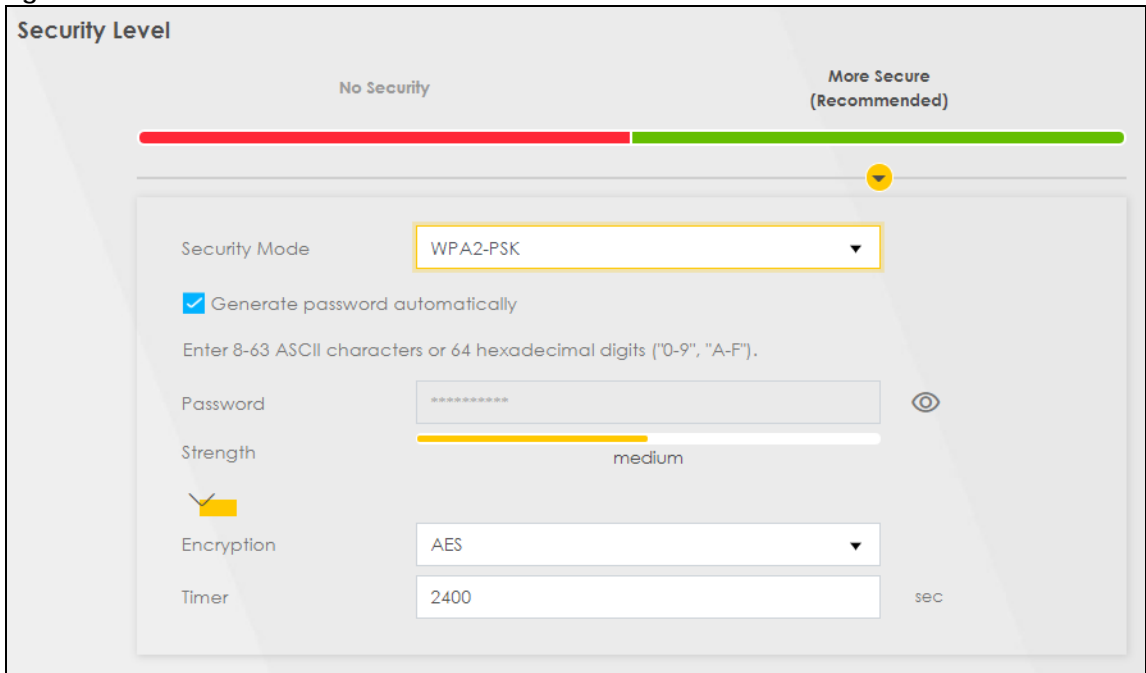

Figure 72 Wireless > General: More Secure: WPA2-PSK

The following table describes the labels in this screen.

Table 30 Wireless > General: More Secure: WPA2-PSK

LABEL	DESCRIPTION
Security Level	Select More Secure to enable WPA2-PSK data encryption.
Security Mode	WPA2-PSK is the default security mode.

Table 30 Wireless > General: More Secure: WPA2-PSK (continued)

LABEL	DESCRIPTION
Generate password automatically	Select this option to have the Zyxel Device automatically generate a password. The password field will not be configurable when you select this option.
Password	<p>Select Generate password automatically or enter a Password.</p> <p>The password has two uses.</p> <ol style="list-style-type: none"> 1. Manual. Manually enter the same password on the Zyxel Device and the client. Enter 8-63 ASCII characters or exactly 64 hexadecimal ('0-9', 'a-f') characters. 2. WPS. When using WPS, the Zyxel Device sends this password to the client. <p>Note: Enter 8-63 ASCII characters only. 64 hexadecimal characters are not accepted for WPS.</p> <p>Click the Eye icon to show or hide the password for your wireless network. When the Eye icon is slashed , you'll see the password in plain text. Otherwise, it's hidden.</p>
more...	Click this  to show more fields in this section. Click this  to hide them.
Encryption	AES is the default data encryption type, which uses a 128-bit key.
Timer	This is the rate at which the RADIUS server sends a new group key out to all clients.

7.3 Guest/More AP

Use this screen to configure a guest wireless network that allows access to the Internet through the Zyxel Device. Click **Network Setting > Wireless > Guest/More AP**. The screen appears as shown. This allows you to use one access point to provide several BSSs simultaneously. You can then assign varying security types to different SSIDs. Wireless clients can use different SSIDs to associate with the same access point.

Figure 73 Network Setting > Wireless > Guest/More AP

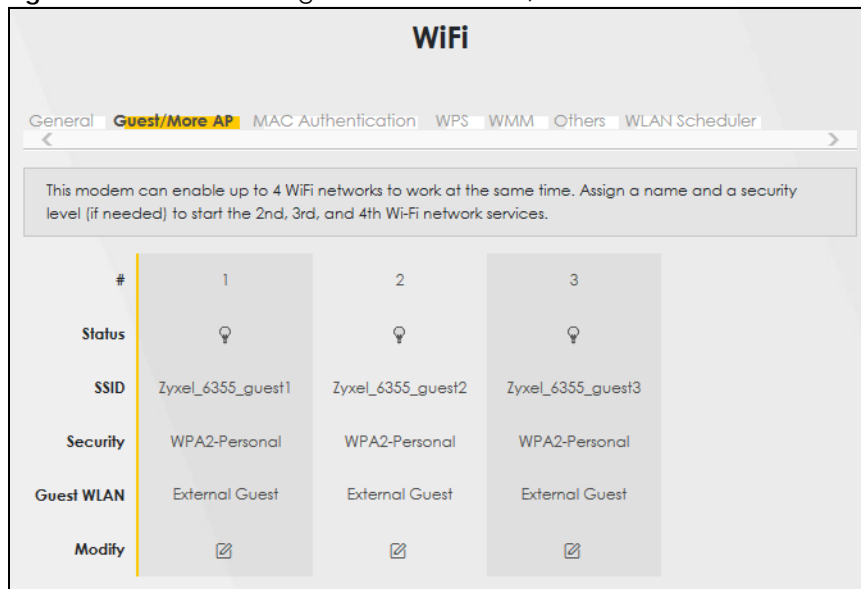

The following table describes the labels in this screen.

Table 31 Guest/More APNetwork Setting > Wireless >

LABEL	DESCRIPTION
#	This is the index number of each SSID profile.
Status	This shows whether the SSID profile is active (a yellow bulb) or not (a gray bulb).
SSID	An SSID profile is the set of parameters relating to one of the Zyxel Device's BSSs. The SSID (Service Set IDentifier) identifies the Service Set with which a wireless device is associated. You can configure up to four SSIDs to enable multiple BSSs (Basic Service Sets) on the Zyxel Device. This field displays the name of the wireless profile on the network. When a wireless client scans for an AP to associate with, this is the name that is broadcast and seen in the wireless client utility.
Security	This field indicates the security mode of the SSID profile.
Guest WLAN	This field shows whether the SSID profile is an external or home guest.
Modify	Click Modify to change the SSID profile.

7.4 More AP Edit

Use this screen to create a guest wireless network and configure its security settings. Click the **Modify** icon in the **More AP** screen. The following screen displays. Click **Network Setting > Wireless > More AP Edit**.

Figure 74 Network Setting > Wireless > More AP Edit

More AP Edit

Wireless security can protect the data from unauthorized access or damage via wireless network. You need a wireless network name (also known as SSID) and security mode to set up the wireless security.

Wireless Network Setup

Wireless

Security Level

Wireless Network Name

Hide SSID

Guest WLAN

Access Scenario

Max. Upstream Bandwidth Kbps

Max. Downstream Bandwidth Kbps

Note

(1) Max. Upstream Bandwidth: This field allows you to configure the maximum bandwidth of this SSID to WAN.
 (2) Max. Downstream Bandwidth: This field allows you to configure the maximum bandwidth of WAN to this SSID.
 (3) If Max. Upstream/Downstream Bandwidth is empty, the device sets the value automatically
 (4) Using Max. Upstream/Downstream Bandwidth will significantly decrease the wireless performance.

BSSID

SSID Subnet

DHCP Start Address

DHCP End Address

SSID Subnet Mask

LAN IP Address

Security Level

No Security More Secure (Recommended)

Security Mode

Generate password automatically
 Enter 8-63 ASCII characters or 64 hexadecimal digits ("0-9", "A-F").

Password

Strength

Encryption

Timer sec

Cancel

The following table describes the labels in this screen.



Table 32 Network Setting > Wireless > More AP Edit

LABEL	DESCRIPTION
WiFi Network Setup	
WiFi	Click Enable to enable the wireless LAN in this field.
Security Level	

Table 32 Network Setting > Wireless > More AP Edit (continued)

LABEL	DESCRIPTION
WiFi Network Name	<p>The SSID (Service Set IDentity) identifies the service set with which a WiFi device is associated. WiFi devices associating to the access point (AP) must have the same SSID.</p> <p>Enter a descriptive name (up to 32 English keyboard characters) for the wireless LAN.</p>
Hide SSID	<p>Select this check box to hide the SSID in the outgoing beacon frame so a station cannot obtain the SSID through scanning using a site survey tool.</p> <p>This check box is grayed out if the WPS function is enabled in the Network > Wireless > WPS screen.</p>
Guest WLAN	Select the check box to enable Guest WLAN.
Access Scenario	<p>If you select Home Guest, clients connecting to the same SSID can communicate with each other directly.</p> <p>If you select External Guest, clients are blocked from connecting to each other directly.</p>
Max. Upstream Bandwidth	Specify the maximum rate for upstream wireless traffic to the WAN from this WLAN in kilobits per second (Kbps).
Max. downstream Bandwidth	Specify the maximum rate for downstream wireless traffic to this WLAN from the WAN in kilobits per second (Kbps).
BSSID	This shows the MAC address of the wireless interface on the Zyxel Device when wireless LAN is enabled.
BSSID Subnet	Select Enable to create an independent subnet for the SSID, which is separated from the LAN subnet(s).
DHCP Start Address	Enter the first of the contiguous addresses in the IP address pool for the SSID subnet. The Zyxel Device assigns IP addresses from this DHCP pool to wireless clients connecting to the SSID.
DHCP End Address	Enter the last of the contiguous addresses in the IP address pool for the SSID subnet.
SSID Subnet Mask	Enter the subnet mask of the Zyxel Device for the SSID subnet.
LAN IP Address	Enter the IP address of the Zyxel Device for the Guest SSID.
Security Level	
Security Mode	<p>Select More Secure or WPA2-PSK to add security on this WiFi network. The WiFi clients which want to associate to this network must have the same WiFi security settings as the Zyxel Device. When you select to use a security, additional options appears in this screen.</p> <p>Or you can select No Security to allow any client to associate with this network without any data encryption or authentication.</p> <p>See the following sections for more details about this field.</p>
Generate password automatically	Select this option to have the Zyxel Device automatically generate a password. The password field will not be configurable when you select this option.

Table 32 Network Setting > Wireless > More AP Edit (continued)

LABEL	DESCRIPTION
Password	<p>Select Generate password automatically or enter a Password.</p> <p>The password has two uses.</p> <ol style="list-style-type: none"> 1. Manual. Manually enter the same password on the Zyxel Device and the client. Enter 8-63 ASCII characters or exactly 64 hexadecimal ('0-9', 'a-f') characters. 2. WPS. When using WPS, the Zyxel Device sends this password to the client. <p>Note: Enter 8-63 ASCII characters only. 64 hexadecimal characters are not accepted for WPS.</p> <p>Click the Eye icon to show or hide the password for your wireless network. When the Eye icon is slashed , you'll see the password in plain text. Otherwise, it's hidden.</p>
more...	Click this  to show more fields in this section. Click this  to hide them.
Encryption	AES is the default data encryption type, which uses a 128-bit key.
Timer	This is the rate at which the RADIUS server sends a new group key out to all clients.
Cancel	Click Cancel to restore your previously saved settings.
Apply	Click Apply to save your changes.

7.5 MAC Authentication

Use this screen to give exclusive access to specific devices (**Allow**) or exclude specific devices from accessing the Zyxel Device (**Deny**), based on the MAC address of each device. Every Ethernet device has a unique factory-assigned MAC (Media Access Control) address, which consists of six pairs of hexadecimal characters, for example: 00:A0:C5:00:00:02. You need to know the MAC addresses of the device you want to allow/deny to configure this screen.

Use this screen to view your Zyxel Device's MAC filter settings and add new MAC filter rules. Click **Network Setting > Wireless > MAC Authentication**. The screen appears as shown.

Figure 75 Network Setting> Wireless > MAC Authentication

Configure the Zyxel Device to give exclusive access to specific devices (**Allow**) or exclude specific devices from accessing the Zyxel Device (**Deny**) based on the device(s) MAC address. Every Ethernet device has a unique MAC (Media Access Control) address. It is assigned at the factory and consists of six pairs of hexadecimal characters; for example, 00:A0:C5:00:00:02. You need to know the MAC addresses of the device(s) you want to allow/deny to configure this screen. Edit the list in the table to decide the rule of access on device(s).

General

SSID Zyxel_B904 ▼

MAC Restrict Mode Disable Deny Allow

MAC address List + Add new MAC address

#	MAC Address	Modify

Note
A maximum of 25 MAC Authentication rules can be configured.

Cancel Apply

The following table describes the labels in this screen.

Table 33 Network Setting> Wireless > MAC Authentication

LABEL	DESCRIPTION
General	
SSID	Select the SSID for which you want to configure MAC filter settings.
MAC Restrict Mode	Define the filter action for the list of MAC addresses in the MAC Address table. Select Disable to turn off MAC filtering. Select Deny to block access to the Zyxel Device. MAC addresses not listed will be allowed to access the Zyxel Device. Select Allow to permit access to the Zyxel Device. MAC addresses not listed will be denied access to the Zyxel Device.
MAC address List	

Table 33 Network Setting> Wireless > MAC Authentication (continued)

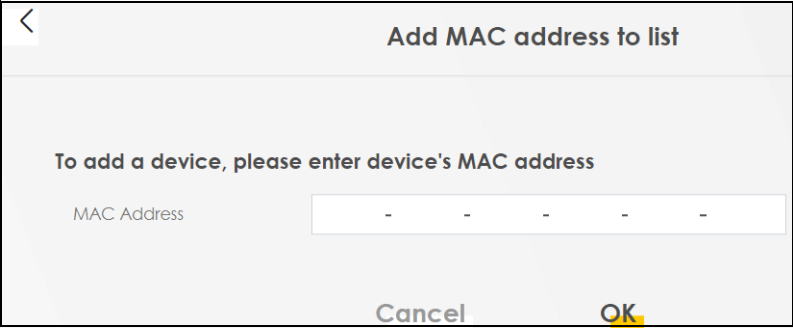
LABEL	DESCRIPTION
Add new MAC address	<p>This field is available when you select Deny or Allow in the MAC Restrict Mode field.</p> <p>Click this if you want to add a new MAC address entry to the MAC filter list below.</p> <p>Enter the MAC addresses of the WiFi devices that are allowed or denied access to the Zyxel Device in these address fields. Enter the MAC addresses in a valid MAC address format, that is, six hexadecimal character pairs, for example, 12:34:56:78:9a:bc.</p> <p>Figure 76 Add New MAC Address</p> 
#	This is the index number of the entry.
MAC Address	This is the MAC addresses of the WiFi devices that are allowed or denied access to the Zyxel Device.
Modify	<p>Click the Edit icon and type the MAC address of the peer device in a valid MAC address format (six hexadecimal character pairs, for example 12:34:56:78:9a:bc).</p> <p>Click the Delete icon to delete the entry.</p>
Cancel	Click Cancel to exit this screen without saving.
Apply	Click Apply to save your changes.

7.6 WPS

Use this screen to configure WiFi Protected Setup (WPS) on your Zyxel Device.

WiFi Protected Setup (WPS) allows you to quickly set up a wireless network with strong security, without having to configure security settings manually. Select one of the WPS methods and follow the instructions to establish a WPS connection. Your devices must support WPS to use this feature. We recommend using Push Button Configuration (**PBC**) if your device supports it. See [Section 7.11.7.3 on page 126](#) for more information about WPS.

Note: The Zyxel Device applies the security settings of the main SSID (**SSID1**) profile to the WPS wireless connection (see [Section 7.2.2 on page 103](#)).

Note: The WPS switch is unavailable if the wireless LAN is disabled.
If WPS is enabled, UPnP will automatically be turned on.

Click **Network Setting > Wireless > WPS**. The following screen displays. Click this switch and it will turn blue. Click **Apply** to activate the WPS function. Then you can configure the WPS settings in this screen.

Figure 77 Network Setting > Wireless > WPS

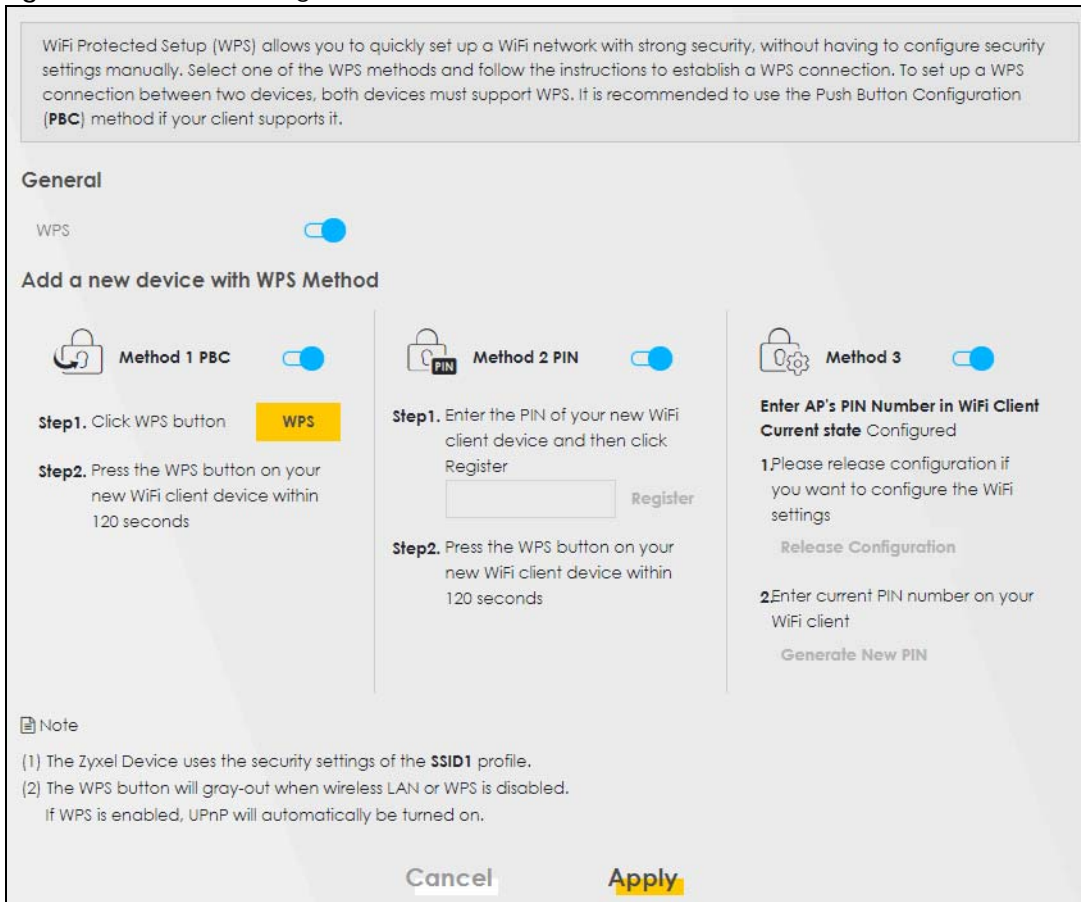

The following table describes the labels in this screen.

Table 34 Network Setting > Wireless > WPS

LABEL	DESCRIPTION
General	
WPS	Click to enable (<input checked="" type="checkbox"/>) and have the Zyxel Device activate WPS. Otherwise, it is disabled.
Add a new device with WPS Method	
Method 1 PBC	Use this section to set up a WPS WiFi network using Push Button Configuration (PBC). Click this switch to make it turn blue. Click Apply to activate WPS method 1 on the Zyxel Device.
WPS	Click this button to add another WPS-enabled WiFi device (within WiFi range of the Zyxel Device) to your WiFi network. This button may either be a physical button on the outside of a device, or a menu button similar to the WPS button on this screen. Note: You must press the other WiFi device's WPS button within two minutes of pressing this button.
Method 2 PIN	Use this section to set up a WPS WiFi network by entering the PIN of the client into the Zyxel Device. Click this switch to make it turn blue. Click Apply to activate WPS method 2 on the Zyxel Device.

Table 34 Network Setting > Wireless > WPS (continued)

LABEL	DESCRIPTION
Register	Enter the PIN of the device that you are setting up a WPS connection with and click Register to authenticate and add the WiFi device to your WiFi network. You can find the PIN either on the outside of the device, or by checking the device's settings. Note: You must also activate WPS on that device within two minutes to have it present its PIN to the Zyxel Device.
Method 3	Use this section to set up a WPS WiFi network by entering the PIN of the Zyxel Device into the client. Click this switch to make it turn blue. Click Apply to activate WPS method 3 on the Zyxel Device.
Release Configuration	The default WPS status is configured. Click this button to remove all configured WiFi and WiFi security settings for WPS connections on the Zyxel Device.
Generate New PIN	If this method has been enabled, the PIN (Personal Identification Number) of the Zyxel Device is shown here. Enter this PIN in the configuration utility of the device you want to connect to using WPS. The PIN is not necessary when you use the WPS push-button method. Click the Generate New PIN button to have the Zyxel Device create a new PIN.
Cancel	Click Cancel to restore your previously saved settings.
Apply	Click Apply to save your changes.

7.7 WMM

Use this screen to enable WiFi MultiMedia (**WMM**) and **WMM Automatic Power Save (APSD)** in wireless networks for multimedia applications. **WMM** enhances data transmission quality, while **APSD** improves power management of wireless clients. This allows delay-sensitive applications, such as voice and videos, to run more smoothly.

Click **Network Setting > Wireless > WMM** to display the following screen.

Figure 78 Network Setting > Wireless > WMM

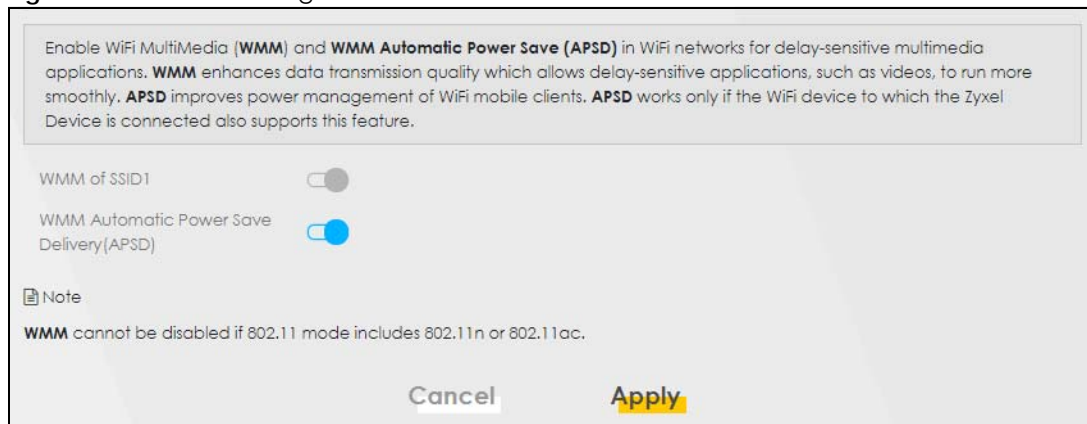

Note: **WMM** cannot be disabled if 802.11 mode includes 802.11n or 802.11ac.

The following table describes the labels in this screen.

Table 35 Network Setting > Wireless > WMM

LABEL	DESCRIPTION
WMM of SSID1~4	Select On to have the Zyxel Device automatically give the WiFi network (SSIDx) a priority level according to the ToS value in the IP header of packets it sends. WMM QoS (WiFi MultiMedia Quality of Service) gives high priority to video, which makes them run more smoothly. If the 802.11 Mode in Network Setting > Wireless > Others is set to include 802.11n or 802.11ac, WMM cannot be disabled.
WMM Automatic Power Save Delivery (APSD)	Select this option to extend the battery life of your mobile devices (especially useful for small devices that are running multimedia applications). The Zyxel Device goes to sleep mode to save power when it is not transmitting data. The AP buffers the packets sent to the Zyxel Device until the Zyxel Device "wakes up." The Zyxel Device wakes up periodically to check for incoming data. Note: This works only if the WiFi device to which the Zyxel Device is connected also supports this feature.
Cancel	Click Cancel to restore your previously saved settings.
Apply	Click Apply to save your changes.

7.8 Others Screen

Use this screen to configure advanced wireless settings, such as additional security settings, power saving, and data transmission settings. Click **Network Setting > Wireless > Others**. The screen appears as shown.

See [Section 7.11.2 on page 120](#) for detailed definitions of the terms listed here.

Figure 79 Network Setting > Wireless > Others

Use this screen to change the default advanced WiFi settings. See the User's Guide for field details.

RTS/CTS Threshold	<input type="text" value="2347"/>	
Fragmentation Threshold	<input type="text" value="2346"/>	
Output Power	<input type="text" value="100%"/>	▼
Beacon Interval	<input type="text" value="100"/>	ms
DTIM Interval	<input type="text" value="1"/>	ms
802.11 Mode	<input type="text" value="802.11b/g/n Mixed"/>	▼
802.11 Protection	<input type="text" value="Auto"/>	▼
Preamble	<input type="text" value="Long"/>	
Protected Management Frames	<input type="text" value="Capable"/>	▼

The following table describes the labels in this screen.

Table 36 Network Setting > Wireless > Others

LABEL	DESCRIPTION
RTS/CTS Threshold	<p>Data with its frame size larger than this value will perform the RTS (Request To Send)/CTS (Clear To Send) handshake.</p> <p>Enter a value between 0 and 2347.</p>
Fragmentation Threshold	<p>This is the maximum data fragment size that can be sent. Enter a value between 256 and 2346.</p>
Output Power	<p>Set the output power of the Zyxel Device. If there is a high density of APs in an area, decrease the output power to reduce interference with other APs. Select one of the following: 20%, 40%, 60%, 80% or 100%.</p>
Beacon Interval	<p>When a wirelessly networked device sends a beacon, it includes with it a beacon interval. This specifies the time period before the device sends the beacon again.</p> <p>The interval tells receiving devices on the network how long they can wait in low power mode before waking up to handle the beacon. This value can be set from 50ms to 1000ms. A high value helps save current consumption of the access point.</p>
DTIM Interval	<p>Delivery Traffic Indication Message (DTIM) is the time period after which broadcast and multicast packets are transmitted to mobile clients in the Power Saving mode. A high DTIM value can cause clients to lose connectivity with the network. This value can be set from 1 to 255.</p>
802.11 Mode	<p>For 2.4GHz frequency WLAN devices:</p> <ul style="list-style-type: none"> • Select 802.11b Only to allow only IEEE 802.11b compliant WLAN devices to associate with the Zyxel Device. • Select 802.11g Only to allow only IEEE 802.11g compliant WLAN devices to associate with the Zyxel Device. • Select 802.11n Only to allow only IEEE 802.11n compliant WLAN devices to associate with the Zyxel Device. • Select 802.11b/g Mixed to allow either IEEE 802.11b or IEEE 802.11g compliant WLAN devices to associate with the Zyxel Device. The transmission rate of your Zyxel Device might be reduced. • Select 802.11b/g/n Mixed to allow IEEE 802.11b, IEEE 802.11g or IEEE802.11n compliant WLAN devices to associate with the Zyxel Device. The transmission rate of your Zyxel Device might be reduced. <p>For 5GHz frequency WLAN devices:</p> <ul style="list-style-type: none"> • Select 802.11a Only to allow only IEEE 802.11a compliant WLAN devices to associate with the Zyxel Device. • Select 802.11n Only to allow only IEEE 802.11n compliant WLAN devices to associate with the Zyxel Device. • Select 802.11ac Only to allow only IEEE 802.11ac compliant WLAN devices to associate with the Zyxel Device. • Select 802.11a/n Mixed to allow either IEEE 802.11a or IEEE 802.11n compliant WLAN devices to associate with the Zyxel Device. The transmission rate of your Zyxel Device might be reduced. • Select 802.11n/ac Mixed to allow either IEEE 802.11n or IEEE 802.11ac compliant WLAN devices to associate with the Zyxel Device. The transmission rate of your Zyxel Device might be reduced. • Select 802.11a/n/ac Mixed to allow IEEE 802.11a, IEEE 802.11n or IEEE802.11ac compliant WLAN devices to associate with the Zyxel Device. The transmission rate of your Zyxel Device might be reduced.
802.11 Protection	<p>Enabling this feature can help prevent collisions in mixed-mode networks (networks with both IEEE 802.11b and IEEE 802.11g traffic).</p> <p>Select Auto to have the wireless devices transmit data after a RTS/CTS handshake. This helps improve IEEE 802.11g performance.</p> <p>Select Off to disable 802.11 protection. The transmission rate of your Zyxel Device might be reduced in a mixed-mode network.</p> <p>This field displays Off and is not configurable when you set 802.11 Mode to 802.11b Only.</p>

Table 36 Network Setting > Wireless > Others (continued)

LABEL	DESCRIPTION
Preamble	Select a preamble type from the drop-down list box. Choices are Long or Short . See Section 7.11.6 on page 123 for more information. This field is configurable only when you set 802.11 Mode to 802.11b .
Protected Management Frames	WiFi with Protected Management Frames (PMF) provides protection for unicast and multicast management action frames. Unicast management action frames are protected from both eavesdropping and forging, and multicast management action frames are protected from forging. Select Capable if the WiFi client supports PMF, then the management frames will be encrypted. Select Required to force the WiFi client to support PMF; otherwise the authentication cannot be performed by the Zyxel Device. Otherwise, select Disabled .
Cancel	Click Cancel to restore your previously saved settings.
Apply	Click Apply to save your changes.

7.9 WLAN Scheduler

Use the **WLAN Scheduler** screen to create rules to schedule the times to permit Internet traffic from each wireless network interfaces. Select a specific time and day of a week for scheduling. You can also create a rule to automatically switch off all the WLAN together.

Click **Network Setting > Wireless > WLAN Scheduler**.

Figure 80 Network Setting > Wireless > WLAN Scheduler

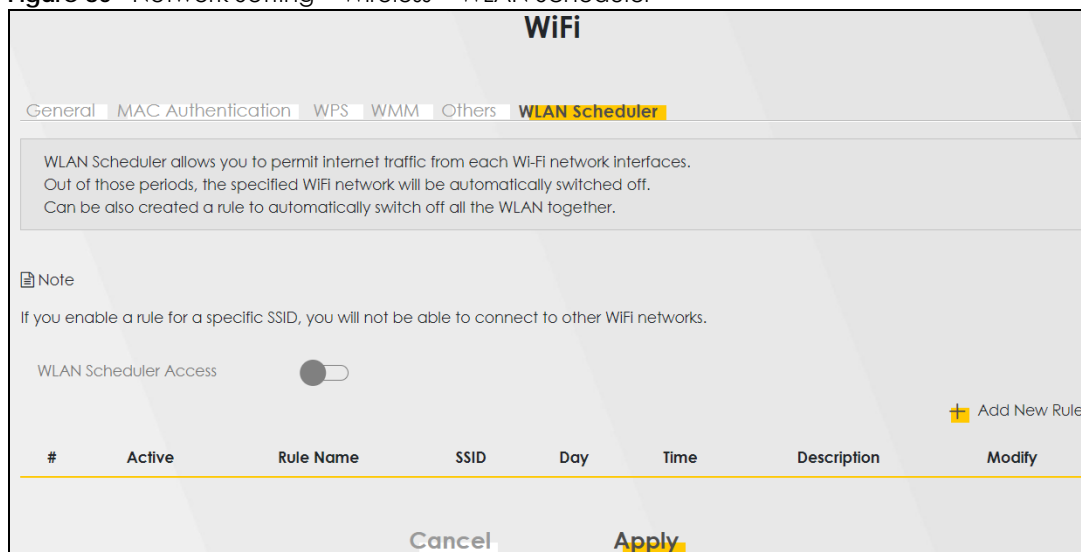

The following table describes the labels in this screen.

Table 37 Network Setting > Wireless > WLAN Scheduler

LABEL	DESCRIPTION
WLAN Scheduler Access	Click this switch to enable the WLAN scheduler function. This serves as the main switch to allow the individual rules to function. When the switch turns blue  , the function is enabled. Otherwise, it's not.
Add New Rule	Click this to configure a new WLAN scheduler rule.
#	This is the index number of the entry.

Table 37 Network Setting > Wireless > WLAN Scheduler (continued)

LABEL	DESCRIPTION
Active	Click the check box to enable individual rules. Note: Make sure to enable the WLAN Scheduler Access switch for the individual rules to work.
Rule Name	This field displays the name of the rule.
SSID	This is the descriptive name used to identify the wireless network interface that this rule applies to. Will show ALL WLAN if you select All wireless networks in the Add New Rule screen.
Day	This field displays the day(s) of the week that you wish to apply this rule.
Time	This field displays the time of the day that you wish to apply this rule.
Description	This field shows a description of the rule, usually to help identify it.
Modify	Click the Edit icon to configure the rule. Click the Delete icon to remove the rule.

Note: If you enable a rule for a specific SSID, you will not be able to connect to other wireless networks.

7.9.1 Add/Edit Rules

Click **Add New Rule** in the **WLAN Scheduler** screen, or click the **Edit** icon next to a scheduling rule, and the following screen displays.

Use this screen to create a scheduling rule to permit Internet traffic from each wireless network interface.

Figure 81 Network Setting > Wireless > WLAN Scheduler > Add New Rule

The screenshot shows the 'Add New Rule' configuration screen. At the top left is a back arrow. The title is 'Add New Rule'. Below the title, there is a section for 'Active' with a blue toggle switch turned on. Underneath is the 'SSID' dropdown menu, currently set to 'All WiFi networks'. Below that is a text input field for 'Rule Name'. A 'Note' icon is followed by the text: 'Select days and time interval you want the specified WiFi network will be automatically turned on.' The 'Day' section features eight radio buttons: 'Every day', 'Mon', 'Tue', 'Wed', 'Thu', 'Fri', 'Sat', and 'Sun'. The 'Time of Day Range' section has 'From' and 'To' time pickers, with '(hh:mm)' indicating the format. There is an 'All days' checkbox which is currently unchecked. At the bottom is a 'Description' text input field. At the very bottom are two buttons: 'Cancel' and 'OK'.

The following table describes the labels in this screen.

Table 38 Network Setting > Wireless > WLAN Schedule > Add New Rule

LABEL	DESCRIPTION
Active	Slide the switch to the right () to enable this WLAN scheduler rule.
SSID	Select All wireless networks if you want the rule to apply to all wireless network interfaces or select a wireless network interface to apply the rule to.
Rule Name	Enter a descriptive name for the rule.
Day	Select the day(s) of the week that you wish to apply this rule.
Time of Day Range	Specify the time of the day that you wish to apply to this rule (format hh:mm). Note: Click the check box for All day if you wish to apply the rule for the whole day (24 hours).
Description	Enter a description of the rule, usually to help identify it (its purpose).
OK	Click OK to save the changes back to the Zyxel Device.
Cancel	Click Cancel to close the window with changes unsaved.

7.10 Channel Status

Use this screen to scan for wireless LAN channel noises and view the results. Click **Scan** to start, and then view the results in the **Channel Scan Result** section. The value on each channel number indicates the number of Access Points (AP) using that channel. The Auto-channel-selection algorithm does not always directly follow the AP count; other factors about the channels are also considered. Click **Network Setting > Wireless > Channel Status**. The screen appears as shown. Click **Scan** to scan wireless LAN channels. You can view the results in Channel Status screen.

Figure 82 Network Setting > Wireless > Channel Status

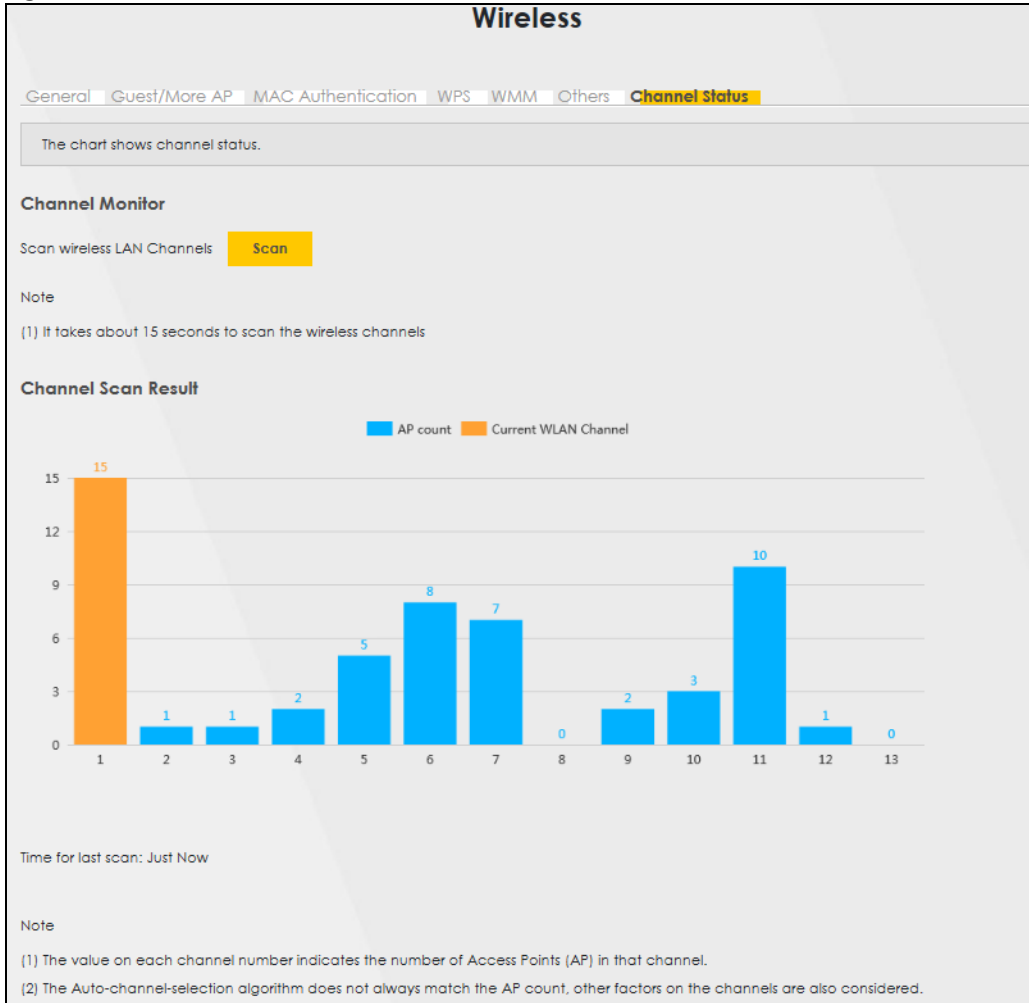

7.11 Technical Reference

This section discusses wireless LANs in depth.

7.11.1 WiFi Network Overview

WiFi networks consist of WiFi clients, access points and bridges.

- A WiFi client is a radio connected to a user's computer.
- An access point is a radio with a wired connection to a network, which can connect with numerous WiFi clients and let them access the network.
- A bridge is a radio that relays communications between access points and WiFi clients, extending a network's range.

Normally, a WiFi network operates in an "infrastructure" type of network. An "infrastructure" type of network has one or more access points and one or more WiFi clients. The WiFi clients connect to the access points.

The following figure provides an example of a WiFi network.

Figure 83 Example of a WiFi Network

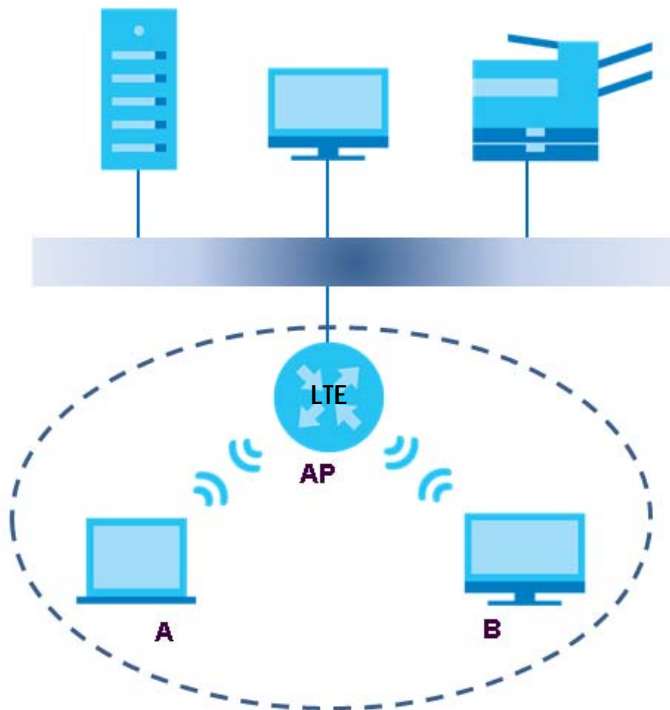

The WiFi network is the part in the blue circle. In this WiFi network, devices **A** and **B** use the access point (**AP**) to interact with the other devices (such as the printer) or with the Internet. Your Zyxel Device is the AP.

Every WiFi network must follow these basic guidelines.

- Every device in the same WiFi network must use the same SSID.
The SSID is the name of the WiFi network. It stands for Service Set Identifier.
- If two WiFi networks overlap, they should use a different channel.
Like radio stations or television channels, each WiFi network uses a specific channel, or frequency, to send and receive information.
- Every device in the same WiFi network must use security compatible with the AP.
Security stops unauthorized devices from using the WiFi network. It can also protect the information that is sent in the WiFi network.

Radio Channels

In the radio spectrum, there are certain frequency bands allocated for unlicensed, civilian use. For the purposes of WiFi networking, these bands are divided into numerous channels. This allows a variety of networks to exist in the same place without interfering with one another. When you create a network, you must select a channel to use.

Since the available unlicensed spectrum varies from one country to another, the number of available channels also varies.

7.11.2 Additional Wireless Terms

The following table describes some WiFi network terms and acronyms used in the Zyxel Device's Web Configurator.

Table 39 Additional WiFi Terms

TERM	DESCRIPTION
RTS/CTS Threshold	<p>In a WiFi network which covers a large area, WiFi devices are sometimes not aware of each other's presence. This may cause them to send information to the AP at the same time and result in information colliding and not getting through.</p> <p>By setting this value lower than the default value, the WiFi devices must sometimes get permission to send information to the Zyxel Device. The lower the value, the more often the devices must get permission.</p> <p>If this value is greater than the fragmentation threshold value (see below), then WiFi devices never have to get permission to send information to the Zyxel Device.</p>
Preamble	A preamble affects the timing in your WiFi network. There are two preamble modes: long and short. If a device uses a different preamble mode than the Zyxel Device does, it cannot communicate with the Zyxel Device.
Authentication	The process of verifying whether a WiFi device is allowed to use the WiFi network.
Fragmentation Threshold	A small fragmentation threshold is recommended for busy networks, while a larger threshold provides faster performance if the network is not very busy.

7.11.3 WiFi Security Overview

By their nature, radio communications are simple to intercept. For WiFi data networks, this means that anyone within range of a WiFi network without security can not only read the data passing over the airwaves, but also join the network. Once an unauthorized person has access to the network, he or she can steal information or introduce malware (malicious software) intended to compromise the network. For these reasons, a variety of security systems have been developed to ensure that only authorized people can use a WiFi data network, or understand the data carried on it.

These security standards do two things. First, they authenticate. This means that only people presenting the right credentials (often a username and password, or a "key" phrase) can access the network. Second, they encrypt. This means that the information sent over the air is encoded. Only people with the code key can understand the information, and only people who have been authenticated are given the code key.

These security standards vary in effectiveness. Some can be broken, such as the old Wired Equivalent Protocol (WEP). Using WEP is better than using no security at all, but it will not keep a determined attacker out. Other security standards are secure in themselves but can be broken if a user does not use them properly. For example, the WPA-PSK security standard is very secure if you use a long key which is difficult for an attacker's software to guess - for example, a twenty-letter long string of apparently random numbers and letters - but it is not very secure if you use a short key which is very easy to guess - for example, a three-letter word from the dictionary.

Because of the damage that can be done by a malicious attacker, it's not just people who have sensitive information on their network who should use security. Everybody who uses any WiFi network should ensure that effective security is in place.

A good way to come up with effective security keys, passwords and so on is to use obscure information that you personally will easily remember, and to enter it in a way that appears random and does not include real words. For example, if your mother owns a 1970 Dodge Challenger and her favorite movie is

Vanishing Point (which you know was made in 1971) you could use "70dodchal71vanpoi" as your security key.

The following sections introduce different types of WiFi security you can set up in the WiFi network.

7.11.3.1 SSID

Normally, the Zyxel Device acts like a beacon and regularly broadcasts the SSID in the area. You can hide the SSID instead, in which case the Zyxel Device does not broadcast the SSID. In addition, you should change the default SSID to something that is difficult to guess.

This type of security is fairly weak, however, because there are ways for unauthorized WiFi devices to get the SSID. In addition, unauthorized WiFi devices can still see the information that is sent in the WiFi network.

7.11.3.2 MAC Address Filter

Every device that can use a WiFi network has a unique identification number, called a MAC address.¹ A MAC address is usually written using twelve hexadecimal characters²; for example, 00A0C5000002 or 00:A0:C5:00:00:02. To get the MAC address for each device in the WiFi network, see the device's User's Guide or other documentation.

You can use the MAC address filter to tell the Zyxel Device which devices are allowed or not allowed to use the WiFi network. If a device is allowed to use the WiFi network, it still has to have the correct information (SSID, channel, and security). If a device is not allowed to use the WiFi network, it does not matter if it has the correct information.

This type of security does not protect the information that is sent in the WiFi network. Furthermore, there are ways for unauthorized WiFi devices to get the MAC address of an authorized device. Then, they can use that MAC address to use the WiFi network.

7.11.3.3 User Authentication

Authentication is the process of verifying whether a WiFi device is allowed to use the WiFi network. You can make every user log in to the WiFi network before using it. However, every device in the WiFi network has to support IEEE 802.1x to do this.

For WiFi networks, you can store the user names and passwords for each user in a RADIUS server. This is a server used in businesses more than in homes. If you do not have a RADIUS server, you cannot set up user names and passwords for your users.

Unauthorized WiFi devices can still see the information that is sent in the WiFi network, even if they cannot use the WiFi network. Furthermore, there are ways for unauthorized WiFi users to get a valid user name and password. Then, they can use that user name and password to use the WiFi network.

7.11.3.4 Encryption

WiFi networks can use encryption to protect the information that is sent in the WiFi network. Encryption is like a secret code. If you do not know the secret code, you cannot understand the message.

-
1. Some wireless devices, such as scanners, can detect WiFi networks but cannot use WiFi networks. These kinds of wireless devices might not have MAC addresses.
 2. Hexadecimal characters are 0, 1, 2, 3, 4, 5, 6, 7, 8, 9, A, B, C, D, E, and F.

The types of encryption you can choose depend on the type of authentication. (See [Section 7.11.3.3 on page 121](#) for information about this.)

Table 40 Types of Encryption for Each Type of Authentication

	NO AUTHENTICATION	RADIUS SERVER
Weakest	No Security	WPA
↕	WPA-PSK	
Strongest	WPA2-PSK	

For example, if the WiFi network has a RADIUS server, you can choose **WPA** or **WPA2**. If users do not log in to the WiFi network, you can choose no encryption, **WPA-PSK**, or **WPA2-PSK**.

Note: It is recommended that WiFi networks use **WPA-PSK**, **WPA**, or stronger encryption. The other types of encryption are better than none at all, but it is still possible for unauthorized WiFi devices to figure out the original information pretty quickly.

Many types of encryption use a key to protect the information in the WiFi network. The longer the key, the stronger the encryption. Every device in the WiFi network must have the same key.

7.11.4 Signal Problems

Because WiFi networks are radio networks, their signals are subject to limitations of distance, interference and absorption.

Problems with distance occur when the two radios are too far apart. Problems with interference occur when other radio waves interrupt the data signal. Interference may come from other radio transmissions, such as military or air traffic control communications, or from machines that are coincidental emitters such as electric motors or microwaves. Problems with absorption occur when physical objects (such as thick walls) are between the two radios, muffling the signal.

7.11.5 BSS

A Basic Service Set (BSS) exists when all communications between wireless stations go through one access point (AP).

Intra-BSS traffic is traffic between wireless stations in the BSS. When Intra-BSS traffic blocking is disabled, wireless station A and B can access the wired network and communicate with each other. When Intra-BSS traffic blocking is enabled, wireless station A and B can still access the wired network but cannot communicate with each other.

Figure 84 Basic Service Set

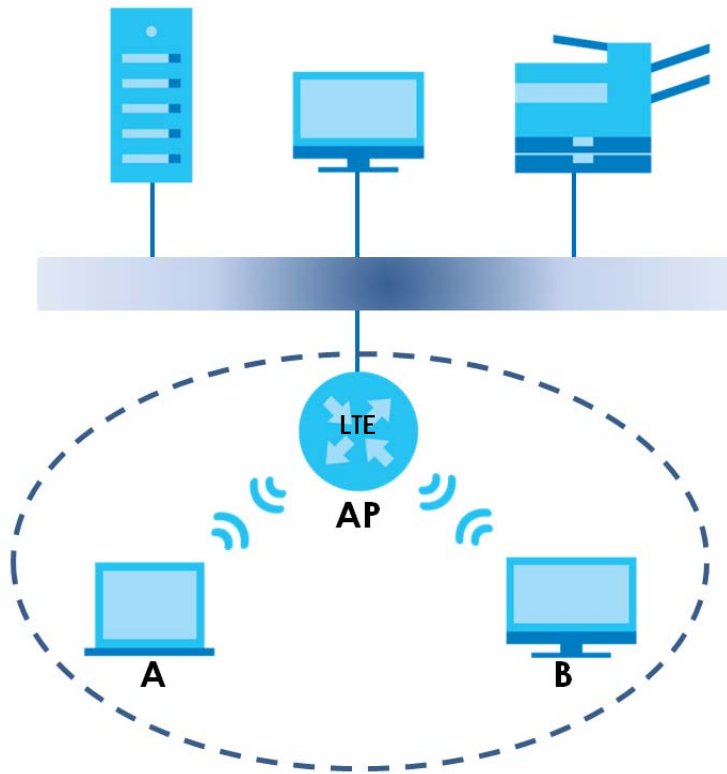

7.11.6 Preamble Type

Preamble is used to signal that data is coming to the receiver. Short and long refer to the length of the synchronization field in a packet.

Short preamble increases performance as less time sending preamble means more time for sending data. All IEEE 802.11 compliant wireless adapters support long preamble, but not all support short preamble.

Use long preamble if you are unsure what preamble mode other WiFi devices on the network support, and to provide more reliable communications in busy WiFi networks.

Use short preamble if you are sure all WiFi devices on the network support it, and to provide more efficient communications.

Use the dynamic setting to automatically use short preamble when all WiFi devices on the network support it, otherwise the Zyxel Device uses long preamble.

Note: The WiFi devices **MUST** use the same preamble mode in order to communicate.

7.11.7 WiFi Protected Setup (WPS)

Your Zyxel Device supports WiFi Protected Setup (WPS), which is an easy way to set up a secure WiFi network. WPS is an industry standard specification, defined by the WiFi Alliance.

WPS allows you to quickly set up a WiFi network with strong security, without having to configure security settings manually. Each WPS connection works between two devices. Both devices must support WPS (check each device's documentation to make sure).

Depending on the devices you have, you can either press a button (on the device itself, or in its configuration utility) or enter a PIN (a unique Personal Identification Number that allows one device to authenticate the other) in each of the two devices. When WPS is activated on a device, it has two minutes to find another device that also has WPS activated. Then, the two devices connect and set up a secure network by themselves.

7.11.7.1 Push Button Configuration

WPS Push Button Configuration (PBC) is initiated by pressing a button on each WPS-enabled device, and allowing them to connect automatically. You do not need to enter any information.

Not every WPS-enabled device has a physical WPS button. Some may have a WPS PBC button in their configuration utilities instead of or in addition to the physical button.

Take the following steps to set up WPS using the button.

- 1 Ensure that the two devices you want to set up are within wireless range of one another.
- 2 Look for a WPS button on each device. If the device does not have one, log into its configuration utility and locate the button (see the device's User's Guide for how to do this - for the Zyxel Device, see [Section 7.6 on page 110](#)).
- 3 Press the button on one of the devices (it doesn't matter which). For the Zyxel Device you must press the **WiFi** button for more than five seconds.
- 4 Within two minutes, press the button on the other device. The registrar sends the network name (SSID) and security key through a secure connection to the enrollee.

If you need to make sure that WPS worked, check the list of associated WiFi clients in the AP's configuration utility. If you see the WiFi client in the list, WPS was successful.

7.11.7.2 PIN Configuration

Each WPS-enabled device has its own PIN (Personal Identification Number). This may either be static (it cannot be changed) or dynamic (in some devices you can generate a new PIN by clicking on a button in the configuration interface).

Use the PIN method instead of the push-button configuration (PBC) method if you want to ensure that the connection is established between the devices you specify, not just the first two devices to activate WPS in range of each other. However, you need to log into the configuration interfaces of both devices to use the PIN method.

When you use the PIN method, you must enter the PIN from one device (usually the WiFi client) into the second device (usually the Access Point or wireless router). Then, when WPS is activated on the first device, it presents its PIN to the second device. If the PIN matches, one device sends the network and security information to the other, allowing it to join the network.

Take the following steps to set up a WPS connection between an access point or wireless router (referred to here as the AP) and a client device using the PIN method.

- 1** Ensure WPS is enabled on both devices.
- 2** Access the WPS section of the AP's configuration interface. See the device's User's Guide on how to do this.
- 3** Look for the client's WPS PIN; it will be displayed either on the device, or in the WPS section of the client's configuration interface (see the device's User's Guide on how to find the WPS PIN - for the Zyxel Device, see [Section 7.6 on page 110](#)).
- 4** Enter the client's PIN in the AP's configuration interface.
- 5** If the client device's configuration interface has an area for entering another device's PIN, you can either enter the client's PIN in the AP, or enter the AP's PIN in the client - it does not matter which.
- 6** Start WPS on both devices within two minutes.
- 7** Use the configuration utility to activate WPS, not the push-button on the device itself.
- 8** On a computer connected to the WiFi client, try to connect to the Internet. If you can connect, WPS was successful.

If you cannot connect, check the list of associated WiFi clients in the AP's configuration utility. If you see the WiFi client in the list, WPS was successful.

The following figure shows a WPS-enabled WiFi client (installed in a notebook computer) connecting to the WPS-enabled AP via the PIN method.

Figure 85 Example WPS Process: PIN Method
ENROLLEE

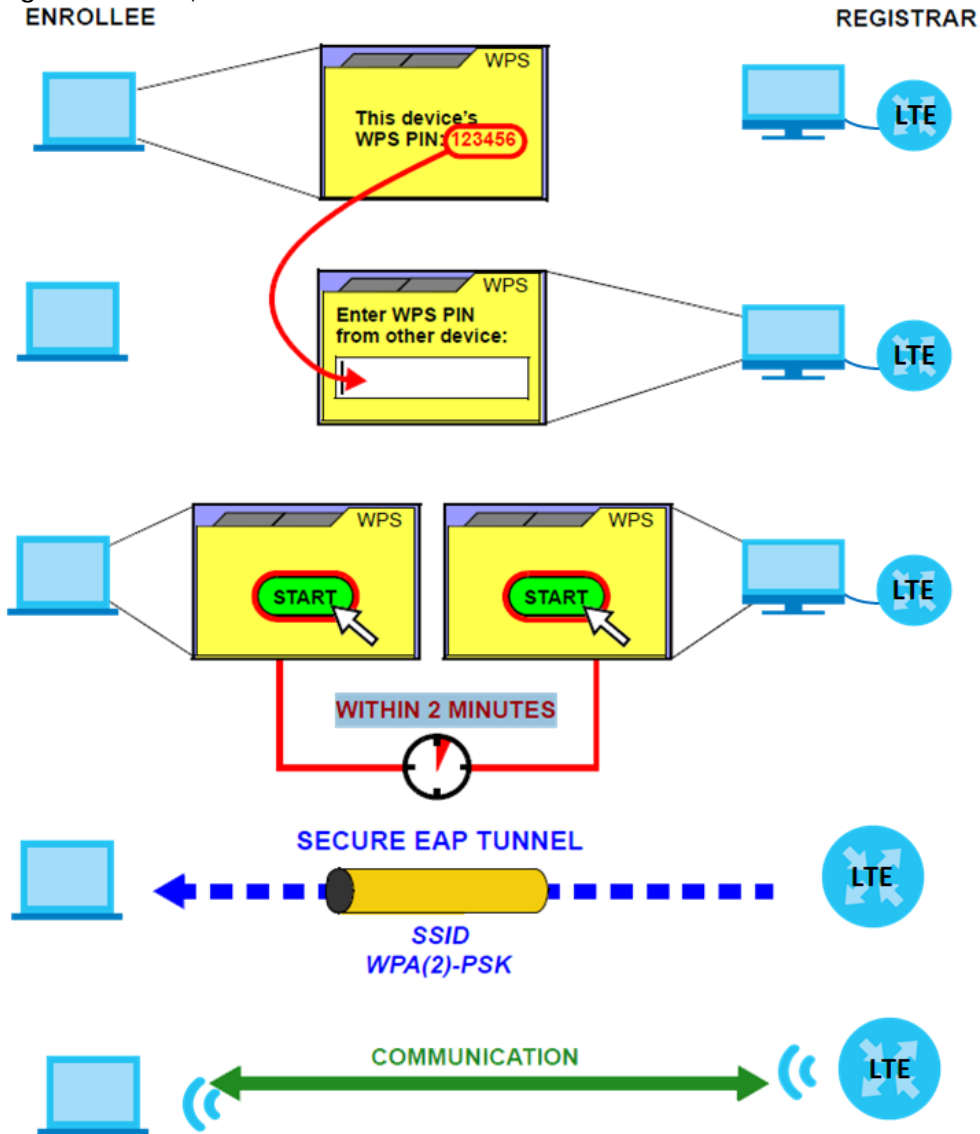

7.11.7.3 How WPS Works

When two WPS-enabled devices connect, each device must assume a specific role. One device acts as the registrar (the device that supplies network and security settings) and the other device acts as the enrollee (the device that receives network and security settings). The registrar creates a secure EAP (Extensible Authentication Protocol) tunnel and sends the network name (SSID) and the WPA-PSK or WPA2-PSK pre-shared key to the enrollee. Whether WPA-PSK or WPA2-PSK is used depends on the standards supported by the devices. If the registrar is already part of a network, it sends the existing information. If not, it generates the SSID and WPA(2)-PSK randomly.

The following figure shows a WPS-enabled client (installed in a notebook computer) connecting to a WPS-enabled access point.

Figure 86 How WPS works

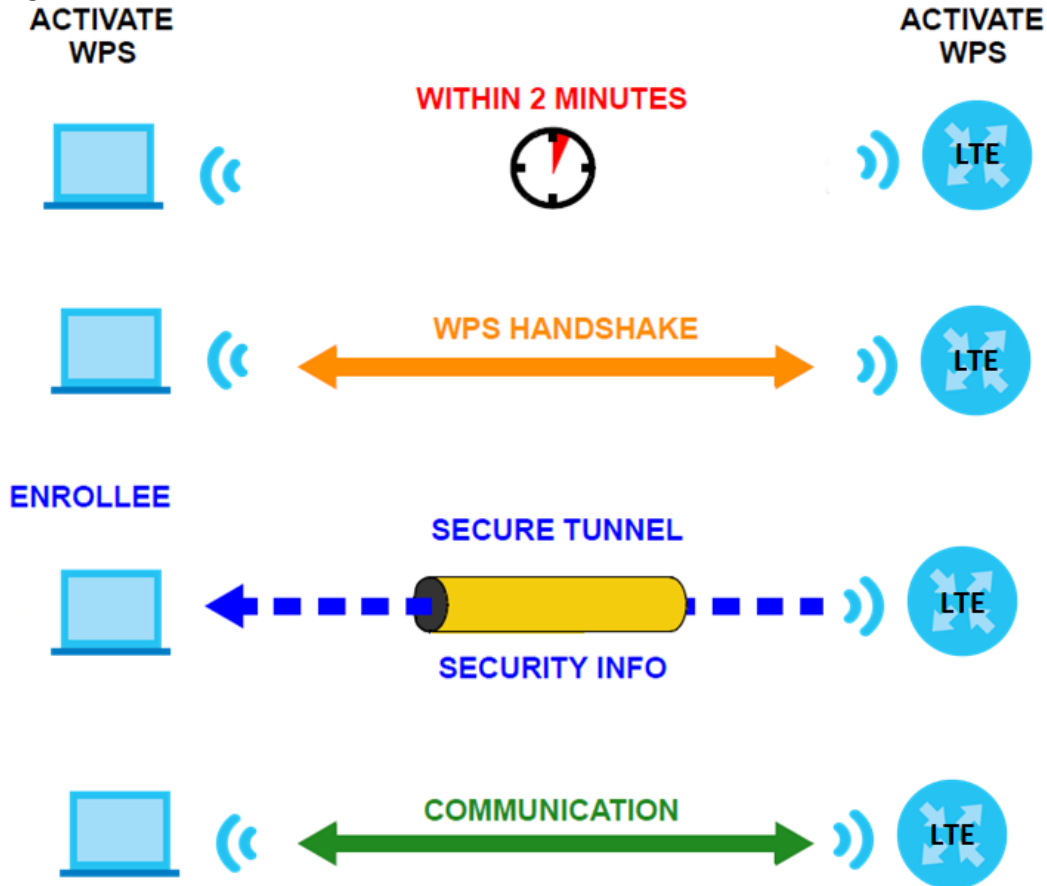

The roles of registrar and enrollee last only as long as the WPS setup process is active (two minutes). The next time you use WPS, a different device can be the registrar if necessary.

The WPS connection process is like a handshake; only two devices participate in each WPS transaction. If you want to add more devices you should repeat the process with one of the existing networked devices and the new device.

Note that the access point (AP) is not always the registrar, and the WiFi client is not always the enrollee. All WPS-certified APs can be a registrar, and so can some WPS-enabled WiFi clients.

By default, a WPS device is 'unconfigured'. This means that it is not part of an existing network and can act as either enrollee or registrar (if it supports both functions). If the registrar is unconfigured, the security settings it transmits to the enrollee are randomly-generated. Once a WPS-enabled device has connected to another device using WPS, it becomes 'configured'. A configured WiFi client can still act as enrollee or registrar in subsequent WPS connections, but a configured access point can no longer act as enrollee. It will be the registrar in all subsequent WPS connections in which it is involved. If you want a configured AP to act as an enrollee, you must reset it to its factory defaults.

7.11.7.4 Example WPS Network Setup

This section shows how security settings are distributed in a sample WPS setup.

The following figure shows a sample network. In step 1, both **AP1** and **Client 1** are unconfigured. When WPS is activated on both, they perform the handshake. In this example, **AP1** is the registrar, and **Client 1**

is the enrollee. The registrar randomly generates the security information to set up the network, since it is unconfigured and has no existing information.

Figure 87 WPS: Example Network Step 1



In step 2, you add another WiFi client to the network. You know that **Client 1** supports registrar mode, but it is better to use **AP1** for the WPS handshake with the new client since you must connect to the access point anyway in order to use the network. In this case, **AP1** must be the registrar, since it is configured (it already has security information for the network). **AP1** supplies the existing security information to **Client 2**.

Figure 88 WPS: Example Network Step 2

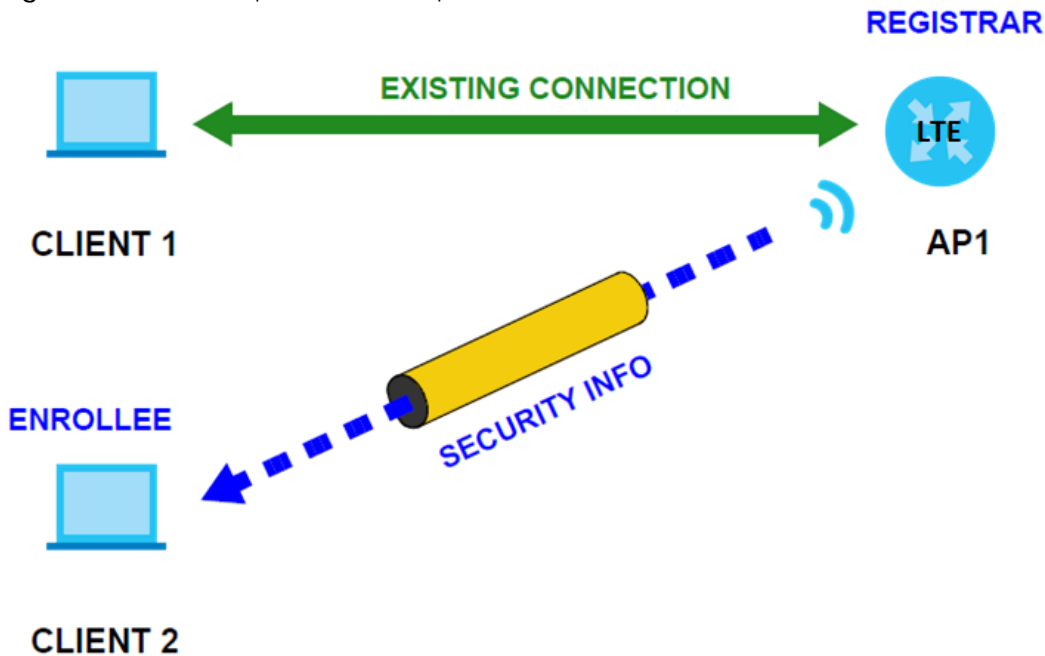

In step 3, you add another access point (**AP2**) to your network. **AP2** is out of range of **AP1**, so you cannot use **AP1** for the WPS handshake with the new access point. However, you know that **Client 2** supports the registrar function, so you use it to perform the WPS handshake instead.

Figure 89 WPS: Example Network Step 3

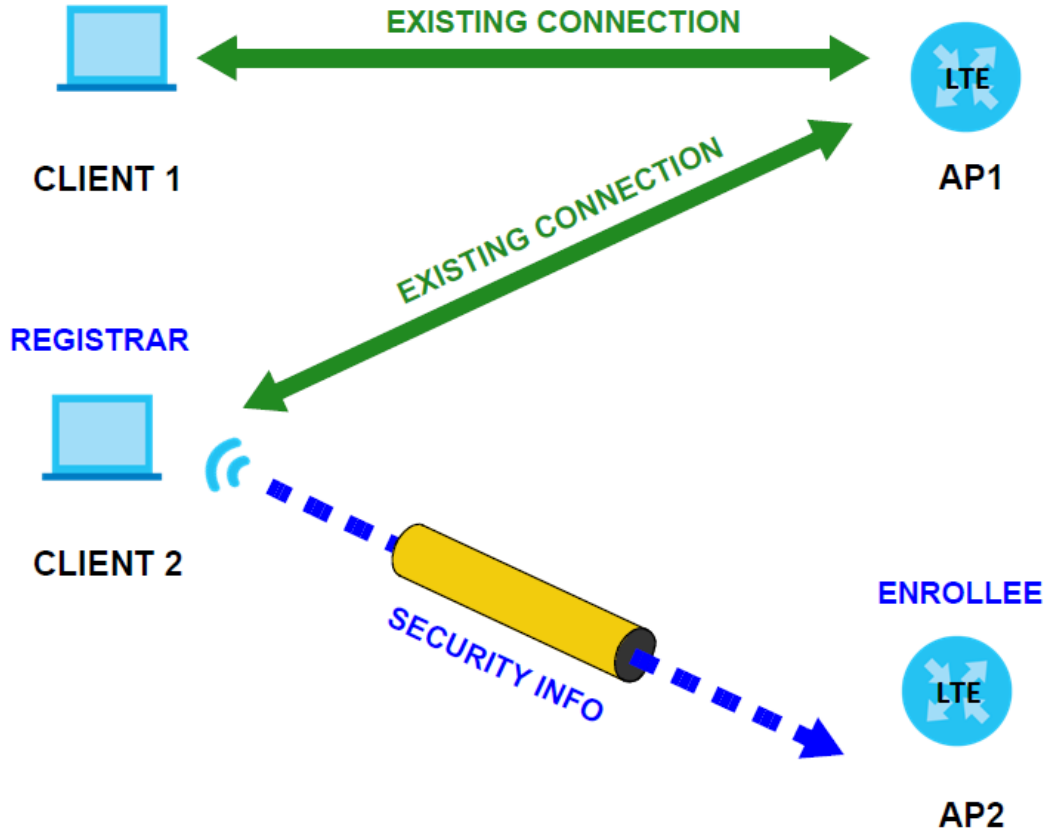

7.11.7.5 Limitations of WPS

WPS has some limitations of which you should be aware.

- When you use WPS, it works between two devices only. You cannot enroll multiple devices simultaneously, you must enroll one after the other.

For instance, if you have two enrollees and one registrar you must set up the first enrollee (by pressing the WPS button on the registrar and the first enrollee, for example), then check that it was successfully enrolled, then set up the second device in the same way.

- WPS works only with other WPS-enabled devices. However, you can still add non-WPS devices to a network you already set up using WPS.

WPS works by automatically issuing a randomly-generated WPA-PSK or WPA2-PSK pre-shared key from the registrar device to the enrollee devices. Whether the network uses WPA-PSK or WPA2-PSK depends on the device. You can check the configuration interface of the registrar device to discover the key the network is using (if the device supports this feature). Then, you can enter the key into the non-WPS device and join the network as normal (the non-WPS device must also support WPA-PSK or WPA2-PSK).

- When you use the PBC method, there is a short period (from the moment you press the button on one device to the moment you press the button on the other device) when any WPS-enabled device could join the network. This is because the registrar has no way of identifying the 'correct' enrollee, and cannot differentiate between your enrollee and a rogue device. This is a possible way for a hacker to gain access to a network.

You can easily check to see if this has happened. WPS only works simultaneously between two devices, so if another device has enrolled your device will be unable to enroll, and will not have access to the network. If this happens, open the access point's configuration interface and look at the list of associated clients (usually displayed by MAC address). It does not matter if the access point

is the WPS registrar, the enrollee, or was not involved in the WPS handshake; a rogue device must still associate with the access point to gain access to the network. Check the MAC addresses of your WiFi clients (usually printed on a label on the bottom of the device). If there is an unknown MAC address you can remove it or reset the AP.

CHAPTER 8

Home Networking

8.1 Overview

A Local Area Network (LAN) is a shared communication system to which many computers are attached. A LAN is usually located in one immediate area such as a building or floor of a building.

The LAN screens can help you configure a LAN DHCP server and manage IP addresses.

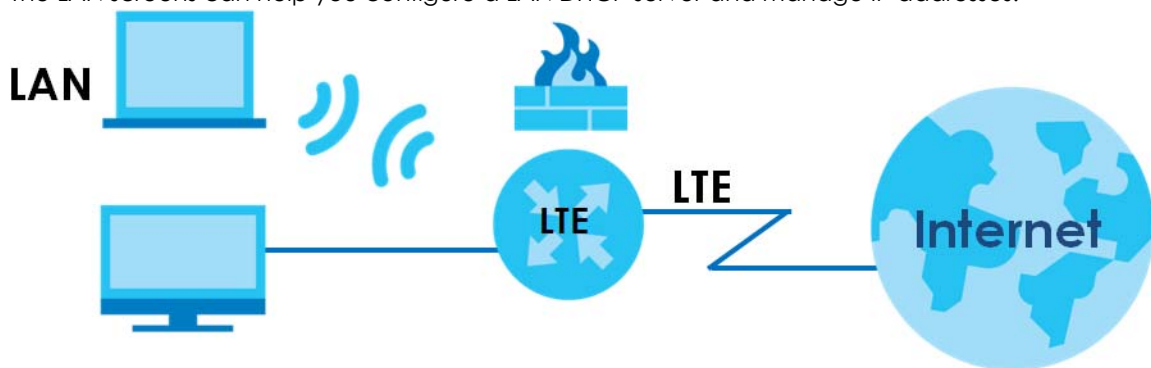

8.1.1 What You Can Do in this Chapter

- Use the **LAN Setup** screen to set the LAN IP address, subnet mask, and DHCP settings ([Section 8.2 on page 132](#)).
- Use the **Static DHCP** screen to assign IP addresses on the LAN to specific individual computers based on their MAC addresses ([Section 8.3 on page 136](#)).
- Use the **UPnP** screen to enable UPnP ([Section 8.4 on page 138](#)).

8.1.2 What You Need To Know

The following terms and concepts may help as you read this chapter.

8.1.2.1 About LAN

IP Address

Similar to the way houses on a street share a common street name, so too do computers on a LAN share one common network number. This is known as an Internet Protocol address.

Subnet Mask

The subnet mask specifies the network number portion of an IP address. Your Zyxel Device will compute the subnet mask automatically based on the IP address that you entered. You do not need to change the subnet mask computed by the Zyxel Device unless you are instructed to do otherwise.

DHCP

DHCP (Dynamic Host Configuration Protocol) allows clients to obtain TCP/IP configuration at start-up from a server. This Zyxel Device has a built-in DHCP server capability that assigns IP addresses and DNS servers to systems that support DHCP client capability.

DNS

DNS (Domain Name System) maps a domain name to its corresponding IP address and vice versa. The DNS server is extremely important because without it, you must know the IP address of a computer before you can access it. The DNS server addresses you enter when you set up DHCP are passed to the client machines along with the assigned IP address and subnet mask.

8.1.2.2 About UPnP

How do I know if I'm using UPnP?

UPnP hardware is identified as an icon in the Network Connections folder (Windows 7). Each UPnP compatible device installed on your network will appear as a separate icon. Selecting the icon of a UPnP device will allow you to access the information and properties of that device.

Cautions with UPnP

The automated nature of NAT traversal applications in establishing their own services and opening firewall ports may present network security issues. Network information and configuration may also be obtained and modified by users in some network environments.

When a UPnP device joins a network, it announces its presence with a multicast message. For security reasons, the Zyxel Device allows multicast messages on the LAN only.

All UPnP-enabled devices may communicate freely with each other without additional configuration. Disable UPnP if this is not your intention.

UPnP and Zyxel

Zyxel has achieved UPnP certification from the Universal Plug and Play Forum UPnP™ Implementers Corp. (UIC). Zyxel's UPnP implementation supports Internet Gateway Device (IGD) 1.0.

See [Section 8.6 on page 140](#) for examples on installing and using UPnP.

8.2 LAN Setup

A LAN IP address is the IP address of a networking device in the LAN. You can use the Zyxel Device's LAN IP address to access its Web Configurator from the LAN. The DHCP server settings define the rules on assigning IP addresses to LAN clients on your network.

Use this screen to set the Local Area Network IP address and subnet mask of your Zyxel Device. Configure DHCP settings to have the Zyxel Device or a DHCP server assign IP addresses to devices. Click **Network Setting > Home Networking** to open the **LAN Setup** screen.

Figure 90 Network Setting > Home Networking > LAN Setup

The LAN IP address is the IP address you use to log into the web configurator. The DHCP server settings define the rules on how to assign IP addresses to the LAN clients on your network.

Interface Group
Group Name:

LAN IP Setup
IP Address: . . .
Subnet Mask: . . .

DHCP Server State
DHCP: Enable Disable DHCP Relay

IP Addressing Values
Beginning IP Address: . . .
Ending IP Address: . . .
Auto reserve IP for the same host:

DHCP Server Lease Time
 days hours minutes

DNS Values
DNS: DNS Proxy Static From ISP

LAN IPv6 Mode Setup
IPv6 Active:

Link Local Address Type
 EUI64
 Manual

LAN Global Identifier Type
 EUI64
 Manual

LAN IPv6 Prefix Setup
 Delegate prefix from WAN
 Static

LAN IPv6 Address Assign Setup

LAN IPv6 DNS Assign Setup

DHCPv6 Configuration
DHCPv6 Active: DHCPv6 Server:

IPv6 Router Advertisement State
RA/DVD Active: Enable:

IPv6 DNS Values
IPv6 DNS Server 1:
IPv6 DNS Server 2:
IPv6 DNS Server 3:

DNS Query Scenario

The following table describes the fields in this screen.

Table 41 Network Setting > Home Networking > LAN Setup

LABEL	DESCRIPTION
Interface Group	
Group Name	This displays the name of the group that your Zyxel Device belongs to.
LAN IP Setup	
IP Address	Enter the LAN IP address you want to assign to your Zyxel Device in dotted decimal notation, for example, 192.168.1.1 (factory default).
Subnet Mask	Type the subnet mask of your network in dotted decimal notation, for example 255.255.255.0 (factory default). Your Zyxel Device automatically computes the subnet mask based on the IP address you enter, so do not change this field unless you are instructed to do so.
DHCP Server State	
DHCP	<p>Select Enable to have your Zyxel Device assign IP addresses, an IP default gateway and DNS servers to LAN computers and other devices that are DHCP clients.</p> <p>If you select Disable, you need to manually configure the IP addresses of the computers and other devices on your LAN.</p> <p>If you select DHCP Relay, the Zyxel Device acts as a surrogate DHCP server and relays DHCP requests and responses between the remote server and the clients.</p> <p>When DHCP is used, the following fields need to be set:</p>
IP Addressing Values	
Beginning IP Address	This field specifies the first of the contiguous addresses in the IP address pool.
Ending IP Address	This field specifies the last of the contiguous addresses in the IP address pool.
Auto reserve IP for the same host	Enable this if you want to reserve the IP address for the same host.
DHCP Server Lease Time	
Days/Hours/Minutes	DHCP server leases an address to a new device for a period of time, called the DHCP lease time. When the lease expires, the DHCP server might assign the IP address to a different device.
DNS Values	
DNS	<p>The Zyxel Device supports DNS proxy by default. The Zyxel Device sends out its own LAN IP address to the DHCP clients as the first DNS server address. DHCP clients use this first DNS server to send domain-name queries to the Zyxel Device. The Zyxel Device sends a response directly if it has a record of the domain-name to IP address mapping. If it does not, the Zyxel Device queries an outside DNS server and relays the response to the DHCP client.</p> <p>Select From ISP if your ISP dynamically assigns DNS server information (and the Zyxel Device's WAN IP address).</p> <p>Select Static if you have the IP address of a DNS server. Enter the DNS server's IP address in the field to the right.</p> <p>Select DNS Proxy to have the DHCP clients use the Zyxel Device's own LAN IP address. The Zyxel Device works as a DNS relay.</p>
LAN IPv6 Mode Setup	
IPv6 Active	<p>Use this field to Enable or Disable IPv6 activation on the Zyxel Device.</p> <p>When IPv6 activation is used, the following fields need to be set:</p>

Table 41 Network Setting > Home Networking > LAN Setup (continued)

LABEL	DESCRIPTION						
Link Local Address Type	<p>A link-local address uniquely identifies a device on the local network (the LAN). It is similar to a "private IP address" in IPv6. You can have the same link-local address on multiple interfaces on a device. A link-local unicast address has a predefined prefix of fe80::/10. The link-local unicast address format is as follows. Select EUI64 to allow the Zyxel Device to generate an interface ID for the LAN interface's link-local address using the EUI-64 format. Otherwise, enter an interface ID for the LAN interface's link-local address if you select Manual.</p> <p>Link-local Unicast Address Format</p> <table border="1" data-bbox="532 491 1060 564"> <tr> <td data-bbox="532 491 732 527">1111 1110 10</td> <td data-bbox="732 491 862 527">0</td> <td data-bbox="862 491 1060 527">Interface ID</td> </tr> <tr> <td data-bbox="532 527 732 564">10 bits</td> <td data-bbox="732 527 862 564">54 bits</td> <td data-bbox="862 527 1060 564">64 bits</td> </tr> </table>	1111 1110 10	0	Interface ID	10 bits	54 bits	64 bits
1111 1110 10	0	Interface ID					
10 bits	54 bits	64 bits					
LAN Global Identifier Type	Select EUI64 to have the Zyxel Device generate an interface ID using the EUI-64 format for its global address. Select Manual to manually enter an interface ID for the LAN interface's global IPv6 address.						
LAN IPv6 Prefix Setup	Select Delegate prefix from WAN to automatically obtain an IPv6 network prefix from the service provider or an uplink router. Select Static to configure a fixed IPv6 address for the Zyxel Device's LAN IPv6 address.						
LAN IPv6 Address Assign Setup	<p>Select how you want to obtain an IPv6 address:</p> <p>Stateless: The Zyxel Device uses IPv6 stateless autoconfiguration. RADVD (Router Advertisement Daemon) is enabled to have the Zyxel Device send IPv6 prefix information in router advertisements periodically and in response to router solicitations. DHCPv6 server is disabled.</p> <p>Stateful: The Zyxel Device uses IPv6 stateful autoconfiguration. The DHCPv6 server is enabled to have the Zyxel Device act as a DHCPv6 server and pass IPv6 addresses to DHCPv6 clients.</p>						
LAN IPv6 DNS Assign Setup	<p>Select how the Zyxel Device provide DNS server and domain name information to the clients:</p> <p>From Router Advertisement: The Zyxel Device provides DNS information through router advertisements.</p> <p>From DHCPv6 Server: The Zyxel Device provides DNS information through DHCPv6.</p> <p>From RA & DHCPv6 Server: The Zyxel Device provides DNS information through both router advertisements and DHCPv6.</p>						
DHCPv6 Configuration	DHCPv6 Active shows the status of the DHCPv6. DHCPv6 Server displays if you configured the Zyxel Device to act as a DHCPv6 server which assigns IPv6 addresses and/or DNS information to clients.						
IPv6 Router Advertisement State	RADVD Active shows whether RADVD is enabled or not.						
IPv6 DNS Values							
IPv6 DNS Server 1~3	<p>Specify the IP addresses up to three DNS servers for the DHCP clients to use. Use one of the following ways to specify these IP addresses.</p> <p>User Defined - Select this if you have the IPv6 address of a DNS server. Enter the DNS server IPv6 addresses the Zyxel Device passes to the DHCP clients.</p> <p>From ISP - Select this if your ISP dynamically assigns IPv6 DNS server information.</p> <p>Proxy - Select this if the DHCP clients use the IP address of this interface and the Zyxel Device works as a DNS relay.</p> <p>Otherwise, select None if you do not want to configure IPv6 DNS servers.</p>						

Table 41 Network Setting > Home Networking > LAN Setup (continued)

LABEL	DESCRIPTION
DNS Query Scenario	<p>Select how the Zyxel Device handles clients' DNS information requests.</p> <p>IPv4/IPv6 DNS Server: The Zyxel Device forwards the requests to both the IPv4 and IPv6 DNS servers and sends clients the first DNS information it receives.</p> <p>IPv6 DNS Server Only: The Zyxel Device forwards the requests to the IPv6 DNS server and sends clients the DNS information it receives.</p> <p>IPv4 DNS Server Only: The Zyxel Device forwards the requests to the IPv4 DNS server and sends clients the DNS information it receives.</p> <p>IPv6 DNS Server First: The Zyxel Device forwards the requests to the IPv6 DNS server first and then the IPv4 DNS server. Then it sends clients the first DNS information it receives.</p> <p>IPv4 DNS Server First: The Zyxel Device forwards the requests to the IPv4 DNS server first and then the IPv6 DNS server. Then it sends clients the first DNS information it receives.</p>
Apply	Click Apply to save your changes.
Cancel	Click Cancel to restore your previously saved settings.

8.3 Static DHCP

When any of the LAN clients in your network want an assigned fixed IP address, add a static lease for each LAN client. Knowing the LAN client's MAC addresses is necessary. This table allows you to assign IP addresses on the LAN to individual computers based on their MAC addresses.

Every Ethernet device has a unique MAC (Media Access Control) address. The MAC address is assigned at the factory and consists of six pairs of hexadecimal characters, for example, 00:A0:C5:00:00:02.

8.3.1 Before You Begin

Find out the MAC addresses of your network devices if you intend to add them to the **Static DHCP** screen.

Use this screen to change your Zyxel Device's static DHCP settings. Click **Network Setting > Home Networking > Static DHCP** to open the following screen.

Figure 91 Network Setting > Home Networking > Static DHCP

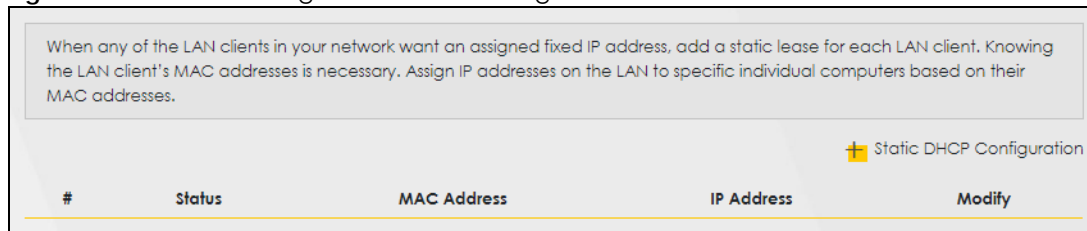

The following table describes the labels in this screen.

Table 42 Network Setting > Home Networking > Static DHCP

LABEL	DESCRIPTION
Static DHCP Configuration	Click this to configure a static DHCP entry.
#	This is the index number of the entry.
Status	Active
MAC Address	The MAC (Media Access Control) or Ethernet address on a LAN (Local Area Network) is unique to your computer (six pairs of hexadecimal notation). A network interface card such as an Ethernet adapter has a hardwired address that is assigned at the factory. This address follows an industry standard that ensures no other adapter has a similar address.
IP Address	This field displays the IP address relative to the # field listed above.
Modify	Click the Edit icon to configure the connection. Click the Delete icon to remove the connection.

If you click **Static DHCP Configuration** in the **Static DHCP** screen, the following screen displays.

Figure 92 Static DHCP: Static DHCP Configuration

The following table describes the labels in this screen.

Table 43 Static DHCP: Configuration

LABEL	DESCRIPTION
Active	Select Enable to activate static DHCP in your Zyxel Device.
Group Name	This displays the Group Name , usually Default .
IP Type	The IP Type is normally IPv4 (non-configurable).
Select Device Info	Select between Manual Input which allows you to enter the next two fields (MAC Address and IP Address); or selecting an existing device would show its MAC address and IP address.
MAC Address	Enter the MAC address of a computer on your LAN if you select Manual Input in the previous field.
IP Address	Enter the IP address that you want to assign to the computer on your LAN with the MAC address that you will also specify if you select Manual Input in the previous field.

Table 43 Static DHCP: Configuration

LABEL	DESCRIPTION
OK	Click OK to save your changes.
Cancel	Click Cancel to exit this screen without saving.

8.4 UPnP

Universal Plug and Play (UPnP) is an open networking standard that uses TCP/IP for simple peer-to-peer network connectivity between networking devices or software applications which have UPnP enabled. A UPnP device can dynamically join a network, obtain an IP address, advertise its services, and learn about other devices on the network. A device can also leave a network automatically when it is no longer in use.

See [Section 8.6 on page 140](#) for more information on UPnP.

Use the following screen to configure the UPnP settings on your Zyxel Device. Click **Network Setting > Home Networking > UPnP** to display the screen shown next.

Figure 93 Network Setting > Home Networking > UPnP

Universal Plug and Play (UPnP) is a distributed, open networking standard that uses TCP/IP for simple peer-to-peer network connectivity between networking devices and software that also have UPnP enabled. A UPnP device can dynamically join a network, obtain an IP address, convey its capabilities and learn about other devices on the network. A device can leave a network smoothly and automatically when it is no longer in use.

UPnP State

UPnP

UPnP NAT-T State

UPnP NAT-T

Note

UPnP NAT-T only works when NAT is enable

#	Description	Destination IP Address	External Port	Internal Port	Protocol
---	-------------	------------------------	---------------	---------------	----------

Cancel Apply

The following table describes the labels in this screen.

Table 44 Network Settings > Home Networking > UPnP

LABEL	DESCRIPTION
UPnP State	
UPnP	Select Enable to activate UPnP. Be aware that anyone could use a UPnP application to open the Web Configurator's login screen without entering the Zyxel Device's IP address (although you must still enter the password to access the Web Configurator).
UPnP NAT-T State	

Table 44 Network Settings > Home Networking > UPnP

LABEL	DESCRIPTION
UPnP NAT-T	Select Enable to activate UPnP with NAT enabled. UPnP NAT traversal automates the process of allowing an application to operate through NAT. UPnP network devices can automatically configure network addressing, announce their presence in the network to other UPnP devices and enable exchange of simple product and service descriptions.
#	This field displays the index number of the entry.
Description	This field displays the description of the UPnP NAT-T connection.
Destination IP Address	This field displays the IP address of the other connected UPnP-enabled device.
External Port	This field displays the external port number that identifies the service.
Internal Port	This field displays the internal port number that identifies the service.
Protocol	This field displays the protocol of the NAT mapping rule. Choices are TCP or UDP .
Apply	Click Apply to save your changes.
Cancel	Click Cancel to restore your previously saved settings.

8.5 Technical Reference

This section provides some technical background information about the topics covered in this chapter.

LANs, WANs and the Zyxel Device

The actual physical connection determines whether the Zyxel Device ports are LAN or WAN ports. There are two separate IP networks, one inside the LAN network and the other outside the WAN network as shown next.

Figure 94 LAN and WAN IP Addresses

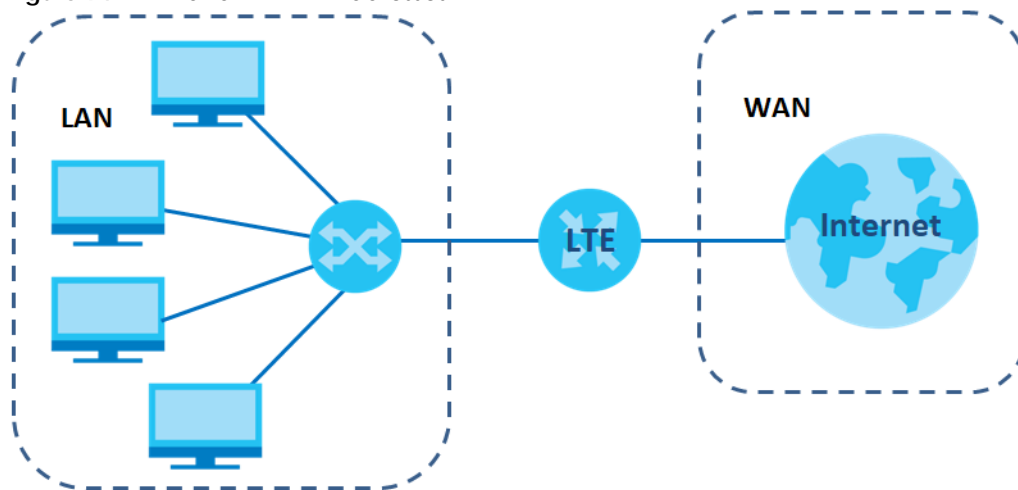

Private IP Addresses

Every machine on the Internet must have a unique address. If your networks are isolated from the Internet, for example, only between your two branch offices, you can assign any IP addresses to the

hosts without problems. However, the Internet Assigned Numbers Authority (IANA) has reserved the following three blocks of IP addresses specifically for private networks:

- 10.0.0.0 — 10.255.255.255
- 172.16.0.0 — 172.31.255.255
- 192.168.0.0 — 192.168.255.255

You can obtain your IP address from the IANA, from an ISP or it can be assigned from a private network. If you belong to a small organization and your Internet access is through an ISP, the ISP can provide you with the Internet addresses for your local networks. On the other hand, if you are part of a much larger organization, you should consult your network administrator for the appropriate IP addresses.

Note: Regardless of your particular situation, do not create an arbitrary IP address; always follow the guidelines above. For more information on address assignment, please refer to RFC 1597, "Address Allocation for Private Internets" and RFC 1466, "Guidelines for Management of IP Address Space."

8.6 Turn on UPnP in Windows 7 Example

This section shows you how to use the UPnP feature in Windows 7. UPnP server is installed in Windows 7. Activate UPnP on the Zyxel Device by clicking **Network Setting > Home Networking > UPnP**.

Make sure the computer is connected to the LAN port of the Zyxel Device. Turn on your computer and the Zyxel Device.

- 1 Click the start icon, **Control Panel** and then the **Network and Sharing Center**.

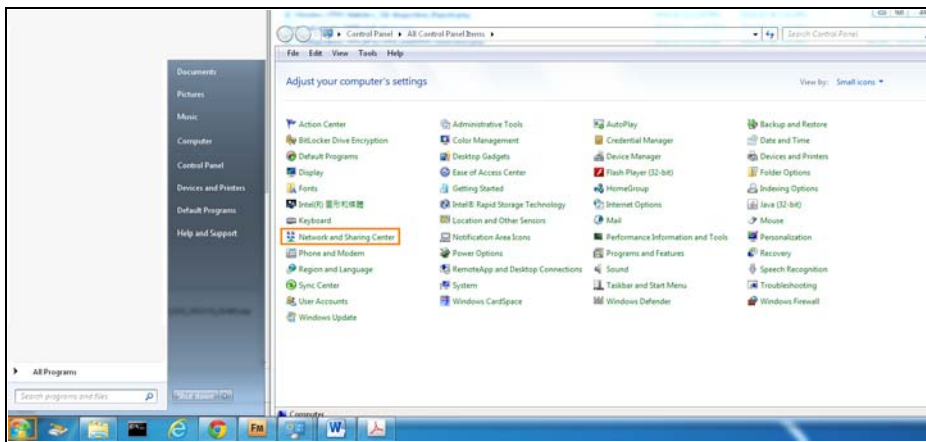

- 2 Click **Change Advanced Sharing Settings**.

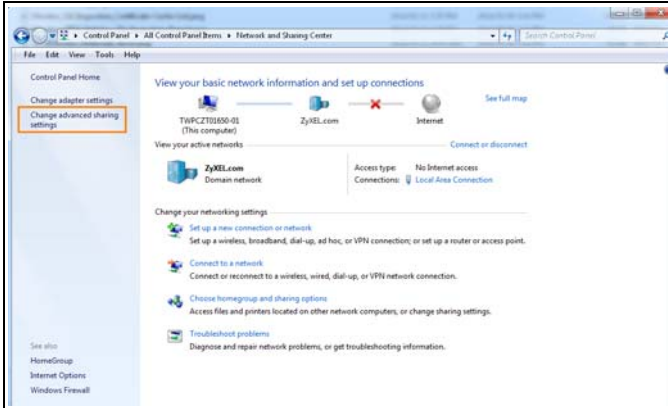

- 3 Select **Turn on network discovery** and click **Save Changes**. Network discovery allows your computer to find other computers and devices on the network and other computers on the network to find your computer. This makes it easier to share files and printers.

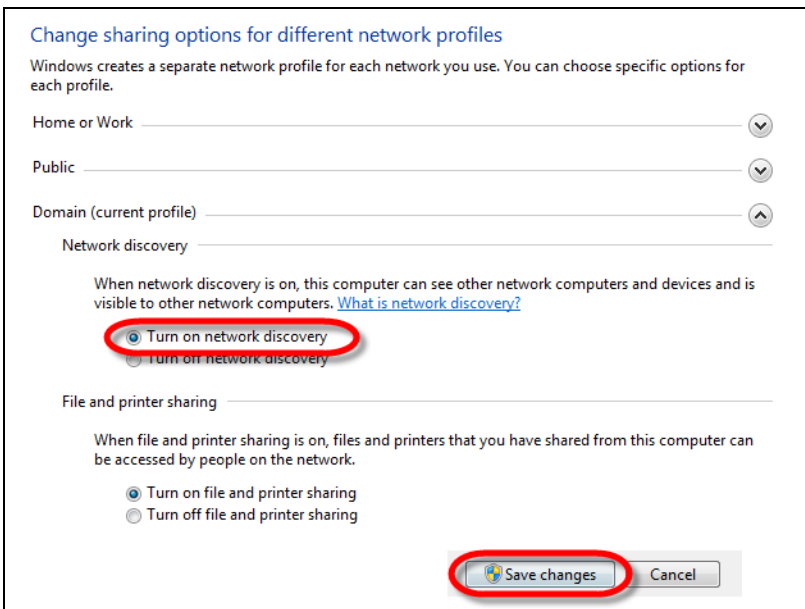

8.6.1 Auto-discover Your UPnP-enabled Network Device

Before you follow these steps, make sure you already have UPnP activated on the Zyxel Device and in your computer.

Make sure your computer is connected to the LAN port of the Zyxel Device.

- 1 Open **Windows Explorer** and click **Network**.
- 2 Right-click the Zyxel Device icon and select **Properties**.

Figure 95 Network Connections

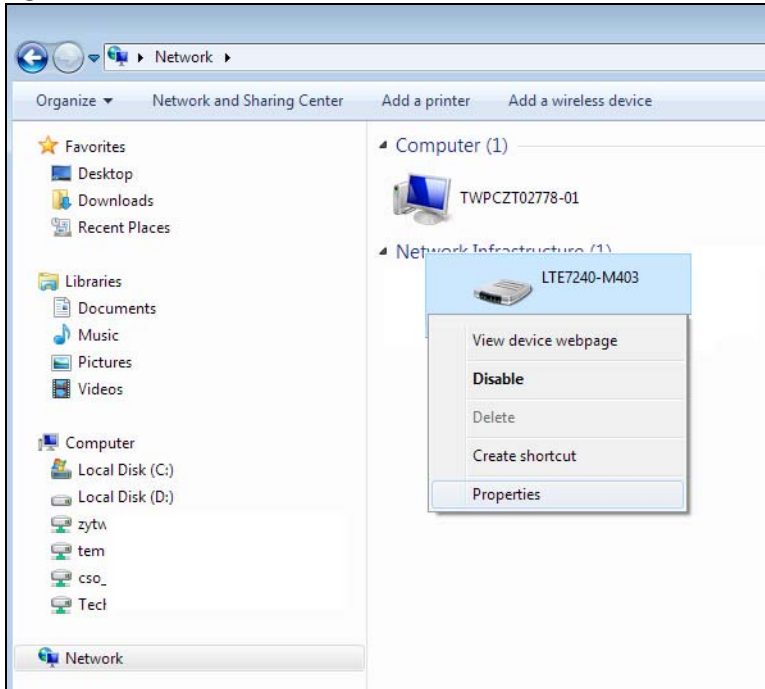

- 3 In the **Internet Connection Properties** window, click **Settings** to see port mappings.

Figure 96 Internet Connection Properties

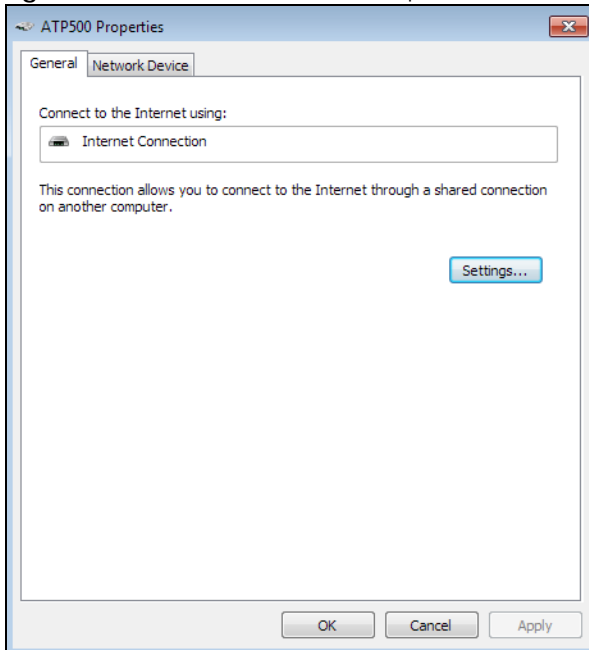

- 4 You may edit or delete the port mappings or click **Add** to manually add port mappings.

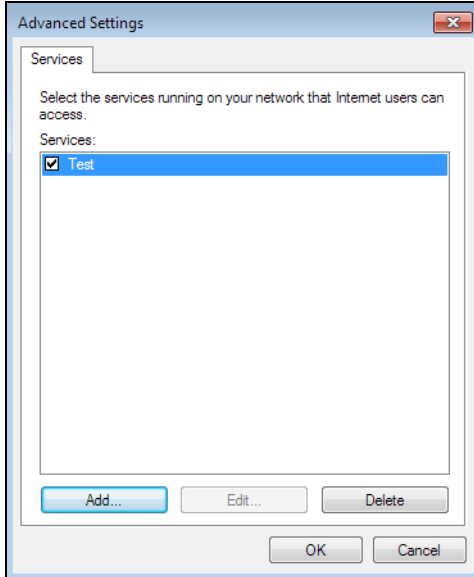
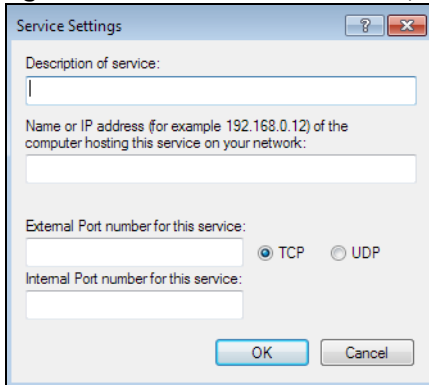
Figure 97 Internet Connection Properties: Advanced Settings**Figure 98** Internet Connection Properties: Advanced Settings: Add

Note: When the UPnP-enabled device is disconnected from your computer, all port mappings will be deleted automatically.

- 5 Click **OK**. Check the network icon on the system tray to see your Internet connection status.

Figure 99 System Tray Icon

- 6 To see more details about your current Internet connection status, right click the network icon in the system tray and click **Open Network and Sharing Center**. Click **Local Area Network**.

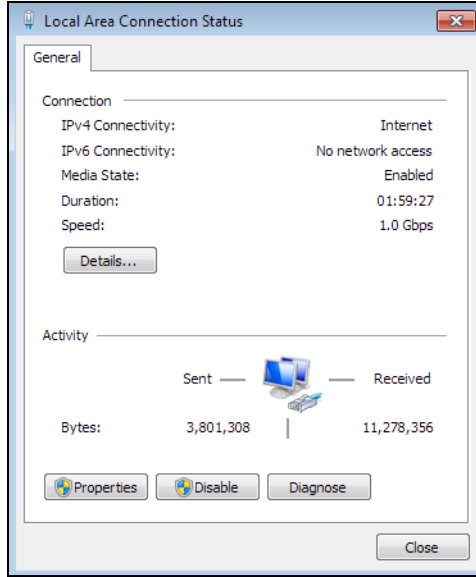
Figure 100 Internet Connection Status

8.7 Turn on UPnP in Windows 10 Example

This section shows you how to use the UPnP feature in Windows 10. UPnP server is installed in Windows 10. Activate UPnP on the Zyxel Device by clicking **Network Setting > Home Networking > UPnP**.

Make sure the computer is connected to the LAN port of the Zyxel Device. Turn on your computer and the Zyxel Device.

- 1 Click the start icon, **Settings** and then **Network & Internet**.

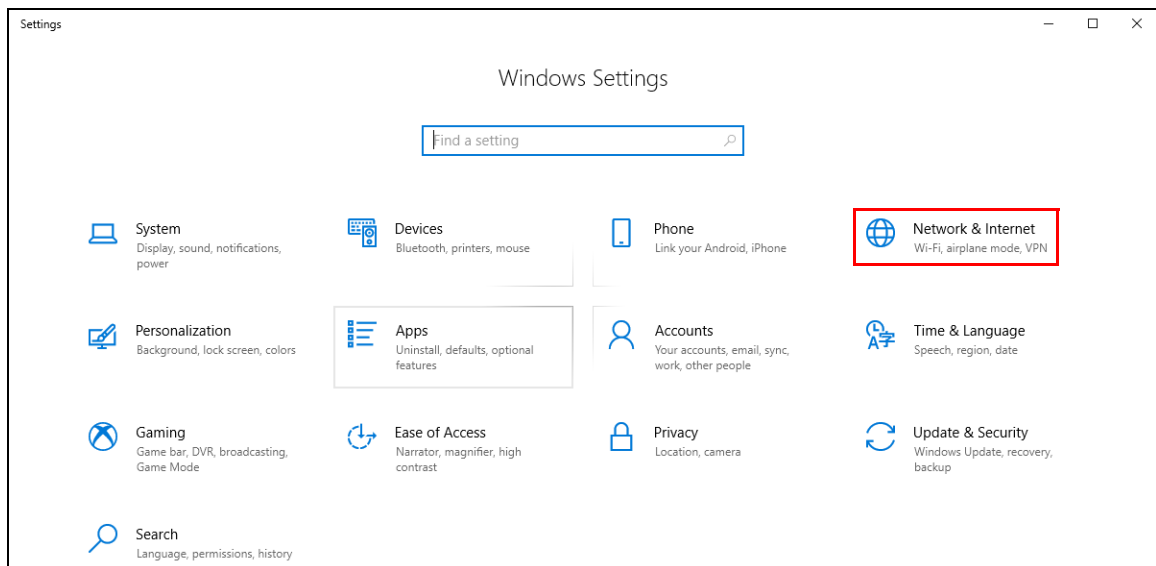

- 2 Click **Network and Sharing Center**.

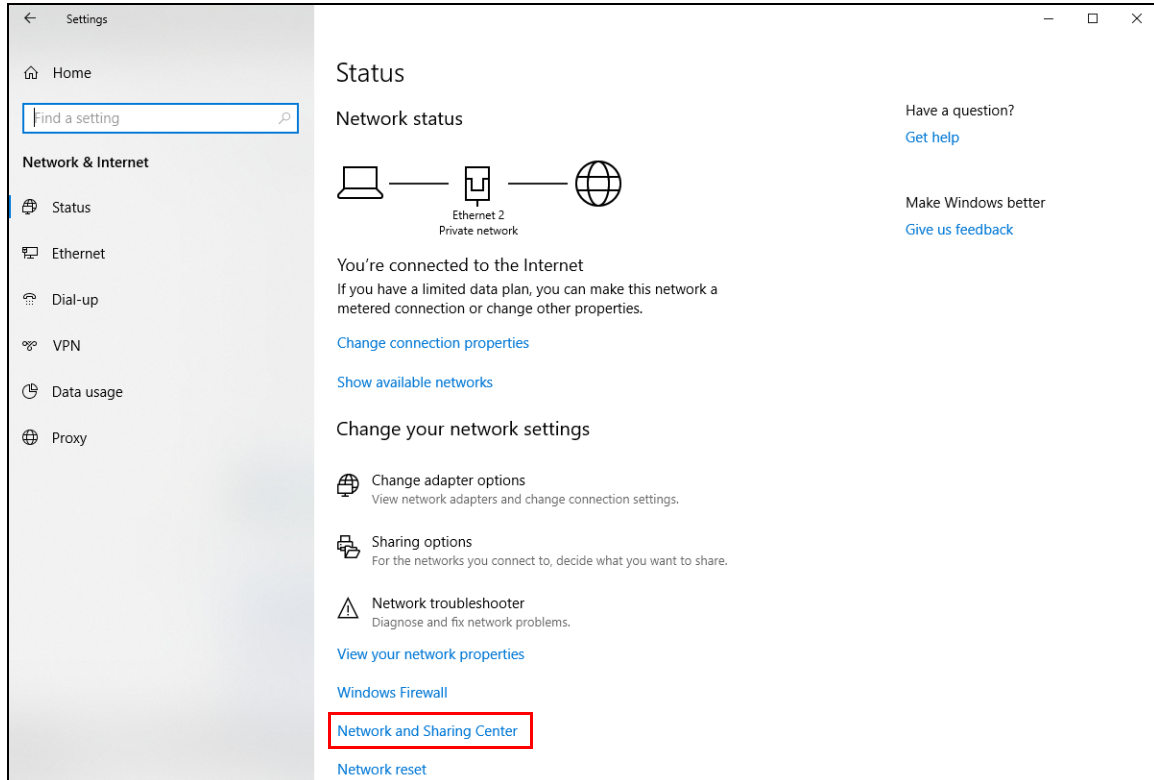

- 3 Click **Change advanced sharing settings**.

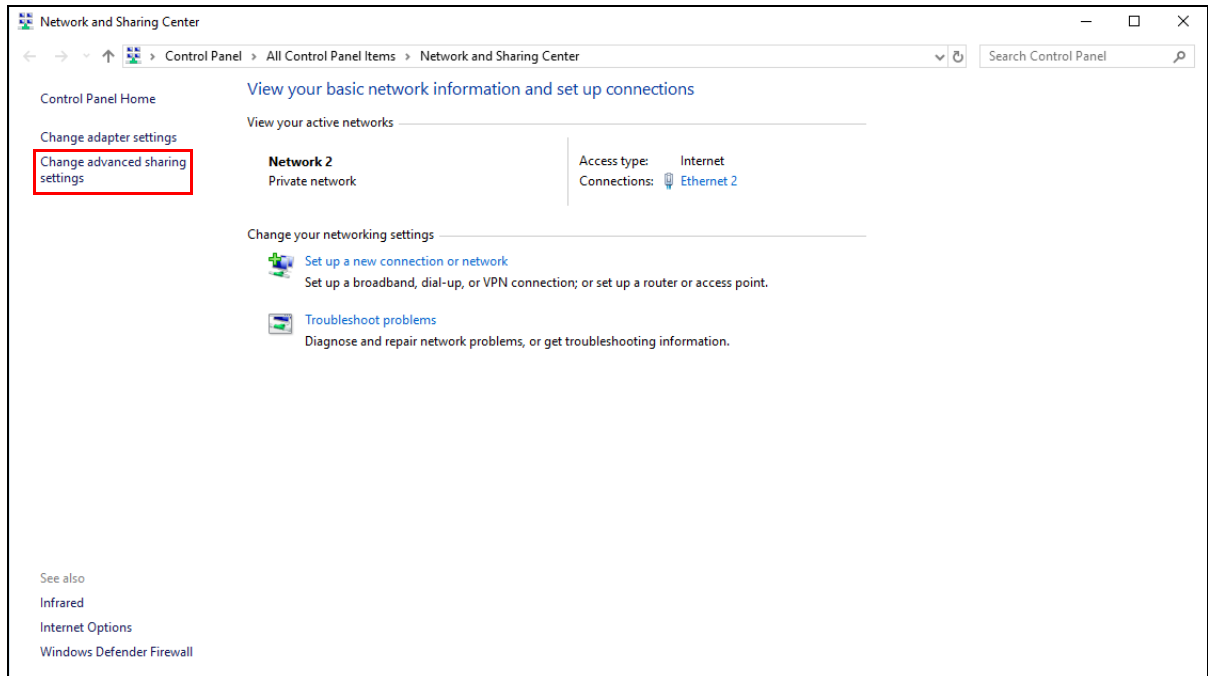

- 4 Under **Domain**, select **Turn on network discovery** and click **Save Changes**. Network discovery allows your computer to find other computers and devices on the network and other computers on the network to find your computer. This makes it easier to share files and printers.

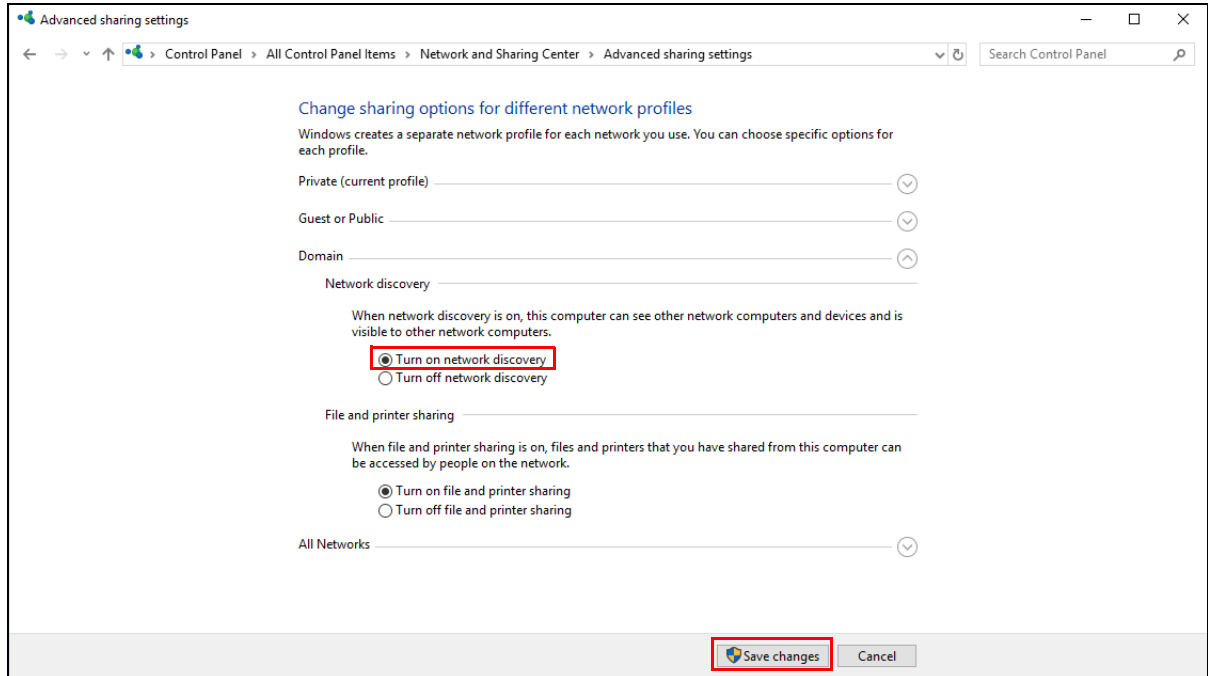

8.7.1 Auto-discover Your UPnP-enabled Network Device

Before you follow these steps, make sure you already have UPnP activated on the Zyxel Device and in your computer.

Make sure your computer is connected to the LAN port of the Zyxel Device.

- 1 Open **File Explorer** and click **Network**.
- 2 Right-click the Zyxel Device icon and select **Properties**.

Figure 101 Network Connections

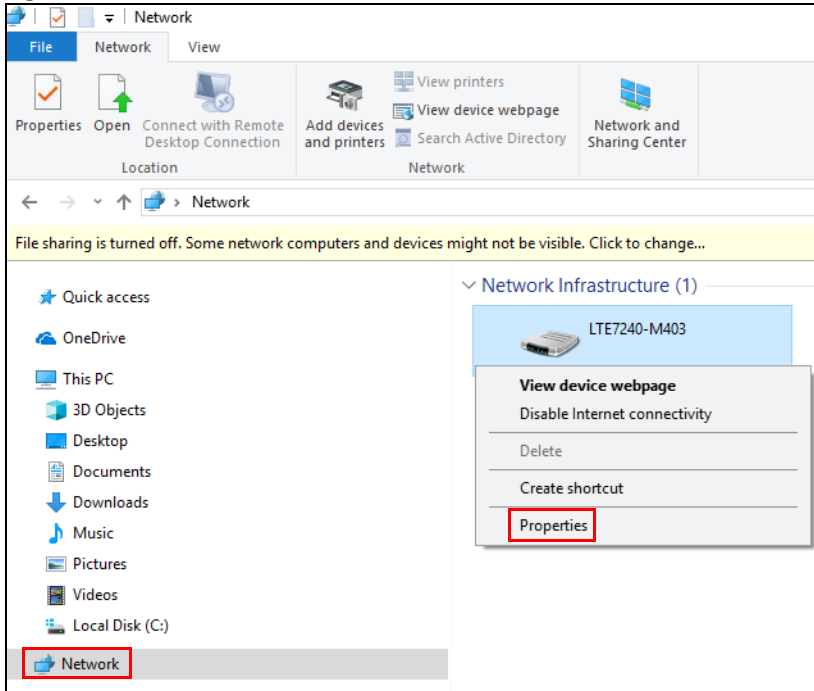

- 3 In the **Internet Connection Properties** window, click **Settings** to see port mappings.

Figure 102 Internet Connection Properties

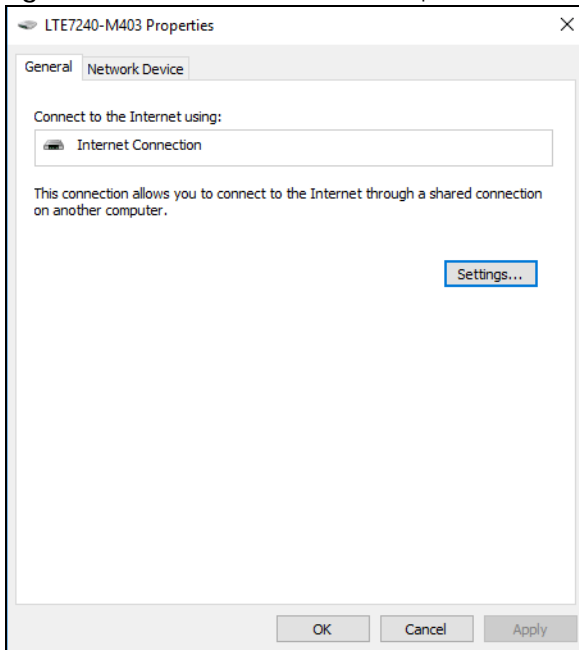

- 4 You may edit or delete the port mappings or click **Add** to manually add port mappings.

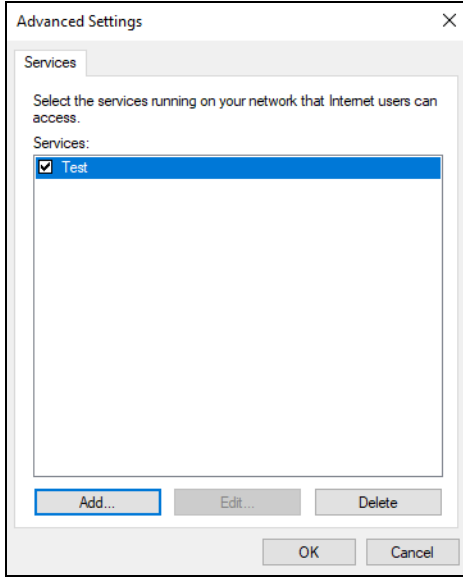
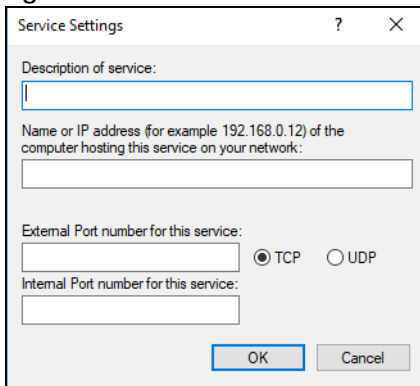
Figure 103 Internet Connection Properties: Advanced Settings**Figure 104** Internet Connection Properties: Advanced Settings: Add

Note: When the UPnP-enabled device is disconnected from your computer, all port mappings will be deleted automatically.

- 5 Click **OK**. Check the network icon on the system tray to see your Internet connection status.

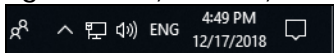
Figure 105 System Tray Icon

- 6 To see more details about your current Internet connection status, right click the network icon in the system tray and click **Open Network & Internet settings**. Click **Network and Sharing Center** and click the **Connections**.

Figure 106 Internet Connection Status

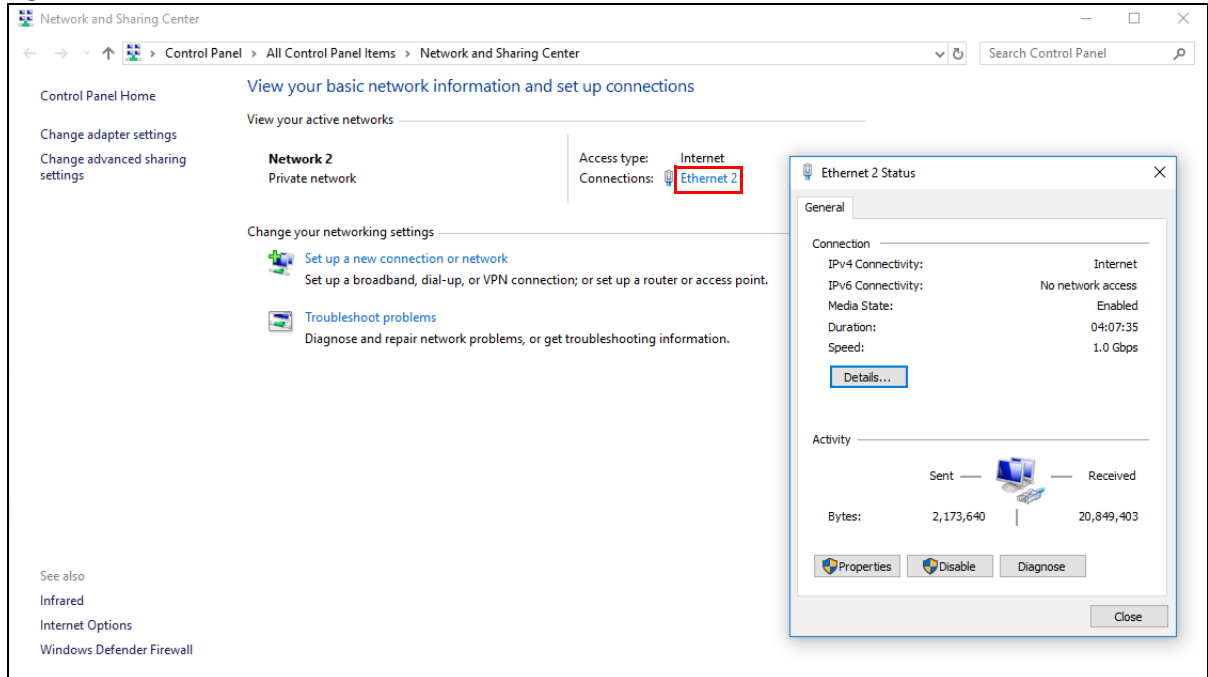

8.8 Web Configurator Easy Access in Windows 7

With UPnP, you can access the Web-based Configurator on the Zyxel Device without needing to find out the IP address of the Zyxel Device first. This comes helpful if you do not know the IP address of the Zyxel Device.

Follow the steps below to access the Web Configurator.

- 1 Open **Windows Explorer**.
- 2 Click **Network**.

Figure 107 Network Connections

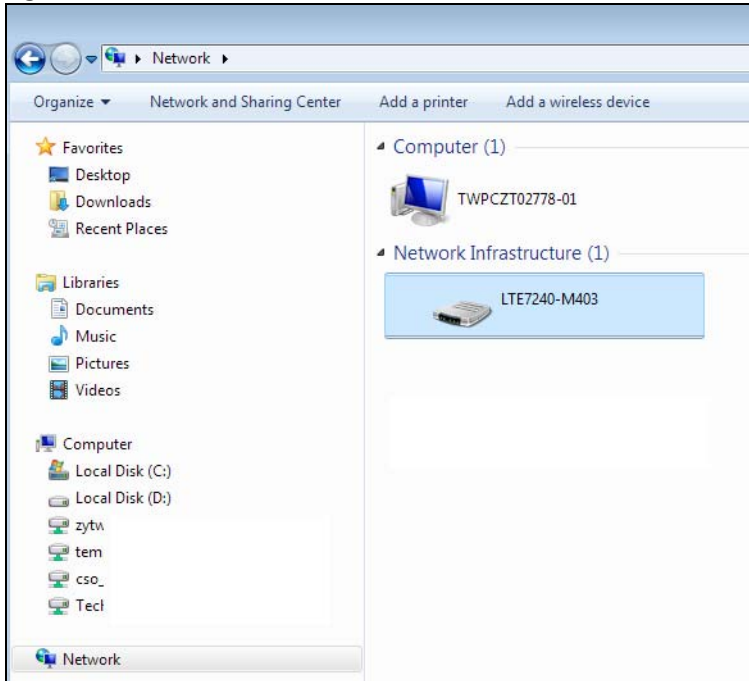

- 3 An icon with the description for each UPnP-enabled device displays under **Network Infrastructure**.
- 4 Right-click the icon for your Zyxel Device and select **View device webpage**. The Web Configurator login screen displays.

Figure 108 Network Connections: My Network Places

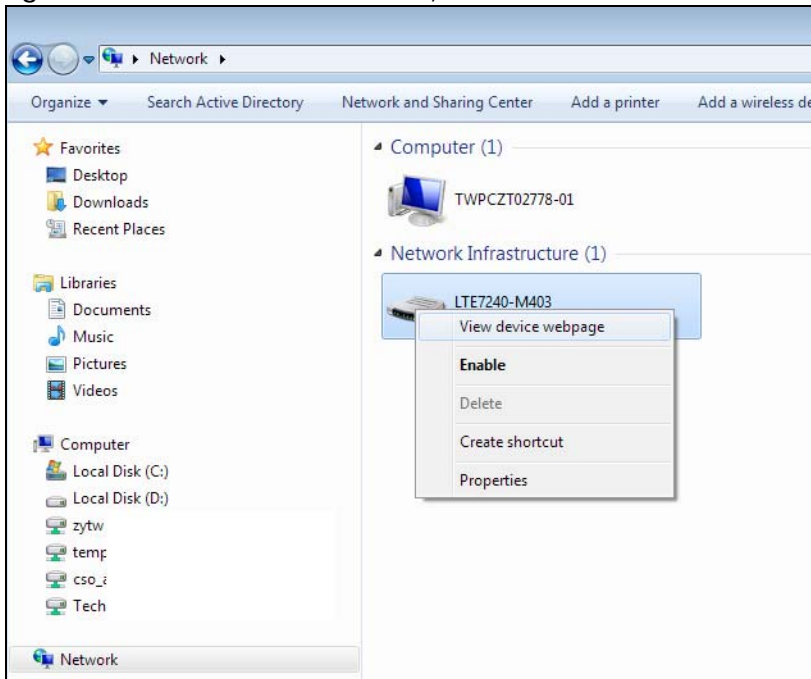

- 5 Right-click the icon for your Zyxel Device and select **Properties**. Click the **Network Device** tab. A window displays with information about the Zyxel Device.

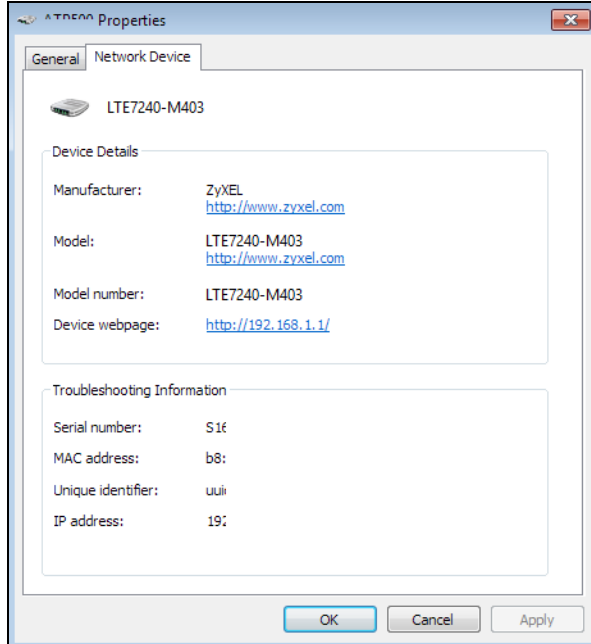
Figure 109 Network Connections: My Network Places: Properties: Example

8.9 Web Configurator Easy Access in Windows 10

Follow the steps below to access the Web Configurator.

- 1 Open **File Explorer**.
- 2 Click **Network**.

Figure 110 Network Connections

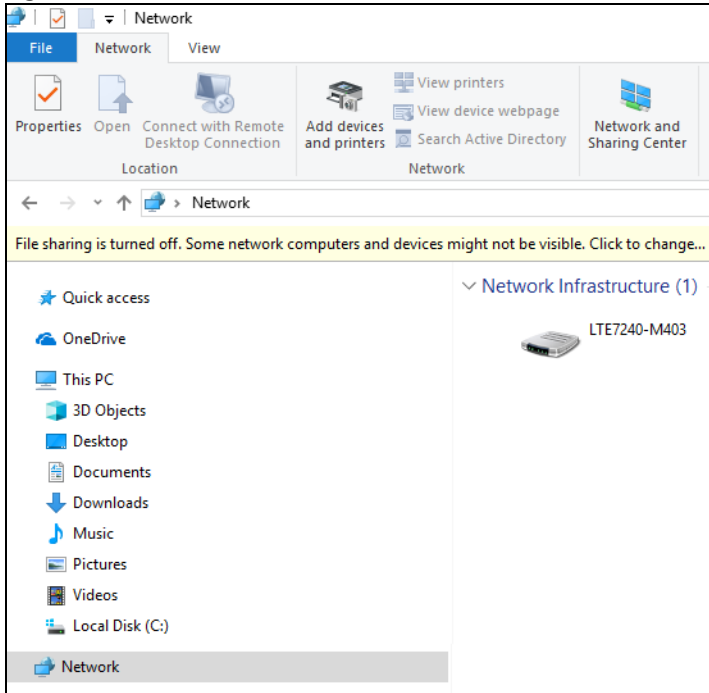

- 3 An icon with the description for each UPnP-enabled device displays under **Network Infrastructure**.
- 4 Right-click the icon for your Zyxel Device and select **View device webpage**. The Web Configurator login screen displays.

Figure 111 Network Connections: Network Infrastructure

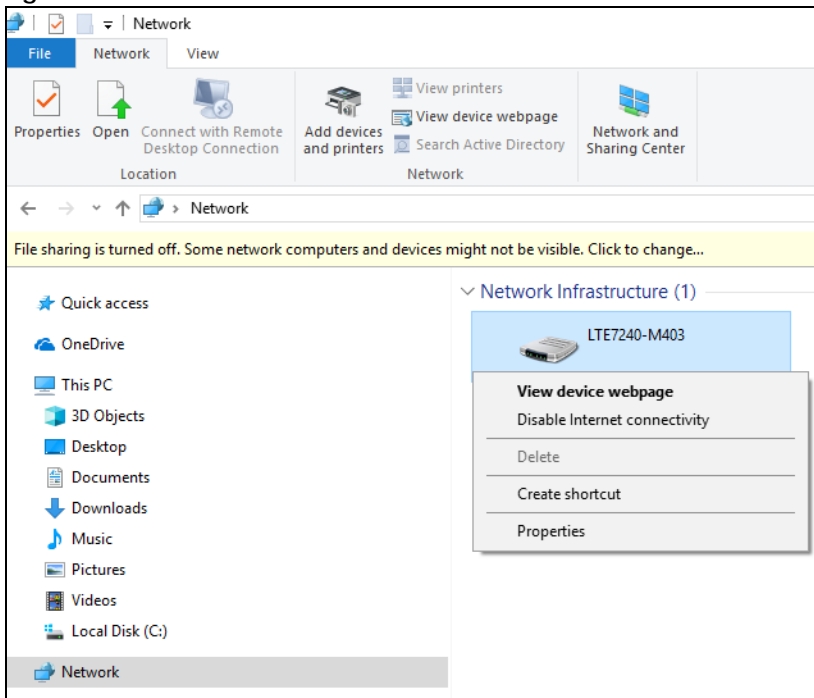

- 5 Right-click the icon for your Zyxel Device and select **Properties**. Click the **Network Device** tab. A window displays information about the Zyxel Device.

Figure 112 Network Connections: Network Infrastructure: Properties: Example

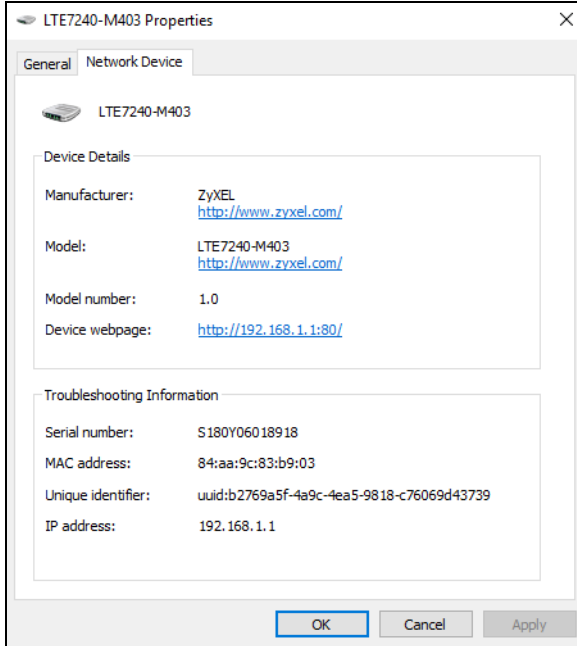

CHAPTER 9

Routing

9.1 Overview

The Zyxel Device usually uses the default gateway to route outbound traffic from computers on the LAN to the Internet. To have the Zyxel Device send data to devices not reachable through the default gateway, use static routes.

For example, the next figure shows a computer (**A**) connected to the Zyxel Device's LAN interface. The Zyxel Device routes most traffic from **A** to the Internet through the Zyxel Device's default gateway (**R1**). You create one static route to connect to services offered by your ISP behind router **R2**. You create another static route to communicate with a separate network behind a router **R3** connected to the LAN.

Figure 113 Example of Static Routing Topology

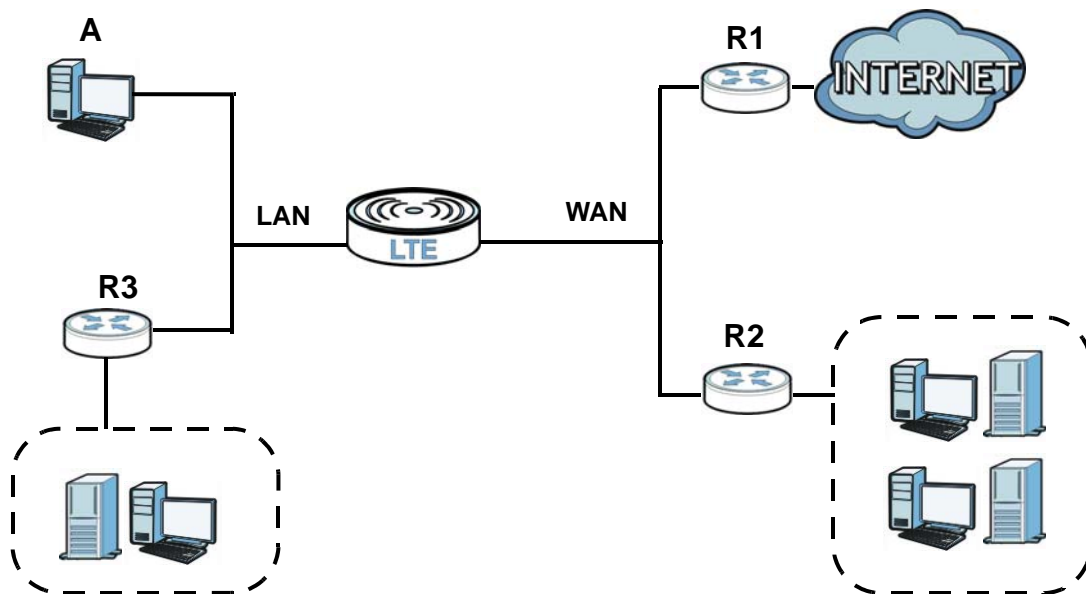

9.2 Configure Static Route

Use this screen to view and configure static route rules on the Zyxel Device. A static route is used to save time and bandwidth usage when LAN devices within an Intranet are transferring files or packets, especially when there are more than two Internet connections in your home or office network. Click **Network Setting > Routing** to open the **Static Route** screen.

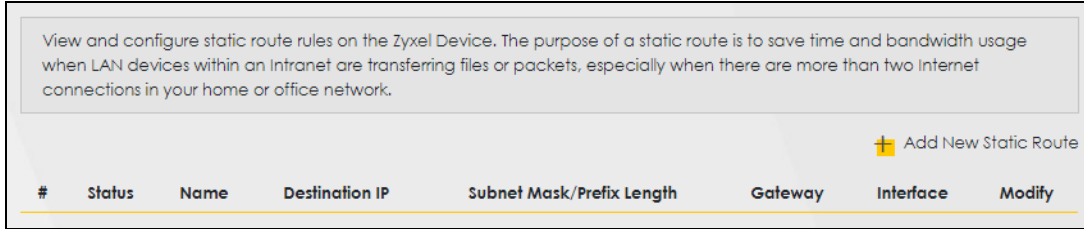
Figure 114 Network Setting > Routing > Static Route

The following table describes the labels in this screen.

Table 45 Network Setting > Routing > Static Route

LABEL	DESCRIPTION
Add New Static Route	Click this to set up a new static route on the Zyxel Device.
#	This is the number of an individual static route.
Status	This field indicates whether the rule is active (yellow bulb) or not (gray bulb).
Name	This is the name of the static route.
Destination IP	This parameter specifies the IP network address of the final destination. Routing is always based on network number.
Subnet Mask/Prefix Length	This parameter specifies the IP network subnet mask of the final destination.
Gateway	This is the IP address of the gateway. The gateway is a router or switch on the same network segment as the Zyxel Device's LAN or WAN port. The gateway helps forward packets to their destinations.
Interface	This is the WAN interface through which the traffic is routed.
Modify	Click the Edit icon to go to the screen where you can set up a static route on the Zyxel Device. Click the Delete icon to remove a static route from the Zyxel Device.

9.2.1 Add/Edit Static Route

Click **Add New Static Route** in the **Static Route** screen, the following screen appears. Configure the required information for a static route.

Note: The **Gateway IP Address** must be within the range of the selected interface in **Use Interface**.

Figure 115 Network Setting > Routing > Static Route > Add New Static Route

The following table describes the labels in this screen.

Table 46 Network Setting > Routing > Static Route > Add New Static Route

LABEL	DESCRIPTION
Active	Select Enable to activate your static route.
Route Name	Assign a name for your static route (up to 15 characters). Special characters are allowed except the following: double quote (") back quote (`) apostrophe or single quote (') less than (<) greater than (>) caret or circumflex accent (^) dollar sign (\$) vertical bar () ampersand (&) semicolon (;)
IP Type	Select between IPv4 or IPv6 . Compared to IPv4 , IPv6 (Internet Protocol version 6), is designed to enhance IP address size and features. The increase in IPv6 address size to 128 bits (from the 32-bit IPv4 address) allows up to 3.4 x 10 ³⁸ IP addresses. The Zyxel Device can use IPv4/IPv6 dual stack to connect to IPv4 and IPv6 networks, and supports IPv6 rapid deployment (6RD).
Destination IP Address	This parameter specifies the IP network address of the final destination. Routing is always based on network number. If you need to specify a route to a single host, use a subnet mask of 255.255.255.255 in the subnet mask field to force the network number to be identical to the host ID.
IP Subnet Mask	Enter the IP subnet mask here.
Use Gateway IP Address	Select Enable to enable forwarding packets to a gateway IP address or a bound interface.
Gateway IP Address	You can decide if you want to forward packets to a gateway IP address or a bound interface. If you want to configure Gateway IP Address , enter the IP address of the next-hop gateway. The gateway is a router or switch on the same network segment as the Zyxel Device's LAN or WAN port. The gateway helps forward packets to their destinations.
Use Interface	You can decide if you want to forward packets to a gateway IP address (Default) or a bound interface (Cellular WAN). If you want to configure bound interface, choose an interface through which the traffic is sent. You must have the WAN interfaces already configured in the Broadband screen.
OK	Click this to save your changes.
Cancel	Click this to exit this screen without saving.

9.3 DNS Route

Use this screen to view and configure DNS routes on the Zyxel Device. A DNS route entry defines a policy for the Zyxel Device to forward a particular DNS query to a specific WAN interface. Click **Network Setting > Routing > DNS Route** to open the **DNS Route** screen.

Figure 116 Network Setting > Routing > DNS Route

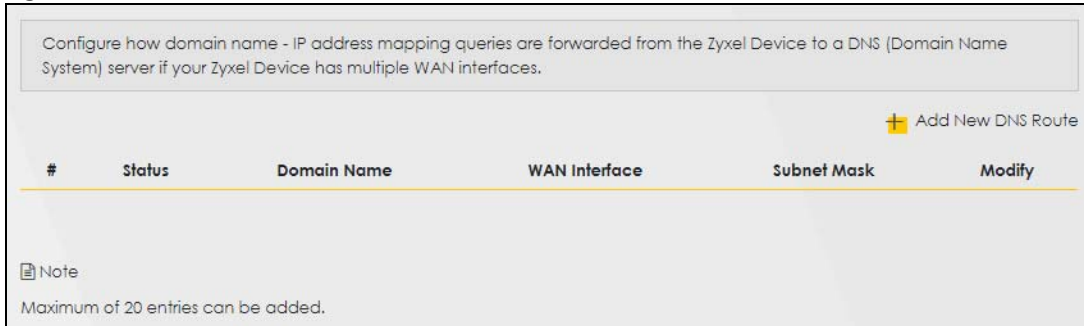

The following table describes the labels in this screen.

Table 47 Network Setting > Routing > DNS Route

LABEL	DESCRIPTION
Add New DNS Route	Click this to create a new entry.
#	This is the number of an individual DNS route.
Status	This field indicates whether the rule is active (yellow bulb) or not (gray bulb).
Domain Name	This is the domain name to which the DNS route applies.
WAN Interface	This is the WAN interface through which the matched DNS request is routed.
Subnet Mask	This parameter specifies the IP network subnet mask.
Modify	Click the Edit icon to configure a DNS route on the Zyxel Device. Click the Delete icon to remove a DNS route from the Zyxel Device.

9.3.1 Add/Edit DNS Route

Click **Add New DNS Route** in the **DNS Route** screen, use this screen to configure the required information for a DNS route.

Figure 117 Network Setting > Routing > DNS Route > Add New DNS Route

The following table describes the labels in this screen.

Table 48 Network Setting > Routing > DNS Route > Add New DNS Route

LABEL	DESCRIPTION
Active	Enable DNS route in your Zyxel Device.
Domain Name	Enter the domain name you want to resolve. You can use the wildcard character, an "*" (asterisk) as the left most part of a domain name, such as *.example.com. The Zyxel Device forwards DNS queries for any domain name ending in example.com to the WAN interface specified in this route.
Subnet Mask	Type the subnet mask of the network for which to use the DNS route in dotted decimal notation, for example 255.255.255.255.
WAN Interface	Select a WAN interface through which the matched DNS query is sent. You must have the WAN interface(s) already configured in the Broadband screen.
OK	Click this to save your changes.
Cancel	Click this to exit this screen without saving.

9.4 Policy Route

By default, the Zyxel Device routes packets based on the shortest path to the destination address. Policy routes allow you to override the default behavior and route packets based on other criteria, such as the source address. For example, you can use policy-based routing to direct traffic from specific users through specific connections or distribute traffic across multiple paths for load sharing. Policy-based routing is applied to outgoing packets before the default routing rules are applied.

The **Policy Route** screen let you view and configure routing policies on the Zyxel Device. Click **Network Setting > Routing > Policy Route** to open the following screen.

Figure 118 Network Setting > Routing > Policy Route

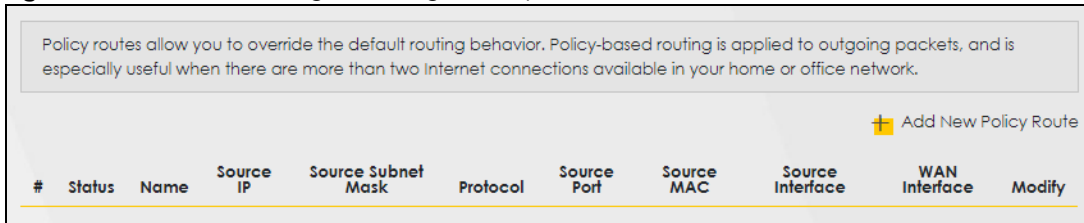

The following table describes the labels in this screen.

Table 49 Network Setting > Routing > Policy Route

LABEL	DESCRIPTION
Add New Policy Route	Click this to create a new policy forwarding rule.
#	This is the index number of the entry.
Status	This field displays whether the DNS route is active or not. A yellow bulb signifies that this DNS route is active. A gray bulb signifies that this DNS route is not active.
Name	This is the name of the rule.
Source IP	This is the source IP address.
Source Subnet Mask	This is the source subnet mask address.
Protocol	This is the transport layer protocol.
Source Port	This is the source port number.
Source MAC	This is the source MAC address.
Source Interface	This is the interface from which the matched traffic is sent.
WAN Interface	This is the WAN interface through which the traffic is routed.
Modify	Click the Edit icon to edit this policy. Click the Delete icon to remove a policy from the Zyxel Device. A window displays asking you to confirm that you want to delete the policy.

9.4.1 Add/Edit Policy Route

Click **Add New Policy Route** in the **Policy Route** screen or click the **Edit** icon next to a policy. Use this screen to configure the required information for a policy route.

Figure 119 Policy Route: Add/Edit

The following table describes the labels in this screen.

Table 50 Policy Route: Add/Edit

LABEL	DESCRIPTION
Active	Click this to enable (turns blue) activation of the policy route. Otherwise, click to disable (turns gray).
Route Name	Enter a descriptive name of up to 8 printable English keyboard characters, not including spaces.
Source IP Address	Enter the source IP address.
Source Subnet Mask	Enter the source subnet mask address.
Protocol	Select the transport layer protocol (TCP, UDP, or None).
Source Port	Enter the source port number.
Source MAC	Enter the source MAC address.
Source Interface (ex: br0 or LAN1~LAN4)	Type the name of the interface from which the matched traffic is sent.
WAN Interface	Select a WAN interface through which the traffic is sent. You must have the WAN interface(s) already configured in the Broadband screens.
Cancel	Click Cancel to exit this screen without saving.
OK	Click OK to save your changes.

9.5 RIP Overview

Routing Information Protocol (RIP, RFC 1058 and RFC 1389) allows the Zyxel Device to exchange routing information with other routers. To activate RIP for the WAN interface, select the supported RIP version and operation.

9.5.1 RIP

Click **Network Setting > Routing > RIP** to open the **RIP** screen. Select the desired RIP version and operation by clicking the check box. To stop RIP on the WAN interface, clear the check box. Click the **Apply** button to start/stop RIP and save the configuration.

Figure 120 Network Setting > Routing > RIP

#	Interface	Version	Operation	Enable	Disable Default Gateway
1	Cellular WAN	RIPv2	Active	<input type="checkbox"/>	<input type="checkbox"/>
2	ETHWAN	RIPv2	Active	<input type="checkbox"/>	<input type="checkbox"/>

The following table describes the labels in this screen.

Table 51 Network Setting > Routing > RIP

LABEL	DESCRIPTION
#	This is the index of the interface in which the RIP setting is used.
Interface	This is the name of the interface in which the RIP setting is used.
Version	The RIP version controls the format and the broadcasting method of the RIP packets that the Zyxel Device sends (it recognizes both formats when receiving). RIPv1 is universally supported but RIPv2 carries more information. RIPv1 is probably adequate for most networks, unless you have an unusual network topology. When set to Both , the Zyxel Device will broadcast its routing table periodically and incorporate the RIP information that it receives
Operation	Select Passive to have the Zyxel Device update the routing table based on the RIP packets received from neighbors but not advertise its route information to other routers in this interface. Select Active to have the Zyxel Device advertise its route information and also listen for routing updates from neighboring routers.
Enable	Select the check box to activate the settings.
Disable Default Gateway	Select the check box to set the Zyxel Device to not send the route information to the default gateway.
Cancel	Click Cancel to exit this screen without saving.
Apply	Click Apply to save your changes back to the Zyxel Device.

CHAPTER 10

Network Address Translation (NAT)

10.1 Overview

NAT (Network Address Translation - NAT, RFC 1631) is the translation of the IP address of a host in a packet, for example, the source address of an outgoing packet, used within one network to a different IP address known within another network.

10.1.1 What You Can Do in this Chapter

- Use the **Port Forwarding** screen to configure forward incoming service requests to the servers on your local network ([Section 10.2 on page 163](#)).
- Use the **Port Triggering** screen to add and configure the Zyxel Device's trigger port settings ([Section 10.3 on page 166](#)).
- Use the **DMZ** screen to configure a default server ([Section 10.4 on page 169](#)).
- Use the **ALG** screen to enable or disable the SIP ALG ([Section 10.5 on page 170](#)).
- Use the **Address Mapping** screen to enable and disable the NAT Address Mapping in the Zyxel Device([Section 10.6 on page 171](#)).
- Use the **Sessions** screen to limit the number of concurrent NAT sessions each client can use([Section 10.7 on page 173](#)).

10.1.2 What You Need To Know

The following terms and concepts may help as you read this chapter.

Inside/Outside and Global/Local

Inside/outside denotes where a host is located relative to the Zyxel Device, for example, the computers of your subscribers are the inside hosts, while the web servers on the Internet are the outside hosts.

Global/local denotes the IP address of a host in a packet as the packet traverses a router, for example, the local address refers to the IP address of a host when the packet is in the local network, while the global address refers to the IP address of the host when the same packet is traveling in the WAN side.

NAT

In the simplest form, NAT changes the source IP address in a packet received from a subscriber (the inside local address) to another (the inside global address) before forwarding the packet to the WAN side. When the response comes back, NAT translates the destination address (the inside global address) back to the inside local address before forwarding it to the original inside host.

Port Forwarding

A port forwarding set is a list of inside (behind NAT on the LAN) servers, for example, web or FTP, that you can make visible to the outside world even though NAT makes your whole inside network appear as a single computer to the outside world.

10.2 Port Forwarding Overview

Use **Port Forwarding** to forward incoming service requests from the Internet to the server(s) on your local network. Port forwarding is commonly used when you want to host online gaming, P2P file sharing, or other servers on your network.

You may enter a single port number or a range of port numbers to be forwarded, and the local IP address of the desired server. The port number identifies a service; for example, web service is on port 80 and FTP on port 21. In some cases, such as for unknown services or where one server can support more than one service (for example both FTP and web service), it might be better to specify a range of port numbers. You can allocate a server IP address that corresponds to a port or a range of ports. Please refer to RFC 1700 for further information about port numbers.

Note: Many residential broadband ISP accounts do not allow you to run any server processes (such as a Web or FTP server) from your location. Your ISP may periodically check for servers and may suspend your account if it discovers any active services at your location. If you are unsure, refer to your ISP.

Configure Servers Behind Port Forwarding (Example)

Let's say you want to assign ports 21-25 to one FTP, Telnet and SMTP server (**A** in the example), port 80 to another (**B** in the example), a default server IP address of 192.168.1.35 to a third (**C** in the example), and a default server IP address of 192.168.1.36 to a fourth (**D** in the example). You assign the LAN IP addresses and the ISP assigns the WAN IP address. The NAT network appears as a single host on the Internet.

Figure 121 Multiple Servers Behind NAT Example

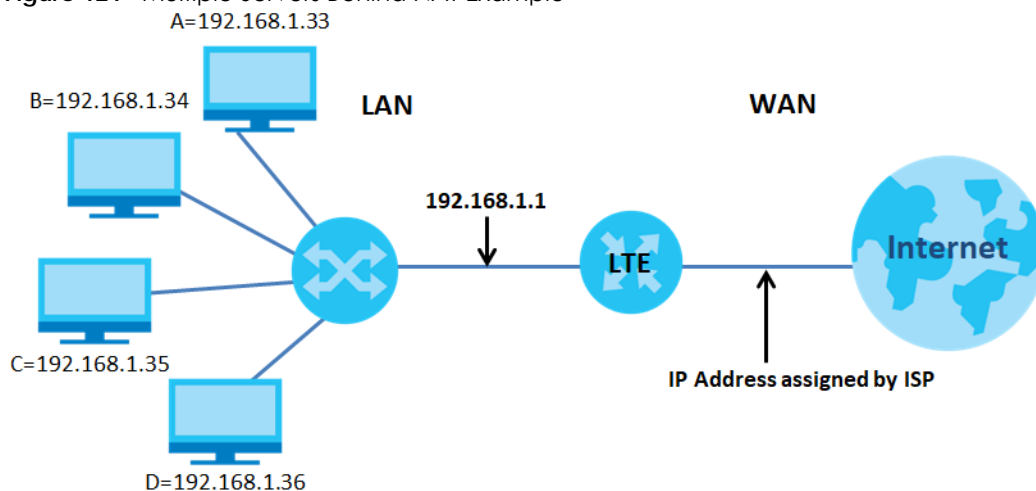

10.2.1 Port Forwarding

Click **Network Setting** > **NAT** to open the **Port Forwarding** screen.

Note: TCP port 7547 is reserved for system use.

Figure 122 Network Setting > NAT > Port Forwarding

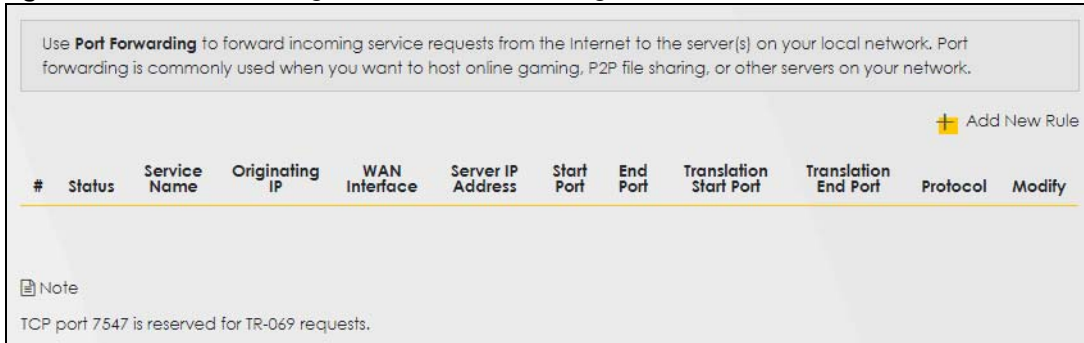

The following table describes the fields in this screen.

Table 52 Network Setting > NAT > Port Forwarding

LABEL	DESCRIPTION
Add New Rule	Click this to add a new port forwarding rule.
#	This is the index number of the entry.
Status	This field indicates whether the rule is active or not. A yellow bulb signifies that this rule is active. A gray bulb signifies that this rule is not active.
Service Name	This is the service's name. This shows User Defined if you manually added a service. You can change this by clicking the edit icon.
Originating IP	This is the source's IP address.
WAN Interface	Select the WAN interface for which to configure NAT port forwarding rules.
Server IP Address	This is the server's IP address.
Start Port	This is the first external port number that identifies a service.
End Port	This is the last external port number that identifies a service.
Translation Start Port	This is the first internal port number that identifies a service.
Translation End Port	This is the last internal port number that identifies a service.
Protocol	This field displays the protocol (TCP, UDP, TCP+UDP) used to transport the packets for which you want to apply the rule.
Modify	Click the Edit icon to edit the port forwarding rule. Click the Delete icon to delete an existing port forwarding rule. Note that subsequent address mapping rules move up by one when you take this action.

10.2.2 Add/Edit Port Forwarding

Create or edit a port forwarding rule. Specify either a port or a range of ports, a server IP address, and a protocol to configure a port forwarding rule. Click **Add New Rule** in the **Port Forwarding** screen or the **Edit** icon next to an existing rule to open the following screen.

Figure 123 Port Forwarding: Add/Edit

Add New Rule

Active

Service Name

WAN Interface

Start Port

End Port

Translation Start Port

Translation End Port

Server IP Address

Configure Originating IP Enable

Originating IP

Protocol

Note

(1) Create or edit a port forwarding rule. Specify either a port or a range of ports, a server IP address, and a protocol to configure a port forwarding rule.

(2) To configure port forwarding, you need to have the same configurations in the **Start Port**, **End Port**, **Translation Start Port**, and **Translation End Port** fields.
To configure port translation, you need to have different configurations in the **Start Port**, **End Port**, **Translation Start Port**, and **Translation End Port** fields.

(3) TCP port 7547 is reserved for system use.

Cancel OK

Note: To configure port forwarding, you need to have the same configurations in the **Start Port**, **End Port**, **Translation Start Port**, and **Translation End Port** fields.
To configure port translation, you need to have different configurations in the **Start Port**, **End Port**, **Translation Start Port**, and **Translation End Port** fields.
Here is an example to configure port translation. Configure **Start Port** to 100, **End Port** to 120, **Translation Start Port** to 200, and **Translation End Port** to 220.

Note: TCP port 7547 is reserved for system use.

The following table describes the labels in this screen.

Table 53 Port Forwarding: Add/Edit

LABEL	DESCRIPTION
Active	Select or clear this field to turn the port forwarding rule on or off.
Service Name	Select a service to forward or select User Defined and enter a name in the field to the right.
WAN Interface	Select the WAN interface for which to configure NAT port forwarding rules.

Table 53 Port Forwarding: Add/Edit (continued)

LABEL	DESCRIPTION
Start Port	Configure this for a user-defined entry. Enter the original destination port for the packets. To forward only one port, enter the port number again in the End Port field. To forward a series of ports, enter the start port number here and the end port number in the End Port field.
End Port	Configure this for a user-defined entry. Enter the last port of the original destination port range. To forward only one port, enter the port number in the Start Port field above and then enter it again in this field. To forward a series of ports, enter the last port number in a series that begins with the port number in the Start Port field above.
Translation Start Port	Configure this for a user-defined entry. This shows the port number to which you want the Zyxel Device to translate the incoming port. For a range of ports, enter the first number of the range to which you want the incoming ports translated.
Translation End Port	Configure this for a user-defined entry. This shows the last port of the translated port range.
Server IP Address	Enter the inside IP address of the virtual server here.
Configure Originating IP	Click the Enable check box to enter the originating IP in the next field.
Originating IP	Enter the originating IP address here.
Protocol	Select the protocol supported by this virtual server. Choices are TCP , UDP , or TCP/UDP .
OK	Click this to save your changes.
Cancel	Click this to exit this screen without saving.

10.3 Port Triggering

Some services use a dedicated range of ports on the client side and a dedicated range of ports on the server side. With regular port forwarding, you set a forwarding port in NAT to forward a service (coming in from the server on the WAN) to the IP address of a computer on the client side (LAN). The problem is that port forwarding only forwards a service to a single LAN IP address. In order to use the same service on a different LAN computer, you have to manually replace the LAN computer's IP address in the forwarding port with another LAN computer's IP address.

Trigger port forwarding allows computers on the LAN to dynamically take turns using the service.

The Zyxel Device records the IP address of a LAN computer that sends traffic to the WAN to request a service with a specific port number and protocol (a \"trigger\" port). When the Zyxel Device's WAN port receives a response with a specific port number and protocol (\"open\" port), the Zyxel Device forwards the traffic to the LAN IP address of the computer that sent the request. After that computer's connection for that service closes, another computer on the LAN can use the service in the same manner. This way you do not need to configure a new IP address each time you want a different LAN computer to use the application.

For example:

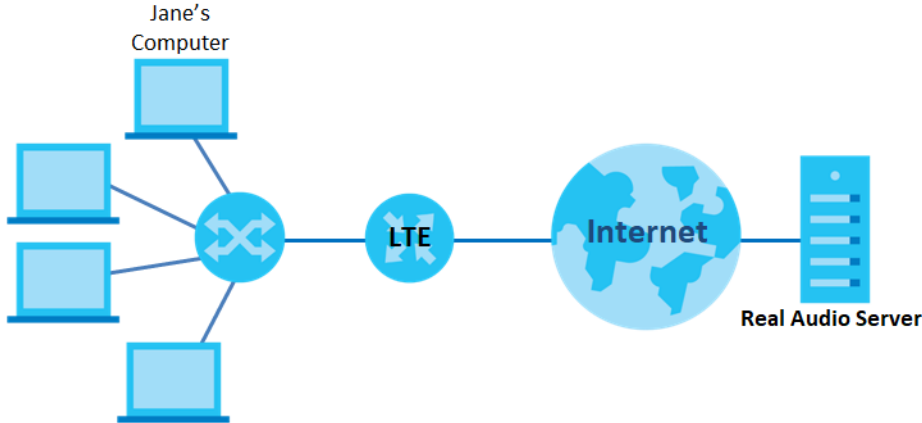
Figure 124 Trigger Port Forwarding Process: Example

- 1 Jane requests a file from the Real Audio server (port 7070).
- 2 Port 7070 is a "trigger" port and causes the Zyxel Device to record Jane's computer IP address. The Zyxel Device associates Jane's computer IP address with the "open" port range of 6970-7170.
- 3 The Real Audio server responds using a port number ranging between 6970-7170.
- 4 The Zyxel Device forwards the traffic to Jane's computer IP address.
- 5 Only Jane can connect to the Real Audio server until the connection is closed or times out. The Zyxel Device times out in three minutes with UDP (User Datagram Protocol) or two hours with TCP/IP (Transfer Control Protocol/Internet Protocol).

Click **Network Setting > NAT > Port Triggering** to open the following screen. Use this screen to view your Zyxel Device's trigger port settings.

Note: TCP port 7547 is reserved for system use.

Note: The sum of trigger ports in all rules must be less than 1000 and every open port range must be less than 1000. When the protocol is TCP/UDP, the ports are counted twice.

Figure 125 Network Setting > NAT > Port Triggering

Unlike port forwarding that only forwards a service to a single LAN IP address, trigger port forwarding allows computers on the LAN to dynamically take turns using a service. Doing away the need to configure a new IP address each time you want a different LAN computer to use a service.

+ Add New Rule

#	Status	Service Name	WAN Interface	Trigger Start Port	Trigger End Port	Trigger Proto.	Open Start Port	Open End Port	Open Protocol	Modify
<p>Note</p> <p>(1) The TCP port 7547 is reserved for system usage.</p> <p>(2) The maximum number of trigger ports for a single rule or all rules is 999. The maximum number of open ports for a single rule or all rules is 999.</p>										

The following table describes the labels in this screen.

Table 54 Network Setting > NAT > Port Triggering

LABEL	DESCRIPTION
Add New Rule	Click this to create a new rule.
#	This is the index number of the entry.
Status	This field displays whether the port triggering rule is active or not. A yellow bulb signifies that this rule is active. A gray bulb signifies that this rule is not active.
Service Name	This field displays the name of the service used by this rule.
WAN Interface	This field shows the WAN interface through which the service is forwarded.
Trigger Start Port	The trigger port is a port (or a range of ports) that causes (or triggers) the Zyxel Device to record the IP address of the LAN computer that sent the traffic to a server on the WAN. This is the first port number that identifies a service.
Trigger End Port	This is the last port number that identifies a service.
Trigger Proto.	This is the trigger transport layer protocol.
Open Start Port	The open port is a port (or a range of ports) that a server on the WAN uses when it sends out a particular service. The Zyxel Device forwards the traffic with this port (or range of ports) to the client computer on the LAN that requested the service. This is the first port number that identifies a service.
Open End Port	This is the last port number that identifies a service.
Open Protocol	This is the open transport layer protocol.
Modify	Click the Edit icon to edit this rule. Click the Delete icon to delete an existing rule.

10.3.1 Add/Edit Port Triggering Rule

This screen lets you create new port triggering rules. Click **Add New Rule** in the **Port Triggering** screen or click a rule's **Edit** icon to open the following screen. Use this screen to configure a port or range of ports and protocols for sending out requests and for receiving responses.

Figure 126 Port Triggering: Add/Edit

The following table describes the labels in this screen.

Table 55 Port Triggering: Add/Edit

LABEL	DESCRIPTION
Active	Click to enable (blue switch) or disable (gray switch) to activate or deactivate the rule.
Service Name	Enter a name to identify this rule using keyboard characters (A-Z, a-z, 1-2 and so on).
WAN Interface	Select a WAN interface for which you want to configure port triggering rules.
Trigger Start Port	The trigger port is a port (or a range of ports) that causes (or triggers) the Zyxel Device to record the IP address of the LAN computer that sent the traffic to a server on the WAN. Type a port number or the starting port number in a range of port numbers.
Trigger End Port	Type a port number or the ending port number in a range of port numbers.
Trigger Protocol	Select the transport layer protocol from TCP , UDP , or TCP/UDP .
Open Start Port	The open port is a port (or a range of ports) that a server on the WAN uses when it sends out a particular service. The Zyxel Device forwards the traffic with this port (or range of ports) to the client computer on the LAN that requested the service. Type a port number or the starting port number in a range of port numbers.
Open End Port	Type a port number or the ending port number in a range of port numbers.
Open Protocol	Select the transport layer protocol from TCP , UDP , or TCP/UDP .
Cancel	Click Cancel to exit this screen without saving.
OK	Click OK to save your changes.

10.4 DMZ

Use this screen to specify the IP address of a default server to receive packets from ports not specified in the **Port Triggering** screen. The DMZ (DeMilitarized Zone) is a network between the WAN and the LAN that is accessible to devices on both the WAN and LAN with firewall protection. Devices on the WAN

can initiate connections to devices on the DMZ but not to those on the LAN.

You can put public servers, such as email, web, and FTP servers, on the DMZ to provide services on both the WAN and LAN. To use this feature, you first need to assign a DMZ host. Click **Network Setting > NAT > DMZ** to open the **DMZ** screen.

Note: Use an IPv4 address for the DMZ server.

Note: Enter the IP address of the default server in the **Default Server Address** field, and click **Apply** to activate the DMZ host. Otherwise, clear the IP address in the **Default Server Address** field, and click **Apply** to deactivate the DMZ host.

Figure 127 Network Setting > NAT > DMZ

A client in the Demilitarized Zone (DMZ) is no longer behind the Zyxel Device and can therefore run any Internet application such as video conferencing and Internet gaming without restrictions. This, however, may pose a security threat to the Zyxel Device. Use this screen to specify the IP address of a default server to receive packets from ports not specified in the **Port Triggering** screen.

Default Server Address

Note

(1) Use an IPv4 address for the DMZ server.
 (2) Enter the IP address and click **Apply** to activate the DMZ host.
 Otherwise, clear the IP address field and click **Apply** to de-activate the DMZ host.

Cancel **Apply**

The following table describes the fields in this screen.

Table 56 Network Setting > NAT > DMZ

LABEL	DESCRIPTION
Default Server Address	Enter the IP address of the default server which receives packets from ports that are not specified in the Port Forwarding screen. Note: If you do not assign a default server, the Zyxel Device discards all packets received for ports not specified in the virtual server configuration.
Apply	Click this to save your changes back to the Zyxel Device.
Cancel	Click Cancel to restore your previously saved settings.

10.5 ALG

Click **Network Setting > NAT > ALG** to open the **ALG** screen. Use this screen to enable and disable the NAT Application Layer Gateway (ALG) in the Zyxel Device.

Application Layer Gateway (ALG) allows certain applications such as File Transfer Protocol (FTP), Session Initiation Protocol (SIP), or file transfer in Instant Messaging (IM) applications to pass through the Zyxel Device.

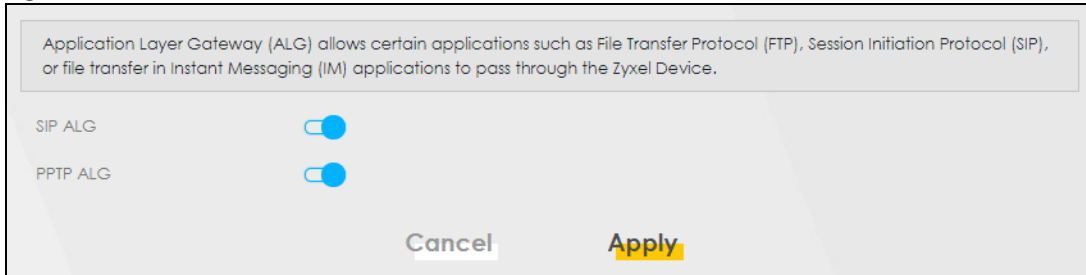
Figure 128 Network Setting > NAT > ALG

The following table describes the fields in this screen.

Table 57 Network Setting > NAT > ALG

LABEL	DESCRIPTION
SIP ALG	Click this (switch turns blue) to make sure SIP (VoIP) works correctly with port-forwarding and address-mapping rules. Otherwise, click this to turn off (switch turns gray) the SIP ALG.
PPTP ALG	Click this to turn on (switch turns blue) the PPTP ALG on the Zyxel Device to detect PPTP traffic and help build PPTP sessions through the Zyxel Device's NAT.
Apply	Click Apply to save your changes back to the Zyxel Device.
Cancel	Click Cancel to restore your previously saved settings.

10.6 Address Mapping

Use this screen to enable or disable the NAT Address Mapping in the Zyxel Device.

10.6.1 Address Mapping Screen

Click **Network Setting > NAT > Address Mapping** to open the **Address Mapping** screen.

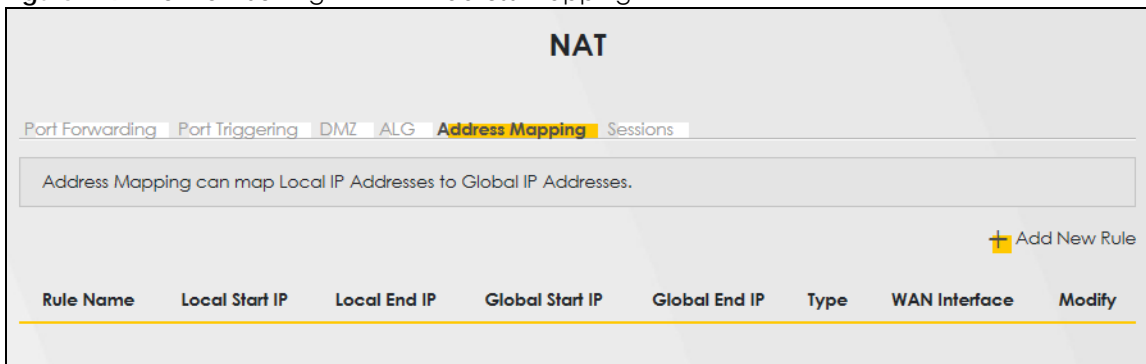
Figure 129 Network Setting > NAT > Address Mapping

The following table describes the fields in this screen.

Table 58 Network Setting > NAT > Address Mapping

LABEL	DESCRIPTION
Rule Name	This is the name of the rule.
Local Start IP	This is the starting Inside Local IP Address (ILA).

Table 58 Network Setting > NAT > Address Mapping (continued)

LABEL	DESCRIPTION
Local End IP	This is the ending Inside Local IP Address (ILA). If the rule is for all local IP addresses, then this field displays 0.0.0.0 as the Local Start IP address and 255.255.255.255 as the Local End IP address. This field is blank for One-to-One mapping types.
Global Start IP	This is the starting Inside Global IP Address (IGA). Enter 0.0.0.0 here if you have a dynamic IP address from your ISP. You can only do this for the Many-to-One mapping type.
Global End IP	This is the ending Inside Global IP Address (IGA). This field is blank for One-to-One and Many-to-One mapping types.
Type	This is the address mapping type. One-to-One: This mode maps one local IP address to one global IP address. Note that port numbers do not change for the One-to-One NAT mapping type. Many-to-One: This mode maps multiple local IP addresses to one global IP address. This is equivalent to SUA (i.e., PAT, port address translation), the Device's Single User Account feature that previous routers supported only. Many-to-Many: This mode maps multiple local IP addresses to shared global IP addresses.
WAN Interface	This is the WAN interface to which the address mapping rule applies.
Modify	Click the Edit icon to go to the screen where you can edit the address mapping rule. Click the Delete icon to delete an existing address mapping rule. Note that subsequent address mapping rules move up by one when you take this action.

10.6.2 Add New Rule Screen

To add or edit an address mapping rule, click **Add New Rule** or the **Modify** icon in the **Address Mapping** screen to display the screen shown next.

Figure 130 Network Setting > NAT > Address Mapping > Add New Rule

The screenshot shows the 'Add New Rule' configuration screen. It features a back arrow in the top left corner and the title 'Add New Rule' at the top center. The form contains the following fields:

- Rule Name:** An empty text input field.
- Type:** A dropdown menu currently set to 'One-to-One'.
- Local Start IP:** An empty IP address input field.
- Local End IP:** An empty IP address input field.
- Global Start IP:** An empty IP address input field.
- Global End IP:** An empty IP address input field.
- WAN Interface:** A dropdown menu currently set to 'Default'.

At the bottom of the screen, there are two buttons: 'Cancel' and 'OK'.

The following table describes the fields in this screen.

Table 59 Network Setting > NAT > Address Mapping > Add New Rule

LABEL	DESCRIPTION
Rule Name	Type up to 20 alphanumeric characters for the name of this rule.
Type	Choose the IP/port mapping type from one of the following. One-to-One: This mode maps one local IP address to one global IP address. Note that port numbers do not change for the One-to-One NAT mapping type. Many-to-One: This mode maps multiple local IP addresses to one global IP address. This is equivalent to SUA (i.e., PAT, port address translation), the Device's Single User Account feature that previous routers supported only. Many-to-Many: This mode maps multiple local IP addresses to shared global IP addresses.
Local Start IP	Enter the starting Inside Local IP Address (ILA).
Local End IP	Enter the ending Inside Local IP Address (ILA). If the rule is for all local IP addresses, then this field displays 0.0.0.0 as the Local Start IP address and 255.255.255.255 as the Local End IP address. This field is blank for One-to-One mapping types.
Global Start IP	Enter the starting Inside Global IP Address (IGA). Enter 0.0.0.0 here if you have a dynamic IP address from your ISP. You can only do this for the Many-to-One mapping type.
Global End IP	Enter the ending Inside Global IP Address (IGA). This field is blank for One-to-One and Many-to-One mapping types.
WAN Interface	Select a WAN interface to which the address mapping rule applies.
Cancel	Click Cancel to exit this screen without saving.
OK	Click OK to save your changes.

10.7 Sessions

Use the **Sessions** screen to limit the number of concurrent NAT sessions each client can use. Click **Network Setting > NAT > Sessions** to open the **Sessions** screen.

Figure 131 Network Setting > NAT > Sessions

NAT

Port Forwarding | Port Triggering | DMZ | ALG | Address Mapping | **Sessions**

The figure below limits the open sessions on a per host (a LAN IP Address) basis. Some applications, especially like P2P file sharing demand a greater number of NAT sessions in order to get a better uploading and downloading rate.

MAX NAT Session Per Host (0 ~ 20480)

Note

(1) Enter session number and click "Apply" to activate this feature.
 (2) Clear the session number field and click "Apply" to de-activate this feature.

Cancel Apply

The following table describes the fields in this screen.

Table 60 Network Setting > NAT > Sessions

LABEL	DESCRIPTION
MAX NAT Session Per Host (0~20480)	Use this field to set a common limit to the number of concurrent NAT sessions each client computer can have. If only a few clients use peer to peer applications, you can raise this number to improve their performance. With heavy peer to peer application use, lower this number to ensure no single client uses too many of the available NAT sessions.
Cancel	Click Cancel to restore your previously saved settings.
Apply	Click Apply to save your changes.

CHAPTER 11

Dynamic DNS Setup

11.1 DNS Overview

DNS

DNS (Domain Name System) is for mapping a domain name to its corresponding IP address and vice versa. The DNS server is extremely important because without it, you must know the IP address of a machine before you can access it.

In addition to the system DNS server(s), each WAN interface (service) is set to have its own static or dynamic DNS server list. You can configure a DNS static route to forward DNS queries for certain domain names through a specific WAN interface to its DNS server(s). The Zyxel Device uses a system DNS server (in the order you specify in the **Broadband** screen) to resolve domain names that do not match any DNS routing entry. After the Zyxel Device receives a DNS reply from a DNS server, it creates a new entry for the resolved IP address in the routing table.

Dynamic DNS

Dynamic DNS allows you to use a dynamic IP address with one or many dynamic DNS services so that anyone can contact you (in NetMeeting, CU-SeeMe, etc.). You can also access your FTP server or Web site on your own computer using a domain name (for instance myhost.dhs.org, where myhost is a name of your choice) that will never change instead of using an IP address that changes each time you reconnect. Your friends or relatives will always be able to call you even if they don't know your IP address.

You first need to have registered a dynamic DNS account with www.dyndns.org. This is for people with a dynamic IP from their ISP or DHCP server that would still like to have a domain name. The Dynamic DNS service provider will give you a password or key.

11.1.1 What You Can Do in this Chapter

- Use the **DNS Entry** screen to view, configure, or remove DNS routes ([Section 11.2 on page 176](#)).
- Use the **Dynamic DNS** screen to enable DDNS and configure the DDNS settings on the Zyxel Device ([Section 11.3 on page 177](#)).

11.1.2 What You Need To Know

DYNDNS Wildcard

Enabling the wildcard feature for your host causes *.yourhost.dyndns.org to be aliased to the same IP address as yourhost.dyndns.org. This feature is useful if you want to be able to use, for example, www.yourhost.dyndns.org and still reach your hostname.

If you have a private WAN IP address, then you cannot use Dynamic DNS.

11.2 DNS Entry

DNS (Domain Name System) is used for mapping a domain name to its corresponding IP address and vice versa. Use this screen to view and configure DNS routes on the Zyxel Device. Click **Network Setting > DNS** to open the **DNS Entry** screen.

Note: The host name should consist of the host's local name and the domain name. For example, Mycomputer.home is a host name where Mycomputer is the host's local name, and .home is the domain name.

Figure 132 Network Setting > DNS > DNS Entry



The following table describes the fields in this screen.

Table 61 Network Setting > DNS > DNS Entry

LABEL	DESCRIPTION
Add New DNS Entry	Click this to create a new DNS entry.
#	This is the index number of the entry.
HostName	This indicates the host name or domain name.
IP Address	This indicates the IP address assigned to this computer.
Modify	Click the Edit icon to edit the rule. Click the Delete icon to delete an existing rule.

11.2.1 Add/Edit DNS Entry

You can manually add or edit the Zyxel Device's DNS name and IP address entry. Click **Add New DNS Entry** in the **DNS Entry** screen or the **Edit** icon next to the entry you want to edit. The screen shown next appears.

Figure 133 DNS Entry: Add/Edit

The following table describes the labels in this screen.

Table 62 DNS Entry: Add/Edit

LABEL	DESCRIPTION
Host Name	Enter the host name of the DNS entry.
IPv4 Address	Enter the IPv4 address of the DNS entry.
Cancel	Click Cancel to exit this screen without saving.
OK	Click OK to save your changes.

11.3 Dynamic DNS

Dynamic DNS can update your current dynamic IP address mapping to a hostname. Configure a DDNS service provider on your Zyxel Device. Click **Network Setting > DNS > Dynamic DNS**. The screen appears as shown.

Figure 134 Network Setting > DNS > Dynamic DNS

Dynamic DNS can update your current dynamic IP address mapping to a hostname. Configure a DDNS service provider on your Zyxel Device.

Dynamic DNS Setup

Dynamic DNS Enable Disable (Settings are invalid when disable)

Service Provider

Host Name

Username

Password

Enable Wildcard Option

Enable Off Line Option (Only applies to custom DNS)

Dynamic DNS Status

User Authentication Result

Last Updated Time

Current Dynamic IP

The following table describes the fields in this screen.

Table 63 Network Setting > DNS > Dynamic DNS

LABEL	DESCRIPTION
Dynamic DNS Setup	
Dynamic DNS	Select Enable to use dynamic DNS.
Service Provider	Select your Dynamic DNS service provider from the drop-down list box.
Host Name	Type the domain name assigned to your Zyxel Device by your Dynamic DNS provider. You can specify up to two host names in the field separated by a comma (",").
Username	Type your user name.
Password	Type the password assigned to you.
Enable Wildcard Option	Select the check box to enable DynDNS Wildcard.
Enable Off Line Option (Only applies to custom DNS)	Check with your Dynamic DNS service provider to have traffic redirected to a URL (that you can specify) while you are off line.
Dynamic DNS Status	
User Authentication Result	This shows Success if the account is correctly set up with the Dynamic DNS provider account.
Last Updated Time	This shows the last time the IP address the Dynamic DNS provider has associated with the hostname was updated.
Current Dynamic IP	This shows the IP address your Dynamic DNS provider has currently associated with the hostname.
Cancel	Click Cancel to exit this screen without saving.
Apply	Click Apply to save your changes.

CHAPTER 12

USB Service

12.1 USB Service Overview

You can share files on a USB memory stick or hard drive connected to your Zyxel Device with users on your network.

The following figure is an overview of the Zyxel Device's file server feature. Computers **A** and **B** can access files on a USB device (**C**) which is connected to the Zyxel Device.

Figure 135 File Sharing Overview

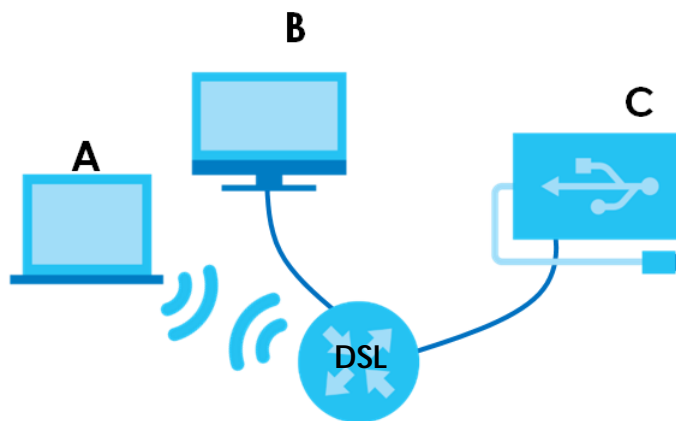

The Zyxel Device will not be able to join the workgroup if your local area network has restrictions set up that do not allow devices to join a workgroup. In this case, contact your network administrator.

12.1.1 What You Need To Know

The following terms and concepts may help as you read this chapter.

12.1.1.1 About File Sharing

Workgroup Name

This is the name given to a set of computers that are connected on a network and share resources such as a printer or files. Windows automatically assigns the workgroup name when you set up a network.

Shares

When settings are set to default, each USB device connected to the Zyxel Device is given a folder, called a "share". If a USB hard drive connected to the Zyxel Device has more than one partition, then each partition will be allocated a share. You can also configure a "share" to be a sub-folder or file on the USB device.

File Systems

A file system is a way of storing and organizing files on your hard drive and storage device. Often different operating systems such as Windows or Linux have different file systems. The file sharing feature on your Zyxel Device supports File Allocation Table (FAT) and FAT32.

Common Internet File System

The Zyxel Device uses Common Internet File System (CIFS) protocol for its file sharing functions. CIFS compatible computers can access the USB file storage devices connected to the Zyxel Device. CIFS protocol is supported on Microsoft Windows, Linux Samba and other operating systems (refer to your systems specifications for CIFS compatibility).

12.1.2 Before You Begin

Make sure the Zyxel Device is connected to your network and turned on.

- 1 Connect the USB device to one of the Zyxel Device's USB port. Make sure the Zyxel Device is connected to your network.
- 2 The Zyxel Device detects the USB device and makes its contents available for browsing. If you are connecting a USB hard drive that comes with an external power supply, make sure it is connected to an appropriate power source that is on.

Note: If your USB device cannot be detected by the Zyxel Device, see the troubleshooting for suggestions.

12.2 USB Service

Use this screen to set up file sharing through the Zyxel Device. The Zyxel Device's LAN users can access the shared folder (or share) from the USB device inserted in the Zyxel Device. To access this screen, click **Network Setting > USB Service**.

Figure 136 Network Setting > USB Service

USB Service

The modem can share Files from your USB flash drive or disk when you attach it to the USB port. You may Start from deciding which folders in the USB disks to share and which users can access the shared folders.

Information

Volume	Capacity	Used Space
usb2_sda1	30111 MB	2705 MB

Server Configuration

File Sharing Services

Share Directory List

 Add New Share

Active	Status	Share Name	Share Path	Share Description	Modify

Account Management

 Add New User

Status	User Name
	admin

Note: Share Directory List field appears when you connect a USB device to the USB port. Otherwise, it does not.

Each field is described in the following table.

Table 64 Network Setting > USB Service > File Sharing



LABEL	DESCRIPTION
Information	
Volume	This is the volume name the Zyxel Device gives to an inserted USB device.
Capacity	This is the total available memory size (in megabytes) on the USB device.
Used Space	This is the memory size (in megabytes) already used on the USB device.
Server Configuration	
File Sharing Services	Click this switch to enable or disable file sharing through the Zyxel Device. When the switch goes to the right  , the function is enabled. Otherwise, it is not.
Share Directory List	
Add New Share	Click this to set up a new share on the Zyxel Device.
Active	Select this to allow the share to be accessed.
Status	This field shows the status of the share  : The share is not activated.  : The share is activated.

Table 64 Network Setting > USB Service > File Sharing

LABEL	DESCRIPTION
Share Name	This field displays the name of the file you shared.
Share Path	This field displays the location in the USB of the file you shared.
Share Description	This field displays a description of the file you shared.
Modify	Click the Edit icon to change the settings of an existing share. Click the Delete icon to delete this share in the list.
Account Management	
Add New User	Click this button to create a user account to access the secured shares. This button redirects you to Maintenance > User Account .
Status	This field shows the status of the user. : The user account is not activated for the share. 🔒: The user account is activated for the share.
User Name	This is the name of a user who is allowed to access the secured shares on the USB device.
Cancel	Click this to restore your previously saved settings.
Apply	Click this to save your changes to the Zyxel Device.

12.2.1 Add New Share

Use this screen to set up a new share or edit an existing share on the Zyxel Device. Click **Add New Share** in the **File Sharing** screen or click the **Edit/Modify** icon next to an existing share.

Please note that you need to set up your shares in the USB before enabling file sharing in the Zyxel Device. Also, spaces and the following special characters listed in the brackets [" < > ^ \$ | & ; \ / : * ?] are not allowed for the USB share name.

Figure 137 Network Setting > USB Service > File Sharing > Add New Share

The screenshot shows the 'Add New Share' configuration screen. It features a back arrow in the top left corner. The title 'Add New Share' is centered at the top. Below the title, there are four rows of input fields:

- Volume:** A dropdown menu with 'usb2_sda1' selected.
- Share Path:** A text input field with a yellow 'Browse' button to its right.
- Description:** A text input field.
- Access Level:** A dropdown menu with 'Public' selected.

At the bottom of the screen, there are two buttons: 'Cancel' on the left and 'OK' on the right.

The following table describes the labels in this menu.

Table 65 Network Setting > USB Service > Media Server

LABEL	DESCRIPTION
Volume	Select the volume in the USB storage device that you want to add as a share in the Zyxel Device. This field is read-only when you are editing the share.
Share Path	Manually enter the file path for the share, or click the Browse button and select the folder that you want to add as a share. This field is read-only when you are editing the share.
Description	You can either enter a short description of the share, or leave this field blank.
Access Level	Select Public if you want the share to be accessed by users connecting to the Zyxel Device. Otherwise, select Security .
Allowed	If Security is selected in the Access Level field, select this check box to allow/prohibit access to the share.
User Name	This field specifies the user for which the Allowed setting applies. Users can be added or modified in Maintenance > User Account .
Cancel	Click Cancel to return to the previous screen.
OK	Click OK to save your changes.

12.2.2 The Add New User Screen

Once you click the **Add New User** button, you'll be directed to the **User Account** screen. To create a user account that can access the secured shares on the USB device, click the **Add New Account** button in the **Network Setting > USB Service > User Account** screen.

Please see [Chapter 26 on page 245](#), for detailed information about **User Account** screen.

CHAPTER 13

Firewall

13.1 Overview

This chapter shows you how to enable the Zyxel Device firewall. Use the firewall to protect your Zyxel Device and network from attacks by hackers on the Internet and control access to it. The firewall:

- allows traffic that originates from your LAN computers to go to all other networks.
- blocks traffic that originates on other networks from going to the LAN.

By default, the Zyxel Device blocks DoS attacks whether the firewall is enabled or disabled.

The following figure illustrates the firewall action. User **A** can initiate an IM (Instant Messaging) session from the LAN to the WAN (1). Return traffic for this session is also allowed (2). However other traffic initiated from the WAN is blocked (3 and 4).

Figure 138 Default Firewall Action

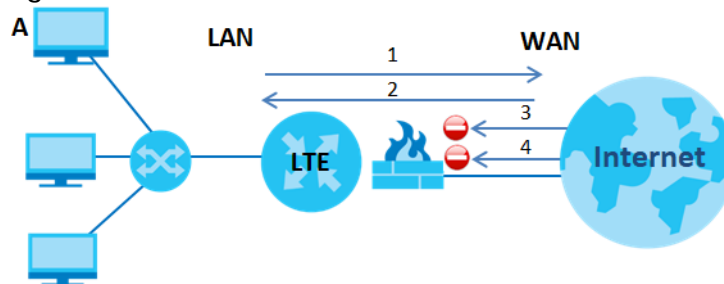

13.1.1 What You Need to Know About Firewall

DoS

Denials of Service (DoS) attacks are aimed at devices and networks with a connection to the Internet. Their goal is not to steal information, but to disable a device or network so users no longer have access to network resources. The Zyxel Device is pre-configured to automatically detect and thwart all known DoS attacks.

ICMP

Internet Control Message Protocol (ICMP) is a message control and error-reporting protocol between a host server and a gateway to the Internet. ICMP uses Internet Protocol (IP) datagrams, but the messages are processed by the TCP/IP software and directly apparent to the application user.

DoS Thresholds

For DoS attacks, the Zyxel Device uses thresholds to determine when to drop sessions that do not become fully established. These thresholds apply globally to all sessions. You can use the default threshold values, or you can change them to values more suitable to your security requirements.

13.2 Firewall

13.2.1 What You Can Do in this Chapter

- Use the **General** screen to configure the security level of the firewall on the Zyxel Device ([Section 13.3 on page 185](#)).
- Use the **Protocol** screen to add or remove predefined Internet services and configure firewall rules ([Section 13.4 on page 187](#)).
- Use the **Access Control** screen to view and configure incoming/outgoing filtering rules ([Section 13.5 on page 188](#)).
- Use the **DoS** screen to activate protection against Denial of Service (DoS) attacks ([Section 13.6 on page 191](#)).

13.3 Firewall General Settings

Use the firewall to protect your Zyxel Device and network from attacks by hackers on the Internet and control access to it. Use this screen to set the security level of the firewall on the Zyxel Device. Firewall rules are grouped based on the direction of travel of packets. A higher firewall level means more restrictions on the Internet activities you can perform. Click **Security > Firewall > General** to display the following screen. Use the slider to select the level of firewall protection.

Figure 139 Security > Firewall > General

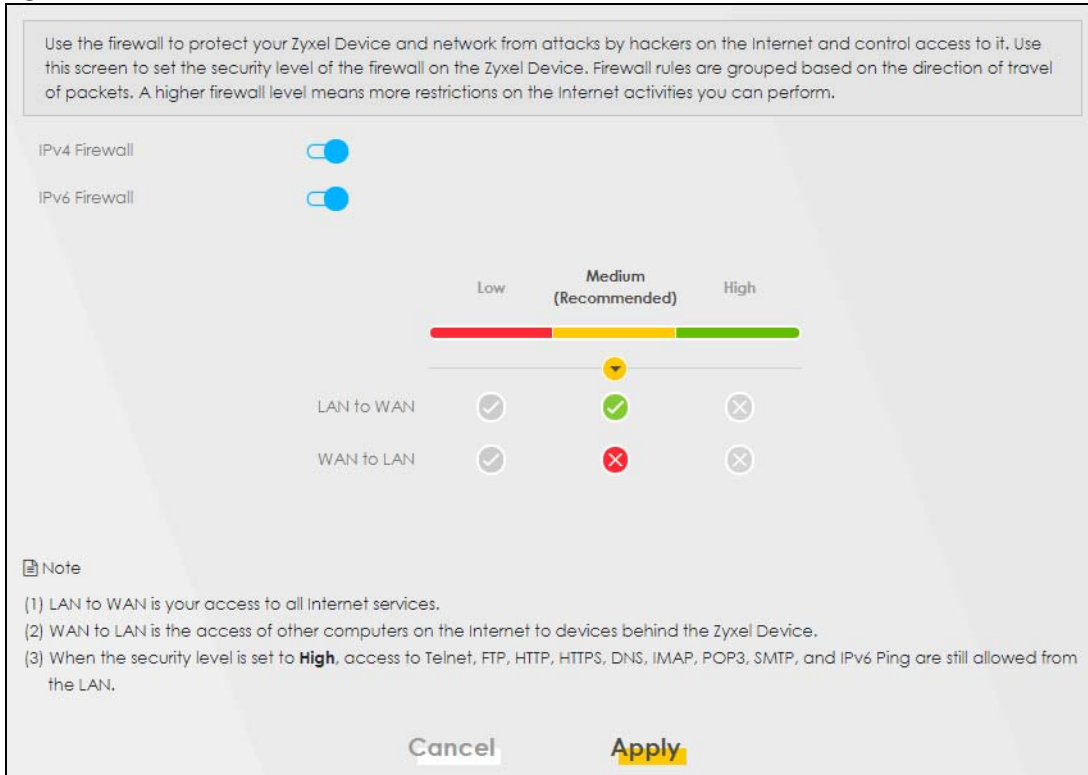

Note: LAN to WAN is your access to all Internet services. WAN to LAN is the access of other computers on the Internet to devices behind the Zyxel Device. When the security level is set to **High**, Telnet, FTP, HTTP, HTTPS, DNS, IMAP, POP3, SMTP, and/or IPv6 ICMPv6 (Ping) traffic from the LAN are still allowed.

The following table describes the labels in this screen.

Table 66 Security > Firewall > General

LABEL	DESCRIPTION
IPv4 Firewall	Enable firewall protection when using IPv4 (Internet Protocol version 4).
IPv6 Firewall	Enable firewall protection when using IPv6 (Internet Protocol version 6).
High	This setting blocks all traffic to and from the Internet. Only local network traffic and LAN to WAN service (Telnet, FTP, HTTP, HTTPS, DNS, POP3, SMTP) is permitted.
Medium	This is the recommended setting. It allows traffic to the Internet but blocks anyone from the Internet from accessing any services on your local network.
Low	This setting allows traffic to the Internet and also allows someone from the Internet to access services on your local network. This would be used with Port Forwarding, Default Server.
Apply	Click this to save your changes.
Cancel	Click this to restore your previously saved settings.

13.4 Protocol (Customized Services)

You can configure customized services and port numbers in the **Protocol** screen. Each set of protocol rules listed in the table are reusable objects to be used in conjunction with ACL rules in the Access Control screen. For a comprehensive list of port numbers and services, visit the IANA (Internet Assigned Number Authority) website. Click **Security > Firewall > Protocol** to display the following screen.

Note: Removing a protocol rule will also remove associated ACL rules.

Figure 140 Security > Firewall > Protocol

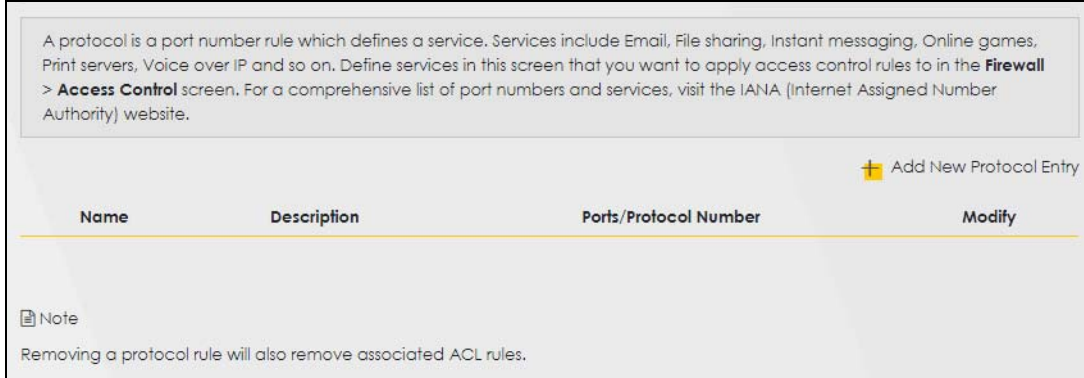

The following table describes the labels in this screen.

Table 67 Security > Firewall > Protocol

LABEL	DESCRIPTION
Add New Protocol Entry	Click this to configure a customized service.
Name	This is the name of your customized service.
Description	This is a description of your customized service.
Ports/Protocol Number	This shows the port number or range and the IP protocol (TCP or UDP) that defines your customized service.
Modify	Click this to edit a customized service.

13.4.1 Add Customized Service

Add a customized rule or edit an existing rule by specifying the protocol and the port numbers. Click **Add New Protocol Entry** in the **Protocol** screen to display the following screen.

Figure 141 Security > Firewall > Protocol: Add New Protocol Entry

The following table describes the labels in this screen.

Table 68 Security > Firewall > Protocol: Add New Protocol Entry

LABEL	DESCRIPTION
Service Name	Type a unique name for your custom port.
Description	Enter a description for your custom port.
Protocol	Choose the protocol (TCP , UDP , ICMP , ICMPv6 , or Other) that defines your customized port from the drop down list box.
Protocol Number	Type a single port number or the range of port numbers (0-255) that define your customized service.
OK	Click this to save your changes.
Cancel	Click this to exit this screen without saving.

13.5 Access Control (Rules)

An Access Control List (ACL) rule is a manually-defined rule that can accept, reject, or drop incoming or outgoing packets from your network. This screen displays a list of the configured incoming or outgoing filtering rules. Note the order in which the rules are listed. Click **Security > Firewall > Access Control** to display the following screen.

Note: The ordering of your rules is very important as rules are applied in turn.

Figure 142 Security > Firewall > Access Control

The following table describes the labels in this screen.

Table 69 Security > Firewall > Rules

LABEL	DESCRIPTION
Rules Storage Space Usage	This read-only bar shows how much of the Zyxel Device's memory for recording firewall rules it is currently using. When you are using 80% or less of the storage space, the bar is green. When the amount of space used is over 80%, the bar is red.
Add New ACL Rule	Select an index number and click Add New ACL Rule to add a new firewall rule after the selected index number. For example, if you select "6", your new rule becomes number 7 and the previous rule 7 (if there is one) becomes rule 8.
#	This field displays the rule index number. The ordering of your rules is important as rules are applied in turn.
Name	This field displays the rule name.
Src IP	This field displays the source IP addresses to which this rule applies.
Dest IP	This field displays the destination IP addresses to which this rule applies.
Service	This field displays the protocol (All, TCP, UDP, TCP/UDP, ICMP, ICMPv6, or any) used to transport the packets for which you want to apply the rule.
Action	Displays whether the firewall silently discards packets (Drop), discards packets and sends a TCP reset packet or an ICMP destination-unreachable message to the sender (Reject), or allow the passage of (Accept) packets that match this rule.
Modify	Click the Edit icon to edit the firewall rule. Click the Delete icon to delete an existing firewall rule.

13.5.1 Add New ACL Rule Screen

Use this screen to configure firewall rules. In the **Access Control** screen, select an index number and click **Add New ACL Rule** or click a rule's **Edit** icon to display this screen and refer to the following table for information on the labels.

Figure 143 Security > Firewall > Access Control > Add New ACL Rule

The screenshot shows the 'Add New ACL Rule' configuration interface. It includes the following fields and options:

- Filter Name:** Text input field.
- Order:** Text input field with value '1'.
- Select Source IP Address:** Dropdown menu with 'Specific IP Address' selected.
- Source IP Address:** Text input field with placeholder '[/prefix length]'.
- Select Destination Device:** Dropdown menu with 'Specific IP Address' selected.
- Destination IP Address:** Text input field with placeholder '[/prefix length]'.
- IP Type:** Text input field with value 'IPv4'.
- Select Service:** Text input field with value 'Specific Service'.
- Protocol:** Text input field with value 'ALL'.
- Custom Source Port:** Range selector with 'Range' button and input fields '1' and '1'.
- Custom Destination Port:** Range selector with 'Range' button and input fields '1' and '1'.
- Policy:** Text input field with value 'ACCEPT'.
- Direction:** Text input field with value 'WAN to LAN'.
- Enable Rate Limit:** Toggle switch (currently off).
- Rate Limit:** Input field for 'packet(s) per' with value 'Minute' and a range '(1-512)'.
- Scheduler Rules:** Dropdown menu.
- Buttons:** 'Add New Rule' (yellow), 'Cancel', and 'OK' (yellow).

The following table describes the labels in this screen.

Table 70 Security > Firewall > Access Control > Add New ACL Rule

LABEL	DESCRIPTION
Filter Name	Type a unique name for your filter rule.
Order	Assign the order of your rules as rules are applied in turn.
Select Source IP Address	If you want the source to come from a particular (single) IP, select Specific IP Address . If not, select from a detected device.
Source IP Address	If you selected Specific IP Address in the previous item, enter the source device's IP address here. Otherwise this field will be hidden if you select the detected device.
Select Destination Device	If you want your rule to apply to packets with a particular (single) IP, select Specific IP Address . If not, select a detected device.
Destination IP Address	If you selected Specific IP Address in the previous item, enter the destination device's IP address here. Otherwise this field will be hidden if you select the detected device.

Table 70 Security > Firewall > Access Control > Add New ACL Rule (continued)

LABEL	DESCRIPTION
IP Type	Select between IPv4 or IPv6 . Compared to IPv4 , IPv6 (Internet Protocol version 6), is designed to enhance IP address size and features. The increase in IPv6 address size to 128 bits (from the 32-bit IPv4 address) allows up to 3.4 x 10 ³⁸ IP addresses. The Zyxel Device can use IPv4/IPv6 dual stack to connect to IPv4 and IPv6 networks, and supports IPv6 rapid deployment (6RD).
Select Service	Select a service from the Select Service box.
Protocol	Select the protocol (ALL , TCP/UDP , TCP , UDP , ICMP , or ICMPv6) used to transport the packets for which you want to apply the rule.
Custom Source Port	This is a single port number or the starting port number of a range that defines your rule.
Custom Destination Port	This is a single port number or the ending port number of a range that defines your rule.
TCP Flag	Select the TCP Flag (SYN, ACK, URG, PSH, RST, FIN).
Policy	Use the drop-down list box to select whether to discard (Drop), deny and send an ICMP destination-unreachable message to the sender (Reject), or allow the passage of (Accept) packets that match this rule.
Direction	Select WAN to LAN to apply the rule to traffic from WAN to LAN. Select LAN to WAN to apply the rule to traffic from LAN to WAN. Select WAN to Router to apply the rule to traffic from WAN to router. Select LAN to Router to apply the rule to traffic from LAN to router.
Enable Rate Limit	Click to enable (switch turns blue) the setting of maximum number of packets per maximum number of minute/second to limit the throughput of traffic that matches this rule. If not, the next item will be disabled.
Scheduler Rules	
packet(s) per (1-512)	Enter the maximum number of packets (1-512) per minute/second .
Add New Rule	Select a schedule rule for this ACL rule from the drop-down list box. You can configure a new schedule rule by clicking Add New Rule .
OK	Click this to save your changes.
Cancel	Click this to exit this screen without saving.

13.6 DoS

DoS (Denial of Service) attacks can flood your Internet connection with invalid packets and connection requests, using so much bandwidth and so many resources that Internet access becomes unavailable. Use the **DoS** screen to activate protection against DoS attacks.

Click **Security > Firewall > DoS** to display the following screen.

Figure 144 Security > Firewall > DoS

Activate protection against DoS attacks. DoS (Denial of Service) attacks can flood your Internet connection with invalid packets and connection requests, using so much bandwidth and so many resources that Internet access becomes unavailable.

DoS Protection Blocking Enable Disable (Settings are invalid when disable)

Cancel Apply

The following table describes the labels in this screen.

Table 71 Security > Firewall > DoS

LABEL	DESCRIPTION
DoS Protection Blocking	Enable this to protect against DoS attacks. The Zyxel Device will drop sessions that surpass maximum thresholds.
Apply	Click this to save your changes.
Cancel	Click this to restore your previously saved settings.

13.7 Firewall Technical Reference

This section provides some technical background information about the topics covered in this chapter.

13.7.1 Firewall Rules Overview

Your customized rules take precedence and override the Zyxel Device's default settings. The Zyxel Device checks the source IP address, destination IP address and IP protocol type of network traffic against the firewall rules (in the order you list them). When the traffic matches a rule, the Zyxel Device takes the action specified in the rule.

Firewall rules are grouped based on the direction of travel of packets to which they apply:

- LAN to Router
- LAN to WAN
- WAN to LAN
- WAN to Router

By default, the Zyxel Device's stateful packet inspection allows packets traveling in the following directions:

- LAN to Router
 - These rules specify which computers on the LAN can manage the Zyxel Device (remote management).

Note: You can also configure the remote management settings to allow only a specific computer to manage the Zyxel Device.

- LAN to WAN
 - These rules specify which computers on the LAN can access which computers or services on the WAN.

By default, the Zyxel Device's stateful packet inspection drops packets traveling in the following directions:

- WAN to LAN
 - These rules specify which computers on the WAN can access which computers or services on the LAN.

Note: You also need to configure NAT port forwarding (or full featured NAT address mapping rules) to allow computers on the WAN to access devices on the LAN.

- WAN to Router

By default the Zyxel Device stops computers on the WAN from managing the Zyxel Device. You could configure one of these rules to allow a WAN computer to manage the Zyxel Device.

Note: You also need to configure the remote management settings to allow a WAN computer to manage the Zyxel Device.

You may define additional rules and sets or modify existing ones but please exercise extreme caution in doing so.

For example, you may create rules to:

- Block certain types of traffic, such as IRC (Internet Relay Chat), from the LAN to the Internet.
- Allow certain types of traffic, such as Lotus Notes database synchronization, from specific hosts on the Internet to specific hosts on the LAN.
- Allow everyone except your competitors to access a web server.
- Restrict use of certain protocols, such as Telnet, to authorized users on the LAN.

These custom rules work by comparing the source IP address, destination IP address and IP protocol type of network traffic to rules set by the administrator. Your customized rules take precedence and override the Zyxel Device's default rules.

13.7.2 Guidelines For Security Enhancement With Your Firewall

- 1 Change the default password via the Web Configurator.
- 2 Think about access control before you connect to the network in any way.
- 3 Limit who can access your router.
- 4 Don't enable any local service (such as telnet or FTP) that you don't use. Any enabled service could present a potential security risk. A determined hacker might be able to find creative ways to misuse the enabled services to access the firewall or the network.
- 5 For local services that are enabled, protect against misuse. Protect by configuring the services to communicate only with specific peers, and protect by configuring rules to block packets for the services at specific interfaces.
- 6 Protect against IP spoofing by making sure the firewall is active.
- 7 Keep the firewall in a secured (locked) room.

13.7.3 Security Considerations

Note: Incorrectly configuring the firewall may block valid access or introduce security risks to the Zyxel Device and your protected network. Use caution when creating or deleting firewall rules and test your rules after you configure them.

Consider these security ramifications before creating a rule:

- 1** Does this rule stop LAN users from accessing critical resources on the Internet? For example, if IRC (Internet Relay Chat) is blocked, are there users that require this service?
- 2** Is it possible to modify the rule to be more specific? For example, if IRC is blocked for all users, will a rule that blocks just certain users be more effective?
- 3** Does a rule that allows Internet users access to resources on the LAN create a security vulnerability? For example, if FTP ports (TCP 20, 21) are allowed from the Internet to the LAN, Internet users may be able to connect to computers with running FTP servers.
- 4** Does this rule conflict with any existing rules?

Once these questions have been answered, adding rules is simply a matter of entering the information into the correct fields in the Web Configurator screens.

CHAPTER 14

MAC Filter

14.1 MAC Filter Overview

You can configure the Zyxel Device to permit access to clients based on their MAC addresses in the **MAC Filter** screen. This applies to wired and wireless connections. Every Ethernet device has a unique MAC (Media Access Control) address. The MAC address is assigned at the factory and consists of six pairs of hexadecimal characters, for example, 00:A0:C5:00:00:02. You need to know the MAC addresses of the LAN client to configure this screen.

14.2 MAC Filter

Enable **MAC Address Filter** and add the host name and MAC address of a LAN client to the table if you wish to allow or deny them access to your network. You can choose to enable or disable the filters per entry; make sure that the check box under **Active** is selected if you want to use a filter. Select **Security > MAC Filter**. The screen appears as shown.

Figure 145 Security > MAC Filter

MAC Filter

You can configure the Zyxel Device to permit access to clients based on their MAC addresses in the **MAC Filter** screen. This applies to wired and wireless connections. Every Ethernet device has a unique MAC (Media Access Control) address. The MAC address is assigned at the factory and consists of six pairs of hexadecimal characters, for example, 00:A0:C5:00:00:02. You need to know the MAC addresses of the LAN client to configure this screen.

MAC Address Filter Enable Disable (Settings are invalid when disable)

MAC Restrict Mode Allow Deny

[+ Add New Rule](#)

Set	Active	Host Name	MAC Address	Delete
-----	--------	-----------	-------------	--------

Note
Enable **MAC Address Filter** and add the host name and MAC address of a LAN client to the table if you wish to allow or deny them access to your network.

[Cancel](#) [Apply](#)

The following table describes the labels in this screen.

Table 72 Security > MAC Filter

LABEL	DESCRIPTION
MAC Address Filter	Select Enable to activate the MAC filter function.
MAC Restrict Mode	Select Allow to only permit the listed MAC addresses access to the Zyxel Device. Select Deny to permit anyone access to the Zyxel Device except the listed MAC addresses.
Add New Rule	Click this button to create a new entry.
Set	This is the index number of the MAC address.
Active	Select Active to enable the MAC filter rule. The rule will not be applied if Allow is not selected under MAC Restrict Mode .
Host Name	Enter the host name of the wireless or LAN clients that are allowed access to the Zyxel Device.
MAC Address	Enter the MAC addresses of the wireless or LAN clients that are allowed access to the Zyxel Device in these address fields. Enter the MAC addresses in a valid MAC address format, that is, six hexadecimal character pairs, for example, 12:34:56:78:9a:bc.
Delete	Click the Delete icon to delete an existing rule.
Cancel	Click Cancel to restore your previously saved settings.
Apply	Click Apply to save your changes.

14.2.1 Add New Rule

You can choose to enable or disable the filters per entry; make sure that the check box under **Active** is selected if you want to use a filter, as shown in the example below. Select **Security > MAC Filter > Add New Rule**. The screen appears as shown.

Figure 146 Security > MAC Filter > Add New Rule

Set	Active	Host Name	MAC Address	Delete
1	<input checked="" type="checkbox"/>	test	BC - 22 - 33 - 11 - 66 - AA	
2	<input checked="" type="checkbox"/>	Test	BC - 88 - 99 - 00 - 11 - 24	

The following table describes the labels in this screen.

Table 73 Security > MAC Filter > Add New Rule

LABEL	DESCRIPTION
Set	This is the index number of the MAC address.
Active	Select Active to enable the MAC filter rule. The rule will not be applied if Allow is not selected under MAC Restrict Mode .
Host Name	Enter the host name of the wireless or LAN clients that are allowed access to the Zyxel Device.
MAC Address	Enter the MAC addresses of the wireless or LAN clients that are allowed access to the Zyxel Device in these address fields. Enter the MAC addresses in a valid MAC address format, that is, six hexadecimal character pairs, for example, 12:34:56:78:9a:bc.
Delete	Click the Delete icon to delete an existing rule.
Cancel	Click Cancel to restore your previously saved settings.
Apply	Click Apply to save your changes.

CHAPTER 15

Parental Control

15.1 Overview

Use this screen to enable parental control and view parental control rules and schedules. Parental control allows you to limit the time users can access the Internet, and prevent users from viewing inappropriate content or participating in unauthorized online activities. These rules are defined in a Parental Control Profile (PCP).

15.2 The Parental Control Screen

Use this screen to enable parental control, view the parental control rules and schedules.

Click **Security > Parental Control** to open the following screen.

Figure 147 Security > Parental Control

Parental Control

To limit the time of using Internet or to prevent family members from inappropriate contents and online activities, the administrator can define Parental Control Profile(PCP) to a specific home network user. A maximum of 20 profiles can be created.

General

Parental Control Enable Disable (Settings are invalid when disable)

Parental Control Profile(PCP) + Add New PCP

#	Status	PCP Name	Home Network User MAC	Internet Access Schedule	Network Service	Website Blocked	Modify
---	--------	----------	-----------------------	--------------------------	-----------------	-----------------	--------

Cancel Apply

The following table describes the fields in this screen.

Table 74 Parental Control > Parental Control

LABEL	DESCRIPTION
Parental Control	Select Enable to activate parental control.
Add New PCP	Click this if you want to configure a new parental control rule.
#	This shows the index number of the rule.

Table 74 Parental Control > Parental Control (continued)

LABEL	DESCRIPTION
Status	This indicates whether the rule is active or not. A yellow bulb signifies that this rule is active. A gray bulb signifies that this rule is not active.
PCP Name	This shows the name of the rule.
Home Network User (MAC)	This shows the MAC address of the LAN user's computer to which this rule applies.
Internet Access Schedule	This shows the day(s) and time on which parental control is enabled.
Network Service	This shows whether the network service is configured. If not, None will be shown.
Website Blocked	This shows whether the website block is configured. If not, None will be shown.
Modify	Click the Edit icon to go to the screen where you can edit the rule. Click the Delete icon to delete an existing rule.
Cancel	Click Cancel to exit this screen without saving.
Apply	Click Apply to save your changes back to the Zyxel Device.

15.2.1 Add New Parental Control Rule

Click **Add New PCP** in the **Parental Control** screen to add a new PCP rule. Use this screen to configure a restricted access schedule and/or URL filtering settings to block the users on your network from accessing certain websites.

Figure 148 Parental Control > Parental Control > Add New PCP

The following table describes the fields in this screen.

Table 75 Parental Control > Parental Control > Add New PCP

LABEL	DESCRIPTION
General	
Active	Select Enable to activate this parental control rule.

Table 75 Parental Control > Parental Control > Add New PCP

LABEL	DESCRIPTION
Parental Control Profile Name	Enter a descriptive name for the rule.
Home Network User	Select the LAN user that you want to apply this rule to from the drop-down list box. If you select Custom , enter the LAN user's MAC address. If you select All , the rule applies to all LAN users.
Rule List	In Home Network User , select Custom , enter the LAN user's MAC address, then click the + sign to enter a computer MAC address for this PCP. Up to five are allowed. Click the - sign to remove one.
Internet Access Schedule	
Day	Select the days that you want the Zyxel Device to perform parental control.
Time	Drag the time bar to define the time that the LAN user is allowed access.
Add New Time	Click this to add a new time bar. Up to three are allowed.
Network Service	
Network Service Setting	If you select Block , the Zyxel Device prohibits the users from viewing the Web sites with the URLs listed below. If you select Allow , the Zyxel Device blocks access to all URLs except the ones listed below.
Add New Service	Click this to show a screen in which you can add a new service rule. You can configure the Add New Service , Protocol , and Port of the new rule.
#	This shows the index number of the rule. Select the checkbox next to the rule to activate it.
Protocol	This shows the protocol of the rule. Choices are TCP , UDP , or TCP& UDP .
Port	This shows the port of the rule.
Modify	Click the Edit icon to go to the screen where you can edit the rule. Click the Delete icon to delete an existing rule.
Site/URL Keyword	
Block or Allow the Web Site	If you select Block the Web URLs , the Zyxel Device prohibits the users from viewing the Web sites with the URLs listed below. If you select Allow the Web URLs , the Zyxel Device blocks access to all URLs except the ones listed below.
#	This shows the index number of the rule.
Website	This shows the URL of web site or URL keyword to which the Zyxel Device blocks or allows access.
Modify	Click the Edit icon to go to the screen where you can edit the rule. Click the Delete icon to delete an existing rule.
Add	Click Add to show a screen to enter the URL of web site or URL keyword to which the Zyxel Device blocks or allows access.
OK	Click OK to save your settings back to the Zyxel Device.
Cancel	Click Cancel to return to the previous screen without saving any changes.

CHAPTER 16

Certificates

16.1 Certificates Overview

The Zyxel Device can use certificates (also called digital IDs) to authenticate users. Certificates are based on public-private key pairs. A certificate contains the certificate owner's identity and public key. Certificates provide a way to exchange public keys for use in authentication.

16.1.1 What You Can Do in this Chapter

- Use the **Local Certificates** screen to view and import the Zyxel Device's CA-signed (Certification Authority) certificates ([Section 16.2 on page 201](#)).
- Use the **Trusted CA** screen to save the certificates of trusted CAs to the Zyxel Device. You can also export the certificates to a computer ([Section 16.3 on page 205](#)).

16.2 Local Certificates

Use this screen to view the Zyxel Device's summary list of certificates, generate certification requests, and import signed certificates. You can import the following certificates to your Zyxel Device:

- Web Server - This certificate secures HTTP connections.
- SSH- This certificate secures remote connections.

Click **Security > Certificates** to open the **Local Certificates** screen.

Figure 149 Security > Certificates > Local Certificates

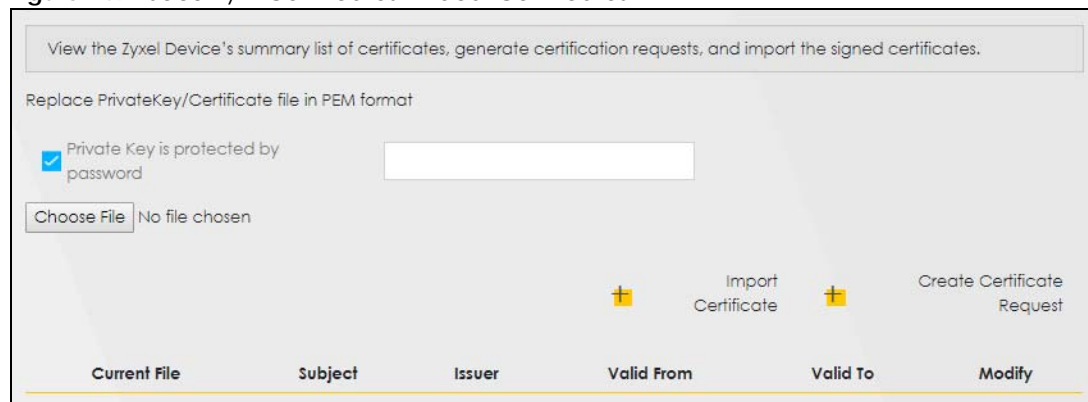

The following table describes the labels in this screen.

Table 76 Security > Certificates > Local Certificates

LABEL	DESCRIPTION
	Replace Private Key/Certificate file in PEM format
Private Key is protected by password	Select the check box and enter the private key into the text box to store it on the Zyxel Device. The private key should not exceed 63 ASCII characters (not including spaces).
Choose File	Click this button to find the certificate file you want to upload.
Import Certificate	Click this button to save the certificate that you have enrolled from a certification authority from your computer to the Zyxel Device.
Create Certificate Request	Click this button to go to the screen where you can have the Zyxel Device generate a certification request.
Current File	This field displays the name used to identify this certificate. It is recommended that you give each certificate a unique name.
Subject	This field displays identifying information about the certificate's owner, such as CN (Common Name), OU (Organizational Unit or department), O (Organization or company) and C (Country). It is recommended that each certificate have a unique subject information.
Issuer	This field displays identifying information about the certificate's issuing certification authority, such as a common name, organizational unit or department, organization or company and country.
Valid From	This field displays the date that the certificate becomes applicable. The text displays in red and includes a Not Yet Valid! message if the certificate has not yet become applicable.
Valid To	This field displays the date that the certificate expires. The text displays in red and includes an Expiring! or Expired! message if the certificate is about to expire or has already expired.
Modify	Click the View icon to open a screen with an in-depth list of information about the certificate. For a certification request, click Load Signed to import the signed certificate. Click the Remove icon to remove the certificate (or certification request). A window displays asking you to confirm that you want to delete the certificate. Note that subsequent certificates move up by one when you take this action.

16.2.1 Create Certificate Request

Click **Security > Certificates > Local Certificates** and then **Create Certificate Request** to open the following screen. Use this screen to have the Zyxel Device generate a certification request. To create a certificate signing request, you need to enter a common name, organization name, state/province name, and the two-letter country code for the certificate.

Figure 150 Create Certificate Request

The following table describes the labels in this screen.

Table 77 Create Certificate Request

LABEL	DESCRIPTION
Certificate Name	Type up to 63 ASCII characters (not including spaces) to identify this certificate.
Common Name	Select Auto to have the Zyxel Device configure this field automatically. Or select Customize to enter it manually. Type the IP address (in dotted decimal notation), domain name or email address in the field provided. The domain name or email address can be up to 63 ASCII characters. The domain name or email address is for identification purposes only and can be any string.
Organization Name	Type up to 63 characters to identify the company or group to which the certificate owner belongs. You may use any character, including spaces, but the Zyxel Device drops trailing spaces.
State/Province Name	Type up to 32 characters to identify the state or province where the certificate owner is located. You may use any character, including spaces, but the Zyxel Device drops trailing spaces.
Country/Region Name	Select a country to identify the nation where the certificate owner is located.
Cancel	Click Cancel to exit this screen without saving.
OK	Click OK to save your changes.

16.2.2 View Certificate Request

Use this screen to view in-depth information about the certificate request. The **Certificate** is used to verify the authenticity of the certification authority. The **Private Key** serves as your digital signature for authentication and must be safely stored. The **Signing Request** contains the certificate signing request value that you will copy upon submitting the certificate request to the CA (certificate authority).

Click the **View** icon in the **Local Certificates** screen to open the following screen.

Figure 151 Certificate Request: View

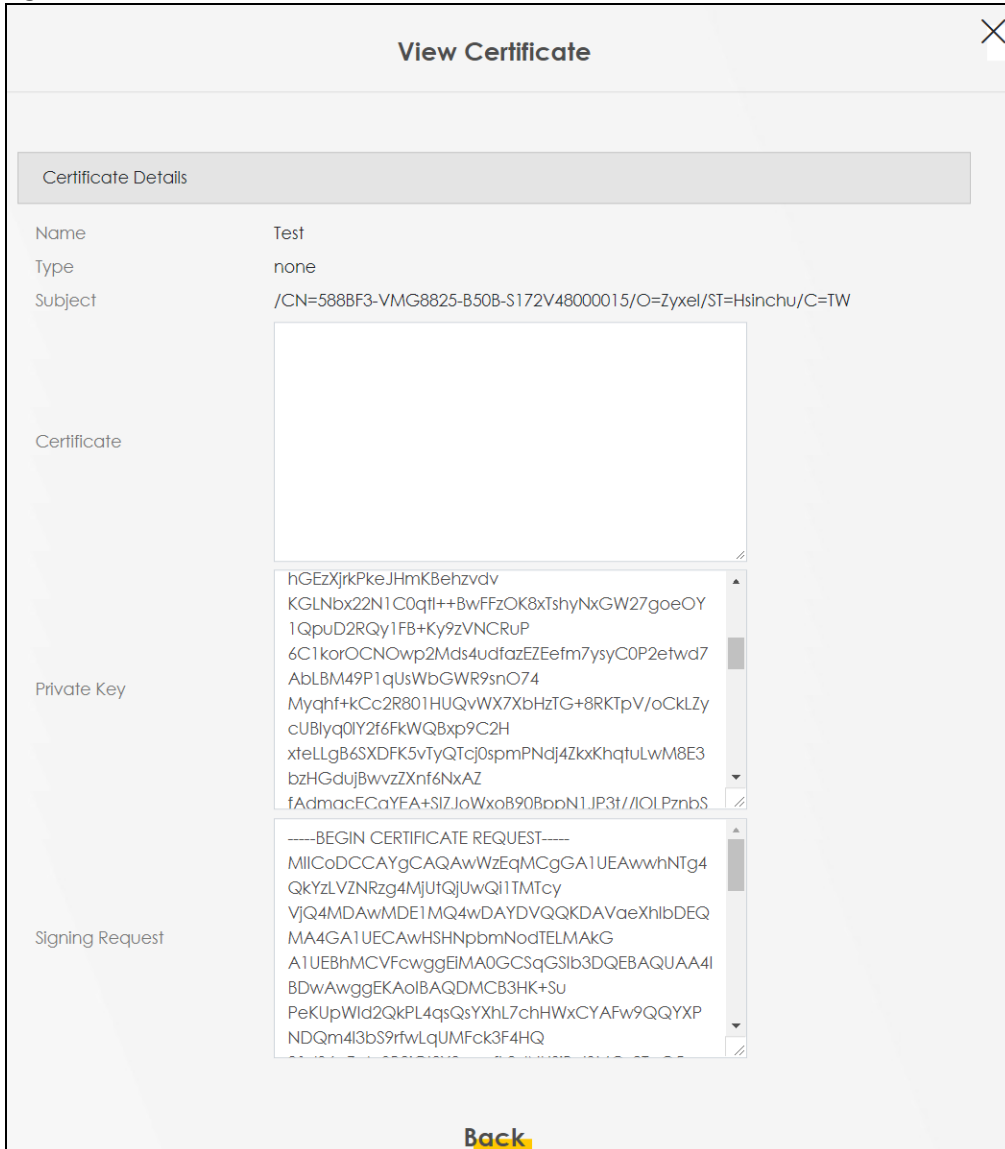

The following table describes the fields in this screen.

Table 78 Certificate Request: View

LABEL	DESCRIPTION
Name	This field displays the identifying name of this certificate.
Type	This field displays general information about the certificate. ca means that a Certification Authority signed the certificate.
Subject	This field displays information that identifies the owner of the certificate, such as Common Name (CN), Organizational Unit (OU), Organization (O) and Country (C).
Certificate	This read-only text box displays the certificate in Privacy Enhanced Mail (PEM) format. PEM uses base 64 to convert the binary certificate into a printable form. You can copy and paste the certificate into an email to send to friends or colleagues or you can copy and paste the certificate into a text editor and save the file on a management computer for later distribution.
Private Key	This field displays the private key of this certificate.

Table 78 Certificate Request: View (continued)

LABEL	DESCRIPTION
Signing Request	This field displays the CSR (Certificate Signing Request) information of this certificate. The CSR will be provided to a certificate authority, and it includes information about the public key, organization name, domain name, location, and country of this certificate.
Back	Click Back to return to the previous screen.

16.3 Trusted CA

Click **Security > Certificates > Trusted CA** to open the following screen. This screen displays a summary list of certificates of the certification authorities that you have set the Zyxel Device to accept as trusted. The Zyxel Device accepts any valid certificate signed by a certification authority on this list as being trustworthy, which means you do not need to import any certificate that is signed by one of these certification authorities.

Note: A maximum of 4 certificates can be added.

Figure 152 Security > Certificates > Trusted CA



The following table describes the labels in this screen.

Table 79 Security > Certificates > Trusted CA

LABEL	DESCRIPTION
Import Certificate	Click this button to open a screen where you can save the certificate of a certification authority that you trust to the Zyxel Device.
#	This is the index number of the entry.
Name	This field displays the name used to identify this certificate.
Subject	This field displays information that identifies the owner of the certificate, such as Common Name (CN), OU (Organizational Unit or department), Organization (O), State (ST) and Country (C). It is recommended that each certificate have a unique subject information.
Type	This field displays general information about the certificate. ca means that a Certification Authority signed the certificate.
Modify	Click the View icon to open a screen with an in-depth list of information about the certificate (or certification request). Click the Remove icon to delete the certificate (or certification request). You cannot delete a certificate that one or more features is configured to use.

16.4 Import Trusted CA Certificate

Click **Import Certificate** in the **Trusted CA** screen to open the **Import Certificate** screen. The Zyxel Device trusts any valid certificate signed by any of the imported trusted CA certificates. Certificates should be in one of the following formats: Binary X.509, PEM (base-64) encoded, Binary PKCS#7, or PEM (base-64) encoded PKCS#7.

Note: You must remove any spaces from the certificate's filename before you can import the certificate.

Figure 153 Trusted CA > Import

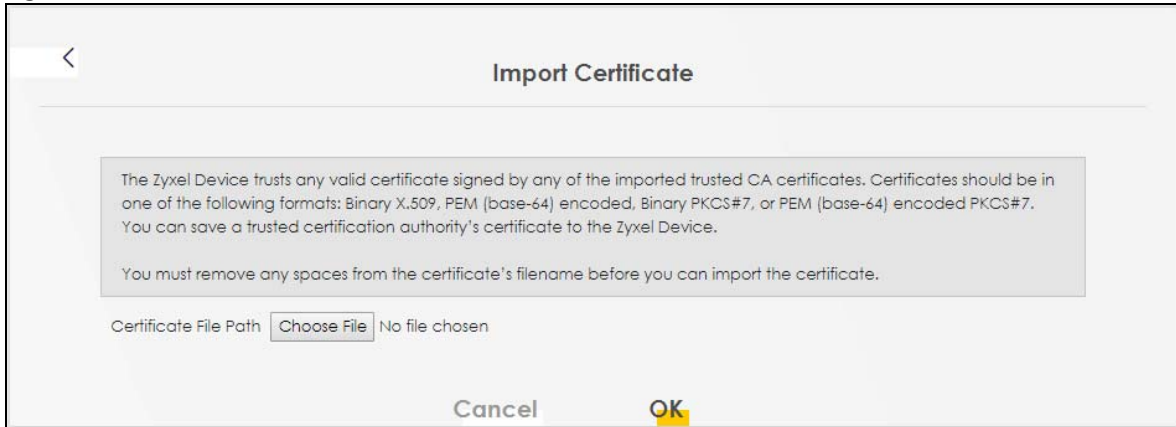

The following table describes the labels in this screen.

Table 80 Security > Certificates > Trusted CA > Import

LABEL	DESCRIPTION
Certificate File Path	Type in the location of the file you want to upload in this field or click Choose File to find it.
Choose File	Click this button to find the certificate file you want to upload.
OK	Click this to save the certificate on the Zyxel Device.
Cancel	Click this to exit this screen without saving.

16.5 View Trusted CA Certificate

Use this screen to view in-depth information about the certification authority's certificate. The certificate text box is read-only and can be distributed to others.

Click **Security > Certificates > Trusted CA** to open the **Trusted CA** screen. Click the **View** icon to open the **View Certificate** screen.

Figure 154 Trusted CA: View

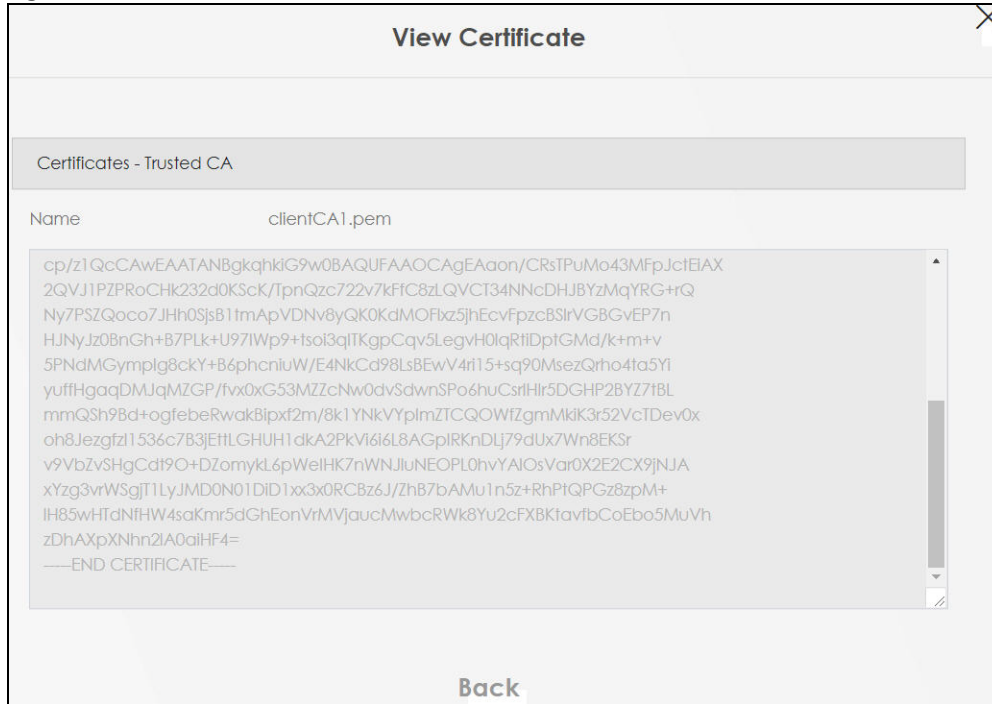

The following table describes the labels in this screen.

Table 81 Trusted CA: View

LABEL	DESCRIPTION
Name	This field displays the identifying name of this certificate.
	This read-only text box displays the certificate or certification request in Privacy Enhanced Mail (PEM) format. PEM uses 64 ASCII characters to convert the binary certificate into a printable form. You can copy and paste the certificate into an email to send to friends or colleagues or you can copy and paste the certificate into a text editor and save the file on a management computer for later distribution (via USB thumb drive for example).
Back	Click this to return to the previous screen.

16.6 Certificates Technical Reference

This section provides some technical background information about the topics covered in this chapter.

Certification Authorities

A Certification Authority (CA) issues certificates and guarantees the identity of each certificate owner. There are commercial certification authorities like CyberTrust or VeriSign and government certification authorities.

Public and Private Keys

When using public-key cryptology for authentication, each host has two keys. One key is public and can be made openly available; the other key is private and must be kept secure. Public-key encryption in general works as follows.

- 1 Tim wants to send a private message to Jenny. Tim generates a public-private key pair. What is encrypted with one key can only be decrypted using the other.
- 2 Tim keeps the private key and makes the public key openly available.
- 3 Tim uses his private key to encrypt the message and sends it to Jenny.
- 4 Jenny receives the message and uses Tim's public key to decrypt it.
- 5 Additionally, Jenny uses her own private key to encrypt a message and Tim uses Jenny's public key to decrypt the message.

The Zyxel Device uses certificates based on public-key cryptology to authenticate users attempting to establish a connection. The method used to secure the data that you send through an established connection depends on the type of connection. For example, a VPN tunnel might use the triple DES encryption algorithm.

The certification authority uses its private key to sign certificates. Anyone can then use the certification authority's public key to verify the certificates.

Advantages of Certificates

Certificates offer the following benefits.

- The Zyxel Device only has to store the certificates of the certification authorities that you decide to trust, no matter how many devices you need to authenticate.
- Key distribution is simple and very secure since you can freely distribute public keys and you never need to transmit private keys.

Certificate File Format

The certification authority certificate that you want to import has to be in PEM (Base-64) encoded X.509 file format. This Privacy Enhanced Mail format uses 64 ASCII characters to convert a binary X.509 certificate into a printable form.

16.6.1 Verify a Certificate

Before you import a trusted CA or trusted remote host certificate into the Zyxel Device, you should verify that you have the actual certificate. This is especially true of trusted CA certificates since the Zyxel Device also trusts any valid certificate signed by any of the imported trusted CA certificates.

You can use a certificate's fingerprint to verify it. A certificate's fingerprint is a message digest calculated using the MD5 or SHA1 algorithms. The following procedure describes how to check a certificate's fingerprint to verify that you have the actual certificate.

- 1 Browse to where you have the certificate saved on your computer.

- 2 Make sure that the certificate has a ".cer" or ".crt" file name extension.

Figure 155 Certificates on Your Computer

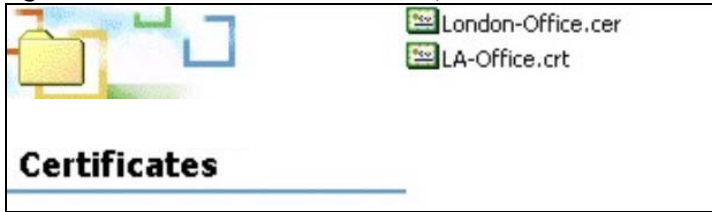

- 3 Double-click the certificate's icon to open the **Certificate** window. Click the **Details** tab and scroll down to the **Thumbprint Algorithm** and **Thumbprint** fields.

Figure 156 Certificate Details

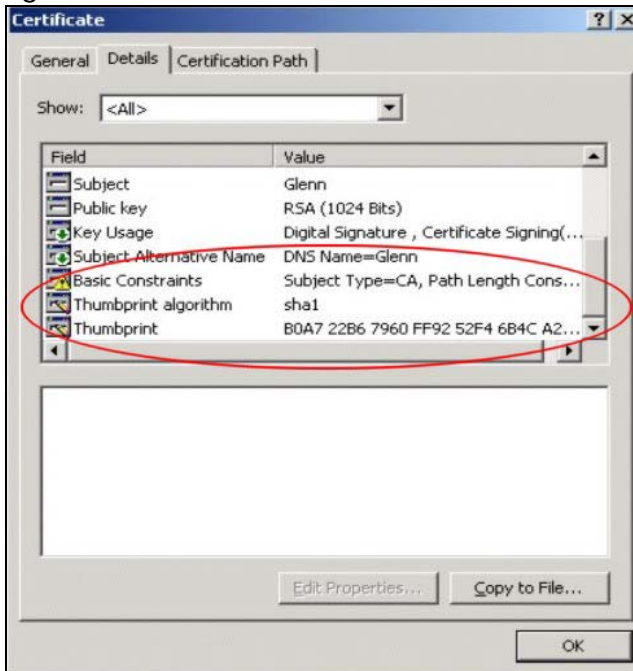

Use a secure method to verify that the certificate owner has the same information in the **Thumbprint Algorithm** and **Thumbprint** fields. The secure method may vary based on your situation. Possible examples would be over the telephone or through an HTTPS connection.

CHAPTER 17

Voice

17.1 Overview

4G only supports all-IP-based packet-switched telephony services. When Voice service is enabled, the Zyxel Device supports Circuit Switched FallBack (CSFB) to deliver/receive circuit-switched voice calls and text messages via a 3G mobile network and then goes back to the 4G LTE network to transmit data packets.

With the voice service, users do not need a SIP account and SIP server to make phone calls over the Internet.

17.1.1 What You Can Do in this Chapter

These screens allow you to configure your Zyxel Device to make phone calls over the Internet and your regular phone line, and to set up the phone you connect to the Zyxel Device.

- Use the **Voice Mode** screen to enable VoIP or VoLTE services on the Zyxel Device ([Section 17.2 on page 210](#)).
- Use the **SIP Account** screen to set up information about your SIP account, control which SIP accounts the phones connected to the LTE Device use and configure audio settings such as volume levels for the phones connected to the ZyxEL Device ([Section 17.3.1 on page 211](#)).
- Use the **SIP Service Provider** screen to configure the SIP server information, and the numbers for certain phone functions ([Section 17.3.3 on page 215](#)).
- Use the **Phone** screen to change settings that depend on which region of the world the Zyxel Device is in ([Section 17.4 on page 219](#)).
- Use the **Call Rule** screen to set up shortcuts for dialing frequently-used (VoIP) phone numbers ([Section 17.5 on page 219](#)).
- Use the **Call History** screen to view a call history list([Section 17.6 on page 220](#)).

17.2 Voice Mode

Use this screen to enable VoIP or VoLTE services on the Zyxel Device. To access this screen, click **Voice > Voice Mode**.

Figure 157 Voice > Voice Mode

The following table describes the labels in this screen.

Table 82 Voice > Voice Mode

LABEL	DESCRIPTION
Configuration	
Voice Service	Select Enable to activate VoIP or VoLTE on the Zyxel Device.
Apply	Click Apply to save the settings.
Cancel	Click Cancel to start configuring this screen again.

17.3 SIP

SIP stands for Session Initiation Protocol. SIP is a signalling standard that lets one network device (like a computer or the Zyxel Device) send messages to another. In VoIP, these messages are about phone calls over the network. For example, when you dial a number on your Zyxel Device, it sends a SIP message over the network asking the other device (the number you dialed) to take part in the call. To access this screen, click **Voice > SIP**.

17.3.1 SIP Account

You can make calls over the Internet using VoIP technology. For this, you first need to set up a SIP account with a SIP service provider. The Zyxel Device uses a SIP account to make outgoing VoIP calls, and to check if an incoming call's destination number matches your SIP account's VoIP number. In order to make and receive VoIP calls, you need to enable and configure a SIP account, and then map it to a phone port. The SIP account contains information that allows your Zyxel Device to connect to your VoIP service provider.

To access this screen, click **Voice > SIP > SIP Account**.

Figure 158 Voice > SIP > SIP Account.

#	Enable	SIP Account	Service Provider	Account Number	Modify
1	Disabled	SIP1	ChangeMe	ChangeMe	

The following table describes the labels in this screen.

Table 83 Voice > SIP > SIP Account

LABEL	DESCRIPTION
#	This is the index number of the entry.
Enable	This shows whether the SIP account is activated or not. A yellow bulb signifies that this SIP account is activated. A gray bulb signifies that this SIP account is activated.
SIP Account	This shows the name of the SIP account.
Service Provider	This shows the name of the SIP service provider.
Account Number	This shows the SIP number.
Modify	Click the Modify icon to configure the SIP account.

17.3.2 SIP Account Entry Edit

You can configure a SIP account. To access this screen, click the **Modify** icon.

Figure 159 Voice > SIP > SIP Account > SIP Account Entry Edit

The following table describes the labels in this screen.

Table 84 Voice > SIP > SIP Account > SIP Account Entry Edit

LABEL	DESCRIPTION
SIP Service Provider Association	
SIP Service Provider Associated with	Select the check box to use this account. Clear it to not use this account.
General	
SIP Account Number	Enter your SIP number. In the full SIP URI, this is the part before the @ symbol. You can use up to 127 printable ASCII characters.
Authentication	
User Name	Enter the user name for registering this SIP account, exactly as it was given to you. You can use up to 95 printable ASCII characters.

Table 84 Voice > SIP > SIP Account > SIP Account Entry Edit (continued)

LABEL	DESCRIPTION
Password	Enter the password for registering this SIP account, exactly as it was given to you. You can use up to 95 printable ASCII characters.
URL Type	
URL Type	<p>Select whether or not to include the SIP service domain name when the LTE Device sends the SIP number.</p> <p>SIP - include the SIP service domain name.</p> <p>TEL - do not include the SIP service domain name.</p>
Voice Features	
Primary Compression Type Secondary Compression Type Third Compression Type	<p>Select the type of voice coder/decoder (codec) that you want the LTE Device to use.</p> <p>G.711 provides higher voice quality but requires more bandwidth (64 kbps).</p> <ul style="list-style-type: none"> • G.729 provides good sound quality and reduces the required bandwidth to 8 kbps. • G.711a is typically used in Europe. • G.711u is typically used in North America and Japan. • G.726-32 operates at 16, 24, 32 or 40 kbps. • G.722 operates at 6.3 kbps or 5.3 kbps. <p>When two SIP devices start a SIP session, they must agree on a codec.</p> <p>Select the LTE Device's first choice for voice coder/decoder.</p> <p>Select the LTE Device's second choice for voice coder/decoder. Select None if you only want the LTE Device to accept the first choice.</p> <p>Select the LTE Device's third choice for voice coder/decoder. Select None if you only want the LTE Device to accept the first or second choice.</p>
Speaking Volume Control	Select the loudness that the LTE Device uses for speech that it sends to the peer device. Choices are Minimum, Middle, and Maximum.
Listening Volume Control	Select the loudness that the LTE Device uses for speech that it receives from the peer device. Choices are Minimum, Middle, and Maximum.
Enable G. 168	Select this if you want to eliminate the echo caused by the sound of your voice reverberating in the telephone receiver while you talk.
Enable VAD	Select this if the LTE Device should stop transmitting when you are not speaking. This reduces the bandwidth the LTE Device uses.
Call Features	
Send Caller ID	Select this if you want to send identification when you make VoIP phone calls. Clear this if you do not want to send identification.
Enable Call Waiting	Select this to enable call waiting on the LTE Device. This allows you to place a call on hold while you answer another incoming call on the same telephone (directory) number.
Call Waiting Reject Timer	Specify a time of seconds that the LTE Device waits before rejecting the second call if you do not answer it.
Enable Do Not Disturb (DND)	Select this to turn the do not disturb feature on. This has the Zyxel Device reject all calls destined to the phone line.
Active Incoming Anonymous Call Block	Select this to have the phone not ring for incoming calls with caller ID deactivated.
OK	Click this to save your changes.
Cancel	Click this to exit this screen without saving.

17.3.3 SIP Service Provider

Use this screen to view the SIP service provider information on the Zyxel Device. A SIP provider offers Internet call services using VoIP technology. You may need to consult your SIP service provider for the following settings. To access this screen, click **Voice > SIP > SIP Service Provider**.

Figure 160 Voice > SIP > SIP Service Provider

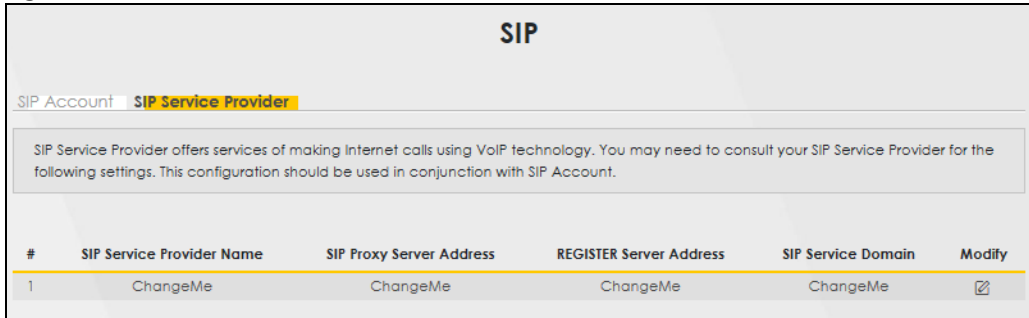

The following table describes the labels in this screen.

Table 85 Voice > SIP > SIP Service Provider

LABEL	DESCRIPTION
#	This is the index number of the entry.
SIP Service Provider Name	This shows the name of the SIP service provider.
SIP Proxy Server Address	This shows the IP address or domain name of the SIP server.
Register Server Address	This shows the IP address or domain name of the SIP register server.
SIP Service Domain	Enter the SIP service domain name. In the full SIP URI, this is the part after the @symbol. You can use up to 127 printable ASCII Extended set characters.
Modify	Click the Modify icon to configure the profile of SIP service provider settings.

17.3.4 Provider Entry Edit

Use this screen to configure the SIP server information, the numbers for certain phone functions and dialing plan for a SIP service provider. Click **Voice > SIP > SIP Service Provider** and then click the **Modify** icon next to a profile of SIP service provider settings to open the following screen.

Figure 161 Voice > SIP > SIP Service Provider: Edit

Provider Entry Edit

SIP Service Provider Selection
Service Provider Selection: ChangeMe

General

SIP Service Provider: Enable SIP Service Provider

SIP Service Provider Name: ChangeMe

SIP Local Port: 5040 (1025-65535)

SIP Proxy Server Address: ChangeMe

SIP Proxy Server Port: 5040 (1025-65535)

SIP REGISTRAR Server Address: ChangeMe

SIP REGISTRAR Server Port: 5040 (1025-65535)

SIP Service Domain: ChangeMe

RFC Support

PRACK (RFC 3262, Require: 100rel)

VoIP IOP Flags

Replace dial digit '#' to '%23' in SIP messages

Remove the 'Route' header in SIP messages

Bound Interface Name

Bound Interface Name: AnyWAN MultWAN

Outbound Proxy

Outbound Proxy Address:

Outbound Proxy Port: 5040 (1025-65535)

Use DHCP Option 120 First

RTP Port Range

Start Port: 40000 (1024-65535)

End Port: 40010 (1044-65500)

DTMF Mode

DTMF Mode: RFC 2833

Transport Type

Transport Type: UDP

Ignore Direct IP

Enable Disable

FAX Option

G.711 Fax Passthrough T.38 Fax Relay

GoS Tag

SIP DSCP Mark Setting: 46 (0-43)

RTP DSCP Mark Setting: 46 (0-43)

Timer Setting

SIP Register Expiration Duration: 3600 (60-65535) seconds

SIP Register Fail Re-try Timer: 1800 (180-65535) seconds

Session Expires (SE): 900 (100-3600) seconds

Min-SE: 600 (90-1800) seconds

Dialing Interval Selection

Dialing Interval Selection: 3 seconds

DNS SRV

Enable DNS SRV

Cancel OK

The following table describes the labels in this screen.

Table 86 Voice > SIP > SIP Service Provider: Edit

LABEL	DESCRIPTION
General	
SIP Service Provider	Select this if you want the Zyxel Device to use this SIP provider. Clear it if you do not want the Zyxel Device to use this SIP provider.
SIP Service Provider Name	Enter the name of your SIP service provider.
SIP Local Port	Enter the Zyxel Device's listening port number, if your VoIP service provider gave you one. Otherwise, keep the default value.
SIP Proxy Server Address	Enter the IP address or domain name of the SIP server provided by your VoIP service provider. You can use up to 95 printable ASCII characters. It does not matter whether the SIP server is a proxy, redirect or register server.

Table 86 Voice > SIP > SIP Service Provider: Edit (continued)

LABEL	DESCRIPTION
SIP Proxy Server Port	Enter the SIP server's listening port number, if your VoIP service provider gave you one. Otherwise, keep the default value.
SIP REGISTAR Server Address	Enter the IP address or domain name of the SIP register server, if your VoIP service provider gave you one. Otherwise, enter the same address you entered in the SIP Server Address field. You can use up to 95 printable ASCII characters.
SIP REGISTAR Server Port	Enter the SIP register server's listening port number, if your VoIP service provider gave you one. Otherwise, enter the same port number you entered in the SIP Server Port field.
SIP Service Domain	Enter the SIP service domain name. In the full SIP URI, this is the part after the @ symbol. You can use up to 127 printable ASCII Extended set characters.
RFC Support	
PRACK (RFC 3262)	<p>RFC 3262 defines a mechanism to provide reliable transmission of SIP provisional response messages, which convey information on the processing progress of the request. This uses the option tag 100rel and the Provisional Response ACKnowledgement (PRACK) method.</p> <p>Select Supported or Required to have the Zyxel Device include a SIP Require/Supported header field with the option tag 100rel in all INVITE requests. When the Zyxel Device receives a SIP response message indicating that the phone it called is ringing, the Zyxel Device sends a PRACK message to have both sides confirm the message is received.</p> <p>If you select Supported, the peer device supports the option tag 100rel to send provisional responses reliably.</p> <p>If you select Required, the peer device requires the option tag 100rel to send provisional responses reliably.</p> <p>Select Disabled to turn off this function.</p>
VoIP IOP Flags - Select VoIP inter-operability settings.	
	Replace dial digit '#' to '%23' in SIP messages.
	Remove ':5060' and 'transport=udp' from request-uri in SIP messages.
	Remove the 'Route' header in SIP messages.
	Don't send re-Invite to the remote party when there are multiple codecs answered in the Session Description Protocol (SDP).
	Remove the 'Authentication' header in SIP ACK messages.
Bound Interface Name	
Bound Interface Name	<p>If you select AnyWAN, the Zyxel Device automatically activates the VoIP service when any WAN connection is up.</p> <p>If you select MultiWAN, you also need to select the pre-configured WAN connections. The VoIP service is activated only when one of the selected WAN connections is up.</p>
Outbound Proxy	
Enable	Select this if your VoIP service provider has a SIP outbound server to handle voice calls. This allows the Zyxel Device to work with any type of NAT router and eliminates the need for STUN or a SIP ALG. Turn off any SIP ALG on a NAT router in front of the Zyxel Device to keep it from re-translating the IP address (since this is already handled by the outbound proxy server).
Outbound Proxy Address	Enter the IP address or domain name of the SIP outbound proxy server.
Outbound Proxy Port	Enter the SIP outbound proxy server's listening port, if your VoIP service provider gave you one. Otherwise, keep the default value.
Use DHCP Option 120 first	Select this to have the Zyxel Device use DHCP Option 120 first.

Table 86 Voice > SIP > SIP Service Provider: Edit (continued)

LABEL	DESCRIPTION
RTP Port Range	
Start Port End Port	<p>Enter the listening port number(s) for RTP traffic, if your VoIP service provider gave you this information. Otherwise, keep the default values.</p> <p>To enter one port number, enter the port number in the Start Port and End Port fields.</p> <p>To enter a range of ports,</p> <ul style="list-style-type: none"> • enter the port number at the beginning of the range in the Start Port field. • enter the port number at the end of the range in the End Port field.
DTMF Mode	<p>Control how the Zyxel Device handles the tones that your telephone makes when you push its buttons. You should use the same mode your VoIP service provider uses.</p> <p>RFC2833 - send the DTMF tones in RTP packets.</p> <p>Inband - send the DTMF tones in the voice data stream. This method works best when you are using a codec that does not use compression (like G.711). Codecs that use compression (like G.726) can distort the tones.</p> <p>SIPInfo - send the DTMF tones in SIP messages.</p>
Transport Type	
Transport Type	Select the transport layer protocol UDP or TCP (usually UDP) used for SIP.
Ignore Direct IP	Select Enable to have the connected devices accept SIP requests only from the SIP proxy/register server specified above. SIP requests sent from other IP addresses will be ignored.
FAX Option	This field controls how the Zyxel Device handles fax messages.
QoS Tag	
SIP DSCP Mark Setting	Enter the DSCP (DiffServ Code Point) number for SIP message transmissions. The Zyxel Device creates Class of Service (CoS) priority tags with this number to SIP traffic that it transmits.
RTP DSCP Mark Setting	Enter the DSCP (DiffServ Code Point) number for RTP voice transmissions. The Zyxel Device creates Class of Service (CoS) priority tags with this number to RTP traffic that it transmits.
Timer Setting	
SIP Register Expiration Duration	Enter the number of seconds your SIP account is registered with the SIP register server before it is deleted. The Zyxel Device automatically tries to re-register your SIP account when one-half of this time has passed (The SIP register server might have a different expiration).
SIP Register Fall Re-try timer	Enter the number of seconds the Zyxel Device waits before it tries again to register the SIP account, if the first try failed or if there is no response.
Session Expires [SE]	Enter the number of seconds the Zyxel Device lets a SIP session remain idle (without traffic) before it automatically disconnects the session.
Min-SE	Enter the minimum number of seconds the Zyxel Device lets a SIP session remain idle (without traffic) before it automatically disconnects the session. When two SIP devices start a SIP session, they must agree on an expiration time for idle sessions. This field is the shortest expiration time that the Zyxel Device accepts.
Dialing interval selection	
Dialing interval selection	Enter the number of seconds the Zyxel Device should wait after you stop dialing numbers before it makes the phone call. The value depends on how quickly you dial phone numbers.
Enable DNS SRV	Select this to have the Zyxel Device query your ISP's DNS server for a list of any available SIP servers that it maintains. This is useful if your static SIP server experiences difficulties, making it hard for your IP phone users to make SIP calls.

Table 86 Voice > SIP > SIP Service Provider: Edit (continued)

LABEL	DESCRIPTION
OK	Click this to save your changes.
Cancel	Click this to exit this screen without saving.

17.4 Phone

Use this screen to configure settings that depend on which region of the world the Zyxel Device is in. Selecting the region where the device is physically located improves the quality of phone calls. To access this screen, click **Voice > Phone**.

Figure 162 Voice > Phone

The following table describes the labels in this screen.

Table 87 Voice > Phone

LABEL	DESCRIPTION
Region Setting	Select the place in which the Zyxel Device is located.
Call Service Mode	Select the mode for supplementary phone services (call hold, call waiting, call transfer and three-way conference calls) that your VoIP service provider supports. <ul style="list-style-type: none"> • Europe Type - use supplementary phone services in European mode. • USA Type - use supplementary phone services American mode. You might have to subscribe to these services to use them. Contact your VoIP service provider.
Apply	Click this to save your changes and to apply them to the Zyxel Device.
Cancel	Click this to set every field in this screen to its last-saved value.

Note: You need to reboot the device after changing the region settings for it to take effect.

17.5 Call Rule

Use this screen to add, edit, or remove speed-dial numbers for outgoing calls. Speed dial provides shortcuts for dialing frequently-used (VoIP) phone numbers. You also have to create speed-dial entries if you want to call SIP numbers that contain letters. Once you have configured a speed dial rule, you can use a shortcut (the speed dial number, #01 for example) on your phone's keypad to call the phone number. To access this screen, click **Voice > Call Rule**.

Figure 163 Voice > Call Rule

Call Rule

When certain phone numbers are dialed on a regular basis, Speed Dial accelerates dialing process. The following rules apply to all the phone devices connected to this device.

[Clear All Speed Dials](#)

Keys	Number	Description
#01		
#02		
#03		
#04		
#05		
#06		
#07		
#08		
#09		
#10		

[Cancel](#) [Apply](#)

The following table describes the labels in this screen.

Table 88 Voice > Call Rule

LABEL	DESCRIPTION
Keys	This field displays the speed-dial number you should dial to use this entry.
Number	Enter the SIP number you want the Zyxel Device to call when you dial the speed-dial number.
Description	Enter a short description to identify the party you call when you dial the speed-dial number. You can use up to 127 printable ASCII characters.
Clear All Speed Dials	Click this button to remove all speed dials saved.
Apply	Click this to save your changes and to apply them to the Zyxel Device.
Cancel	Click this to set every field in this screen to its last-saved value.

17.6 Call History

The Zyxel Device logs calls from or to your SIP addresses. This screen allows you to view a summary of received, dialed and missed calls and a call history list. You can also view detailed information on each outgoing and incoming call.

17.6.1 Call History Screen

To access this screen, click **Voice > Call History**.

Figure 164 Voice > Call History

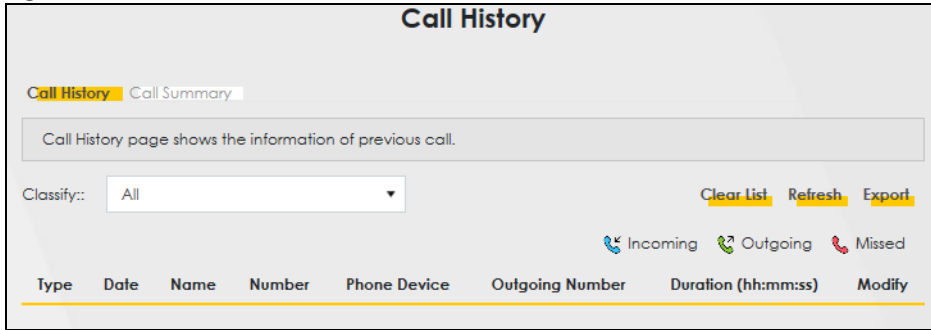

The following table describes the labels in this screen.

Table 89 Voice > Call History

LABEL	DESCRIPTION
Classify	Select the type of the calls. The call types are: Incoming, Outgoing and Missed.
Clear List	Click this button to remove all entries from the call history list.
Refresh	Click this button to renew the call history list.
Export	Click Export to download a call history list.
Type	This displays the type of the calls.
Date	This displays the date when the calls were made.
Name	This displays the SIP account you called.
Number	This displays the SIP number you called.
Phone Device	This field displays the name of a phone port on the Zyxel Device.
Outgoing Number	This displays how many calls originated from you that day.
Duration	This displays how long the current call has lasted.
Modify	Click the Modify icon to make changes to the call history.

17.6.2 Call Summary Screen

The Zyxel Device logs calls to or from your SIP addresses. This screen allows you to view the summary of received, dialed and missed calls. To access this screen, click **Voice > Call History > Call Summary**.

Figure 165 Voice > Call History > Call Summary

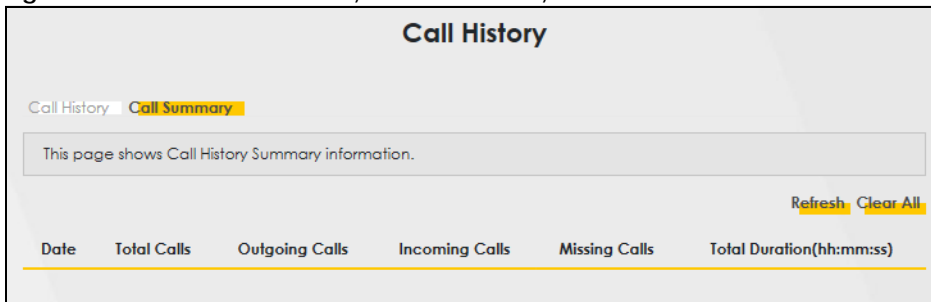

The following table describes the labels in this screen.

Table 90 Voice > Call History > Call Summary

LABEL	DESCRIPTION
Refresh	Click this button to renew the call history list.
Clear All	Click this button to remove all entries from the call history list.
Date	This is the date when the calls were made.
Total Calls	This displays the total number of calls from or to your SIP numbers that day.
Outgoing Calls	This displays how many calls originated from you that day.
Incoming Calls	This displays how many calls you received that day.
Missing Calls	This displays how many incoming calls were not answered that day.
Total Duration	This displays how long all calls lasted that day.

CHAPTER 18

Log

18.1 Log Overview

These screens allow you to determine the categories of events and/or alerts that the Zyxel Device logs and then display these logs or have the Zyxel Device send them to an administrator (through email) or to a syslog server.

18.1.1 What You Can Do in this Chapter

- Use the **System Log** screen to see the system logs ([Section 18.2 on page 224](#)).
- Use the **Security Log** screen to see the security-related logs for the categories that you select ([Section 18.3 on page 224](#)).

18.1.2 What You Need To Know

The following terms and concepts may help as you read this chapter.

Alerts and Logs

An alert is a type of log that warrants more serious attention. They include system errors, attacks (access control) and attempted access to blocked web sites. Some categories such as **System Errors** consist of both logs and alerts. You may differentiate them by their color in the **View Log** screen. Alerts display in red and logs display in black.

Syslog Overview

The syslog protocol allows devices to send event notification messages across an IP network to syslog servers that collect the event messages. A syslog-enabled device can generate a syslog message and send it to a syslog server.

Syslog is defined in RFC 3164. The RFC defines the packet format, content and system log related information of syslog messages. Each syslog message has a facility and severity level. The syslog facility identifies a file in the syslog server. Refer to the documentation of your syslog program for details. The following table describes the syslog severity levels.

Table 91 Syslog Severity Levels

CODE	SEVERITY
0	Emergency: The system is unusable.
1	Alert: Action must be taken immediately.
2	Critical: The system condition is critical.
3	Error: There is an error condition on the system.
4	Warning: There is a warning condition on the system.

Table 91 Syslog Severity Levels

CODE	SEVERITY
5	Notice: There is a normal but significant condition on the system.
6	Informational: The syslog contains an informational message.
7	Debugging: The message is intended for debug-level purposes.

18.2 System Log

Use the **System Log** screen to see the system logs. You can filter the entries by selecting a severity level and/or category. Click **System Monitor > Log** to open the **System Log** screen.

Figure 166 System Monitor > Log > System Log

Export or email the system logs. You can filter the entries by clicking the **Level** and/or **Category** drop-down list boxes.

Level: Category: [Clear Log](#) [Refresh](#) [Export Log](#) [E-mail Log Now](#)

#	Time	Facility	Level	Category	Messages
---	------	----------	-------	----------	----------

The following table describes the fields in this screen.

Table 92 System Monitor > Log > System Log

LABEL	DESCRIPTION
Level	Select a severity level from the drop-down list box. This filters search results according to the severity level you have selected. When you select a severity, the Zyxel Device searches through all logs of that severity or higher.
Category	Select the type of logs to display.
Clear Log	Click this to delete all the logs.
Refresh	Click this to renew the log screen.
Export Log	Click this to export the selected log(s).
Email Log Now	Click this to send the log file(s) to the email address you specify in the Maintenance > Logs Setting screen.
#	This field is a sequential value and is not associated with a specific entry.
Time	This field displays the time the log was recorded.
Facility	The log facility allows you to send logs to different files in the syslog server. Refer to the documentation of your syslog program for more details.
Level	This field displays the severity level of the log that the device is to send to this syslog server.
Category	This field displays the type of the log.
Messages	This field states the reason for the log.

18.3 Security Log

Use the **Security Log** screen to see the security-related logs for the categories that you select. You can filter the entries by selecting a severity level and/or category. Click **System Monitor > Log > Security Log** to open the following screen.

Figure 167 System Monitor > Log > Security Log

View the security-related logs for the categories that you select. You can filter the entries by clicking the **Level** and/or **Category** drop-down list boxes.

Level: Category:

[Clear Log](#) [Refresh](#) [Export Log](#) [E-mail Log Now](#)

#	Time	Facility	Level	Category	Messages
---	------	----------	-------	----------	----------

The following table describes the fields in this screen.

Table 93 System Monitor > Log > Security Log

LABEL	DESCRIPTION
Level	Select a severity level from the drop-down list box. This filters search results according to the severity level you have selected. When you select a severity, the Zyxel Device searches through all logs of that severity or higher.
Category	Select the type of logs to display.
Clear Log	Click this to delete all the logs.
Refresh	Click this to renew the log screen.
Export Log	Click this to export the selected log(s).
Email Log Now	Click this to send the log file(s) to the email address you specify in the Maintenance > Logs Setting screen.
#	This field is a sequential value and is not associated with a specific entry.
Time	This field displays the time the log was recorded.
Facility	The log facility allows you to send logs to different files in the syslog server. Refer to the documentation of your syslog program for more details.
Level	This field displays the severity level of the log that the device is to send to this syslog server.
Category	This field displays the type of the log.
Messages	This field states the reason for the log.

CHAPTER 19

Traffic Status

19.1 Traffic Status Overview

Use the **Traffic Status** screens to look at the network traffic status and statistics of the WAN/LAN interfaces.

19.1.1 What You Can Do in this Chapter

- Use the **WAN** screen to view the WAN traffic statistics ([Section 19.2 on page 226](#)).
- Use the **LAN** screen to view the LAN traffic statistics ([Section 19.3 on page 227](#)).

19.2 WAN Status

Click **System Monitor > Traffic Status** to open the **WAN** screen. The figures in this screen show the number of bytes received and sent through the Zyxel Device's WAN interface. The table below shows packet statistics for each WAN interface.

Figure 168 System Monitor > Traffic Status > WAN

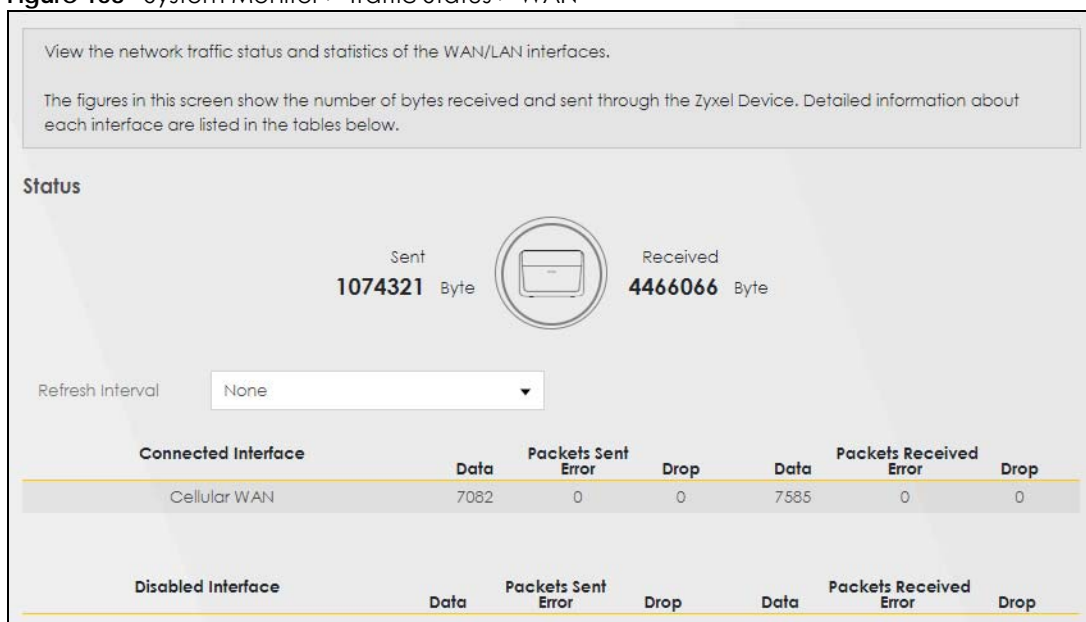

The following table describes the fields in this screen.

Table 94 System Monitor > Traffic Status > WAN

LABEL	DESCRIPTION
Refresh Interval	Select how often you want the Zyxel Device to update this screen.
Connected Interface	This shows the name of the WAN interface that is currently connected.
Packets Sent	
Data	This indicates the number of transmitted packets on this interface.
Error	This indicates the number of frames with errors transmitted on this interface.
Drop	This indicates the number of outgoing packets dropped on this interface.
Packets Received	
Data	This indicates the number of received packets on this interface.
Error	This indicates the number of frames with errors received on this interface.
Drop	This indicates the number of received packets dropped on this interface.
Disabled Interface	This shows the name of the WAN interface that is currently disabled.
Packets Sent	
Data	This indicates the number of transmitted packets on this interface.
Error	This indicates the number of frames with errors transmitted on this interface.
Drop	This indicates the number of outgoing packets dropped on this interface.
Packets Received	
Data	This indicates the number of received packets on this interface.
Error	This indicates the number of frames with errors received on this interface.
Drop	This indicates the number of received packets dropped on this interface.

19.3 LAN Status

Click **System Monitor > Traffic Status > LAN** to open the following screen. This screen allows you to view packet statistics for each LAN or WLAN interface on the Zyxel Device.

Figure 169 System Monitor > Traffic Status > LAN

Traffic Status			
WAN LAN			
Figures about data that have been sent to and received from each LAN port (including wireless) are displayed in the following table.			
Refresh Interval	30 seconds		
Interface	LAN	2.4G WLAN	5G WLAN
Bytes Sent	589466	1060	0
Bytes Received	480594	2664	0
Interface	LAN	2.4G WLAN	5G WLAN
Sent (Packet)	Data	2836	5
	Error	0	0
	Drop	0	0
Received (Packet)	Data	5096	28
	Error	0	8
	Drop	6	0

The following table describes the fields in this screen.

Table 95 System Monitor > Traffic Status > LAN

LABEL	DESCRIPTION
Refresh Interval	Select how often you want the Zyxel Device to update this screen.
Interface	This shows the LAN or WLAN interface.
Bytes Sent	This indicates the number of bytes transmitted on this interface.
Bytes Received	This indicates the number of bytes received on this interface.
Interface	This shows the LAN or WLAN interfaces.
Sent (Packets)	
Data	This indicates the number of transmitted packets on this interface.
Error	This indicates the number of frames with errors transmitted on this interface.
Drop	This indicates the number of outgoing packets dropped on this interface.
Received (Packets)	
Data	This indicates the number of received packets on this interface.
Error	This indicates the number of frames with errors received on this interface.
Drop	This indicates the number of received packets dropped on this interface.

CHAPTER 20

ARP Table

20.1 ARP Table Overview

Address Resolution Protocol (ARP) is a protocol for mapping an Internet Protocol (IP) address to a physical machine address, known as a Media Access Control (MAC) address, on the local area network.

An IP version 4 address is 32 bits long. MAC addresses are 48 bits long. The ARP table maintains an association between each MAC address and its corresponding IP address.

20.1.1 How ARP Works

When an incoming packet destined for a host device on a local area network arrives at the device, the device's ARP program looks in the ARP table and, if it finds the address, sends it to the device.

If no entry is found for the IP address, ARP broadcasts the request to all the devices on the LAN. The device fills in its own MAC and IP address in the sender address fields, and puts the known IP address of the target in the target IP address field. In addition, the device puts all ones in the target MAC field (FF.FF.FF.FF.FF.FF is the Ethernet broadcast address). The replying device (which is either the IP address of the device being sought or the router that knows the way) replaces the broadcast address with the target's MAC address, swaps the sender and target pairs, and unicasts the answer directly back to the requesting machine. ARP updates the ARP table for future reference and then sends the packet to the MAC address that replied.

20.2 ARP Table

Use the ARP table to view the IPv4-to-MAC address mappings for each device connected to the Zyxel Device. The neighbor table shows the IPv6-to-MAC address mappings of each IPv6 neighbor. To open this screen, click **System Monitor > ARP Table**.

Figure 170 System Monitor > ARP Table

ARP Table			
Address Resolution Protocol (ARP) is a protocol for mapping an Internet Protocol address (IP address) to a physical machine address, also known as a Media Access Control or MAC address, on the local area network.			
The ARP table maintains an association between each MAC address and its corresponding IP address.			
Use the ARP table to view the IPv4-to-MAC address mapping(s) for the LAN. The neighbor table shows the IPv6-to-MAC address mapping(s) of each neighbor.			
IPv4 ARP Table			
#	IPv4 Address	MAC Address	Device
1	192.168.1.129	dc:4a:3e:40:ec:5f	br0
2	192.168.1.93	74:f6:1c:0d:f1:69	br0
IPv6 Neighbour Table			
#	IPv6 Address	MAC Address	Device
1	fe80::ecad:ab45:c530:cc3f	dc:4a:3e:40:ec:5f	br0
2	fe80::2d8d:742c:122d:59ae	74:f6:1c:0d:f1:69	br0

The following table describes the labels in this screen.

Table 96 System Monitor > ARP Table

LABEL	DESCRIPTION
#	This is the ARP table entry number.
IPv4/IPv6 Address	This is the learned IPv4 or IPv6 IP address of a device connected to a port.
MAC Address	This is the MAC address of the device with the listed IP address.
Device	This is the type of interface used by the device. You can click the device type to go to its configuration screen.

CHAPTER 21

Routing Table

21.1 Routing Table Overview

Routing is based on the destination address only and the Zyxel Device takes the shortest path to forward a packet.

21.2 Routing Table

The table below shows IPv4 and IPv6 routing information. The IPv4 subnet mask is '255.255.255.255' for a host destination and '0.0.0.0' for the default route. The gateway address is written as '*'(IPv4)('/: '(IPv6) if none is set.

Click **System Monitor > Routing Table** to open the following screen.

Figure 171 System Monitor > Routing Table

Routing Table					
Routing is based on the destination address only and the Zyxel Device takes the shortest path to forward a packet.					
The table below shows IPv4 and IPv6 routing information. The destination can be a network or host. The IPv4 subnet mask is '255.255.255.255' for a host destination and '0.0.0.0' for the default route. The gateway address is written as '**' (IPv4) / '::' (IPv6) if none is set. Flags can be U - up, ! - reject, G - gateway, C - cache, H - host, R - reinstate, D - dynamic (redirect), or M - modified (redirect). Metric is the distance to the target (usually counted in hops). Interface is how the packets for this route will be sent.					
IPv4 Routing Table					
Destination	Gateway	Subnet Mask	Flag	Metric	Interface
0.0.0.0	10.60.62.158	0.0.0.0	UG	0	wwan0
10.60.62.156	0.0.0.0	255.255.255.252	U	0	wwan0
127.0.0.0	0.0.0.0	255.255.0.0	U	0	lo
192.168.1.0	0.0.0.0	255.255.255.0	U	0	br0
239.0.0.0	0.0.0.0	255.0.0.0	U	0	br0
IPv6 Routing Table					
Destination	Gateway	Flag	Metric	Interface	
fe80::/64	::	U	256	eth2	
fe80::/64	::	U	256	br0	
fe80::/64	::	U	256	ra0	
fe80::/64	::	U	256	wwan0	
::1/128	::	U	0	lo	
fe80::/128	::	U	0	lo	
fe80::/128	::	U	0	lo	
fe80::/128	::	U	0	lo	
fe80::/128	::	U	0	lo	
fe80::3065:f9ff:fe8c:186/128	::	U	0	lo	
fe80::86aa:9cff:fe83:b903/128	::	U	0	lo	
fe80::86aa:9cff:fe83:b903/128	::	U	0	lo	
fe80::86aa:9cff:fe83:b904/128	::	U	0	lo	
ff02::1/128	::	UC	0	br0	
ff00::/8	::	U	256	eth2	
ff00::/8	::	U	256	br0	
ff00::/8	::	U	256	ra0	
ff00::/8	::	U	256	wwan0	

The following table describes the labels in this screen.

Table 97 System Monitor > Routing Table

LABEL	DESCRIPTION
IPv4/IPv6 Routing Table	
Destination	This indicates the destination IPv4 address or IPv6 address and prefix of this route.
Gateway	This indicates the IPv4 address or IPv6 address of the gateway that helps forward this route's traffic.
Subnet Mask	This indicates the destination subnet mask of the IPv4 route.

Table 97 System Monitor > Routing Table (continued)

LABEL	DESCRIPTION
Flag	This indicates the route status. U-Up: The route is up. !-Reject: The route is blocked and will force a route lookup to fail. G-Gateway: The route uses a gateway to forward traffic. H-Host: The target of the route is a host. R-Reinstate: The route is reinstated for dynamic routing. D-Dynamic (redirect): The route is dynamically installed by a routing daemon or redirect. M-Modified (redirect): The route is modified from a routing daemon or redirect.
Metric	The metric represents the "cost of transmission." A router determines the best route for transmission by choosing a path with the lowest "cost." The smaller the number, the lower the "cost."
Interface	This indicates the name of the interface through which the route is forwarded.

CHAPTER 22

WLAN Station Status

22.1 WLAN Station Status Overview

Use this screen to view information and status of the wireless stations (wireless clients) that are currently associated with the Zyxel Device. Being associated means that a wireless client (for example, your computer with a wireless network card installed) has connected successfully to an AP (or wireless router) using the same SSID, channel, and WiFi security settings.

Click **System Monitor > WLAN Station Status** to open the following screen.

Figure 172 System Monitor > WLAN Station Status

The screenshot shows the 'WLAN Station Status' interface. It contains two main sections: 'WLAN 2.4G Station Status' and 'WLAN 5G Station Status'. Each section has a header bar with the section name and a table below it. The table columns are: '#', 'MAC Address', 'Rate (Mbps)', 'RSSI (dBm)', 'SNR', and 'Level'. The tables are currently empty.

The following table describes the labels in this screen.

Table 98 System Monitor > WLAN Station Status

LABEL	DESCRIPTION
#	This is the index number of an associated wireless station.
MAC Address	This field displays the MAC address of an associated wireless station.
Rate (Mbps)	This field displays the transmission rate of WiFi traffic between an associated wireless station and the Zyxel Device.
RSSI (dBm)	The RSSI (Received Signal Strength Indicator) field shows the WiFi signal strength of the station's wireless connection. The normal range is -30dBm to -79dBm. If the value drops below -80dBm, try moving the associated wireless station closer to the Zyxel Device to get better signal strength.

Table 98 System Monitor > WLAN Station Status (continued)

LABEL	DESCRIPTION
SNR	<p>The Signal-to-Noise Ratio (SNR) is the ratio between the received signal power and the received noise power.</p> <p>The normal range is 15 to 40. If the value drops below 15, try moving the associated wireless station closer to the Zyxel Device to get better quality WiFi.</p>
Level	<p>This field displays a number which represents the strength of the WiFi signal between an associated wireless station and the Zyxel Device. The Zyxel Device uses the RSSI and SNR values to determine the strength of the WiFi signal.</p> <p>5 means the Zyxel Device is receiving an excellent WiFi signal.</p> <p>4 means the Zyxel Device is receiving a very good WiFi signal.</p> <p>3 means the Zyxel Device is receiving a weak WiFi signal.</p> <p>2 means the Zyxel Device is receiving a very weak WiFi signal.</p> <p>1 means the Zyxel Device is not receiving a WiFi signal.</p>

CHAPTER 23

VoIP Status

23.1 VoIP Status Screen

Click System Monitor > VoIP Status to open the following screen. You can view the VoIP registration, current call status and phone numbers in this screen.

Figure 173 System Monitor > VoIP Status

The screenshot shows the 'VoIP Status' screen with the following sections:

- Information:** A text box stating, 'Information, such as whether a SIP account is registered and the total call volume made by a SIP account, can be viewed in the page.'
- Poll Interval:** A text input field containing '10' and 'sec' to its right. Below it is '(s)'. To the right are two buttons: 'Set Interval' and 'Stop'.
- SIP Status:** A table with columns: Account, Register Action, Registration, Registration Time, URI, Message Waiting, Last Incoming Number, and Last Outgoing Number. The first row shows Account '1', Register Action as a toggle switch, Registration 'Disabled', and Message Waiting 'No'.
- Call Status:** A table with columns: Account, Duration, Status, Call Type, Codec, From Phone Port Type, To Phone Port Type, and Peer Number. This table is currently empty.
- Phone Status:** A table with columns: Phone, Outgoing Number, Incoming Number, and Hook Status. The first row shows Phone 'Phone 1', Outgoing Number 'ChangeMe', Incoming Number 'ChangeMe', and Hook Status 'On-hook'.

The following table describes the labels in this screen.

Table 99 System Monitor > VoIP Status

LABEL	DESCRIPTION
Poll Interval	Enter the number of seconds the Device needs to wait before updating this screen and then click Set Interval. Click Stop to have the Device stop updating this screen.
SIP Status	
Account	This column displays each SIP account in the Device.
Registration	This field displays the current registration status of the SIP account. You can change this in the Status screen. Registered - The SIP account is registered with a SIP server. Not Registered - The last time the Device tried to register the SIP account with the SIP server, the attempt failed. The Device automatically tries to register the SIP account when you turn on the Device or when you activate it. Inactive - The SIP account is not active. You can activate it in VoIP > SIP > SIP Account.

Table 99 System Monitor > VoIP Status (continued)

LABEL	DESCRIPTION
Registration Time	This field displays the last time the Device successfully registered the SIP account. The field is blank if the Device has never successfully registered this account.
URI	This field displays the account number and service domain of the SIP account. You can change these in the VoIP > SIP screen.
Message Waiting	This field indicates whether or not there are any messages waiting for the SIP account.
Last Incoming Number	This field displays the last number that called the SIP account. The field is blank if no number has ever dialed the SIP account.
Last Outgoing Number	This field displays the last number the SIP account called. The field is blank if the SIP account has never dialed a number.
Call Status	
Account	This column displays each SIP account in the Device.
Duration	This field displays how long the current call has lasted.
Status	<p>This field displays the current state of the phone call.</p> <p>Idle - There are no current VoIP calls, incoming calls or outgoing calls being made.</p> <p>Dial - The callee's phone is ringing.</p> <p>Ring - The phone is ringing for an incoming VoIP call.</p> <p>Process - There is a VoIP call in progress.</p> <p>DISC - The callee's line is busy, the callee hung up or your phone was left off the hook.</p>
Call Type	<p>This field displays the call direction type of the current VoIP call. Outgoing Call - It's a SIP VoIP call made by local phone ports, and this SIP account is able to issue a (SIP-based) call setup to the SIP account of remote peers for a VoIP call establishment. This (SIP-based) call setup signal is sent to the SIP server first, and then the SIP server would relay it to the target peer after correctly resolving and locating the target peer. During the call setup (signaling) phase, Calling state is displayed in the Status field, and it turns to InCall state once the call is successfully established.</p> <p>Incoming Call - It's a SIP VoIP call made or originated by remote SIP accounts to connect to this local SIP account. One or more local phone ports can be configured to receive this type of call, see the Incoming Number below, and all of them should begin to ring during the call setup (signaling phase), see the Status above. Once some remote SIP accounts start to ring one local phone, answer by off-hook to the call, and the call is successfully established. The other ringing local phone ports will stop ringing and turning to InCall state in the Status field.</p> <p>Internal Call - It's a local VoIP call between two different local phone ports. No SIP signaling is needed and thus no SIP server is involved to establish this type of call. This type of call is established via the Internal and Non-SIP local setup signaling procedure between the call-originating and call-terminating local phone ports. In general, one or more local phone ports can be designed to receive this type of call, and once any of the ringing phones answer the call, the other ringing ones will stop ringing. During the call setup phase (signaling phase), Calling state is displayed in Status field, and turns to InCall state once the call is successfully established.</p>
Codec	This field displays what voice codec is being used for a current VoIP call through a phone port.
From Phone Port Type	This field displays the phone ports type used to originate, start, or create the current VoIP call. Two possible type values will be displayed here: SIP - For the current call which is categorized as Incoming Call in the Call Type field, this field will show the type SIP. FXS - As for the other cases: Outgoing Call and Internal Call, this field will show the corresponding local phone port type: FXS, the legacy analog phone port on the device.

Table 99 System Monitor > VoIP Status (continued)

LABEL	DESCRIPTION
To Phone Port Type	This field displays the phone ports type used to receive the current VoIP call. Three possible type Type values will be displayed here: SIP - For the current call which is categorized as Outgoing Call in the Call Type field, this field will show the type SIP. FXS and Unknown - As for the other cases: Incoming Call and Internal Call, this field will show the corresponding local phone port type: FXS, the legacy analog phone port on the device. While the call is established, this field shows Unknown during the call setup phase (signaling phase). This is because one or more local phone ports can be configured or designed to receive these two types of calls, see the Call Type above, and the local phone port will answer the call that hasn't been determined yet at that time.
Peer Number	This field displays the SIP number of the party that is currently engaged in a VoIP call through a phone port.
Phone Status	
Phone	This field displays the name of a phone port on the Device.
Outgoing Number	This field displays the SIP number that you use to make calls on this phone port.
Incoming Number	This field displays the SIP number that you use to receive calls on this phone port.
Hook Status	This field displays whether the phone is in the on or off hook status.

CHAPTER 24

Cellular WAN Status

24.1 Cellular WAN Status Overview

View the LTE connection details and LTE signal strength value that you can use as reference for positioning the Zyxel Device, as well as SIM card and module information.

24.2 Cellular WAN Status

To open this screen, click **System Monitor > Cellular WAN Status**. Cellular information is available on this screen only when you insert a valid SIM card in the Zyxel Device.

Figure 174 System Monitor > Cellular WAN Status

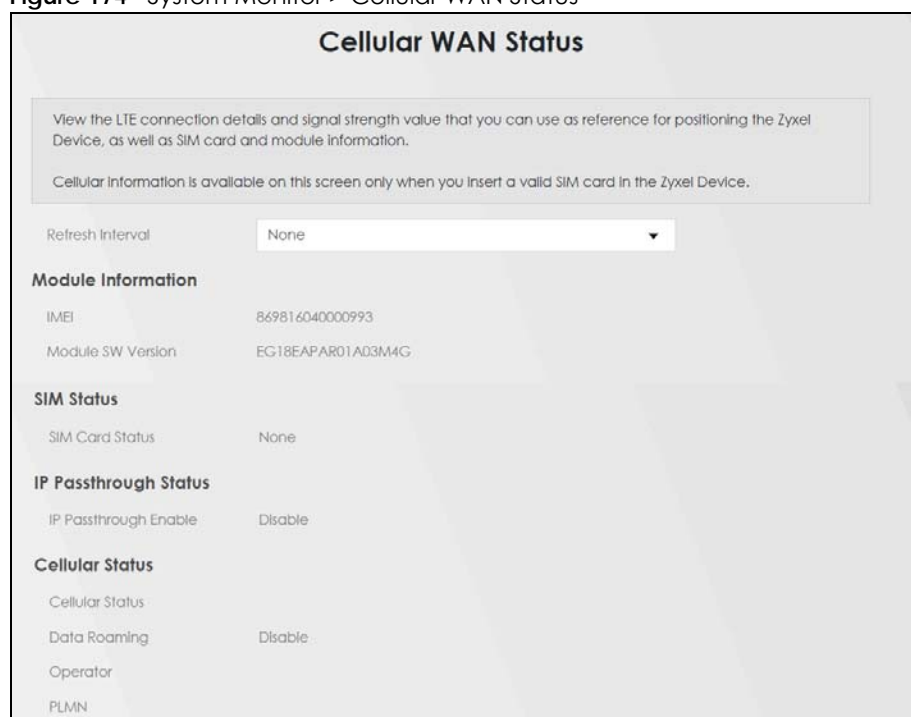

Figure 175 System Monitor > Cellular WAN Status (Service Information)

Service Information	
Access Technology	Unknown
Band	N/A
RSSI	N/A
Cell ID	N/A
Physical Cell ID	N/A
UL Bandwidth (MHz)	N/A
DL Bandwidth (MHz)	N/A
RFCN	N/A
RSRP	N/A
RSRQ	N/A
RSCP	N/A
EcNo	N/A
TAC	N/A
LAC	N/A
RAC	N/A
BSIC	N/A
SINR	N/A
CQI	N/A
MCS	N/A
RI	N/A
PMI	N/A

The following table describes the labels in this screen.

Table 100 System Monitor > Cellular WAN Status

LABEL	DESCRIPTION
Refresh Interval	Select the time interval the Zyxel Device will check and refresh the fields shown on this screen. Select None to stop detection.
Module Information	
IMEI	This shows the International Mobile Equipment Identity of the Zyxel Device.
Module SW Version	This shows the software version of the LTE module.
SIM Status	
SIM Card Status	This displays the SIM card status: None - the Zyxel Device does not detect that there is a SIM card inserted. Available - the SIM card could either have or doesn't have PIN code security. Locked - the SIM card has PIN code security, but you did not enter the PIN code yet. Blocked - you entered an incorrect PIN code too many times, so the SIM card has been locked; call the ISP for a PUK (Pin Unlock Key) to unlock the SIM card. Error - the Zyxel Device detected that the SIM card has errors.
IMSI	This displays the International Mobile Subscriber Identity (IMSI) of the installed SIM card. An IMSI is a unique ID used to identify a mobile subscriber in a mobile network.
ICCID	Integrated Circuit Card Identifier (ICCID). This is the serial number of the SIM card.

Table 100 System Monitor > Cellular WAN Status (continued)

LABEL	DESCRIPTION
PIN Protection	<p>A PIN (Personal Identification Number) code is a key to a SIM card. Without the PIN code, you cannot use the SIM card.</p> <p>Shows Enable if the service provider requires you to enter a PIN to use the SIM card.</p> <p>Shows Disable if the service provider lets you use the SIM without inputting a PIN.</p>
PIN Remaining Attempts	This is how many more times you can try to enter the PIN code before the ISP blocks your SIM card.
IP Passthrough Status	
IP Passthrough Enable	<p>This displays if IP Passthrough is enabled on the Zyxel Device.</p> <p>IP Passthrough allows a LAN computer on the local network of the Zyxel Device to have access to web services using the public IP address. When IP Passthrough is configured, all traffic is forwarded to the LAN computer and will not go through NAT.</p>
IP Passthrough Mode	<p>This displays the IP Passthrough mode.</p> <p>This displays Dynamic and the Zyxel Device will allow traffic to be forwarded to the first LAN computer requesting an IP address from the Zyxel Device.</p> <p>This displays Fixed and the Zyxel Device will allow traffic to be forwarded to a specific LAN computer on the local network of the Zyxel Device.</p>
Cellular Status	This displays the status of the cellular Internet connection.
Data Roaming	<p>This displays if data roaming is enabled on the Zyxel Device.</p> <p>4G roaming is to use your Zyxel Device in an area which is not covered by your service provider. Enable roaming to ensure that your Zyxel Device is kept connected to the Internet when you are traveling outside the geographical coverage area of the network to which you are registered.</p>
Operator	This displays the name of the service provider.
PLMN	This displays the PLMN number.
Access Technology	This displays the type of the mobile network (such as LTE, UMTS, GSM) to which the Zyxel Device is connecting.
Band	This displays the current LTE band of your Zyxel Device (WCDMA2100).
RSSI	<p>This displays the strength of the WiFi signal between an associated wireless station and an AP.</p> <p>The normal range is -30dBm to -79dBm. If the value drops below -80dBm, try moving the associated wireless station closer to the Zyxel Device to get better signal strength.</p>
Cell ID	<p>This shows the cell ID, which is a unique number used to identify the Base Transceiver Station to which the Zyxel Device is connecting.</p> <p>The value depends on the Current Access Technology:</p> <ul style="list-style-type: none"> For GPRS, it is the Cell Identity as specified in 3GPP-TS.25.331. For UMTS, it is the Cell Identity as defined in SIB3 3GPP-TS.25.331, 3GPP-TS.24.008. For LTE, it is the 28-bit binary number Cell Identity as specified in SIB1 in 3GPP-TS.36.331. <p>The value is '0' (zero) or 'N/A' if there is no network connection.</p>
Physical Cell ID	This shows the Physical Cell ID (PCI), which are queries and replies between the Zyxel Device and the mobile network it is connecting to. The normal range is 1 to 504.
UL Bandwidth (MHz)	This shows the LTE channel bandwidth from device to base station. According to 3GPP specifications, the bandwidths defined by the standard are 1.4, 3, 5, 10, 15, and 20 MHz. The wider the bandwidth the higher the throughput.
DL Bandwidth (MHz)	This shows the LTE channel bandwidth from base station to LTE device. According to 3GPP specifications, the bandwidths defined by the standard are 1.4, 3, 5, 10, 15, and 20 MHz. The wider the bandwidth the higher the throughput.

Table 100 System Monitor > Cellular WAN Status (continued)

LABEL	DESCRIPTION
RFCN	<p>This displays the Radio Frequency Channel Number of DL carrier frequency used by the mobile network to which the Zyxel Device is connecting.</p> <p>The value depends on the Current Access Technology:</p> <ul style="list-style-type: none"> • For GPRS, it is the ARFCN (Absolute Radio-Frequency Channel Number) as specified in 3GPP-TS.45.005. • For UMTS, it is the UARFCN (UTRA Absolute Radio-Frequency Channel Number) as specified in 3GPP-TS.25.101. • For LTE, it is the EARFCN (E-UTRA Absolute Radio-Frequency Channel Number) as specified in 3GPP-TS.36.101. <p>The value is '0' (zero) or 'N/A' if there is no network connection.</p>
RSRP	<p>This displays the Reference Signal Receive Power (RSRP), which is the average received power of all Resource Element (RE) that carry cell-specific Reference Signals (RS) within the specified bandwidth.</p> <p>The received RSRP level of the connected E-UTRA cell, in dBm, is as specified in 3GPP-TS.36.214. The reporting range is specified in 3GPP-TS.36.133.</p> <p>An undetectable signal is indicated by the lower limit, example -140 dBm.</p> <p>This parameter is for LTE only. The normal range is -30 to -140. The value is -140 if the Current Access Technology is not LTE. The value is 'N/A' if there is no network connection.</p>
RSRQ	<p>This displays the Reference Signal Receive Quality (RSRQ), which is the ratio of RSRP to the E-UTRA carrier RSSI and indicates the quality of the received reference signal.</p> <p>The received RSRQ level of the connected E-UTRA cell, in 0.1 dB, is as specified in 3GPP-TS.36.214. An undetectable signal is indicated by the lower limit, example -240.</p> <p>This parameter is for LTE only. The normal range is -30 to -240. The value is -240 if the Current Access Technology is not LTE. The value is 'N/A' if there is no network connection.</p>
RSCP	<p>This displays the Received Signal Code Power, which measures the power of channel used by the Zyxel Device.</p> <p>The received signal level, in dBm, is of the CPICH channel (Ref. 3GPP TS 25.133). An undetectable signal is indicated by the lower limit, example -120 dBm.</p> <p>This parameter is for UMTS only. The normal range is -30 to -120. The value is -120 if the Current Access Technology is not UMTS. The value is 'N/A' if there is no network connection.</p>
EcNo	<p>This displays the ratio (in dB) of the received energy per chip and the interference level.</p> <p>The measured EcNo is in 0.1 dB and is received in the downlink pilot channel. An undetectable signal is indicated by the lower limit, example -240 dB.</p> <p>This parameter is for UMTS only. The normal range is -30 to -240. The value is -240 if the Current Access Technology is not UMTS or there is no network connection.</p>
TAC	<p>This displays the Tracking Area Code (TAC), which is used to identify the country of a mobile subscriber.</p> <p>The physical cell ID of the connected E-UTRAN cell, is as specified in 3GPP-TS.36.101.</p> <p>This parameter is for LTE only. The value is '0' (zero) or 'N/A' if the Current Access Technology is not LTE or there is no network connection.</p>
LAC	<p>This displays the 2-octet Location Area Code (LAC), which is used to identify a location area within a PLMN.</p> <p>The LAC of the connected cell is as defined in SIB 1 [3GPP-TS.25.331]. The concatenation of PLMN ID (MCC+MNC) and LAC uniquely identifies the LAI (Location Area ID) [3GPP-TS.23.003].</p> <p>This parameter is for UMTS or GPRS. The value is '0' (zero) if the Current Access Technology is not UMTS or GPRS. The value is 'N/A' if there is no network connection.</p>

Table 100 System Monitor > Cellular WAN Status (continued)

LABEL	DESCRIPTION
RAC	<p>This displays the RAC (Routing Area Code), which is used in mobile network "packet domain service" (PS) to identify a routing area within a location area.</p> <p>In a mobile network, it uses LAC (Location Area Code) to identify the geographical location for the old 3G voice only service, and use RAC to identify the location of data service like HSDPA or LTE.</p> <p>The RAC of the connected UTRAN cell is as defined in SIB 1 [3GPP-TS.25.331]. The concatenation of PLMN ID (MCC+MNC), LAC, and RAC uniquely identifies the RAI (Routing Area ID) [3GPP-TS.23.003].</p> <p>This parameter is for UMTS or GPRS. The value is '0' (zero) if the Current Access Technology is not UMTS or GPRS. The value is 'N/A' if there is no network connection.</p>
BSIC	<p>The Base Station Identity Code (BSIC), which is a code used in GSM to uniquely identify a base station.</p> <p>This parameter is for GPRS only. The value is '0' (zero) if the Current Access Technology is not GPRS. The value is 'N/A' if there is no network connection.</p>
SINR	<p>This displays the Signal to Interference plus Noise Ratio (SINR) in dB. This is also a measure of signal quality and used by the UE (User Equipment) to calculate the Channel Quality Indicator (CQI) that it reports to the network. A negative value means more noise than signal.</p>
CQI	<p>This displays the Channel Quality Indicator (CQI). It is an indicator carrying the information on how good/bad the communication channel quality is.</p>
MCS	<p>MCS stands for modulation coding scheme. The base station selects MCS based on current radio conditions. The higher the MCS the more bits can be transmitted per time unit.</p>
RI	<p>This displays the Rank Indication, one of the control information that a UE will report to eNodeB (Evolved Node-B) on either PUCCH (Physical Uplink Control Channel) or PUSCH (Physical Uplink Shared Channel) based on uplink scheduling.</p>
PMI	<p>This displays the Precoding Matrix Indicator (PMI).</p> <p>PMI is for transmission modes 4 (closed loop spatial multiplexing), 5 (multi-user MIMO), and 6 (closed loop spatial multiplexing using a single layer).</p> <p>PMI determines how cellular data are encoded for the antennas to improve downlink rate.</p>

CHAPTER 25

System

25.1 System Overview

Use this screen to name your Zyxel Device (Host) and give it an associated domain name for identification purposes.

25.2 System

Click **Maintenance > System** to open the following screen. Assign a unique name to the Zyxel Device so it can be easily recognized on your network. You can use up to 30 characters, including spaces.

Figure 176 Maintenance > System

System

Give a name to your Zyxel Device (host) and an associated domain name for identification purposes.

Assign a unique name so it can be easily recognized on your network. You can use up to 30 characters, including spaces.

Host Name

Domain Name

The following table describes the labels in this screen.

Table 101 Maintenance > System

LABEL	DESCRIPTION
Host Name	Type a host name for your Zyxel Device. Enter a descriptive name of up to 16 alphanumeric characters, not including spaces, underscores, and dashes.
Domain Name	Type a Domain name for your host Zyxel Device.
Cancel	Click Cancel to abandon this screen without saving.
Apply	Click Apply to save your changes.

CHAPTER 26

User Account

26.1 User Account Overview

In the **User Account** screen, you can view the settings of the "admin" and other user accounts that you use to log into the Zyxel Device to manage it.

26.2 User Account

Click **Maintenance > User Account** to open the following screen. Use this screen to create or manage user accounts and their privileges on the Zyxel Device.

Figure 177 Maintenance > User Account

#	Active	User Name	Retry Times	Idle Timeout	Lock Period	Group	Modify
1	<input checked="" type="checkbox"/>	admin	0	60	5	Administrator	
2	<input checked="" type="checkbox"/>	User-S	0	60	5	User	

The following table describes the labels in this screen.

Table 102 Maintenance > User Account

LABEL	DESCRIPTION
Add New Account	Click this button to add a new user account (up to 4 Administrator accounts and 4 User accounts).
#	This is the index number.
Active	This indicates whether the user account is active or not. The check box is selected when the user account is enabled. It is cleared when it is disabled.
User Name	This displays the name of the account used to log into the Zyxel Device Web Configurator.
Retry Times	This displays the number of times consecutive wrong passwords can be entered for this account. 0 means there is no limit.

Table 102 Maintenance > User Account (continued)

LABEL	DESCRIPTION
Idle Timeout	This displays the length of inactive time before the Zyxel Device will automatically log the user out of the Web Configurator.
Lock Period	This field displays the length of time a user must wait before attempting to log in again after a number of consecutive wrong passwords have been entered as defined in Retry Times .
Group	This field displays whether this user has Administrator or User privileges.
Modify	Click the Edit icon to configure the entry. Click the Delete icon to remove the entry.
Cancel	Click Cancel to restore your previously saved settings.
Apply	Click Apply to save your changes.

26.2.1 User Account Add/Edit

Add or change the name of the user account, set the security password and the retry times, and whether this user will have **Administrator** or **User** privileges. Click **Add New Account** or the **Edit** icon of an existing account in the **Maintenance > User Account** to open the following screen.

Figure 178 Maintenance > User Account > Add/Edit

The following table describes the labels in this screen.

Table 103 Maintenance > User Account > Add/Edit

LABEL	DESCRIPTION
Active	Click to enable (switch turns blue) or disable (switch turns gray) to activate or deactivate the user account.
User Name	Enter a new name for the account (up to 15 characters). Special characters are allowed except the following: double quote (") back quote (`) apostrophe or single quote (') less than (<) greater than (>) caret or circumflex accent (^) dollar sign (\$) vertical bar () ampersand (&) semicolon (;)
Password	Type your new system password (up to 256 characters). Note that as you type a password, the screen displays a (*) for each character you type. After you change the password, use the new password to access the Zyxel Device.

Table 103 Maintenance > User Account > Add/Edit (continued)

LABEL	DESCRIPTION
Verify Password	Type the new password again for confirmation.
Retry Times	Enter the number of times consecutive wrong passwords can be entered for this account. 0 means there is no limit.
Idle Timeout	Enter the length of inactive time before the Zyxel Device will automatically log the user out of the Web Configurator.
Lock Period	Enter the length of time a user must wait before attempting to log in again after a number of consecutive wrong passwords have been entered as defined in Retry Times .
Group	<p>Specify whether this user will have Administrator or User privileges.</p> <p>The Administrator privileges are the following:</p> <ul style="list-style-type: none"> • Quick Start setup. • The following screens are visible for setup: Broadband, Wireless, Home Networking, Routing, NAT, DNS, Firewall, MAC Filter, Certificates, Voice, Log, Traffic Status, ARP Table, Routing Table, Cellular WAN Status, System, User Account, Remote Management, TR-069 Client, Time, Email Notification, Log Setting, Firmware Upgrade, Backup/Restore, Reboot, Diagnostic. <p>The User privileges are the following:</p> <ul style="list-style-type: none"> • The following screens are visible for setup: Log, Traffic Status, ARP Table, Routing Table, Cellular WAN Status, User Account, Remote Management, Time, Email Notification, Log Setting, Firmware Upgrade, Backup/Restore, Reboot, Diagnostic.
Cancel	Click Cancel to restore your previously saved settings.
OK	Click OK to save your changes.

CHAPTER 27

Remote Management

27.1 Overview

Remote management controls through which interface(s), which web services (such as HTTP, HTTPS, FTP, Telnet, SSH and Ping) can access the Zyxel Device.

Note: The Zyxel Device is managed using the Web Configurator.

27.2 MGMT Services

Note: The **MGMT Services** screen will be hidden if you enable the **IP Passthrough** function in **Network Setting > Broadband > Cellular IP Passthrough** screen.

Use this screen to configure the interfaces through which services can access the Zyxel Device. Click **Maintenance > Remote Management** to open the following screen.

Figure 179 Maintenance > Remote Management

Configure which interface(s) you can use to access the Zyxel Device for a given service. You can also specify the service port numbers computers must use to connect to the Zyxel Device.

Service Control

WAN Interface used for services: Any_WAN Multi_WAN

Cellular WAN

Service	LAN/WLAN	WAN	Trust Domain	Port
HTTP	<input checked="" type="checkbox"/> Enable	<input type="checkbox"/> Enable	<input type="checkbox"/> Enable	80
HTTPS	<input checked="" type="checkbox"/> Enable	<input type="checkbox"/> Enable	<input type="checkbox"/> Enable	443
FTP	<input checked="" type="checkbox"/> Enable	<input type="checkbox"/> Enable	<input type="checkbox"/> Enable	21
TELNET	<input checked="" type="checkbox"/> Enable	<input type="checkbox"/> Enable	<input type="checkbox"/> Enable	23
SSH	<input checked="" type="checkbox"/> Enable	<input type="checkbox"/> Enable	<input type="checkbox"/> Enable	22
PING	<input checked="" type="checkbox"/> Enable	<input type="checkbox"/> Enable	<input type="checkbox"/> Enable	

Cancel Apply

The following table describes the fields in this screen.

Table 104 Maintenance > Remote Management

LABEL	DESCRIPTION
WAN Interface used for services	Select Any_WAN to have the Zyxel Device automatically activate the remote management service when any WAN connection is up. Select Multi_WAN and then select one or more WAN connections to have the Zyxel Device activate the remote management service when the selected WAN connections are up.
Cellular WAN	Enable the LTE WAN connection configured in Network Setting > Broadband > Cellular WAN to access the service on the Zyxel Device.
ETHWAN	Enable the LTE WAN connection configured in Network Setting > Broadband > Cellular WAN to access the service on the Zyxel Device.
Service	This is the service you may use to access the Zyxel Device.
LAN/WLAN	Select the Enable check box for the corresponding services that you want to allow access to the Zyxel Device from the LAN/WLAN.
WAN	Select the Enable check box for the corresponding services that you want to allow access to the Zyxel Device from all WAN connections.
Trust Domain	Select the Enable check box for the corresponding services that you want to allow access to the Zyxel Device from the trusted host IP address.
Port	You may change the server port number for a service if needed, however you must use the same port number in order to use that service for remote management.
Apply	Click Apply to save your changes back to the Zyxel Device.
Cancel	Click Cancel to restore your previously saved settings.

27.3 MGMT Services for IP Passthrough

Configure which interfaces you can use to access the Zyxel Device in **IP Passthrough** mode (bridge mode) for a given service. You can also specify the service port numbers computers must use to connect to the Zyxel Device. IP Passthrough allows Internet traffic to go to a LAN computer behind the Zyxel Device without going through NAT. Make sure to enable IP Passthrough in **Network Setting > Broadband > Cellular IP Passthrough**. See [Section 6.9 on page 97](#) for details.

Click **Maintenance > Remote Management > MGMT Services for IP Passthrough** to open the following screen.

Figure 180 Maintenance > Remote Management > MGMT Services for IP Passthrough

Configure which interface(s) you can use to access the Zyxel Device in **IP Passthrough** mode (bridge mode) for a given service. You can also specify the service port numbers computers must use to connect to the Zyxel Device. IP Passthrough allows Internet traffic to go to a LAN computer behind the Zyxel Device without going through NAT. Make sure to enable IP Passthrough in **Network Setting > Broadband > Cellular IP Passthrough**.

Service Control

Service	WAN	Port
PT_HTTP	<input checked="" type="checkbox"/> Enable	20080
PT_HTTPS	<input checked="" type="checkbox"/> Enable	20443
PT_FTP	<input type="checkbox"/> Enable	20021
PT_TELNET	<input type="checkbox"/> Enable	20023
PT_SSH	<input type="checkbox"/> Enable	20022

Cancel Apply

The following table describes the fields in this screen.

Table 105 Maintenance > Remote Management > MGMT Services for IP Passthrough

LABEL	DESCRIPTION
Service	This is the service you may use to access the Zyxel Device.
WAN	Select the Enable check box for the corresponding services that you want to allow access to the Zyxel Device from all WAN connections.
Port	You may change the server port number for a service if needed, however you must use the same port number in order to use that service for remote management.
Apply	Click Apply to save your changes back to the Zyxel Device.
Cancel	Click Cancel to restore your previously saved settings.

27.4 Trust Domain

Use this screen to view a list of public IP addresses which are allowed to access the Zyxel Device through the services configured in the **Maintenance > Remote Management > MGMT Services** screen. Click **Maintenance > Remote Management > Trust Domain** to open the following screen.

Note: Enter the IP address of the management station permitted to access the local management services. If specific services from the trusted hosts are allowed access but the trust domain list is empty, all public IP addresses can access the Zyxel Device from the WAN using the specified services.

Figure 181 Maintenance > Remote Management > Trust Domain

View a list of public IP addresses which you want to allow access to the Zyxel Device through the services configured in this screen.

If this list is empty, all public IP addresses can access the Zyxel Device from the WAN through the specified services.

+ Add Trust Domain

IP Address	Delete
------------	--------

The following table describes the fields in this screen.

Table 106 Maintenance > Remote Management > Trust Domain

LABEL	DESCRIPTION
Add Trust Domain	Click this to add a trusted host IP address.
IP Address	This field shows a trusted host IP address.
Delete	Click the Delete icon to remove the trusted host IP address.

27.5 Add Trust Domain

Use this screen to add a public IP addresses or a complete domain name of a device which is allowed to access the Zyxel Device. Click the **Add Trust Domain** button in the **Maintenance > Remote Management > Trust Domain** screen to open the following screen.

Figure 182 Maintenance > Remote Management > Trust Domain > Add Trust Domain

The following table describes the fields in this screen.

Table 107 Maintenance > Remote Management > Trust Domain > Add Trust Domain

LABEL	DESCRIPTION
IP Address	Enter a public IPv4/IPv6 IP address which is allowed to access the service on the Zyxel Device from the WAN.
OK	Click OK to save your changes back to the Zyxel Device.
Cancel	Click Cancel to restore your previously saved settings.

27.6 Trust Domain for IP Passthrough

Use this screen to view a list of public IP addresses/complete domain names which are allowed to access the Zyxel Device in **IP Passthrough** mode (bridge mode). IP Passthrough allows Internet traffic to go to a LAN computer behind the Zyxel Device without going through NAT. Make sure to enable IP Passthrough in **Network Setting > Broadband > Cellular IP Passthrough**. See [Section 6.9 on page 97](#) for details.

Click **Maintenance > Remote Management > Trust Domain for IP Passthrough** to open the following screen.

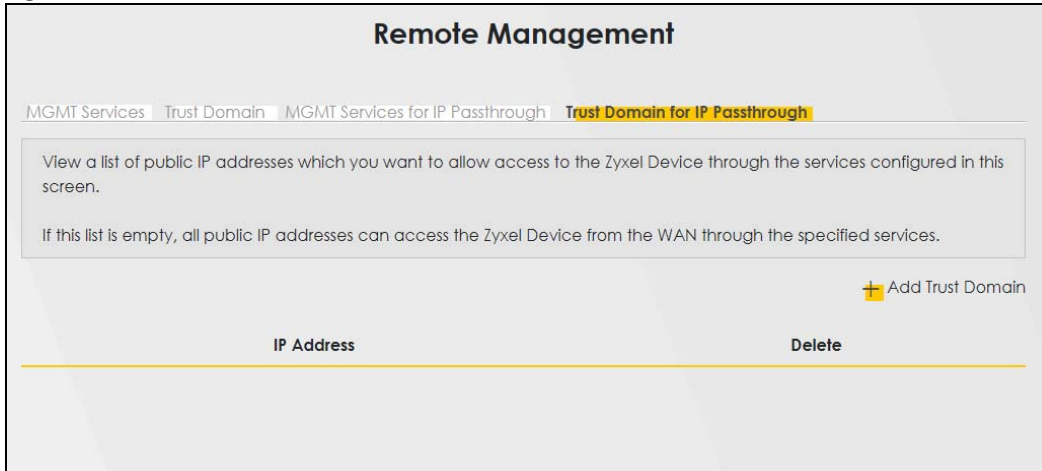
Figure 183 Maintenance > Remote Management > Trust Domain for IP Passthrough

The following table describes the fields in this screen.

Table 108 Maintenance > Remote Management > Trust Domain for IP Passthrough

LABEL	DESCRIPTION
Add Trust Domain	Click this to add a trusted host IP address.
IP Address	This field shows a trusted host IP address.
Delete	Click the Delete icon to remove the trusted host IP address.

27.7 Add Trust Domain

Use this screen to add a public IP address or a complete domain name of a device which is allowed to access the Zyxel Device. Click the **Add Trust Domain** button in the **Maintenance > Remote Management > Trust Domain for IP Passthrough** screen to open the following screen.

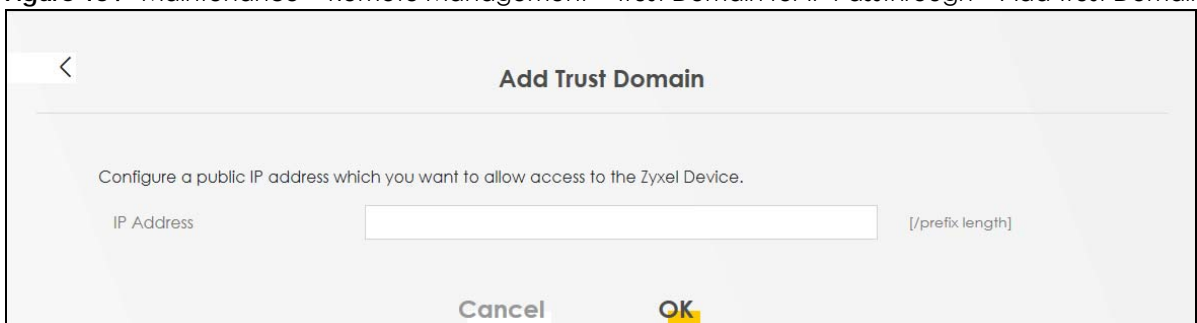
Figure 184 Maintenance > Remote Management > Trust Domain for IP Passthrough > Add Trust Domain

The following table describes the fields in this screen.

Table 109 Maintenance > Remote Management > Trust Domain for IP Passthrough > Add Trust Domain

LABEL	DESCRIPTION
IP Address	Enter a public IPv4/IPv6 IP address which is allowed to access the service on the Zyxel Device from the WAN.
Cancel	Click Cancel to restore your previously saved settings.
OK	Click OK to save your changes back to the Zyxel Device.

CHAPTER 28

TR-069 Client

28.1 Overview

This chapter explains how to configure the Zyxel Device's TR-069 auto-configuration settings.

28.2 TR-069 Client

TR-069 is a protocol that defines how your Zyxel Device can be managed via a management server. You can use a management server to remotely set up the Zyxel Device, modify settings, perform firmware upgrades as well as monitor and diagnose the Zyxel Device.

Click **Maintenance > TR-069 Client** to open the following screen.

Figure 185 Maintenance > TR-069 Client

The screenshot shows the 'TR-069 Client' configuration page. At the top, there is a title 'TR-069 Client' and a subtitle 'Allow your Zyxel Device to be managed remotely by an Auto Configuration Server (ACS) using TR-069.' Below this, there are several configuration options:

- CWMP Active:** A toggle switch that is turned on.
- Inform:** A toggle switch that is turned on.
- Inform Interval:** A text input field containing the value '86400'.
- IP Protocol:** Three radio buttons: 'TR069 on IPv4 Only', 'TR069 on IPv6 Only', and 'Auto Select'. The 'Auto Select' option is selected.
- ACS URL:** A text input field. To its right is a note: '(URL or IPv4 Address / Global IPv6 Address)'. Below this are input fields for 'ACS User Name' and 'ACS Password'.
- WAN Interface Used by TR-069 Client:** Two radio buttons: 'Any_WAN' and 'Multi_WAN'. The 'Multi_WAN' option is selected.
- Cellular WAN:** A checked checkbox.
- Display SOAP Messages on Serial Console:** A toggle switch that is turned on.
- Connection Request Authentication:** A toggle switch that is turned on.
- Connection Request User Name:** A text input field.
- Connection Request Password:** A text input field.
- Connection Request URL:** A text input field.
- Validate ACS certificate:** A toggle switch that is turned on.
- Local Certificate Used by TR-069 Client:** A dropdown menu.

At the bottom of the page, there are two buttons: 'Cancel' and 'Apply'.

The following table describes the fields in this screen.

Table 110 Maintenance > TR-069 Client

LABEL	DESCRIPTION
CWMP Active	<p>CPE WAN Management Protocol (CWMP) enables the Zyxel Device to be remotely configured via a WAN link. Communication between the Zyxel Device and the management server is conducted via SOAP/HTTP(S) in the form of remote procedure calls (RPC).</p> <p>Click to enable (switch turns blue) to allow the Zyxel Device to be managed by a management server. Otherwise, click to disable (switch turns gray) to disallow the Zyxel Device to be managed by a management server.</p>
Inform	Click to enable (switch turns blue) the Zyxel Device to send periodic inform via TR-069 on the WAN. Otherwise, click to disable (switch turns gray).
Inform Interval	Enter the time interval (in seconds) at which the Zyxel Device sends information to the auto-configuration server.
IP Protocol	Select the type of IP protocol to allow TR-069 to operate on.
ACS URL	Enter the URL or IP address of the auto-configuration server.
ACS User Name	Enter the TR-069 user name for authentication with the auto-configuration server.
ACS Password	Enter the TR-069 password for authentication with the auto-configuration server.
WAN Interface used by TR-069 client	<p>Select a WAN interface through which the TR-069 traffic passes.</p> <p>If you select Any_WAN, the Zyxel Device automatically passes the TR-069 traffic when any WAN connection is up.</p> <p>If you select Multi_WAN, you also need to select two or more pre-configured WAN interfaces. The Zyxel Device automatically passes the TR-069 traffic when one of the selected WAN connections is up.</p>
Cellular WAN	The Zyxel Device automatically passes the TR-069 traffic when cellular WAN connection is up.
Display SOAP messages on serial console	Click to enable (switch turns blue) the dumping of all SOAP messages during the ACS server communication with the CPE.
Connection Request Authentication	Select this option to enable authentication when there is a connection request from the ACS.
Connection Request User Name	<p>Enter the connection request user name.</p> <p>When the ACS makes a connection request to the Zyxel Device, this user name is used to authenticate the ACS.</p>
Connection Request Password	<p>Enter the connection request password.</p> <p>When the ACS makes a connection request to the Zyxel Device, this password is used to authenticate the ACS.</p>
Connection Request URL	<p>This shows the connection request URL.</p> <p>The ACS can use this URL to make a connection request to the Zyxel Device.</p>
Validate ACS Certificate	Click to enable (switch turns blue) the validation of a local certificate used by TR-069 client.
Local certificate used by TR-069 client	You can choose a local certificate used by TR-069 client. The local certificate should be imported in the Security > Certificates > Local Certificates screen.
Apply	Click Apply to save your changes.
Cancel	Click Cancel to restore the screen's last saved settings.

CHAPTER 29

Time Settings

29.1 Time Settings Overview

This chapter shows you how to configure system related settings, such as system time, password, name, the domain name and the inactivity timeout interval.

29.2 Time

Use this screen to configure the Zyxel Device's time based on your local time zone. You can enter a time server address, select the time zone where the Zyxel Device is physically located, and configure Daylight Savings settings if needed.

To change your Zyxel Device's time and date, click **Maintenance > Time**. The screen appears as shown.

Figure 186 Maintenance > Time

Configure the Zyxel Device's time based on your local time zone. You can add a time server address, select your time zone, and configure Daylight Savings if your location uses it.

Current Date/Time

Current Time 14:21:53
Current Date 2019-02-27

Time and Date Setup

Time Protocol SNTP (RFC-1769)

First Time Server Address pool.ntp.org
Second Time Server Address clock.nyc.he.net
Third Time Server Address clock.sjc.he.net
Fourth Time Server Address None
Fifth Time Server Address None

Time Zone

Time Zone (GMT+08:00) Taipei

Daylight Savings

Active

Start Rule

Day 1 in
 Last Sunday in

Month March
Hour 2 0

End Rule

Day 1 in
 Last Sunday in

Month October
Hour 3 0

Cancel Apply

The following table describes the fields in this screen.

Table 111 Maintenance > Time

LABEL	DESCRIPTION
Current Date/Time	
Current Time	This displays the time of your Zyxel Device. Each time you reload this screen, the Zyxel Device synchronizes the time with the time server.
Current Date	This displays the date of your Zyxel Device. Each time you reload this screen, the Zyxel Device synchronizes the date with the time server.
Time and Date Setup	
Time Protocol	This displays the time protocol used by your Zyxel Device.

Table 111 Maintenance > Time (continued)

LABEL	DESCRIPTION
First ~ Fifth Time Server Address	<p>Select an NTP time server from the drop-down list box.</p> <p>Otherwise, select Other and enter the IP address or URL (up to 29 extended ASCII characters in length) of your time server.</p> <p>Select None if you don't want to configure the time server.</p> <p>Check with your ISP/network administrator if you are unsure of this information.</p>
Time Zone	
Time zone	Choose the time zone of your location. This will set the time difference between your time zone and Greenwich Mean Time (GMT).
Daylight Savings	Daylight Saving Time is a period from late spring to early fall when many countries set their clocks ahead of normal local time by one hour to give more daytime light in the evening.
Active	Click this switch to enable or disable Daylight Saving Time. When the switch turns blue  , the function is enabled. Otherwise, it's not.
Start Rule	<p>Configure the day and time when Daylight Saving Time starts if you enabled Daylight Saving. You can select a specific date in a particular month or a specific day of a specific week in a particular month. The Time field uses the 24 hour format. Here are a couple of examples:</p> <p>Daylight Saving Time starts in most parts of the United States on the second Sunday of March. Each time zone in the United States starts using Daylight Saving Time at 2 A.M. local time. So in the United States, set the day to Second, Sunday, the month to March and the time to 2 in the Hour field.</p> <p>Daylight Saving Time starts in the European Union on the last Sunday of March. All of the time zones in the European Union start using Daylight Saving Time at the same moment (1 A.M. GMT or UTC). So in the European Union you would set the day to Last, Sunday and the month to March. The time you select in the o'clock field depends on your time zone. In Germany for instance, you would select 2 in the Hour field because Germany's time zone is one hour ahead of GMT or UTC (GMT+1).</p>
End Rule	<p>Configure the day and time when Daylight Saving Time ends if you enabled Daylight Saving. You can select a specific date in a particular month or a specific day of a specific week in a particular month. The Time field uses the 24 hour format. Here are a couple of examples:</p> <p>Daylight Saving Time ends in the United States on the first Sunday of November. Each time zone in the United States stops using Daylight Saving Time at 2 A.M. local time. So in the United States you would set the day to First, Sunday, the month to November and the time to 2 in the Hour field.</p> <p>Daylight Saving Time ends in the European Union on the last Sunday of October. All of the time zones in the European Union stop using Daylight Saving Time at the same moment (1 A.M. GMT or UTC). So in the European Union you would set the day to Last, Sunday, and the month to October. The time you select in the o'clock field depends on your time zone. In Germany for instance, you would select 2 in the Hour field because Germany's time zone is one hour ahead of GMT or UTC (GMT+1).</p>
Cancel	Click Cancel to exit this screen without saving.
Apply	Click Apply to save your changes.

CHAPTER 30

E-mail Notification

30.1 E-mail Notification Overview

A mail server is an application or a computer that can receive, forward and deliver e-mail messages.

To have the Zyxel Device send reports, logs or notifications via e-mail, you must specify an e-mail server and the e-mail addresses of the sender and receiver.

30.2 E-mail Notification

Use this screen to view, remove and add e-mail account information on the Zyxel Device. This account can be set to send e-mail notifications for logs.

Click **Maintenance > E-mail Notification** to open the **E-mail Notification** screen.

Note: The default port number of the mail server is 25.

Figure 187 Maintenance > E-mail Notification

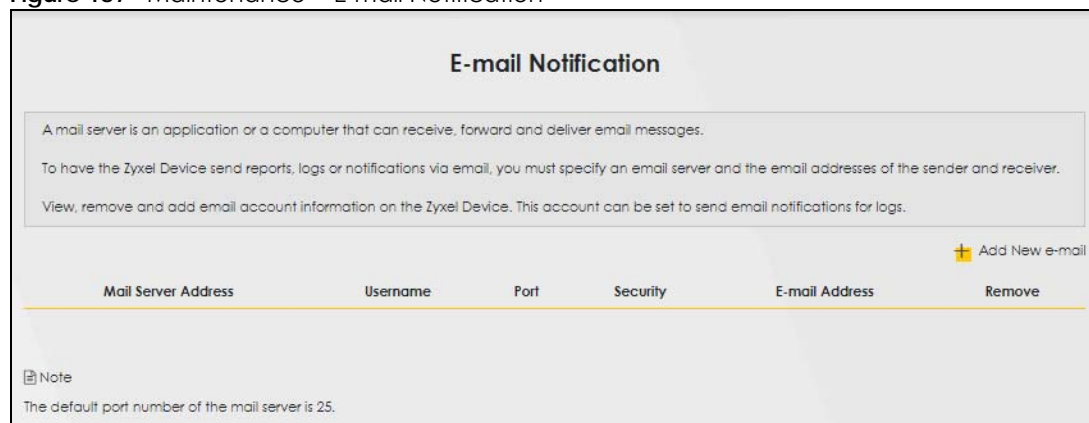

The following table describes the labels in this screen.

Table 112 Maintenance > E-mail Notification

LABEL	DESCRIPTION
Add New e-mail	Click this button to create a new entry (up to 32 can be created).
Mail Server Address	This displays the server name or the IP address of the mail server.
User name	This displays the user name of the sender's mail account.
Port	This field displays the port number of the mail server.
Security	This field displays the protocol used for encryption.

Table 112 Maintenance > E-mail Notification (continued)

LABEL	DESCRIPTION
E-mail Address	This field displays the e-mail address that you want to be in the from/sender line of the e-mail that the Zyxel Device sends.
Remove	Click this button to delete the selected entry(ies).

30.2.1 E-mail Notification Edit

Click the **Add** button in the **E-mail Notification** screen. Use this screen to configure the required information for sending e-mail via a mail server.

Figure 188 E-mail Notification > Add

The following table describes the labels in this screen.

Table 113 E-mail Notification > Add

LABEL	DESCRIPTION
Mail Server Address	Enter the server name or the IP address of the mail server for the e-mail address specified in the Account e-mail Address field. If this field is left blank, reports, logs or notifications will not be sent via e-mail.
Port	Enter the same port number here as is on the mail server for mail traffic.
Authentication User name	Enter the user name (up to 32 characters). This is usually the user name of a mail account you specified in the Account email Address field.
Authentication Password	Enter the password associated with the user name above.
Account e-mail Address	Enter the e-mail address that you want to be in the from/sender line of the e-mail notification that the Zyxel Device sends. If you activate SSL/TLS authentication, the e-mail address must be able to be authenticated by the mail server as well.

Table 113 E-mail Notification > Add (continued)

LABEL	DESCRIPTION
Connection Security	Select SSL to use Secure Sockets Layer (SSL) or Transport Layer Security (TLS) if you want encrypted communications between the mail server and the Zyxel Device. Select STARTTLS to upgrade a plain text connection to a secure connection using SSL/TLS.
Cancel	Click this button to begin configuring this screen afresh.
OK	Click this button to save your changes and return to the previous screen.

CHAPTER 31

Log Setting

31.1 Log Setting Overview

Use this screen to configure where the Zyxel Device sends logs, and which type of logs the Zyxel Device records.

31.2 Log Setting

You can configure where the Zyxel Device sends logs and which type of logs the Zyxel Device records in the **Logs Setting** screen.

If you have a server that is running a syslog service, you can also save log files to it by enabling **Syslog Logging**, and then entering the IP address of the server in the **Syslog Server** field. Select **Remote** to store logs on the syslog server, or select **Local File** to store logs on the Zyxel Device. Select **Local File and Remote** to store logs on both the Zyxel Device and the syslog server. To change your Zyxel Device's log settings, click **Maintenance > Log Setting**. The screen appears as shown.

Figure 189 Maintenance > Log Setting

Log Setting

You can configure where the Zyxel Device sends logs and which logs and/or immediate alerts the Zyxel Device records.

If there is a LAN client on your network or a remote server that is running a syslog utility, you can save log files from LAN computers to it by enabling **Syslog Logging**, selecting **Remote** or **Local File and Remote** in the **Mode** field, and entering the IP address of the syslog server in the **Syslog Server** field. **Remote** allows you to store logs on a syslog server, while **Local File** allows you to store them on the Zyxel Device. **Local File and Remote** means your logs are stored both on the Zyxel Device and on a syslog server.

Syslog Setting

Syslog Logging

Mode: Local File

Syslog Server: 0 . 0 . 0 . 0 (Server NAME or IPv4/IPv6 Address)

UDP Port: 514 (Server Port)

E-mail Log Settings

E-mail Log Settings

Mail Account: Select one account

System Log Mail Subject:

Security Log Mail Subject:

Send Log to: (E-Mail Address)

Send Alarm to: (E-Mail Address)

Alarm Interval: 60 (seconds)

Active Log

System Log

WAN-DHCP

DHCP Server

TR-069

HTP

UPNP

System

ACL

Wireless

Cellular WAN

Security Log

Account

Attack

Firewall

MAC Filter

The following table describes the fields in this screen.

Table 114 Maintenance > Log Setting

LABEL	DESCRIPTION
Syslog Settings	
Syslog Logging	Click the switch (it will turn blue) to enable syslog logging.
Mode	<p>Select Remote to have the Zyxel Device send it to an external syslog server.</p> <p>Select Local File to have the Zyxel Device save the log file on the Zyxel Device itself.</p> <p>Select Local File and Remote to have the Zyxel Device save the log file on the Zyxel Device itself and send it to an external syslog server.</p> <p>Note: A warning appears upon selecting Remote or Local File and Remote. Just click OK to continue.</p>

Table 114 Maintenance > Log Setting (continued)

LABEL	DESCRIPTION
Syslog Server	Enter the server name or IP address of the syslog server that will log the selected categories of logs.
UDP Port	Enter the port number used by the syslog server.
E-mail Log Settings	
E-mail Log Setting	Click the switch (it will turn blue) to allow the sending via e-mail the system and security logs to the e-mail address specified in Send Log to . Note: Make sure that the Mail Server Address field is not left blank in the Maintenance > E-mail Notifications screen.
Mail Account	Select a server specified in Maintenance > E-mail Notifications to send the logs to.
System Log Mail Subject	This field allows you to enter a descriptive name for the system log e-mail (for example Zyxel System Log). Up to 127 characters are allowed for the System Log Mail Subject including special characters inside the square brackets [!#%()*+,-./:=?@[\\{}~].
Security Log Mail Subject	This field allows you to enter a descriptive name for the security log e-mail (for example Zyxel Security Log). Up to 127 characters are allowed for the Security Log Mail Subject including special characters inside the square brackets [!#%()*+,-./:=?@[\\{}~].
Send Log to	This field allows you to enter the log's designated e-mail recipient. The log's format is plain text file sent as an e-mail attachment.
Send Alarm to	This field allows you to enter the alarm's designated e-mail recipient. The alarm's format is plain text file sent as an e-mail attachment.
Alarm Interval	Select the frequency of showing of the alarm.
Active Log	
System Log	Select the categories of System Logs that you want to record.
Security Log	Select the categories of Security Logs that you want to record.
Apply	Click Apply to save your changes.
Cancel	Click Cancel to restore your previously saved settings.

CHAPTER 32

Firmware Upgrade

32.1 Overview

This chapter explains how to upload new firmware to your Zyxel Device. You can download new firmware releases from your nearest Zyxel FTP site (or www.zyxel.com) to use to upgrade your Zyxel Device's performance.

Only use firmware for your Zyxel Device's specific model. Refer to the label on the bottom of your Zyxel Device.

32.2 Firmware Upgrade

This screen lets you upload new firmware to your Zyxel Device. Download the latest firmware file from the Zyxel website and upload it to your Zyxel Device using this screen. The upload process uses HTTP (Hypertext Transfer Protocol) and may take up to three minutes. After a successful upload, the Zyxel Device will reboot.

Click **Maintenance > Firmware Upgrade** to open the following screen.

Do NOT turn off the Zyxel Device while firmware upload is in progress!

Figure 190 Maintenance > Firmware Upgrade

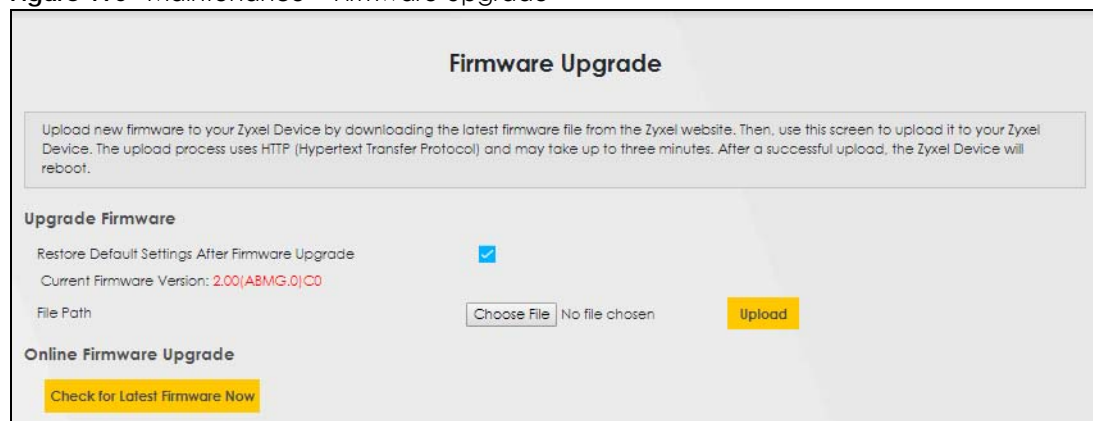

The screenshot shows a web interface titled "Firmware Upgrade". At the top, there is a heading "Firmware Upgrade". Below the heading is a text box containing instructions: "Upload new firmware to your Zyxel Device by downloading the latest firmware file from the Zyxel website. Then, use this screen to upload it to your Zyxel Device. The upload process uses HTTP (Hypertext Transfer Protocol) and may take up to three minutes. After a successful upload, the Zyxel Device will reboot." Below this text box are two sections: "Upgrade Firmware" and "Online Firmware Upgrade". In the "Upgrade Firmware" section, there is a checkbox labeled "Restore Default Settings After Firmware Upgrade" which is checked. Below the checkbox, it says "Current Firmware Version: 2.00(ABMG.0)C0". There is a "File Path" label, a "Choose File" button, and the text "No file chosen". To the right of the "Choose File" button is a yellow "Upload" button. In the "Online Firmware Upgrade" section, there is a yellow button labeled "Check for Latest Firmware Now".

The following table describes the labels in this screen.

Table 115 Maintenance > Firmware Upgrade

LABEL	DESCRIPTION
Upgrade Firmware	Use these fields to upload firmware to the Zyxel Device.
Restore Default Settings After Firmware Upgrade	Click to enable this option that restores the factory-default to the Zyxel Device after upgrading the firmware. Note: Make sure to backup the Zyxel Device's configuration settings first in case the restore to factory-default process is not successful. Refer to Section 33.2 on page 266 .
Current Firmware Version	This is the present firmware version.
File Path	Type in the location of the file you want to upload in this field or click Choose File to find it.
Choose File	Click this to find the .bin file you want to upload. Remember that you must decompress compressed (.zip) files before you can upload them.
Upload	Click this to begin the upload process. This process may take up to three minutes.

After you see the firmware updating screen, wait a few minutes before logging into the Zyxel Device again.

The Zyxel Device automatically restarts in this time causing a temporary network disconnect. In some operating systems, you may see the following icon on your desktop.

Figure 191 Network Temporarily Disconnected

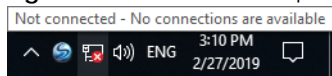

After two minutes, log in again and check your new firmware version in the **Status** screen.

If the upload was not successful, an error screen will appear. Click **OK** to go back to the **Firmware Upgrade** screen.

CHAPTER 33

Backup/Restore

33.1 Backup/Restore Overview

Information related to factory default settings and backup configuration are shown in this screen. You can also use this to restore previous device configurations.

33.2 Backup/Restore

Click **Maintenance > Backup/Restore**. Information related to factory defaults, backup configuration, and restoring configuration appears in this screen, as shown next.

Figure 192 Maintenance > Backup/Restore

The screenshot shows the 'Backup/Restore' configuration page. At the top, there is a title 'Backup/Restore' and a brief overview: 'Back up and restore your Zyxel Device configurations. You can also reset your Zyxel Device settings back to the factory default.' Below this, there are three main sections: 'Backup Configuration', 'Restore Configuration', and 'Back to Factory Default Settings'. Each section contains descriptive text and a corresponding action button (Backup, Upload, and Reset). The 'Restore Configuration' section includes a file path input field with a 'Browse...' button and an 'Upload' button. The 'Back to Factory Default Settings' section lists the default settings after a reset: Password will be 1234, LAN IP address will be 192.168.1.1, and DHCP will be reset to default setting.

Backup/Restore

Back up and restore your Zyxel Device configurations. You can also reset your Zyxel Device settings back to the factory default.

Backup Configuration

Click Backup to back up (save) the Zyxel Device's current configuration to a file on your computer. Once the Zyxel Device is configured and functioning properly, it is highly recommended that you back up your configuration file before making configuration changes. The backup configuration file will be useful in case you need to return to your previous settings.

Restore Configuration

Click Restore to upload a new or previously saved configuration file from your computer to your Zyxel Device.

Backup Configuration

Click Backup to save the current configuration of your system to your computer.

Backup

Restore Configuration

To restore a previously saved configuration file to your system, browse to the location of the configuration file and click Upload.

File Path No file selected. **Upload**

Back to Factory Default Settings

Click Reset to clear all user-entered configuration information and return to factory default settings. After resetting, the

- Password will be 1234
- LAN IP address will be 192.168.1.1
- DHCP will be reset to default setting

Reset

Backup Configuration

Backup Configuration allows you to back up (save) the Zyxel Device's current configuration to a file on your computer. Once your Zyxel Device is configured and functioning properly, it is highly recommended that you back up your configuration file before making configuration changes.

Click **Backup** to save the Zyxel Device's current configuration to your computer.

Restore Configuration

Restore Configuration allows you to upload a new or previously saved configuration file from your computer to your Zyxel Device.

Table 116 Restore Configuration

LABEL	DESCRIPTION
File Path	Type in the location of the file you want to upload in this field or click Choose File to find it.
Choose File	Click this to find the file you want to upload. Remember that you must decompress compressed (.ZIP) files before you can upload them.
Upload	Click this to begin the upload process.
Reset	Click this to reset your Zyxel Device settings back to the factory default.

Do not turn off the Zyxel Device while configuration file upload is in progress.

After the Zyxel Device configuration has been restored successfully, the login screen appears. Login again to restart the Zyxel Device.

The Zyxel Device automatically restarts in this time causing a temporary network disconnect. In some operating systems, you may see the following icon on your desktop.

Figure 193 Network Temporarily Disconnected

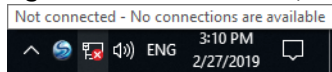

If you restore the default configuration, you may need to change the IP address of your computer to be in the same subnet as that of the default Zyxel Device IP address (192.168.1.1).

If the upload was not successful, an error screen will appear. Click **OK** to go back to the **Configuration** screen.

33.3 Reboot

System **Reboot** allows you to reboot the Zyxel Device remotely without turning the power off. You may need to do this if the Zyxel Device hangs, for example. This does not affect the Zyxel Device's configuration.

Click **Maintenance > Reboot**. Click **Reboot** to have the Zyxel Device reboot.

Figure 194 Maintenance > Reboot

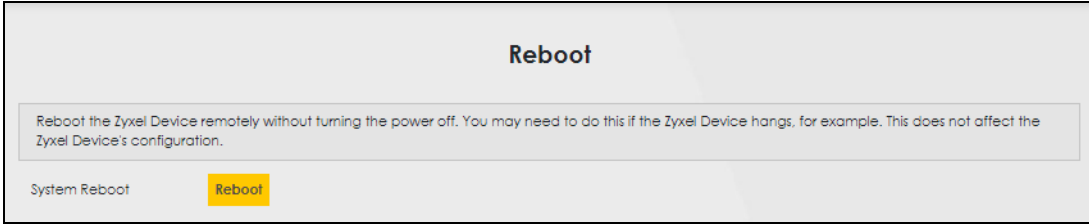

CHAPTER 34

Diagnostic

34.1 Diagnostic Overview

The **Diagnostic** screens display information to help you identify problems with the Zyxel Device.

34.2 Ping/TraceRoute/Nslookup Test

Use this screen to ping, traceroute, or nslookup for troubleshooting. Ping and traceroute are used to test whether a particular host is reachable. After entering an IP address and clicking one of the buttons to start a test, the results will be shown in the Ping/Traceroute Test area. Use nslookup to find the IP address for a host name and vice versa. Click **Maintenance > Diagnostic** to open the **Ping/TraceRoute/Nslookup** screen shown next.

Figure 195 Maintenance > Diagnostic > Ping/Trace Route/Nslookup

The screenshot shows a web interface titled "Diagnostic". It contains a large text area with instructions: "You can use different diagnostic methods to test a connection and see its detailed information. The **Diagnostic** screens display information to help you identify problems with the Zyxel Device." Below this is a section labeled "Ping/TraceRoute Test" with a large empty rectangular area for results. At the bottom, there is a "TCP/IP" section with an "Address" input field and five buttons: "Ping", "Ping 6", "Trace Route", "Trace Route 6", and "Nslookup".

The following table describes the fields in this screen.

Table 117 Maintenance > Diagnostic

LABEL	DESCRIPTION
Ping/ TraceRoute Test	The result of tests is shown here in the info area.
TCP/IP	

Table 117 Maintenance > Diagnostic (continued)

LABEL	DESCRIPTION
Address	Enter either an IP address or a host name to start a test.
Ping	Click this button to perform a ping test on the IPv4 address or host name in order to test a connection. The ping statistics will show in the info area.
Ping 6	Click this button to perform a ping test on the IPv6 address or host name in order to test a connection. The ping statistics will show in the info area.
Trace Route	Click this button to perform the IPv4 trace route function. This determines the path a packet takes to the specified host.
Trace Route 6	Click this button to perform the IPv6 trace route function. This determines the path a packet takes to the specified host.
Nslookup	Click this button to perform a DNS lookup on the IP address or host name.

CHAPTER 35

Troubleshooting

35.1 Overview

This chapter offers some suggestions to solve problems you might encounter. The potential problems are divided into the following categories.

- [Power and Hardware Connections](#)
- [Zyxel Device Access and Login](#)
- [Internet Access](#)
- [USB Device Connection](#)
- [UPnP](#)
- [SIM Card](#)
- [Cellular Signal](#)

35.2 Power and Hardware Connections

[The Zyxel Device does not turn on.](#)

For LTE3301-PLUS / LTE5388-M804 / LTE5398-M904 / LTE3316-M604

- 1 Make sure you are using the power adapter included with the Zyxel Device.
- 2 Make sure the power adapter is connected to the Zyxel Device and plugged in to an appropriate power source. Make sure the power source is turned on.
- 3 Disconnect and re-connect the power adapter to the Zyxel Device.
- 4 Make sure you've pressed the **POWER** button to turn on the Zyxel Device.
- 5 If the problem continues, contact the vendor.

For LTE7240-M403/LTE7461-M602/LTE7480-S905

- 1 Make sure you are using the PoE injector and cable (Power over Ethernet, PoE) included with the Zyxel Device.

- 2 Make sure the PoE is connected to the Zyxel Device and plugged in to an appropriate power source. Make sure the power source is turned on.
- 3 Turn the Zyxel Device off and on.
- 4 If the problem continues, contact the vendor.

35.3 Zyxel Device Access and Login

I forgot the IP address for the Zyxel Device.

- 1 The default IP address is 192.168.1.1.
- 2 If you changed the IP address and have forgotten it, you might get the IP address of the Zyxel Device by looking up the IP address of the default gateway for your computer. To do this in most Windows computers, click **Start > Run**, enter **cmd**, and then enter **ipconfig**. The IP address of the **Default Gateway** might be the IP address of the Zyxel Device (it depends on the network), so enter this IP address in your Internet browser.
- 3 If this does not work, you have to reset the Zyxel Device to its factory defaults. Refer to [Section 33.2 on page 266](#).

I forgot the password.

- 1 See the Zyxel Device label for the default admin password.
- 2 If you changed the password, and can't remember the password, you have to reset the Zyxel Device to its factory defaults. Refer to [Section 33.2 on page 266](#).

I cannot see or access the **Login** screen in the Web Configurator.

- 1 Make sure you are using the correct IP address.
 - The default IP address is 192.168.1.1.
 - If you changed the IP address ([Section 8.2 on page 132](#)), use the new IP address.
 - If you changed the IP address and have forgotten it, see the troubleshooting suggestions for [I forgot the IP address for the Zyxel Device](#).
- 2 Check the hardware connections, see the Quick Start Guide.
- 3 Make sure your Internet browser does not block pop-up windows and has JavaScript and Java enabled.

- 4 Reset the Zyxel Device to its factory default, and try to access the Zyxel Device with the default IP address. Refer to [Section 33.2 on page 266](#).
- 5 If the problem continues, contact the network administrator or vendor, or try the advanced suggestion.

Advanced Suggestion

- Try to access the Zyxel Device using another service, such as Telnet. If you can access the Zyxel Device, check the remote management settings and firewall rules to find out why the Zyxel Device does not respond to HTTP.

I can see the [Login](#) screen, but I cannot log in to the Zyxel Device.

- 1 Make sure you have entered the user name and password correctly. The default user name is **admin**. These fields are case-sensitive, so make sure [Caps Lock] is not on.
- 2 You cannot log in to the Web Configurator while someone is using Telnet to access the Zyxel Device. Log out of the Zyxel Device in the other session, or ask the person who is logged in to log out.
- 3 Turn the Zyxel Device off and on.
- 4 If this does not work, you have to reset the Zyxel Device to its factory default. See [Section 33.2 on page 266](#).

I cannot use FTP, Telnet, SSH or Ping to access the Zyxel Device.

See the Remote Management [Chapter 27 on page 248](#) for details on allowing web services (such as HTTP, HTTPS, FTP, Telnet, SSH and Ping) to access the Zyxel Device.

Check the server **Port** number field for the web service in the **Maintenance > Remote Management** screen. You must use the same port number in order to use that web service for remote management.

35.4 Internet Access

I cannot access the Internet.

- 1 Check the hardware connections and make sure the LEDs are behaving as expected. See the **Quick Start Guide** and [Section 1.5.1 on page 24](#).
- 2 Check the SIM card. Maybe it has wrong settings (refer to [Section 6.6 on page 92](#)), the account has expired, it became loose (remove and reinsert it - refer to the Quick Start Guide) or it's missing (stolen). See [Section 35.7 on page 276](#) for possible SIM card problems.

- 3 Make sure you entered your ISP account information correctly. These fields are case-sensitive, so make sure [Caps Lock] is not on.
- 4 For LTE3301-PLUS / LTE5388-M804 / LTE5398-M904 / LTE3316-M604 make sure you converted the first or fourth LAN port to a WAN port. Click **Enable** in **Network Setting > Broadband > Ethernet WAN** screen. Make sure you have the Ethernet WAN port connected to a modem or router.
- 5 If the problem continues, contact your ISP.

[I cannot access the Internet anymore. I had access to the Internet \(with the Zyxel Device\), but my Internet connection is not available anymore.](#)

- 1 Check the hardware connections (refer to the Quick Start Guide).
- 2 Turn the Zyxel Device off and on.
- 3 If the problem continues, contact your ISP.

[The Internet connection is slow or intermittent.](#)

- 1 There might be a lot of traffic on the network. If the Zyxel Device is sending or receiving a lot of information, try closing some programs that use the Internet, especially peer-to-peer applications.
- 2 Check the signal strength. Look at the LEDs, and check the LED section for more information. If the signal strength is low, try moving the Zyxel Device closer to the ISP's base station if possible, and look around to see if there are any devices that might be interfering with the wireless network (for example, microwaves, other wireless networks, and so on).
- 3 For the LTE3301-PLUS / LTE5388-M804 / LTE5398-M904 / LTE3316-M604, connect two external antennas to improve the wireless WAN signal strength. Point the antennas to the base stations directions if you know where they are, or try pointing the antennas in different directions and check which provides the strongest signal to the Zyxel Device. See the Introduction chapter for more information.
- 4 Turn the Zyxel Device off and on.
- 5 If the problem continues, contact the network administrator or vendor, or try the advanced suggestion (refer to [I cannot see or access the Login screen in the Web Configurator](#) in this chapter).

Note: Since your Zyxel Device is an outdoor-type, inclement weather like rain and hot weather may affect LTE signals.

35.5 USB Device Connection

The Zyxel Device fails to detect my USB device.

- 1 Disconnect the USB device.
- 2 Reboot the Zyxel Device.
- 3 If you are connecting a USB hard drive that comes with an external power supply, make sure it is connected to an appropriate power source that is on.
- 4 Re-connect your USB device to the Zyxel Device.

35.6 UPnP

When using UPnP and the Zyxel Device reboots, my computer cannot detect UPnP and refresh **My Network Places > Local Network**.

- 1 Make sure that UPnP is enabled in your computer. For Windows 7, see [Section 8.6 on page 140](#). For Windows 10, see [Section 8.7 on page 144](#).
- 2 Make sure that UPnP is enabled in the **Network Settings > Home Networking > UPnP** screen. See [Section 8.4 on page 138](#) for details.
- 3 Disconnect the Ethernet cable from the Zyxel Device's Ethernet port or from your computer.
- 4 Re-connect the Ethernet cable.

The **Local Area Connection** icon for UPnP disappears in the screen.

Restart your computer.

I cannot open special applications such as white board, file transfer and video when I use the MSN Messenger.

- 1 Wait more than three minutes.
- 2 Restart the applications.

35.7 SIM Card

The SIM card cannot be detected.

- 1 Disconnect the Zyxel Device from the power supply.
- 2 Remove the SIM card from its slot.
- 3 Clean the SIM card slot of any loose debris using compressed air.
- 4 Clean the gold connectors on the SIM card with a clean lint-free cloth.
- 5 Insert the SIM card into its slot and connect the Zyxel Device to the power supply to restart it.

I get an **Invalid SIM card** alert.

- 1 Make sure you have an active plan with your ISP.
- 2 Make sure that the Zyxel Device is in the coverage area of a cellular network.

35.8 Cellular Signal

How should I position the Zyxel Device to get a strong cellular signal?

- 1 Find the location of your nearest cellular base station(s), then install the Zyxel Device towards the direction of those sites. The nearest site or site with a direct line-of-sight is usually preferred.

Note: It is best to test towards more than one cellular site, as the nearest site / line-of-sight is not always the best due to the terrain, interference, density of usage, etc. All of these factors influence the stability, availability and throughput of the link to the Zyxel Device.

- 2 Position the Zyxel Device towards a direction where coverage is expected (example the nearest town).
- 3 Conduct test measurements using the Web Configurator's **System Monitor > Cellular WAN Status** screen to obtain a report of the cellular network signal strength and quality at various test positions.

Note: It is best to reboot the Zyxel Device before each test measurement is taken to ensure that it is not camping on the previous cellular site. This is because the Zyxel Device can 'lock' onto the previous cellular site even when the new cellular site is at a much better signal level and quality.

Although installing the Zyxel Device as high as possible is the usual rule of thumb, it is sometimes possible that the Zyxel Device is in a weak coverage spot at that specific height. Adjust the height to achieve the best service possible.

Note: Cellular network signals and quality can fluctuate. A measurement taken now and a few moments later can differ substantially even if nothing apparent has changed – this can be due to many aspects, such as fading, reflections, interference, capacity due to high network traffic, etc.

It is possible that the network topology and usage changes over time, even from one minute to the next as network utilization increases. If poor performance is experienced at a later stage, re-test different installation locations again. It is possible that the current serving cellular site has become over utilized or is out-of-service. As the network design and topology changes, so will the experience change, either for the better or for the worse.

PART III

Appendices

Appendices contain general information. Some information may not apply to your Zyxel Device.

APPENDIX A

Customer Support

In the event of problems that cannot be solved by using this manual, you should contact your vendor. If you cannot contact your vendor, then contact a Zyxel office for the region in which you bought the device.

See <https://www.zyxel.com/homepage.shtml> and also https://www.zyxel.com/about_zyxel/zyxel_worldwide.shtml for the latest information.

Please have the following information ready when you contact an office.

Required Information

- Product model and serial number.
- Warranty Information.
- Date that you received your device.
- Brief description of the problem and the steps you took to solve it.

Corporate Headquarters (Worldwide)

Taiwan

- Zyxel Communications Corporation
- <https://www.zyxel.com>

Asia

China

- Zyxel Communications (Shanghai) Corp.
- Zyxel Communications (Beijing) Corp.
- Zyxel Communications (Tianjin) Corp.
- <https://www.zyxel.com/cn/zh/>

India

- Zyxel Technology India Pvt Ltd
- <https://www.zyxel.com/in/en/>

Kazakhstan

- Zyxel Kazakhstan
- <https://www.zyxel.kz>

Korea

- Zyxel Korea Corp.
- <http://www.zyxel.kr>

Malaysia

- Zyxel Malaysia Sdn Bhd.
- <http://www.zyxel.com.my>

Pakistan

- Zyxel Pakistan (Pvt.) Ltd.
- <http://www.zyxel.com.pk>

Philippines

- Zyxel Philippines
- <http://www.zyxel.com.ph>

Singapore

- Zyxel Singapore Pte Ltd.
- <http://www.zyxel.com.sg>

Taiwan

- Zyxel Communications Corporation
- <https://www.zyxel.com/tw/zh/>

Thailand

- Zyxel Thailand Co., Ltd
- <https://www.zyxel.com/th/th/>

Vietnam

- Zyxel Communications Corporation-Vietnam Office
- <https://www.zyxel.com/vn/vi>

Europe

Belarus

- Zyxel BY
- <https://www.zyxel.by>

Belgium

- Zyxel Communications B.V.
- <https://www.zyxel.com/be/nl/>

- <https://www.zyxel.com/be/fr/>

Bulgaria

- Zyxel България
- <https://www.zyxel.com/bg/bg/>

Czech Republic

- Zyxel Communications Czech s.r.o
- <https://www.zyxel.com/cz/cs/>

Denmark

- Zyxel Communications A/S
- <https://www.zyxel.com/dk/da/>

Estonia

- Zyxel Estonia
- <https://www.zyxel.com/ee/et/>

Finland

- Zyxel Communications
- <https://www.zyxel.com/fi/fi/>

France

- Zyxel France
- <https://www.zyxel.fr>

Germany

- Zyxel Deutschland GmbH
- <https://www.zyxel.com/de/de/>

Hungary

- Zyxel Hungary & SEE
- <https://www.zyxel.com/hu/hu/>

Italy

- Zyxel Communications Italy
- <https://www.zyxel.com/it/it/>

Latvia

- Zyxel Latvia
- <https://www.zyxel.com/lv/lv/>

Lithuania

- Zyxel Lithuania
- <https://www.zyxel.com/lt/lt/>

Netherlands

- Zyxel Benelux
- <https://www.zyxel.com/nl/nl/>

Norway

- Zyxel Communications
- <https://www.zyxel.com/no/no/>

Poland

- Zyxel Communications Poland
- <https://www.zyxel.com/pl/pl/>

Romania

- Zyxel Romania
- <https://www.zyxel.com/ro/ro>

Russia

- Zyxel Russia
- <https://www.zyxel.com/ru/ru/>

Slovakia

- Zyxel Communications Czech s.r.o. organizacna zlozka
- <https://www.zyxel.com/sk/sk/>

Spain

- Zyxel Communications ES Ltd
- <https://www.zyxel.com/es/es/>

Sweden

- Zyxel Communications
- <https://www.zyxel.com/se/sv/>

Switzerland

- Studerus AG
- <https://www.zyxel.ch/de>
- <https://www.zyxel.ch/fr>

Turkey

- Zyxel Turkey A.S.
- <https://www.zyxel.com/tr/tr/>

UK

- Zyxel Communications UK Ltd.
- <https://www.zyxel.com/uk/en/>

Ukraine

- Zyxel Ukraine
- <http://www.ua.zyxel.com>

South America

Argentina

- Zyxel Communications Corporation
- <https://www.zyxel.com/co/es/>

Brazil

- Zyxel Communications Brasil Ltda.
- <https://www.zyxel.com/br/pt/>

Colombia

- Zyxel Communications Corporation
- <https://www.zyxel.com/co/es/>

Ecuador

- Zyxel Communications Corporation
- <https://www.zyxel.com/co/es/>

South America

- Zyxel Communications Corporation
- <https://www.zyxel.com/co/es/>

Middle East

Israel

- Zyxel Communications Corporation
- <http://il.zyxel.com/>

Middle East

- Zyxel Communications Corporation
- <https://www.zyxel.com/me/en/>

North America

USA

- Zyxel Communications, Inc. - North America Headquarters
- <https://www.zyxel.com/us/en/>

Oceania

Australia

- Zyxel Communications Corporation
- <https://www.zyxel.com/au/en/>

Africa

South Africa

- Nology (Pty) Ltd.
- <https://www.zyxel.com/za/en/>

APPENDIX B

IPv6

Overview

IPv6 (Internet Protocol version 6), is designed to enhance IP address size and features. The increase in IPv6 address size to 128 bits (from the 32-bit IPv4 address) allows up to 3.4×10^{38} IP addresses.

IPv6 Addressing

The 128-bit IPv6 address is written as eight 16-bit hexadecimal blocks separated by colons (:). This is an example IPv6 address `2001:0db8:1a2b:0015:0000:0000:1a2f:0000`.

IPv6 addresses can be abbreviated in two ways:

- Leading zeros in a block can be omitted. So `2001:0db8:1a2b:0015:0000:0000:1a2f:0000` can be written as `2001:db8:1a2b:15:0:0:1a2f:0`.
- Any number of consecutive blocks of zeros can be replaced by a double colon. A double colon can only appear once in an IPv6 address. So `2001:0db8:0000:0000:1a2f:0000:0000:0015` can be written as `2001:0db8::1a2f:0000:0000:0015`, `2001:0db8:0000:0000:1a2f::0015`, `2001:db8::1a2f:0:0:15` or `2001:db8:0:0:1a2f::15`.

Prefix and Prefix Length

Similar to an IPv4 subnet mask, IPv6 uses an address prefix to represent the network address. An IPv6 prefix length specifies how many most significant bits (start from the left) in the address compose the network address. The prefix length is written as “/x” where x is a number. For example,

`2001:db8:1a2b:15::1a2f:0/32`

means that the first 32 bits (`2001:db8`) is the subnet prefix.

Link-local Address

A link-local address uniquely identifies a device on the local network (the LAN). It is similar to a “private IP address” in IPv4. You can have the same link-local address on multiple interfaces on a device. A link-local unicast address has a predefined prefix of `fe80::/10`. The link-local unicast address format is as follows.

Table 118 Link-local Unicast Address Format

1111 1110 10	0	Interface ID
10 bits	54 bits	64 bits

Global Address

A global address uniquely identifies a device on the Internet. It is similar to a “public IP address” in IPv4. A global unicast address starts with a 2 or 3.

Unspecified Address

An unspecified address (0:0:0:0:0:0 or ::) is used as the source address when a device does not have its own address. It is similar to "0.0.0.0" in IPv4.

Loopback Address

A loopback address (0:0:0:0:0:1 or ::1) allows a host to send packets to itself. It is similar to "127.0.0.1" in IPv4.

Multicast Address

In IPv6, multicast addresses provide the same functionality as IPv4 broadcast addresses. Broadcasting is not supported in IPv6. A multicast address allows a host to send packets to all hosts in a multicast group.

Multicast scope allows you to determine the size of the multicast group. A multicast address has a predefined prefix of ff00::/8. The following table describes some of the predefined multicast addresses.

Table 119 Predefined Multicast Address

MULTICAST ADDRESS	DESCRIPTION
FF01:0:0:0:0:0:0:1	All hosts on a local node.
FF01:0:0:0:0:0:0:2	All routers on a local node.
FF02:0:0:0:0:0:0:1	All hosts on a local connected link.
FF02:0:0:0:0:0:0:2	All routers on a local connected link.
FF05:0:0:0:0:0:0:2	All routers on a local site.
FF05:0:0:0:0:0:0:1:3	All DHCP servers on a local site.

The following table describes the multicast addresses which are reserved and cannot be assigned to a multicast group.

Table 120 Reserved Multicast Address

MULTICAST ADDRESS
FF00:0:0:0:0:0:0:0
FF01:0:0:0:0:0:0:0
FF02:0:0:0:0:0:0:0
FF03:0:0:0:0:0:0:0
FF04:0:0:0:0:0:0:0
FF05:0:0:0:0:0:0:0
FF06:0:0:0:0:0:0:0
FF07:0:0:0:0:0:0:0
FF08:0:0:0:0:0:0:0
FF09:0:0:0:0:0:0:0
FF0A:0:0:0:0:0:0:0
FF0B:0:0:0:0:0:0:0
FF0C:0:0:0:0:0:0:0
FF0D:0:0:0:0:0:0:0

Table 120 Reserved Multicast Address (continued)

MULTICAST ADDRESS
FF0E:0:0:0:0:0:0:0
FF0F:0:0:0:0:0:0:0

Subnet Masking

Both an IPv6 address and IPv6 subnet mask compose of 128-bit binary digits, which are divided into eight 16-bit blocks and written in hexadecimal notation. Hexadecimal uses four bits for each character (1 ~ 10, A ~ F). Each block's 16 bits are then represented by four hexadecimal characters. For example, FFFF:FFFF:FFFF:FFFF:FC00:0000:0000:0000.

Interface ID

In IPv6, an interface ID is a 64-bit identifier. It identifies a physical interface (for example, an Ethernet port) or a virtual interface (for example, the management IP address for a VLAN). One interface should have a unique interface ID.

EUI-64

The EUI-64 (Extended Unique Identifier) defined by the IEEE (Institute of Electrical and Electronics Engineers) is an interface ID format designed to adapt with IPv6. It is derived from the 48-bit (6-byte) Ethernet MAC address as shown next. EUI-64 inserts the hex digits ffe between the third and fourth bytes of the MAC address and complements the seventh bit of the first byte of the MAC address. See the following example.

MAC	00 : 13 : 49 : 12 : 34 : 56
EUI-64	02 : 13 : 49 : FF : FE : 12 : 34 : 56

Identity Association

An Identity Association (IA) is a collection of addresses assigned to a DHCP client, through which the server and client can manage a set of related IP addresses. Each IA must be associated with exactly one interface. The DHCP client uses the IA assigned to an interface to obtain configuration from a DHCP server for that interface. Each IA consists of a unique IAID and associated IP information.

The IA type is the type of address in the IA. Each IA holds one type of address. IA_NA means an identity association for non-temporary addresses and IA_TA is an identity association for temporary addresses.

An IA_NA option contains the T1 and T2 fields, but an IA_TA option does not. The DHCPv6 server uses T1 and T2 to control the time at which the client contacts with the server to extend the lifetimes on any addresses in the IA_NA before the lifetimes expire. After T1, the client sends the server (**S1**) (from which the addresses in the IA_NA were obtained) a Renew message. If the time T2 is reached and the server

does not respond, the client sends a Rebind message to any available server (**S2**). For an IA_TA, the client may send a Renew or Rebind message at the client's discretion.

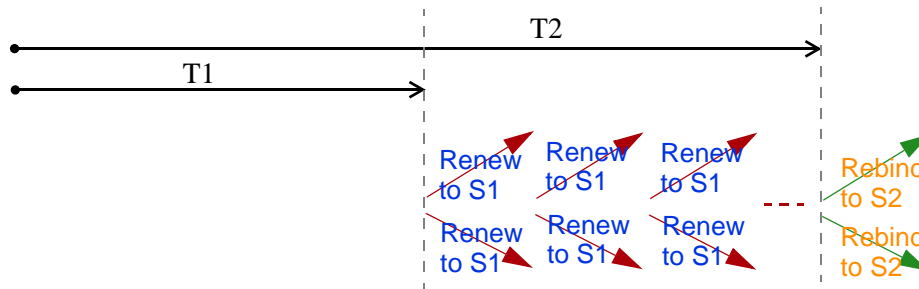

DHCP Relay Agent

A DHCP relay agent is on the same network as the DHCP clients and helps forward messages between the DHCP server and clients. When a client cannot use its link-local address and a well-known multicast address to locate a DHCP server on its network, it then needs a DHCP relay agent to send a message to a DHCP server that is not attached to the same network.

The DHCP relay agent can add the remote identification (remote-ID) option and the interface-ID option to the Relay-Forward DHCPv6 messages. The remote-ID option carries a user-defined string, such as the system name. The interface-ID option provides slot number, port information and the VLAN ID to the DHCPv6 server. The remote-ID option (if any) is stripped from the Relay-Reply messages before the relay agent sends the packets to the clients. The DHCP server copies the interface-ID option from the Relay-Forward message into the Relay-Reply message and sends it to the relay agent. The interface-ID should not change even after the relay agent restarts.

Prefix Delegation

Prefix delegation enables an IPv6 router to use the IPv6 prefix (network address) received from the ISP (or a connected uplink router) for its LAN. The Zyxel Device uses the received IPv6 prefix (for example, 2001:db2::/48) to generate its LAN IP address. Through sending Router Advertisements (RAs) regularly by multicast, the Zyxel Device passes the IPv6 prefix information to its LAN hosts. The hosts then can use the prefix to generate their IPv6 addresses.

ICMPv6

Internet Control Message Protocol for IPv6 (ICMPv6 or ICMP for IPv6) is defined in RFC 4443. ICMPv6 has a preceding Next Header value of 58, which is different from the value used to identify ICMP for IPv4. ICMPv6 is an integral part of IPv6. IPv6 nodes use ICMPv6 to report errors encountered in packet processing and perform other diagnostic functions, such as "ping".

Neighbor Discovery Protocol (NDP)

The Neighbor Discovery Protocol (NDP) is a protocol used to discover other IPv6 devices and track neighbor's reachability in a network. An IPv6 device uses the following ICMPv6 messages types:

- Neighbor solicitation: A request from a host to determine a neighbor's link-layer address (MAC address) and detect if the neighbor is still reachable. A neighbor being "reachable" means it responds to a neighbor solicitation message (from the host) with a neighbor advertisement message.
- Neighbor advertisement: A response from a node to announce its link-layer address.

- Router solicitation: A request from a host to locate a router that can act as the default router and forward packets.
- Router advertisement: A response to a router solicitation or a periodical multicast advertisement from a router to advertise its presence and other parameters.

IPv6 Cache

An IPv6 host is required to have a neighbor cache, destination cache, prefix list and default router list. The Zyxel Device maintains and updates its IPv6 caches constantly using the information from response messages. In IPv6, the Zyxel Device configures a link-local address automatically, and then sends a neighbor solicitation message to check if the address is unique. If there is an address to be resolved or verified, the Zyxel Device also sends out a neighbor solicitation message. When the Zyxel Device receives a neighbor advertisement in response, it stores the neighbor's link-layer address in the neighbor cache. When the Zyxel Device uses a router solicitation message to query for a router and receives a router advertisement message, it adds the router's information to the neighbor cache, prefix list and destination cache. The Zyxel Device creates an entry in the default router list cache if the router can be used as a default router.

When the Zyxel Device needs to send a packet, it first consults the destination cache to determine the next hop. If there is no matching entry in the destination cache, the Zyxel Device uses the prefix list to determine whether the destination address is on-link and can be reached directly without passing through a router. If the address is un-link, the address is considered as the next hop. Otherwise, the Zyxel Device determines the next-hop from the default router list or routing table. Once the next hop IP address is known, the Zyxel Device looks into the neighbor cache to get the link-layer address and sends the packet when the neighbor is reachable. If the Zyxel Device cannot find an entry in the neighbor cache or the state for the neighbor is not reachable, it starts the address resolution process. This helps reduce the number of IPv6 solicitation and advertisement messages.

Multicast Listener Discovery

The Multicast Listener Discovery (MLD) protocol (defined in RFC 2710) is derived from IPv4's Internet Group Management Protocol version 2 (IGMPv2). MLD uses ICMPv6 message types, rather than IGMP message types. MLDv1 is equivalent to IGMPv2 and MLDv2 is equivalent to IGMPv3.

MLD allows an IPv6 switch or router to discover the presence of MLD listeners who wish to receive multicast packets and the IP addresses of multicast groups the hosts want to join on its network.

MLD snooping and MLD proxy are analogous to IGMP snooping and IGMP proxy in IPv4.

MLD filtering controls which multicast groups a port can join.

MLD Messages

A multicast router or switch periodically sends general queries to MLD hosts to update the multicast forwarding table. When an MLD host wants to join a multicast group, it sends an MLD Report message for that address.

An MLD Done message is equivalent to an IGMP Leave message. When an MLD host wants to leave a multicast group, it can send a Done message to the router or switch. The router or switch then sends a group-specific query to the port on which the Done message is received to determine if other devices connected to this port should remain in the group.

Example - Enabling IPv6 on Windows 7

Windows 7 supports IPv6 by default. DHCPv6 is also enabled when you enable IPv6 on a Windows 7 computer.

To enable IPv6 in Windows 7:

- 1 Select **Control Panel > Network and Sharing Center > Local Area Connection**.
- 2 Select the **Internet Protocol Version 6 (TCP/IPv6)** checkbox to enable it.
- 3 Click **OK** to save the change.

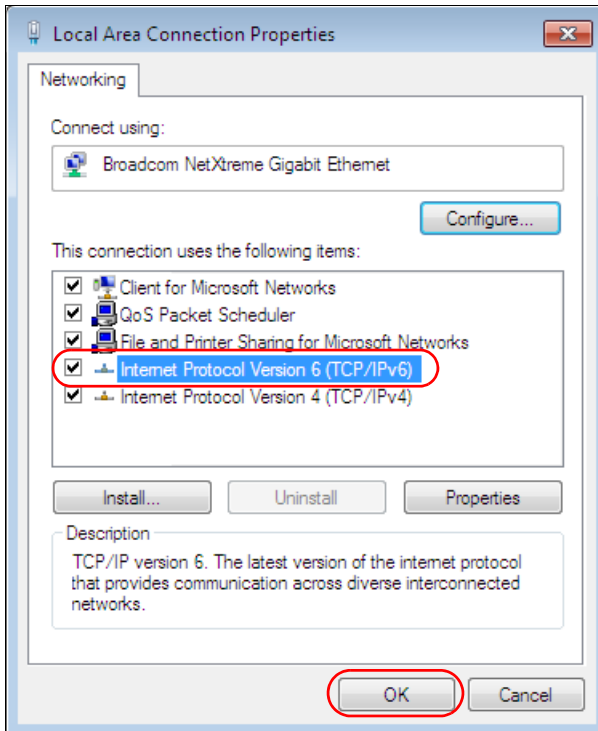

- 4 Click **Close** to exit the **Local Area Connection Status** screen.
- 5 Select **Start > All Programs > Accessories > Command Prompt**.
- 6 Use the `ipconfig` command to check your dynamic IPv6 address. This example shows a global address (2001:b021:2d::1000) obtained from a DHCP server.

```
C:\>ipconfig

Windows IP Configuration

Ethernet adapter Local Area Connection:

    Connection-specific DNS Suffix . . :
    IPv6 Address. . . . . : 2001:b021:2d::1000
    Link-local IPv6 Address . . . . . : fe80::25d8:dcab:c80a:5189%11
    IPv4 Address. . . . . : 172.16.100.61
    Subnet Mask . . . . . : 255.255.255.0
    Default Gateway . . . . . : fe80::213:49ff:feaa:7125%11
                                172.16.100.254
```

APPENDIX C

Legal Information

Copyright

Copyright © 2020 by Zyxel Communications Corporation.

The contents of this publication may not be reproduced in any part or as a whole, transcribed, stored in a retrieval system, translated into any language, or transmitted in any form or by any means, electronic, mechanical, magnetic, optical, chemical, photocopying, manual, or otherwise, without the prior written permission of Zyxel Communications Corporation.

Published by Zyxel Communications Corporation. All rights reserved.

Disclaimer

Zyxel does not assume any liability arising out of the application or use of any products, or software described herein. Neither does it convey any license under its patent rights nor the patent rights of others. Zyxel further reserves the right to make changes in any products described herein without notice. This publication is subject to change without notice.

Regulatory Notice and Statement

EUROPEAN UNION



The following information applies if you use the product within the European Union.

Declaration of Conformity with Regard to EU Directive 2014/53/EU (Radio Equipment Directive, RED)

- Compliance information for wireless products relevant to the EU and other Countries following the EU Directive 2014/53/EU (RED). And this product may be used in all EU countries (and other countries following the EU Directive 2014/53/EU) without any limitation except for the countries mentioned below table:
- In the majority of the EU and other European countries, the 5GHz bands have been made available for the use of wireless local area networks (LANs). Later in this document you will find an overview of countries in which additional restrictions or requirements or both are applicable. The requirements for any country may evolve. Zyxel recommends that you check with the local authorities for the latest status of their national regulations for the 5GHz wireless LANs.
- If this device for operation in the band 5150-5350 MHz, it is for indoor use only.
- This equipment should be installed and operated with a minimum distance of 20 cm between the radio equipment and your body.
- The maximum RF power operating for each band as follows:

(LTE7240-M403)

- WiFi
 - The band 2,400 to 2,483.5 MHz is 88.51 mW
- GSM
 - The GSM 900 is 1967.89 mW
 - The DCS 1800 is 968.28 mW
- WCDMA
 - The WCDMA Band I is 213.8 mW
 - The WCDMA Band VIII is 208.93 mW
- LTE
 - The LTE Band 1 is 204.17 mW
 - The LTE Band 3 is 199.53 mW
 - The LTE Band 7 is 190.55 mW
 - The LTE Band 8 is 208.93 mW
 - The LTE Band 20 is 223.87 mW
 - The LTE Band 38 is 147.91 mW
 - The LTE Band 40 is 141.25 mW

(LTE3301-PLUS)

- WiFi
 - The band 2,400 to 2,483.5 MHz is 81.28 mW
 - The band 5,150 to 5,350 MHz is 180.3 mW
 - The band 5,470 to 5,725 MHz is 612.35 mW
- WCDMA
 - The WCDMA Band I is 193.64 mW

- The WCDMA Band III is 228.56 mW
- The WCDMA Band VIII is 198.15 mW
- LTE
 - The LTE Band 1 is 223.87 mW
 - The LTE Band 3 is 239.88 mW
 - The LTE Band 7 is 218.78 mW
 - The LTE Band 8 is 186.21 mW
 - The LTE Band 20 is 186.21 mW
 - The LTE Band 28 is 206.06 mW
 - The LTE Band 38 is 247.17 mW
 - The LTE Band 40 is 231.21 mW
- (LTE7480-M804 & LTE7490-M904)
 - The band 2,400 to 2,483.5 MHz is 87.1 mW (LTE7480-M804)
 - The band 2,400 to 2,483.5 MHz is 87.1 mW (LTE7490-M904)
- WCDMA
 - The WCDMA Band I is 316.23 mW
 - The WCDMA Band III is 316.23 mW
 - The WCDMA Band VIII is 281.84 mW
- LTE
 - The LTE Band 1/3/7/8/20/28/38/40 is 281.84 mW
- (LTE3316-M604)
 - WCDMA
 - The WCDMA Band I is 193.64 mW
 - The WCDMA Band III is 228.56 mW
 - The WCDMA Band VIII is 198.15 mW
 - LTE
 - The LTE Band 1 is 223.87 mW
 - The LTE Band 3 is 251.19 mW
 - The LTE Band 7 is 218.78 mW
 - The LTE Band 8 is 186.21 mW
 - The LTE Band 20 is 186.21 mW
 - The LTE Band 28 is 206.06 mW
 - The LTE Band 38 is 247.17 mW
 - The LTE Band 40 is 231.21 mW
 - 802.11 Mode
 - 802.11b Band is 84.3 mW
 - 802.11g Band is 95.72 mW
 - 802.11n Band is 96.83 mW
 - 802.11ac Band is 195.88 mW
 - 802.11ac Band is 392.64 mW

Български (Bulgarian)	<p>С настоящото Zyxel декларира, че това оборудване е в съответствие със съществените изисквания и другите приложими разпоредбите на Директива 2014/53/ЕС.</p> <p>National Restrictions</p> <ul style="list-style-type: none"> • The Belgian Institute for Postal Services and Telecommunications (BIPT) must be notified of any outdoor wireless link having a range exceeding 300 meters. Please check http://www.bipt.be for more details. • Draadloze verbindingen voor buitengebruik en met een reikwijdte van meer dan 300 meter dienen aangemeld te worden bij het Belgisch Instituut voor postdiensten en telecommunicatie (BIPT). Zie http://www.bipt.be voor meer gegevens. • Les liaisons sans fil pour une utilisation en extérieur d'une distance supérieure à 300 mètres doivent être notifiées à l'Institut Belge des services Postaux et des Télécommunications (IBPT). Visitez http://www.ibpt.be pour de plus amples détails.
Español (Spanish)	<p>Por medio de la presente Zyxel declara que el equipo cumple con los requisitos esenciales y cualesquiera otras disposiciones aplicables o exigibles de la Directiva 2014/53/UE..</p>
Čeština (Czech)	<p>Zyxel tímto prohlašuje, že tento zařízený je ve shodě se základními požadavky a dalšími příslušnými ustanoveními směrnice 2014/53/EU.</p>
Dansk (Danish)	<p>Undertegnede Zyxel erklærer herved, at følgende udstyr overholder de væsentlige krav og øvrige relevante krav i direktiv 2014/53/EU.</p> <p>National Restrictions</p> <ul style="list-style-type: none"> • In Denmark, the band 5150 - 5350 MHz is also allowed for outdoor usage. • I Danmark må frekvensbåndet 5150 - 5350 også anvendes udendørs.
Deutsch (German)	<p>Hiermit erklärt Zyxel, dass sich das Gerät Ausstattung in Übereinstimmung mit den grundlegenden Anforderungen und den übrigen einschlägigen Bestimmungen der Richtlinie 2014/53/EU befindet.</p>
Eesti keel (Estonian)	<p>Käesolevaga kinnitab Zyxel seadme seadme vastavust direktiivi 2014/53/EL põhinõuetele ja nimetatud direktiivist tulenevatele teistele asjakohastele sätetele.</p>
Ελληνικά (Greek)	<p>ΜΕ ΤΗΝ ΠΑΡΟΥΣΑ Zyxel ΔΗΛΩΝΕΙ ΟΤΙ ΕΞΟΠΛΙΣΜΟΣ ΣΥΜΜΟΡΦΩΝΕΤΑΙ ΠΡΟΣ ΤΙΣ ΟΥΣΙΩΔΕΙΣ ΑΠΑΙΤΗΣΕΙΣ ΚΑΙ ΤΙΣ ΛΟΙΠΕΣ ΣΧΕΤΙΚΕΣ ΔΙΑΤΑΞΕΙΣ ΤΗΣ ΟΔΗΓΙΑΣ 2014/53/ΕΕ.</p>

English	Hereby, Zyxel declares that this device is in compliance with the essential requirements and other relevant provisions of Directive 2014/53/EU.
Français (French)	Par la présente Zyxel déclare que l'appareil équipements est conforme aux exigences essentielles et aux autres dispositions pertinentes de la directive 2014/53/UE.
Hrvatski (Croatian)	Zyxel ovime izjavljuje da je radijska oprema tipa u skladu s Direktivom 2014/53/UE.
Íslenska (Icelandic)	Hér með lýsir, Zyxel því yfir að þessi búnaður er í samræmi við grunnkröfur og önnur viðeigandi ákvæði tilskipunar 2014/53/UE.
Italiano (Italian)	Con la presente Zyxel dichiara che questo attrezzatura è conforme ai requisiti essenziali ed alle altre disposizioni pertinenti stabilite dalla direttiva 2014/53/UE. National Restrictions <ul style="list-style-type: none"> This product meets the National Radio Interface and the requirements specified in the National Frequency Allocation Table for Italy. Unless this wireless LAN product is operating within the boundaries of the owner's property, its use requires a "general authorization." Please check http://www.sviluppoeconomico.gov.it/ for more details. Questo prodotto è conforme alla specifiche di Interfaccia Radio Nazionali e rispetta il Piano Nazionale di ripartizione delle frequenze in Italia. Se non viene installato all'interno del proprio fondo, l'utilizzo di prodotti Wireless LAN richiede una "Autorizzazione Generale". Consultare http://www.sviluppoeconomico.gov.it/ per maggiori dettagli.
Latviešu valoda (Latvian)	Ar šo Zyxel deklarē, ka iekārtas atbilst Direktīvas 2014/53/ES būtiskajām prasībām un citiem ar to saistītajiem noteikumiem. National Restrictions <ul style="list-style-type: none"> The outdoor usage of the 2.4 GHz band requires an authorization from the Electronic Communications Office. Please check http://www.esd.lv for more details. 2.4 GHz frekvenču joslas izmantošanai ārpus telpām nepieciešama atļauja no Elektronisko sakaru direkcijas. Vairāk informācijas: http://www.esd.lv.
Lietuvių kalba (Lithuanian)	Šiuo Zyxel deklaruoja, kad šis įranga atitinka esminius reikalavimus ir kitas 2014/53/ES Direktyvos nuostatas.
Magyar (Hungarian)	Alulírott, Zyxel nyilatkozom, hogy a berendezés megfelel a vonatkozó alapvető követelményeknek és az 2014/53/EU irányelv egyéb előírásainak.
Malti (Maltese)	Hawnhekk, Zyxel, jiddikjara li dan tagħmir jikkonforma mal-htigijiet essenzjali u ma provvedimenti oħrajn rilevanti li hemm fid-Direttiva 2014/53/UE.
Nederlands (Dutch)	Hierbij verklaart Zyxel dat het toestel uitrusting in overeenstemming is met de essentiële eisen en de andere relevante bepalingen van richtlijn 2014/53/EU.
Polski (Polish)	Niniejszym Zyxel oświadcza, że sprzęt jest zgodny z zasadniczymi wymogami oraz pozostałymi stosownymi postanowieniami Dyrektywy 2014/53/UE.
Português (Portuguese)	Zyxel declara que este equipamento está conforme com os requisitos essenciais e outras disposições da Directiva 2014/53/UE.
Română (Romanian)	Prin prezenta, Zyxel declară că acest echipament este în conformitate cu cerințele esențiale și alte prevederi relevante ale Directivei 2014/53/UE.
Slovenčina (Slovak)	Zyxel týmto vyhlasuje, že zariadenia spĺňa základné požiadavky a všetky príslušné ustanovenia Smernice 2014/53/EÚ.
Slovenščina (Slovene)	Zyxel izjavlja, da je ta oprema v skladu z bistvenimi zahtevami in ostalimi relevantnimi določili direktive 2014/53/EU.
Suomi (Finnish)	Zyxel vakuuttaa täten että laitteet tyyppinen laite on direktiivin 2014/53/EU oleellisten vaatimusten ja sitä koskevien direktiivin muiden ehtojen mukainen.
Svenska (Swedish)	Härmed intygar Zyxel att denna utrustning står i överensstämmelse med de väsentliga egenskapskrav och övriga relevanta bestämmelser som framgår av direktiv 2014/53/EU.
Norsk (Norwegian)	Erklærer herved Zyxel at dette utstyret er i samsvar med de grunnleggende kravene og andre relevante bestemmelser i direktiv 2014/53/EU.

Notes:

- Although Norway, Switzerland and Liechtenstein are not EU member states, the EU Directive 2014/53/EU has also been implemented in those countries.
- The regulatory limits for maximum output power are specified in EIRP. The EIRP level (in dBm) of a device can be calculated by adding the gain of the antenna used (specified in dBi) to the output power available at the connector (specified in dBm).

List of national codes

COUNTRY	ISO 3166 2 LETTER CODE	COUNTRY	ISO 3166 2 LETTER CODE
Austria	AT	Liechtenstein	LI
Belgium	BE	Lithuania	LT
Bulgaria	BG	Luxembourg	LU
Croatia	HR	Malta	MT
Cyprus	CY	Netherlands	NL
Czech Republic	CZ	Norway	NO
Denmark	DK	Poland	PL
Estonia	EE	Portugal	PT
Finland	FI	Romania	RO
France	FR	Serbia	RS
Germany	DE	Slovakia	SK
Greece	GR	Slovenia	SI
Hungary	HU	Spain	ES
Iceland	IS	Switzerland	CH
Ireland	IE	Sweden	SE
Italy	IT	Turkey	TR
Latvia	LV	United Kingdom	GB

United States of America (LTE7461-M602 and LTE7480-S905)



The following information applies if you use the product within USA area.

FCC EMC Statement

- This device complies with part 15 of the FCC Rules. Operation is subject to the following two conditions:
 - (1) This device may not cause harmful interference, and
 - (2) This device must accept any interference received, including interference that may cause undesired operation.
 - Changes or modifications not expressly approved by the party responsible for compliance could void the user's authority to operate the equipment.
 - This product has been tested and complies with the specifications for a Class B digital device, pursuant to part 15 of the FCC Rules. These limits are designed to provide reasonable protection against harmful interference in a residential installation. This equipment generates, uses, and can radiate radio frequency energy and, if not installed and used according to the instructions, may cause harmful interference to radio communications. However, there is no guarantee that interference will not occur in a particular installation.
 - If this device does cause harmful interference to radio or television reception, which is found by turning the equipment off and on, the user is encouraged to try to correct the interference by one or more of the following measures:
 - Reorient or relocate the receiving antenna.
 - Increase the separation between the equipment or devices
 - Connect the equipment to an outlet other than the receiver's
 - Consult a dealer or an experienced radio/TV technician for assistance
- The following information applies if you use the product with RF function within USA area.

FCC Radiation exposure statement

- This equipment complies with FCC RF radiation exposure limits set forth for an uncontrolled environment.
- **(LTE7461-M602)**
This transmitter must be at least 30 cm from the user and must not be co-located or operating in conjunction with any other antenna or transmitter.
- **(LTE7480-S905)**
This transmitter must be at least 20 cm from the user and must not be co-located or operating in conjunction with any other antenna or transmitter.

CANADA (LTE7461-M602)

The following information applies if you use the product within Canada area.

Innovation, Science and Economic Development Canada ICES Statement

CAN ICES-3 (B)/NMB-3(B)

Innovation, Science and Economic Development Canada RSS-GEN & RSS-247 Statement

- This device contains licence-exempt transmitter(s)/receiver(s) that comply with Innovation, Science and Economic Development Canada's licence-exempt RSS(s). Operation is subject to the following two conditions: (1) this device may not cause interference, and (2) this device must accept any interference, including interference that may cause undesired operation of the device.
- This radio transmitter (2468C-LTE7461M602) has been approved by Innovation, Science and Economic Development Canada to operate with the antenna types listed below with the maximum permissible gain indicated. Antenna types not included in this list that have a gain greater than the maximum gain indicated for any type listed, are strictly prohibited for use with this device.

Antenna Information

Chain No.	Antenna Type	Frequency Range	WiFi Gain (dBi)	LTE Gain (dBi)	Connector
WLAN-ANT0	PIFA	2.4 ~ 2.4835 GHz	6	N.A.	iPEX
WLAN-ANTI	PIFA	2.4 ~ 2.4835 GHz	5	N.A.	iPEX
WWAN	Dipole	2500 ~ 2570 MHz	N.A.	9	iPEX
		698 ~ 716 MHz	N.A.	3.5	iPEX
		777 ~ 787 MHz	N.A.	3	iPEX
		1850 ~ 1915 MHz	N.A.	8	iPEX
		814 ~ 849 MHz	N.A.	3.6	iPEX
		2305 ~ 2315 MHz	N.A.	9	iPEX
		1710 ~ 1780 MHz	N.A.	6	iPEX

If the product with 5G wireless function operating in 5150-5250 MHz and 5725-5850 MHz, the following attention must be paid,

- The device for operation in the band 5150-5250 MHz is only for indoor use to reduce the potential for harmful interference to co-channel mobile satellite systems.
- For devices with detachable antenna(s), the maximum antenna gain permitted for devices in the band 5725-5850 MHz shall be such that the equipment still complies with the e.i.r.p. limits as appropriate; and
- Where applicable, antenna type(s), antenna models(s), and the worst-case tilt angle(s) necessary to remain compliant with the e.i.r.p. elevation mask requirement set forth in Section 6.2.2.3 of RSS 247 shall be clearly indicated.

If the product with 5G wireless function operating in 5250-5350 MHz and 5470-5725 MHz, the following attention must be paid.

- For devices with detachable antenna(s), the maximum antenna gain permitted for devices in the bands 5250-5350 MHz and 5470-5725 MHz shall be such that the equipment still complies with the e.i.r.p. limit.
- L'émetteur/récepteur exempt de licence contenu dans le présent appareil est conforme aux CNR d'Innovation, Sciences et Développement économique Canada applicables aux appareils radio exempts de licence. L'exploitation est autorisée aux deux conditions suivantes : (1) l'appareil ne doit pas produire de brouillage; (2) l'appareil doit accepter tout brouillage radioélectrique subi, même si le brouillage est susceptible d'en compromettre le fonctionnement.
- Le présent émetteur radio (2468C-LTE7461M602) a été approuvé par Innovation, Sciences et Développement économique Canada pour fonctionner avec les types d'antenne énumérés ci-dessous et ayant un gain admissible maximal. Les types d'antenne non inclus dans cette liste, et dont le gain est supérieur au gain maximal indiqué pour tout type figurant sur la liste, sont strictement interdits pour l'exploitation de l'émetteur.

informations antenne

Chaîne NB.	Antenne Type	Gamme de fréquences	WiFi Gain (dBi)	LTE Gain (dBi)	Connecteur
WLAN-ANT0	PIFA	2.4 ~ 2.4835 GHz	6	N.A.	iPEX
WLAN-ANTI	PIFA	2.4 ~ 2.4835 GHz	5	N.A.	iPEX
WWAN	Dipole	2500 ~ 2570 MHz	N.A.	9	iPEX
		698 ~ 716 MHz	N.A.	3.5	iPEX
		777 ~ 787 MHz	N.A.	3	iPEX
		1850 ~ 1915 MHz	N.A.	8	iPEX
		814 ~ 849 MHz	N.A.	3.6	iPEX
		2305 ~ 2315 MHz	N.A.	9	iPEX
		1710 ~ 1780 MHz	N.A.	6	iPEX

Lorsque la fonction sans fil 5G fonctionnant en 5150-5250 MHz and 5725-5850 MHz est activée pour ce produit, il est nécessaire de porter une attention particulière aux choses suivantes

- Les dispositifs fonctionnant dans la bande de 5 150 à 5 250 MHz sont réservés uniquement pour une utilisation à l'intérieur afin de réduire les risques de brouillage préjudiciable aux systèmes de satellites mobiles utilisant les mêmes canaux;
- Pour les dispositifs munis d'antennes amovibles, le gain maximal d'antenne permis (pour les dispositifs utilisant la bande de 5 725 à 5 850 MHz) doit être conforme à la limite de la p.i.r.e. spécifiée, selon le cas;
- Lorsqu'il y a lieu, les types d'antennes (s'il y en a plusieurs), les numéros de modèle de l'antenne et les pires angles d'inclinaison nécessaires pour rester conforme à l'exigence de la p.i.r.e. applicable au masque d'élévation, énoncée à la section 6.2.2.3 du CNR-247, doivent être clairement indiqués.

Lorsque la fonction sans fil 5G fonctionnant en 5250-5350 MHz et 5470-5725 MHz est activée pour ce produit, il est nécessaire de porter une attention particulière aux choses suivantes.

- Pour les dispositifs munis d'antennes amovibles, le gain maximal d'antenne permis pour les dispositifs utilisant les bandes de 5 250 à 5 350 MHz et de 5 470 à 5 725 MHz doit être conforme à la limite de la p.i.r.e.

Industry Canada radiation exposure statement

This equipment complies with ISED radiation exposure limits set forth for an uncontrolled environment. This equipment should be installed and operated with a minimum distance of 30 cm between the radiator and your body.

Déclaration d'exposition aux radiations:

Cet équipement est conforme aux limites d'exposition aux rayonnements ISED établies pour un environnement non contrôlé. Cet équipement doit être installé et utilisé avec un minimum de 30 cm de distance entre la source de rayonnement et votre corps.

Safety Warnings (All LTE Models)

- Do not use this product near water, for example, in a wet basement or near a swimming pool.
- Do not expose your Zyxel Device to dampness, dust or corrosive liquids.
- Do not store things on the device.
- Do not obstruct the Zyxel Device ventilation slots as insufficient airflow may harm your Zyxel Device. For example, do not place the Zyxel Device in an enclosed space such as a box or on a very soft surface such as a bed or sofa.
- Do not install, use, or service this Zyxel Device during a thunderstorm. There is a remote risk of electric shock from lightning.
- Connect ONLY suitable accessories to the Zyxel Device.
- Do not open the Zyxel Device or unit. Opening or removing covers can expose you to dangerous high voltage points or other risks.
- Only qualified service personnel should service or disassemble this Zyxel Device. Please contact your vendor for further information.
- Make sure to connect the cables to the correct ports.
- Place connecting cables carefully so that no one will step on them or stumble over them.
- Always disconnect all cables from this Zyxel Device before servicing or disassembling.
- Do not remove the plug and connect it to a power outlet by itself; always attach the plug to the power adapter first before connecting it to a power outlet.
- Do not allow anything to rest on the power adapter or cord and do NOT place the product where anyone can walk on the power adapter or cord.
- Please use the provided or designated connection cables/power cables/adapters. Connect it to the right supply voltage (for example, 110V AC in North America or 230V AC in Europe). If the power adapter or cord is damaged, it might cause electrocution. Remove it from the Zyxel Device and the power source, repairing the power adapter or cord is prohibited. Contact your local vendor to order a new one.
- The following warning statements apply, where the disconnect device is not incorporated in the Zyxel Device or where the plug on the power supply cord is intended to serve as the disconnect device.
 - For permanently connected Zyxel Device, a readily accessible disconnect device shall be incorporated external to the Zyxel Device;
 - For pluggable devices, the socket-outlet shall be installed near the Zyxel Device and shall be easily accessible.

Environment Statement

ErP (LTE3301-PLUS / LTE5388-M804 / LTE5398-M904 / LTE3316-M604)

Zyxel products put on the EU market in compliance with the requirement of the European Parliament and the Council published Directive 2009/125/EC establishing a framework for the setting of ecodesign requirements for energy-related products (recast), so called as "ErP Directive (Energy-related Products directive) as well as ecodesign requirement laid down in applicable implementing measures, power consumption has satisfied regulation requirements which are:

- Network standby power consumption < 8W, and/or
- Off mode power consumption < 0.5W, and/or
- Standby mode power consumption < 0.5W.

(Wireless settings, please refer to the chapter about wireless settings for more detail.)

European Union - Disposal and Recycling Information

The symbol below means that according to local regulations your product and/or its battery shall be disposed of separately from domestic waste. If this product is end of life, take it to a recycling station designated by local authorities. At the time of disposal, the separate collection of your product and/or its battery will help save natural resources and ensure that the environment is sustainable development.

Die folgende Symbol bedeutet, dass Ihr Produkt und/oder seine Batterie gemäß den örtlichen Bestimmungen getrennt vom Hausmüll entsorgt werden muss. Wenden Sie sich an eine Recyclingstation, wenn dieses Produkt das Ende seiner Lebensdauer erreicht hat. Zum Zeitpunkt der Entsorgung wird die getrennte Sammlung von Produkt und/oder seiner Batterie dazu beitragen, natürliche Ressourcen zu sparen und die Umwelt und die menschliche Gesundheit zu schützen.

El símbolo de abajo indica que según las regulaciones locales, su producto y/o su batería deberán depositarse como basura separada de la doméstica. Cuando este producto alcance el final de su vida útil, llévelo a un punto limpio. Cuando llegue el momento de desechar el producto, la recogida por separado éste y/o su batería ayudará a salvar los recursos naturales y a proteger la salud humana y medioambiental.

Le symbole ci-dessous signifie que selon les réglementations locales votre produit et/ou sa batterie doivent être éliminés séparément des ordures ménagères. Lorsque ce produit atteint sa fin de vie, amenez-le à un centre de recyclage. Au moment de la mise au rebut, la collecte séparée de votre produit et/ou de sa batterie aidera à économiser les ressources naturelles et protéger l'environnement et la santé humaine.

Il simbolo sotto significa che secondo i regolamenti locali il vostro prodotto e/o batteria deve essere smaltito separatamente dai rifiuti domestici. Quando questo prodotto raggiunge la fine della vita di servizio portarlo a una stazione di riciclaggio. Al momento dello smaltimento, la raccolta separata del vostro prodotto e/o della sua batteria aiuta a risparmiare risorse naturali e a proteggere l'ambiente e la salute umana.

Symbolen innebär att enligt lokal lagstiftning ska produkten och/eller dess batteri kastas separat från hushållsavfallet. När den här produkten når slutet av sin livslängd ska du ta den till en återvinningsstation. Vid tiden för kasseringen bidrar du till en bättre miljö och mänsklig hälsa genom att göra dig av med den på ett återvinningsställe.



台灣



以下訊息僅適用於產品具有無線功能且銷售至台灣地區

- 第十二條 經型式認證合格之低功率射頻電機，非經許可，公司，商號或使用者均不得擅自變更頻率、加大功率或變更原設計之特性及功能。
- 第十四條 低功率射頻電機之使用不得影響飛航安全及干擾合法通信；經發現有干擾現象時，應立即停用，並改善至無干擾時方得繼續使用。前項合法通信，指依電信法規定作業之無線電通信。低功率射頻電機須忍受合法通信或工業、科學及醫療用電波輻射性電機設備之干擾。
- 無線資訊傳輸設備忍受合法通信之干擾且不得干擾合法通信；如造成干擾，應立即停用，俟無干擾之虞，始得繼續使用。
- 無線資訊傳輸設備的製造廠商應確保頻率穩定性，如依製造廠商使用手冊上所述正常操作，發射的信號應維持於操作頻帶中
- 使用無線產品時，應避免影響附近雷達系統之操作。
- 高增益指向性天線只得應用於固定式點對點系統。

以下訊息僅適用於產品屬於專業安裝並銷售至台灣地區

- 本器材須經專業工程人員安裝及設定，始得設置使用，且不得直接販售給一般消費者。





安全警告 - 為了您的安全，請先閱讀以下警告及指示：

- 請勿將此產品接近水、火焰或放置在高溫的環境。
- 避免設備接觸：
 - 任何液體 - 切勿讓設備接觸水、雨水、高濕度、污水腐蝕性的液體或其他水份。
 - 灰塵及污物 - 切勿接觸灰塵、污物、沙土、食物或其他不合適的材料。
- 雷雨天氣時，不要安裝，使用或維修此設備。有遭受電擊的風險。
- 切勿重摔或撞擊設備，並勿使用不正確的電源變壓器。
- 若接上不正確的電源變壓器會有爆炸的風險。
- 請勿隨意更換產品內的電池。
- 如果更換不正確之電池型式，會有爆炸的風險，請依製造商說明書處理使用過之電池。
- 請將廢電池丟棄在適當的電器或電子設備回收處。
- 請勿將設備解體。
- 請勿阻礙設備的散熱孔，空氣對流不足將會造成設備損害。
- 請插在正確的電壓供給插座（如：北美 / 台灣電壓 110V AC，歐洲是 230V AC）。
- 假若電源變壓器或電源變壓器的纜線損壞，請從插座拔除，若您還繼續插電使用，會有觸電死亡的風險。
- 請勿試圖修理電源變壓器或電源變壓器的纜線，若有毀損，請直接聯絡您購買的店家，購買一個新的電源變壓器。
- 請勿將此設備安裝於室外，此設備僅適合放置於室內。
- 請勿隨一般垃圾丟棄。
- 請參閱產品背貼上的設備額定功率。
- 請參考產品型錄或是彩盒上的作業溫度。
- 產品沒有斷電裝置或者採用電源線的插頭視為斷電裝置的一部分，以下警語將適用：
 - 對永久連接之設備，在設備外部須安裝可觸及之斷電裝置；
 - 對插接式之設備，插座必須接近安裝之地點而且是易於觸及的。

About the Symbols

Various symbols are used in this product to ensure correct usage, to prevent danger to the user and others, and to prevent property damage. The meaning of these symbols are described below. It is important that you read these descriptions thoroughly and fully understand the contents.

Explanation of the Symbols

SYMBOL	EXPLANATION
	Alternating current (AC): AC is an electric current in which the flow of electric charge periodically reverses direction.
	Direct current (DC): DC is the unidirectional flow or movement of electric charge carriers.
	Earth; ground: A wiring terminal intended for connection of a Protective Earthing Conductor.
	Class II equipment: The method of protection against electric shock in the case of class II equipment is either double insulation or reinforced insulation.

Viewing Certifications

Go to <http://www.zyxel.com> to view this product's documentation and certifications.

Zyxel Limited Warranty

Zyxel warrants to the original end user (purchaser) that this product is free from any defects in material or workmanship for a specific period (the Warranty Period) from the date of purchase. The Warranty Period varies by region. Check with your vendor and/or the authorized Zyxel local distributor for details about the Warranty Period of this product. During the warranty period, and upon proof of purchase, should the product have indications of failure due to faulty workmanship and/or materials, Zyxel will, at its discretion, repair or replace the defective products or components without charge for either parts or labor, and to whatever extent it shall deem necessary to restore the product or components to proper operating condition. Any replacement will consist of a new or re-manufactured functionally equivalent product of equal or higher value, and will be solely at the discretion of Zyxel. This warranty shall not apply if the product has been modified, misused, tampered with, damaged by an act of God, or subjected to abnormal working conditions.

Note

Repair or replacement, as provided under this warranty, is the exclusive remedy of the purchaser. This warranty is in lieu of all other warranties, express or implied, including any implied warranty of merchantability or fitness for a particular use or purpose. Zyxel shall in no event be held liable for indirect or consequential damages of any kind to the purchaser.

To obtain the services of this warranty, contact your vendor. You may also refer to the warranty policy for the region in which you bought the Zyxel Device at http://www.zyxel.com/web/support_warranty_info.php.

Registration

Register your product online at www.zyxel.com to receive e-mail notices of firmware upgrades and related information.

Open Source Licenses

This product may contain in part some free software distributed under GPL license terms and/or GPL like licenses. Open source licenses are provided with the firmware package. You can download the latest firmware at www.zyxel.com. If you cannot find it there, contact your vendor or Zyxel Technical Support at support@zyxel.com.tw.

To obtain the source code covered under those Licenses, please contact your vendor or Zyxel Technical Support at support@zyxel.com.

A

access
 troubleshooting [272](#)

Access Control (Rules) screen [188](#)

ACS [253](#)

activation
 firewalls [185](#)

Add New ACL Rule screen [189](#)

Address Resolution Protocol [229](#)

Any_WAN
 Remote Management [249](#)
 TR-069 traffic [254](#)

APN information
 obtain [91](#)

APN Settings [92](#)

Application Layer Gateway (ALG) [170](#)

applications
 Internet access [18](#)
 wireless WAN [18](#)

ARP Table [229](#), [231](#), [234](#)

ARP Table screen [230](#)

authentication [120](#), [121](#)
 RADIUS server [121](#)

Authentication Type
 APN [92](#)

Auto Configuration Server, see ACS [253](#)

B

backup
 configuration [267](#)

backup configuration [267](#)

Backup/Restore screen [266](#)

Band Configuration Screen [93](#)

Basic Service Set, see BSS

blinking LEDs [24](#)

Broadband [83](#)

BSS [122](#)

example [123](#)

C

CA [207](#)

Cellular Band screen [93](#)

Cellular SIM screen [92](#)

Cellular WAN [249](#)
 TR-069 traffic [254](#)

Cellular WAN Screen [91](#)

Cellular WAN screen [89](#), [91](#)

certificate
 details [209](#)
 factory default [202](#)
 file format [208](#)
 file path [206](#)
 import [202](#), [205](#)
 public and private keys [208](#)
 verification [208](#)

certificate request
 create [202](#)
 view [203](#)

certificates [201](#)
 advantages [208](#)
 authentication [201](#)
 CA [207](#)
 creating [202](#)
 public key [201](#)
 replacing [202](#)
 storage space [202](#)
 thumbprint algorithms [209](#)
 thumbprints [209](#)
 trusted CAs [206](#)
 verifying fingerprints [208](#)

Certification Authority, see CA

certifications [295](#)
 viewing [299](#)

channel, wireless LAN [119](#)

client list [136](#)

configuration

- backup [267](#)
- firewalls [185](#)
- restoring [267](#)
- static route [176](#)
- contact information [279](#)
- copyright [292](#)
- Create Certificate Request screen [202](#)
- creating certificates [202](#)
- CTS threshold [114](#), [120](#)
- customer support [279](#)
- customized service
 - add [187](#)
- customized services [187](#), [188](#)

D

- data fragment threshold [114](#), [120](#)
- Data Roaming
 - enable [91](#)
- Denials of Service, see DoS
- DHCP [132](#)
- DHCP Server Lease Time [134](#)
- DHCP Server State [134](#)
- diagnostic [269](#)
- diagnostic screens [269](#)
- digital IDs [201](#)
- disclaimer [292](#)
- DMZ screen [170](#)
- DNS [132](#)
- DNS Values [134](#)
- domain name system, see DNS
- DoS [184](#)
 - thresholds [185](#)
- DoS protection blocking
 - enable [192](#)
- dynamic DNS [175](#)
 - wildcard [175](#)
- Dynamic Host Configuration Protocol, see DHCP
- DYNDNS wildcard [175](#)

E

- e-mail
 - log setting [263](#)
- Extended Service Set IDentification [102](#), [107](#)

F

- factory-default
 - RESET button [31](#)
- filters
 - MAC address [108](#), [121](#)
- firewall
 - enhancing security [193](#)
 - security considerations [193](#)
 - traffic rule direction [191](#)
- Firewall DoS screen [191](#)
- Firewall General screen [186](#)
- firewall rules
 - direction of travel [192](#)
- firewalls [184](#), [185](#)
 - actions [191](#)
 - configuration [185](#)
 - customized services [187](#), [188](#)
 - DoS [184](#)
 - thresholds [185](#)
 - ICMP [184](#)
 - rules [192](#)
 - security [193](#)
- firmware [264](#)
 - version [73](#)
- Firmware Upgrade screen [264](#)
- firmware upload [264](#)
- firmware version
 - check [265](#)
- fragmentation threshold [114](#), [120](#)
- FTP [163](#)
 - unusable [273](#)

G

- General wireless LAN screen [100](#)

H

hardware connections
troubleshooting [271](#)

I

IANA [140](#)
 ICMP [184](#)
 Import Certificate screen [206](#)
 importing trusted CAs [206](#)
 Internet
 no access [273](#)
 wizard setup [44](#)
 Internet access [18](#)
 wizard setup [44](#)
 Internet Assigned Numbers Authority
 See IANA
 Internet Blocking [71](#)
 Internet connection
 slow or erratic [274](#)
 Internet Control Message Protocol, see ICMP
 Internet Protocol version 6, see IPv6
 IP address
 WAN [84](#)
 IP address access control [251](#)
 IP Passthrough mode [98](#)
 IP Passthrough screen [39, 97](#)
 IPv4 firewall [186](#)
 IPv6 [285](#)
 addressing [285](#)
 EUI-64 [287](#)
 global address [285](#)
 interface ID [287](#)
 link-local address [285](#)
 Neighbor Discovery Protocol [285](#)
 ping [285](#)
 prefix [285](#)
 prefix length [285](#)
 unspecified address [286](#)
 IPv6 firewall [186](#)

L

LAN [131](#)
 client list [136](#)
 MAC address [116, 137](#)
 status [74, 81](#)
 LAN IP address [134](#)
 LAN IPv6 Mode Setup [134](#)
 LAN Setup screen [132](#)
 LAN subnet mask [134](#)
 limitations
 wireless LAN [122](#)
 WPS [129](#)
 listening port [217](#)
 Local Area Network, see LAN
 local certificate
 TR-069 client [254](#)
 Local Certificates screen [201](#)
 Log Setting screen [261](#)
 login [35](#)
 passwords [35](#)
 troubleshooting [272](#)
 Login screen
 no access [272](#)
 logs [223, 226, 239, 261](#)

M

MAC Address
 LAN [137](#)
 MAC address [110, 116, 137](#)
 filter [108, 121](#)
 MAC authentication [108](#)
 MAC Authentication screen [104, 109](#)
 Mac filter [195](#)
 managing the device
 good habits [20](#)
 using FTP. See FTP.
 MGMT Services screen [248, 249](#)
 MSN Messenger
 problem [275](#)
 Multi_WAN
 Remote Management [249](#)
 TR-069 traffic [254](#)

N

- NAT
 - default server [170](#)
 - DMZ host [170](#)
 - multiple server example [163](#)
- NAT ALG screen [170, 171, 173](#)
- Network Address Translation, see NAT
- network disconnect
 - temporary [265](#)
- Network Map [71](#)
- network map [39](#)
- network type
 - select [94](#)
- Nslookup test [270](#)

O

- Others screen [113](#)

P

- password
 - admin [272](#)
 - good habit [20](#)
 - lost [272](#)
 - user [272](#)
- passwords [35](#)
- PBC [124](#)
- PIN Protection [93](#)
- PIN, WPS [124](#)
 - example [126](#)
- Ping
 - unusable [273](#)
- Ping test [270](#)
- Ping/TraceRoute/Nslookup screen [269](#)
- PLMN Configuration Screen [94](#)
- PoE injector [18, 271](#)
- port forwarding rule
 - add/edit [164](#)
- Port Forwarding screen [164](#)
- Port Triggering
 - add new rule [168](#)

- Port Triggering screen [166](#)
- ports [24](#)
- power
 - troubleshooting [271](#)
- preamble [115, 120](#)
- preamble mode [123](#)
- problem
 - troubleshooting [271](#)
- Protocol (Customized Services) screen [187](#)
- Protocol Entry
 - add [187](#)
- Push Button Configuration, see PBC
- push button, WPS [124](#)

R

- RADIUS server [121](#)
- Reboot screen [267](#)
- remote management
 - TR-069 [253](#)
- Remote Procedure Calls, see RPCs [253](#)
- RESET Button [31](#)
- restart system [267](#)
- restore default settings
 - after firmware upgrade [265](#)
- restoring configuration [267](#)
- RFC 1058. See RIP.
- RFC 1389. See RIP.
- RFC 1631 [162](#)
- RFC 3164 [223](#)
- RIP [161](#)
- router features [18](#)
- Routing Information Protocol. See RIP
- Routing Table screen [232, 234](#)
- RPPCs [253](#)
- RTS threshold [114, 120](#)

S

- security
 - network [193](#)
 - wireless LAN [120](#)

Security Log [224](#)
 service access control [249, 251](#)
 Service Set [102, 107](#)
 setup
 firewalls [185](#)
 static route [176](#)
 SIM card
 status [75, 240](#)
 SIM configuration [92](#)
 SSH
 unusable [273](#)
 SSID [121](#)
 Static DHCP [136](#)
 Configuration [137](#)
 Static DHCP screen [136](#)
 static route [154, 161](#)
 configuration [176](#)
 status [71](#)
 firmware version [73](#)
 LAN [74, 81](#)
 WAN [73](#)
 wireless LAN [74](#)
 status indicators [24](#)
 syslog
 protocol [223](#)
 severity levels [223](#)
 syslog logging
 enable [262](#)
 syslog server
 name or IP address [263](#)
 system
 firmware [264](#)
 version [73](#)
 passwords [35](#)
 status [71](#)
 LAN [74, 81](#)
 WAN [73](#)
 wireless LAN [74](#)
 time [255](#)

T

Telnet
 unusable [273](#)
 The [84](#)

thresholds
 data fragment [114, 120](#)
 DoS [185](#)
 RTS/CTS [114, 120](#)
 time [255](#)
 TR-069 [253](#)
 authentication [254](#)
 TR-069 Client screen [253](#)
 Trace Route test [270](#)
 troubleshooting [271](#)
 Trust Domain
 add [251](#)
 Trust Domain screen [250](#)
 Trusted CA certificate
 view [206](#)
 Trusted CA screen [205](#)
 Turning on UPnP
 Windows 7 example [140](#)

U

Universal Plug and Play, see UPnP
 upgrading firmware [264](#)
 UPnP [138](#)
 forum [132](#)
 security issues [132](#)
 State [138](#)
 undetectable [275](#)
 usage confirmation [132](#)
 UPnP screen [138](#)
 UPnP-enabled Network Device
 auto-discover [141, 146](#)

W

WAN
 status [73](#)
 Wide Area Network, see WAN [83](#)
 warranty [299](#)
 note [299](#)
 Web Configurator
 easy access [149](#)
 web configurator

- login [35](#)
- passwords [35](#)
- WEP Encryption [103](#)
- Wireless General screen [100](#)
- wireless LAN [99](#)
 - authentication [120, 121](#)
 - BSS [122](#)
 - example [123](#)
 - channel [119](#)
 - example [119](#)
 - fragmentation threshold [114, 120](#)
 - limitations [122](#)
 - MAC address filter [108, 121](#)
 - preamble [115, 120](#)
 - RADIUS server [121](#)
 - RTS/CTS threshold [114, 120](#)
 - security [120](#)
 - SSID [121](#)
 - status [74](#)
 - WPS [123, 126](#)
 - example [127](#)
 - limitations [129](#)
 - PIN [124](#)
 - push button [124](#)
- Wireless tutorial [48](#)
- wizard setup
 - Internet [44](#)
- WMM screen [112](#)
- WPS [123, 126](#)
 - example [127](#)
 - limitations [129](#)
 - PIN [124](#)
 - example [126](#)
 - push button [124](#)
- WPS screen [110](#)