

# CDE30 Series

## Commercial Display

### Quick Start Guide

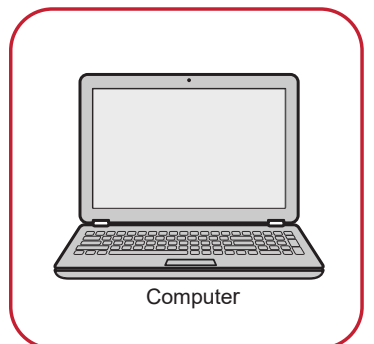

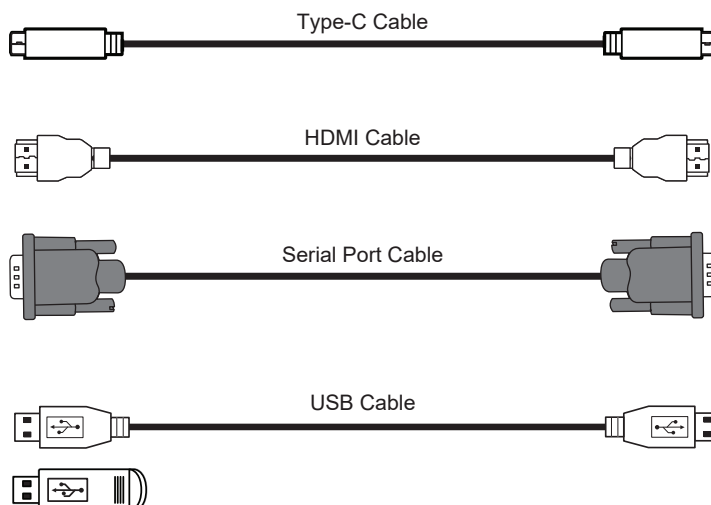
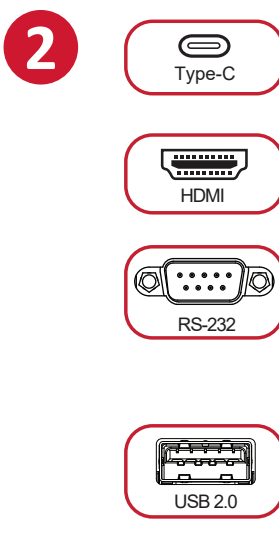
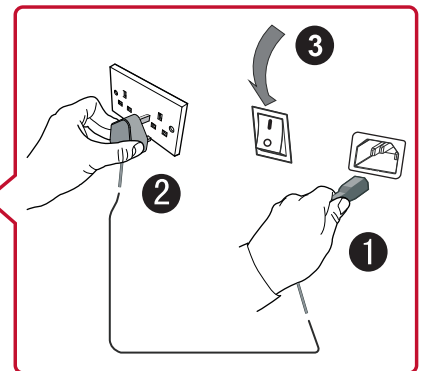
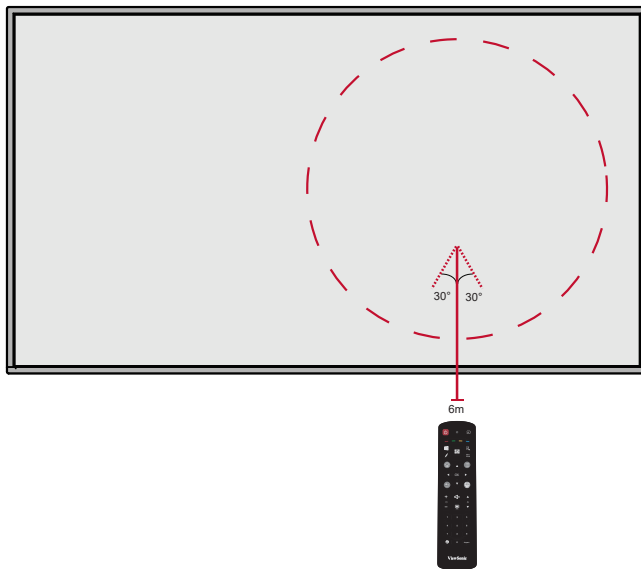
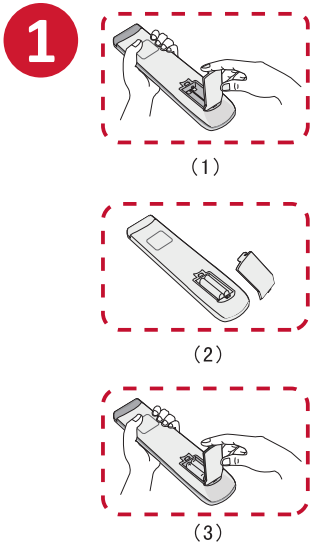
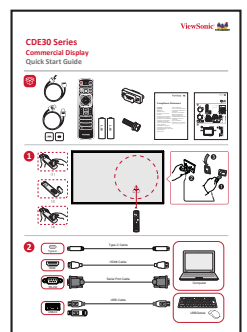
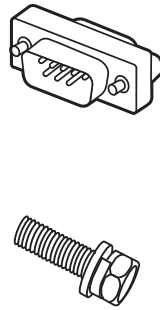
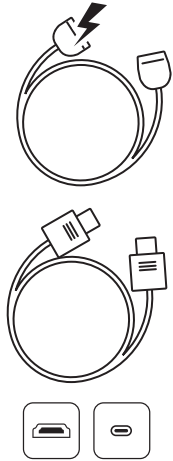
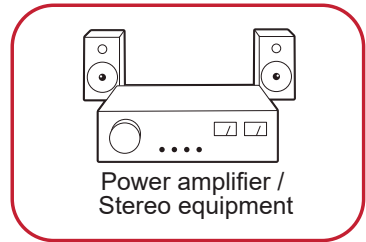
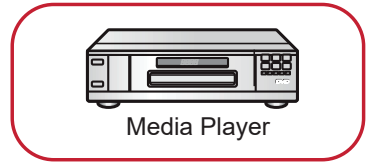
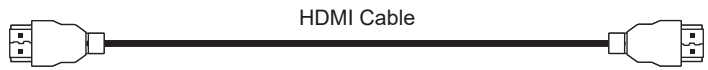
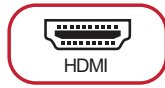
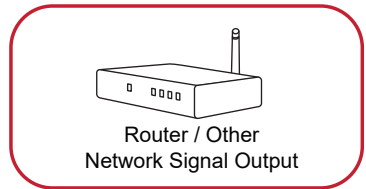
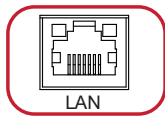

The terms HDMI, HDMI High-Definition Multimedia Interface, HDMI trade dress and the HDMI Logos are trademarks or registered trademarks of HDMI Licensing Administrator, Inc.

3

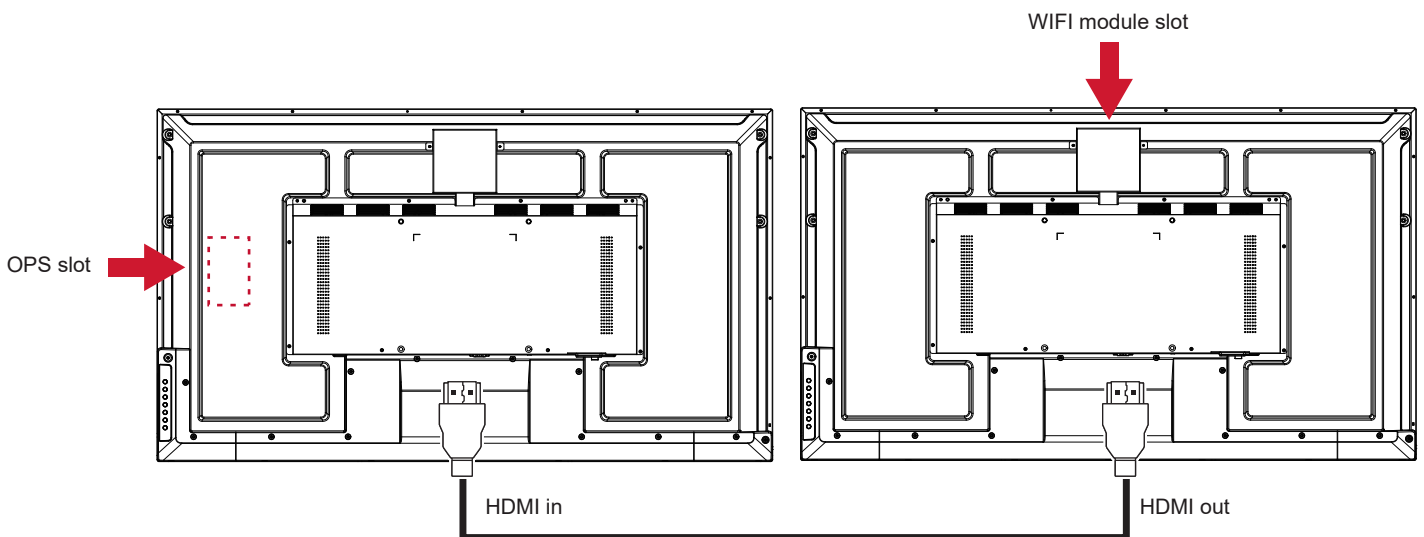

Scan for more information