

TCL

androidtv

OPERATION MANUAL

P715/C815/X10 SERIES

Table of Contents

Chapter 1: Safety Information

Precautions	3
Warning	3
Product	3
Power and Plug	3
Power Cord and Signal Cable	3
Use Environment	3
Cleaning	3
Hanging the TV Set on the Wall	3

Chapter 2: Connections and Setup

TV Buttons	4
Initial Setup	4
Sockets	5
Remote Control Functions	6
Installing Batteries	6
Exclusive Remote Control	7
How to Use the Remote Control.....	7
Installing Batteries	7
Network Connection	8
Switching On	9
Switching Off	9

Chapter 3: Basic TV Operations

Accessing Channels	10
Watching Connected Devices	10
Adjusting Volume	10
Accessing Smart TV Homepage	10
Accessing Google Play	10
Accessing T-Channel	11
Using System Settings menu	11
Using Instant Power On	11
Using TV Options menu	11

Chapter 4: Using more of your TV

Installing Channels	12
Using Subtitles	12
Turning On/Off Subtitles	12
Enabling Subtitle Languages on Digital TV Channels	12
Selecting a Subtitle Type on Digital TV Channels	12
Using Teletext	12
Selecting Decoding Page Language	12
Digital Teletext Language	12
Network Wake Up	12
T-Link	13
Enabling or Disabling T-Link	13
Using Auto Power On	13
Using Auto Standby	13
T-Cast	13
Using EPG (Electronic Programme Guide)	13
Bluetooth Function	13
Time Shift	14
PVR(Personal Video Recorder)	14
Freeview Plus	15
What You Need	15
To Launch Freeview Plus	15
HbbTV	15
HbbTV Access	15
HbbTV Deactivation	15
Works with Alexa	15
Netflix Settings	15
Reset Shop	16
Password in Parental Control	16
Using the Hands-free TV Voice Control	16

Chapter 5: Other Information

Problems & Solutions	17
Troubleshooting	18
Legal Statement	19

Precautions

Read all of the instructions before operating the set. Keep these instructions well for future use.

Warning

Never place a television set in an unstable location. A television set may fall, causing serious personal injury or death. Many injuries, particularly to children, can be avoided by taking simple precautions such as:

- Using cabinets or stands recommended by the manufacturer of the television set.
- Only using furniture that can safely support the television set.
- Ensuring the television set is not overhanging the edge of the supporting furniture.
- Not placing the television set on tall furniture (for example, cupboards or bookcases) without anchoring both the furniture and the television set to a suitable support.
- Not placing the television set on cloth or other materials that may be located between the television set and supporting furniture.
- Educating children about the dangers of climbing on furniture to reach the television set or its controls.

If your existing television set is being retained and relocated, the same considerations as above should be applied.

Product

- Do not block or cover the ventilation openings on the back cover.
- Do not push objects of any kind into this unit through the cabinet slots as they could touch the current carrying parts or short-circuit parts, resulting in fire, electric shock, or damage to the unit.
- Do not attempt to open the cabinet as this may cause damage. There are no parts inside you can service by yourself. Refer all servicing to qualified personnel.
- Do not touch the screen surface with fingers as this may scratch or mar the TV screen.
- Do not impact the TV screen with hard pressure as this may damage the TV screen severely.
- This appliance is not intended for use by young children or infirm persons without supervision. Young children should be supervised to ensure that they do not play with the appliance.

Power and Plug

- Unplug the set under the following conditions:
 - If the set will not be used for a long period of time.
 - If the power cord or the power outlet/plug is damaged.
 - Follow the instructions to install and adjust the product. Adjust those controls that are covered in these operating instructions as improper adjustment of other controls may result in damage. If this happens, unplug the set and refer to the service personnel.
 - If the set is subject to impact or has been dropped

and the cabinet has been damaged.

- Where the mains plug or an appliance coupler is used as disconnect device, the disconnect device shall remain readily operable.

Power Cord and Signal Cable

- Do not allow anything to rest on or roll over the power cord and the signal cable.
- Protect the power cord and the signal cable from being trampled.
- Do not overload the power cord or the power outlet.
- Do not expose the power cord and the signal cable to moisture.

Use Environment

- Do not place the set on an unstable cart, stand, or table.
- Place the set on a place that allows good ventilation.
- Do not use the set near damp, and cold areas.
- Do not expose the set to excessive heat such as direct sunlight, fire, or the like and no naked flame sources, such as lighted candles, should be placed on the apparatus.
- Do not expose the set to dripping or splashing and no objects filled with liquids, such as vases, shall be placed on the apparatus.
- Do not use the set in dusty environments.
- Operating Temperature: 5°C to 35°C (41°F to 95°F)
Operating Humidity: 20% to 80%, non-condensing
Storage Temperature: -15°C to 45°C (5°F to 113°F)
Storage Humidity: 10% to 90%, non-condensing

Cleaning

- Dust the set by wiping the screen and the cabinet with a soft, clean cloth or some special liquid cleaner.
- Do not apply excessive force to the screen when cleaning.
- Do not use water or other chemical cleaner to clean the screen as this may damage the surface of the TV screen.

Hanging the TV Set on the Wall

Warning: This operation requires two people.

To ensure a safe installation, observe the following safety notes:

- Check that the wall can support the weight of the TV set and wall mount assembly.
- Follow the mounting instructions provided with the wall mount.
- The TV set must be installed on a vertical wall.
- Make sure to use only screws suitable for the material of the wall.
- Make sure that the TV set cables are placed so that there is no danger of tripping over them.



All other safety instructions about our TV sets are also applicable here. Wall mount bracket not included.

(Note: certain TV models are not designed to be mounted to the wall.)

TV Buttons

- Power button

If the batteries in your remote control are run down, you can use the button on your TV set.

The model has only one  button. It may work just as Power on/Standby button, or as a multi-function controller. You can turn on the TV by pressing the  button on the TV set.

While the TV is on, press the  button to display the multi-function menu. More information about how to use the multi-function menu, please refer to the figure below.

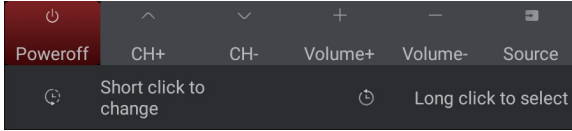

- Press  to move the highlight to the next function selection
- Press and hold the button for more than 2 seconds to confirm your selection.

Note:

You can follow the on-screen guide to operate. Figures and illustrations are provided for reference only and may vary depending on the model.

- MIC switch or

The MIC switch is located next to the power button. If you want to use the feature of hands-free TV voice control, turn on the switch (*not available for some models*).

Initial Setup

The first time you switch the set on, the **Welcome** wizard appears, which guides you through the initial setup process. Follow the on-screen instructions to finish the initial setup process such as selecting the language, connecting to the network, and more. During each step, either make a choice or skip the step. If you skip a step, you can perform the setup later from the settings menu.

Connections and Setup

Sockets

Note: the location and names of the sockets on the TV may vary according to TV model, and not all sockets are available on all models.

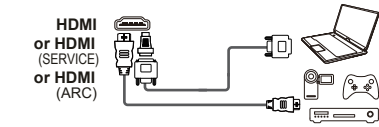

HDMI, HDMI(ARC) or HDMI(SERVICE) socket (input)

The HDMI (High-Definition Multimedia Interface) socket can be used to connect a Blu-ray player, PC with a compatible video card installed, certain DVD players or a high-definition compatible digital satellite decoder. This socket provides an uncompressed digital connection that carries both video and audio data by way of an integrated mini-plug cable.

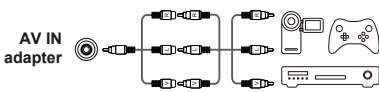

AV IN adapter socket

The AV IN adapter socket can be used to connect the attached AV adapter cable with VIDEO and AUDIO L & R IN sockets. The AV IN sockets can be used to connect a range of equipment, including video recorders, camcorders, decoders, satellite receivers, DVD players, or games consoles. The VIDEO IN socket provides composite video connection.



ANTENNA IN socket (input)

This socket can be used to connect an outside aerial.

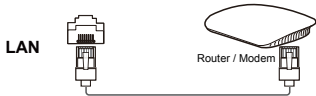

LAN

RJ45 plug for connecting to external modem or network access equipment.



DIGITAL AUDIO OUT (OPTICAL) socket

This socket can be used to connect a compatible digital audio receiver.



Headphone socket (output)

This socket can be used to connect headphones or stereo earphones.

Warning: Excessive sound pressure from earphones and headphones can cause hearing loss.

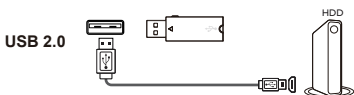

USB2.0 socket (input)

These sockets can be used to connect a USB 2.0 device.

Note: The number of USB sockets on the TV may vary according to TV model.

Connections and Setup

Remote Control Functions

Most of your television's functions are available via the menus that appear on the screen. The remote control supplied with your set can be used to navigate through the menus and to configure all the general settings.

Note: figures and illustrations in this operation manual are provided for reference only and may differ from actual product appearance. Certain function may not be available for some models, e.g. GUIDE/SUBTITLE functions are only available under DTV source. And DTV is not available for certain model.



RC802N

- To switch the sound off and back on.
- Standby / quit standby.
- Numeric buttons** To enter channel numbers or a digit.
- To access T recommended apps.
- LIST** To display the channel list.
- To control the volume.
- To display programme information, if available.
- To display the Settings menu.
- To change channels.
- To access the Smart TV homepage.
- To display the Option menu.
- Navigation direction buttons.
- OK** To confirm an entry or selection.
- To return to the previous menu or quit an app.
- To select input source.
- EXIT** To exit the Settings menu.
- LANG** To select an audio language available for selected digital TV programme.
- GUIDE** To toggle the Electronic Programme Guide on or off. (*only available for digital channels.*)
- TEXT** To toggle Teletext on or off.
- SUBT.** To select a subtitle language available for selected digital TV programme.
- Colour buttons** To select tasks or Teletext pages; to be used for HbbTV function.
 - To start fast reverse.
 - To pause playback.
 - To start fast forward.
 - To record programmes under DTV source.
 - To start playback.
 - To stop playback.
- NETFLIX** To access the NETFLIX application. (*Not available for some models.*)

Installing Batteries

1. Push to open the back cover as illustrated.
2. Insert two AAA batteries according to the polarities marked on the battery case.
3. Replace the back cover as illustrated.

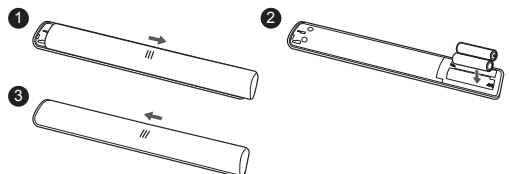













Connections and Setup

Exclusive Remote Control



RC602S

-  To switch the sound off and back on.
-  Standby / quit standby..
-  To control the volume.
-  To access T recommended apps.
-  To display the Settings menu.
-  To change channels.
-  To access or exit the Smart TV homepage.
-  To select input source.
-  Navigation direction buttons.
- OK** To confirm an entry or selection.
-  To return to the previous menu or quit an app.
-  To display the Option menu.
- NETFLIX** To access Netflix. *(Not available for some models.)*
-  To pop up the virtual remote control keyboard when available.
-  Press the Assistant button on your remote to talk to the Google Assistant. *(Available only when the network connection works)*

Note: This remote control is available only for selected models. The remote control type may be changed without notice.

Google and Android TV are trademarks of Google LLC.

How to Use the Remote Control

When using the Google Assistant button for the first time, you will be prompted to pair the remote with the TV.

- a. Keep the remote control and TV in 1 meter, please follow the on-screen guide for pairing instructions. You can use the Google Assistant button after activating successfully.
- b. The Google Assistant is only available for content search from certain apps.
- c. Set languages in the **settings** to your local language or official language to enhance voice search successfully.

Installing Batteries

1. Push to open the back cover as illustrated.
2. Insert two AAA batteries according to the polarities marked on the battery case.
3. Replace the back cover as illustrated.

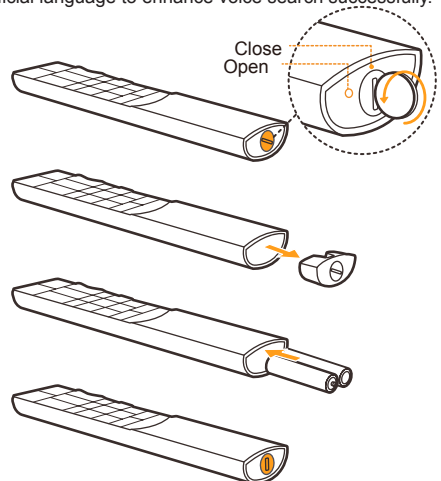

Network Connection



Your TV will require an internet connection to operate all functions. Data usage charges may apply. Please refer to your Internet Service Provider (ISP) for additional information.

To access the internet, you must subscribe to high speed broadband internet service from your internet service provider.

Your TV can be connected to your home network in two ways:

- Wired, using the RJ45 (LAN) connector on the back panel.
- Wireless, using the internal wireless or external wireless USB adapter and your home wireless network.

Note: the following instructions are just the usual ways to connect your TV to the wired or wireless network. The connection method may be different depending on your actual network configuration. If you have any questions about your home network, please refer to your ISP (Internet Service Provider).

Connecting to a wired Network

To connect to a wired network:

1. Ensure you have:
 - An Ethernet cable long enough to reach your TV
 - A router or modem with an available Ethernet port
 - A high-speed internet connection
 - An **Ethernet (LAN) port** on the back of the TV
2. Connect your Ethernet cable to the router and to the **Ethernet port** on the back of the TV.
3. Use the **Network & Internet** menu to configure the TV.

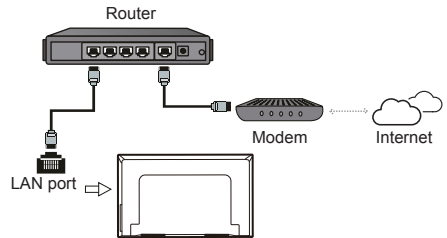





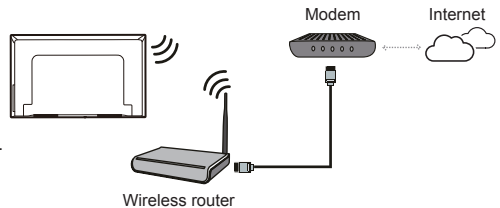

Connecting to a Wireless Network

To connect to a wireless network:

1. Ensure you have:
 - A router broadcasting a high-speed wireless signal
 - A high-speed internet connection
2. Use the **Network & Internet** menu to configure the TV.



Note: please follow below steps to enter the **Network & Internet** menu.

1. Press  on the remote control to display the Smart TV homepage.
2. Press    to move the cursor to  (**Settings**) on the right top of the screen and press **OK** to enter.
3. Press   to select **Network & Internet**, then press **OK** to enter the submenu and follow the on-screen guidance to set up your network.

Connections and Setup

Switching On

Follow the instructions on this page on how to switch on your TV set and the remote control before going on to following pages describing how to use the channel set-up procedure.

1. Insert two AAA batteries in the remote control.

Precautions on using batteries:

- Only use the battery types specified.
- Make sure you use the correct polarity.
- Do not mix new and used batteries.
- Do not use rechargeable batteries.
- Do not expose batteries to excessive heat such as sunshine, fire or the like, throw them in a fire, recharge them or try to open them, as this could cause them to leak or explode.
- Remove the batteries from the remote control if you are not using it for a long period of time.
- Attention should be drawn to the environmental aspects of battery disposal.

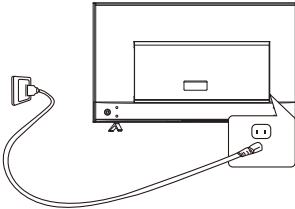

2. Connect the power cable FIRST to the television, THEN to a mains socket. (**Note:** if the power cable is connected to the television, please only connect the power cable to the mains socket.)

Your TV set should only be connected to an AC supply. It must not be connected to a DC supply. If the plug is detached from the cable, do not, under any circumstances, connect it to a mains socket, as there is a risk of electric shock.

Note: the figures are for representation only, the location of power socket of the television might differ depend on the model.

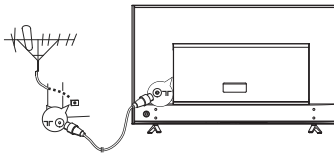

3. Connect an outside aerial to the ANTENNA IN socket at the back of the TV set.

The aerial socket (75 OHM - VHF / UHF / cable) can be used for connecting an external aerial or other equipment fitted.

Note: if you want to receive the signal from your cable or cable box, please connect a coaxial cable to the ANTENNA IN socket at the back of the TV set.

4. When powered on, the TV will be turned on directly or be in standby mode.

If the power indicator lights up, the TV set is in standby mode. Press the  button on the remote control or on the TV set to turn on the TV.

Switching Off

To put the TV set into standby mode, press the  button on the remote control. The TV set remains powered up, but with low energy consumption.

To switch off the TV set, unplug the mains socket from the mains outlet.

Accessing Channels

- Using the remote control of RC802N

Using the numeric buttons: press the corresponding numeric buttons on the remote control to access the channels.

Using the P buttons: press the P buttons on the remote control to scroll through the channels.

Using the LIST button: press the LIST button to display the channel list and press ▲/▼/◀/▶ and OK to select channels.

- Using the remote control of RC602S

Using the M buttons: press the M buttons on the remote control to scroll through the channels.

Using the OK button: press the OK button to display the channel list and press M/◀/▶ and OK to select channels.

Using the P buttons: press the P buttons on the remote control to scroll through the channels.

Using the [] button: press [] to display the virtual remote control keyboard, then you can use the numeric buttons or the LIST button to operate accordingly.

Watching Connected Devices

Press [] on the remote control to display the source list. Press ▲/▼ to select TV or other input sources and press OK to confirm.

You can also press [] on the remote control to display the homepage, press ▲/◀/▶ to move the cursor to the [](Inputs) area on the right top of the screen, and press OK to enter. Then press ▲/▼ and OK to select the input source.

Adjusting Volume

Volume control: press the 🔊 buttons on the remote control or the corresponding buttons on the TV set to increase or decrease the volume.

Sound mute: press the 🔇 button to temporarily mute the sound. Press this button again or the 🔊 button to restore the sound. (Available for RC802N remote control only.)

Accessing Smart TV Homepage

Allows you to enjoy Internet Applications (Apps) and specially adapted Internet websites, and perform system settings for your TV. You can make controlling with the TV remote control.

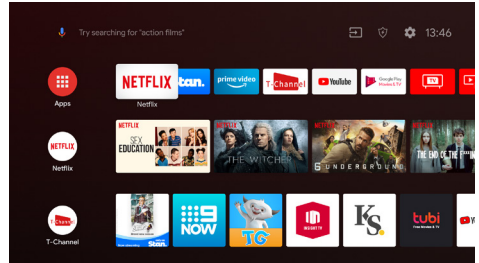

WARNING:

- Configure the network settings before using **Smart TV applications**.
 - Slow responses and/or interruptions may occur, depending on your network conditions.
 - If you experience a problem using an application, please contact the content provider.
 - According to circumstances of the content provider, an application's updates or the application itself may be discontinued.
 - Depending on your country's regulations, some applications may have limited service or not be supported.
 - Changes in application content may be made without prior notice by the service provider.
1. Press [] on the remote control to display the Smart TV homepage.
 2. Press ▲/▼/◀/▶ and OK to enter the desired apps, functions or settings.
 3. Press ← to return to the homepage.
 4. To exit the homepage, press ▲/◀/▶ to move the cursor to the [](Inputs) area on the right top of the screen, press OK to enter and then press ▲/▼ and OK to select your desired input source.

Note: since the connection with Internet takes time, it's recommended that you wait a few minutes to use the Smart TV feature after activation of TV from standby.

Accessing Google Play

Google Play is your entertainment unbound. It brings together all of the entertainment you love and helps you explore it in new ways, anytime, anywhere. We've brought the magic of Google to music, movies, TV, books, magazines, apps and games, so you get more from your content every day.

Basic TV Operations

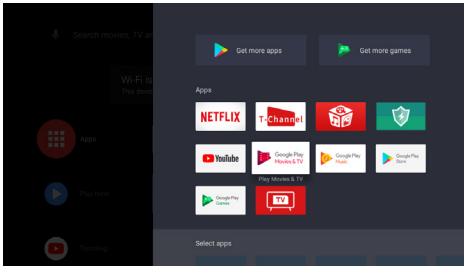

1. Press on the remote control to display the Smart TV homepage.
2. Press to select the **Apps**, and press **OK** to enter. Then press and **OK** to enter the desired apps.
3. Press to return to the homepage.

Accessing T-Channel

Allows you to enjoy Internet Applications (Apps).

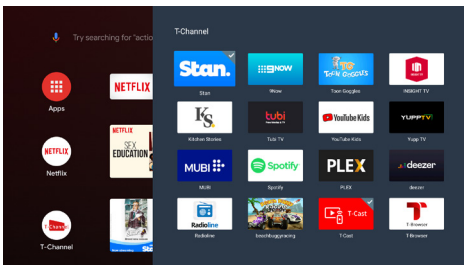

1. Press on the remote control to display the recommended apps.
2. Press and **OK** to enter the desired apps. For the first time, the apps will be downloaded automatically.
3. Press to return to the recommend page and exit.

Using System Settings menu

Allows you to not only adjust device settings, such as Network & Internet, Accounts & Sign-In, Apps and Device Preferences, etc., but also set preferences.

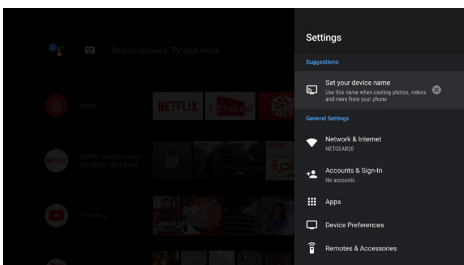

1. Press on the remote control to display the Smart TV homepage.
2. Press to move the cursor to (**Settings**) on the right top of the screen and press **OK** to enter the system settings.
3. Press to choose the items and press **OK** to enter.
4. Press to return to previous interface.
5. Press **EXIT** to close the menu.

Using Instant Power On

It enables you to turn on your TV faster from standby mode than turning this function off, but it will also increase standby power consumption.

1. Press on the remote control to display the homepage, Press to select (**Settings**) > **Device Preferences** > **Power** > **Instant power on** and press **OK** to toggle between On and Off.
2. Press to return to previous interface.

Using TV Options menu

Allows you to adjust TV settings, such as picture and sound.

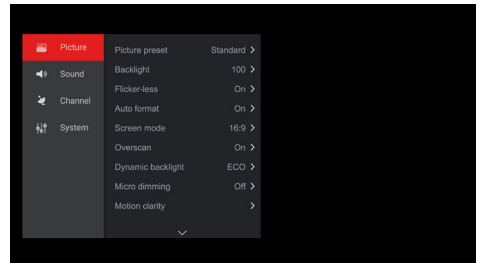



1. Press on the remote control to display the Settings menu.
2. Press to select the desired item, then press **OK/▶** to enter the corresponding submenu.
3. In submenu, press to select menu options, then press **OK/▶** to enter the option list, the adjustment interface, or the corresponding submenu.
4. Press to return to the previous menu.
5. Press **EXIT** or to close the menu.

Notes:

- You can also press on the remote control, select **Settings** (if available) and press **OK** to enter the Settings menu. Some options may not be available for certain signal sources.
- Setting **LED Motion clear** on will make fast moving images clearer by controlling the LED backlight, but the picture will be darker and more flickering than with **LED Motion clear** off.

Installing Channels

This section describes how to search and store channels automatically. This may be done in any of the cases below:

- you are prompted that there are no channels in TV mode;
 - you want to update your channels.
1. In TV mode, press  on the remote control and select **Channel > Channel scan**. Press **OK/▶** to enter.
 2. The TV installs and arranges channels according to your country or region. Press **▲/▼** to select **Country/Region**, and press **OK/▶** to enter. Enter the default password **1234** or your own password in case you have changed the password in the **System > Lock** menu. Press **▲/▼** to select your country or region and press **OK** to confirm.
 3. Press **▲/▼** to select **Automatic search** and press **OK/▶** to enter.
 4. Press **▲/▼** to select **Channel type** and press **◀/▶** to select **Digital, Analogue** or **Digital&Analogue**.
 5. After configuration is completed, press **▼** to select **Search** and press **OK** to start scanning channels.
 6. The channel search may take a few minutes. After the automatic search, channels are arranged in a preset order. If you wish to hide or move channels, press  on the remote control, select **Channel > Channel organizer** and press **OK/▶** to enter.



Note: If the channel search retrieved only the analogue channels it could be caused by poor broadcasting and therefore is not covered by manufacturer warranty. Manufacturers cannot be held responsible for lack of or poor broadcasting in some areas.

Using Subtitles

You can enable subtitles for each TV channel. Subtitles are broadcast via Teletext or DVB-T digital broadcasts. With digital broadcasts, you have the additional option of selecting a preferred subtitle language.

*Note: some options are available only when **Subtitle** is set to **On**.*

Turning On/Off Subtitles

1. Press  on the remote control, select **Channel > Subtitle** and press **OK/▶** to enter.
2. Select the **Subtitle** option, press **OK/▶** to enter, press **▲/▼** to select **On** or **Off** and press **OK** to confirm.
3. Press **EXIT** or  to close the menu.



Enabling Subtitle Languages on Digital TV Channels

1. Press  on the remote control, select **Channel > Subtitle > Digital subtitle language 1st** and press **OK/▶** to enter.

2. Press **▲/▼** to select a subtitle language as your preferred language and press **OK** to confirm.
3. Press **▲/▼** to select **Digital subtitle language 2nd** and press **OK/▶** to enter.
4. Press **▲/▼** to select a secondary subtitle language and press **OK** to confirm.
5. Press **EXIT** or  to close the menu.



Shortcut operation: Press **SUBT.** on the remote control to directly select a subtitle language available for the selected digital TV programme.
(Available for RC802N remote control only.)

Selecting a Subtitle Type on Digital TV Channels

1. Press  on the remote control, select **Channel > Subtitle > Subtitle type** and press **OK/▶** to enter.
2. Press **▲/▼** to select a subtitle type and press **OK** to confirm. You can select **Hearing impaired** to display the hearing impaired subtitles with your selected language.
3. Press **EXIT** or  to close the menu.



Using Teletext

Selecting Decoding Page Language

1. Press  on the remote control, select **Channel > Teletext > Decoding page language** and press **OK/▶** to enter.
2. Press **▲/▼** to select a proper type of language in which Teletext will display and press **OK** to confirm.
3. Press **EXIT** or  to close the menu.

Digital Teletext Language

On digital TV channels, depending on the broadcaster, you may be able to enjoy a service with multiple initial Teletext pages in different languages. This function allows you to select an available language as primary language, which relates to different initial Teletext pages.



1. Press  on the remote control, select **Channel > Teletext > Digital teletext language** and press **OK/▶** to enter.
2. Press **▲/▼** to select a language and press **OK** to confirm.
3. Press **EXIT** or  to close the menu.

Network Wake Up

This function allows you to turn on your TV from standby mode via a network. To use this function, please make sure:



1. Your TV is connected to an effective home network;
2. The desired controller, such as a smartphone, is connected to the same network as your TV;
3. An app which supports network waking up function, such as YouTube, has been installed into the controller;

Using more of your TV

4. **Networked standby** is set to **On** in the **Network & Internet** menu under homepage by pressing  >  (**Settings**) > **Network & Internet** and use  to select **Networked standby** and press **OK** to activate.

When the TV is in networked standby mode, you can use the app to wake up the TV remotely.



Notes:

- This feature is disabled if you press and hold the  button on the remote control and confirm to shut the TV down
- Before using the feature of network wake up, make sure  (**Settings**) > **Device Preferences** > **Power** > **Instant power on** is set to on.

T-Link

Use this function to search for CEC devices connected to the HDMI sockets in your TV and enable auto power on and auto standby between the TV and CEC devices.

Enabling or Disabling T-Link

1. Press  on the remote control, select **System** > **T-Link** and press **OK/▶** to enter.
2. Press **▲/▼** to select **T-Link** and press **OK/▶** to enter.
3. Press **▲/▼** to select **On** or **Off** and press **OK** to confirm.
4. Press **EXIT** or  to close the menu.

Using Auto Power On

Enables the TV to automatically power on when you power on a CEC device (e.g. DVD) with the device's remote. Select **On** to enable this function.

Using Auto Standby

Enables all CEC devices to automatically go to the standby mode when you turn off the TV with the TV remote. Select **On** to enable this function.

Note: the CEC functions depend on the devices connected and it is possible that some devices may not interoperate correctly when connected to this TV. The user manual or the manufacturer of the problematic devices should be consulted for further information.

T-Cast

T-Cast lets you enjoy plenty of videos, rich of applications, and share great contents on large screen. It also allows you to turn a smart device into a sophisticated remote control, providing more features than your normal TV remote control. You can then control your TV through your smart device.



Follow the on-screen instructions to scan the QR code on the TV screen and download T-Cast.

Note: Make sure the smart device and your TV are in the same home LAN (local area network) or network segment to use TV remote function.

Using EPG (Electronic Programme Guide)

EPG is an on-screen guide that displays scheduled digital TV programmes. You can navigate, select and view programmes.

*Note: the DTV EPG does not require an internet connection. To use the DTV EPG, HbbTV must be set to **Off**. when HbbTV is set to **ON**, then it will enter the HbbTV EPG directly. Please refer to “HbbTV” part of this manual for assistance to set HbbTV to on or off.*

1. Press  on the remote control, select **Channel** > **EPG** and press **OK/▶** to enter, or press **GUIDE** directly (if available) on the remote control, the **Programme Guide** menu will appear, which allows you to get information about the current or next programme playing on each channel. Navigate through the different programmes using the **▲/▼/◀/▶** buttons on the remote control.
2. Use the related buttons shown at the bottom of the screen to view EPG.
 - **Programme filter:** Programme guide filter for digital TV programmes.
 - Press  to display the type list of the programme.
 - Navigate through the different types using the **▲/▼** buttons on the remote control.
 - Select one or more types, which you want to highlight from the type list, press **OK** to select or deselect. A checkmark will appear to the right of the type when selected.
 - **Custom schedule:** Press **▲/▼** to select a programme, then press the **RED** button to set the schedule, press **OK** to enter and use **▲/▼** to select **Schedule reminder** or **Schedule recording**.
 - **Select date:** Press the **GREEN** button to select date.
 - **Schedule list:** Press the **YELLOW** button to view your schedule list.

Note: if using the remote control of RC602S, to access the colour buttons, you need to press  button on the remote control to display the virtual remote control keyboard first.

3. Press **←** to exit EPG.





Bluetooth Function

(* not available for some models)

Bluetooth® is a wireless technology standard for exchanging data over short distance between Bluetooth devices. You can connect Bluetooth audio device,

Using more of your TV

mouse or keyboard via the TV.

1. Press  on the remote control, press  /  to move the cursor to the  (Settings) area on the right top of the screen and press **OK** to enter.
2. Move to the **Remotes & Accessories** area, select **Add accessory** and press **OK** to enter. The TV will search nearby Bluetooth devices automatically.
3. Select an available device, press **OK** and follow the guides on the screen to connect it.









Note: bluetooth technology (if available in your TV) uses 2.4GHz frequency thus close proximity to Wi-Fi access points, routers or microwave ovens might interfere with Bluetooth audio streaming. If you face interruptions in audio reception, you should restart your Bluetooth device to find frequency with less interferences and if you continue to face issues you should move closer to TV or increase space between TV and source of interferences.



The Bluetooth word mark and logos are registered trademarks owned by Bluetooth SIG, Inc. and any use of such marks by TCL is under license. Other trademarks and trade names are those of their respective owners.

Time Shift

(* not available for some models)

Allows you to pause, fast forward and rewind live TV, so you don't have to miss any part of your favourite programmes. Before you use the function, connect a USB drive to the TV first. For the first time, you should complete the disk setup for the USB drive.

Press  on the remote control and select **Time shift**, then press **OK** /  to confirm. (**Note:** this option is available only when **Time shift** is set to On: press  on the remote control, press  /  to select **Settings** > **Channel** > **Time Shift**, press **OK** /  to enter and use  /  to set Time Shift to **On** or **Off**.)

1. Follow the directions on the screen to do the disk setup if you use time shift for the first time.
2. After the disk setup is done, time shift will start, and the time shift menu displays on the screen.
3. For later use, press  and select **Time shift**. press **OK** to display the time shift menu and operate according to the on-screen prompt.
4. Pressing  button on the remote control stops the time shift and exits. (for RC602S, you can find  button on the virtual remote control keyboard.)
 - When the time shift menu disappears and only the timing of the time shift remains on the screen, you can press **OK** to call out the time shift menu.

Notes:

- Before you plug the USB drive to TV, make sure you have backed up the data on the drive to avoid unforeseen malfunction and data loss.
- We recommend that you use a USB drive with at

least 1GB free space and a disk speed faster than 5.0MB/sec.

- The bigger the USB drive free space for time shift, the bigger the recording length.

Quick Access of Time Shift









Insert a USB disk, press **PAUSE** () on the remote control, it will access time shift automatically. (Available for RC802N remote control only.)

PVR (Personal Video Recorder)

(* not available for some models)

Allows you to record your favourite TV programmes. Before you use the function, connect a USB drive to the TV first.

Note: the feature is available only in selected products and, due to specific TV network limitations and country technical requirements, might not be available in product or place of installation. Feature might also be blocked by TV network due to copyright protection (HD content, recording protection). Please use  on the remote control to check if the feature is available in your product.

1. Press  on the remote control and select **PVR**.
2. Press **OK** /  to enter and select **Record**. It starts to record automatically.
3. Press **blue** button to access **Settings** and use  /  /  to adjust the recording duration.
4. Press **OK** or  to stop recording manually, the recorded file will be saved. In normal operation, the recording will stop automatically when the recording duration expires.
Note: you can find  and colour buttons on the virtual remote control keyboard for RC602S.
5. In recording, the PVR mini pane will also show on the screen to indicate the recording progress.
6. To watch the recorded programme, exit PVR mode first. Press  and select **PVR** > **PVR list**, then select the related record file. Press **OK** to play. (It is the same if you record a digital radio programme.)

Notes:

- This feature is available only for digital non encrypted channels.
- Before you connect the USB drive to the TV, make sure you have backed up the data in the drive to avoid the loss of your important data due to unforeseen malfunction.
- The bigger the USB drive free memory for the PVR function, the bigger the recording length.
- If you want to change channel or signal source during recording, store the recording data before changing the channel or source.
- The TV cannot play files normally if the parameters of the file exceed the limitations of the system, the file format is not supported, the file is damaged, or the file cannot be decoded.

Using more of your TV

- Do not disconnect the USB drive when the system is reading a file or transmitting data, otherwise the system or the drive may be damaged.

Freeview Plus

Freeview Plus delivers an aggregated TV service that includes an unrivalled 7+ day EPG experience from all the free to air networks in Australia. At the press of a button, Freeview Plus provides users with all the available Catch Up content along with the ability to set reminders and to search for content via genre. Use the following features and don't miss a show:

- A 7+ day easy to use EPG
- All available Catch Up TV content
- Featured recommendations
- Ability to browse by genre and search programmes for the next 7 days
- A favourite function with reminders to live and Catch Up programmes

What You Need

Your television must be connected to a high speed broadband internet connection as well as an aerial.

To Launch Freeview Plus

When you are watching TV, you will see a prompt at the top left of the screen. Press the corresponding colour key on the remote control to launch Freeview Plus. Follow the on-screen instructions and use the colour keys, arrow keys and the **OK** button to navigate.

*Freeview Plus uses HbbTV technology which combines broadcast and broadband. An internet connection is required. Data usage and conditions apply.

**Freeview Plus is available throughout Australia but Catch Up services vary by region – please check www.freeview.com.au to see what is available in your area.

***More information about Freeview Plus can be found on www.freeview.com.au.

HbbTV

HbbTV (Hybrid broadcast broadband TV) is a service offered by certain broadcasters and available only on some digital TV channels. HbbTV delivers interactive television over broadband Internet. These interactive features are added to and enrich the normal digital programmes, and include services such as digital teletext, electronic programme guide, games, voting, specific information related to the current programme, interactive advertising, information magazines, catch-up TV, etc.

To use HbbTV please ensure your TV is connected to Internet and HbbTV is switched on.

Notes:

- HbbTV services are broadcast- or country-dependent and may be unavailable in your area.
- You cannot download files to your TV with HbbTV function.
- Application provider or broadcasting related conditions may cause an HbbTV application to be unavailable momentarily.
- To access HbbTV applications you must connect your TV to the Internet via a broadband link. HbbTV applications may not work correctly in case of network related issues.

HbbTV Access

1. Press  on the remote control, select **System > HbbTV settings** and press **OK/▶** to enter.
2. Select **HbbTV** then press **▲/▼** to select **On** and press **OK** to confirm.
3. When you tune to a digital TV channel that offers HbbTV, this will be signaled to you by an on-screen indication (generally a red button, but other colour buttons may also be used). Press the indicated colour button to open the interactive pages.
4. Use **▲/▼/◀/▶** and the colour buttons to navigate through the HbbTV pages and press **OK** to confirm.

HbbTV Deactivation

To avoid disturbances that may be caused by HbbTV broadcasting tests, you can turn off the HbbTV function:

1. Press  on the remote control, select **System > HbbTV settings** and press **OK/▶** to enter.
2. Select **HbbTV** then press **▲/▼** to select **Off** and press **OK** to confirm.

Works with Alexa

To use the Works with Alexa function, you will need a device like an Amazon Echo or Amazon Echo Dot (Sold Separately). Set up your Amazon device. Then, on your TV go to the Settings Menu, select System, and select **“Works with Alexa”**. Then follow the on screen prompts. Please note that within the Alexa app on your phone, you will need to enable the TCL Assistant Skill, through the Alexa Skills Menu.







Netflix Settings

Netflix provides on-demand movies and TV shows delivered via the Internet. Netflix is available in certain countries. Unlimited membership is required. More information can be found at www.netflix.com <<http://www.netflix.com/>>.

Note: you can directly access Netflix via clicking the **Netflix** button on the remote control.

Reset Shop

Allows you to reset the TV to factory default settings.

1. Press  on the remote control to display the homepage, Press / to select (**Settings**) > **Device Preferences** > **Reset** and press **OK/▶** to enter.
2. Press / to select **Factory data reset** and press **OK** to enter. Then select **Erase everything** and press **OK** to confirm.
3. Enter the password 1234 or your own password in case you have changed the password.
4. Select **OK** and press **OK** to confirm.
5. The **Initial setup** wizard appears. Follow the instructions in the section **Initial setup**.



Password in Parental Control

- The default password is 1234. You can change it to a new one.
- The super password is 0423. If you forget your code, enter the super password to override any existing codes.

Using the Hands-free TV Voice Control

(not available for some models)*

Before using the hands-free TV voice control, connect the TV to the network and make sure it can access the Google website first. Then follow the steps below to access.

1. Turn the built-in MIC switch (next to the power button) to on before using this function.
2. Access the Android TV homepage by pressing  on the remote control.
3. Select (**Settings**) > **Quick Settings** > **'Ok Google' detection** and press **OK** to turn it on. You can also set it by selecting (**Settings**) > **Device Preferences** > **Google Assistant** > **'Ok Google' detection**.
4. Say "OK Google" to activate it.

Notes:

- *The availability of hands-free TV voice control depends on your region/country/language and your model. For details, please refer to your local dealer.*
- *A quiet surrounding is required for better function when using it. The recommended using distance is within 2 meters in front of TV set.*
- *Turn the built-in MIC switch to off if you are not going to use it. Or set the **'Ok Google' detection** to off.*
- *Standby power consumption will increase because the built-in MIC is always listening when the Google Assistant or voice control with the built-in MIC is enabled.*

Problems & Solutions

Note: problems & solutions 1 to 2 are for the TV models which have network functions, so users of non-connected TV models can disregard them.

1. Fail to link to the network.

- Check if your TV is connected with the network;
- Reboot your TV;
- Consult your internet service provider, to confirm if access of your router is supported. Refer to the operation manual of your router.
- Make sure your TV is connected to a router, and make sure your router is powered on. Check that your router/modem has an internet connection, and that your Ethernet cables/wireless connection is OK. Test your connection with a computer to make sure it is OK. Should the problem persist, contact customer service.

2. The video could not be played smoothly.

- Videos from your USB flash drive --- It may result from data transmission, or its code flow is far beyond the supported formats of this TV set.
- Videos downloaded from internet, or online videos.
 - a. It may be caused by the lower bandwidth of your network. A high network speed is required to handle online videos.
 - b. Peak internet usage times may affect the bandwidth.
 - c. Check if any other computers on the same network are also operating, as they may be using up bandwidth. Especially if they are downloading or playing on-line videos.
 - d. The video may not be smooth itself, it is not the problem of your TV or network.

3. When two mobile hard disks are connected with the TV at the same time, they will not be recognized some times.

- All mobile hard disks consume a lot of power, which may result in power supply problems. We recommend inserting only one hard disk, or a low power consumption mobile hard disk.

4. The video from a mobile hard disk (USB) is playing with no sound.

- The audio format of the video in your mobile hard disk is not supported by the TV player.

5. Some videos fail to play.

- The formats of the videos may not be supported by the TV, especially videos shot by certain kinds of cameras, generally with their private protocol of formats, which are not compatible with your TV.

6. Video stops playing midway.

- Mistakes may occur when videos are copied or

compressed, so they may automatically stop playing during playback.

7. What should I pay attention to, when I do SW updating?

- No power cuts when SW updating;
- Avoid any operations with your remote control when SW updating;
- Depending on your internet connection speed, the software updating process may take some time.

8. There are no distinct changes of TV interface after SW updating.

- Under certain conditions, SW updating may not only update or add new functions but also improve the performance of the TV set, without distinct changes to the user interface. Also, there may be no changes to the user interface at all.

9. What should I do when SW updating process stops due to a sudden power-off?

- If you do SW updating by USB, do not pluck the USB from your TV, and restart your TV to continue SW updating; If you do SW updating by Network, also restart your TV and check if it is well functioned.

10. With a USB device being inserted into the TV in advance, I am prompted that no USB devices are detected after I access Media, why?

- There may be something wrong with your mobile hard disk(s), damaged or with low voltage. You could increase power supply by inserting the two plugs on one end on the USB wire into TV's USB port simultaneously.

11. External device cannot be recognized.

- Some external devices (e.g. webcam, smart phone, tablet, game handle, and external wireless adapter) may not be compatible with the TV and cannot be supported for certain functions (nScreen, wireless display, gesture control, face recognition, if any). Please try a similar device. If it does not work, contact your local dealer.

12. Voice search does not work.

- Check if your remote control has been successfully paired with your TV.
- Check if the language setting is correct.
- Check if Google server is available and stable.

Troubleshooting

Most problems you encounter with your TV can be corrected by consulting the following troubleshooting list.

No picture, no sound

1. Check if the fuse or circuit breaker is working.
2. Plug another electrical device into the outlet to make sure it is working or turned on.
3. Power plug is in a bad contact with the outlet.
4. Check the signal source.

No colour

1. Change the colour system.
2. Adjust the saturation.
3. Try another channel. Black-white programme may be received.

Remote control does not work

1. Change the batteries.
2. Batteries are not installed correctly.
3. Main power is not connected.

No picture, normal sound

1. Adjust the brightness and contrast.
2. Broadcasting failure may happen.

Normal picture, no sound

1. Press the VOLUME UP button to increase volume.
2. Volume is set to mute, press the **Mute** button to restore sound. (Available for RC802N remote control only.)
3. Change the sound system.
4. Broadcasting failure may happen.

Unorderly ripples on the picture

It is usually caused by local interference, such as cars, daylight lamps and hair driers. Adjust the antenna to minimize the interference.

Snowy dots and interference

If the antenna is located in the fringe area of a television signal where the signal is weak, the picture may be marred by dots. When the signal is extremely weak, it may be necessary to install a special antenna to improve the reception.

1. Adjust the position and orientation of the indoor/ outdoor antenna.
2. Check the connection of antenna.
3. Fine tune the channel.
4. Try another channel. Broadcasting failure may happen.

Ignition

Black spots or horizontal streaks appear, or the picture flutters or drifts. This is usually caused by interference from car ignition system, neon lamps, electric drills, or other electrical appliance.

Ghost

Ghosts are caused by the television signal following two paths. One is the direct path, the other is reflected from tall buildings, hills, or other objects. Changing the direction or position of the antenna may improve the reception.

Radio frequency interference

This interference produces moving ripples or diagonal streaks, and in some case, loss of contrast in the picture. Find out and remove the radio interference source.

**To bring you better visual experience, please remove all labels, if any, from TV front panel and screen before use.*

**Figures and illustrations in this User Manual are provided for reference only and may differ from actual product appearance. Product design and specifications may be changed without notice.*

Legal Statement

[Legal Statement] of TCL - manufacturer of this TV set
Due to the various capabilities of products featuring the SmartTV - Services, as well as limitations in the available content, certain features, applications, and services may not be available on all devices or in all territories. Some features on SmartTV may also require additional peripheral devices or membership fees that are sold separately. Please visit our website for more information on specific device information and content availability. The services and availability of content through SmartTV are subject to change from time to time without prior notice.

All content and services accessible through this device belong to third parties and are protected by copyright, patent, trademark and/or other intellectual property laws. Such content and services are provided solely for your personal noncommercial use. You may not use any content or services in a manner that has not been authorized by the content owner or service provider. Without limiting the foregoing, unless expressly authorized by the applicable content owner or service provider, you may not modify, copy, republish, upload, post, transmit, translate, sell, create derivative works, exploit, or distribute in any manner or medium any content or services displayed through this device.

You expressly acknowledge and agree that use of the device is at your sole risk and that the entire risk as to satisfactory quality, performance and accuracy is with you. The device and all third party content and services are provided "as is" without warranty of any kind, either express or implied. TCL expressly disclaims all warranties and conditions with respect to the device and any content and services, either express or implied, including but not limited to, warranties of merchantability, of satisfactory quality, fitness for a particular purpose, of accuracy, of quiet enjoyment, and non-infringement of third party rights. TCL does not guarantee the accuracy, validity, timeliness, legality, or completeness of any content or service made available through this device and does not warrant that the device, content or services will meet your requirements, or that operation of the device or services will be uninterrupted or error-free. Under no circumstances, including negligence, shall TCL be liable, whether in contract or tort, for any direct, indirect, incidental, special or consequential damages, attorney fees, expenses, or any other damages arising out of, or in connection with, any information contained in, or as a result of the use of the device, or any content or service accessed by you or any third party, even if advised of the possibility of such damages.

Third party services may be changed, suspended, removed, terminated or interrupted, or access may be disabled at any time, without notice, and TCL makes no representation or warranty that any content or service will remain available for any period of time. Content and services are transmitted by third parties by means of networks and transmission facilities over which TCL has no control. Without limiting the generality of this disclaimer, TCL expressly disclaims any responsibility or liability for any change, interruption, disabling, removal of or suspension of any content or service made available through this device. TCL may impose limits on the use of or access to certain services or content, in any case and without notice or liability. TCL is neither responsible nor liable for customer service related to the content and services. Any question or request for service relating to the content or services should be made directly to the respective content and service providers.



The terms HDMI, HDMI High-Definition Multimedia Interface, and the HDMI Logo are trademarks or registered trademarks of HDMI Licensing Administrator, Inc.



HEVC, or H.265 is the successor to H.264 and strives to deliver video with equivalent quality with bitrate savings of up to 50 percent. HEVC is critical for streaming high-quality video even in congested network environments, and will be a driving factor in the delivery of 4K content to new Ultra HD displays.



Dolby, Dolby Vision, Dolby Atmos, Dolby Audio, and the double-D symbol are trademarks of Dolby Laboratories. Manufactured under license from Dolby Laboratories. Confidential unpublished works. Copyright © 1992-2019 Dolby Laboratories. All rights reserved.



The Bluetooth® word mark and logos are registered trademarks owned by Bluetooth SIG, Inc. and any use of such marks by TCL is under license. Other trademarks and trade names are those of their respective owners.



Freeview Plus uses HbbTV technology which combines broadcast and broadband. An internet connection is required. Data usage and conditions apply.



For DTS patents, see <http://patents.dts.com>. Manufactured under license from DTS Licensing Limited. DTS, the Symbol, DTS and the Symbol together, DTS-HD, and the DTS-HD logo are registered trademarks or trademarks of DTS, Inc. in the United States and/or other countries. © DTS, Inc. All Rights Reserved.



Like us on Facebook

TCL Electronics Australia Pty Ltd.

ABN 83 111 032 896

Telephone: 1300 738 149

service.au@tcl.com

www.tcl.com/au



72-RT51MT-EAU1C