

**StarTech.com**  
Hard-to-find made easy®

## Articulating Monitor Arm and Laptop Holder

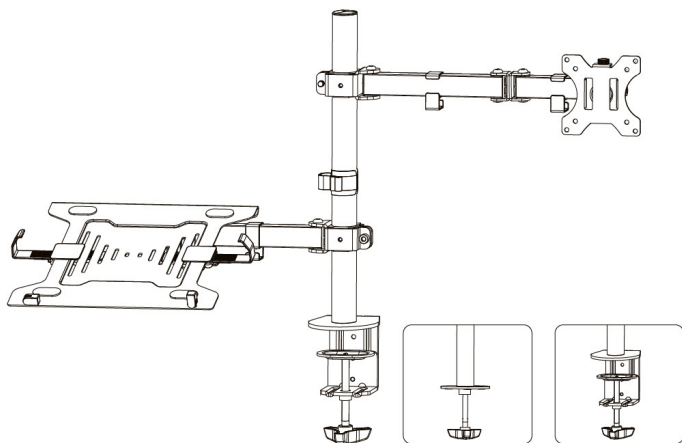

*Actual product may vary from photos*

### User Manual

SKU: A2-LAPTOP-DESK-MOUNT

## Compliance Statements

### **Use of Trademarks, Registered Trademarks, and other Protected Names and Symbols**

This manual may make reference to trademarks, registered trademarks, and other protected names and/or symbols of third-party companies not related in any way to StarTech.com. Where they occur these references are for illustrative purposes only and do not represent an endorsement of a product or service by StarTech.com, or an endorsement of the product(s) to which this manual applies by the third-party company in question. Regardless of any direct acknowledgement elsewhere in the body of this document, StarTech.com hereby acknowledges that all trademarks, registered trademarks, service marks, and other protected names and/or symbols contained in this manual and related documents are the property of their respective holders.

PHILLIPS® is a registered trademark of Phillips Screw Company in the United States or other countries.

# Safety Statements

## Safety Measures

- Product installation and/or mounting should be completed by a certified professional as per the local safety and building code guidelines.

## Mesures de sécurité

- L'installation et/ou le montage du produit doit être réalisé par un professionnel certifié et dans le respect des normes locales et du code de construction local.

## 安全対策

- 製品の設置やマウントは、使用地域の安全ガイドラインおよび建築基準に従い、有資格の専門業者が行うようにしてください。

## Misure di sicurezza

- L'installazione e/o il montaggio dei prodotti devono essere eseguiti da un tecnico professionale certificato che conosca le linee guida locali sulle norme edilizie e sulla sicurezza.

## Säkerhetsåtgärder

- Installation och/eller montering får endast göras av behöriga yrkespersoner och enligt gällande lokala förordningar för säkerhet och byggnormer.

## Warning Statements

- Assemble this product according to the instructions.
- Read the entire manual and ensure the instructions are fully understood before assembling and/or using this product.
- Do not exceed the weight capacity of this product. Overloading this product might result in injury or property damage.
- Weight capacity of the monitor mount: 8 kg (17.6 lb.)
- Weight capacity of the laptop mount: 4.5 kg (9.9 lb.)
- Do not allow children to climb on this product, or use this product without proper supervision.
- This product is intended for indoor use only and should not be used outdoors.
- Do not over-tighten the screws. If any resistance is encountered, stop tightening.
- Assembling this product is a two-person task. Do not attempt to assemble this product and install equipment without assistance.
- Before adding equipment to this product, ensure the product has been properly assembled, and that the product can support the weight of the added equipment.
- Make sure all of the equipment has been properly secured before adjusting this product.
- Pinch hazard! Keep your fingers clear from moving components.

## Varningsmeddelanden

- Se till att du monterar produkten i enlighet med instruktionerna.
- Läs hela manualen och se till att du förstår instruktionerna innan du börjar montera och använda produkten.
- Överskrid inte produktens viktkapacitet. Överbelastning av produkten kan orsaka skada på person eller egendom.
- Skärmfästets viktkapacitet: 8 kg (17,6 lb.)
- Viktkapacitet för bärbar datorfäste: 4,5 kg (9,9 lb.)
- Låt inte barn klättra på produkten eller använda produkten utan uppsikt.
- Produkten är endast avsedd för användning inomhus och ska inte användas utomhus.
- Dra inte åt skruvarna för hårt när du monterar produkten. Om du måste ta i när du skruvar åt kan du sluta skruva åt.
- Det krävs Monitorå personer för att montera produkten. Försök inte montera produkten och installera utrustning utan hjälp.

- Innan du lägger till utrustning på produkten, se till att produkten är korrekt monterad, installerad och att produkten klarar av vikten på utrustningen som du lägger till.
- Se till att all utrustning är korrekt installerad innan du börjar justera produkten.
- Innan du börjar flytta på vagnen, se till att hjulen är upplåsta.
- Klämrisk! Håll fingrarna borta från rörliga komponenter.

## Waarschuwingen

- Zorg dat u dit product volgens de instructies in elkaar zet.
- Lees de gehele handleiding en zorg dat u de instructies begrijpt voordat u dit product in elkaar zet en gebruikt.
- Overschrijd de maximale capaciteit van dit product niet. Overbelasting van dit product kan letsel of materiële schade veroorzaken.
- Gewichtscapaciteit van de monitorsteun: 8 kg (17,6 lb.)
- Gewichtscapaciteit van de laptopbevestiging: 4,5 kg (9,9 lb.)
- Geef kinderen geen toestemming om op dit apparaat te klimmen of dit product zonder goed toezicht te gebruiken.
- Dit product is alleen bedoeld voor binnengebruik en mag niet buiten worden gebruikt.
- Draai de schroeven niet te strak vast wanneer u dit product in elkaar zet. Als u weerstand voelt tijdens het vastdraaien van de schroeven, stop dan.
- Dit product moet met twee personen in elkaar worden gezet. Probeer dit product niet zonder hulp in elkaar te zetten en apparatuur te installeren.
- Voordat u apparatuur aan dit product toevoegt, moet u ervoor zorgen dat u het op de juiste manier in elkaar hebt gezet en geïnstalleerd, en dat het product het gewicht van de toe te voegen apparatuur kan ondersteunen.
- Voordat u de wagen gaat verplaatsen, moet u de zwenkwielen ontgrendelen.
- Gevaar voor beknelling! Houd uw vingers weg van de bewegende onderdelen als u.

## 注意

- 必ず取扱説明書に従って本製品の組み立てを行って下さい。
- 最初に取扱説明書を最後まで読み、本製品の組み立て方をすべて理解してから組み立て作業を始めて下さい。
- 本製品で定められた最大積載重量を超えないようにして下さい。最大積載重量をオーバーした場合、怪我をする恐れや器物破損の恐れがあります。
- モニターマウントの耐荷重: 8 kg (17.6ポンド)
- ラップトップマウントの耐荷重: 4.5 kg (9.9 lb.)

- 本製品に小さなお子様が乗って遊ばないようにして下さい。お子様が使用する際には、適切な監視を怠らないようにして下さい。
- 本製品は、室内での使用を想定しています。戸外では使用しないで下さい。
- 本製品を組み立てる際、ネジを締めすぎないようにして下さい。ネジを締めているうちに手応えを感じたら、締めるのを止めてください。
- 本製品は、二人がかりでの組み立てを想定しています。手助けなしに単独で組み立てと設置を行わないで下さい。
- コードやケーブルの上、または凹凸のある床面でカートを移動させないで下さい。
- 危険! 可動部品に近づかないでください。

## Dichiarazioni di avvertenza

- Assicurarci di Assemblare il prodotto secondo le istruzioni.
- Leggere l'intero manuale e assicurarsi di aver compreso tutte le istruzioni prima di iniziare ad assemblare e a utilizzare questo prodotto.
- Non superare la capacità di carico del prodotto. Il sovraccarico del prodotto potrebbe causare danni o lesioni.
- Capacità di peso del supporto del monitor: 8 kg (17,6 lb.)
- Capacità di peso del supporto per laptop: 4,5 kg (9,9 lb.)
- Non consentire ai bambini di arrampicarsi sul prodotto o di utilizzarlo senza un'adeguata supervisione.
- Il prodotto è destinato all'uso in ambienti interni. Se ne sconsiglia l'impiego in ambienti esterni.
- Durante l'assemblaggio del prodotto, non stringere troppo le viti. Se si incontra resistenza mentre si stringono le viti, interrompere l'operazione.
- L'assemblaggio di questo prodotto richiede la presenza di due persone. Non tentare di assemblare il prodotto e installare le apparecchiature senza assistenza.
- Prima di aggiungere altre apparecchiature al prodotto, assicurarsi di averlo assemblato e installato correttamente e che sia in grado di sostenere il peso dell'apparecchiatura in questione.
- Prima di procedere allo spostamento del carrello, verificare di aver sbloccato le rotelle.
- Pericolo di Schiacciamento! Tenere lontane le dita da parti in movimento.

## Avertissements

- Assemblez ce produit conformément aux instructions.
- Lisez tout le manuel et assurez-vous que vous comprenez les instructions avant de commencer à assembler et utiliser ce produit.

- Ne dépassez pas la capacité pondérale du produit. Une surcharge du produit peut entraîner des blessures ou des dommages matériels.
- Capacité de poids du support de moniteur: 8 kg (17,6 lb)
- Capacité de poids du support pour ordinateur portable : 4,5 kg (9,9 lb.)
- N'autorisez pas les enfants à grimper sur ce produit ni à l'utiliser sans surveillance.
- Ce produit est uniquement destiné à une utilisation en intérieur et ne doit pas être utilisé à l'extérieur.
- Ne serrez pas trop les vis lors de l'assemblage de ce produit. Si vous rencontrez une résistance lors du serrage des vis, cessez de serrer.
- L'assemblage de ce produit nécessite deux personnes. Ne tentez pas d'assembler le produit et d'installer les équipements sans aide.
- Avant d'ajouter des équipements au produit, vérifiez que vous l'avez correctement assemblé et installé, et que le produit peut supporter le poids des équipements que vous y ajoutez.
- Avant de déplacer le meuble, veillez à débloquer les roulettes.
- Risque de pincement ! Ne pas approcher les doigts des composants mobiles.

## Mensagens de aviso

- Certifique-se de que monta este produto de acordo com as instruções.
- Leia todo o manual e certifique-se de que entende as instruções antes de começar a montar e a utilizar este produto.
- Não exceda a capacidade de peso deste produto. Sobrecarregar este produto pode resultar em ferimentos ou danos de propriedade.
- Capacidade de peso do suporte do monitor: 8 kg (17,6 lb.)
- Capacidade de peso do suporte para laptop: 4,5 kg (9,9 lb.)
- Não deixar as crianças trepar neste produto ou utilizar este produto sem a devida supervisão.
- Este produto destina-se apenas a uma utilização no interior e não deve ser utilizado no exterior.
- Quando montar este produto, não aperte demasiado os parafusos. Se encontrar resistência enquanto aperta os parafusos, pare de apertar.
- Montar este produto é uma tarefa para duas pessoas. Não tentar montar este produto e instalar o equipamento sem assistência.
- Antes de adicionar o equipamento a este produto, certifique-se de que o montou e instalou devidamente e de que o produto pode suportar o peso do equipamento que está a adicionar ao mesmo.
- Antes de começar a mover o carro, certifique-se de que desbloqueia os rodízios.

- Risco de dedos trilhados! Mantenha os dedos afastados dos componentes em movimento.

## Advertencias de uso

- Asegúrese de ensamblar este producto según las instrucciones.
- Lea todo el manual y asegúrese de haber comprendido bien las instrucciones antes de proceder con el ensamblaje y el uso de este producto.
- Asegúrese de no exceder la capacidad de peso de este producto. La sobrecarga de este producto puede causar lesiones personales o daños en la propiedad.
- Capacidad de peso del soporte del monitor: 8 kg (17,6 lb)
- Capacidad de peso del soporte para computadora portátil: 4,5 kg (9,9 lb.)
- No permita que los niños se suban a este producto o que lo utilicen sin la debida supervisión de un adulto.
- El uso de este producto es solo para interiores y no debe utilizarse en exteriores.
- Cuando ensamble este producto, no apriete los tornillos más de lo debido. Si al apretar los tornillos siente resistencia, no los apriete más.
- Se requieren dos personas para el ensamblaje de este producto. No intente ensamblar este producto e instalar otros equipos sin la debida asistencia de otra persona.
- Antes de instalar equipos en este producto, asegúrese de haberlo ensamblado correctamente, a fin de que pueda soportar el peso del equipo que vaya a instalar.
- Antes de empezar a mover el carrito, asegúrese de haber desbloqueado las ruedas. Antes de empezar a mover el carrito, asegúrese de haber desbloqueado las ruedas.
- ¡Peligro de Aplastamiento! Mantenga sus dedos alejados de las partes móviles.

## Warnhinweise

- Beachten Sie bei der Montage dieses Produkts die Montageanweisungen.
- Bevor Sie dieses Produkt montieren und verwenden, lesen Sie das gesamte Handbuch und vergewissern Sie sich, dass Sie die Anweisungen verstanden haben.
- Überschreiten Sie nicht die Tragkraft dieses Produkts. Ein Überladen dieses Produkts kann zu Verletzungen oder zur Beschädigung des Produkts führen.
- Gewichtskapazität der Monitorhalterung: 8 kg (17,6 lb.)
- Belastbarkeit der Laptophalterung: 4,5 kg (9,9 lb.)



- Gestatten Sie Kindern nicht, auf das Produkt zu klettern oder das Produkt ohne Aufsicht zu benutzen.
- Dieses Produkt ist nur zum Gebrauch in Innenräumen vorgesehen und sollte nicht im Freien verwendet werden.
- Achten Sie bei der Montage des Produkts darauf, die Schrauben nicht zu fest anzuziehen. Sobald Sie beim Anziehen der Schrauben auf Widerstand stoßen, stellen Sie das Anziehen ein.
- Die Montage dieses Produkts ist auf die Ausführung von zwei Personen ausgelegt. Versuchen Sie nicht ohne Hilfe, dieses Produkt zu montieren und Geräte zu installieren.
- Bevor Sie Geräte zu diesem Produkt hinzufügen, vergewissern Sie sich, dass Sie es ordnungsgemäß montiert und installiert haben und dass das Produkt das Gewicht der Geräte, die Sie hinzufügen möchten, tragen kann.
- Stellen Sie sicher, dass die Rollen entriegelt sind, bevor Sie den Wagen in Bewegung setzen.
- Einklemmgefahr! Halten Sie Ihre Finger fern von beweglichen Teilen.

# Table of Contents

Compliance Statements .....	i
Safety Statements .....	ii
Warning Statements .....	iii
Product Diagram .....	1
Front View .....	1
Product Dimensions .....	2
Front View .....	2
Product Information .....	2
Requirements .....	2
Package Contents .....	3
Installation .....	5
Mounting Option #1 - Desk Mount .....	5
Attach the Pole Cap (H) to the Pole (G) .....	5
Attach the Pole (G) to the Mounting Surface .....	5
Mounting Option #2 - Grommet Mount .....	7
Assemble the Grommet Mount .....	7
Attach the Arms (B) to the Pole Assembly .....	8
Mount the Display .....	9
Attach the VESA Mount (A) to a Monitor .....	9
Attach the Monitor Mount Assembly to the Arm (B) .....	13
Attach the Laptop Tray (C) to the Pole Assembly .....	14
Attach the Laptop Arms .....	14

---

Attach the VESA Mount (A) to the Laptop Tray (C) .....	15
Attach the Laptop Mount Assembly to the Arm (B) .....	15
Mount the Laptop.....	16
Cable Management.....	17
Adjustment Tool Storage.....	17
<b>Operation .....</b>	<b>18</b>
Adjust the Tilt Angle of the Laptop/Monitor.....	18
Adjust the Swivel Angle of the Laptop/Monitor.....	19
Rotate the Monitor .....	19
<b>Warranty Information.....</b>	<b>20</b>

# Product Diagram

## Front View

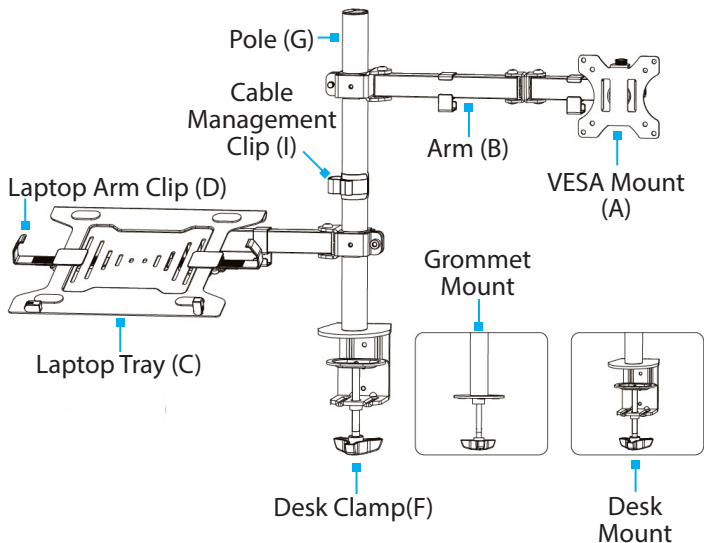

## Product Dimensions

### Front View

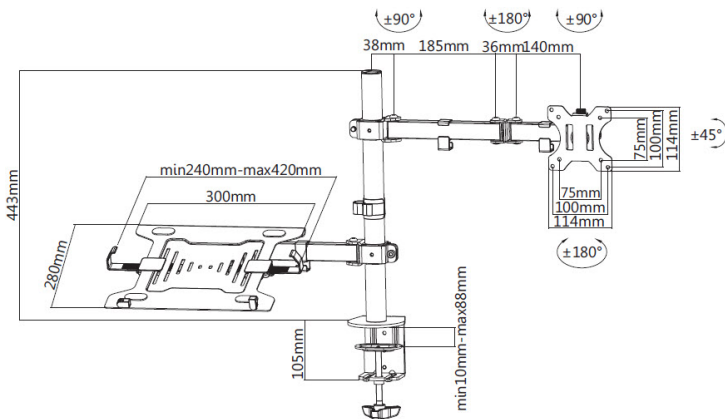

## Product Information









### Requirements

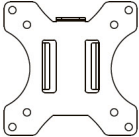



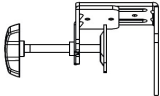

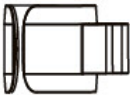
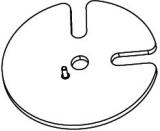



For the latest manuals, product information, technical specifications, and Declarations of Conformance, please visit:  
[www.StarTech.com/A2-LAPTOP-DESK-MOUNT](http://www.StarTech.com/A2-LAPTOP-DESK-MOUNT)

- Phillips Head Screwdriver

## Package Contents

**Note:** The following images are not to scale.

 <p>VESA Mounts (A) Qty: 2</p>	 <p>Arms (B) Qty: 2</p>	 <p>Laptop Tray (C) Qty: 1</p>	 <p>Laptop Arm Clips (D) Qty: 2</p>
 <p>Laptop Arm Pads (E) Qty: 2</p>	 <p>Desk Clamp (F) Qty: 1</p>	 <p>Pole (G) Qty: 1</p>	 <p>Pole Cap (H) Qty: 1</p>
 <p>Cable Management Clip (I) Qty: 1</p>	 <p>Grommet Base Plate (J) Qty: 1</p>	 <p>Grommet Clamp Plate (K) Qty: 1</p>	 <p>Laptop Tray Mounting Screws (L) Qty: 4</p>

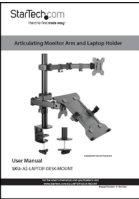
 <p>VESA Mount Knobs (M) Qty: 2</p>	 <p>Rubber Pads (N) Qty: 5</p>	 <p>Pole Mounting Screws (O) Qty: 3</p>	 <p>4 mm Hex Key (P) Qty: 1</p>
 <p>6 mm Hex Key (Q) Qty: 1</p>	 <p>M4 x 12 mm Screws (M-A) Qty: 8</p>	 <p>M4 x 16 mm Screws (M-B) Qty: 8</p>	 <p>M5 x 12 mm Screws (M-C) Qty: 8</p>
 <p>M5 x 16 mm Screws (M-D) Qty: 8</p>	 <p>Washers (M-E) Qty: 8</p>	 <p>Spacers (M-F) Qty: 8</p>	 <p>User Manual Qty: 1</p>

## Installation

**Note:** Do not overtighten any of the screws.

**Pinch hazards!** Keep hands away from any pinch points created by the mechanical components when moving the arm assembly. Failure to do so may result in serious personal injury.

### Mounting Option #1 - Desk Mount

#### Attach the Pole Cap (H) to the Pole (G)

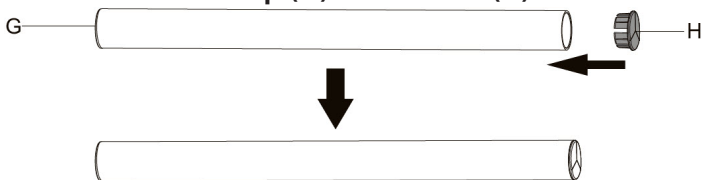

Figure 1

- Insert the **Pole Cap (H)** into the end of the **Pole (G)** that does not feature any screw holes.

(Figure 1)



## Attach the Pole (G) to the Mounting Surface

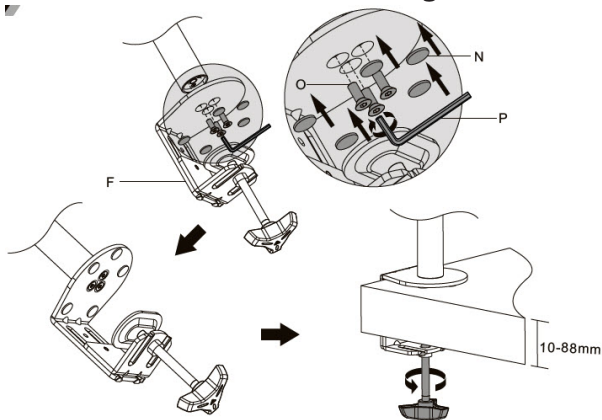

Figure 2

1. Align the holes in the **Desk Clamp (F)** with the holes in one end of the **Pole (G)**. (Figure 2)
2. Insert three **Pole Mounting Screws (O)** through the holes, located in the top of the **Desk Clamp (F)**, and into the **Pole (G)** and tighten, using the **4 mm Hex Key (P)**, to complete the **Desk Pole Assembly**.
3. Loosen the **Hand Screw**, located on the **Desk Pole Assembly**, until the **Desk Clamp** is wider than the thickness of the **Mounting Surface** (e.g. Desk or Table).
4. Slide the **Desk Pole Assembly Clamp** onto the **Mounting Surface**.
5. Tighten the **Hand Screw**, located on the **Desk Pole Assembly**, by hand, until hand-tight.

## Mounting Option #2 - Grommet Mount

### Assemble the Grommet Mount

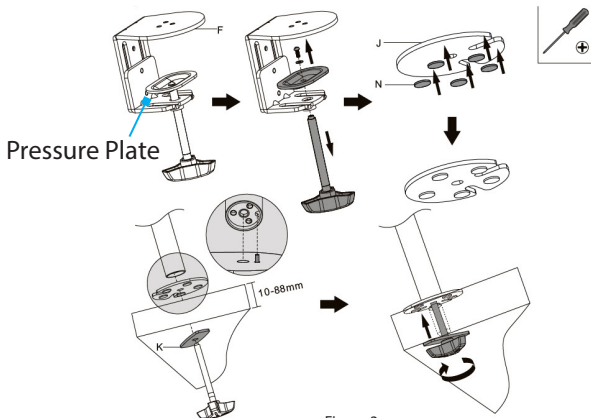
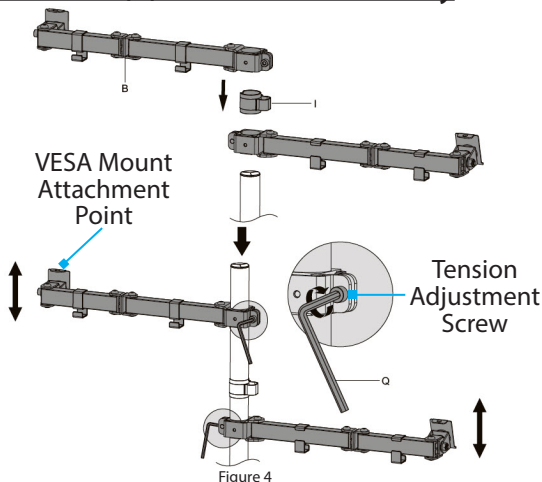

Figure 3

1. Remove the two **Screws**, located on the back of the **Desk Clamp (F)**, using the **4 mm Hex Key (P)**.
2. Remove the **Screw** that fastens **Pressure Plate** to the **Hand Screw**. (Figure 3)
3. Remove the **Pressure Plate** and **Washer**, and remove the **Hand Screw** from the **Desk Clamp (F)**.
4. Slide the **Grommet Clamp Plate (K)** over the end of the **Hand Screw**, completing the **Grommet Hand Screw**.
5. Affix the **Rubber Pads (N)(x5)** to the side of the **Grommet Base Plate (J)** that does not feature the **Peg**.

6. Insert the **Peg**, located on the **Grommet Base Plate (J)**, into the non-threaded hole, located in the base of the **Pole (G)** and push to attach the two pieces, completing the **Grommet Pole Assembly**.
7. Align the **Grommet Pole Assembly** over the **Grommet Hole**.
8. Insert the **Grommet Hand Screw** through the bottom of the **Grommet Hole** and into the **Grommet Pole Assembly** and tighten, by hand, until hand tight.

## Attach the Arms (B) to the Pole Assembly



1. Slide one **Arm (B)** onto the **Pole Assembly**, ensuring the hole in the **VESA Mount Attachment Point** is oriented towards the top. (Figure 4)

2. Slide the **Cable Management Clip (I)** onto the **Pole Assembly**.
3. Slide the second **Arm (B)** onto the **Pole Assembly**, ensuring the hole in the **VESA Mount Attachment Point** is oriented towards the top.
4. Adjust the height of the **Arms (B)** to the desired mounting heights for the **Laptop** and **Display** and tighten the **Tension Adjustment Screws**, using the **6 mm Hex Key (Q)**.

## Mount the Display

### Attach the VESA Mount (A) to a Monitor

#### Non-Recessed Monitor VESA Holes

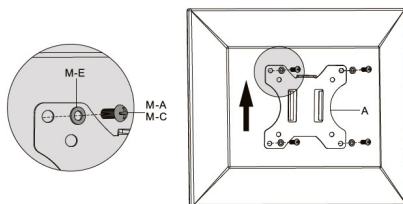

Figure 5

1. Place the **Monitor** screen side down on a flat, clean surface.
2. Remove any **Screws** or **Place Holders** from the **VESA Mounting Holes** on the back of the **Monitor**. (Figure 5)

**Note:** Be careful not to remove any of the **Screws** holding the **Monitor's Casing** together.

3. Align the **Screw Holes**, located on the **VESA Mount (A)**, with the **VESA Mounting Holes**, located on the back of the **Monitor**. The **VESA Mount** can support a 75 x 75 or 100 x 100 mounting pattern.

**Note** *When attached, the **VESA Attachment Tab**, located on the **VESA Mount (A)**, should be positioned toward the top of the **VESA Mount (A)**.*

4. Select the appropriate hardware for mounting the **VESA Mount** to the back of the **Monitor (M4 x 12 mm Screws (M-A), M4 x 16 mm Screws (M-B), M5 x 12 mm Screws (M-C), M4 x 16 mm Screws (M-D)**, or customer sourced screws).
5. Thread one **Washer (M-E)** over each appropriately sized **Screw** to complete the **Screw Assembly**.
6. Insert the four **Screw Assemblies** through the **Screw Holes** on the **VESA Mount (A)**, and into the **VESA Mounting Holes**, located on the back of the **Monitor**, and tighten, using a **Phillips Head Screwdriver**, to complete the **Monitor Mount Assembly**.

**Note:** *Do not over-tighten the **Screws**. If you encounter resistance while you're tightening the **Screws**, stop tightening. Failure to do so could result in damage to the **Monitor**.*

## Recessed Monitor VESA Holes

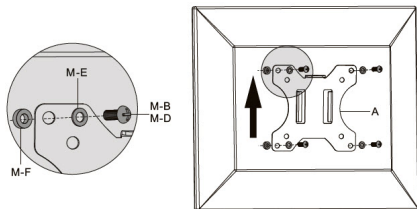

Figure 6

1. Place the **Monitor** screen side down on a flat, clean surface.
2. Remove any **Screws** or **Place Holders** from the **VESA Mounting Holes** on the back of the **Monitor**. (Figure 6)  
**Note:** *Be careful not to remove any of the **Screws** holding the **Monitor's Casing** together.*
3. Align the **Spacers (M-F)** with the **VESA Mounting Holes**, located on the back of the **Monitor**.
4. Align the **Screw Holes**, located on the **VESA Mount (A)**, with the **Spacers (M-F) / VESA Mounting Holes**, located on the back of the **Monitor**. The **VESA Mount** can support a 75 x 75 or 100 x 100 mounting pattern.

**Note** *When attached, the **VESA Attachment Tab**, located on the **VESA Mount (A)**, should be positioned toward the top of the **VESA Mount (A)**.*

5. Select the appropriate hardware for mounting the **VESA Mount** to the back of the **Monitor** (**M4 x 12 mm Screws (M-A)**, **M4 x 16 mm Screws (M-B)**, **M5 x 12 mm Screws (M-C)**, **M4 x 16 mm Screws (M-D)**, or customer sourced screws).
6. Thread one **Washer (M-E)** over each appropriately sized **Screw** to complete the **Screw Assembly**.
7. Insert the four **Screw Assemblies** through the **Screw Holes** on the **VESA Mount (A)**, the **Spacers (M-F)**, and into the **VESA Mounting Holes**, located on the back of the **Monitor**, and tighten, using a **Phillips Head Screwdriver**, to complete the **Monitor Mount Assembly**.

**Note:** Do not over-tighten the **Screws**. If you encounter resistance while you're tightening the **Screws**, stop tightening. Failure to do so could result in damage to the **Monitor**.

## Attach the Monitor Mount Assembly to the Arm (B)

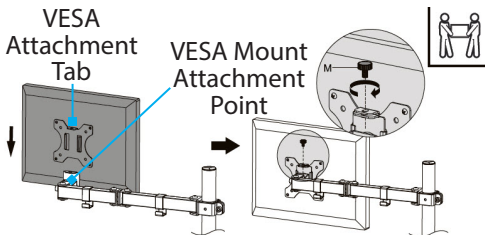

Figure 7

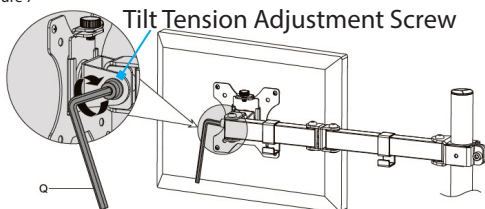

Figure 8

**Note:** It is recommended that two people mount the Monitor.

1. Tighten the **Tilt Tension Adjustment Screw**, located on the side of the **VESA Mount Attachment Point**, using the **6 mm Hex Key (Q)**, to prevent unwanted forward tilting of the **Monitor**.
2. Align the hole in the **VESA Attachment Tab**, located on the **VESA Mount (A)**, with the hole in the **VESA Mount Attachment Point**, located on the **Arm (B)**. (Figure 7)
3. Insert one **VESA Mount Knob (M)** through the hole in the **VESA Attachment Tab** and into the **VESA Mount Attachment Point** and tighten, by hand, until hand tight. (Figure 8)



## Attach the Laptop Tray (C) to the Pole Assembly

### Attach the Laptop Arms

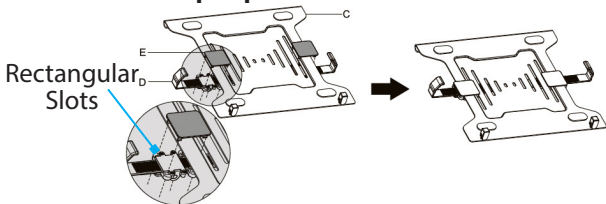

Figure 9

1. Unfold the **Laptop Holder Tabs**, located at the bottom-front of the **Laptop Tray (C)**. (Figure 9)
2. Position the **Laptop Arm Clips (D)** under the right and left-hand sides of the **Laptop Tray (C)**.
3. Align the **Small Tabs**, located on one of the **Laptop Arm Pads (E)**, with the **Rectangular Slots**, located on the **Laptop Arm Clip (D)** and the **Laptop Tray (C)**, and gently push the **Laptop Arm Pad (E)** into the **Rectangular Slots**.
4. Repeat step 4 to install the second **Laptop Arm Clip (D)**.
5. Adjust the position of the **Laptop Arm Clips (D)** to ensure the **Laptop Arm Clips (D)** will not impede access to any of the **Laptop's Side Ports**. To verify clear access, temporarily place the **Laptop** atop the **Laptop Tray (C)** and make adjustments to the **Laptop Arm Clips (D)** as necessary. Remove the **Laptop** before proceeding to the next step.

## Attach the VESA Mount (A) to the Laptop Tray (C)

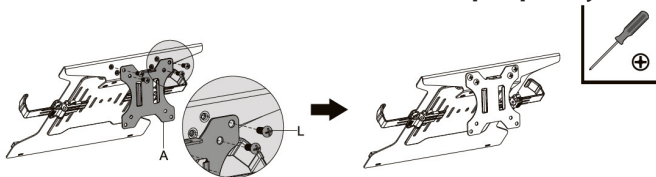

Figure 10

1. Align the four holes, located at the top-back of the **Laptop Tray (C)**, with the top four holes, located on the **VESA Mount (A)**. (Figure 10)
2. Insert four **Laptop Tray Mounting Screws (L)** through the holes, located in the **VESA Mount (A)** and into the **Laptop Tray (C)**, and tighten, using a **Phillips Head Screwdriver**, to complete the **Laptop Mount Assembly**.

## Attach the Laptop Mount Assembly to the Arm (B)

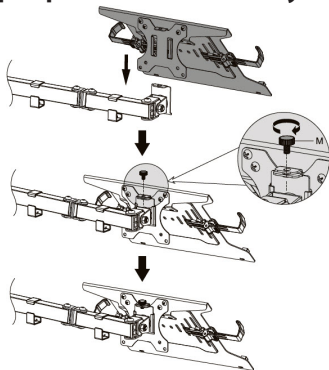

Figure 11

1. Align the hole in the **VESA Attachment Tab**, located on the **Laptop Mount Assembly**, with the hole in the **VESA Mount Attachment Point**, located on the **Arm (B)**. (Figure 11)
2. Insert one **VESA Mount Knob (M)** through the hole in the **Laptop Mount Assembly** and into the **VESA Mount Attachment Point** and tighten by hand, until hand tight.

## Mount the Laptop

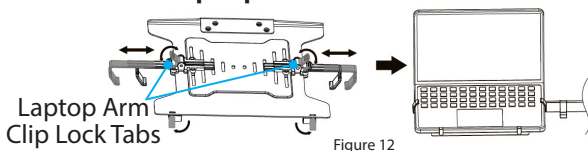

Figure 12

**Warning!** Ensure the **Laptop Mount Assembly** has been adjusted to a horizontal position before mounting a **Laptop**.

1. Unlock the **Laptop Arm Clip Lock Tabs**, located on the back of the **Laptop Mount Assembly**, and fully extend the **Laptop Arm Clips (D)**. (Figure 12)
2. Place a **Laptop** atop the **Laptop Mount Assembly** and collapse the **Laptop Arm Clips** inwards, until they are flush with the sides of the **Laptop**.
3. Lock the **Laptop Arm Clip Lock Tabs**.

## Cable Management

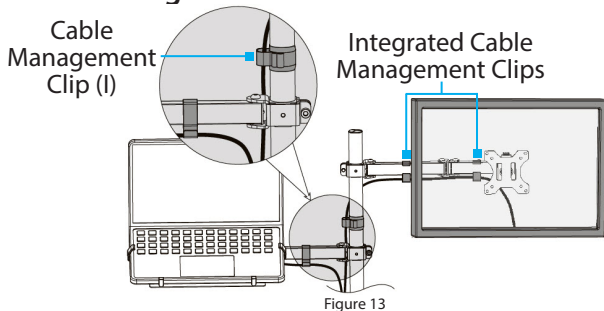

Figure 13

- Route the **Laptop/Monitor Cables** through the **Integrated Cable Management Clips**, located on the **Arms (B)**, and the **Cable Management Clip (I)**, located on the **Pole (G)**, and to their respective **Power/Video Sources**.(Figure 13)

## Adjustment Tool Storage

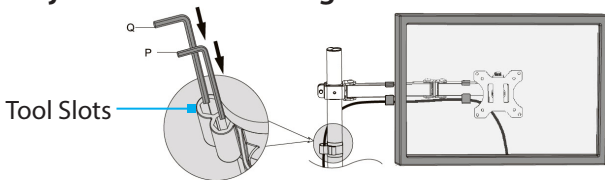

Figure 14

- Slide the **4 mm Hex Key (P)** and the **6 mm Hex Key (Q)** into the **Tool Slots**, located on the **Cable Management Clip (I)**. (Figure 14)

## Operation

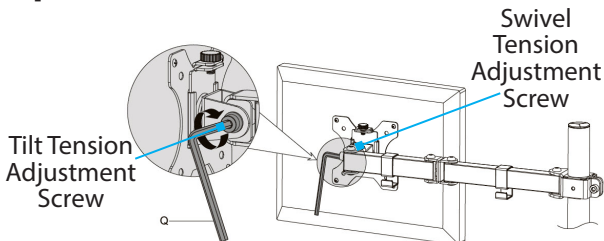

Figure 15

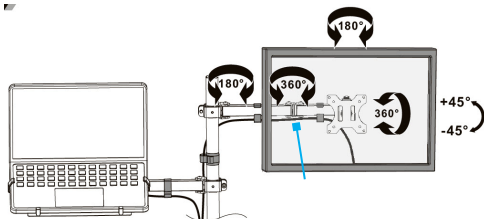

Figure 16

### Adjust the Tilt Angle of the Laptop/Monitor

- Loosen the **Tilt Tension Adjustment Screw**, located on the side of the **VESA Mount Attachment Point**, by 1/4 turns until adequately loose, make the desired adjustments to the tilt angle, and tighten the **Tilt Adjustment Screw**, using the **6 mm Hex Key (Q)**. (Figure 15)

**Note:** Hold the **Monitor** while adjusting the tilt angle.

## Adjust the Swivel Angle of the Laptop/Monitor VESA Mount Attachment Point

**Note:** Hold the **Monitor** while adjusting the swivel angle.

- Loosen the **Swivel Tension Adjustment Screw**, located on the top of the **VESA Mount Attachment Point**, by 1/4 turns until adequately loose, make the desired adjustments to the swivel angle, and tighten the **Swivel Adjustment Screw**, using the **6 mm Hex Key (Q)**.

### Articulation Point on the Arms (B)

**Note:** Remove the **Laptop** and hold the **Laptop Mount Assembly** and/or **Monitor** while adjusting the swivel angle.

- Adjust the swivel angle of the **Laptop Mount Assembly** or the **Monitor Mount Assembly** by hand. No tools are required to complete this adjustment.

### Rotate the Monitor

- Rotate the **Monitor** by hand. No tools are required to complete this adjustment.

## Warranty Information

This product is backed by a five-year warranty.

For further information on product warranty terms and conditions, please refer to [www.startech.com/warranty](http://www.startech.com/warranty).

## Limitation of Liability

In no event shall the liability of StarTech.com Ltd. and StarTech.com USA LLP (or their officers, directors, employees or agents) for any damages (whether direct or indirect, special, punitive, incidental, consequential, or otherwise), loss of profits, loss of business, or any pecuniary loss, arising out of or related to the use of the product exceed the actual price paid for the product.

Some states do not allow the exclusion or limitation of incidental or consequential damages. If such laws apply, the limitations or exclusions contained in this statement may not apply to you.

## Hard-to-find made easy. At StarTech.com, that isn't a slogan. It's a promise.

StarTech.com is your one-stop source for every connectivity part you need. From the latest technology to legacy products — and all the parts that bridge the old and new — we can help you find the parts that connect your solutions.

We make it easy to locate the parts, and we quickly deliver them wherever they need to go. Just talk to one of our tech advisors or visit our website. You'll be connected to the products you need in no time.

Visit [www.startech.com](http://www.startech.com) for complete information on all StarTech.com products and to access exclusive resources and time-saving tools.

StarTech.com is an ISO 9001 Registered manufacturer of connectivity and technology parts. StarTech.com was founded in 1985 and has operations in the United States, Canada, the United Kingdom and Taiwan servicing a worldwide market.

### Reviews

Share your experiences using StarTech.com products, including product applications and setup, what you love about the products, and areas for improvement.

#### StarTech.com Ltd.

45 Artisans Crescent  
London, Ontario  
N5V 5E9  
Canada

#### StarTech.com LLP

4490 South  
Hamilton Road  
Groveport, Ohio  
43125  
U.S.A.

#### StarTech.com Ltd.

Unit B, Pinnacle 15  
Gowerton Road  
Brackmills,  
Northampton  
NN4 7BW  
United Kingdom

#### StarTech.com Ltd.

Siriusdreef 17-27  
2132 WT  
Hoofddorp  
The Netherlands

FR: [fr.startech.com](http://fr.startech.com)

DE: [de.startech.com](http://de.startech.com)

ES: [es.startech.com](http://es.startech.com)

NL: [nl.startech.com](http://nl.startech.com)

IT: [it.startech.com](http://it.startech.com)

JP: [jp.startech.com](http://jp.startech.com)