

## Contents

<b>1</b>	<b>Instructions</b>	<b>34</b>
1.1	General safety instructions	34
1.2	Appliance purpose	38
1.6	Disposal	39
1.7	How to read the user manual	40
<b>2</b>	<b>Description</b>	<b>41</b>
2.1	General Description	41
2.2	Control panel	42
<b>3</b>	<b>Use</b>	<b>44</b>
3.1	Instructions	44
3.2	Preliminary operations	45
3.3	Using the hob	45
3.4	Special functions	50
3.5	Additional functions	51
3.6	Deactivating the hob power limitation	53
3.7	Error codes	54
<b>4</b>	<b>Cleaning and maintenance</b>	<b>55</b>
4.1	Instructions	55
4.2	Cleaning the surfaces	55
4.3	Ordinary weekly cleaning	55
4.4	Food stains or residues	55
4.5	What to do if...	56
<b>5</b>	<b>Installation</b>	<b>57</b>
5.1	Electrical connection	57
5.2	Safety instructions	58
5.3	Section cut from the countertop	58
5.4	Mounting	60
5.5	Instructions for the installer	61

### TRANSLATION OF THE ORIGINAL INSTRUCTIONS

We advise you to read this manual carefully, which contains all the instructions for maintaining the appliance's aesthetic and functional qualities.

For further information on the product: [www.smeg.com](http://www.smeg.com)



## 1 Instructions

### 1.1 General safety instructions

#### Risk of personal injury

- During use the appliance and its accessible parts become very hot.
- Never touch the heating elements during use.
- Protect your hands by wearing heat-proof gloves during use.
- Never try to put out a fire or flames with water: Turn off the appliance and smother the flames with a fire blanket or other appropriate cover.
- This appliance may be used by children aged at least 8 and by people of reduced physical, sensory or mental capacity, or lacking in experience in the use of electrical appliances, provided that they are supervised or instructed by adults who are responsible for their safety.
- Children must not play with the appliance.
- Keep children under the age of eight at a safe distance unless they are constantly supervised.
- Keep children under the age of 8 away from the appliance when it is in use.
- Cleaning and maintenance must not be carried out by unsupervised children.
- Be aware of how rapidly the cooking zones heat up. Do not let pans heat up when dry, as there is a danger of them overheating.
- Fats and oils can catch fire if they overheat. Do not leave the appliance unattended while preparing foods containing oils or fats. If fats or oils catch fire, never put water on them. Place the lid on the pan and turn off the relevant cooking zone.
- Do not use the Booster functions to heat fats or oils. Fire hazard.
- The cooking process must always be monitored. A short cooking process must be continuously monitored.



- Do not place metal objects, such as dishes or cutlery, on the hob surface during use as they may overheat.
- Do not insert pointed metal objects (cutlery or utensils) into the slots in the appliance.
- Do not pour water directly onto very hot trays.
- Do not use or store flammable materials near the appliance or directly underneath the hob.
- **DO NOT USE AEROSOLS IN THE VICINITY OF THIS APPLIANCE WHILST IT IS IN USE.**
- Switch off the appliance immediately after use.
- **DO NOT MODIFY THIS APPLIANCE.**
- Always use any necessary/required personal protective equipment (PPE) before performing any work on the appliance (installation, maintenance, positioning or movement).
- Before performing any work on the appliance, switch off the power supply.
- Installation and servicing should be carried out by qualified personnel in accordance with current standards.
- Do not try to repair the appliance yourself or without the assistance of a qualified technician.
- If the power supply cable is damaged, contact technical support immediately and they will replace it.

## **Risk of damaging the appliance**

- Do not use abrasive or corrosive detergents (e.g. scouring powders, stain removers and metallic sponges) on glass parts.
- Use wooden or plastic utensils.
- Do not sit on the appliance.
- Do not use the hob as a support surface.
- Do not obstruct ventilation openings and heat dispersal slots.
- Do not use steam jets to clean the appliance.
- Never leave the appliance unattended during cooking operations where fats or oils could be released, as these could then heat up and catch fire. Be very careful.



## Instructions

- Fire hazard: Never leave objects on the cooking surfaces.
- DO NOT FOR ANY REASON USE THE APPLIANCE AS A SPACE HEATER.
- Cooking vessels or griddle plates should be placed inside the perimeter of the hob.
- All pans must have smooth, flat bottoms.
- If any liquid does boil over or spill, remove the excess from the hob.
- Take care not to spill acid substances such as lemon juice or vinegar on the hob.
- Do not spill sugar or sweet mixtures on the hob during cooking.
- Do not place materials or substances that could melt or catch fire (paper, plastic or aluminium foil) on the appliance while it is in use.
- Place the cookware directly on the glass ceramic surface.
- Do not put empty pans or frying pans on switched on cooking zones.
- Do not use rough or abrasive materials or sharp metal scrapers.
- Do not use cleaning products containing chlorine, ammonia or bleach on parts made of steel or that have metallic surface finishes (e.g. anodizing, nickel- or chromium-plating).

### Installation

- THIS APPLIANCE **MUST NOT BE INSTALLED** IN BOATS OR CARAVANS.
- Position the appliance into the cabinet cut-out with the help of a second person.
- Check that the carcass material is heat resistant.
- Check that the carcass has the required openings.
- To avoid potential overheating, the appliance must not be installed behind a decorative door or a panel.
- Have the electrical connection performed by authorised technical personnel.
- The appliance must be connected to earth in compliance with electrical system safety standards.



- Use cables that can withstand temperatures of at least 90°C.
- The tightening torque of the screws of the terminal supply wires must be 1.5 - 2 Nm.
- The power cable must only be installed or replaced by a qualified technician.
- Activate the controls lock when you have children or pets which could reach the hob.
- After use the cooking zones remain hot for a certain period of time after they have been turned off. Do not touch the hob surfaces.
- After use, switch off the plates. Never rely solely on the cookware detector.

## For this appliance

- If cracks or fissures form, or if the glass ceramic cooking surface breaks, turn off the appliance immediately. Disconnect the power supply and call Technical Support.
- Avoid hard, solid objects falling on the cooking surface.
- Do not use the hob if the pyrolytic cycle is taking place inside any oven installed below.
- Do not touch or clean the hob surface during operation or when the residual heat indicator lights are still on.
- Supervise children carefully as they cannot readily see the residual heat indication. After use the cooking zones remain hot for a certain period of time even if they have been turned off. Keep children away from the cooking zones.
- The glass ceramic surface is highly resistant to impact. However, prevent hard, solid objects from falling on the cooking surface as they may cause it to break if they are sharp.
- Do not use the glass ceramic cooking surface as a support surface.
- Remove any traces of liquid from the cover (if fitted) before opening.



## Instructions

- Let the cooking surface cool down before closing the cover.
- People who have pacemakers or other similar devices fitted must make sure that the operation of these devices is not affected by the induction field, the frequency range of which is between 20 and 50 kHz.
- In conformity with the provisions regarding electromagnetic compatibility, the electromagnetic induction cooking hob comes under group 2 and class B (EN 55011).

### 1.2 Appliance purpose

- This appliance is intended for cooking food in the home environment. Every other use is considered improper.
- The appliance is not designed to operate with external timers or with remote-control systems.

### 1.3 Manufacturer's liability

- The manufacturer declines all liability for damage to persons or property caused by:
  - Use of the appliance other than that specified
  - Failure to comply with the instructions in the user manual
  - Tampering with any part of the appliance
  - The use of non-original spare parts.

### 1.4 Identification plate

The identification plate bears the technical data, serial number and brand name of the appliance. Do not remove the identification plate for any reason.

### 1.5 This user manual

This user manual is an integral part of the appliance and must therefore be kept in its entirety and within the user's reach for the whole working life of the appliance.

- Read this user manual carefully before using the appliance.



## 1.6 Disposal



This appliance conforms to the WEEE European directive (2012/19/EU) and must be disposed of separately from other waste at the end of its service life.

The appliance does not contain substances in quantities sufficient to be considered hazardous to health and the environment, in accordance with current European directives.

To dispose of the appliance:

- Cut the power supply cable and remove it along with the plug.



### Power voltage

### Danger of electrocution

- Disconnect the mains power supply.
- Unplug the appliance.

- Deliver the appliance to the appropriate recycling centre for electrical and electronic equipment waste, or return it to the retailer when purchasing an equivalent product, on a one for one basis.

Our appliances are packaged in non-polluting and recyclable materials.

- Deliver the packing materials to the appropriate recycling centre.



### Plastic packaging

### Danger of suffocation

- Do not leave the packaging or any part of it unattended.
- Do not let children play with the plastic bags.



# Instructions

## 1.7 How to read the user manual

This user manual uses the following reading conventions:

### Instructions



General information on this user manual, on safety and final disposal.

### Description



Description of the appliance and its accessories.

### Use



Information on the use of the appliance and its accessories, cooking advice.

### Cleaning and maintenance



Information for proper cleaning and maintenance of the appliance.

### Installation



Information for the qualified technician: Installation, operation and inspection.



Safety instructions



Information



Advice

1. Sequence of instructions for use.

- Standalone instruction.





## 2 Description

### 2.1 General Description

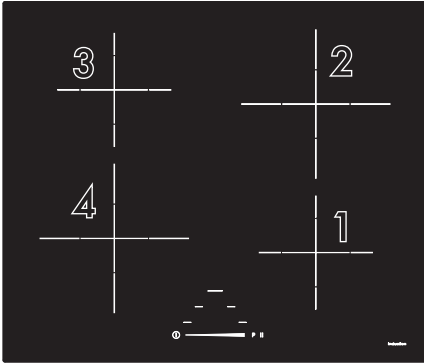

60 cm with straight edge

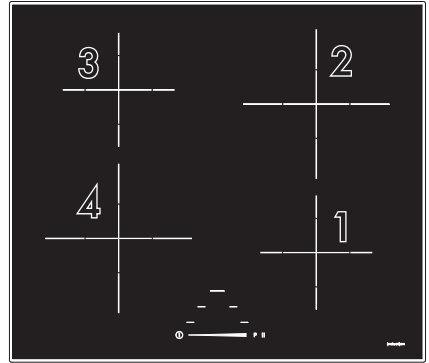

60 cm with bevelled edge

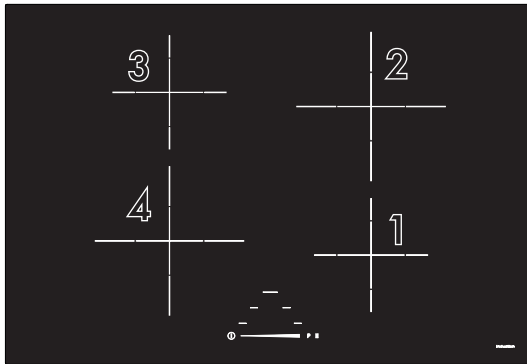

75 cm with straight edge

### Maximum absorbed power\* (Watt) table

	H x L (mm)	Level 9	Booster
Zones 1 - 3	160 x 160	1400	2100
Zones 2 - 4	210 x 210	2300	3000

\* power levels are approximate and may vary according to the pan used or the settings made.



## Description

### 2.2 Control panel

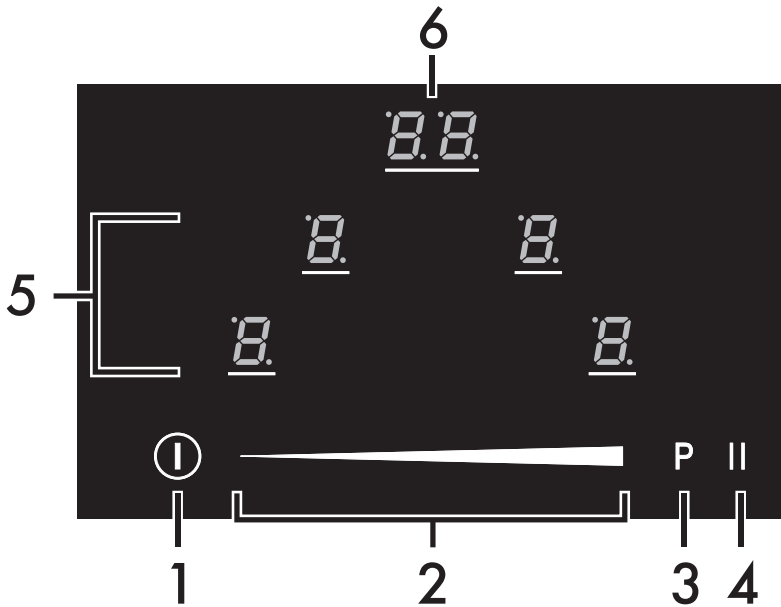

1 On/Off button

2 Scroll bar

3 Booster function button

4 Pause button

5 Cooking zones selection area

6 Timer setting area

### Advantages of induction cooking

**i**

The appliance is equipped with an induction generator for each cooking zone. Each generator located under the glass ceramic cooking surface creates an electromagnetic field which induces a thermal current in the base of the pan. This means the heat is no longer transmitted from the hob to the pan but created directly inside the pan by the inductive current.

- Energy saving thanks to the direct transmission of energy to the pan (suitable magnetisable cookware is required) compared to traditional electric cooking.
- Improved safety as the energy is only transmitted to the pan placed on the hob.
- High level of energy transmitted from the induction cooking zone to the base of the pan.
- Rapid heating speed.
- Reduced danger of burns as the cooking surface is only heated under the base of the pan; foods which overflow do not stick.



## Power control

The hob is fitted with a power control module that optimises/limits consumption. If the overall set power level exceeds the maximum limit permitted, the electronic circuit board will automatically manage the power supplied by the hot plates.

The module tries to maintain the maximum deliverable power levels. Levels set by the automatic control will appear on the display.



Priority is given to the first zone that is set.



The power control module does not affect the total power consumption of the appliance.

## List of symbols



On/Off button: turns the hob on or off.



Booster function button: activates maximum power.



Pause button: pauses cooking.

Scroll bar: increases or decreases the power level of a cooking zone.



## Cooking zones selection area



The buttons for selecting the cooking zones are located in this area.

## Timer setting area



The controls for setting the independent timer and the timer for the cooking zones are located in this area.

During normal operation, the letters "CL" are shown in the timer setting area to indicate that the minute minder timer controls are available.



## 3 Use

### 3.1 Instructions



#### High temperature Danger of burns

- Protect your hands by wearing heat-proof gloves during use.
- Do not touch or clean the hob surface during operation or when the residual heat indicator lights are still on.
- Do not put empty pans or frying pans on switched on cooking zones.
- Keep children under the age of 8 away from the appliance when it is in use.
- Activate the controls lock when you have children or pets which could reach the hob.
- After use the cooking zones remain hot for a certain period of time after they have been turned off. Do not touch the hob surfaces.



#### High temperature Danger of fire or explosion

- Do not use or leave flammable materials near the appliance or directly underneath the hob.
- Do not cook in closed tins or containers, plastic kitchenware or containers.
- Do not leave the appliance unattended during cooking operations where fats or oils could be released.
- In case you notice cracks or fissures or you cannot turn off the appliance, disconnect the power supply and contact the Assistance Centre.



#### Improper use Risk of damage to surfaces

- Do not use the hob if the pyrolytic cycle is taking place inside any oven installed below.
- Never place pans with bases which are not perfectly flat and smooth.
- Avoid hard, solid objects falling on the cooking surface.
- Do not use the hob as a support surface.



### 3.2 Preliminary operations

In order to remove any moisture that could have accumulated during the manufacturing process and for the electronic circuits and control keypad to work properly:

1. Remove the protective films from the external surfaces of the appliance and accessories.
2. Remove any labels (apart from the technical data plate).
3. Place a pan full of water on each of the front cooking zones and switch them on to the maximum power setting for at least 30 minutes.
4. After 30 minutes, switch off the front cooking zones and repeat this operation for the rear cooking zones and any central cooking zone.
5. If after carrying out the above operations the controls do not work properly, it might be necessary to extend the operations until the moisture has completely evaporated.

### 3.3 Using the hob

#### Switching on the hob for the first time



On first connection to the electrical mains, an automatic check will be carried out that will switch on all indicator lights for a few seconds.

All the appliance's control and monitoring devices are located together on the front panel. The induction hob is controlled by means of the Touch control sensor buttons. Lightly touch a symbol on the glass ceramic surface. A beep will sound to confirm every effective touch.

#### Minimum cookware diameter

Make sure that the minimum diameter of the pans are those indicated in the following table, for both configurations.

Zones	Ø minimum (cm)
Zones 1 - 3	7 - 9
Zones 2 - 4	9 - 11

Bear in mind the following:

- Do not exceed the limits indicated by the cross printed on the hob.
- Do not cover the control panel.
- Do not place the pans next to the edges of the glass.

#### Cookware suitable for use in induction cooking

Cookware used on the induction cooking surface must be made of metal, with magnetic properties and a sufficiently large base.



# Use

## Suitable cookware:

- Enamelled steel cookware with thick bases.
- Cast iron cookware with an enamelled base.
- Cookware in multilayer stainless steel, ferritic stainless steel and aluminium with a special base.

## Unsuitable cookware:

- Copper, stainless steel, aluminium, fireproof glass, wood, ceramic and terracotta cookware.

To see whether the pan is suitable, bring a magnet close to the bottom: if it is attracted, the pan is suitable for induction cooking.

If you do not have a magnet, you can put a small amount of water in the pan, place it on a cooking zone and start the hot plate.

If the  symbol appears on the display, it means the pan is not suitable.

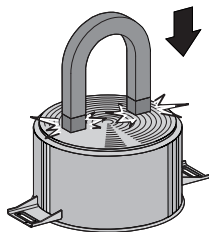

Use only cookware with a perfectly flat bottom which is suitable for induction hot plates. Using cookware with an irregular bottom could jeopardise the efficiency of the heating system and prevent cookware from being detected on the hot plate.



Make sure that the pans do not cover the control panel.

## Limiting the cooking duration

The hob has an automatic device which limits the duration of use.

If the cooking zone settings are not changed, the maximum duration of operation for each zone depends on the power level selected.

When the device for limiting the duration of use is activated, the cooking zone turns off, a short alert sounds and, if the zone is hot,

the  symbol appears on the display.

Set power level	Maximum cooking duration in hours
1	6
2	6
3	5
4	5
5	4
6 - 7 - 8 - 9	1 ½

## Protection from overheating

If the hob is used on full power for a long period, the electronics will have trouble cooling down if the room temperature is high.

If the temperature of the internal electronic components exceeds the safety threshold, the appliance will switch off automatically and "ER21" will be displayed (see "Error codes").



### Advice on energy-saving

- The diameter of the base of the pan must not exceed the width of the silk-screened cooking zone.
- Pans must not be placed outside the perimeter of the hob or above the front control panel.
- When buying a pan, check whether the diameter indicated is that of the base or the top of the pan, as the top is almost always larger than the base.
- When preparing dishes with long cooking times, you can save time and energy by using a pressure cooker, which also helps to retain vitamins contained in the food.
- Make sure that the pressure cooker contains enough liquid as, if there is not enough and it overheats, this may cause damage to both the pressure cooker and the cooking zone.
- If possible, always cover pans with a suitable lid.
- Choose a pan suitable for the quantity of food to be cooked. A large, half-empty saucepan leads to a waste of energy.



Under certain circumstances, if the hob and the oven are being used at the same time, the maximum power limit that can be used by the electrical system might be exceeded.

### Power levels

The power in the cooking zone can be adjusted to various levels. The table shows the levels suitable for various types of cooking.

Power level	Suitable for:
0	OFF setting
1 - 2	Cooking small amounts of food (minimum power)
3 - 4	Cooking
5 - 6	Cooking large quantities of food, roasting larger portions
7 - 8	Roasting, slow frying with flour
9	Roasting
P	Roasting / Browning, cooking (maximum power)*

\* see Booster function

### Switching the hob on and off

Keep the On/Off button  pressed in for at least 1 second to activate the hob. Press it again for at least one second to deactivate it.



If no power setting is selected within 20 seconds, the hob is automatically deactivated.



## Use

### Switching on the cooking zone automatically



The hob is provided with an automatic pan sensing system.

After switching on the hob:

- Position a pan (suitable for induction cooking and not empty) on the cooking zone you wish to use.
- The button corresponding to the zone on which the container has been placed

turns on automatically and displays 

The first segment of the scroll bar will light up.

- Select the cooking zone by pressing the corresponding button (see "Cooking zones selection area").
- Once a zone has been selected, a dot appears in the lower right corner of the digit field: the power level shown is .

### Adjusting the cooking zone

After selecting a cooking zone:

1. Place a finger on the left-hand side of the scroll bar of the cooking zone to be used.



The power level is now



2. Move your finger to the left or right on the scroll bar to select the power level from



The display of the zone being used will indicate the selected power level.

### Switching off the cooking zone

1. Move your finger all the way to the left on the scroll bar of the cooking zone you wish to turn off.



The display of the zone being used indicates .



Hold the On/Off button  down for at least 2 seconds to switch off all cooking zones at the same time.





## Quick selection

**i** This function allows you to quickly set the cooking zones to the required power.

After switching on the hob and having selected a cooking zone:

1. Place a finger on the scroll bar at approximately the required power level.



2. Move your finger to the left or right to select the required cooking power.

## Residual heat



**Improper use**  
**Danger of burns**

- Supervise children carefully as they cannot easily see the residual heat indicator. The cooking zones remain hot for a certain period of time even after they have been turned off. Make sure that children never touch the hob.

If the cooking zone is still hot after being

switched off, the **H** symbol will be displayed on the display. The symbol disappears when the temperature falls below 65°C.

## Cooking guidelines

The table below shows the power values which can be set, together with the corresponding type of food. Settings may vary depending on the amount of food and consumer taste.

Power level	Suitable for:
1 - 2	Reheating food, keeping small amounts of water on the boil, and whipping up sauces with egg yolk or butter.
3 - 4	Cooking solid or liquid food, keeping water on the boil, defrosting deep-frozen food, cooking 2- or 3-egg omelettes, fruit and vegetables, various cooking processes.
5 - 7	Stewing meat, fish and vegetables, simmering food, making jams etc.
8-9	Cooking or frying meat, fish, steaks and liver; browning meat, fish, eggs, etc.
P	Bringing a large amount of water to the boil rapidly.



## 3.4 Special functions

### Pause function



This function pauses the operation of all the cooking zones.

To activate the Pause function:

1. Switch on at least one cooking zone.
2. Hold down the pause button .



 appears on the displays of all the cooking zones.



The pause function can be maintained for a maximum of 10 minutes, after which the appliance switches off.

To deactivate the Pause function:

1. Hold down the button . The pause symbol, which has just been pressed, starts to flash.
2. Immediately afterwards, press any button apart from the Pause button.
3. The pause function has now been deactivated and the previously set functions are restored.



The cooking time limitation and the residual heat indicators remain enabled during the Pause function.



When the power comes back on after a power failure, the pause function will be deactivated.

### Booster function



**Improper use  
Danger of burns**

- Do not use the Booster functions to heat fats or oils as they could catch fire.



This function allows you to use the maximum available power of the cooking zone in order to bring a large amount of water to the boil rapidly.

To activate the Booster function:

1. Switch on the hob and select a cooking zone.
2. Press the  button.

The display of the cooking zone used will turn on: the power value indicated is .





- The Booster function remains active for a maximum of 10 minutes, after which the power is reduced automatically to level 9.
- If the internal temperature is too high, the Booster function will be temporarily disabled.

To deactivate the Booster function, simply select any power level using the scroll bar.



## 3.5 Additional functions

### Controls lock

 This function allows you to disable all the buttons of the appliance, except for the  button.

This is useful when cleaning the appliance and to prevent functions being activated by mistake.

To activate the controls lock, carry out the following procedure within 10 seconds:

1. Press the front right cooking zone button and the  button at the same time.
2. Press the front right cooking zone button again.

 appears on the timer and cooking zone displays.

To deactivate the controls lock, carry out the following procedure within 10 seconds:

1. Press the front right cooking zone button and the  button at the same time.
2. Press the button  again.

After the controls have been unlocked, the appliance switches off.

### Rapid heating

 This function is not available for power level **9** or the Booster function.

The rapid heating function heats one cooking zone at maximum power for a limited time, after which it continues cooking at the set power level.

After selecting a cooking zone:

- Press and hold a power level (from **1** to **8**) for at least 3 seconds.
-  appears on the display of the cooking zone.
- After the heating time has elapsed, the cooking zone reverts to the previously selected power level.

This function can be deactivated by pressing and holding the set power level for at least 3 seconds, or by selecting a lower power level.

### Rapid heating times

Power level	Automatic heating time (minutes/seconds)
1	48 s
2	2 m 24 s
3	3 m 50 s
4	5 m 12 s
5	6 m 48 s
6	2 m
7	2 m 48 s
8	3 m 36 s



## Use

### Warming Function

**i** This function allows you to keep cooked food warm or to keep water on the boil.

To activate the Warming function, first turn on the hob, then:

1. Select a cooking zone.
2. Press the far left of the scroll bar, approximately between level 0 and level 1, to activate the function; the  symbol appears on the display of the selected cooking zone.

Select any power level to deactivate the Warming function.

Or press the  button.

**i** For safety reasons, the Warming function remains active for a maximum of 2 hours.

### Timer



**i** This function is used to set a timer that will emit a sound at the end of the pre-set time.

**i** A maximum of 99 minutes can be set.

After having switched on the hob, without having selected a cooking zone:

1. Touch the inside of the timer setting area.

2.  appears on the display.

3. Pressing again will cause the digit on the left to flash. It is now possible to set the minutes using the scroll bar (e.g. ).
4. When the digit on the left stops flashing, the tens of minutes (e.g. ) can be selected using the same procedure.
5. After a few seconds, the timer will start the countdown.
6. When the time elapses, a series of beeps will be emitted. This can be deactivated by pressing the timer area.



Using the minute minder does not stop the operation of the cooking zones but rather informs the user when the set minutes have run out.

### Timed cooking

**i** This function is used to program the automatic switch-off of each cooking zone at the end of a period of time.

**i** A maximum of 99 minutes can be set.

The timed cooking function can be activated when at least one cooking zone is switched on:

1. Select a power level.



- Follow the same procedure as for a minute minder timer.
- The  symbols appear in the corners of the timer setting area to indicate that the zones are timed.
- Timed cooking will start a few seconds after the last selection.
- When the time elapses, a series of beeps will be emitted. This can be deactivated by pressing the timer area.

 This function can be activated on multiple cooking zones at the same time.

### Modifying and deactivating the timer and timed cooking

To modify or deactivate the timer and timed cooking, simply press the timer setting area and follow the same procedure used for setting it in order to modify or zero the minutes.

### Recall Function

 This is used to restore some functions that have already been started after the appliance has been switched off unintentionally.

If the appliance is switched off unintentionally, carry out the following procedure within 6 seconds:

- Switch on the appliance.
- The  button starts to flash.

- Press the pause button  immediately to restore the functions that were previously active.



 This function restores the cooking zone, timer, rapid heating and controls lock functions. No other functions will be restored.

 The cooking zones with the Booster function will be brought to power level 9.

### 3.6 Deactivating the hob power limitation

 The induction hob is configured to operate at **7.4 kW**, but the power can be limited so that it will work at **6.0 kW, 5.5 kW, 5.0 kW, 4.5 kW, 4.0 kW, 3.5 kW, 2.8 kW** and **2.4 kW**.

With the appliance switched off:

- Press the  button for at least 3 seconds.
- The  symbols appear on the cooking zone displays.
- Press the buttons of any two cooking zones at the same time.
- The current power level  is shown in the timer setting area.



4. Press the right of the scroll bar to decrease the power and the left to increase it.

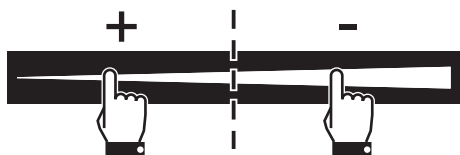

5. Press the  button to save the new setting; the hob will emit a sound and switch off.



After a minute of inactivity, the hob switches off automatically without saving any changes.

### 3.7 Error codes

If the appliance malfunctions or operates incorrectly, the associated error code appears on the cooking zones display.

The error codes always begin with "E.." or "Er..", followed by a number.

The following error codes can be corrected without having to contact the Technical Support Service.

- **Er03**: Remove any materials or pans from the area of the front control panel.
- **E3**: Make sure that the pans are suitable for induction cooking and that they are not empty; allow the appliance to cool down.

For all other errors, make a note of the code, if possible, and contact Technical Support.



## 4 Cleaning and maintenance

### 4.1 Instructions



**Improper use**  
**Risk of damage to surfaces**

- Do not use steam jets to clean the appliance.
- Do not spill sugar or sweet mixtures on the hob during cooking.
- Do not place materials or substances that could melt (plastic or aluminium foil).
- Keep sensor buttons clean at all times and do not rest any object on them.
- Do not use cleaning products containing chlorine, ammonia or bleach on parts made of steel or that have metallic surface finishes (e.g. anodizing, nickel- or chromium-plating).
- Do not use abrasive or corrosive detergents (e.g. scouring powders, stain removers and metallic sponges) on glass parts. Use wooden or plastic utensils.

### 4.2 Cleaning the surfaces

To keep the surfaces in good condition, they should be cleaned regularly after use. Let them cool first.

### 4.3 Ordinary weekly cleaning

Clean and maintain the hob once a week using an ordinary glass cleaning product. Always follow the manufacturer's instructions. The silicon in these products creates a protective, water-repellent membrane which also resists dirt. All marks stay on the membrane and can therefore be removed easily. After cleaning, dry the surface with a clean cloth. Make sure that there is no detergent left on the cooking surface as it will undergo a corrosive reaction when heated up and could modify the structure of the cooking surface.

### 4.4 Food stains or residues

Light coloured marks from pans with aluminium bases can be easily cleaned off with a cloth moistened in vinegar.

Remove any burnt-on residues after cooking; then rinse with water and dry thoroughly with a clean cloth.

**Dirt** which may have fallen on the hob while cleaning lettuce or potatoes can scratch the hob when moving pans. Consequently, remove any dirt from the cooking surface immediately.



## Cleaning and maintenance

**Changes in colour** do not affect the operation and stability of the glass. These are not alterations to the material of the hob but just residues which have not been removed and have then carbonised.

**Shiny surfaces** can form due to the bases of pans, especially aluminium ones, rubbing on the surface, and due to the use of unsuitable detergents. They are difficult to remove using conventional cleaning products. It may be necessary to repeat the cleaning process several times. Use of corrosive detergents or rubbing of pan bases can wear away the decoration on the hob over time and contribute to the formation of stains.

### 4.5 What to do if...

The hob does not work:

- Make sure that the hob is connected and that the main switch is turned on.
- Make sure that there is no power failure.
- Make sure that the fuse has not blown. In this case replace the fuse.
- Make sure that the circuit breaker of the residential electrical system has not tripped. In this case, reset the circuit breaker.

The cooking results are unsatisfactory:

- Make sure that the cooking temperature is not too high or too low.

The hob smokes:

- Let the hob cool down and clean it once cooking is complete.
- Make sure that the food has not spilled out of the pan and use a larger cooking vessel, if needed.

The fuses blow or the circuit breaker of the residential electrical system trips repeatedly.

- Call Technical Support or an electrician.

There are cracks or fissures in the hob:

- Turn off the appliance immediately, disconnect the power supply and contact Technical Support.





## 5 Installation

### 5.1 Electrical connection



**Power voltage  
Danger of electrocution**

- Have the electrical connection performed by authorised technical personnel.
- Use personal protective equipment.
- The appliance must be connected to earth in compliance with electrical system safety standards.
- Disconnect the mains supply.
- Do not pull the cable to unplug the appliance.
- Use cables withstanding a temperature of at least 90°C.
- The tightening torque of the screws of the terminal supply wires must be 1.5 - 2 Nm.

### General information

Check the grid characteristics against the data indicated on the plate.  
The identification plate bearing the technical data, serial number and brand name is visibly positioned on the appliance.  
Do not remove this plate for any reason.  
Perform the ground connection using a wire that is 20 mm longer than the other wires.

The appliance can be connected as follows:

- 220-240 V / 380-415 V 2N~

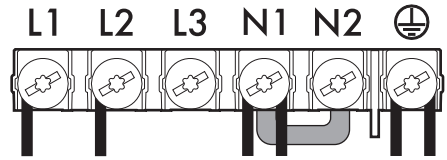

**6 x 1.5 mm<sup>2</sup> six-core cable.**

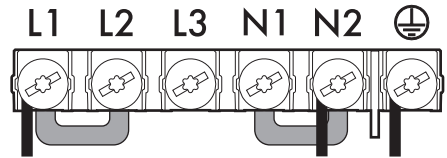

**3 x 6 mm<sup>2</sup> three-core cable.**



For all types of connection, use the jumper provided.

### Fixed connection

Fit the power line with an all-pole circuit breaker in compliance with installation regulations.

The circuit breaker should be located near the appliance and in an easily reachable position.



Run the power cable in the rear part of the unit. Make sure that it does not come into contact with the lower part of the hob or a built-in oven below it.



# Installation



Be careful when connecting additional electrical appliances. Connection cables must not come into contact with hot cooking zones.

## Testing

At the end of installation, carry out a brief inspection test. If the hob fails to operate, after checking that you have carried out the instructions correctly, unplug the appliance and contact Technical Support.

## 5.2 Safety instructions



**Heat production during appliance operation**  
**Risk of fire**

- Check that the carcass material is heat resistant.
- Check that the carcass has the required openings.
- Do not obstruct the ventilation grille in front of the product during mounting.

Veneers, adhesives or plastic coatings on adjacent furniture should be temperature-resistant (>90°C), otherwise they might warp over time.

The minimum clearance between exhaust hoods and the cooking surface must be at least the distance indicated in the exhaust hood installation instructions.

The minimum clearances must also be respected for the edges of the hob on the back as indicated in the mounting illustrations.

## 5.3 Section cut from the countertop



The following operation requires building and/or carpentry work and must therefore be carried out by a competent tradesman.

Installation can be carried out on various materials such as masonry, metal, solid wood or plastic laminated wood as long as they are heat resistant (>90°C).

Make a hole in the countertop of the unit according to the dimensions shown in the figure (mm).

### Mounting dimensions (models with bevelled edge)

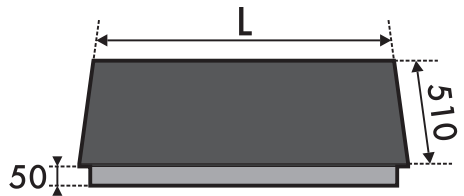

L	X	Y
600	560	478÷490

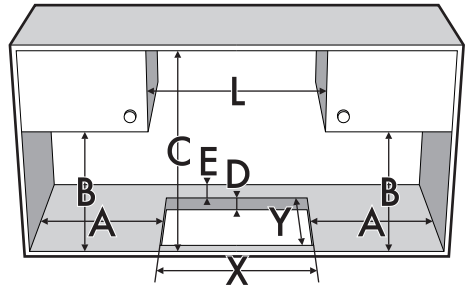

A	B	C	D	E
min. 50	min. 460	min. 750	20-60	min. 50



## Hob seal

To prevent leakage of liquid between the frame of the hob and the countertop, place the adhesive seal provided along the entire outer edge of the hob before assembly.

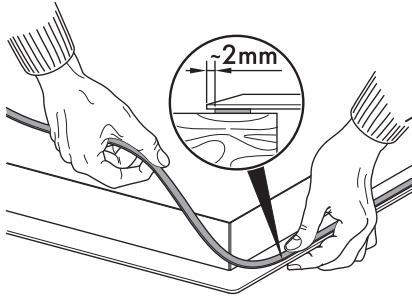

Do not use silicone to secure the hob. This would make it impossible to remove the hob, if necessary, without damaging it.

## Mounting dimensions (models with straight edge)

For this kind of hobs additional milling is needed in the recessed hole if you wish to install the hob flush with the work surface.

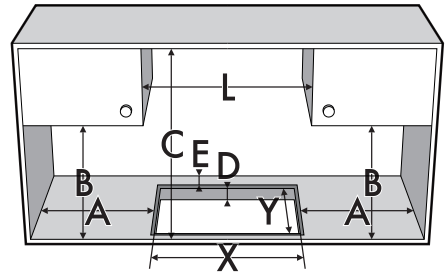
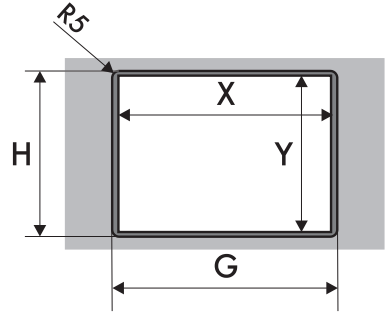
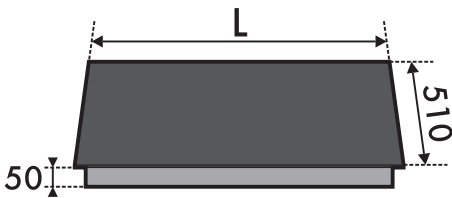

L	X	Y	G	H
600 - 750	560	478÷ 490	604	514
A	B	C	D	E
min. 50	min. 460	min. 750	20 - 60	min. 50

After laying the adhesive seal **(A)** on the glass surface and after positioning and securing the hob, fill the edges with insulating silicone **(B)** and wipe away any excess.

In the event the hob needs to be removed, cut the silicone using a cutter before attempting to remove it **(C)**.

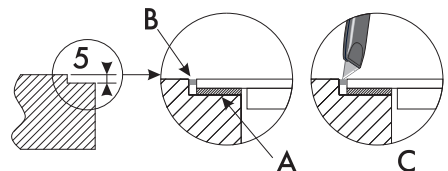



# Installation

## 5.4 Mounting

### Over built-in oven unit



If installed on top of an oven, the latter must be equipped with a cooling fan.

The clearance between the hob and the kitchen units or other built-in appliances must be enough to ensure sufficient ventilation and air discharge. If installed above an oven, a space must be left between the bottom of the hob and the top of the appliance installed below.

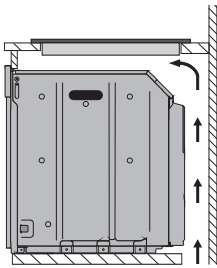

opens on bottom

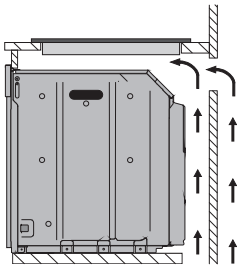

opens on bottom and on rear

### On top of an empty kitchen unit or drawers

If there are other pieces of furniture (lateral walls, drawers, etc.), dishwashers or fridges under the hob, a double-layer wooden base must be installed at least **20 mm** from the bottom of the hob to avoid any accidental contact. It must only be possible to remove the double-layer base using suitable equipment.

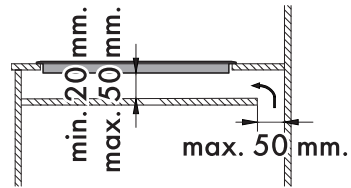
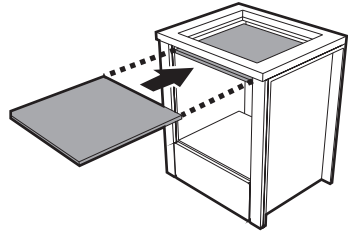

opens on bottom

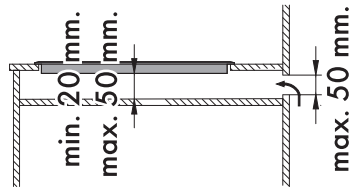

opens on rear



Failure to install the double-layer wooden base exposes the user to possible accidental contact with sharp or hot parts.



## Ventilation

The illustrations below show two examples of installation suitable for proper ventilation and one example of incorrect installation to be avoided.

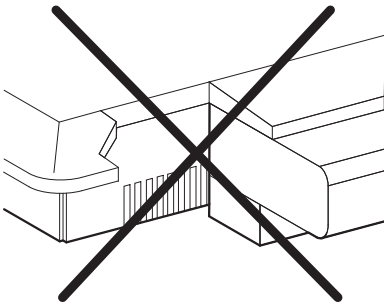
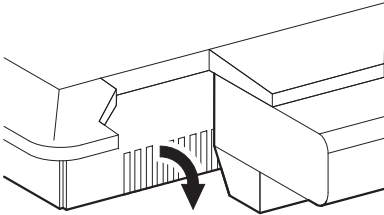
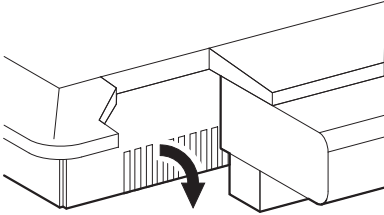

## Spring clips

To ensure the hob is fixed and centred as accurately as possible, the clips provided must be positioned as described below:

1. Fit the clips by gently pressing them horizontally into the appropriate space.

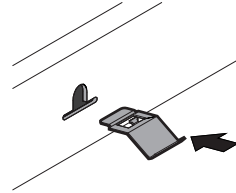

2. Then turn them upwards to fix them in place.

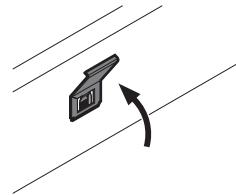

## 5.5 Instructions for the installer

- Do not bend or trap the power cable.
- The appliance must be installed according to the installation diagrams.
- If the appliance does not work correctly after having carried out all the checks, contact your local Authorised Service Centre.
- Once the appliance has been installed, please explain to the user how to use it correctly.



# Installation

## Position of slot for clips

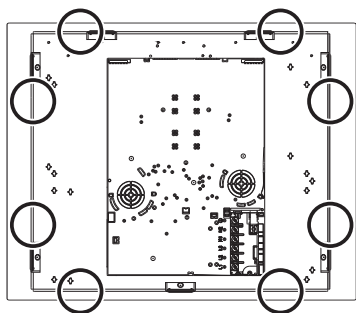

60 cm

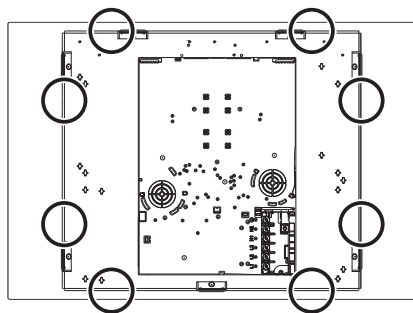

75 cm