

Contents

1	Instructions	46
1.1	General safety instructions	46
1.2	Appliance purpose	49
1.3	Manufacturer's liability	49
1.4	This user manual	50
1.5	Identification plate	50
1.6	Disposal	50
1.7	How to read the user manual	51
2	Description	52
2.1	General Description	52
2.2	Control panel	53
2.3	Other parts	54
2.4	Available accessories	55
3	Use	57
3.1	Instructions	57
3.2	First use	57
3.3	Using the accessories	58
3.4	Using the oven	59
3.5	Cooking advice	66
3.6	Special functions	68
3.7	Secondary menu	71
4	Cleaning and maintenance	74
4.1	Instructions	74
4.2	Cleaning the appliance	74
4.3	Removing the door	74
4.4	Cleaning the door glazing	75
4.5	Pyrolytic cycle	77
4.6	Extraordinary maintenance	79
5	Installation	81
5.1	Electrical connection	81
5.2	Cable replacement	81
5.3	Positioning	82

TRANSLATION OF THE ORIGINAL INSTRUCTIONS

We advise you to read this manual carefully, which contains all the instructions for maintaining the appliance's aesthetic and functional qualities.

For further information on the product: www.smeg.com

NE



Instructions

1 Instructions

1.1 General safety instructions

Risk of personal injury

- During use the appliance and its accessible parts become very hot. Never touch the heating elements during use.
- Protect your hands by wearing oven gloves when moving food inside the oven.
- Never try to put out a fire or flames with water: Turn off the appliance and smother the flames with a fire blanket or other appropriate cover.
- This appliance may be used by children aged at least 8 and by people of reduced physical, sensory or mental capacity, or lacking in experience in the use of electrical appliances, provided that they are supervised or instructed by adults who are responsible for their safety.
- Children must not play with the appliance.
- Keep children under the age of eight at a safe distance unless they are constantly supervised.
- Keep children under the age of 8 away from the appliance when it is in use.
- Cleaning and maintenance must not be carried out by unsupervised children.
- The cooking process must always be monitored. A short cooking process must be continuously monitored.
- Never leave the appliance unattended during cooking operations where fats or oils could be released, as these could then heat up and catch fire. Be very careful.
- Do not pour water directly onto very hot trays.
- Keep the oven door closed during cooking.
- If you need to move food or at the end of cooking, open the door 5 cm for a few seconds, let the steam come out, then open it fully.
- Do not insert pointed metal objects (cutlery or utensils) into the slots in the appliance.
- Switch off the appliance immediately after use.



- DO NOT USE OR STORE FLAMMABLE MATERIALS NEAR THE APPLIANCE.
- DO NOT USE AEROSOLS IN THE VICINITY OF THIS APPLIANCE WHILST IT IS IN USE.
- DO NOT MODIFY THIS APPLIANCE.
- Have qualified personnel carry out installation and assistance interventions according to the standards in force.
- Do not try to repair the appliance yourself or without the intervention of a qualified technician.
- Do not pull the cable to remove the plug.
- Switch off the burners or the electric hot plates of the hob installed above the appliance during the pyrolytic process (where available).
- Do not seat on the appliance.
- Do not use cleaning products containing chlorine, ammonia or bleach on parts made of steel or that have metallic surface finishes (e.g. anodizing, nickel- or chromium-plating).
- Racks and trays should be inserted as far as they will go into the side guides. The mechanical safety locks that prevent them from being removed must face downwards and towards the back of the oven cavity.

Risk of damaging the appliance

- Do not use abrasive or corrosive detergents (e.g. scouring powders, stain removers and metallic sponges) on glass parts. Use wooden or plastic utensils.
- Do not use rough or abrasive materials or sharp metal scrapers.
- Do not use steam jets to clean the appliance.
- Do not spray any spray products near the appliance.
- Do not obstruct ventilation openings and heat dispersal slots.
- Never leave objects on the cooking surface.
- DO NOT FOR ANY REASON USE THE APPLIANCE AS A SPACE HEATER.



Instructions

- Do not use plastic cookware or containers when cooking food.
- Do not put sealed tins or containers in the oven.
- Remove all trays and racks which are not required during cooking.
- Do not cover the bottom of the oven cavity with aluminium or tin foil sheets.
- Do not place pans or trays directly on the bottom of the oven cavity.
- If you wish to use greaseproof paper, place it so that it will not interfere with the hot air circulation inside the oven.
- Do not use the open door to rest pans or trays on the internal glass pane.
- Never use the oven door to lever the appliance into place when fitting.
- Avoid exerting too much pressure on the oven door when open.
- Do not use the handle to lift or move the appliance.

Installation and maintenance

- THIS APPLIANCE **MUST NOT BE INSTALLED** IN BOATS OR CARAVANS.
- The appliance must not be installed on a pedestal.
- Position the appliance into the cabinet cut-out with the help of a second person.
- To avoid potential overheating, the appliance must not be installed behind a decorative door or a panel.
- Have qualified personnel carry out installation and assistance interventions according to the standards in force.
- Have the electrical connection performed by authorised technical personnel.
- The appliance must be connected to earth in compliance with electrical system safety standards.
- Use cables withstanding a temperature of at least 90 °C.
- The tightening torque of the screws of the terminal supply wires must be 1.5 - 2 Nm.



- If the power supply cable is damaged, contact technical support immediately and they will replace it.
- Always use any necessary/required personal protective equipment (PPE) before performing any work on the appliance (installation, maintenance, positioning or movement).
- Before performing any work on the appliance, switch off the power supply.
- This appliance can be used up to a maximum altitude of 4,000 metres above sea level.

For this appliance

- Take care because steam may not be visible at certain temperatures.
- Open the appliance door carefully during or after cooking.
- Dishes must be heat and steam resistant.
- Ensure that the appliance is switched off before replacing the bulb.
- Do not rest any weight or sit on the open door of the appliance.

- Take care that no objects are stuck in the doors.
- Do not install / use the appliance outdoors.

1.2 Appliance purpose

- This appliance is intended for cooking food in the home environment. Every other use is considered improper.
- The appliance is not designed to operate with external timers or with remote-control systems.

1.3 Manufacturer's liability

The manufacturer declines all liability for damage to persons or property caused by:

- Use of the appliance other than that specified
- Failure to comply with the instructions in the user manual
- Tampering with any part of the appliance
- The use of non-original spare parts.



Instructions

1.4 This user manual

This user manual is an integral part of the appliance and must therefore be kept in its entirety and within the user's reach for the whole working life of the appliance.

Read this user manual carefully before using the appliance.

1.5 Identification plate

The identification plate bears the technical data, serial number and brand name of the appliance. Do not remove the identification plate for any reason.

1.6 Disposal



This appliance must be disposed of separately from other waste (Directives 2002/95/EC, 2002/96/EC, 2003/108/EC). The appliance does not contain substances in quantities sufficient to be considered hazardous to health and the environment, in accordance with current European directives.

To dispose of the appliance:

- Cut the power supply cable and remove it along with the plug.



Power voltage

Danger of electrocution

- Disconnect the mains power supply.
- Unplug the appliance.

- Deliver the appliance to the appropriate recycling centre for electrical and electronic equipment waste, or return it to the retailer when purchasing an equivalent product, on a one for one basis.

Our appliances are packaged in non-polluting and recyclable materials.

- Deliver the packing materials to the appropriate recycling centre.



Plastic packaging

Danger of suffocation

- Do not leave the packaging or any part of it unattended.
- Do not let children play with the plastic bags.



1.7 How to read the user manual

This user manual uses the following reading conventions:

Instructions



General information on this user manual, on safety and final disposal.

Description



Description of the appliance and its accessories.

Use



Information on the use of the appliance and its accessories, cooking advice.

Cleaning and maintenance



Information for proper cleaning and maintenance of the appliance.

Installation



Information for the qualified technician: Installation, operation and inspection.



Safety instructions



Information



Advice

1. Sequence of instructions for use.

- Standalone instruction.



Description

2 Description

2.1 General Description

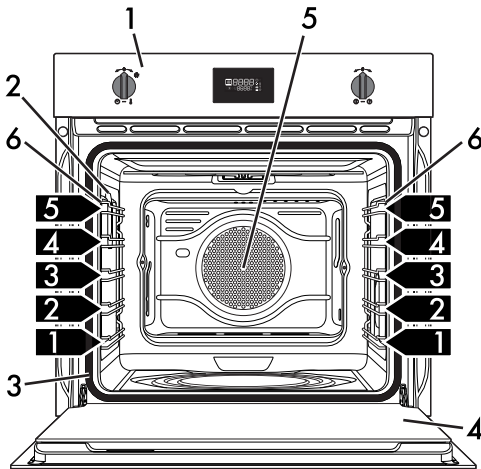

Multifunction/Pyrolytic models

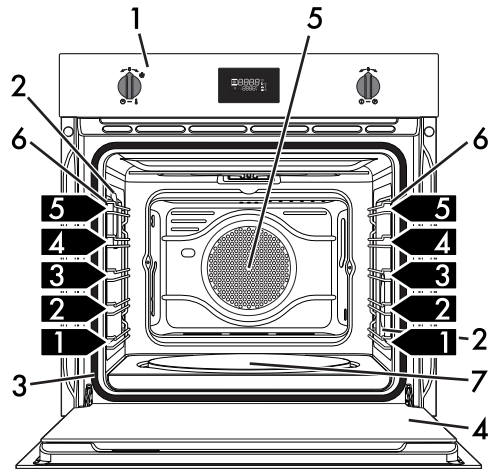

Models with pizza stone

1 Control panel

2 Oven light

3 Seal

4 Door

5 Fan

6 Rack/tray support frames

7 Pizza stone

1,2,3 Frame shelf



2.2 Control panel

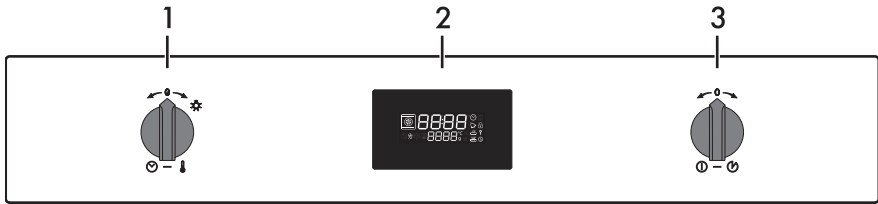

1 Programming knob

This knob can be used to select:

- The cooking temperature
- The duration of a function
- Programmed cooking procedures
- The current time
- The turning on or off of the light inside the appliance.

2 Display

Displays the current time, the selected cooking temperature, power and function and any time set.

3 Function knob

This knob can be used to:

- Turn the appliance on and off
- Select a function
- Temporarily start or stop a function.



Press and hold the function knob down for around 3 seconds to immediately terminate any cooking operation.



Description

2.3 Other parts

Interior lighting

The appliance's interior lighting comes on:

- When the door is opened (on some models only).
- When any function is selected, apart from the **Pyro**, **PECo** and **CLEA** functions (where present)
- When no function is selected, turn the programming knob briefly to the right to activate or deactivate internal lighting.

i In order to save energy, the light turns off after a minute at the start of cooking (this function can be deactivated via the secondary menu).

i When the door is open, it is not possible to turn off the interior lighting (on some models only).

Shelves

The appliance features shelves to position trays and racks at different heights. The insertion heights are indicated from the bottom upwards (see 2.1 General Description).

Cooling fan

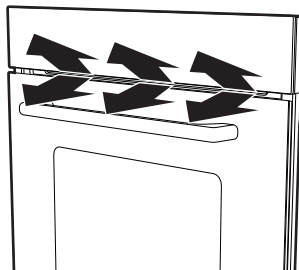

The fan cools the appliance and comes into operation during cooking.

The fan causes a steady outflow of air from above the door which may continue for a brief period of time even after the appliance has been turned off.



2.4 Available accessories



Some models are not provided with all accessories.

Rack

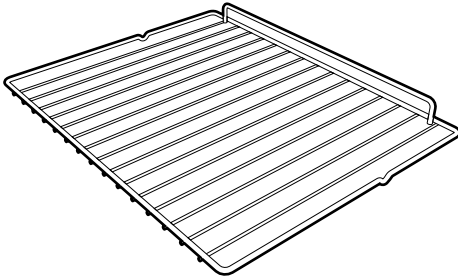

Useful for supporting containers with food during cooking.

Tray rack (on some models only)

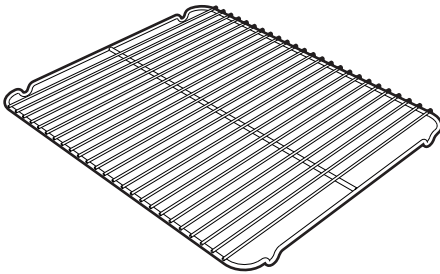

Deep tray

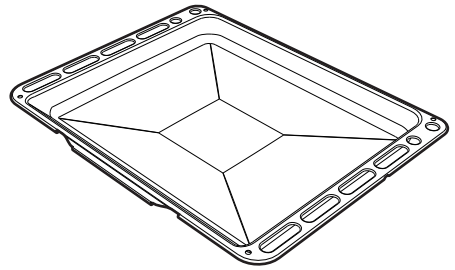

Useful for collecting fat from foods placed on the rack above and for cooking pies, pizzas and baked desserts.

Pizza stone (on some models only)

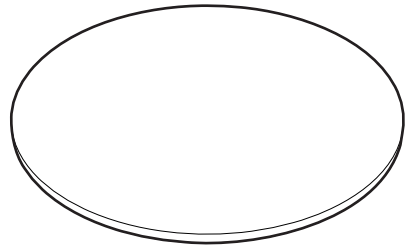

Specially designed for cooking pizza and similar dishes.

Pizza spatula (on some models only)

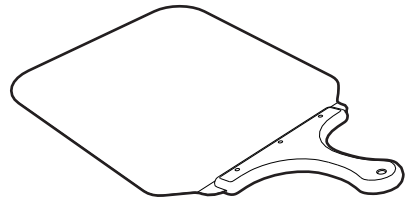

For easily placing the pizza on the pizza stone.



Description

Pizza stone cover (on some models only)

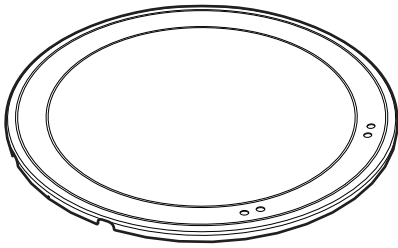

To be placed in the housing on the base of the oven in place of the pizza stone when this is not being used.



The appliance accessories intended to come into contact with food are made of materials that comply with the provisions of current legislation.



Original supplied and optional accessories can be requested to Authorised Assistance Centres. Use only original accessories supplied by the manufacturer.



3 Use

3.1 Instructions



High temperature inside the oven during use
Danger of burns

- Keep the oven door closed during cooking.
- Protect your hands by wearing oven gloves when moving food inside the oven.
- Do not touch the heating elements inside the oven.
- Do not pour water directly onto very hot trays.
- Do not allow children to approach the appliance when it is in operation.



Improper use
Risk of damage to surfaces

- Do not cover the bottom of the oven cavity with aluminium or tin foil sheets.
- If you wish to use greaseproof paper, place it so that it will not interfere with the hot air circulation inside the oven.
- Do not place pans or trays directly on the bottom of the oven cavity.
- Do not pour water directly onto very hot trays.



High temperature inside the oven during use
Danger of fire or explosion

- Do not spray any spray products near the appliance.
- Do not use or leave flammable materials near the appliance.
- Do not use plastic cookware or containers when cooking food.
- Do not put sealed tins or containers in the oven.
- Do not leave the appliance unattended during cooking operations where fats or oils could be released.
- Remove all trays and racks which are not required during cooking.

3.2 First use

1. Remove any protective film from the outside or inside of the appliance, including accessories.
2. Remove any labels (apart from the technical data plate) from the accessories and from the oven cavity.
3. Remove and wash all the appliance accessories (see 4 Cleaning and maintenance).
4. Heat the empty oven at the maximum temperature to burn off any residues left by the manufacturing process.



3.3 Using the accessories

Racks and trays

Racks and trays have to be inserted into the side guides until they come to a complete stop.

- The mechanical safety locks that prevent the rack from being removed accidentally must face downwards and towards the back of the oven cavity.

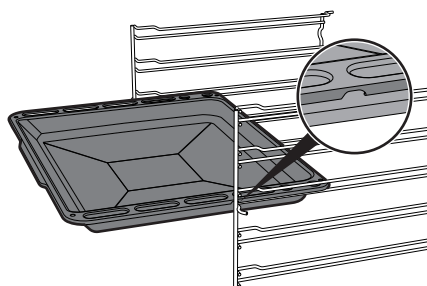
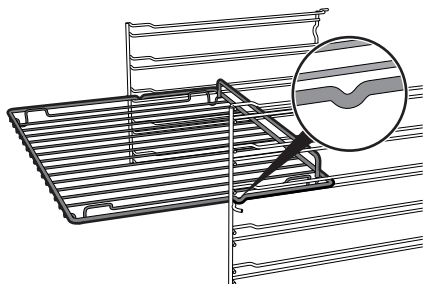

Gently insert racks and trays into the oven until they come to a stop.



Clean the trays before using them for the first time to remove any residues left by the manufacturing process.

Tray rack

The tray rack has to be inserted into the tray. In this way fat can be collected separately from the food which is being cooked.

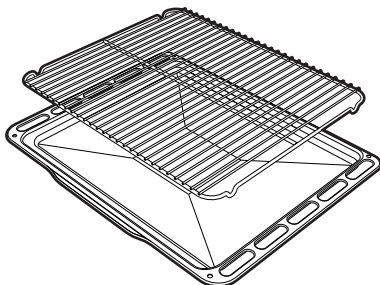

Cover and pizza stone (on some models only)



Improper use

Danger of burns and damage to surfaces

- The stone stays hot for many minutes after cooking has ended. Ensure it is handled with due caution.
- Do not use the pizza stone other than as described, for example do not use it on gas or glass ceramic hobs or in ovens which are not designed for this purpose.
- If you like oil on your pizza, it is best to add it after removal from the oven since oil stains on the pizza stone are unsightly and may reduce its efficiency.
- If the pizza stone is not in use, remove it from the oven and cover the bottom of the oven with the cover provided.



With the appliance cold, remove the cover from the bottom and insert the pizza stone. Make sure that the stone is inserted correctly in the recess provided. For cooking use the special pizza function .

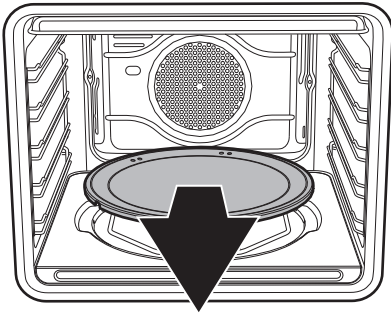

Pizza spatula (on some models only)

To avoid being burnt, always hold the pizza spatula by the handle when moving food. It is recommended to dust the steel surface lightly with flour to make it easier to slide fresh products on and off, as they could stick to the steel due to their moisture content.

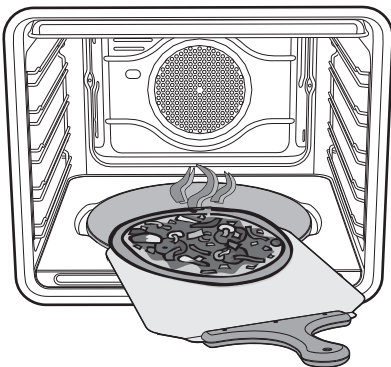

3.4 Using the oven

Switching on the oven

1. Press the function knob to turn on the display.
2. Turn the function knob to the right or left to select the required function.
3. Press the programming knob.
4. Turn the programming knob to set the temperature.
5. Press the programming knob or wait 3 seconds.
6. Press the function knob to start cooking.



Press and hold the function knob down for around 3 seconds to immediately terminate any cooking operation.

Preheating stage

Cooking itself is preceded by a preheating stage, which allows the appliance to heat to the cooking temperature more quickly.

The  light flashes to indicate that this stage is in progress.

When the preheating stage is over, the indicator light  will remain lit steadily and a buzzer will sound to indicate that the food can be placed inside the oven.



Cooking can be interrupted at any time by pressing and holding the function knob down for at least 3 seconds.



List of cooking functions



Eco

This function is particularly suitable for cooking on a single shelf with low energy consumption.

It is recommended for all types of food except those that may produce a large amount of moisture (e.g. vegetables).

To obtain maximum energy savings and reduce cooking times, it is recommended to place food in the oven without preheating.



When using the ECO function, avoid opening the door during cooking.



Cooking (and preheating) times are longer with the ECO function and may depend on the amount of food in the oven cavity.



The ECO function is a delicate cooking function and is recommended for cooking that does not require temperatures higher than 210°C. It is recommended that you select a different function for cooking at higher temperatures.



Static

As the heat comes from above and below at the same time, this system is particularly suitable for certain types of food. Traditional cooking, also known as static cooking, is suitable for cooking just one dish at a time. Perfect for all types of roasts, bread and cakes, and in any case, particularly suitable for fatty meats such as goose and duck.



Grill

The heat coming from the grill element gives perfect grilling results above all for thin and medium thickness meat and, in combination with the rotisserie (where fitted), gives the food an even browning at the end of cooking. Perfect for sausages, spare ribs and bacon. This function enables large quantities of food, particularly meat, to be grilled evenly.



Lower element

The heat coming just from the bottom allows you to complete the cooking of foods that require a higher bottom temperature, without affecting their browning. Perfect for cakes, pies, tarts and pizzas.



Fan assisted (on some models only)

The operation of the fan, combined with traditional cooking, ensures consistent cooking even with complex recipes. Perfect for biscuits and cakes, even when simultaneously cooked on several levels. (For multiple-level cooking, we recommend using the 2nd and 4th shelf).



Fan with grill

The air produced by the fan softens the strong heatwave generated by the grill, grilling perfectly even very thick foods. Perfect for large cuts of meat (e.g. shin of pork).



Fan + lower element

The combination of the fan with just the lower heating element allows cooking to be completed more rapidly. This system is recommended for sterilising or for finishing off the cooking of foods which are already well-cooked on the surface, but not inside, which therefore need a little more heat. Perfect for any type of food.

In pyrolytic models, the special defrost and proving functions are brought together under the same function.



Turbo (on some models only)

The combination of fan assisted cooking and traditional cooking allows different foods to be cooked on several levels extremely quickly and efficiently, without odours and flavours mingling. Perfect for large volumes that call for intense cooking. (For multiple-level cooking, we recommend using the 1st and 4th shelf.)



Circulaire (on some models only)

The combination of the fan and the circulaire heating element (incorporated in the rear of the oven) allows you to cook different foods on several levels, as long as they need the same temperatures and same type of cooking. Hot air circulation ensures instant and even distribution of heat. It will be possible, for instance, to cook fish, vegetables and biscuits simultaneously (on different levels) without odours and flavours mingling.



Pizza (on some models only)







The operation of the fan, combined with the grill and the lower heating element, ensures uniform cooking even with complex recipes. Perfect not just for pizzas, but also for biscuits and cakes.



Use

Display



-  Clock indicator light
-  Minute minder timer indicator light
-  Programmed cooking indicator light
-  Timed cooking indicator light
-  Door lock indicator light
-  Child lock indicator light
-  Showroom indicator light

Operating modes





Standby: When no function is selected, the display shows the current time.



ON: When a function is activated, the display shows the parameters set such as temperature, duration and temperature reached.



Each time the programming knob is pressed during a function, the parameters will be cycled through in the following order.

-  °C Temperature
-  Minute minder timer duration
-  Programmed cooking duration
-  Timed cooking duration
-  Current time display

In all states it is possible to modify the value by turning the programming knob to the left or right. Keep the knob turned to produce a faster increase or decrease.



Setting the time

When the appliance is used for the first time or after a power failure, **00:00** will flash on the display. To be able to start any cooking function, the current time must be set.

1. Turn the programming knob to set the displayed hour (keep the knob turned to produce a faster increase or decrease).
2. Press the programming knob.
3. Turn the programming knob to set the minutes (keep the knob turned to produce a faster increase or decrease).
4. Press the programming knob to complete the setting.



It may be necessary to change the current time, for example for daylight saving time. From the stand-by position, keep the programming knob turned to the right or left until the hours flash.

It is not possible to change the time if the oven is **ON**.

Minute minder





This function only activates the buzzer, without stopping cooking.



The minute minder can be activated both during cooking and when the appliance is in standby.

1. Press the programming knob once (twice if cooking is already in progress). The display shows **00:00** and the  indicator light flashes.



2. Turn the programming knob to set the duration (from 1 minute to 4 hours). After a few seconds, the  indicator stops flashing and the countdown starts.
3. Wait for the buzzer to indicate that the time has finished. The  indicator flashes.
4. Turn the programming knob to select another minute minder. Or else press the programming knob to stop the buzzer.



Use

Timed cooking

i Timed cooking is the function which allows a cooking operation to be started and then ended after a specific length of time set by the user.

i Activation of timed cooking cancels any minute minder timer which may previously have been set.

1. After selecting a cooking function and temperature, press the programming knob three times. The display indicates **00:00** and the  indicator light flashes.



2. Turn the programming knob to set the cooking time from 00:01 to 13:00. Keep the knob turned to produce a faster increase or decrease.





3. A few seconds after the required duration is set, the  indicator light stops flashing. Press the function knob to start timed cooking.

4. At the end of the cooking, STOP flashes on the display and a buzzer will sound that can be deactivated by opening the door or pressing/turning one of the two knobs.



 To select a further timed cooking, turn the programming knob right or left again.

 To extend the cooking time manually, press the programming knob again. The appliance will resume its normal operation with the previously selected cooking settings.

 When cooking has finished, it is possible to select a new function by rotating the function knob.

 Press and hold the function knob down to switch off the appliance.



Programmed cooking

i Programmed cooking is the function which allows a cooking operation to be stopped automatically at an established time depending on the time set by the user, after which the oven will switch off automatically.

1. After selecting a cooking function and temperature, press the programming knob three times. The display indicates **00:00** and the  indicator flashes.



2. Turn the knob to set the cooking time from 00:01 to 13:00. Keep the knob turned to increase or decrease it more quickly.



3. Press the programming knob a fourth time. The  indicator light flashes. Turn the knob to set the cooking end time.

4. After a few seconds the indicator lights  and  stop flashing. The appliance waits for the set start time.



5. At the end of the cooking, STOP flashes on the display and a buzzer will sound that can be deactivated by opening the door or pressing/turning one of the two knobs.



To extend the cooking time manually, press the programming knob again. The appliance will resume its normal operation with the previously selected cooking settings.



Press and hold the function knob down to switch off the appliance.



For safety reasons, it is not possible to set the end of cooking time by itself without setting the cooking duration.



3.5 Cooking advice

General advice

- Use a fan assisted function to achieve consistent cooking at several levels.
- It is not possible to shorten cooking times by increasing the temperature (the food could be overcooked on the outside and undercooked on the inside).

Advice for cooking meat

- Cooking times vary according to the thickness and quality of the food and to consumer taste.
- Use a meat thermometer when roasting meat, or simply press on the roast with a spoon. If it is hard, it is ready; If not, it needs another few minutes cooking.

Advice for cooking with the Grill and the Fan with grill

- Meat can be grilled even when it is put into the cold oven or into the preheated oven if you wish to change the effect of the cooking.
- With the Fan with grill function, we recommend that you preheat the oven before grilling.
- We recommend placing the food at the centre of the rack.
- With the Grill function, we recommend that you set the temperature to the maximum value to optimise cooking.

Advice for cooking desserts/pastries and biscuits

- Use dark metal moulds: They help to absorb the heat better.
- The temperature and the cooking time depend on the quality and consistency of the dough.

- To check whether the dessert is cooked right through: At the end of the cooking time, put a toothpick into the highest point of the dessert. If the dough does not stick to the toothpick, the dessert is cooked.
- If the dessert collapses when it comes out of the oven, on the next occasion reduce the set temperature by about 10°C, selecting a longer cooking time if necessary.

Advice for defrosting and proving

- Place frozen foods without their packaging in a lidless container on the first shelf of the oven.
- Avoid overlapping the food.
- To defrost meat, use the rack placed on the second level and a tray on the first level. In this way, the liquid from the defrosting food drains away from the food.
- The most delicate parts can be covered with aluminium foil.
- For successful proving, a container of water should be placed in the bottom of the oven.

To save energy

- Stop cooking a few minutes before the time normally used. Cooking will continue for the remaining minutes with the heat which has accumulated inside the oven.
- Reduce any opening of the door to a minimum to avoid heat dispersal.
- Keep the inside of the appliance clean at all times.
- (Where fitted) When it is not being used, remove the pizza stone and put the cover back in its slot.



Cooking information table

Food	Weight (Kg)	Function	Shelf	Temperature (°C)	Time (minutes)	
Lasagne	3 - 4	Static	1	220 - 230	45 - 50	
Pasta bake	3 - 4	Static	1	220 - 230	45 - 50	
Veal roast	2	Turbo/Fan assisted	2	180 - 190	90 - 100	
Pork loin	2	Turbo/Fan assisted	2	180 - 190	70 - 80	
Sausages	1.5	Fan with grill	4	280	15	
Roast beef	1	Turbo/Fan assisted	2	200	40 - 45	
Roast rabbit	1.5	Circulaire/Fan assisted	2	180 - 190	70 - 80	
Turkey breast	3	Turbo/Fan assisted	2	180 - 190	110 - 120	
Roast pork neck	2 - 3	Turbo/Fan assisted	2	180 - 190	170 - 180	
Roast chicken	1.2	Turbo/Fan assisted	2	180 - 190	65 - 70	
					1st surface	2nd surface
Pork chops	1.5	Fan with grill	4	280	15	5
Spare ribs	1.5	Fan with grill	4	280	10	10
Bacon	0.7	Grill	5	280	7	8
Pork fillet	1.5	Fan with grill	4	280	10	5
Beef fillet	1	Grill	5	280	10	7
Salmon trout	1.2	Turbo/Fan assisted	2	150 - 160	35 - 40	
Monkfish	1.5	Turbo/Fan assisted	2	160	60 - 65	
Turbot	1.5	Turbo/Fan assisted	2	160	45 - 50	
Pizza	1	Turbo/Fan assisted	2	280	8 - 9	
Bread	1	Circulaire/Fan assisted	2	190 - 200	25 - 30	
Focaccia	1	Turbo/Fan assisted	2	180 - 190	20 - 25	
Bundt cake	1	Circulaire/Fan assisted	2	160	55 - 60	
Tart	1	Circulaire/Fan assisted	2	160	35 - 40	
Ricotta cake	1	Circulaire/Fan assisted	2	160 - 170	55 - 60	
Jam tarts	1	Turbo/Fan assisted	2	160	20 - 25	
Paradise cake	1.2	Circulaire/Fan assisted	2	160	55 - 60	
Profiteroles	1.2	Turbo/Fan assisted	2	180	80 - 90	
Sponge cake	1	Circulaire/Fan assisted	2	150 - 160	55 - 60	
Rice pudding	1	Turbo/Fan assisted	2	160	55 - 60	
Brioche	0.6	Circulaire/Fan assisted	2	160	30 - 35	



The times indicated in the table do not include preheating times and are provided only as a guide.



3.6 Special functions

Defrost by time

i This function allows you to defrost food on the basis of a selectable time.

1. Place the food inside the oven.
2. Press and turn the function knob to select the defrost by time function marked by the  indicator light and the  indicator light flashing.



3. Turn the programming knob to adjust the duration (from 1 minute to 13 hours).
4. Press the programming knob to confirm the values entered.
5. Press the function knob to start defrosting.

6. At the end of the defrosting cycle, STOP flashes on the display and a buzzer will sound that can be deactivated by opening the door or pressing/turning one of the two knobs.



Defrost by weight

i This function defrosts foods according to the type and weight of the frozen product.

1. Place the food inside the oven.
2. Press and turn the function knob to select the defrost by weight function, marked by the  indicator light and



3. Press the function knob to confirm.
4. Turn the function knob to select the type of food to defrost.
5. Press and turn the programming knob to select the weight (in grams) of the food to defrost.



- Press the function knob to confirm the set parameters and start defrosting.
- At the end of the defrosting cycle, STOP flashes on the display and a buzzer will sound that can be deactivated by opening the door or pressing/turning one of the two knobs.



Pre-set parameters:



dE	Type	Weight (g)	Time (minutes)
d01	Meat	500	105
d02	Fish	400	40
d03	Fruit	300	45
d04	Bread	300	20

Proving

i For successful proving, a container of water should be placed in the bottom of the oven.

- Press and turn the function knob to select the proving function.



- Press the function knob to start the proving function.
- While the function is in progress, it is possible to set a minute minder  (see "Minute minder"), a proving duration  (see "Timed cooking") or delayed proving  (see "Programmed cooking"). Press the programming knob to make the desired changes.

i Unless otherwise set, the proving will have a maximum duration of 13 hours.

i The light inside the oven will remain off during the proving function.



Use

4. When the proving function finishes a buzzer will sound; to stop the buzzer, press the function knob.



When using the proving function the temperature cannot be altered.

Sabbath



This function results in the appliance operating in a particular way:

- Cooking can proceed indefinitely, it is not possible to set any cooking duration.
- No preheating will be performed.
- The cooking temperature which can be selected varies between 60-100 °C.
- Oven light disabled, any operation such as opening the door (where present) or manual activation with the knob will not activate the light.
- The internal fan remains turned off.
- Knob illumination and audible prompts remain disabled.



After activating the Sabbath function the settings cannot be altered.

Any action on the knobs will produce no effect; only the function knob remains active to allow you to return to the main menu.

1. Press and turn the function knob to select the Sabbath function.



2. Press and turn the programming knob to select the required temperature (from 60°C to 100°C).



3. Press the programming knob to confirm the set parameters.
4. Press the function knob to start the Sabbath function.
5. To exit this function, press and hold the function knob down for at least 5 seconds.



3.7 Secondary menu

The appliance has a drop-down secondary menu allowing the user to:

- Activate or deactivate the Child lock.
- Activate or deactivate Showroom mode (which disables all the heating elements so that only the control panel works).
- Activate or deactivate Low Power (Eco-Logic) mode.
- Activate or deactivate Eco-light mode.

With the appliance in Stand-by status

1. Turn the programming knob to the right to activate the oven light.
2. Press and hold the programming knob down for at least 5 seconds.
3. Turn the programming knob right or left to change the setting status (**ON/OFF**).
4. Press the programming knob to move to the next mode.

Child Lock mode: This mode allows the appliance to lock the controls automatically after one minute of normal operation without any intervention from the user.



During normal operation it is indicated by the indicator light  coming on.

To temporarily release the lock during cooking, hold the programming knob down for 5 seconds. One minute after the last setting the lock will become active again.



Touching or varying the position of the temperature and function knobs, the display will show **bLoC** for two seconds.



It is still possible to turn the appliance off instantaneously by pressing and holding the function knob down for 3 seconds when in child lock mode.



Use

Showroom mode (for exhibitors only):

This mode allows the appliance to deactivate all heating elements, while keeping the control panel active.

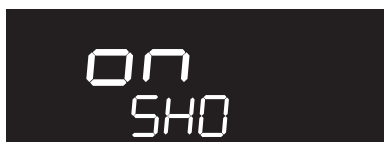

To use the appliance normally, set this mode to **OFF**.

Eco-logic mode: This mode allows the appliance to limit the power used. Suitable for simultaneous use with further home appliances.



HI: normal power.

LO: low power.



If the mode is active, the indicator light  lights up on the display.



Activating eco-logic mode means that preheating and cooking times may be extended.



Keep warm

This mode allows the appliance to keep cooked food warm (at low temperatures) after cooking finishes with a cooking cycle for which a duration has been set (if this is not manually interrupted), without altering the taste and smell obtained during cooking.



To use the appliance normally, set this mode to **OFF**.

Eco-light mode

For greater energy savings, the light is automatically deactivated one minute from the start of cooking.



To stop the appliance from automatically deactivating the light after one minute, set this mode to **OFF**.



The manual on/off control is always available with both settings by turning the programming knob to the right.



Cleaning and maintenance

4 Cleaning and maintenance

4.1 Instructions



Improper use
Risk of damage to surfaces

- Do not use steam jets to clean the appliance.
- Do not use cleaning products containing chlorine, ammonia or bleach on parts made of steel or that have metallic surface finishes (e.g. anodizing, nickel- or chromium-plating).
- Do not use abrasive or corrosive detergents (e.g. scouring powders, stain removers and metallic sponges) on glass parts.
- Do not use rough or abrasive materials or sharp metal scrapers.

4.2 Cleaning the appliance



We recommend the use of cleaning products distributed by the manufacturer.

Recommendations for cleaning the oven cavity

In order to keep your oven in the best possible condition, clean it regularly after letting it cool down.

Avoid letting food residue dry inside the oven cavity, as this could damage the enamel.

Take out all removable parts before cleaning.

For easier cleaning, we recommend removing:

- The door
- The rack/tray support frames
- The seal (excluding pyrolytic models).



In the event you are using specific cleaning products, we recommend running the oven at maximum temperature for 15-20 minutes in order to eliminate any residue.

4.3 Removing the door

For easier cleaning it is recommended to remove the door and place it on a tea towel. To remove the door proceed as follows:

1. Open the door completely and insert two pins into the holes on the hinges indicated in the figure.

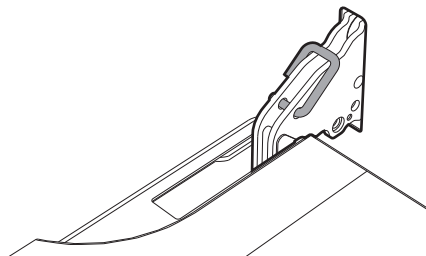



2. Grasp the door on both sides with both hands, lift it forming an angle of around 30° and remove it.

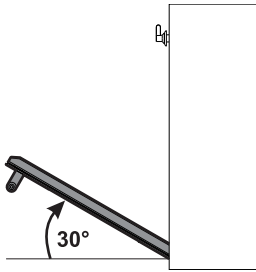

3. To reassemble the door, put the hinges in the relevant slots in the oven, making sure that grooved sections **A** are resting completely in the slots. Lower the door and once it is in place remove the pins from the holes in the hinges.

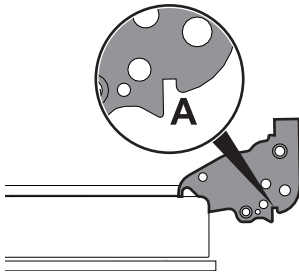

4.4 Cleaning the door glazing

The glass in the door should always be kept thoroughly clean. Use absorbent kitchen roll. In case of stubborn dirt, wash with a damp sponge and an ordinary detergent.

Removing the internal glass panes

For easier cleaning the internal glass panes of the door can be removed.

1. Remove the internal glass pane by pulling the rear part gently upwards, following the movement indicated by the arrows (1).
2. Then, pull the front part upwards (2). This way, the 4 pins attached to the glass detach from their housings in the oven door.

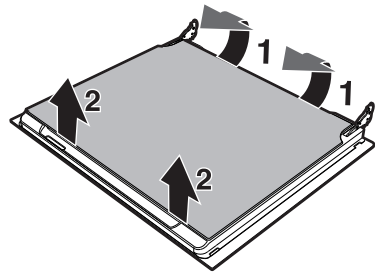

3. Some models are fitted with a pair of intermediate glass panes. Remove the intermediate glass panes by lifting them upwards.

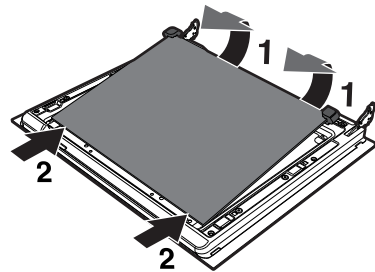



Cleaning and maintenance

4. Clean the external glass pane and the panes removed previously. Use absorbent kitchen roll. In case of stubborn dirt, wash with a damp sponge and neutral detergent.

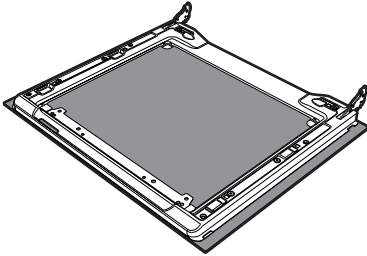

5. Refit the panes in the reverse order in which they were removed.
6. Reposition the internal glass pane. Take care to centre and insert the 4 pins into their housings in the oven door by applying slight pressure.

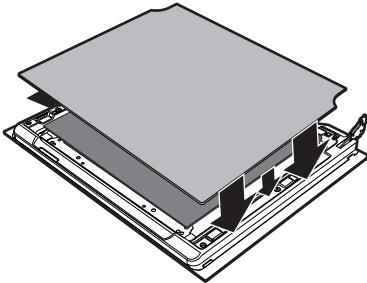

Removing rack/tray support frames

Removing the rack/tray support frames enables the sides to be cleaned more easily. This operation should be performed each time the automatic cleaning cycle is used (on some models only).

To remove the rack/tray support frames:

1. Pull the frame towards the inside of the oven cavity to unhook it from groove **A**.
2. Then slide it out of the seats at the back **B**.
3. When cleaning is complete, repeat the above procedures to put the rack/tray support frames back in.

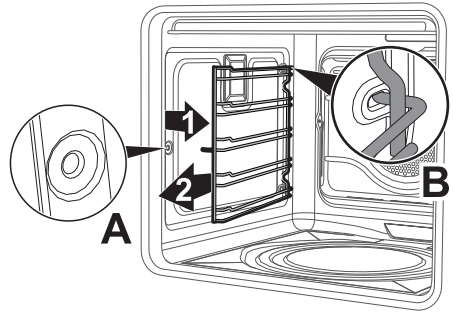



4.5 Pyrolytic cycle



Pyrolytic cleaning is an automatic high-temperature cleaning procedure which causes dirt to dissolve. Thanks to this process, it is possible to clean the inside of the oven very easily.



Improper use Risk of damage to surfaces

- Remove any food residues or large spills from previous cooking operations from the inside of the oven.
- Switch off the burners or electric hot plates if there is a hob installed above the oven.

Preliminary operations

Before starting the pyrolytic cycle:

- Clean the internal glass pane following the usual cleaning instructions.
- For very stubborn encrustations spray an oven cleaning product onto the glass (read the warnings on the product); leave for 60 minutes, then rinse and dry the glass using kitchen roll or a microfibre cloth.
- Completely remove all accessories from inside the oven.
- Remove the rack/tray support frames.
- Close the door.

Pyrolytic function setting

1. Press and turn the function knob to select the Eco Pyrolytic or Pyrolytic function.

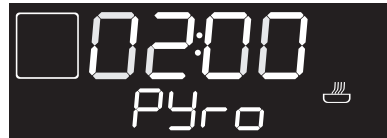

2. The duration of the Pyrolytic cycle will appear on the display.
3. Press and turn the programming knob to set the Pyrolytic cycle duration from a minimum of 2 hours to a maximum of 3 hours (except for the **PECO** function whose duration is 2 hours).
4. Press the programming knob to confirm the values entered.
5. Press the function knob to start the Pyrolytic cycle.



Recommended pyrolytic cycle duration:

- Light dirt: 2 hours.
- Medium dirt: 2 ½ hours.
- Heavy dirt: 3 hours.



Cleaning and maintenance

Pyrolytic cycle

1. Two minutes after the Pyrolytic cycle starts, the  indicator light comes on to indicate that the door is locked by a device that prevents the door from being opened.

 It is not possible to select any function once the door lock device has been activated.

2. At the end of the Pyrolytic cycle, STOP flashes on the display and a buzzer will sound that can be deactivated by opening the door or pressing/turning one of the two knobs.



3. The door remains locked until the temperature inside the oven returns to a safe level. Wait for the oven to cool down (the indicator light  will turn off) and collect the residue deposited inside the oven with a damp microfibre cloth.

 During the first Pyrolytic cycle, unpleasant odours may occur due to the normal evaporation of oily manufacturing substances. This is an absolutely normal phenomenon which disappears after the first pyrolytic cycle.





 During the pyrolytic cycle the fans produce a more intense level of noise due to a greater rotation speed. This is an absolutely normal operation, intended to provide more effective heat dispersal. At the end of the pyrolytic cycle, the fans will continue to operate for long enough to avoid overheating the walls of adjacent units and the front of the oven.

 If the pyrolytic cycle gives unsatisfactory results at minimum duration, it is recommended to set a longer time for subsequent cleaning cycles.



Setting of a programmed Pyrolytic cycle

It is possible to program the pyrolytic cycle start time like all other cooking functions.

1. After selecting the Pyrolytic function and setting the duration (except for Eco Pyrolytic), press the programming knob. The display will show the current time and the temperature, and the  indicator light will come on.
2. Turn the programming knob to set the time you wish the Pyrolytic cycle to finish.
3. Press the programming knob to confirm the values entered. The   and  indicator lights turn on steadily and the appliance then waits for the set start time to begin the Pyrolytic cycle.



It is not possible to select any function once the door lock device has been activated. It remains possible, however, to switch off the appliance using the specific controls.

4.6 Extraordinary maintenance

Removing and installing the door seal (not on pyrolytic models)

To remove the seal:

- Release the clips located in the 4 corners and pull the seal outwards.

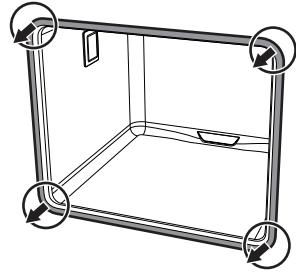

To refit the seal:

- Hook the clips in the 4 corners onto the seal.

Seal maintenance tips

The seal should be soft and elastic.

- To keep the seal clean, use a non-abrasive sponge and wash with lukewarm water.



Cleaning and maintenance

Replacing the internal light bulb



Live parts
Danger of electrocution

- Unplug the appliance.

1. Completely remove all accessories from inside the oven.
2. Remove the rack/tray support frames.
3. Remove the bulb cover using a tool (e.g. a screwdriver).



Pay attention not to scratch the oven cavity enamel.

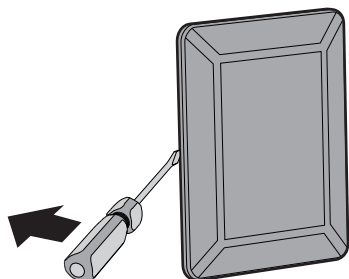

4. Slide out and remove the light bulb.

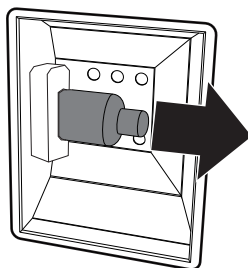

Do not touch the halogen light bulb directly with your fingers, but wrap it in insulating material.

5. Replace the light bulb with one of the same type (40W).
6. Refit the cover. Ensure the moulded part of the glass (**A**) is facing the door.

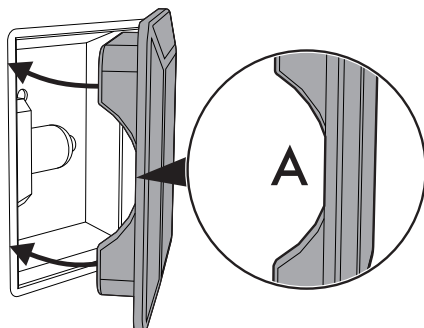

7. Press the cover completely down so that it attaches perfectly to the bulb support.



5 Installation

5.1 Electrical connection



Power voltage
Danger of electrocution

- Have the electrical connection performed by authorised technical personnel.
- The appliance must be connected to earth in compliance with electrical system safety standards.
- Disconnect the mains power supply.

General information

Check the grid characteristics against the data indicated on the plate.

The identification plate bearing the technical data, serial number and brand name is visibly positioned on the appliance.

Do not remove this plate for any reason. The appliance operates at 220-240 V \sim .

Use a three-core cable (3 x 1.5 mm² internal conductors).

Perform the ground connection using a wire that is 20 mm longer than the other wires.

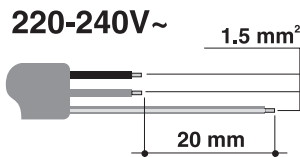

Fixed connection

Fit the power line with an all-pole circuit breaker in compliance with installation regulations.

The circuit breaker should be located near the appliance and in an easily reachable position.

Connection with plug and socket

Make sure that the plug and socket are of the same type.

Avoid using adapters and shunts as these could cause overheating and a risk of burns.

5.2 Cable replacement



Power voltage
Danger of electrocution

- Disconnect the mains power supply.

1. Unscrew the rear casing screws and remove the casing to access the terminal board.

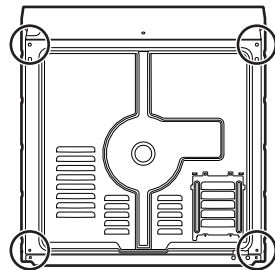

2. Replace the cable.
3. Make sure that the cables (for the oven or any hob) follow the best route in order to avoid any contact with the appliance.



Installation

5.3 Positioning



**Heavy appliance
Crushing hazard**

- Position the appliance into the cabinet cut-out with the help of a second person.



**Pressure on the open door
Risk of damage to the appliance**

- Never use the oven door to lever the appliance into place when fitting.
- Avoid exerting too much pressure on the oven door when open.



**Heat production during appliance operation
Risk of fire**

- Check that the carcass material is heat resistant.
- Check that the carcass has the required openings.
- Do not install the appliance in a recess which can be closed with a door, or in a cupboard.

Position of the power cable

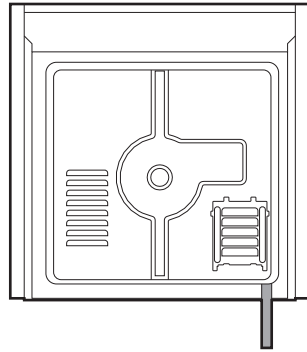

(rear view)

Front panel seal

Glue the supplied seal to the rear part of the front panel to avoid water or other liquids from leaking in.

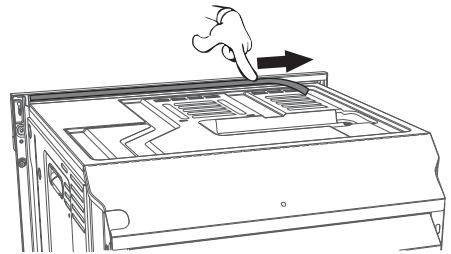



Fastening bushings

1. Remove the bushing covers on the front of the appliance.

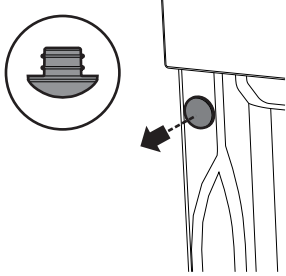

2. Mount the appliance into the recess.
3. Secure the appliance to the carcass using the screws.

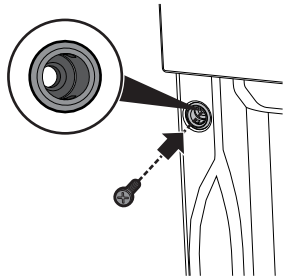

4. Cover the bushings with the previously removed covers.

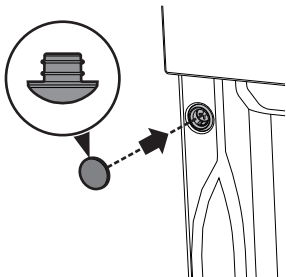

Appliance overall dimensions (mm)

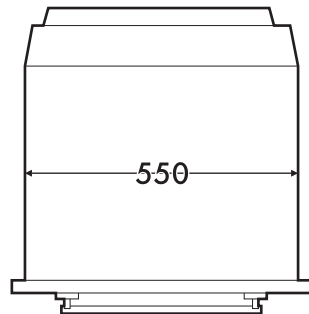
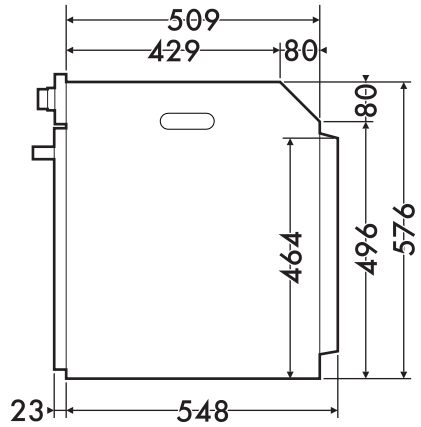
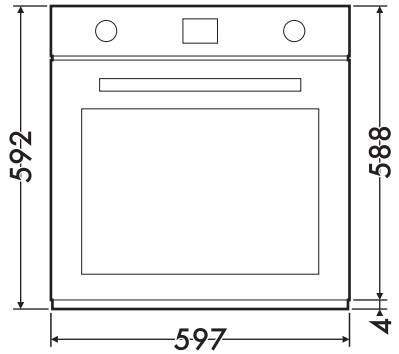



Installation

Mounting under worktops (mm)

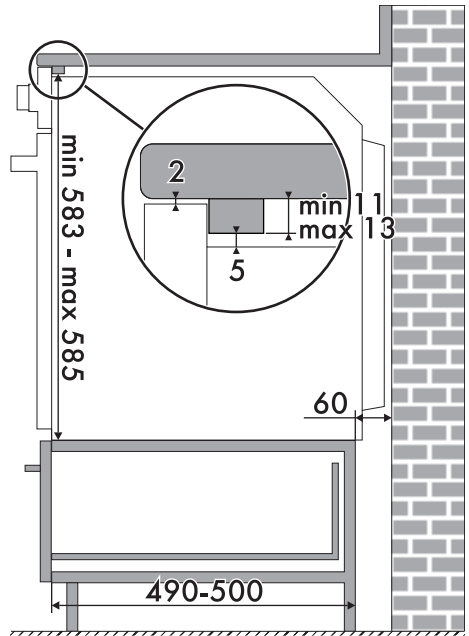
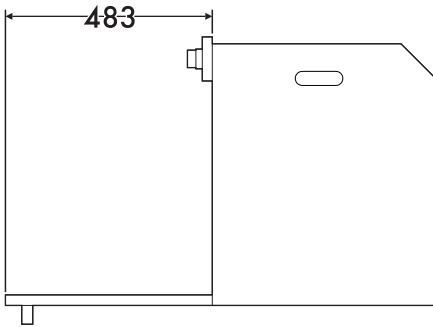
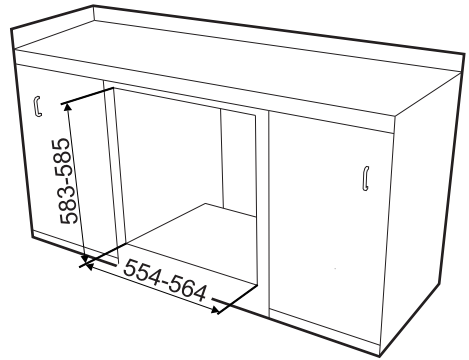
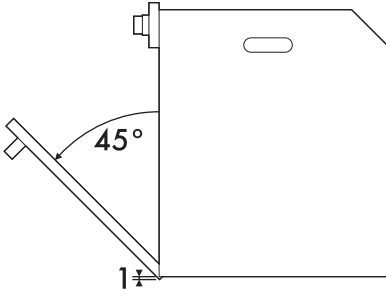

Make sure that the carcass rear/
bottom section has an opening of
approx. 60 mm.



Mounting into a column (mm)

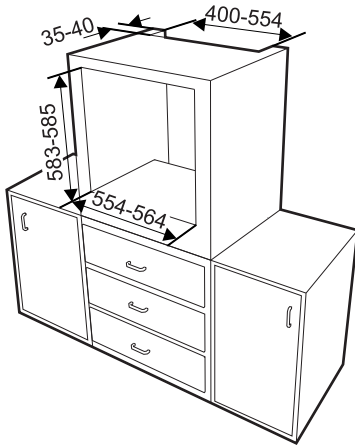

Make sure that the carcass top/rear section has an opening approx. 35-40 mm deep.

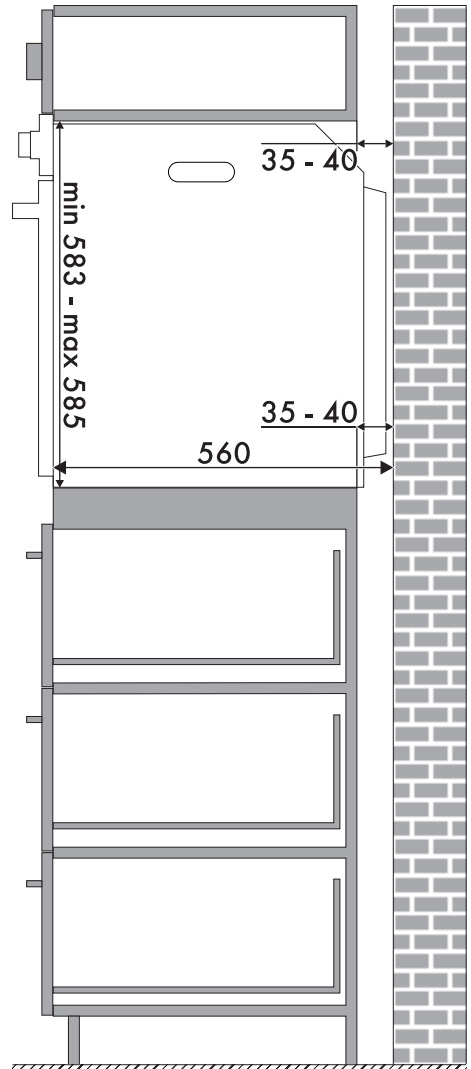

EN



Installation

Mounting under worktops

Whenever a hob is installed above the oven, a wooden separator has to be installed at a minimum distance of **20 mm** from the top of the oven to prevent overheating when the two appliances are used at the same time. It must only be possible to remove the separator by using suitable tools.

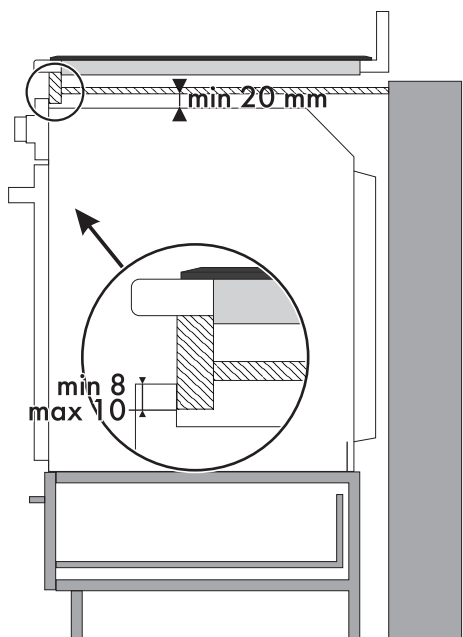
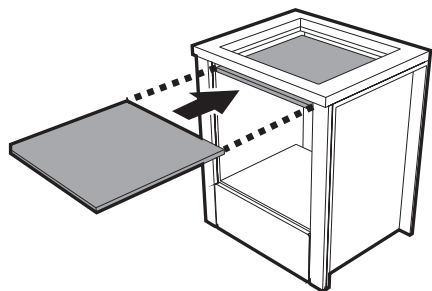

When using a wooden separator, a wooden bar has to be installed under the worktop in order to use the seal that is glued to the back of the front panel to prevent water or other liquids leaking in.