

**SIEMENS**

## Induction hob with integrated ventilation system

EH8..BE15.

en Information for Use



Register your product on My Siemens and discover exclusive services and offers.  
[siemens-home.bsh-group.com/welcome](https://siemens-home.bsh-group.com/welcome)

The future moving in.

**Further information and explanations are available online:**



## Table of contents

1	<b>Safety</b> .....	2
2	<b>Avoiding material damage</b> .....	5
3	<b>Environmental protection and saving energy</b> .....	5
4	<b>Suitable cookware</b> .....	6
5	<b>Familiarising yourself with your appliance</b> .....	7
6	<b>Operating modes</b> .....	8
7	<b>Before using for the first time</b> .....	8
8	<b>Basic operation</b> .....	9
9	<b>Hood control</b> .....	10
10	<b>Time-setting options</b> .....	11
11	<b>powerBoost</b> .....	11
12	<b>Childproof lock</b> .....	12
13	<b>Individual safety switch-off</b> .....	12
14	<b>Basic settings</b> .....	12
15	<b>Cookware test</b> .....	13
16	<b>Power limitation</b> .....	14
17	<b>Cleaning and servicing</b> .....	14
18	<b>FAQs</b> .....	17
19	<b>Troubleshooting</b> .....	19
20	<b>Disposal</b> .....	20
21	<b>Customer Service</b> .....	20
22	<b>Test dishes</b> .....	21

## 1 Safety

Observe the following safety instructions.

### 1.1 General information

- Read this instruction manual carefully.
- Keep the instructions, the appliance pass and the product information safe for future reference or for the next owner.
- Do not connect the appliance if it has been damaged in transit.

### 1.2 Intended use

Only a licensed professional may connect appliances without plugs. Damage caused by incorrect connection is not covered under the warranty.

The appliance can only be used safely if it is correctly installed according to the safety instructions. The installer is responsible for ensuring that the appliance works perfectly at its installation location.

Only use this appliance:

- To prepare meals and drinks.
- Under supervision. Never leave the appliance unattended when cooking for short periods.
- In private households and in enclosed spaces in a domestic environment.
- Up to an altitude of max. 2000 m above sea level.

Do not use the appliance:

- On boats or in vehicles.
- With an external timer or a separate remote control. This does not apply if operation with appliances included in EN 50615 is switched off.
- To extract hazardous or explosive substances and vapours.
- To extract small parts and liquids.

If you wear an active implantable medical device (e.g. a pacemaker or defibrillator), check with your doctor that it complies with Council Directive 90/385/EEC of 20th June 1990, EN 45502-2-1 and EN 45502-2-2, and that it has been chosen, implanted and programmed in accordance with VDE-AR-E 2750-10. If these conditions are satisfied, and if, in addition, non-metal cooking utensils and cookware with non-metal handles are used, it is safe to use this induction hob as intended. If these conditions are satisfied, and if, in addition, non-metal cooking utensils and cookware with non-metal handles are used, it is safe to use this induction hob as intended.

### 1.3 Restriction on user group

This appliance may be used by children aged 8 or over and by people who have reduced physical, sensory or mental abilities or inadequate experience and/or knowledge, provided that they are supervised or have been instructed on how to use the appliance safely and have understood the resulting dangers.

Children must not play with the appliance. Children must not perform cleaning or user maintenance unless they are at least 15 years old and are being supervised.

Keep children under the age of 8 years away from the appliance and power cable.

### 1.4 Safe use

#### **⚠ WARNING – Risk of suffocation!**

Children may breathe in or swallow small parts, causing them to suffocate.

- ▶ Keep small parts away from children.
  - ▶ Do not let children play with small parts.
- Children may put packaging material over their heads or wrap themselves up in it and suffocate.
- ▶ Keep packaging material away from children.
  - ▶ Do not let children play with packaging material.

#### **⚠ WARNING – Risk of poisoning!**

Risk of poisoning from flue gases being drawn back in. Room-air-dependent heat-producing appliances (e.g. gas, oil, wood or coal-operated heaters, continuous flow heaters or water heaters) obtain combustion air from the room in which they are installed and discharge the exhaust gases into the open through an exhaust gas system (e.g. a chimney). With the extractor hood switched on, air is extracted from the kitchen and the adjacent rooms. Without an adequate supply of air, the air pressure falls below atmospheric pressure. Toxic gases from the flue or the extraction shaft are sucked back into the living space.

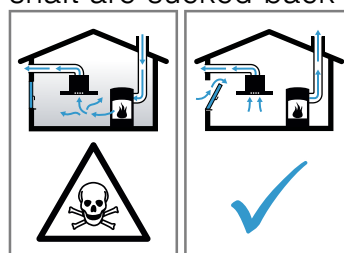

- ▶ Always ensure adequate fresh air in the room if the appliance is being operated in exhaust air mode at the same time as a room-air-dependent heat-producing appliance is being operated.
- ▶ It is only possible to safely operate the appliance if the pressure in the room in which the heating appliance is installed does not drop more than 4 Pa (0.04 mbar) below atmospheric pressure. This can be achieved whenever the air needed for combustion is able to enter through openings that cannot be sealed, for example in doors, windows, incoming/exhaust air wall boxes or by other technical means. An incoming/exhaust air wall box alone does not ensure compliance with the limit.
- ▶ In any case, consult your responsible chimney sweep. They are able to assess the house's entire ventilation setup and will suggest the suitable ventilation measures to you.
- ▶ Unrestricted operation is possible if the appliance is operated exclusively in circulating-air mode.

**⚠ WARNING – Risk of fire!**

Leaving fat or oil cooking on an unattended hob can be dangerous and may lead to fires.

- ▶ Never leave hot oil or fat unattended.
- ▶ Never attempt to extinguish a fire using water; instead, switch off the appliance and then cover with a lid or a fire blanket.

The cooking surface becomes very hot.

- ▶ Never place flammable objects on the cooking surface or in its immediate vicinity.
- ▶ Never place objects on the cooking surface.

The appliance will become hot.

- ▶ Do not keep combustible objects or aerosol cans in drawers directly underneath the hob.

Hob covers can cause accidents, for example due to overheating, catching fire or materials shattering.

- ▶ Do not use hob covers.

After every use, switch off the hob using the main switch.

- ▶ Do not wait until the hob turns off automatically as there are no longer any pots and pans on it.

Fatty deposits in the grease filters may catch fire.

- ▶ Never operate the appliance without a grease filter.
- ▶ Clean the grease filters regularly.
- ▶ Never work with naked flames close to the appliance (e.g. flambéing).
- ▶ Do not install the appliance near a solid fuel heating appliance (e.g. wood- or coal-burning) unless the heating appliance has a sealed, non-removable cover. There must be no flying sparks.

**⚠ WARNING – Risk of burns!**

The appliance and its parts that can be touched become hot during use, particularly the hob surround, if fitted.

- ▶ Caution should be exercised here in order to avoid touching heating elements.
- ▶ Young children under 8 years of age must be kept away from the appliance.

The hotplate heats up but the display does not work.

- ▶ Switch off the fuse in the fuse box.
- ▶ Call the customer service.

Hob protective grilles may cause accidents.

- ▶ Never use hob protective grilles.

Metal objects on the hob quickly become very hot.

- ▶ Never place metal objects (such as knives, forks, spoons and lids) on the hob.

The appliance becomes hot during operation.

- ▶ Allow the appliance to cool down before cleaning.
- ▶ If hot liquids penetrate the appliance, only remove the grease filter or the overflow container once the appliance has cooled down.

**⚠ WARNING – Risk of electric shock!**

Incorrect repairs are dangerous.

- ▶ Repairs to the appliance should only be carried out by trained specialist staff.
- ▶ Only use genuine spare parts when repairing the appliance.
- ▶ If the power cord of this appliance is damaged, it must be replaced with a special connection cable, which is available from the manufacturer or his Customer Service.

If the appliance or the power cord is damaged, this is dangerous.

- ▶ Never operate a damaged appliance.
- ▶ Never operate an appliance with a cracked or fractured surface.
- ▶ Never pull on the power cord to unplug the appliance. Always unplug the appliance at the mains.
- ▶ If the appliance or the power cord is damaged, immediately unplug the power cord or switch off the fuse in the fuse box.
- ▶ Call customer services. → *Page 20*

An ingress of moisture can cause an electric shock.

- ▶ Do not use steam- or high-pressure cleaners to clean the appliance.

The insulation on cables of electrical appliances may melt if it touches hot parts of the appliance.

- ▶ Never bring electrical appliance cables into contact with hot parts of the appliance.

**⚠ WARNING – Risk of injury!**

Saucepans may suddenly jump due to liquid between the saucepan base and the hotplate.

- ▶ Always keep hotplates and saucepan bases dry.
- ▶ Never use icy-cold cookware that has been in the freezer.

When cooking in a bain marie, the hob and cooking container could shatter due to overheating.

- ▶ The cooking container in the bain marie must not directly touch the bottom of the water-filled pot.
- ▶ Only use heat-resistant cookware.

An appliance with a cracked or broken surface can cause cuts.

- ▶ Do not use the appliance if it has a cracked or broken surface.

## 2 Avoiding material damage

This is where you can find the most common causes of damage and tips on how to avoid them.

Damage	Cause	Action
Stains	Unsupervised cooking process.	Monitor the cooking process.
Stains, blisters	Spilled food, especially food with a high sugar content.	Remove immediately with a glass scraper.
Stains, blisters or fractures in the glass	Defective cookware, cookware with melted enamel or cookware with copper or aluminium base.	Use suitable cookware that is in a good condition.
Stains, discolouration	Unsuitable cleaning methods.	Only use cleaning agents that are suitable for glass ceramic, and only clean the hob when it is cold.
Blisters or fractures in the glass	Knocks or falling cookware, cooking accessories or other hard or pointed objects.	When cooking, do not hit the glass or let objects fall onto the hob.
Scratches, discolouration	Rough cookware bases or moving the cookware on the hob.	Check the cookware. Lift the cookware when moving it.
Scratches	Salt, sugar or sand.	Do not use the hob as a work surface or storage space.
Damage to the appliance	Cooking with frozen cookware.	Never use frozen cookware.
Damage to the cookware or the appliance	Cooking without contents.	Never place or heat empty cookware on a hot cooking zone.
Glass damage	Melted material on the hot cooking zone or hot pot lid on the glass.	Do not place greaseproof paper or aluminium foil nor plastic containers or pot lids on the hob.
Overheating	Hot cookware on the control panel or on the frame.	Never place hot cookware on these areas.

## 3 Environmental protection and saving energy

### 3.1 Disposing of packaging

The packaging materials are environmentally compatible and can be recycled.

- ▶ Sort the individual components by type and dispose of them separately.

### 3.2 Saving energy

If you follow these instructions, your appliance will use less energy.

Select the cooking zone to match the size of your pan. Centre the cookware on the hob. Use cookware whose base diameter is the same diameter as the hotplate.

**Tip:** Cookware manufacturers often give the upper diameter of the saucepan. It is often larger than the base diameter.

- Unsuitable cookware or incompletely covered cooking zones consume a lot of energy.

Cover saucepans with suitable lids.

- Cooking without a lid consumes considerably more energy.

Lift lids as infrequently as possible.

- When you lift the lid, a lot of energy escapes.

Use a glass lid.

- You can see into the pan through a glass lid without having to lift it.

Use pots and pans with flat bases.

- Uneven bases increase energy consumption.

Use cookware that is suitable for the quantity of food.

- Large items of cookware containing little food need more energy to heat up.

Cook with only a little water.

- The more water that is contained in the cookware, the more energy is required to heat it up.

Turn down to a lower power level early on. Use a suitable ongoing power level.

- If you use an ongoing power level that is too high, you will waste energy.

Adjust the fan speed to the amount of steam produced during cooking.

- The lower the fan speed, the less energy is consumed.

If cooking produces large amounts of steam, select a higher fan speed in good time.

- The odours are distributed around the room less.

Switch the appliance off when you are not using it.

- 

Ensure that there is sufficient ventilation when cooking.

- The appliance works more efficiently and with fewer operating noises.

Clean or replace the filters at regular intervals.

- The effectiveness of the filter is retained.

Product Information according (EU) 66/2014 can be found on the attached appliance pass and online on the product page for your appliance.

## 4 Suitable cookware

Cookware that is suitable for induction cooking must have a ferromagnetic base, i.e. it must be attracted by a magnet. The base must also match the size of the



cooking zone. If cookware is not detected on a cooking zone, place this on the cooking zone with the next smallest diameter.

### 4.1 Size and characteristics of the cookware

To correctly detect the cookware, take the size and the material of the cookware into consideration. All cookware bases must be perfectly flat and smooth.

You can use Cookware test to check whether your cookware is suitable. You can find more information about this under

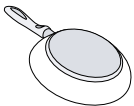
→ "Cookware test", Page 13.

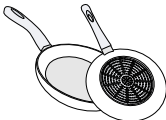
Cookware	Materials	Properties
Recommended cookware	Stainless steel cookware in a sandwich design that distributes the heat well.	This cookware distributes the heat evenly, heats up quickly, and ensures that it can be detected easily.
	Ferromagnetic cookware made of enamelled steel, cast iron or special induction cookware made of stainless steel.	This cookware heats up quickly and ensures that it can be detected easily.
Suitable	The base is not fully ferromagnetic.	If the ferromagnetic area is smaller than the base of the cookware, only the area that is ferromagnetic heats up. As a result, the heat is not distributed evenly.
	Cookware bases with aluminium content.	These reduce the ferromagnetic area, which means that less power is emitted to the cookware. This cookware may not be sufficiently detected or may not be detected at all, and therefore does not heat sufficiently.
		
Not suitable	Cookware made from normal thin steel, glass, clay, copper or aluminium.	

### Notes

- Do not use adapter plates between the hob and the cookware.
- Do not heat up empty cookware and do not use cookware with a thin base, as this may become very hot.

## 5 Familiarising yourself with your appliance

### 5.1 Cooking with induction

In comparison to conventional hobs, induction technology brings with it a series of changes and has a number of benefits such as time savings when cooking and frying, energy savings as well as greater ease of cleaning and care. It also offers improved heat control as the heat is generated directly in the cookware.

### 5.2 Your new appliance

Information about your new appliance

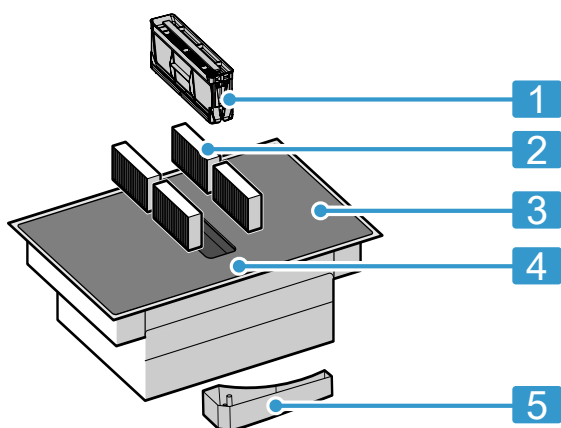

No.	Designation
1	Grease filter
2	Odour filter for circulating-air mode or acoustics filter for air extraction mode <sup>1</sup>
3	Hob
4	Control panel
5	Overflow container

<sup>1</sup> Depending on the appliance specifications.

### 5.3 Special accessories

Depending on the appliance model, various accessories are available and you can obtain these from specialist retailers, from our after-sales service or from our official website.

- Air extraction set
- Air recirculation set
- Odour filter for recirculating air mode
- Acoustics filter for air extraction mode

### 5.4 The control panel

Individual details, such as colour and shape, may differ from the figure.

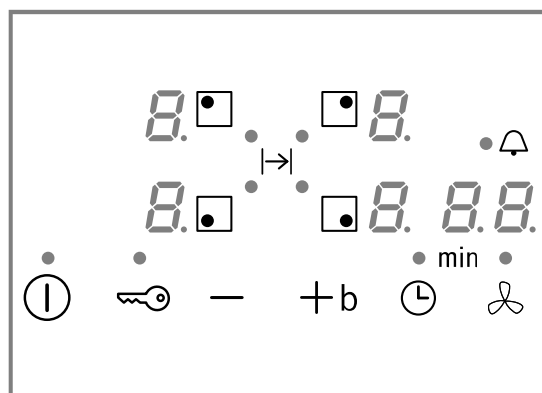

#### Selection sensors

Sensor	Function
ⓘ	Main switch
□	Selecting the cooking zone
-/+	Selecting settings
b	powerBoost Intensive ventilation setting
⌚	Timer function
🔑	Childproof lock
🌀	Manual ventilation control

#### Displays

Display	Function
8	Operating status
1-9	Power levels
1-3	Ventilation settings
H/h	Residual heat
b	powerBoost Intensive ventilation setting
00	Time-setting options

#### Touch fields and displays

Touch a symbol to activate the function it represents.

- Always keep the control panel clean and dry. Moisture impairs the function.
- Do not place any cookware near the indicators or sensors. The electronics may overheat.

## 5.5 Distribution of the cooking zones

The specified power has been measured with the standard pots, which are described in IEC/EN 60335-2-6. The power may vary depending on the size of the cookware or cookware material.

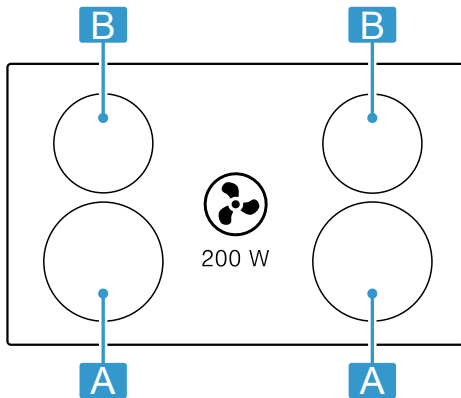

Area	Highest power level	
<b>A</b> 21 cm diameter	Power level 9	2200 W
	powerBoost	3700 W

Area	Highest power level	
<b>B</b> 18 cm diameter	Power level 9	1800 W
	powerBoost	3100 W

## 5.6 Cooking zone

Before you start cooking, check whether the size of the cookware fits the cooking zone that you want to use for cooking:

Area	Cooking zone type
○	Single-circuit cooking zone

## 5.7 Residual heat indicator

The hob has a residual heat indicator for each cooking zone. Do not touch the cooking zone if the residual heat indicator is lit.

Display	Meaning
<i>H</i>	The cooking zone is hot.
<i>h</i>	The cooking zone is warm.

# 6 Operating modes

You can use your appliance in air extraction mode or circulating-air mode.

## 6.1 Air extraction mode

The air which is drawn in is cleaned by the grease filters and conveyed to the exterior by a pipe system.



The air must not be discharged into a flue that is used for exhausting fumes from appliances burning gas or other fuels (not applicable to appliances that only discharge the air back into the room).

- If the exhaust air is to be conveyed into a non-functioning smoke or exhaust gas flue, you must obtain the consent of the heating engineer responsible.
- If the exhaust air is conveyed through the external wall, a telescopic duct should be used.

## 6.2 Air recirculation mode

The air which is drawn in is cleaned by the grease filters and an odour filter, and conveyed back into the room.



To bind odours in circulating-air mode, you must install an odour filter. The different options for operating the appliance in circulating-air mode can be found in our catalogue. Alternatively, ask your dealer. The required accessories are available from specialist retailers, from customer service or from the Online Shop.

# 7 Before using for the first time

Observe the following recommendations.

## 7.1 Preparing the appliance

To ensure correct operation, you must arrange the components in this order:

1. Insert the filter.
2. Insert the metal grease filter.

**Note:** Never operate the appliance without the metal grease filter and the overflow container.

## 7.2 Setting the operating mode

The appliance is supplied with a preset circulating-air mode.

When your hob is installed with an air outlet to the outside, you must configure the setting  $\epsilon / 7$  to this mode. You can find additional information about this in the section entitled

→ "Basic settings", Page 12



## 8 Basic operation

### 8.1 Switching the hob on and off

- ▶ Switch the hob on and off using the main switch ①. If all of the cooking zones are switched off for longer than 20 seconds, the hob is automatically switched off.

#### reStart

- ▶ If you switch the appliance on within four seconds of switching it off, the hob operates with the settings that were previously set.

### 8.2 Setting the cooking zones

To choose the required selectable power level, touch + or -.

Each power level has an intermediate level. This is marked with a dot.

Power level	
1	Lowest power level
9	Highest power level

#### Selecting the cooking zone and power setting

1. Touch  to select the cooking zone.

### 8.3 Cooking tips

- When heating up puree, cream soups or thick sauces, stir occasionally.
- To preheat, set the power level 8-9.
- When cooking with the lid on, reduce the power level as soon as you see steam escaping. The cooking result is not affected by the steam escaping.
- After cooking, place a lid on the cookware until you serve the dish.
- To cook with the pressure cooker, observe the manufacturer's instructions.
- Do not cook food for too long, otherwise nutrients will be lost. The kitchen timer enables you to set the optimal cooking time.
- Ensure that the oil does not smoke.
- To brown the food, fry it in small portions, one after the other.
- Some items of cookware may reach high temperatures while the food is cooking. You should therefore use oven gloves.
- You can find recommendations for energy-efficient cooking under → "Saving energy", Page 5

#### Cooking recommendations

The table shows which power level (⏏) is suitable for which food. The cooking time (⌚ min) may vary depending on the type, weight, thickness and quality of the food.

2. Within the next 10 seconds, select the required power level:
  - Touch + to call up power level 9.
  - Touch - to call up power level 4.
- ✓ The power level has been set.

**Note:** If no cookware is placed on the cooking zone or the pot is not suitable, the selected power level flashes. After a certain period of time, the cooking zone switches itself off.

#### quickStart

- ▶ If you place cookware on the hob before you switch it on, the cookware is detected when you switch on and the corresponding cooking zone is selected automatically. Select the power level in the next 20 seconds, or the hob switches itself off.

#### Changing the power level and switching off the cooking zone

1. Select the cooking zone.
2. Touch + or - until the required power level appears. To switch off the cooking zone, set ⏏.

#### Switching off the cooking zone quickly

Touch and hold the symbol for the cooking zone for three seconds. The cooking zone switches itself off.

	⏏	⌚ min
<b>Melting</b>		
Chocolate coating	1 - 1.	-
Butter, honey, gelatine	1 - 2	-
<b>Heating and keeping warm</b>		
Stew, e.g. lentil stew	1. - 2	-
Milk <sup>1</sup>	1. - 2.	-
Boiled sausages <sup>1</sup>	3 - 4	-
<b>Defrosting and heating</b>		
Spinach, frozen	3 - 4	15 - 25
Goulash, frozen	3 - 4	35 - 55
<b>Poaching, simmering</b>		
Potato dumplings <sup>1</sup>	4. - 5.	20 - 30
Fish <sup>1</sup>	4 - 5	10 - 15
White sauces, e.g. Béchamel sauce	1 - 2	3 - 6
Whisked sauces, e.g. Béarnaise sauce, Hollandaise sauce	3 - 4	8 - 12
<b>Boiling, steaming, braising</b>		
Rice, with double the volume of water	2. - 3.	15 - 30
Rice pudding <sup>2</sup>	2 - 3	30 - 40
Unpeeled boiled pots	4. - 5.	25 - 35
Boiled potatoes	4. - 5.	15 - 30

<sup>1</sup> Without lid

<sup>2</sup> Preheat to power level 8 - 8.

		⊖ min
Pasta <sup>1</sup>	6 - 7	6 - 10
Stew	3. - 4.	120 - 180
Soups	3. - 4.	15 - 60
Vegetables	2. - 3.	10 - 20
Vegetables, frozen	3. - 4.	7 - 20
Stew in a pressure cooker	4. - 5.	-
<b>Stewing</b>		
Rolled roasting joint	4 - 5	50 - 65
Pot roast	4 - 5	60 - 100
Goulash <sup>2</sup>	3 - 4	50 - 60
<b>Braising/frying with a small amount of fat <sup>1</sup></b>		
Escalope, plain or breaded	6 - 7	6 - 10
Escalope, frozen	6 - 7	6 - 12
Chops, plain or breaded	6 - 7	8 - 12
Steak (3 cm thick)	7 - 8	8 - 12
Poultry breast (2 cm thick)	5 - 6	10 - 20
Poultry breast, frozen	5 - 6	10 - 30
Rissoles (3 cm thick)	4. - 5.	20 - 30
Hamburgers (2 cm thick)	6 - 7	10 - 20
Fish and fish fillet, plain	5 - 6	8 - 20
Fish and fish fillet, breaded	6 - 7	8 - 20

<sup>1</sup> Without lid  
<sup>2</sup> Preheat to power level 8 - 8.

		⊖ min
Fish, breaded and frozen, e.g. fish fingers	6 - 7	8 - 15
Prawns and scampi	7 - 8	4 - 10
Sautéing fresh vegetables and mushrooms	7 - 8	10 - 20
Stir-fry, vegetables, meat cut in strips Asian-style	7 - 8	15 - 20
Frozen dishes, e.g. stir-fries	6 - 7	6 - 10
Pancakes, cooked one after the other	6. - 7.	-
Omelette (cooked one after the other)	3. - 4.	3 - 10
Fried eggs	5 - 6	3 - 6
<b>Deep-frying, 150–200 g per portion in 1–2 l oil, deep-fat fried in portions <sup>1</sup></b>		
Frozen products, e.g. chips, chicken nuggets	8 - 9	-
Croquettes, frozen	7 - 8	-
Meat, e.g. chicken portions	6 - 7	-
Fish, breaded or battered	6 - 7	-
Vegetables, mushrooms, breaded, beer-battered or tempura	6 - 7	-
Small baked items, e.g. doughnuts, battered fruit	4 - 5	-

<sup>1</sup> Without lid  
<sup>2</sup> Preheat to power level 8 - 8.

## 9 Hood control

You can use the hood control to control the highly efficient air extraction system that is integrated in the cooking surface.

### 9.1 Manual ventilation control

You can control the ventilation setting manually.



**Note:** Using tall items of cookware may prevent the extraction system from working at optimum power. You can improve the extraction power by placing the lid on the cookware at an angle.

#### Activating the manual ventilation control

1. Touch .  
The ventilation system starts at the preset performance level.
2. Use the + and – symbols to select the required performance level within the next 10 seconds.  
✓ The performance level lights up.

**Note:** If you have set a cooking time or timer duration, touch  to view the ventilation setting.





#### Changing or deactivating manual ventilation control

1. Touch .
2. Select the required performance level or set the + and – symbols to .

### 9.2 Intensive ventilation setting



The appliance has an intensive ventilation setting. If you activate the intensive ventilation setting, the ventilation system works at maximum output for a short time.

#### Activating the intensive ventilation setting

1. Touch .
2. Select performance level  and then touch .  
The  display lights up.  
✓ The intensive setting is activated.

**Note:** After approx. eight minutes, the appliance automatically switches back to performance level .

#### Changing or deactivating the intensive ventilation setting

1. Touch .
2. Select the required performance level or set the + and – symbols to .

### 9.3 Automatic start for the ventilation system

If you select a power level for a cooking zone, the automatic start switches on.

The ventilation system starts at the corresponding power level. You can find out how to change this setting in section

→ "Basic settings", Page 12.

### 9.4 Run-on function for the ventilation system

The run-on function leaves the ventilation system running for a few minutes after the hob has been switched off. This allows you to remove any cooking fumes that remain. The ventilation system then automatically switches off.

#### Activating the fan run-on

As standard, the run-on time is activated with a maximum switch-off time.

You can find out how to change this setting in section → "Basic settings", Page 12.

**Note:** The run-on function only switches on if at least one cooking zone has been switched on for at least one minute.

#### Deactivating the fan run-on

##### Manually

To deactivate the function, touch .

##### Automatically

The appliance deactivates the run-on function if:

- The run-on time has elapsed.
- You switch the appliance on again.

## 10 Time-setting options

Your hob has various functions for setting the cooking time:

- Switch-off timer
- Timer

### 10.1 Switch-off timer

Allows you to programme a cooking time for a hotplate and its automatic switch-off once the set time has elapsed.



#### Programming the cooking time

1. Select the cooking zone and the required power level.
2. Touch .
  - ✓ The • display lights up in the cooking zone.
3. Use + or – to select the cooking time.
  - ✓ The time begins to count down.

**Note:** You can automatically set the same cooking time for all cooking zones. You can find more information about this under

→ "Basic settings", Page 12.



#### Changing or deleting the cooking time

1. Select the cooking zone.
2. Touch .
3. To change the cooking time, touch + or – or set it to .



### 10.2 Timer

Enables the activation of a timer of 0–99 minutes. This function can be used independently of the cooking zones and other settings. It does not automatically switch off the hotplates.

#### Setting the kitchen timer

1. Select the hotplate and touch  twice.
  - ✓ • beside  lights up.
2. Use + or – to select the required time.
  - ✓ The time counts down.



#### Changing or deleting the timer duration

1. Touch  repeatedly until the • display beside  lights up.
2. To change the cooking time, touch + or – or set it to .

## 11 powerBoost

The PowerBoost function enables you to heat up large quantities of water faster than when using power level .

This function is available for all cooking zones, provided the other cooking zone in the same group is not in use.

Otherwise,  and  flash in the display for the selected cooking zone.  is then set automatically without activating the function.

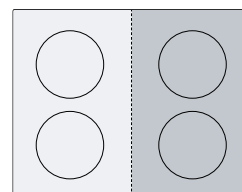

## 11.1 Activating the PowerBoost function

1. Select the cooking zone.
  2. Select power level **9** and then touch the **b** symbol. The **b** display lights up.
- ✓ The function has been activated.

## 11.2 Deactivating the PowerBoost function

1. Select the cooking zone.
  2. Touch the **b** symbol. The **b** display goes out and the cooking zone switches back to power level **9**.
- ✓ The function has now been deactivated.



**Note:** In certain circumstances, the PowerBoost function is automatically switched off in order to protect the electronic elements inside the hob.

# 12 Childproof lock

The hob is equipped with a childproof lock. This prevents children from switching on the hob.

## 12.1 Activating the childproof lock

**Requirement:** The hob must be switched off.

- ▶ Touch and hold  for four seconds.
- ✓ The display beside  lights up for 10 seconds.
- ✓ The hob is now locked.

## 12.2 Deactivating the childproof lock

- ▶ Touch and hold  for four seconds.
- ✓ The lock is released.

## 12.3 Automatic childproof lock

The hob is equipped with an automatic childproof lock. This prevents children from switching on the hob.

### Activating and deactivating

You can find more information about the automatic childproof lock under  
→ "Basic settings", Page 12.

# 13 Individual safety switch-off

The safety function is activated if one cooking zone is in operation for an extended period and you do not change any settings. The cooking zone displays **FB** and switches itself off.



















The time from 1 to 10 hours depends on the selected power level.

Press any button to switch on the cooking zone.

# 14 Basic settings

You can configure the basic settings for your appliance to meet your needs.

## 14.1 Overview of the basic settings

Display	Setting	Value
	Childproof lock	 - Manual. <sup>1</sup>  - Automatic.  - Switched off.
	Audible signals	 - Confirmation and fault signals are switched off.  - Only the fault signal is switched on.  - Only the confirmation signal is switched on.  - All signal tones are switched on <sup>1</sup> .
	Automatic switch-off of the cooking zones.	 - switched off. <sup>1</sup>    - minutes until the appliance switches off automatically.
	Duration of the timer end signal tone	 - 10 seconds <sup>1</sup>  - 30 seconds  - 1 minute

<sup>1</sup> Factory setting

Display	Setting	Value
c 7	Power limitation Enables the total power of the hob to be limited, if necessary, based on the conditions of your electrical installation. The available settings depend on the maximum power of the hob. You can find precise information on the rating plate. If the function is active and the hob has reached the set power limit, _ is displayed and you cannot select a higher power level.	0 - Switched off. Maximum power of the hob <sup>1</sup> . 1 - 1000 W. Lowest power setting. 1. - 1500 W. ... 3 - 3000 W. Recommended for 13 A. 3. - 3500 W. Recommended for 16 A. 4 - 4000 W. 4. - 4500 W. Recommended for 20 A. ... 9 - Maximum power of the hob.
c 9	Time for selecting the cooking zone	0 - Unlimited: You can adjust the last selected cooking zone without having to select it again. <sup>1</sup> 1 - Limited: You can adjust the last selected cooking zone within 10 seconds after selecting it. After this time, you must select the cooking zone again before adjusting it.
c 12	Cookware test You can use this function to test the quality of the cookware.	0 - Not suitable. 1 - Not optimal. 2 - Suitable.
c 17	Set circulating-air mode or air extraction mode.	0 - Configure circulating-air mode. <sup>1</sup> 1 - Configure air extraction mode.
c 18	Setting automatic start	0 - Switched off. 1 - Switched on. <sup>1</sup>
c 20	Setting the run-on If your hob is working in air extraction mode, the ventilation system is switched on at the power level for approx. 6 minutes. If your hob is working in circulating-air mode, the ventilation system is switched on at the power level for approx. 30 minutes. The run-on function automatically switches off after this time.	0 - Switched off. 1 - Switched on <sup>1</sup> :
c 0	Restoring factory settings	0 - Individual settings <sup>1</sup> . 1 - Factory settings.

<sup>1</sup> Factory setting

## 14.2 To go to the basic settings

**Requirement:** The hob must be switched off.

1. To switch on the hob, touch ①.
2. Within the next 10 seconds, touch and hold ⇐ for four seconds.

Product information	Display
Directory for the technical after-sales service (TK)	0 1
Production number	Fd
Production number 1	02.
Production number 2	0.5

- ✓ The first four displays provide the product information. Touch + or - to view the individual displays.

3. Touch ⇐ to access the basic settings.  
✓ c and 1 light up alternately as well as 0 as a preset value.
4. Touch ⇐ repeatedly until the required function is displayed.
5. Use + or - to select the required value.
6. Touch and hold ⇐ for four seconds.  
✓ The settings are saved.

## 14.3 Exiting the basic settings

- ▶ Touch ① to switch off the hob.

# 15 Cookware test

The quality of the cookware has a major influence on the speed and the result of the cooking process. You can use this function to test the quality of the cookware.

Before the test, ensure that the size of the cookware base corresponds to the size of the cooking zone being used.



Access is via the basic settings. → Page 12

## 15.1 Carrying out Cookware test

1. At room temperature, place the cookware with approx. 200 ml water in the centre of the cooking zone that best fits the base of the cookware in terms of size.
2. Call up the basic settings and select  $\epsilon$  12.
3. Touch + or -. The - display flashes in the cooking zones.
  - ✓ The function has been activated.
  - ✓ After 10 seconds, the result appears in the cooking zone displays.

## 15.2 Checking the result

You can see what the result means for the quality and speed of the cooking process in the following table.

Result	
	The cookware is not suitable for the cooking zone and therefore does not heat up.
	The cookware is taking longer to heat up than expected and cooking is not progressing as well as it ought to.
	The cookware is heating up correctly and cooking is progressing well.

**Note:** If you have any unfavourable results, reposition the cookware on a smaller cooking zone, if available.

Touch + or - to activate the function.

# 16 Power limitation

You can use the PowerManager function to set the total power of the hob.

The hob is set at the factory; the hob's maximum power is shown on the rating plate. You can use this function to adjust the configuration to the requirements of each electrical installation.

In order to not exceed this set value, the hob automatically distributes the available power as needed between the cooking zones that are switched on.

While this function is activated, the output of each cooking zone may temporarily fall below the nominal value. In order to not exceed this set value, the hob automatically distributes the available power as needed between the cooking zones that are switched on. The appliance regulates and selects the highest power level automatically.

For more information, go to → "Basic settings", Page 12

# 17 Cleaning and servicing

To keep your appliance working efficiently for a long time, it is important to clean and maintain it carefully.

## 17.1 Cleaning products

You can obtain suitable cleaning products and glass scrapers from customer service, a retailer or the online shop [siemens-home.bsh-group.com](http://siemens-home.bsh-group.com).

### ATTENTION!

Unsuitable cleaning products may damage the surfaces of the appliance.

- ▶ Never use unsuitable cleaning products.
- ▶ Do not use cleaning products while the hob is still hot. This may cause marks on the surface.





### Unsuitable cleaning products

- Undiluted detergent
- Detergent intended for dishwashers
- Abrasive cleaning products
- Aggressive cleaning products such as oven spray or stain remover
- Abrasive sponges
- High-pressure or steam jet cleaners

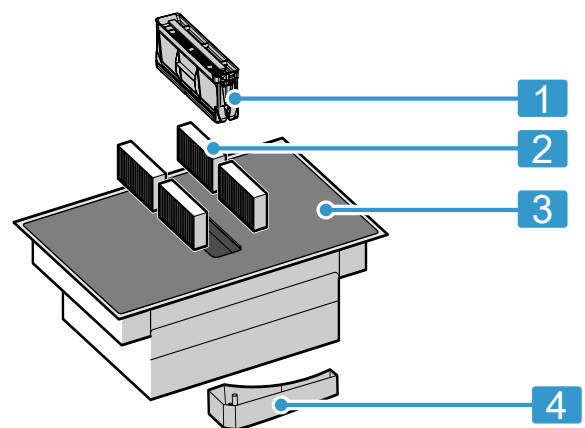
## 17.2 Components to be cleaned or replaced

The following overview shows the components of the appliance that you either replace or clean.



	Grease filter
	Odour filter or acoustics filter
	Glass ceramic
	Overflow container

### 17.3 Cleaning the hob

Clean the hob after every use to stop cooking residues from getting burnt on.

**Requirement:** The hob must be cold. Do not allow the hob to cool down if it has sugar stains, rice starch, plastic or aluminium foil on it.

1. Remove heavy soiling using a glass scraper.
2. Clean the hob with a cleaning agent for glass ceramic. Follow the cleaning instructions on the packaging of the cleaning agent.

#### Tips

- You can achieve good cleaning results using a special sponge for glass ceramic.
- If you keep the base of the cookware clean, the hob surface remains in a good condition.

### 17.4 Cleaning the hob surround

If the hob frame is dirty or stained after use, clean this.

**Note:** Do not use a glass scraper.

1. Clean the hob frame with hot soapy water and a soft cloth. Wash new sponge cloths thoroughly before use.
2. Dry with a soft cloth.

### 17.5 Changing the odour filter or acoustics filter

Change the odour filter regularly. Change the acoustics filters if they are dirty.

**Note:** You can obtain odour filters or acoustics filters from specialist retailers, customer service or in the on-line shop.

1. To keep them in good working order, only use genuine replacement filters.
2. **ATTENTION!** Falling grease filters may damage the hob below.
  - ▶ Grip below the grease filter with one hand.
 Remove the grease filter.
  - Grease may accumulate in the bottom of the container. Hold the grease filter level to prevent grease from dripping out.

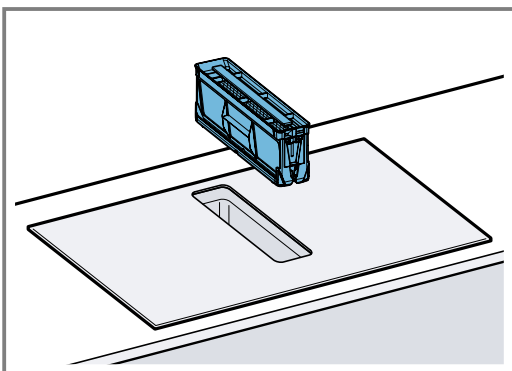

3. Remove the four odour filters or acoustics filters, and dispose of them properly.

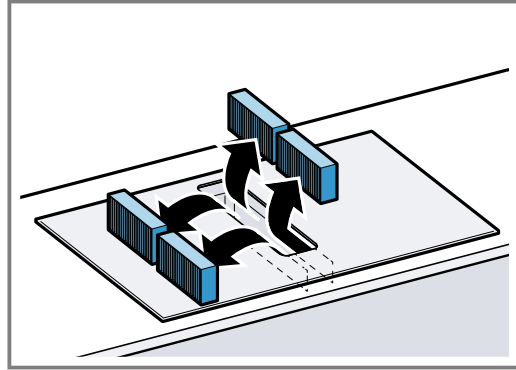

4. Insert two odour filters or acoustics filters into the left and right of the appliance and slide them forwards.

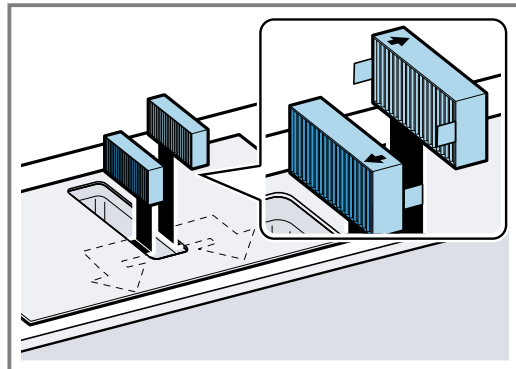

5. Insert the other odour filters or acoustics filters into the left and right of the appliance.

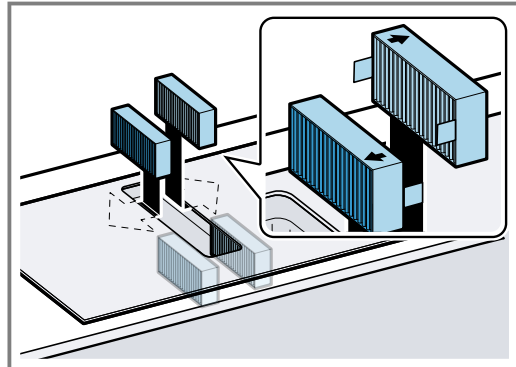

6. Insert the grease filter.

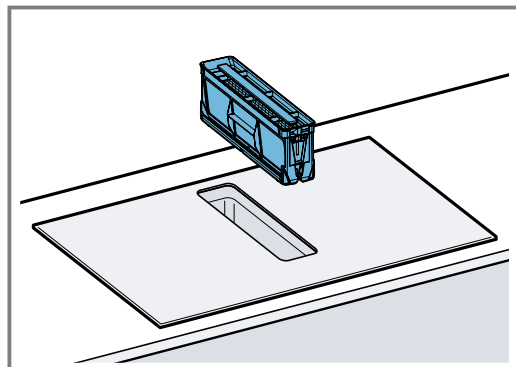

### Resetting the saturation indicator

**Requirement:** After the appliance is switched off, *F* lights up.

1. Replace the odour filter. → Page 15

2. Press and hold  until an audible signal sounds.
  - ✓ The *F* display stops lighting up. The saturation indicator for the odour filters is reset.

## 17.6 Cleaning the grease filters

Grease filters filter the grease from the cooking vapour. To keep it in good working order, you must clean the grease filter regularly.

### **WARNING – Risk of fire!**

Fatty deposits in the grease filters may catch fire.

- ▶ Never operate the appliance without a grease filter.
- ▶ Clean the grease filters regularly.
- ▶ Never work with naked flames close to the appliance (e.g. flambéing).

#### 1. **ATTENTION!**

Falling grease filters may damage the hob below.

- ▶ Grip below the grease filter with one hand.

Remove the grease filter.

- Fat may accumulate in the bottom of the container. Hold the grease filter level to prevent grease from dripping out.

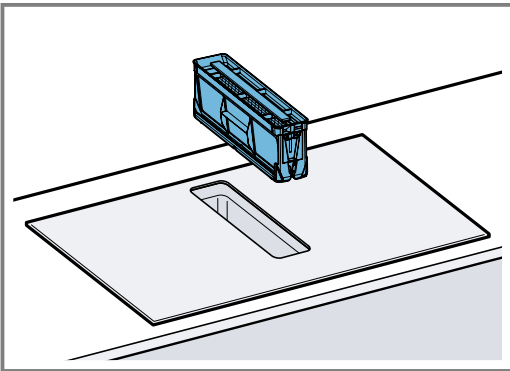

2. Clean the grease filter.
  - → "Cleaning the grease filters manually", Page 16
  - → "Cleaning the grease filter in the dishwasher", Page 16
3. If required, remove the odour filters or acoustics filters and clean the appliance from the inside.  
→ "Changing the odour filter or acoustics filter", Page 15
4. If any objects get into the appliance, remove these objects and ensure that the supply to the overflow container is not blocked.
5. Wipe out the inside of the appliance with soapy water and a dish cloth.
6. After cleaning, reinsert the dried grease filter.

## Cleaning the grease filters manually

1. Dismantle the grease filter.

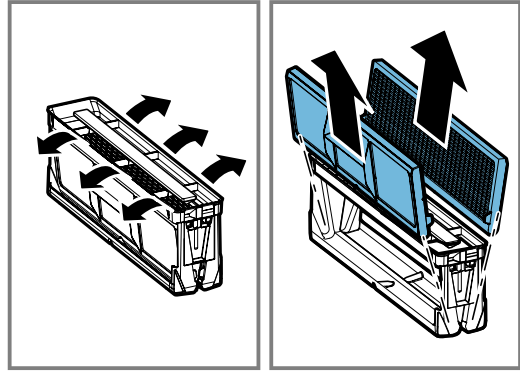

2. Soak the grease filter in hot soapy water.
3. Use a brush to clean the grease filter.  
Do not use aggressive, acidic or alkaline cleaning products.  
Use special grease solvent for stubborn dirt. You can purchase the grease solvent from the after-sales service, through our online shop or in a specialist shop.
4. Rinse the grease filters thoroughly.
5. Allow the grease filters to drain.

## Cleaning the grease filter in the dishwasher

1. For optimum cleaning results, disassemble the grease filter.

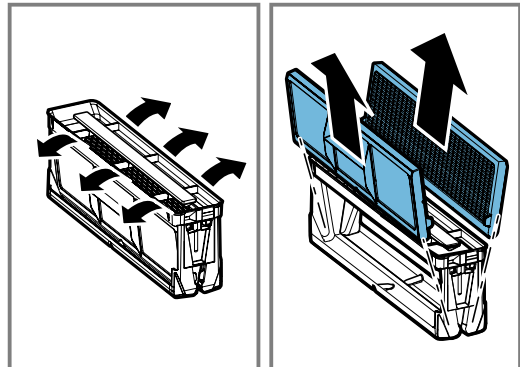

2. Place the individual components of the grease filter loosely in the dishwasher and do not jam them in.

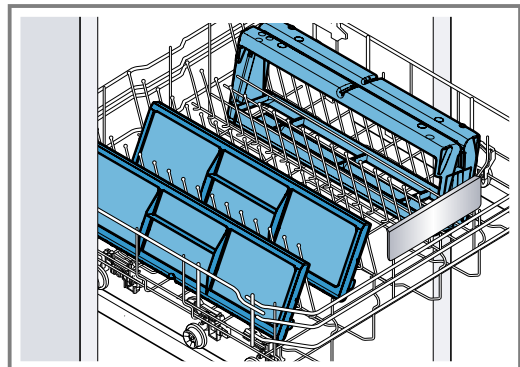

Do not clean heavily soiled grease filters with tableware.

Do not use aggressive, acidic or alkaline cleaning products.

3. Start the dishwasher.  
Select a maximum temperature setting of 70 °C.
4. Leave the grease filter to drain.



## 17.7 Cleaning the overflow container

The overflow container collects liquids or objects that come into the appliance from above.

**Requirement:** The appliance has cooled and the residual heat indicator has gone out.

1. Hold the overflow container with one hand and unscrew it with the other hand.
  - Hold the overflow container level to prevent liquid from leaking out.

2. Empty the overflow container and rinse it out.
3. If required, unscrew the screw and clean the overflow container without the screw in the dishwasher.
4. Clean the overflow container before screwing it back into place.
5. Ensure that the supply to the overflow container is not blocked.  
Remove any objects that have entered the appliance once it has cooled down. To do this, remove the grease filter. → *Page 16*

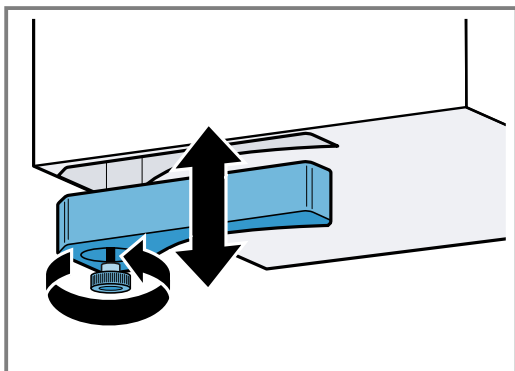

## 18 FAQs

### 18.1 Using the appliance

Question	Answer
Why can I not switch on the hob and why is the childproof lock symbol lit?	<ul style="list-style-type: none"> <li>▪ The childproof lock is activated. You can find further information about this function under → <i>"Childproof lock", Page 12.</i></li> </ul>
Why are the illuminated displays flashing and why is a signal sounding?	<ul style="list-style-type: none"> <li>▪ Clean the surface of the control panel of any liquids or food residue. Remove any objects that may cover the control panel. You can find further information about deactivating the signal tone under → <i>"Basic settings", Page 12.</i></li> </ul>
The ventilation system does not switch on even though the automatic start is activated.	<ul style="list-style-type: none"> <li>▪ Manually activate the ventilation system or check the configuration of the automatic start. You can find additional information about this in the section entitled → <i>"Basic settings", Page 12.</i></li> </ul>
The ventilation system continues to run even though the cooking zones have been switched off.	<ul style="list-style-type: none"> <li>▪ Manually switch off the ventilation system. You can find additional information about this setting in the section entitled → <i>"Basic operation", Page 9.</i></li> </ul>
The air intake is too weak.	<ul style="list-style-type: none"> <li>▪ Ensure that the grease filter is clean. To find out how to clean and replace the filter, refer to the section entitled → <i>"Cleaning and servicing", Page 14.</i></li> </ul>

## 18.2 Noises

Question	Answer
Why can I hear noises while I'm cooking?	<ul style="list-style-type: none"> <li>Noises may be generated while using the hob depending on the base material of the cookware. These noises are normal for induction technology. They do not indicate that there is a fault.</li> </ul>
Possible noises	<ul style="list-style-type: none"> <li><b>A deep humming noise similar to a transformer:</b> Occurs when cooking at a high power level. This noise disappears or becomes quieter when you reduce the power level.</li> <li><b>A quiet whistling noise:</b> This can be heard when the cookware is empty. This noise disappears when you add water or food to the cookware.</li> <li><b>Crackling:</b> This noise occurs when the cookware is made from different multilayer materials, or if you use cookware of different sizes and different materials. The loudness of the noise can vary depending on the quantity of food being cooked or the cooking method.</li> <li><b>Loud whistling noises:</b> These may arise if you are operating two cooking zones at the same time and at the maximum power level. These whistling noises disappear or become quieter when you reduce the power level.</li> <li><b>Fan noises:</b> The hob is equipped with a fan that switches on automatically at high temperatures. The fan may also continue to run after you have switched the hob off if the temperature measured is still too high.</li> </ul>

## 18.3 Items of cookware

Question	Answer
Which cookware is suitable for the induction hob?	<ul style="list-style-type: none"> <li>You can find more information on which items of cookware are compatible with induction cooking in → <i>"Suitable cookware", Page 6.</i></li> </ul>
Why is the cooking zone not heating up and why is the heat setting flashing?	<ul style="list-style-type: none"> <li>The cookware is on a different cooking zone to the one that has been switched on. Ensure that you have switched on the correct cooking zone for the cookware.</li> <li>The cookware is too small for the cooking zone that is switched on or it is not suitable for induction cooking. Ensure that the cookware is suitable for induction cooking and that it is placed on the cooking zone which best corresponds to its size. You can find more information about this under → <i>"Suitable cookware", Page 6.</i></li> </ul>
Why is it taking so long for the cookware to heat up or why is it not heating up sufficiently despite being on a high power setting?	<ul style="list-style-type: none"> <li>The cookware is too small for the cooking zone that is switched on or it is not suitable for induction cooking. Ensure that the cookware is suitable for induction cooking and that it is placed on the cooking zone which best corresponds to its size. You can find more information about this under → <i>"Suitable cookware", Page 6.</i></li> </ul>

## 18.4 Cleaning

Question	Answer
How can I clean the hob?	<ul style="list-style-type: none"> <li>You can achieve the best results by using special glass-ceramic cleaning products. Do not use harsh or abrasive cleaning products, dishwasher detergent (concentrated) or scouring pads. You can find more information about this under → <i>"Cleaning and servicing", Page 14.</i></li> </ul>
There is water in the cabinet underneath the hob.	<ul style="list-style-type: none"> <li>Check whether the overflow container is full. You can find further information about cleaning and caring for the hob under → <i>"Cleaning and servicing", Page 14.</i></li> </ul>

Question	Answer
How often do I need to clean the overflow container?	<ul style="list-style-type: none"> <li>▪ Clean the overflow container frequently. You can find further information about how to clean the overflow container under → "Cleaning and servicing", Page 14.</li> </ul>
How often do I need to clean the grease filter?	<ul style="list-style-type: none"> <li>▪ Regularly clean the grease filter. To find out how to clean and replace the filter, refer to the section entitled → "Cleaning and servicing", Page 14.</li> </ul>

## 19 Troubleshooting

You can rectify minor faults on your appliance yourself. Read the troubleshooting information before contacting after-sales service. This will avoid unnecessary costs.

### **WARNING – Risk of injury!**

Improper repairs are dangerous.

- ▶ Repairs to the appliance should only be carried out by trained specialist staff.
- ▶ If the appliance is defective, call Customer Service.

### **WARNING – Risk of electric shock!**

Incorrect repairs are dangerous.

- ▶ Repairs to the appliance should only be carried out by trained specialist staff.
- ▶ Only use genuine spare parts when repairing the appliance.
- ▶ If the power cord of this appliance is damaged, it must be replaced with a special connection cable, which is available from the manufacturer or his Customer Service.

## 19.1 Warnings

### Notes

- If  $E$  appears in the displays, press and hold the sensor for the respective cooking zone and read the fault code.
- If the fault code is not listed in the table, disconnect the hob from the power supply and wait 30 seconds before reconnecting it. If this display appears again, contact the technical after-sales service and specify the exact fault code.
- If an error occurs, the appliance does not switch to standby mode.
- In order to protect the appliance's electronic parts from overheating or surge currents, the hob may temporarily reduce the power level.

## 19.2 Information on the display panel

Fault	Cause and troubleshooting
No displays light up.	The power supply has been disconnected. <ul style="list-style-type: none"> <li>▶ Use other electrical appliances to check whether there has been a power failure.</li> </ul> The appliance has not been connected as shown in the circuit diagram. <ul style="list-style-type: none"> <li>▶ Connect the appliance in accordance with the circuit diagram.</li> </ul> Electronics fault <ul style="list-style-type: none"> <li>▶ If you are unable to rectify the fault, inform the technical after-sales service.</li> </ul>
The displays flash.	The control panel is wet or an object is covering it. <ul style="list-style-type: none"> <li>▶ Dry the control panel or remove the object.</li> </ul>
$F$	The odour filter is saturated or the saturation indicator lights up even though the filter has been replaced. <ul style="list-style-type: none"> <li>▶ Change the filter and reset the filter saturation indicator. You can find additional information about this in the section entitled → "Cleaning and servicing", Page 14.</li> </ul>
$F2, F4, E 7015, E 8207, E 8208$	The electronics have overheated and one or all of the cooking zones have been switched off. <ul style="list-style-type: none"> <li>▶ Wait until the electronics have cooled down sufficiently. Then touch any button on the control panel.</li> </ul>
$FS$ + power level and audible signal	There is hot cookware in the vicinity of the control panel. This may cause the electronics to overheat. <ul style="list-style-type: none"> <li>▶ Remove the cookware. The fault display goes out shortly afterwards. You can continue to cook.</li> </ul>
$FS$ and signal tone	There is hot cookware in the vicinity of the control panel. The cooking zone has been switched off to protect the electronics. <ul style="list-style-type: none"> <li>▶ Remove the cookware. Wait a few seconds. Touch any button. When the fault display goes out, you can continue cooking.</li> </ul>

Fault	Cause and troubleshooting
<i>F1/F6</i>	The cooking zone has overheated and has been switched off to protect the work surface. ▶ Wait until the electronics have cooled down sufficiently before switching the cooking zone back on.
<i>F8</i>	The cooking zone has been operating continuously for an extended period. ▶ Individual safety switch-off is switched on. Touch any button to switch off the display so that you can set the cooking zone again.
<i>E 9000/E9010</i>	The operating voltage is incorrect and outside of the normal operating range. ▶ Contact your energy supplier.
<i>U400</i>	The hob is not connected correctly. ▶ Disconnect the hob from the mains. Connect the hob in accordance with the circuit diagram.
<i>dE</i>	Demo mode is activated. ▶ Disconnect the hob from the mains. Wait for 30 seconds and connect the hob. Touch any sensor in the next three minutes. Demo mode is deactivated.

### 19.3 Normal noises from your appliance

An induction hob may sometimes cause noises or vibrations, such as buzzing, crackling, hissing noises, fan noises or rhythmic noises.

## 20 Disposal

### 20.1 Disposing of old appliance

Valuable raw materials can be reused by recycling.

1. Unplug the appliance from the mains.
2. Cut through the power cord.
3. Dispose of the appliance in an environmentally friendly manner.  
Information about current disposal methods are available from your specialist dealer or local authority.



This appliance is labelled in accordance with European Directive 2012/19/EU concerning used electrical and electronic appliances (waste electrical and electronic equipment - WEEE). The guideline determines the framework for the return and recycling of used appliances as applicable throughout the EU.

## 21 Customer Service

Function-relevant genuine spare parts according to the corresponding Ecodesign Order can be obtained from Customer Service for a period of at least 10 years from the date on which your appliance was placed on the market within the European Economic Area.

**Note:** Under the terms of the manufacturer's warranty the use of Customer Service is free of charge.

Detailed information on the warranty period and terms of warranty in your country is available from our after-sales service, your retailer or on our website.

If you contact Customer Service, you will require the product number (E-Nr.) and the production number (FD) of your appliance.

The contact details for Customer Service can be found in the enclosed Customer Service directory or on our website.

### 21.1 Product number (E-Nr.) and production number (FD)

You can find the product number (E-Nr.) and the production number (FD) on the appliance's rating plate.

The rating plate can be found:

- On the appliance certificate.
- On the underside of the hob, towards the front.

The product number (E no.) can also be found on the glass ceramic. You can also display the customer service index (KI) and the production number (FD) in the basic settings. → Page 12

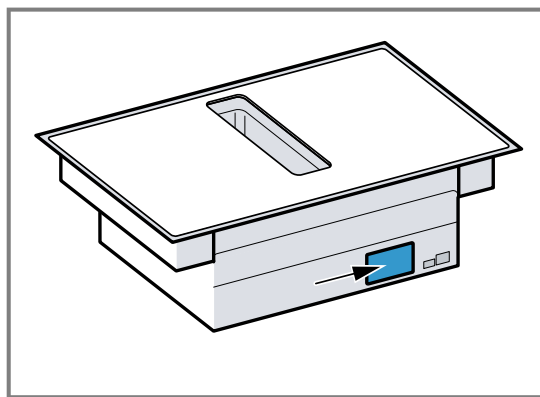

Make a note of your appliance's details and the Customer Service telephone number to find them again quickly.

## 22 Test dishes

These recommended settings are intended for test institutes to facilitate the testing of our appliances. The tests were carried out using our cookware sets for induction hobs. If required, these accessory sets can be purchased at a later point from specialist retailers, or through our technical after-sales service or our online shop.

### 22.1 Melting the chocolate coating

Ingredients: 150 g dark chocolate (55% cocoa).

- 16 cm saucepan without lid
  - Boiling: Power level 1.

### 22.2 Heating and keeping lentil stew warm

Recipe in accordance with DIN 44550

Initial temperature 20 °C

Heating up without stirring

- 16 cm saucepan with lid, amount: 450 g
  - Heating up: Duration 1 min. 30 sec., power level 9
  - Simmering: Power level 1.
- 20 cm saucepan with lid, amount: 800 g
  - Heating up: Duration 2 min. 30 sec., power level 9
  - Simmering: Power level 1.

### 22.3 Heating and keeping lentil stew warm

E.g.: Lentil diameter 5–7 mm. Initial temperature 20 °C

Stir after heating for 1 minute

- 16 cm saucepan with lid, amount: 500 g
  - Heating up: Duration approx. 1 min. 30 sec., power level 9
  - Simmering: Power level 1.
- 20 cm saucepan with lid, amount: 1 kg
  - Heating up: Duration approx. 2 min. 30 sec., power level 9
  - Simmering: Power level 1.

### 22.4 Béchamel sauce

Milk temperature: 7 °C

- 16 cm saucepan without lid, ingredients: 40 g butter, 40 g flour, 0.5 l milk with 3.5% fat content and a pinch of salt

#### Preparing Béchamel sauce

1. Melt the butter, stir in the flour and salt, and heat up the mixture.
  - Heating up: Duration 6 min., power level 2
2. Add the milk to the roux and bring to the boil, stirring continuously.
  - Heating up: Duration 6 min. 30 sec., power level 7
3. Once the Béchamel sauce comes to the boil, leave it on the cooking zone for a further two minutes.
  - Simmering: Power level 2

### 22.5 Cooking rice pudding with the lid on

Milk temperature: 7 °C

1. Heat the milk until it starts to rise up. Heat up without a lid. Stir after heating for 10 min.

2. Set the recommended power level and add rice, sugar and salt to the milk.

The cooking time, including heating up, is approx. 45 minutes.

- 16 cm saucepan, ingredients: 190 g short-grain rice, 90 g sugar, 750 ml milk with 3.5% fat content and 1 g salt
  - Heating up: Duration approx. 5 min. 30 sec., power level 8.
  - Simmering: Power level 3
- 20 cm saucepan, ingredients: 250 g short-grain rice, 120 g sugar, 1 l milk with 3.5% fat content and 1.5 g salt
  - Heating up: Duration approx. 5 min. 30 sec., power level 8.
  - Simmering: Power level 3, stir after 10 minutes

## 22.6 Cooking rice pudding without a lid

Milk temperature: 7 °C

1. Add the ingredients to the milk and heat the mixture up while stirring continuously.
2. Once the milk has reached approx. 90 °C, select the recommended power level and leave it to simmer on a low heat for approx. 50 minutes.
  - 16 cm saucepan without lid, ingredients: 190 g short-grain rice, 90 g sugar, 750 ml milk with 3.5% fat content and 1 g salt
    - Heating up: Duration approx. 5 min. 30 sec., power level 8.
    - Simmering: Power level 3
  - 20 cm saucepan without lid, ingredients: 250 g short-grain rice, 120 g sugar, 1 l milk with 3.5% fat content and 1.5 g salt
    - Heating up: Duration approx. 5 min. 30 sec., power level 8.
    - Simmering: Power level 2.

## 22.7 Cooking rice

Recipe in accordance with DIN 44550

Water temperature: 20 °C

- 16 cm saucepan with lid, ingredients: 125 g long-grain rice, 300 g water and a pinch of salt
  - Heating up: Duration approx. 2 min. 30 sec., power level 9
  - Simmering: Power level 2
- 20 cm saucepan with lid, ingredients: 250g long-grain rice, 600 g water and a pinch of salt
  - Heating up: Duration approx. 2 min. 30 sec., power level 9
  - Simmering: Power level 2.

## 22.8 Roasting a pork loin

Initial temperature of the loin: 7 °C

- 24 cm pan without lid, ingredients: 3 pork loins, total weight approx. 300 g, 1 cm thick, and 15 g sunflower oil
  - Heating up: Duration approx. 1 min. 30 sec., power level 9
  - Simmering: Power level 7

## 22.9 Preparing crêpes

Recipe in accordance with DIN EN 60350-2

- 24 cm pan without lid, ingredients: 55 ml batter per crêpe
  - Heating up: Duration 1 min. 30 sec., power level 9
  - Simmering: Power level 7

## 22.10 Deep-fat frying frozen chips

- Pot dia. 20 cm without lid: ingredients: 2 l sunflower oil. For each frying time: 200 g frozen chips, 1 cm thick.
  - Heating up: Power level 9, until the oil temperature reaches 180 °C.
  - Simmering: Power level 9



**BSH Hausgeräte GmbH**  
Carl-Wery-Straße 34  
81739 München, GERMANY  
[siemens-home.bsh-group.com](http://siemens-home.bsh-group.com)

Valid within Great Britain:  
Imported to Great Britain by  
BSH Home Appliances Ltd.  
Grand Union House  
Old Wolverton Road  
Wolverton, Milton Keynes  
MK12 5PT  
United Kingdom

Manufactured by BSH Hausgeräte GmbH under the trademark licence of Siemens AG



**9001576748** (020930)  
en