

SAMSUNG

FULL MANUAL

HW-Q600B

Imagine the possibilities

Thank you for purchasing this Samsung product.

To receive more complete service, please register your product at www.samsung.com/register

SAFETY INFORMATION









SAFETY WARNINGS

TO REDUCE THE RISK OF ELECTRIC SHOCK, DO NOT REMOVE THE COVER (OR BACK).

NO USER-SERVICEABLE PARTS ARE INSIDE.

REFER SERVICING TO QUALIFIED SERVICE PERSONNEL.

Refer to the table below for an explanation of symbols which may be on your Samsung product.

	<p style="text-align: center;">CAUTION RISK OF ELECTRIC SHOCK. DO NOT OPEN.</p>	
	<p>This symbol indicates that high voltage is present inside. It is dangerous to make any kind of contact with any internal part of this product.</p>	
	<p>This symbol indicates that this product has included important literature concerning operation and maintenance.</p>	
	<p>Class II product : This symbol indicates that it does not require a safety connection to electrical earth (ground). If this symbol is not present on a product with a power cord, the product MUST have a reliable connection to protective earth (ground).</p>	
	<p>AC voltage : This symbol indicates that the rated voltage marked with the symbol is AC voltage.</p>	
	<p>DC voltage : This symbol indicates that the rated voltage marked with the symbol is DC voltage.</p>	
	<p>Caution, Consult instructions for use : This symbol instructs the user to consult the user manual for further safety related information.</p>	

WARNING

- To reduce the risk of fire or electric shock, do not expose this appliance to rain or moisture.

CAUTION

- TO PREVENT ELECTRIC SHOCK, MATCH WIDE BLADE OF PLUG TO WIDE SLOT, FULLY INSERT.
- This apparatus shall always be connected to a AC outlet with a protective grounding connection.
- To disconnect the apparatus from the mains, the plug must be pulled out from the mains socket, therefore the mains plug shall be readily operable.
- Do not expose this apparatus to dripping or splashing. Do not put objects filled with liquids, such as vases on the apparatus.
- To turn this apparatus off completely, you must pull the power plug out of the wall socket. Consequently, the power plug must be easily and readily accessible at all times.

PRECAUTIONS

1. Ensure that the AC power supply in your house complies with the power requirements listed on the identification sticker located on the bottom of your product. Install your product horizontally, on a suitable base (furniture), with enough space around it for ventilation (7~10 cm). Make sure the ventilation slots are not covered. Do not place the unit on amplifiers or other equipment which may become hot. This unit is designed for continuous use. To fully turn off the unit, disconnect the AC plug from the wall outlet. Unplug the unit if you intend to leave it unused for a long period of time.
2. During thunderstorms, disconnect the AC plug from the wall outlet. Voltage peaks due to lightning could damage the unit.
3. Do not expose the unit to direct sunlight or other heat sources. This could lead to overheating and cause the unit to malfunction.
4. Protect the product from moisture (i.e. vases), and excess heat (e.g. a fireplace) or equipment creating strong magnetic or electric fields. Unplug the power cable from the AC wall socket if the unit malfunctions. Your product is not intended for industrial use. It is for personal use only. Condensation may occur if your product has been stored in cold temperatures. If transporting the unit during the winter, wait approximately 2 hours until the unit has reached room temperature before using.
5. The battery used with this product contains chemicals that are harmful to the environment. Do not dispose of the battery in the general household trash. Do not expose the battery to excess heat, direct sunlight, or fire. Do not short circuit, disassemble, or overheat the battery.
CAUTION : Danger of explosion if the battery is replaced incorrectly. Replace only with the same or equivalent type.

CONTENTS

01	Checking the Components	6
02	Product Overview	7
	Front Panel / Top Panel of the Soundbar	7
	Bottom Panel of the Soundbar	8
03	Using the Remote Control	9
	Inserting Batteries before using the Remote Control (AAA batteries X 2)	9
	How to Use the Remote Control	9
	Using the Hidden Buttons (Buttons with more than one function)	13
	Output specifications for the different sound effect modes	13
	Adjusting the Soundbar volume with a TV remote control	14
04	Connecting the Soundbar	15
	Connecting Electrical Power	15
	Connecting the Samsung Wireless Rear Kit to your Soundbar	18
05	Using a wired connection to the TV	19
	Method 1. Connecting with HDMI	19
	Method 2. Connecting using an Optical Cable	21
06	Using a wireless connection to the TV	23
	Connecting via Bluetooth	23
07	Connecting an External Device	25
	Method 1. Connecting using an HDMI Cable (Capable of Dolby Atmos® decoding and playback)	25
	Method 2. Connecting using an Optical Cable	26

08	Connecting a USB drive	27
09	Connecting a Mobile Device	28
	Connecting via Bluetooth	28
	Using Tap Sound	32
10	Installing the Wall Mount	33
	Installation Precautions	33
	Wallmount Components	33
11	Installing the Soundbar in front of TV	35
12	Software Update	36
	USB Update	36
	Reset	37
13	Troubleshooting	38
14	Licence	40
15	Open Source Licence Notice	41
16	Important Notes About Service	41
17	Specifications and Guide	42
	Specifications	42

01 CHECKING THE COMPONENTS

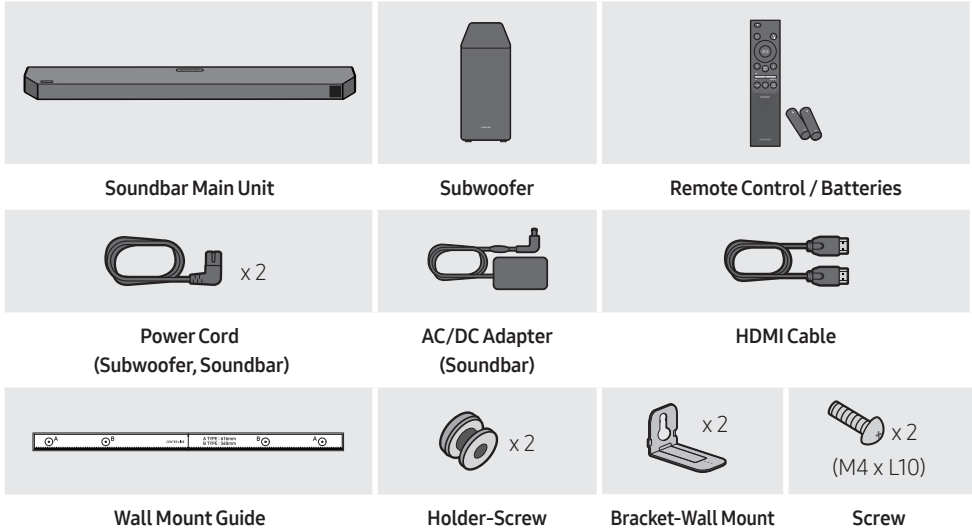

- For more information about the power supply and power consumption, refer to the label attached to the product. (Label: Bottom of the Soundbar Main Unit)
- To purchase additional components or optional cables, contact a Samsung Service Centre or Samsung Customer Care.
- For more information about the wallmount see page 33.
- Design and specifications are subject to change without prior notice.
- The appearance of the components may differ slightly from the illustrations above.

02 PRODUCT OVERVIEW

Front Panel / Top Panel of the Soundbar

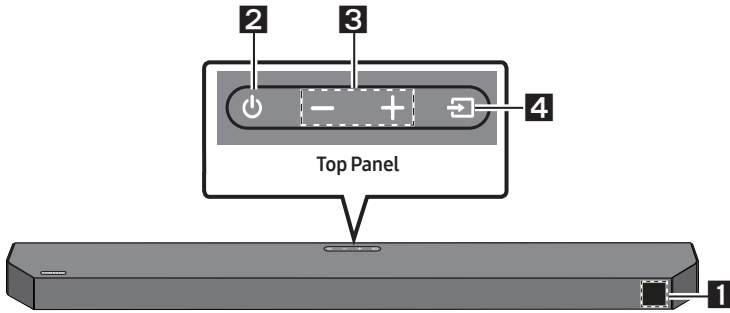

1	<p>Display Displays the product's status and current mode.</p>												
2	<p>⏻ (Power) Button Turns the power on and off.</p> <ul style="list-style-type: none"> • Auto Power Down Function The unit turns off automatically in the following situations: <ul style="list-style-type: none"> – In D.IN / HDMI / BT / USB Mode : If there is no audio signal for 18 minutes. 												
3	<p>– + (Volume) Button Adjusts the volume.</p> <ul style="list-style-type: none"> • When adjusted, the volume level appears on the Soundbar's front display. 												
4	<p>↔ (Source) Button Selects the source input mode.</p> <table border="1" style="width: 100%; border-collapse: collapse;"> <thead> <tr> <th style="text-align: center;">Input mode</th> <th style="text-align: center;">Display</th> </tr> </thead> <tbody> <tr> <td style="text-align: center;">Optical</td> <td style="text-align: center;">D.IN</td> </tr> <tr> <td style="text-align: center;">eARC/ARC (HDMI OUT)</td> <td style="text-align: center;">* D.IN → TV eARC (Auto conversion) D.IN → TV ARC (Auto conversion)</td> </tr> <tr> <td style="text-align: center;">HDMI</td> <td style="text-align: center;">HDMI</td> </tr> <tr> <td style="text-align: center;">BLUETOOTH mode</td> <td style="text-align: center;">BT</td> </tr> <tr> <td style="text-align: center;">USB mode</td> <td style="text-align: center;">USB</td> </tr> </tbody> </table> <ul style="list-style-type: none"> • To turn on "BT PAIRING" mode, change the source to "BT" mode, and then press and hold the ↔ (Source) button for more than 5 seconds. 	Input mode	Display	Optical	D.IN	eARC/ARC (HDMI OUT)	* D.IN → TV eARC (Auto conversion) D.IN → TV ARC (Auto conversion)	HDMI	HDMI	BLUETOOTH mode	BT	USB mode	USB
Input mode	Display												
Optical	D.IN												
eARC/ARC (HDMI OUT)	* D.IN → TV eARC (Auto conversion) D.IN → TV ARC (Auto conversion)												
HDMI	HDMI												
BLUETOOTH mode	BT												
USB mode	USB												

- **"*"** mode is supported when the eARC function in the TV setting is On.
- When you plug in the AC cord, the power button will begin working in 4 to 6 seconds.

- When you turn on this unit, there will be a 4 to 5 second delay before it produces sound.
- If you hear sounds from both the TV and Soundbar, go to the **Settings** menu for the TV audio and change the TV speaker to **External Speaker**.

Bottom Panel of the Soundbar

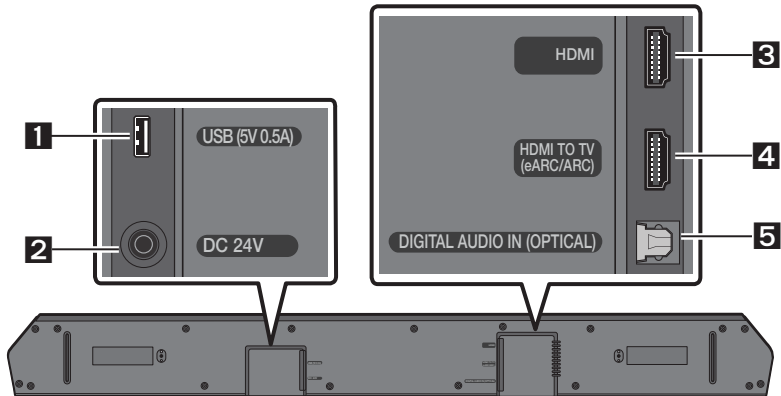

1	USB (5V 0.5A) Connect a USB drive here to play music files stored on the USB drive through the Soundbar.
2	DC 24V (Power Supply In) Connect the AC/DC power adapter.
3	HDMI Inputs digital video and audio signals simultaneously using an HDMI cable. Connect to the HDMI output of an external device.
4	HDMI TO TV (eARC/ARC) Connect to the HDMI IN (ARC) port on a TV.
5	DIGITAL AUDIO IN (OPTICAL) Connect to the digital (optical) output of an external device.

- When disconnecting the power cable of the AC/DC power adapter from a wall outlet, pull the plug. Do not pull the cable.
- Do not connect this unit or other components to an AC outlet until all connections between components are complete.

03 USING THE REMOTE CONTROL

Inserting Batteries before using the Remote Control (AAA batteries X 2)



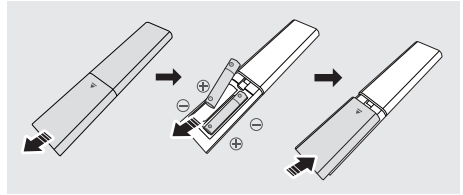

Slide the back cover in the direction of the arrow until it is completely removed.



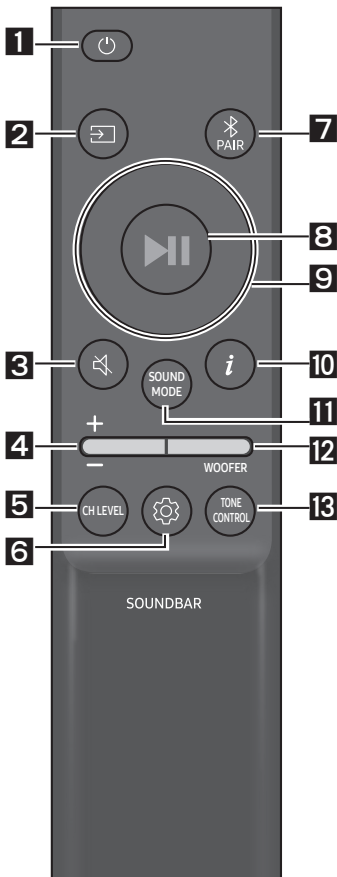



Insert 2 AAA batteries (1.5V) oriented so that their polarity is correct. Slide the back cover back into position.

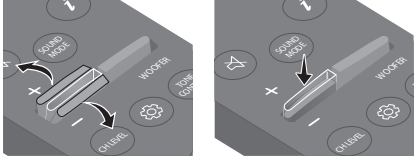







How to Use the Remote Control



<p>1</p>  <p>Power</p>	<p>Turns the Soundbar on and off.</p>
<p>2</p>  <p>Source</p>	<p>Press to select a source connected to the Soundbar.</p>
<p>3</p>  <p>Mute</p>	<p>Press the Mute button to mute the sound. Press it again to unmute the sound.</p>
<p>4</p>  <p>Volume</p>	 <p>Push the button up or down to adjust the volume.</p> <ul style="list-style-type: none"> • Mute Press the Volume button in to mute the sound. Press it in again to unmute the sound.

<p>5</p>	 <p>CH LEVEL</p>	<p>By pressing the button, you can adjust the volume of the each speaker.</p> <ul style="list-style-type: none"> • Press the button to select CENTER LEVEL or TOP LEVEL and then adjust the volume between -6~+6 by using the Up/Down buttons. • If the Rear Speakers (sold separately) are connected, the setting REAR LEVEL is supported. To adjust the volume of the REAR LEVEL between -6 to +6 by using the Up/Down buttons.
<p>6</p>	 <p>Sound Control</p>	<p>By pressing the button, you can set the audio function. The desired settings can be adjusted using the Up/Down buttons.</p> <p>VOICE ENHANCE ON/OFF → NIGHT MODE ON/OFF → AUDIO SYNC → VIRTUAL ON/OFF</p> <ul style="list-style-type: none"> – VOICE ENHANCE ON/OFF This mode is makes it easier to hear spoken dialog in movies and TV. – NIGHT MODE ON/OFF This mode is optimized for nighttime viewing with the settings adjusted to bring the volume down but keep the dialog clear. – AUDIO SYNC If the video on the TV and audio from the Soundbar are not synchronized, press the  (Sound Control) button to select AUDIO SYNC and then set the audio delay between 0~300 milliseconds by using the Up/Down buttons. (Not available in “USB” or “BT” mode.) – VIRTUAL ON/OFF Dolby Virtual function can be turned ON/OFF. • The VOICE ENHANCE, NIGHT MODE, and VIRTUAL audio function can be turned ON/OFF by using the Up/Down buttons. (VIRTUAL function is not available in “USB” or “BT” mode.) • Press and hold the  (Sound Control) button for about 5 seconds to adjust the sound for each frequency band. 150Hz, 300Hz, 600Hz, 1.2kHz, 2.5kHz, 5kHz, and 10kHz are selectable using the Left/Right buttons and each can be adjusted to a setting between -6 to +6 using the Up/Down buttons. (Make sure the Sound mode is set to “STANDARD”).
<p>7</p>	 <p>Bluetooth PAIR</p>	<p>Switch the Soundbar to Bluetooth pairing mode. Press the  PAIR button and wait for the “BT PAIRING” screen to connect to a new Bluetooth device.</p>
<p>8</p>	 <p>Play / Pause</p>	<p>You can also play or pause music by pressing the button.</p>

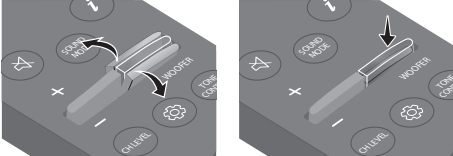
<p>9</p>  <p>Up/Down/ Left/Right</p>	 <p>Press the indicated areas to select Up/Down/Left/Right.</p> <p>Press Up/Down/Left/Right on the button to select or set functions.</p> <ul style="list-style-type: none"> • Repeat To use the Repeat function in "USB" mode, press the Up button. • Music Skip Press the Right button to select the next music file. Press the Left button to select the previous music file. • ID SET Press and hold the Up button for 5 seconds to complete ID SET (when connecting to a wireless subwoofer or wireless rear speakers).
<p>10</p>  <p>Info</p>	<p>When pressed, the information for each mode appears. (See page 7.)</p>
<p>11</p>  <p>SOUND MODE</p>	<p>By pressing the button, you can select the desired sound mode.</p> <p>SURROUND SOUND → GAME PRO → ADAPTIVE SOUND → STANDARD</p> <ul style="list-style-type: none"> – SURROUND SOUND Provides a wider sound field than standard. – GAME PRO Provides stereoscopic sound to immerse you in the action while gaming. – ADAPTIVE SOUND Analyzes the content in real time and automatically provides an optimal sound field based on the characteristics of the content. – STANDARD Outputs the original sound. • DRC (Dynamic Range Control) Lets you apply dynamic range control to Dolby Digital tracks. Press and hold the SOUND MODE button for more than 5 seconds while the Soundbar is powered off to turn DRC (Dynamic Range Control) on or off. With the DRC turned on, loud sound is reduced. (The sound may be distorted.) • Bluetooth Power This feature automatically turns the Soundbar on when it receives a connection request from a previously connected TV or Bluetooth device. The setting is On by default. <ul style="list-style-type: none"> – Press and hold the SOUND MODE button for more than 5 seconds to turn off the Bluetooth Power function.

<p>12</p>	 <p>WOOFER</p> <p>WOOFER (BASS) LEVEL</p>	 <p>Push the button up or down to adjust the level of the woofer (bass) to -12 or between -6 to +6. To set the woofer (bass) volume level to 0 (Default), press the button.</p>
<p>13</p>	 <p>TONE CONTROL</p>	<p>By pressing the button, you can adjust the volume of the treble or bass sound.</p> <ul style="list-style-type: none"> • Press the button to select TREBLE or BASS and then adjust the volume between -6~+6 by using the Up/Down buttons.

Using the Hidden Buttons (Buttons with more than one function)

Hidden Button		Reference page
Remote Control Button	Function	
WOOFER (Up)	TV remote control On/Off (Standby)	page 14
Left	TV Auto connect On/Off (BT Ready)	page 24
Up	ID SET	page 11
 (Sound Control)	7 Band EQ	page 10
SOUND MODE	DRC ON/OFF (Standby)	page 11
	Bluetooth Power	page 11

Output specifications for the different sound effect modes

Effect		Input	Output	
			With Subwoofer Only	With Subwoofer & Wireless Rear Speaker Kit
 SOUND MODE	SURROUND SOUND	2.0 ch	3.1.2 ch	5.1.2 ch
		5.1 ch	3.1.2 ch	5.1.2 ch
		Dolby Atmos®, DTS:X	3.1.2 ch	5.1.2 ch
	GAME PRO	2.0 ch	3.1.2 ch	5.1.2 ch
		5.1 ch	3.1.2 ch	5.1.2 ch
		Dolby Atmos®, DTS:X	3.1.2 ch	5.1.2 ch
	ADAPTIVE SOUND	2.0 ch	3.1.2 ch	5.1.2 ch
		5.1 ch	3.1.2 ch	5.1.2 ch
		Dolby Atmos®, DTS:X	3.1.2 ch	5.1.2 ch
	STANDARD	2.0 ch	2.1 ch	2.1 ch
		5.1 ch	3.1 ch	5.1 ch
		Dolby Atmos®, DTS:X	3.1.2 ch	5.1.2 ch







- The Samsung Wireless Rear Speaker Kit can be purchased separately. To purchase a Kit, contact the vendor you purchased the Soundbar from.
- When the input source is Dolby Atmos®, DTS:X, the Subwoofer-only setup provides 3.1.2 channel audio, while the Subwoofer & Wireless Rear Speaker Kit setup provides 5.1.2 channel audio.
- The Rear Speakers will not produce sounds for 2 channel output while **STANDARD** mode is in use. To enable sound for the Rear Speakers, change the effect mode to **SURROUND SOUND**.

Adjusting the Soundbar volume with a TV remote control

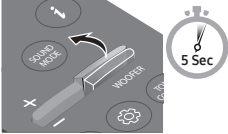
Adjust the Soundbar volume using the TV's remote control.

- This function can be used with IR remote controls only. Bluetooth remote controls (remote controls that require pairing) are not supported.
- Set the TV speaker to **External Speaker** to use this function.
- Manufacturers supporting this function:
Samsung, VIZIO, LG, Sony, Sharp, PHILIPS, PANASONIC, TOSHIBA, Hisense, RCA

1. Turn Off the Soundbar.
2. Push up and hold the **WOOFER** button for 5 seconds.
Each time you push the **WOOFER** button up and hold it for 5 seconds, the mode switches in the following order: "**OFF-TV REMOTE**" (Default mode), "**SAMSUNG-TV REMOTE**", "**ALL-TV REMOTE**".

Remote Control Button	Display	Status
	(Default mode) OFF-TV REMOTE 	Disable the TV remote control.
	SAMSUNG-TV REMOTE 	Enable a Samsung TV's IR remote control.
	ALL-TV REMOTE 	Enable a third-party TV's IR remote control.

04 CONNECTING THE SOUNDBAR

Connecting Electrical Power

Use the power components to connect the Subwoofer and Soundbar to an electrical outlet in the following order:

- For more information about the required electrical power and power consumption, refer to the label attached to the product. (Label: Bottom of the Soundbar Main Unit)
1. Connect the power cord to the Subwoofer.
 2. Connect the power cord to the AC/DC adapter. Connect the AC/DC adapter (with the power cord) to the Soundbar.
 3. Connect power to the Soundbar and Subwoofer.
 - Connect power to the Subwoofer first. The Subwoofer will be automatically connected when turning on the Soundbar.

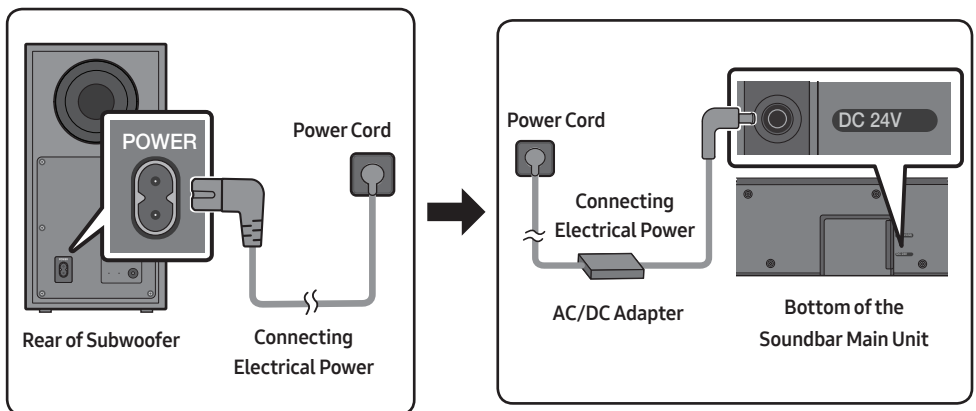

- Make sure to rest the AC/DC Adapter flat on a table or the floor. If you place the AC/DC Adapter so that it is hanging with the AC cord input facing upwards, water or other foreign substances could enter the Adapter and cause the Adapter to malfunction.
- If you unplug and reconnect the power cord when the product is turned on, the Soundbar turns on automatically.

Manually connecting the Subwoofer if automatic connection fails

Before performing the manual connection procedure below:

- Check whether the power cables for the Soundbar and subwoofer are connected properly.
- Make sure that the Soundbar is turned on.

1. Press and hold **ID SET** on the rear of the subwoofer for at least 5 seconds.
 - The red indicator on the rear of the subwoofer turns off and the blue indicator blinks.

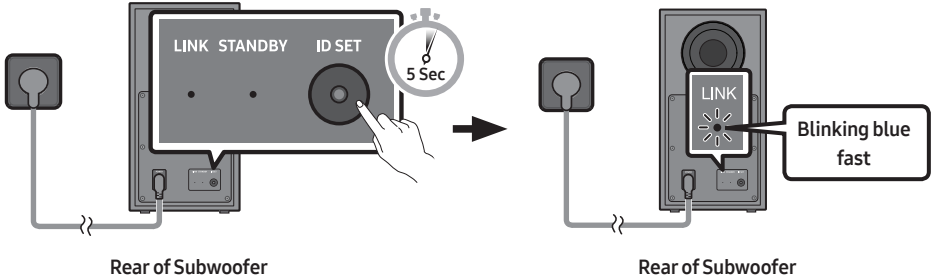

2. Press and hold the **Up** button on the remote control for at least 5 seconds.
 - The **ID SET** message appears on the display of the Soundbar for a moment, and then it disappears.
 - The Soundbar will automatically power on when **ID SET** is complete.

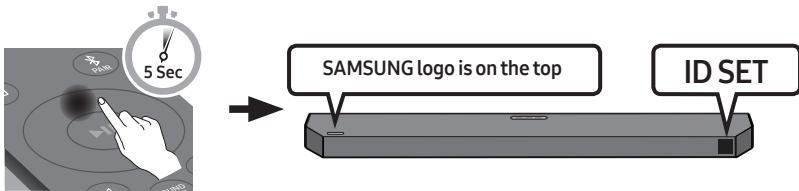

3. Check if the LINK LED is solid blue (connection complete).

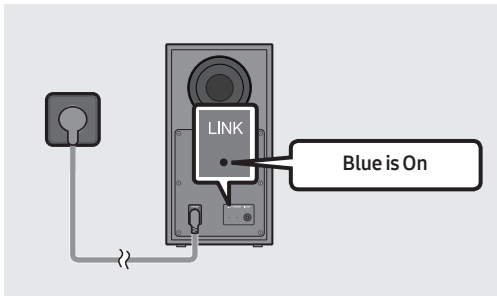

The LINK LED indicator stops blinking and glows a solid blue when a connection is established between the Soundbar and the Wireless Subwoofer.

LED Indicator Lights on the Rear of Subwoofer

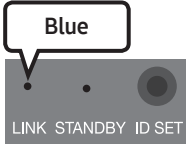
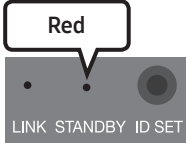
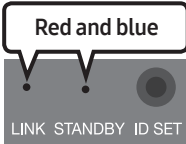
LED	Status	Description	Resolution
	On	Successfully connected (normal operation)	-
	Blinking	Recovering the connection	Check if the power cable attached to the main Soundbar unit is connected properly or wait about 5 minutes. If blinking persists, try manually connecting the subwoofer. See page 16.
	On	Standby (with the Soundbar main unit turned off)	Check if the power cable attached to the main Soundbar unit is connected properly.
		Connection failed	Connect again. See the instructions for manual connection on page 16.
	Blinking	Malfunction	See the contact information for the Samsung Service Centre in this manual.

NOTES

- Do not connect the power cord of this product or your TV to a wall outlet until all connections between components are complete.
- Before moving or installing this product, be sure to turn off the power and disconnect the power cord.
- If the main unit is powered off, the wireless subwoofer will go into stand-by mode and the STANDBY LED on the rear of the sub-woofer will turn red after blinking blue several times.
- If you use a device that uses the same frequency as the Soundbar near the Soundbar, interference may cause some sound interruption.
- The maximum transmission distance of the main unit's wireless signal is about 10 m, but may vary depending on your operating environment. If a steel-concrete or metallic wall is between the main unit and the wireless subwoofer, the system may not operate at all because the wireless signal cannot penetrate metal.

 **CAUTION**

- Wireless receiving antennas are built into the wireless subwoofer. Keep the unit away from water and moisture.
- For optimal listening performance, make sure that the area around the wireless subwoofer and the Wireless Receiver Module (sold separately) is clear of any obstructions.

Connecting the Samsung Wireless Rear Kit to your Soundbar

Expand to true wireless surround sound by connecting the Samsung Wireless Rear Speaker Kit (SWA-9100S or SWA-9200S sold separately) to your Soundbar.

For detailed information on connections, see the Samsung Wireless Rear Speaker Kit manual.

05 USING A WIRED CONNECTION TO THE TV

Method 1. Connecting with HDMI

Connecting the TV that supports HDMI ARC/eARC (Audio Return Channel/ Enhanced Audio Return Channel)

CAUTION

- When both the HDMI cable and optical cable are connected, the HDMI signal is received first.
- To connect the HDMI cable between the TV and Soundbar, be sure to connect the terminals marked ARC or eARC. Otherwise, the TV sound may not be output.
- The recommended cable is **High Speed HDMI Cable with Ethernet**.
- When connecting a TV that supports the eARC function, “**TV eARC**” appears on the display and the sound is heard.
- Dolby Atmos® is supported in the ARC/eARC function.
- TV port can be marked eARC depending on the TV.

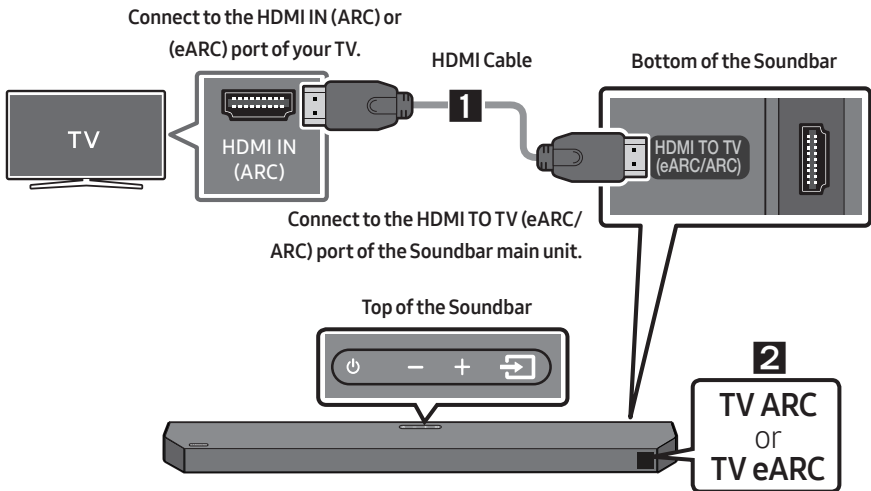

1. With the Soundbar and TV turned on, connect the HDMI cable as shown in the figure.
2. “**TV ARC**” or “**TV eARC**” appears in the display window of the Soundbar main unit and the Soundbar plays TV sound.
 - “**TV eARC**” is displayed when the eARC function in the TV setting is On.

- To connect with eARC, the eARC function in the TV menu should be set to On. Refer to the TV user manual for details on setting. (e.g. Samsung TV : Home (🏠) → Menu → Settings (⚙️) → All Settings (⚙️) → Sound → Expert Settings → HDMI-eARC Mode (Auto))
- If TV sound is inaudible, press the  (**Source**) button on the remote control or on the top of the Soundbar to switch to “**D.IN**” mode. The screen displays “**D.IN**” and “**TV ARC**” or “**TV eARC**” in sequence, and TV sound is played.
- If “**TV ARC**” or “**TV eARC**” does not appear in the display window of the Soundbar main unit, confirm that the HDMI cable is connected to the correct port.
- Use the volume buttons on the TV’s remote control to change the volume on the Soundbar.

NOTES

- When you connect the TV that supports the HDMI ARC/eARC (Audio Return Channel/Enhanced Audio Return Channel) to the Soundbar with an HDMI cable, you can transmit the digital video and audio data without connecting a separate optical cable.
- We recommend you use a coreless HDMI cable if possible. If you use a cored HDMI cable, use one whose diameter is less than 14 mm.
- This function is not available if the HDMI cable does not support ARC or eARC.
- ARC and eARC differ in bandwidth. eARC that is enhanced version of the audio return channel has significantly higher bandwidth than ARC. Higher bandwidth increases the amount of data that can be transmitted. So, with the eARC channel, you can enjoy the sound through formats such as Dolby Atmos® and DTS:X.
- When the audio in a broadcast is encoded in Dolby Digital and the “Digital Output Audio Format” on your TV is set to PCM, we recommend that you change the setting to Dolby Digital. When the setting on the TV is changed, you will experience better sound quality. (The TV menu may use different words for Dolby Digital and PCM depending on the TV manufacturer.)

Method 2. Connecting using an Optical Cable

Pre-connection Checklist

- When both the HDMI cable and optical cable are connected, the HDMI signal is received first.
- When you use an optical cable and the terminals have covers, be sure to remove the covers.

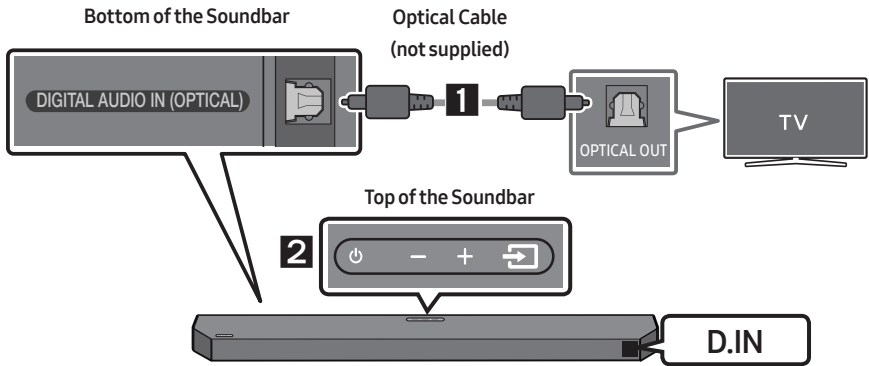

1. Connect the **DIGITAL AUDIO IN (OPTICAL)** port on the Soundbar to the OPTICAL OUT port of the TV with a digital Optical Cable (not supplied).
2. Press the  (**Source**) button on the top panel or remote control, and then select the “**D.IN**” mode.
3. The TV sound is output from the Soundbar.

Using the Q-Symphony Function

For Q-Symphony, the Soundbar syncs with a Samsung TV to output sound through two devices for optimum surround effect. When the Soundbar is connected, the menu, “**TV+Soundbar**” appears under the **Sound Output** menu of the TV. Select the corresponding menu.

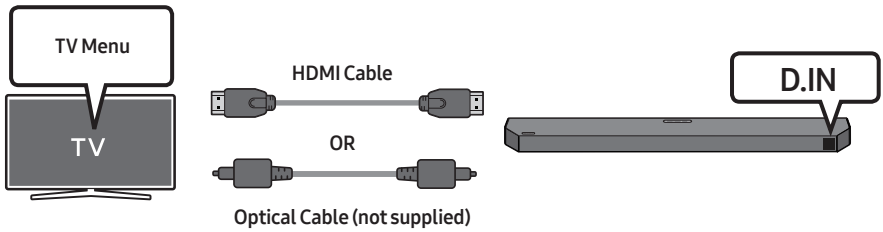

- TV menu example: **TV + [AV] Soundbar series name (HDMI)**

NOTES

- It can operate according to the Codec supported by TV.
- This function is supported only when the HDMI Cable or Optical Cable (not supplied) is connected.
- The message displayed may differ with the TV model.
- This function is available in some Samsung TVs and some Soundbar models.

06 USING A WIRELESS CONNECTION TO THE TV

Connecting via Bluetooth

When a TV is connected using Bluetooth, you can hear stereo sound without the hassle of cabling.

- Only one TV can be connected at a time.

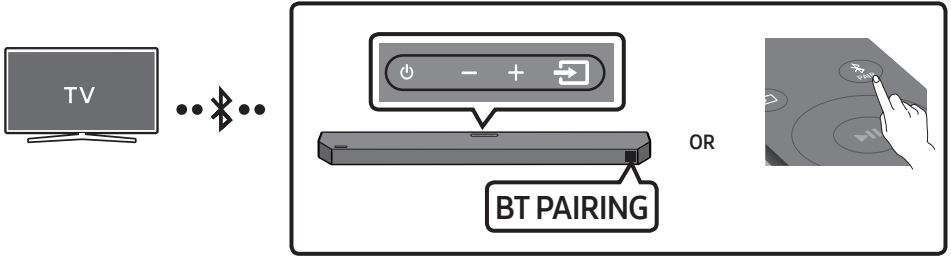

The initial connection

1. Press the **PAIR** button on the remote control to enter the “**BT PAIRING**” mode.

(OR) a. Press the **(Source)** button on the top panel and then select “**BT**”.

“**BT**” changes to “**BT PAIRING**” in a few seconds automatically or changes to “**BT READY**” if there is a connect record.

- b. When “**BT READY**” appears, press and hold the **(Source)** button on the top panel of the Soundbar for more than 5 seconds to display “**BT PAIRING**”.

2. Select Bluetooth mode on the TV. (For more information, see the TV’s manual.)

3. Select “[**AV**] Samsung Soundbar Q6B-Series” from the list on TV’s screen.

An available Soundbar is indicated with “**Need Pairing**” or “**Paired**” on the TV’s Bluetooth device list. To connect the TV to the Soundbar, select the message, and then establish a connection.

- When the TV is connected, [**TV Name**] → “**BT**” appears on the Soundbar’s front display.

4. You can now hear TV sound from the Soundbar.

- After you have connected the Soundbar to your TV the first time, use the “**BT READY**” mode to reconnect.

If the device fails to connect



- If a previously connected Soundbar listing (e.g. “[**AV**] Samsung Soundbar Q6B-Series”) appears in the list, delete it.
- Then repeat steps 1 through 3.

Disconnecting the Soundbar from the TV

Press the  (**Source**) button on the top panel or on the remote control and switch to any mode but “**BT**”.

- Disconnecting takes time because the TV must receive a response from the Soundbar. (The time required may differ, depending on the TV model.)
- To cancel the automatic Bluetooth connection between the Soundbar and TV, press the **Left** button on the remote control for 5 seconds with the Soundbar in “**BT READY**” status. (Toggle On → Off)

What is the difference between BT READY and BT PAIRING?

- **BT READY** : In this mode, you can reconnect TV or mobile device that was connected before.
- **BT PAIRING** : In this mode, you can connect a new device to the Soundbar. (Press the  **PAIR** button on the remote control or press and hold the  (**Source**) button on the top of the Soundbar for more than 5 seconds while the Soundbar is in “**BT**” mode.)

Notes on Bluetooth connection

- Locate a new device within 1 m to connect via Bluetooth communication.
- If asked for a PIN code when connecting a Bluetooth device, enter <0000>.
- In Bluetooth connection mode, the Bluetooth connection will be lost if the distance between the Soundbar and the Bluetooth device exceeds 10 meters.
- The Soundbar automatically turns off after 18 minutes in the Ready state.
- The Soundbar may not perform Bluetooth search or connection correctly under the following circumstances:
 - If there is a strong electrical field around the Soundbar.
 - If several Bluetooth devices are simultaneously paired with the Soundbar.
 - If the Bluetooth device is turned off, not in place, or malfunctions.
- Electronic devices may cause radio interference. Devices that generate electromagnetic waves must be kept away from the Soundbar main unit - e.g., microwaves, wireless LAN devices, etc.

07 CONNECTING AN EXTERNAL DEVICE

Method 1. Connecting using an HDMI Cable (Capable of Dolby Atmos® decoding and playback)

Pre-connection Checklist

- If the Audio Output options include Secondary Audio, make sure Secondary Audio is set to Off.
- Make sure that the content supports Dolby Atmos®.
- TV port can be marked eARC depending on the TV.

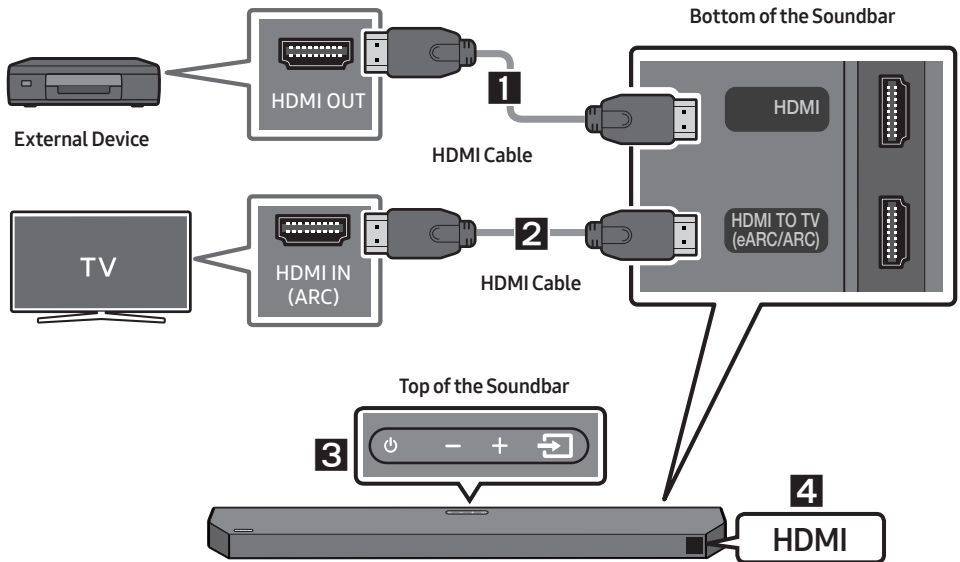

1. Connect an HDMI cable from the **HDMI** port on the bottom of the Soundbar to the HDMI OUT port on your digital device.
2. Connect an HDMI cable from the **HDMI TO TV (eARC/ARC)** port on the bottom of the Soundbar to the HDMI IN (ARC) port on your TV.
3. Press the  (**Source**) button on the top panel or on the remote control, and then select "HDMI".
4. "HDMI" mode is displayed on the Soundbar display panel and sound plays.

NOTES

- **When you use Dolby Atmos®:** If the input source is Dolby Atmos®, 3.1.2 channels are output.
- When Dolby Atmos® is activated, “**DOLBY ATMOS**” appears in the front display.
- **Configuring Dolby Atmos® on your BD player or other device.**
Open the audio output options on the settings menu of your BD player or other device and make sure that “No Encoding” is selected for Bitstream. For example, on a Samsung BD Player, go to Home Menu → Sound → Digital Output and then select Bitstream (unprocessed).
- HDMI Pass-Through is that the Soundbar plays the audio from the source through its own speakers and sends the unaltered video signal to a TV via the second HDMI cable.

Supported UHD Signals Specification (3840 x 2160p)

Frame rate (fps)	Colour depth	RGB 4:4:4	YCbCr 4:4:4	YCbCr 4:2:2	YCbCr 4:2:0
< 60	8 bit	○	○	○	○
	10 bit	-	-	○	○
	12 bit	-	-	○	○
120	8 bit	-	-	-	-
	10 bit	-	-	-	-

- Supported specification may vary depending on the connected external device or usage conditions.

Method 2. Connecting using an Optical Cable

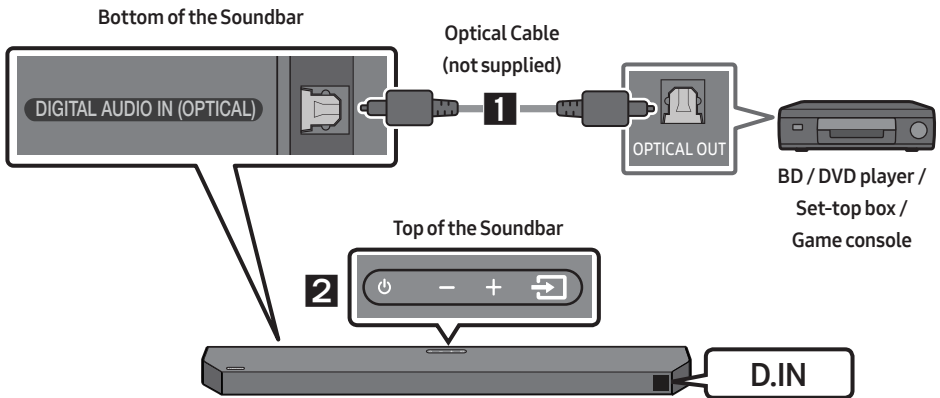

1. Connect the **DIGITAL AUDIO IN (OPTICAL)** port on the Soundbar and the **OPTICAL OUT** port on the external device with the optical cable (not supplied), as shown in the figure.
2. Select “**D.IN**” mode by pressing the  (**Source**) button on the top panel or on the remote control.
3. The external device sound is output from the Soundbar.

08 CONNECTING A USB DRIVE

You can play music files located on USB drive through the Soundbar.

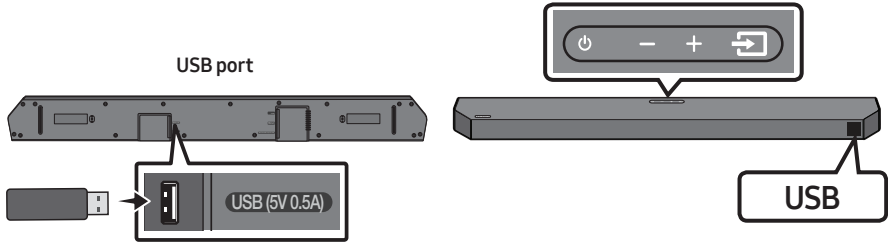

1. Connect the USB drive to the USB port on the bottom of the product.
2. Press the  (**Source**) button on the top panel or on the remote control, and then select “USB”.
3. “USB” appears in the display screen.
4. Play music files from the USB drive through the Soundbar.
 - The Soundbar automatically turns off (Auto Power Down) if there is no audio signal from USB drive or no USB drive connection for more than 18 minutes.

File Format Type Compatibility list

Extension	Codec	Sampling Rate	Bit Rate
*.mp3	MPEG1 Layer2	32kHz ~ 48kHz	32kbps ~ 320kbps
	MPEG1 Layer3	32kHz ~ 48kHz	32kbps ~ 320kbps
	MPEG2 Layer3	16kHz ~ 24kHz	8kbps ~ 160kbps
	MPEG2.5 Layer3	8kHz ~ 12kHz	8kbps ~ 160kbps
*.wma	WMA7/8/9 (Audio Only)	32kHz ~ 48kHz	32kbps ~ 320kbps
*.ogg	Vorbis	32kHz ~ 48kHz	45kbps ~ 500kbps
*.aac *.m4a *.mp4	AAC-LC (MPEG2/MPEG4 Audio Only)	32kHz ~ 48kHz	32kbps ~ 320kbps
*.wav	LPCM	32kHz ~ 192kHz	1,024kbps ~ 9,216kbps
*.flac	FLAC	32kHz ~ 192kHz	162kbps ~ 8,100kbps
*.aiff	AIFF	32kHz ~ 192kHz	1,024kbps ~ 9,216kbps

- If there are too many folders (about 200) and files (about 2000) stored on the USB drive, it may take the Soundbar some time to access and play files.
- Supported USB file system : FAT16, FAT32, NTFS

09 CONNECTING A MOBILE DEVICE

Connecting via Bluetooth

When a mobile device is connected using Bluetooth, you can hear stereo sound without the hassle of cabling.

- When you connect a paired Bluetooth device with the Soundbar off, the Soundbar automatically turns on.
- The connection is limited to one TV or two Bluetooth devices at the same time.

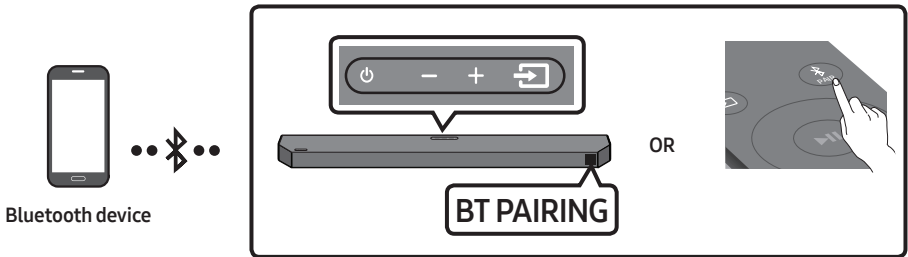

The initial connection

- When connecting to a new Bluetooth device, make sure the device is within 1 m distance.

1. Press the **PAIR** button on the remote control to enter the **"BT PAIRING"** mode.

(OR) a. Press the **Source** button on the top panel and then select **"BT"**.

"BT" changes to **"BT PAIRING"** in a few seconds automatically or changes to **"BT READY"** if there is a connect record.

b. When **"BT READY"** appears, press and hold the **Source** button on the top panel of the Soundbar for more than 5 seconds to display **"BT PAIRING"**.

2. On your device, select **"[AV] Samsung Soundbar Q6B-Series"** from the list that appears.

- When the Soundbar is connected to the Mobile device, **[Mobile Device Name]** → **"BT"** appears in the front display.



3. Play music files from the device connected via Bluetooth through the Soundbar.

- After you have connected the Soundbar to your mobile device the first time, use the **"BT READY"** mode to reconnect.

If the device fails to connect

- If you have an existing Soundbar (e.g., “[AV] Samsung Soundbar Q6B-Series”) on the list of speakers on the Mobile device, delete it.
- Then repeat steps 1 and 2.

What is the difference between BT READY and BT PAIRING?

- **BT READY** : In this mode, you can reconnect TV or mobile device that was connected before.
- **BT PAIRING** : In this mode, you can connect a new device to the Soundbar. (Press the  **PAIR** button on the remote control or press and hold the  (**Source**) button on the top of the Soundbar for more than 5 seconds while the Soundbar is in “**BT**” mode.)

Notes on Bluetooth connection

- Locate a new device within 1 m to connect via Bluetooth communication.
- If asked for a PIN code when connecting a Bluetooth device, enter <0000>.
- In Bluetooth connection mode, the Bluetooth connection will be lost if the distance between the Soundbar and the Bluetooth device exceeds 10 m.
- The Soundbar automatically turns off after 18 minutes in the Ready state.
- The Soundbar may not perform Bluetooth search or connection correctly under the following circumstances:
 - If there is a strong electrical field around the Soundbar.
 - If several Bluetooth devices are simultaneously paired with the Soundbar.
 - If the Bluetooth device is turned off, not in place, or malfunctions.
- Electronic devices may cause radio interference. Devices that generate electromagnetic waves must be kept away from the Soundbar main unit - e.g., microwaves, wireless LAN devices, etc.
- The Soundbar supports SBC data (44.1kHz, 48kHz).
- Connect only to a Bluetooth device that supports the A2DP (AV) function.
- You cannot connect the Soundbar to a Bluetooth device that supports only the HF (Hands Free) function.
- Once you have paired the Soundbar to a Bluetooth device, selecting “[AV] Samsung Soundbar Q6B-Series” from the device’s scanned devices list will automatically change the Soundbar to “**BT**” mode.
 - Available only if the Soundbar is listed among the Bluetooth device’s paired devices.
(The Bluetooth device and the Soundbar must have been previously paired at least once.)
- The Soundbar will appear in the Bluetooth device’s searched devices list only when the Soundbar is displaying “**BT READY**”.
- When connecting the Soundbar to a Bluetooth device, place them as close to each other as possible.
- The farther the Soundbar and Bluetooth device are from each other, the lower the sound quality will become. The Bluetooth connection may break when the devices are out of the effective range.
- The Bluetooth connection may not function as intended in areas with poor reception.

- A Bluetooth device may experience noise or malfunction under in the following conditions:
 - When the body is in contact with the signal transceiver on the Bluetooth device or Soundbar
 - In corners or when there is an obstacle in proximity, such as a wall or partition, where electrical changes may occur.
 - When exposed to radio interferences by other products operating on the same frequency ranges, such as medical equipment, microwave ovens, and wireless LAN devices.
 - Obstacles such as doors and walls may still impact the sound quality even when the devices are within the effective range.
- Note that your Soundbar cannot be paired with other Bluetooth devices while using the Bluetooth option.
- This wireless device may cause electrical interference during operation.

Bluetooth Power On (SOUND MODE)

If a previously paired Bluetooth device tries to pair with the Soundbar when the Bluetooth Power On function is on and the Soundbar is turned off, the Soundbar turns on automatically.

1. Press and hold the **SOUND MODE** button for more than 5 seconds on the remote while the Soundbar is turned on.
2. “**ON-BLUETOOTH POWER**” appears on the Soundbar’s display.

Disconnecting the Bluetooth device from a Soundbar

You can disconnect a Bluetooth device from the Soundbar. For instructions, see the Bluetooth device’s user manual.

- The Soundbar will be disconnected.
- When the Soundbar is disconnected from the Bluetooth device, the Soundbar will display “**BT DISCONNECTED**” on the front display.

Disconnecting the Soundbar from the Bluetooth device

Press the  (**Source**) button on the top panel or on the remote control, and then change to any mode except “**BT**”.

- Disconnecting takes time because the Bluetooth device must receive a response from the Soundbar. (Disconnection time may differ, depending on the Bluetooth device)
- When the Soundbar is disconnected from the Bluetooth device, the Soundbar will display “**BT DISCONNECTED**” on the front display.

Bluetooth Multi connection

The Soundbar can be connected to 2 Bluetooth devices at the same time.

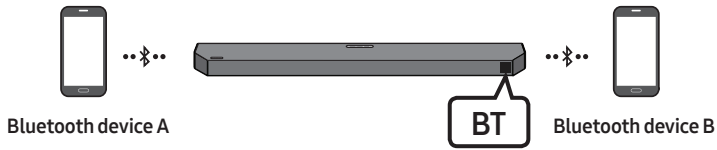

1. Connect the Soundbar to up to two Bluetooth devices. (See page 28)
2. Play music from one of the connected Bluetooth devices while two devices are connected.
3. If music is played from the Bluetooth device “B” while playing from the device “A”, the music is started playing on the device “B” and automatically being stopped/paused playback on the device “A”.
4. In versions prior to AVRCP V1.4, the switching time of the device playing music may be delayed.

NOTES

- The device can be switched by notification or alarm on some devices.
- Some devices do not support Bluetooth multi connection.
- “**BT PAIRING**” mode stops when no device is paired within 3 minutes.
- Switching devices may take about 7 seconds on some apps.
- If you attempt to connect a 3rd Bluetooth device, the A or B devices will be disconnected. (A device that is not currently playing will be disconnected.)
- Only one Samsung TV, or 2 Bluetooth devices can be connected at the same time.
- The Soundbar will be disconnected from Bluetooth devices when it receives a connection request from a Samsung TV.

Using Tap Sound

Tap the Soundbar with your mobile device to play audio from the mobile device through the Soundbar.

- This function may not be supported, depending on the mobile device.
- This function is only compatible with Samsung mobile devices with Android 8.1 or later.

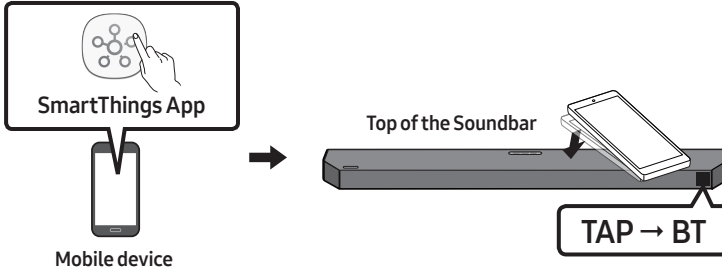

1. Turn on the **Tap Sound** function on your mobile device.
 - For details on how to turn on the function, refer to “**Enable the Tap Sound function**” below.
2. Tap the Soundbar with the mobile device. Select “**Start now**” in the displayed message window. A connection is established between the mobile device and Soundbar via Bluetooth.
3. Play audio from the mobile device through the Soundbar.
 - This function connects a mobile device to the Soundbar via Bluetooth by detecting vibration that occurs when the device touches the Soundbar.
 - Make sure the mobile device does not tap a sharp corner of the Soundbar. The Soundbar or mobile device may become scratched or damaged.
 - It is recommended that the mobile device be covered with a case. Lightly tap the wide area in the upper portion of the Soundbar, without using excessive force.
 - To use this function, update the **SmartThings** app to the latest version. The function may not be supported, depending on the app version.

Enable the Tap Sound function

Use the **SmartThings** app to turn on the **Tap View, Tap Sound** function.

1. On the mobile device, run the **SmartThings** app.
2. Select (☰ → ⚙) in the **SmartThings** app screen displayed on the mobile device.
3. Set “**Tap View, Tap Sound**” to On to allow the function to work when a mobile device moves close to the Soundbar.

NOTES

- When the mobile device is in power-saving mode, the **Tap Sound** function does not work.
- The **Tap Sound** function may not work if there are devices near the Soundbar that cause radio interference such as electric devices. Make sure devices that may cause radio interference are placed at a sufficient distance away from the Soundbar.

10 INSTALLING THE WALL MOUNT

Wallmount Components

Installation Precautions

- Install on a vertical wall only.
- Do not install in a place with high temperature or humidity.
- Verify whether the wall is strong enough to support the product's weight. If not, reinforce the wall or choose another installation point.
- Purchase and use the fixing screws or anchors appropriate for the kind of wall you have (plaster board, iron board, wood, etc.). If possible, fix the support screws into wall studs.
- Purchase wall mounting screws according to the type and thickness of the wall you want to mount the Soundbar on.
 - Diameter: M5
 - Length: 35 mm or longer recommended.
- Connect cables from the unit to external devices before you install the Soundbar on the wall.
- Make sure the unit is turned off and unplugged from the power source before you install it. Otherwise, it may cause an electric shock.

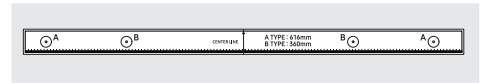

Wall Mount Guide



Holder-Screw

Screw



Bracket-Wall Mount

1. Place the **Wall Mount Guide** against the wall surface.
 - The **Wall Mount Guide** must be level.
 - If your TV is mounted on the wall, install the Soundbar at least 5 cm below the TV.

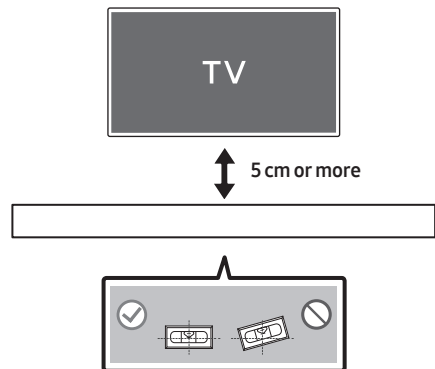

- Align the **Wall Mount Guide's Centre Line** with the centre of your TV (if you are mounting the Soundbar below your TV), and then fix the **Wall Mount Guide** to the wall using tape.
 - If you are not mounting below a TV, place the **Centre Line** in the centre of the installation area.

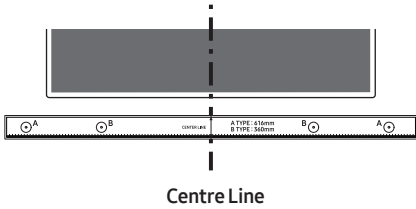

- Push a pen tip or sharpened pencil tip through the centre of the **A-TYPE** images on each end of the Guide to mark the holes for the supporting screws, and then remove the **Wall Mount Guide**.

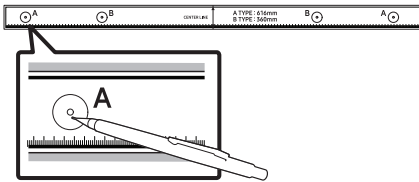

- Using an appropriately sized drill bit, drill a hole in the wall at each marking.
 - If the markings do not correspond to the positions of studs, make sure you insert appropriate anchors into the holes before you insert the support screws. If you use anchors, make sure the holes you drill are large enough for the anchors you use.

- Push a screw (not supplied) through each **Holder-Screw**, and then screw each screw firmly into a support screw hole.

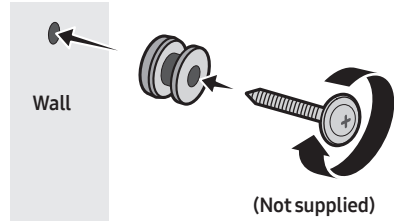

- Install the 2 **Bracket-Wall Mounts** in the correct orientation on the bottom of the Soundbar using 2 **Screws**.

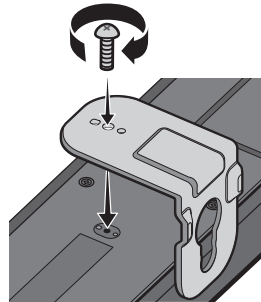

- When assembling, make sure the hanger part of the **Bracket-Wall Mounts** are located behind the rear of the Soundbar.

Rear of Soundbar

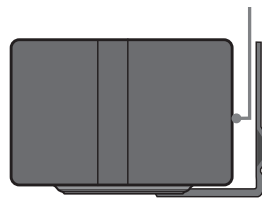

Right end of Soundbar

7. Install the Soundbar with the attached **Bracket-Wall Mounts** by hanging the **Bracket-Wall Mounts** on the **Holder-Screws** on the wall.

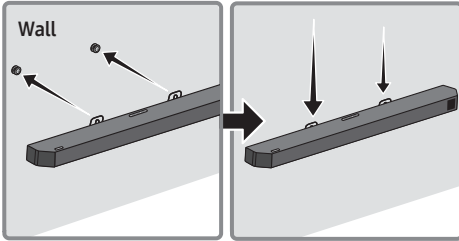

8. Slide the Soundbar down as shown below so that the **Bracket-Wall Mounts** rest securely on the **Holder-Screws**.

- Insert the **Holder-Screws** into the wide (bottom) part of the **Bracket-Wall Mounts**, and then slide the **Bracket-Wall Mounts** down so that the **Bracket-Wall Mounts** rest securely on the **Holder-Screws**.

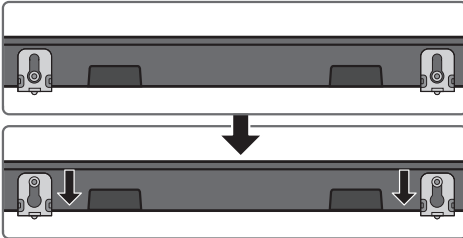

11 INSTALLING THE SOUNDBAR IN FRONT OF TV

Place the Soundbar on a TV stand.

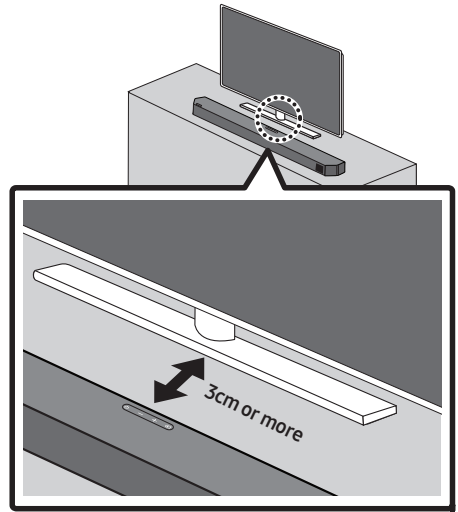

As illustrated in the image, align the centre of the Soundbar with the centre of the TV, carefully place the Soundbar onto the TV stand. For optimal sound quality, position the Soundbar at least 3 cm away from the TV front.

NOTES

- Make sure the Soundbar is placed on a flat and solid surface.
- Insufficient gap from the TV may cause acoustic problems.

12 SOFTWARE UPDATE

Samsung may offer updates for the Soundbar's system firmware in the future.

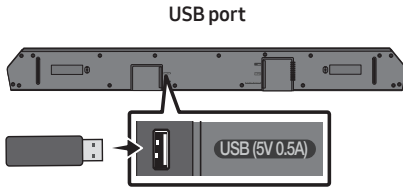

If an update is offered, you can update the firmware by connecting a USB drive with the firmware update stored on it to the USB port on your Soundbar.

USB Update

After the update completes, all your customized user settings are maintained.

1. Connect a USB drive to the USB port on your computer.

Important: Make sure there are no music files on the USB drive. This may cause the firmware update to fail.

2. Go to (samsung.com) → Select the product type or enter the model number of your Soundbar and download the latest upgrade file (USB type).
 - For more information about update, refer to Upgrade Guide.
3. Unzip the downloaded upgrade file and copy the *.bin file to the root directory of the USB drive.

4. Turn off the Soundbar and connect the USB drive containing the firmware update to the USB port on the Soundbar.
5. Turn on the Soundbar and press the  (Source) button to select USB source. "UPDATE" will be displayed, this may take up to 3 minutes.

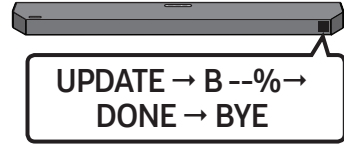

- The process of firmware update is displayed **UPDATE → B --% → DONE → BYE** in sequence, B, D or H can be displayed according to the firmware that is updated.

NOTES

- Soundbar is rebooted automatically when the update is completed.
- This product has a DUAL BOOT function. If the firmware fails to update, you can update the firmware again.
- During update, do not turn it off or remove the USB.
- If update does not proceed, reconnect the Soundbar power cord.
- When the latest version is installed, no update is performed.
- Depending on the USB type, update may not be supported.
- If the connection to the subwoofer is not re-established automatically after the update, refer to page 16.
- If the software update fails, check if the USB drive is defective.
- Mac OS users should use MS-DOS (FAT) as the USB format.

Reset

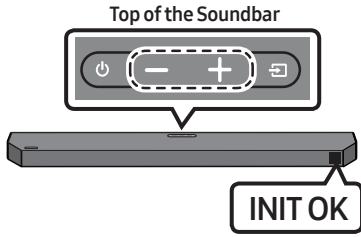

With the Soundbar on, press the **— + (Volume)** buttons on the body at the same time for at least 5 seconds. **"INIT OK"** appears on the display and then the Soundbar is reset.

CAUTION

- All the settings of the Soundbar are reset. Be sure to perform this only when a reset is required.

13 TROUBLESHOOTING

Before seeking assistance, check the following.

Soundbar does not turn on.

- Check whether the power cord of the Soundbar is correctly inserted into the outlet.

Soundbar works erratically.

- After removing the power cord, insert it again.
- Unplug the power cord and plug it back into the external device and try again.
- If there is no signal, the Soundbar automatically turns off after a certain period of time. Turn on the power. (See page 7.)

If the remote control does not work.

- Point the remote directly at the Soundbar.
- Replace the batteries with new ones.

Soundbar does not output any sound.

- The volume of the Soundbar is too low or muted. Adjust the volume.
- When any external device (STB, Bluetooth device, mobile device, etc.) is connected, adjust the volume of the external device.
- For sound output of the TV, select Soundbar. (Samsung TV: Home (🏠) → Menu → Settings (⚙️) → All Settings (⚙️) → Sound → Sound Output → Select Soundbar)
- The cable connection to the Soundbar may not be loose. Remove the cable and connect again.
- Remove the power cord completely, reconnect, and turn the power on.
- Reset the product and try again. (See page 37.)

Subwoofer does not output any sound.

- Check whether the LED indicator on the rear of the Subwoofer is on in blue. Reconnect the Soundbar and Subwoofer if the indicator is blinking in blue or turned red. (See page 16.)
- You may experience an issue if there is an obstacle between the Soundbar and Subwoofer. Move devices to an area away from obstacles.
- Other devices sending radio frequency signals in proximity may interrupt the connection. Keep your speaker away from such devices.
- Remove and reconnect the power plug.

The Subwoofer volume is too low.

- The original volume of the content you are playing may be low. Try adjusting the Subwoofer level. (See page 12.)
- Bring the Subwoofer speaker closer to you.

If the TV is not connected via HDMI TO TV (eARC/ARC).

- Check whether the HDMI cable is correctly connected to the ARC terminal. (See page 19.)
- Connection may not be possible due to the connected external device (set-top box, game machine, etc.). Directly connect the Soundbar.
- HDMI-CEC may not be activated on the TV. Turn on the CEC on the TV menu. (Samsung TV: Home (🏠) → Menu → Settings (⚙️) → All Settings (⚙️) → Connection → External Device Manager → Anynet+ (HDMI-CEC) ON)
- To connect with eARC, the eARC function in the TV menu should be set to On. (Samsung TV: Home (🏠) → Menu → Settings (⚙️) → All Settings (⚙️) → Sound → Expert Settings → HDMI-eARC Mode (Auto))

There is no sound in when connecting to the TV in HDMI TO TV (eARC/ARC) mode.

- Your device is unable to play the input signal. Change the TV's audio output to PCM or Dolby Digital.
(For a Samsung TV: Home (🏠) → Menu → Settings (⚙️) → All Settings (⚙️) → Sound → Expert Settings → Digital Output Audio Format)

Soundbar does not connect via Bluetooth.

- When connecting a new device, switch to "BT PAIRING" for connection. (Press the **PAIR** button on the remote control or press the **Source** button on the body for at least 5 seconds.)
- If the Soundbar is connected to another device, disconnect that device first to switch the device.
- Reconnect it after removing the Bluetooth speaker list on the device to connect. (Samsung TV: Home (🏠) → Menu → Settings (⚙️) → All Settings (⚙️) → Sound → Sound Output → Bluetooth Speaker List)
- The automatic TV connection may be disabled. While the Soundbar is in "BT READY", press and hold the **Left** button on the Soundbar remote control for 5 seconds to select **ON-TV CONNECT**. If you see **OFF-TV CONNECT**, press and hold **Left** button again for 5 seconds to switch the selection.
- Remove and reconnect the power plug, then try again.
- Reset the product and try again. (See page 37.)

Sound drops out when connected via Bluetooth.

- Some devices can cause radio interference if they are located too close to the Soundbar. e. g. microwaves, wireless routers, etc.
- If your device that is connected via Bluetooth moves too far away from the Soundbar, it may cause the sound to drop out. Move the device closer to the Soundbar.
- If a part of your body is in contact with the Bluetooth transceiver or the product is installed on metal furniture, sound may drop out. Check the installation environment and conditions for use.

Bluetooth multi connection does not work.

- When the TV is connected to the soundbar, Bluetooth multi connection may not operate. Disconnect the Soundbar from the TV and try again.
- Check whether the Bluetooth Multi connection setting is turned on. (Refer to the "**Soundbar does not connect via Bluetooth.**" section.)
- Disconnect the device currently playing, pair with the device that you want to connect, and reconnect the previous device.
- If the sound is inaudible even after connecting properly, refer to the "**Sound drops out when connected via Bluetooth.**" section.

Soundbar does not turn on automatically with the TV.

- When you turn off the Soundbar while watching TV, power synchronization with the TV is disabled. First turn off the TV.

14 LICENCE



Dolby, Dolby Atmos, and the double-D symbol are registered trademarks of Dolby Laboratories Licensing Corporation. Manufactured under license from Dolby Laboratories. Confidential unpublished works. Copyright © 2012-2021 Dolby Laboratories. All rights reserved.



For DTS patents, see <http://patents.dts.com>. Manufactured under license from DTS, Inc. (for companies headquartered in the U.S./Japan/Taiwan) or under license from DTS Licensing Limited (for all other companies). DTS, DTS:X, and the DTS:X logo are registered trademarks or trademarks of DTS, Inc. in the United States and other countries. © 2021 DTS, Inc. ALL RIGHTS RESERVED.



The terms HDMI and HDMI High-Definition Multimedia Interface, and the HDMI Logo are trademarks or registered trademarks of HDMI Licensing Administrator, Inc. in the United States and other countries.



The Bluetooth® word mark and logos are registered trademarks owned by Bluetooth SIG, Inc. and any use of such marks by Samsung Electronics Co., Ltd. is under license. Other trademarks and trade names are those of their respective owners.



[ENERGY STAR]

ENERGY STAR qualified model only

- Your Samsung product is ENERGY STAR qualified in its factory default setting. Change to certain features, settings and functionality in this product can change the power consumption, possibly beyond the limits required for ENERGY STAR qualification.
- Environmental Protection Agency and Department of Energy. ENERGY STAR is a joint program of the Government agencies, designed to promote energy efficient products and practices.

Refer to www.energystar.gov for more information of the ENERGY STAR Program.

ENERGY STAR qualified model only (Applicable to Thin Client models only)

As an ENERGY STAR® Partner, SAMSUNG has determined that this product meets the ENERGY STAR® guidelines for energy efficiency.

- The ENERGY STAR Program has been to reduced greenhouse gas emissions and save energy through voluntary labeling.
- Power management setting of this product have been enabled by default, and have various timing setting from 1 minutes to 5 hours.
- The product can wake with a button press on the chassis from sleep mode.

ENERGY STAR qualified model only (The other models)

- As an ENERGY STAR Partner, Samsung has determined that this product or product models meets the ENERGY STAR guideline for energy efficiency.
-

15 OPEN SOURCE LICENCE NOTICE

To send inquiries and requests for questions regarding open sources, contact Samsung Open Source (<http://opensource.samsung.com>)

16 IMPORTANT NOTES ABOUT SERVICE

Figures and illustrations in this User Manual are provided for reference only and may differ from actual product appearance.

17 SPECIFICATIONS AND GUIDE

Specifications

Model Name	HW-Q600B
USB	5V/0.5A
Weight	3.8 kg
Dimensions (W x H x D)	1030.0 x 57.0 x 105.0 mm
Operating Temperature Range	+5°C to +35°C
Operating Humidity Range	10 % ~ 75 %
AMPLIFIER Rated Output power	200W (30W x 6 + 10W x 2)
Supported play formats	Dolby 5.1ch / Dolby Digital Plus / Dolby TRUE HD / Dolby ATMOS / DTS:X MA / DTS:X / DTS-HD MA / DTS-HD HRA / DTS Express / DTS 96/24 / DTS-ES / DTS Digital Surround / LPCM 8ch

Subwoofer Name	PS-WB67B
Weight	5.5 kg
Dimensions (W x H x D)	184.0 x 343.0 x 295.0 mm
AMPLIFIER Rated Output power	160W

NOTES

- Samsung Electronics Co., Ltd reserves the right to change the specifications without notice.
- Weight and dimensions are approximate.

安全資訊

安全警告

為防止電擊，請勿拆卸蓋板（或背板）。
本機內部無使用者可以自行維修的零件。如需維修，請由專門的服務人員進行維修。
參閱下表，以取得三星產品上標誌的詮釋。

	注意 為防止電擊，請勿打開。	
	此符號表示內有高電壓。以任何方式與本產品內部之任何部件接觸均可導致危險。	
	此符號表示本產品隨附關於操作與維護的重要說明文件。	
	II 類產品：此符號表示不需要連接接地。 如此標誌沒有在帶有電源線的產品上出現，則產品必須正確連接保護地線。	
	AC 電壓：此符號表示額定電壓的標記為 AC 電壓。	
	DC 電壓：此符號表示額定電壓的標記為 DC 電壓。	
	注意，使用時需參照說明指示：此符號指示用戶查閱使用者手冊以取得進一步的安全相關資訊。	

警告

- 請勿將本機暴露在雨中或潮濕場所，以免火災或電擊。

注意

- 為防止電擊，請將寬片插頭完全插入匹配的寬插槽。
- 本設備應始終連接到帶有保護地線連接的交流電插座。
- 設備與電源斷開連接時，必須將插頭從電源插座上拔出，因此電源插頭應隨時保持便於操作。
- 請勿將水滴落或噴灑在設備上，不得在設備上放置裝有液體的物品，如花瓶。
- 要完全關閉本設備，須將電源插頭從牆上電源插座拔出。因此，電源插頭應隨時保持便於操作。

注意事項

1. 確定您屋內的交流電源供應符合產品底部識別標籤上列出的電源要求。請將產品安裝在水平、適當的基座 (家具) 上，並在周邊留下足夠的通風空間 7~10 公分。確保通風孔未被堵塞。請勿將本設備放在放大器或其他會發熱的設備上。本設備可供連續使用。要完全斷開設備的電源連接，請從牆上電源插座上拔掉交流電插頭。如果長時間不使用設備，請拔下其電源插頭。
2. 在雷雨天氣時，請從牆上電源插座拔下交流電插頭。閃電造成的電壓峰值會損壞本設備。
3. 請勿將本設備直接在陽光下暴曬或暴露於其他熱源下。這可能導致本設備過熱而發生故障。
4. 本產品應避免接觸潮濕 (如花瓶) 以及過熱 (如壁爐) 或者會產生強磁或電場的設備。如果設備發生故障，請從交流電源拔下電源線。本產品並非供工業使用，而是僅供個人使用。如果本產品存放在低溫環境中，則可能會出現冷凝現象。如果在冬天將本設備運送到室內，則需要等待大約 2 小時的時間，以便本機在使用前達到室內溫度。

5. 本產品使用的電池含有對環境有害的化學物質。請勿將電池作為普通生活垃圾棄置。請勿將電池置於火中。請勿使電池短路，分解或過熱。

注意：如果沒有正確替換電池，可能會導致危險。僅可使用同樣或相同類別的電池替換。

目錄

01	查看元件	6
02	產品概覽	7
	Soundbar 的前方面板/上方面板	7
	Soundbar 底部面板	8
03	使用遙控器	9
	使用遙控器前插入電池 (2 粒 AAA 電池)	9
	使用遙控器的方法	9
	使用隱藏按鈕 (具有多個功能的按鈕)	13
	不同音效模式的輸出規格	13
	使用電視遙控器調校 Soundbar 音量	14
04	連接 Soundbar	15
	連接電源	15
	將 Samsung 無線後置套件連接至 Soundbar	18
05	使用纜線連接至電視	19
	方法 1。以 HDMI 連接	19
	方法 2。使用光纖線連接	21
06	以無線方式連接至電視	23
	透過藍牙連接	23
07	連接外部裝置	25
	方法 1。使用 HDMI 線連接 (支援 Dolby Atmos® 解碼和播放)	25
	方法 2。使用光纖線連接	26

08	連接 USB 裝置	27
09	連接流動裝置	28
	透過藍牙連接	28
	一拍即“聽”用法	32
10	安裝牆壁安裝托架	33
	安裝注意事項	33
	牆壁安裝托架元件	33
11	將 Soundbar 安裝在電視前方	35
12	軟件更新	36
	USB 更新	36
	重設	37
13	解決疑難	38
14	授權	40
15	開源軟件許可聲明	41
16	有關維修的重要說明	41
17	規格和指南	42
	規格	42

01 查看元件

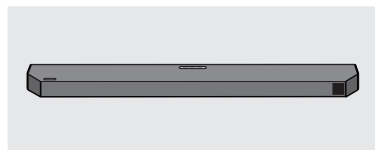

Soundbar 主設備



低音炮



遙控器/電池

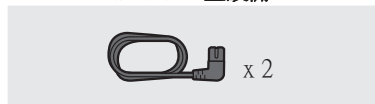

電源線
(低音炮, Soundbar)

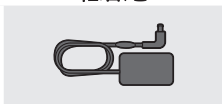

交流/
直流電適配器
(Soundbar)

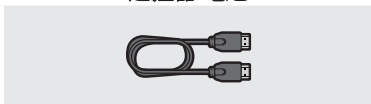

HDMI 線

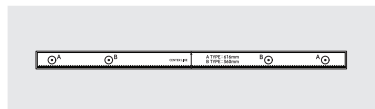

牆壁安裝托架指示圖



螺絲固定器



牆壁安裝托架

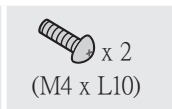

螺絲
(M4 x L10)

- 如需更多有關電源供應和耗電資料，請參閱產品貼附標籤。
(標籤：Soundbar 主設備底部)
- 如欲購買其他元件或連接線，請聯絡 Samsung 服務中心或 Samsung 客戶服務中心。
- 如需更多有關掛牆的資料，請參閱第 33 頁。
- 設計和規格畫面可能會隨時變更，恕不另行通知。
- 配件的外觀與上圖可能有些不同。

02 產品概覽

Soundbar 的前方面板/上方面板

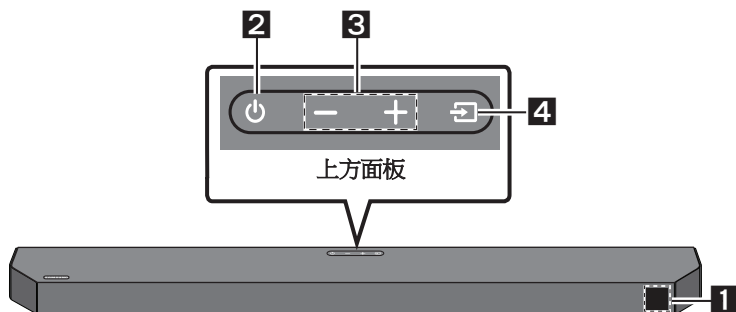

1	顯示螢幕 顯示產品狀態和目前模式。													
2	⏻ (電源) 按鈕 開啟或關閉電源。 <ul style="list-style-type: none">• Auto Power Down 功能 裝置會在以下情況下自動關閉。<ul style="list-style-type: none">- D.IN / HDMI / BT / USB 模式: 若 18 分鐘沒有音訊。													
3	- + (音量) 按鈕 調整音量。 <ul style="list-style-type: none">• 調整時, 音量會在 Soundbar 的前方顯示螢幕上出現。													
4	↺ (來源) 按鈕 選擇來源輸入模式。 <table border="1"><thead><tr><th>輸入模式</th><th>顯示螢幕</th></tr></thead><tbody><tr><td>光纖</td><td>D.IN</td></tr><tr><td rowspan="2">eARC/ARC (HDMI OUT)</td><td>* D.IN → TV eARC (自動轉換)</td></tr><tr><td>D.IN → TV ARC (自動轉換)</td></tr><tr><td>HDMI</td><td>HDMI</td></tr><tr><td>BLUETOOTH 模式</td><td>BT</td></tr><tr><td>USB 模式</td><td>USB</td></tr></tbody></table> <ul style="list-style-type: none">• 如要開啟「BT PAIRING」模式, 將來源變更為「BT」模式, 然後按住 ↺ (來源) 按鈕 超過 5 秒。	輸入模式	顯示螢幕	光纖	D.IN	eARC/ARC (HDMI OUT)	* D.IN → TV eARC (自動轉換)	D.IN → TV ARC (自動轉換)	HDMI	HDMI	BLUETOOTH 模式	BT	USB 模式	USB
輸入模式	顯示螢幕													
光纖	D.IN													
eARC/ARC (HDMI OUT)	* D.IN → TV eARC (自動轉換)													
	D.IN → TV ARC (自動轉換)													
HDMI	HDMI													
BLUETOOTH 模式	BT													
USB 模式	USB													

- 電視設定中的 eARC 功能設為開啟時, 便可支援「*」模式。
- 插入交流電電源線時, 電源按鈕會在 4 至 6 秒後開始運作。

- 開啟本設備時，您需要等待 4 至 5 秒才會聽到聲音。
- 如果電視和 Soundbar 一起發出聲音，可前往電視音效的**設定**選單，並將電視揚聲器變更為**外部揚聲器**。

Soundbar 底部面板

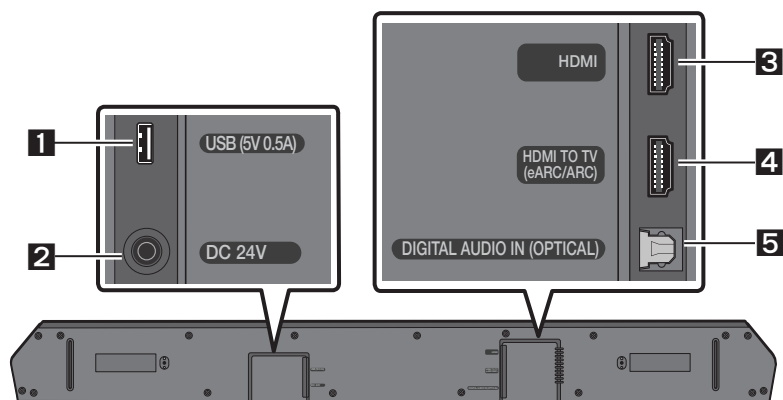

1	USB (5V 0.5A) 在此連接 USB 手指以透過 Soundbar 播放儲存在 USB 手指上的音樂檔案。
2	DC 24V (電源供應輸入) 連接交流/直流電適配器。
3	HDMI 使用 HDMI 線同時輸入數碼視頻和音頻訊號。 連接至外部裝置的 HDMI 輸出。
4	HDMI TO TV (eARC/ARC) 連接至電視上的 HDMI IN (ARC) 插孔。
5	DIGITAL AUDIO IN (OPTICAL) 連接至外部裝置的數位 (光纖) 輸出。

- 從牆上插座解除連接交流/直流電源適配器的電源線時，拉出插頭。
不要拉扯電源線。
- 元件之間完成所有連接之前，不要將本設備或其他元件連接至交流電插座。

03 使用遙控器



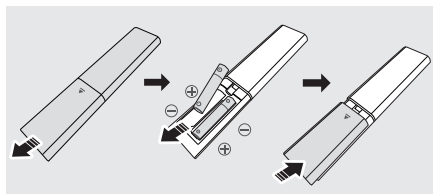

使用遙控器前插入電池 (2 粒 AAA 電池)

向箭頭方向滑動背蓋，直至將其完全移除。以正確電極方向插入 2 粒 AAA 電池 (1.5V)。將背蓋滑動回原位。

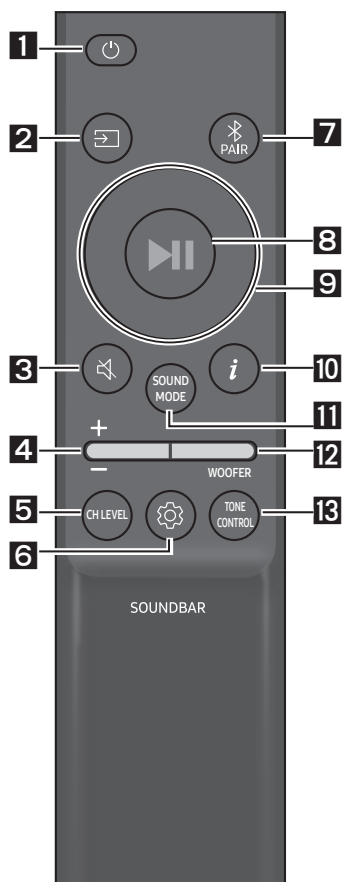



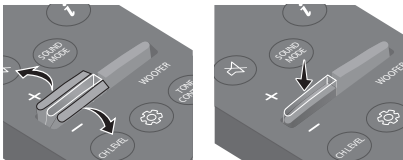

使用遙控器的方法



1  電源	開啟和關閉 Soundbar。
2  來源	按下以選擇連接至 Soundbar 的來源。
3  靜音	按下  (靜音) 按鈕即可設為靜音。 再次按下按鈕即可取消靜音。
4  音量	 將按鈕向上或向下推，以調整音量。 • 靜音 按下 音量 按鈕以設定為靜音。再次按下按鈕以取消靜音。

<p>5</p>  <p>CH LEVEL</p>	<p>按下按鈕，即可調較各揚聲器的音量。</p> <ul style="list-style-type: none"> • 按下按鈕以選擇 CENTER LEVEL 或 TOP LEVEL，以及使用上/下按鈕來設定，以將的音量在 -6 至 +6 之間進行調整。 • 連接後置揚聲器 (單獨出售) 時，可支援 REAR LEVEL 設定。使用上/下按鈕來設定，以將的 REAR LEVEL 的音量在 -6 至 +6 之間進行調整。
<p>6</p>  <p>聲音控制</p>	<p>按下按鈕，即可設定音訊功能。 可使用向上/下鈕調整所需的設定。</p> <p>VOICE ENHANCE ON/OFF → NIGHT MODE ON/OFF → AUDIO SYNC → VIRTUAL ON/OFF</p> <ul style="list-style-type: none"> - VOICE ENHANCE ON/OFF 此模式讓您更可輕鬆地聽到電影和電視播放的語音對話。 - NIGHT MODE ON/OFF 此模式針對夜間觀看作出最佳化，已調整設定以降低音量，同時保持對話清晰。 - AUDIO SYNC 如果電視影片和 Soundbar 音訊並非同步，按下  (聲音控制) 按鈕來選擇 AUDIO SYNC，然後使用上/下按鈕將音訊延遲設定為 0~300 毫秒之間。(不適用於「USB」或「BT」模式。) - VIRTUAL ON/OFF Dolby Virtual 功能可設為 ON/OFF。 • VOICE ENHANCE、NIGHT MODE 和 VIRTUAL 功能可透過向上/下鈕來 ON/OFF。(VIRTUAL 功能不適用於 USB 或 BT 模式。) • 按住  (聲音控制) 按鈕 5 秒，為各頻段調整音效。可使用左/右按鈕選擇 150Hz、300Hz、600Hz、1.2kHz、2.5kHz、5kHz 和 10kHz，而各頻率可使用上/下按鈕在 -6 至 +6 之間進行設定。 (請確保聲音模式已設置為「STANDARD」。)
<p>7</p>  <p>Bluetooth PAIR</p>	<p>切換 Soundbar 至藍牙配對模式。</p> <p>按下  PAIR 按鈕直至出現 BT PAIRING 畫面，以連接新的藍牙裝置。</p>
<p>8</p>  <p>播放/暫停</p>	<p>按下按鈕即可播放或暫停播放音樂。</p>

<p>9</p>  <p>上/下/左/右</p>	 <p>按下指示區域以選擇上/下/左/右。</p> <p>在按鈕上按下上/下/左/右以選擇或設定功能。</p> <ul style="list-style-type: none"> • 重覆 如要在「USB」模式下使用重覆功能，按下上按鈕。 • 音樂跳播 按下右按鈕以選擇下一個音樂檔案。按下向左按鈕以選擇上一個音樂檔案。 • ID SET 按住上按鈕 5 秒，以完成 ID SET (連接無線有源重低音箱或無線後置揚聲器的時候。)
<p>10</p>  <p>資料</p>	<p>按下後，便會顯示各種模式的資料。(請參閱第 7 頁。)</p>
<p>11</p>  <p>SOUND MODE</p>	<p>按下按鈕，即可選擇所需的聲音模式。</p> <p>SURROUND SOUND → GAME PRO → ADAPTIVE SOUND → STANDARD</p> <ul style="list-style-type: none"> - SURROUND SOUND 提供比標準更寬闊的音場。 - GAME PRO 提供立體聲，讓您在玩遊戲時盡情投入。 - ADAPTIVE SOUND 即時分析內容，並自動根據內容特性提供最佳音場。 - STANDARD 輸出原始聲音。 • DRC (Dynamic Range Control) 讓您將動態範圍控制套用至 Dolby Digital 歌曲。Soundbar 關閉時，按住 SOUND MODE 按鈕 5 秒，即可開啟或關閉 DRC (動態範播控制)。開啟 DRC 後，音量會降低。(聲音可能會失真。) • Bluetooth Power 此功能可在收到先前已連接的電視或藍牙裝置的連接要求時自動開啟 Soundbar。設定預設為開啟。 <ul style="list-style-type: none"> - 按住 SOUND MODE 按鈕超過 5 秒，以關閉 Bluetooth Power 功能。

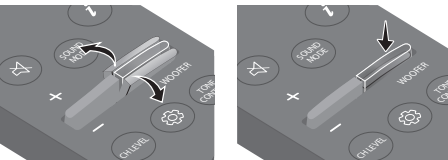
<p>12</p>	 <p>WOOFER</p> <p>WOOFER (BASS) 水平</p>	 <p>將按鈕向上或向下推，以調整 -12 或 -6 至 +6 的低音炮 (低音) 水平。如要將低音炮 (低音) 音量設為 0 (預設)，按下按鈕。</p>
<p>13</p>	 <p>TONE CONTROL</p>	<p>按下按鈕，即可調較高音或低音的音量。</p> <ul style="list-style-type: none"> • 按下按鈕以選擇 TREBLE 或 BASS，以及使用上/下按鈕來設定，以將的音量在 -6 至 +6 之間進行調整。

使用隱藏按鈕 (具有多個功能的按鈕)

隱藏按鈕		參考網頁
遙控器按鈕	功能	
WOOFER (上)	電視遙控器開/關 (備用)	第 14 頁
左	電視自動連接開/關 (藍牙準備就緒)	第 24 頁
上	ID SET	第 11 頁
 (聲音控制)	7 頻 EQ	第 10 頁
SOUND MODE	DRC ON/OFF (備用)	第 11 頁
	Bluetooth Power	第 11 頁

不同音效模式的輸出規格

效果		輸入	輸出	
			只包含有源重低音音箱	包含有源重低音音箱和無線後置揚聲器套件
 SOUND MODE	SURROUND SOUND	2.0 ch	3.1.2 ch	5.1.2 ch
		5.1 ch	3.1.2 ch	5.1.2 ch
		Dolby Atmos®, DTS:X	3.1.2 ch	5.1.2 ch
	GAME PRO	2.0 ch	3.1.2 ch	5.1.2 ch
		5.1 ch	3.1.2 ch	5.1.2 ch
		Dolby Atmos®, DTS:X	3.1.2 ch	5.1.2 ch
	ADAPTIVE SOUND	2.0 ch	3.1.2 ch	5.1.2 ch
		5.1 ch	3.1.2 ch	5.1.2 ch
		Dolby Atmos®, DTS:X	3.1.2 ch	5.1.2 ch
	STANDARD	2.0 ch	2.1 ch	2.1 ch
		5.1 ch	3.1 ch	5.1 ch
		Dolby Atmos®, DTS:X	3.1.2 ch	5.1.2 ch

- Samsung 無線後置揚聲器套件獨立發售。如要選購套件，請聯絡您購買 Soundbar 的供應商。
- 若輸入來源是 Dolby Atmos®, DTS:X，只包含低音炮的設定提供 3.1.2 頻道音效，而低音炮和無線後置揚聲器套件設定則提供 5.1.2 頻道音效。
- 使用 **STANDARD** 模式時，後置揚聲器不會為 2 聲道輸出製造音效。如果啟用後置揚聲器的音效，可將效果模式變更為 **SURROUND SOUND**。

使用電視遙控器調校 Soundbar 音量







使用電視遙控器調校 Soundbar 音量。

- 此功能只可以與 IR 遙控器一併使用。藍牙遙控器 (需要進行配對的遙控器) 不受支援。
- 將電視揚聲器設定至**外部揚聲器**以使用此功能。
- 支援該功能的製造商：
Samsung, VIZIO, LG, Sony, Sharp, PHILIPS, PANASONIC, TOSHIBA, Hisense, RCA

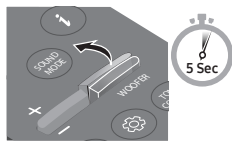
1. 關閉 Soundbar。

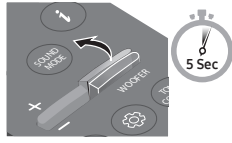
2. 按住 **WOOFER** 按鈕 5 秒。

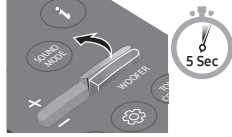
每次向上推動 **WOOFER** 按鈕 5 秒時，模式會按以下次序切換：「**OFF-TV REMOTE**」(預設模式)、「**SAMSUNG-TV REMOTE**」、「**ALL-TV REMOTE**」。

遙控器按鈕	顯示	狀態
	(預設模式) 	停用電視遙控器。
		啟用三星電視的 IR 遙控器。
		啟用第三方電視的 IR 遙控器。

04 連接 SOUNDBAR

連接電源

使用電源元件 將低音炮和 Soundbar 按以下次序連接至電源插座：

- 如需更多有關電源供應和耗電資料，請參閱產品貼附標籤。
(標籤：Soundbar 主設備底部)
1. 將電源線連接至有源重低音音箱。
 2. 將電源線連接至交流/直流電適配器。將交流/直流電適配器 (及電源線) 連接至 Soundbar。
 3. 將電源接駁至 Soundbar 和有源重低音音箱。
 - 先將電源線連接至有源重低音音箱。打開 Soundbar 時，有源重低音音箱會自動連接。

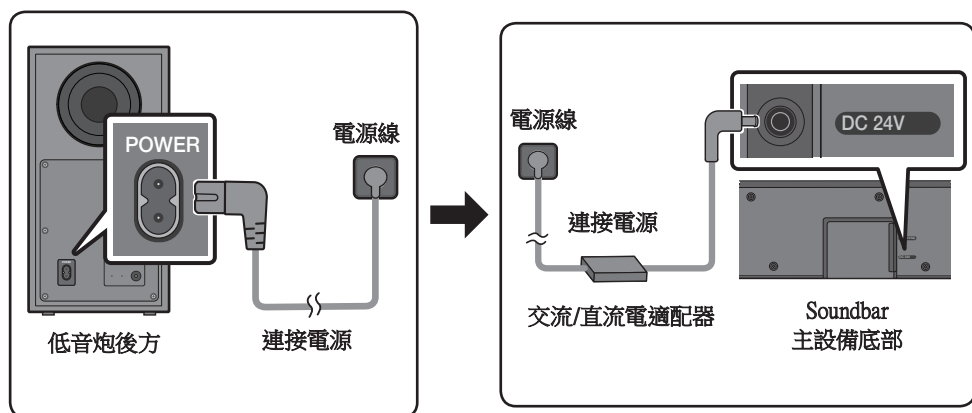

- 請確保交流電/直流電適配器平穩放在桌面上或地上。若您將交流電/直流電適配器的交流電源線插口朝上懸掛，水或其他異物可能進入適配器而導致其無法正常工作。
- 如果您在產品開啟期間拔除電源並再次連接電源線，Soundbar 會自動開啟。

自動連接失敗時，手動連接低音炮

執行下方手動連接程序前：

- 檢查 Soundbar 和低音炮的電源線是否正確連接。
- 確定 Soundbar 已開啟。

1. 按住低音炮後方的 **ID SET** 最少 5 秒。
 - 低音炮後方的紅色指示燈熄滅，藍色指示燈閃爍。

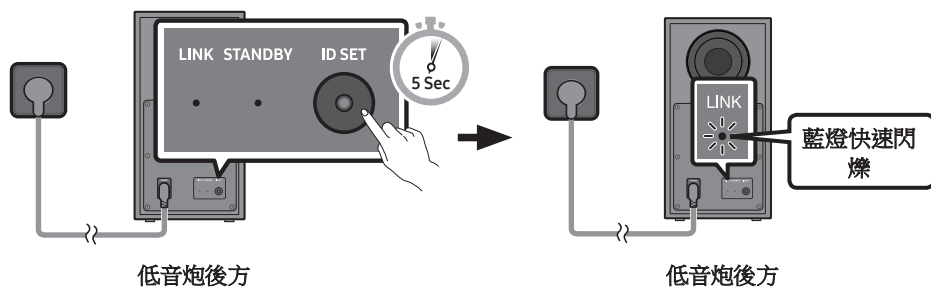

2. 按住遙控器上的上按鈕最少 5 秒。
 - Soundbar 顯示螢幕上將顯示 **ID SET** 訊息，然後在短時間內消失。
 - **ID SET** 完成後，Soundbar 會自動開啟。

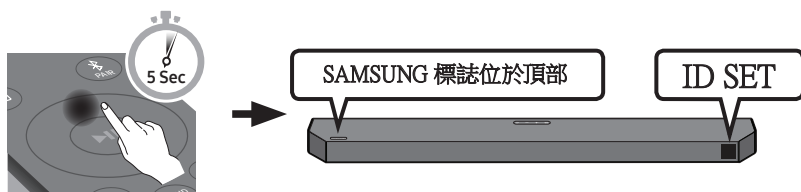

3. 檢查 **LINK LED** 亮起藍色 (連接完成)。

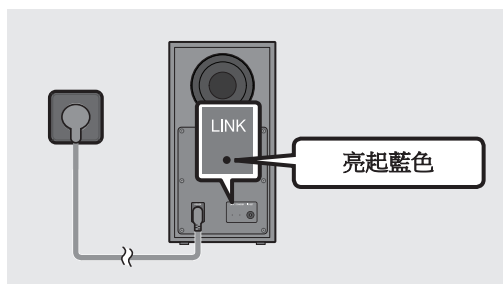

Soundbar 和無線低音炮連接後，**LINK LED** 指示燈停止閃爍並亮起藍色。

低音炮後方的 LED 指示燈

LED	狀態	描述	解決方法
	開	成功連接 (正常操作)	-
	閃爍	正在恢復連接	檢查電源線是否已正確連接 Soundbar 主設備, 或等待約 5 分鐘。若指示燈持續閃爍, 嘗試手動連接低音炮。請參閱第 16 頁。
	開	待機 (Soundbar 主設備已關閉)	檢查電源線是否已正確連接 Soundbar 主設備。
		連接失敗	重新連接。參閱第 16 頁的手動連接指示。
	閃爍	故障	參閱本手冊的 Samsung 服務中心聯絡資料。

備註

- 元件之間完成所有連接之前, 不要將本產品或電視的電源線連接至牆上的插座。
- 移動或安裝本產品時, 確保關閉電源, 並解除連接電源線。
- 如果主裝置的電源關閉, 無線低音炮將處於待機模式, 並且背後的 STANDBY LED 將會閃爍藍色數次, 然後轉為紅色。
- 如果您在 Soundbar 附近使用與 Soundbar 相同頻率的裝置, 干擾可能會導致部分聲音中斷。
- 主設備的無線訊號最大傳輸距離約為 10 米, 但可能視乎您的運作環境而定。若主設備和無線低音炮之間受鋼筋混凝土或金屬牆阻隔, 系統可能無法運作, 因為無線訊號無法穿過金屬。

注意

- 無線低音炮內置無線接收天線。讓設備遠離水和濕氣。
- 如要取得最佳聆聽體驗，請確定無線低音炮附近和無線接收器模組 (獨立發售) 位置沒有任何障礙物。

將 Samsung 無線後置套件連接至 Soundbar

透過將 Samsung 無線後置揚聲器套件 (SWA-9100S 或 SWA-9200S，獨立發售) 連接至有 Soundbar，可擴大至逼真的無線環繞聲。

有關如何連接的詳細資料，請參閱 Samsung 無線後置揚聲器套件的手冊。

05 使用纜線連接至電視

方法 1•以 HDMI 連接

連接支援 HDMI ARC/eARC (音訊回傳通道) 的電視

⚠ 注意

- 同時連接 HDMI 纜線和光纖電纜時，會首先接收 HDMI 訊號。
- 如要連接電視和 Soundbar 之間的 HDMI 纜線，請確保連接標示為 ARC 或 eARC 的端子。否則可能不會輸出電視聲音。
- 建議使用 **High-Speed HDMI Cable with Ethernet**。
- 連接支援 eARC 功能的電視時，「TV eARC」會在顯示屏上出現，並且會發出聲音。
- ARC/eARC 功能可支援 Dolby Atmos®。
- 視乎電視型號，電視連接埠可能會標記為 eARC。

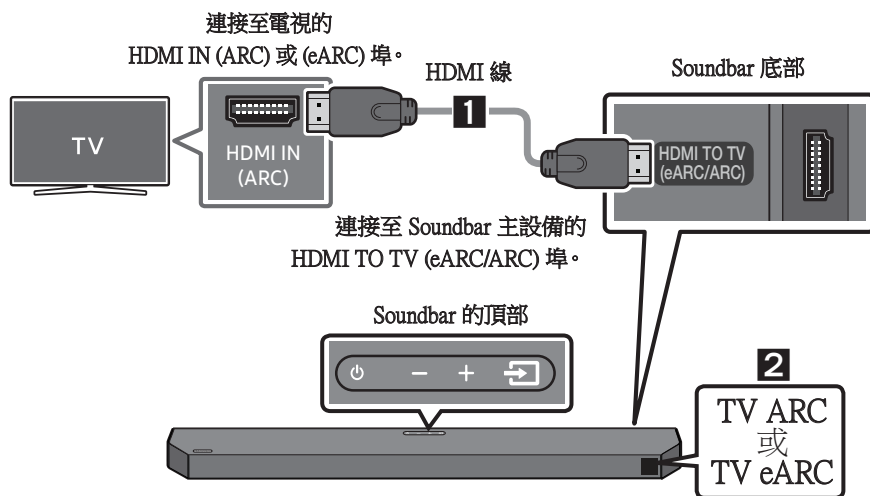

1. 開啟 Soundbar 和電視後，按照圖解所示連接 HDMI 線。
2. 「TV ARC」或「TV eARC」在 Soundbar 主設備的顯示螢幕上出現，而 Soundbar 會播放電視聲音。
 - 電視設定中的「TV eARC」功能設為開啟時，便會顯示 eARC。

- 如要連接至 eARC，電視功能表的 eARC 功能應設為開啟。有關設定的詳細資訊，請參閱電視使用者手冊。(例如 Samsung 電視：首頁 (🏠) → 功能表 → 設定 (⚙️) → 所有設定 (⚙️) → 音效 → 專家設定 → HDMI-eARC 模式 (自動))
- 如果聽不到電視聲音，按下遙控器上的  (來源) 按鈕或 Soundbar 頂部，以切換至「D.IN」模式。螢幕會按序顯示「D.IN」和「TV ARC」或「TV eARC」，而電視聲音會播放。
- 如果「TV ARC」或「TV eARC」沒有出現在 Soundbar 主設備的顯示螢幕上，請確定 HDMI 線已插入正確的連接埠。
- 使用電視遙控器上的音量按鈕變更 Soundbar 音量。

備註

- 當您以 HDMI 纜線把支援 HDMI ARC/eARC (音訊回傳通道) 的電視連接至 Soundbar，無須連接另一條光纖電纜即可傳輸數位視訊和音訊數據。
- 我們建議您盡可能使用無芯 HDMI 線。如果您使用帶芯 HDMI 線，請使用直徑少於 14 毫米的 HDMI 線。
- 若 HDMI 線不支援 ARC 或 eARC，此功能將無法使用。
- ARC 和 eARC 的頻寬不同。eARC 是音訊回傳通道的增強版本，其頻寬明顯高於 ARC。更高的頻寬代表可傳輸的數據量亦會增加。因此，使用 eARC 頻道，您便可以使用 Dolby Atmos® 和 DTS:X 等格式欣賞音效。
- 若廣播的音訊以 Dolby Digital 編碼，且電視上的「數碼輸出音訊格式」設定為 PCM，我們建議您將設定變更為 Dolby Digital。電視設定變更後，您可享有較佳的音質。(電視菜單可能使用不同文字顯示 Dolby Digital 和 PCM，視乎電視製造商而定。)

方法 2。使用光纖線連接

連接前的檢查清單

- 同時連接 HDMI 纜線和光纖電纜時，會首先接收 HDMI 訊號。
- 如果所採用的光纖電纜端子有蓋，請僅記移除端子口。

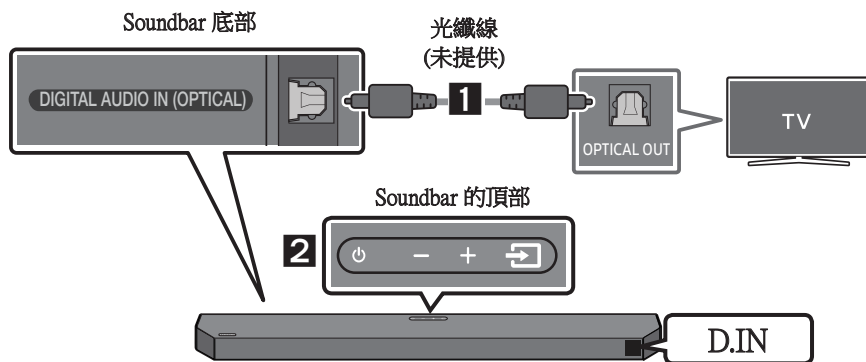

1. 使用數位光纖連 (未提供) 接線連接 Soundbar 上的 **DIGITAL AUDIO IN (OPTICAL)** 插孔和電視的 **OPTICAL OUT** 插孔。
2. 按下上方面板或遙控器上的  (來源) 按鈕，然後選擇「D.IN」模式。
3. 電視聲音透過 Soundbar 輸出。

使用 Q-Symphony 功能

使用 Q-Symphony 時，Soundbar 會與 Samsung 電視同步，透過兩部裝置以最佳環迴音效播放聲音。Soundbar 連接好後，功能表「TV+Soundbar」會在電視的**音效輸出**功能表中出現。選擇相應的功能表。

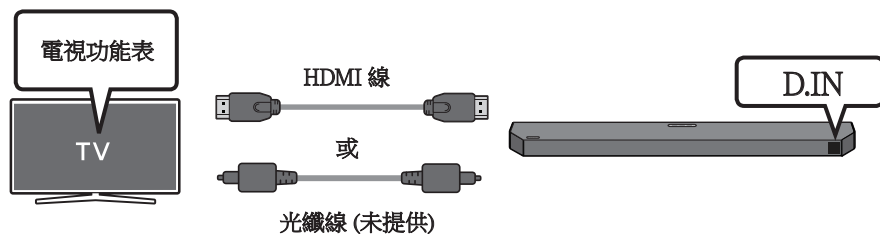

- 電視功能表例子：TV + [AV] Soundbar 系列名稱 (HDMI)

備註

- 可根據電視所支援的 Codec 運作。
- 僅於連接了 HDMI 纜線或光纖電纜 (無提供) 的情況下才支援此功能。
- 顯示的訊息可能因電視型號而有所不同。
- 只有部分 Samsung 電視和部分 Soundbar 型號才有提供此功能。

06 以無線方式連接至電視

透過藍牙連接

透過藍牙連接電視時，您可以欣賞立體聲，而無需因處理纜線而煩惱。

- 只可同時連接一部電視。

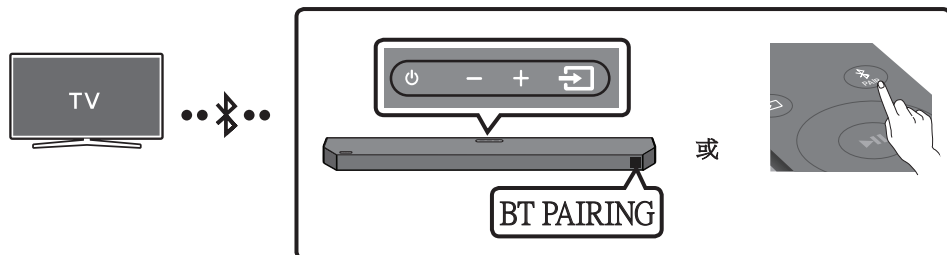

初始連接

1. 按下遙控器上的 **PAIR** 按鈕，以進入「BT PAIRING」模式。
(或)
 - a. 按下上方面板的 **☰ (來源)** 按鈕，然後選擇「BT」。
「BT」會在數秒內自動轉為「BT PAIRING」，若有連接記錄則會轉為「BT READY」。
 - b. 看到「BT READY」時，按住 Soundbar 上方面板上的 **☰ (來源)** 按鈕超過 5 秒，以顯示「BT PAIRING」。
2. 在電視上選擇藍牙模式。(如需瞭解詳情，請參閱電視手冊。)
3. 從電視螢幕上的清單選擇「[AV] Samsung Soundbar Q6B-Series」。
可用的 Soundbar 會在電視藍牙裝置清單上顯示為「需要配對」或「已配對」。
如要連接 Soundbar，選擇訊息並建立連接。
 - 電視連接後，[電視名稱] → 「BT」會在 Soundbar 前方顯示螢幕上出現。
4. 您現在可以聽到 Soundbar 播放電視聲音。
 - 首次將 Soundbar 連接至電視後，可使用「BT READY」模式重新連接。

若裝置無法連接



- 如果先前連接的 Soundbar (例如「[AV] Samsung Soundbar Q6B-Series」) 在清單上出現，請將它刪除。
- 然後重複第 1 至 3 步。

從電視解除連接 Soundbar

按下上方面板或遙控器上的  (來源) 按鈕，然後將模式變更為「BT」以外的模式。

- 電視必須從 Soundbar 接收回應，因此解除連接過程需要時間。
(所需時間可能有所不同，視乎電視型號而定。)
- 如要取消 Soundbar 和電視之間的自動藍牙連接，在 Soundbar 處於「BT READY」狀態時，按下遙控器上的左按鈕 5 秒。(切換開 → 關)

BT READY 和 BT PAIRING 有什麼不同？

- **BT READY**：在這個模式下，您可以重新連接任何以前連接過的電視或流動裝置。
- **BT PAIRING**：在這個模式，您可以將新裝置連接至 Soundbar。(按下遙控器上的  PAIR 按鈕，或在 Soundbar 處於「BT」模式時按住 Soundbar 上方面板的  (來源) 按鈕超過 5 秒。)

藍牙連接注意事項

- 把新裝置放置在 1 米 內的地方，以透過連接藍牙通訊連接。
- 如果系統在連接藍牙裝置時要求輸入 PIN 碼，請輸入 <0000>。
- 在藍牙連接模式下，若 Soundbar 和藍牙裝置相距超過 10 米，藍牙連接會中斷。
- 在待機狀態下，Soundbar 會在 18 分鐘後自動關閉。
- 在以下情況下，Soundbar 可能不會執行藍牙搜尋，或正確連接：
 - 若 Soundbar 附近的電場強烈。
 - 如果同時有兩個或更多的藍牙裝置與 Soundbar 配對。
 - 若藍牙裝置已關閉、不存在或發生故障。
- 電子裝置可能會導致無線電干擾。發放電磁波的裝置必須與 Soundbar 主設備保持遠距離，當中包括微波爐、無線 LAN 裝置等。

07 連接外部裝置

方法 1。使用 HDMI 線連接 (支援 Dolby Atmos® 解碼和播放)

連接前的檢查清單

- 如果音訊輸出選項包含第二音訊，須確定第二音訊設定為關閉。
- 確定內容支援 Dolby Atmos®。
- 視乎電視型號，電視連接埠可能會標記為 eARC。

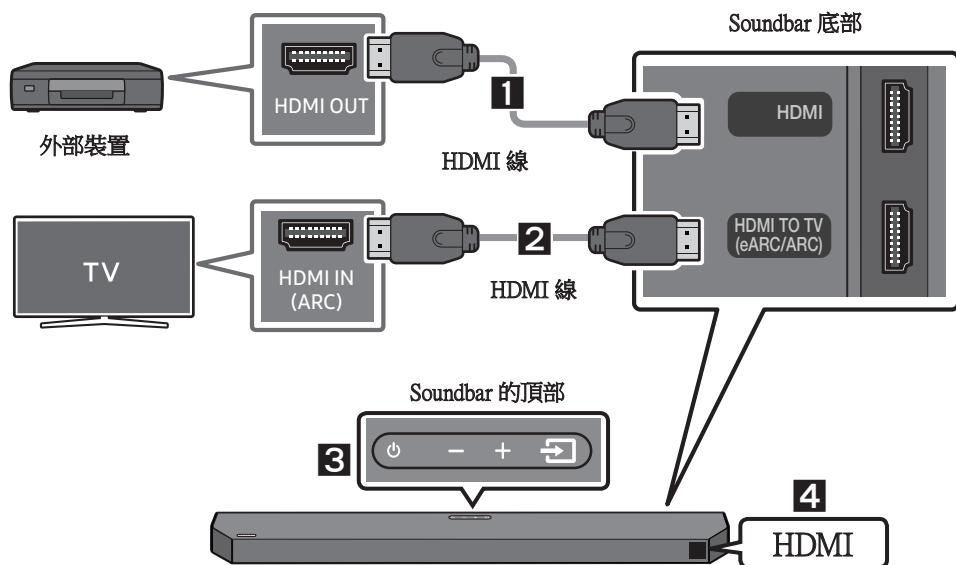

1. 使用 HDMI 纜線連接 Soundbar 底部的 **HDMI** 連接埠和相關數位裝置的 HDMI OUT 連接埠。
2. 使用 HDMI 纜線連接 Soundbar 底部的 **HDMI TO TV (eARC/ARC)** 連接埠和相關電視的 HDMI IN (ARC) 連接埠。
3. 按下上方面板或遙控器上的  (來源) 按鈕，然後選擇「HDMI」。
4. 「HDMI」模式會在 Soundbar 顯示面板上顯示，而聲音會播放。

備註

- 使用 Dolby Atmos® 時：如果輸入來源為 Dolby Atmos®，將輸出 3.1.2 頻道。
- Dolby Atmos® 啟動後，「DOLBY ATMOS」會在前方顯示屏上顯示。
- 在 BD 播放機或其他裝置上配置 Dolby Atmos®。

在 BD 播放機或其他裝置的設定功能表上開啟音訊輸出選項，並確定已為 Bitstream 選擇「沒有編碼」。例如，在三星 BD 播放機上，前往首項功能表 → 音效 → 數碼輸出，然後選擇 Bitstream (未處理)。

- HDMI Pass-Through 是指 Soundbar 透過自己的揚聲器播放來自來源的音訊，並透過第二條 HDMI 纜線將未經改變的影像訊號發送到電視。

支援的 UHD 訊號規格 (3840 x 2160p)

畫面播放速率 (fps)	色彩深度	RGB 4:4:4	YCbCr 4:4:4	YCbCr 4:2:2	YCbCr 4:2:0
< 60	8 位元	O	O	O	O
	10 位元	-	-	O	O
	12 位元	-	-	O	O
120	8 位元	-	-	-	-
	10 位元	-	-	-	-

- 支援的規格可能會因所連接的外置裝置或使用狀況而有所不同。

方法 2。使用光纖線連接

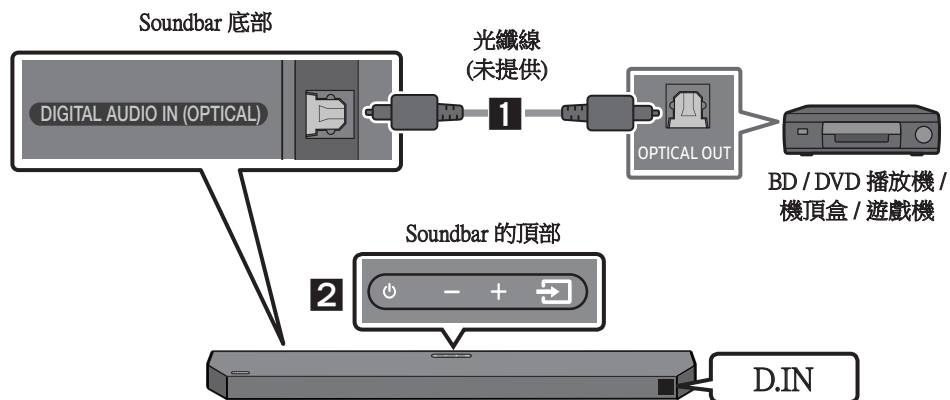

1. 按照圖解以光纖電纜 (未提供) 連接 Soundbar 上的 DIGITAL AUDIO IN (OPTICAL) 連接埠和外置裝置上的 OPTICAL OUT 連接埠。
2. 按下上方面板或遙控器上的  (來源) 按鈕，以選擇「D.IN」模式。
3. 外置裝置聲音透過 Soundbar 輸出。

08 連接 USB 裝置

您可以透過 Soundbar 播放儲存在 USB 裝置上的音樂檔案。

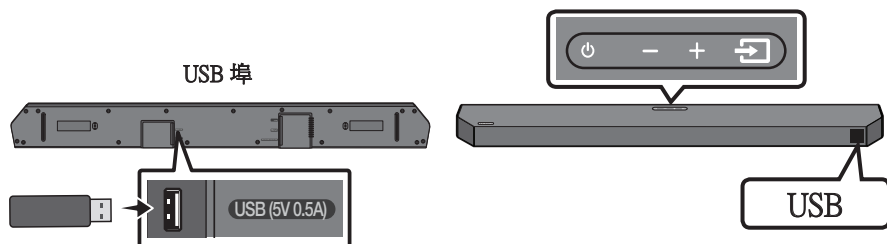

1. 經由產品底部的 USB 插口連接 USB 裝置。
2. 按下上方面板或遙控器上的  (來源) 按鈕，然後選擇「USB」。
3. 「USB」會顯示在螢幕上。
4. 透過 Soundbar 播放儲存在 USB 裝置上的音樂檔案。
 - 如果超過 18 分鐘沒有來自 USB 裝置的音訊訊號或仍未連接 USB 裝置，則 Soundbar 會自動關閉 (Auto Power Down)。

兼容的檔案格式類型清單

延長線	編碼	取樣率	位元率
*.mp3	MPEG1 Layer2	32kHz ~ 48kHz	32kbps ~ 320kbps
	MPEG1 Layer3	32kHz ~ 48kHz	32kbps ~ 320kbps
	MPEG2 Layer3	16kHz ~ 24kHz	8kbps ~ 160kbps
	MPEG2.5 Layer3	8kHz ~ 12kHz	8kbps ~ 160kbps
*.wma	WMA7/8/9 (僅限音訊)	32kHz ~ 48kHz	32kbps ~ 320kbps
*.ogg	Vorbis	32kHz ~ 48kHz	45kbps ~ 500kbps
*.aac *.m4a *.mp4	AAC-LC (MPEG2/MPEG4 僅限音訊)	32kHz ~ 48kHz	32kbps ~ 320kbps
*.wav	LPCM	32kHz ~ 192kHz	1024kbps ~ 9216kbps
*.flac	FLAC	32kHz ~ 192kHz	162kbps ~ 8100kbps
*.aiff	AIFF	32kHz ~ 192kHz	1024kbps ~ 9216kbps

- 若 USB 裝置上存儲了太多資料夾 (約 200 個) 和檔案 (約 2,000 個)，Soundbar 可能需要一定時間來存取和播放檔案。
- 支援的 USB 檔案系統：FAT16, FAT32, NTFS

09 連接流動裝置

透過藍牙連接

透過藍牙連接流動裝置時，您可以欣賞立體聲，而無需因處理纜線而煩惱。

- 在 Soundbar 已關閉的情況下連接已配對的藍牙裝置，會令 Soundbar 自動開啟。
- 僅可同時連接一部電視或兩個藍牙裝置。

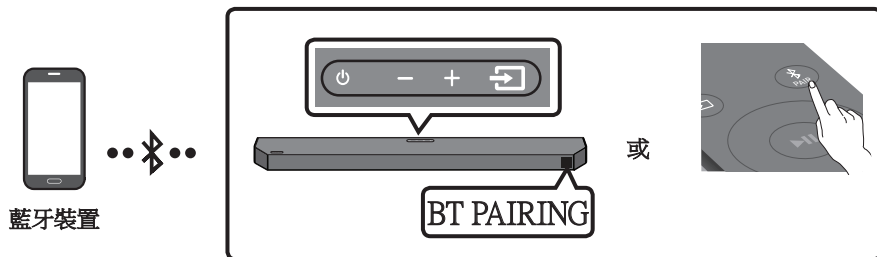

初始連接

- 連接新藍牙裝置時，確保該裝置位於 1 米之內。

1. 按下遙控器上的 **PAIR** 按鈕，以進入「BT PAIRING」模式。

(或) a. 按下上方面板的 **☰ (來源)** 按鈕，然後選擇「BT」。

「BT」會在數秒內自動轉為「BT PAIRING」，若有連接記錄則會轉為「BT READY」。

b. 看到「BT READY」時，按住 Soundbar 上方面板上的 **☰ (來源)** 按鈕超過 5 秒，以顯示「BT PAIRING」。

2. 在裝置上，從顯示的清單中選擇「[AV] Samsung Soundbar Q6B-Series」。

- Soundbar 連接至流動裝置後，[流動裝置名稱] → 「BT」會在前方螢幕上顯示。



3. 透過 Soundbar 播放藍牙連接裝置上的音樂檔案。

- 首次將 Soundbar 連接至流動裝置後，可使用「BT READY」模式重新連接。

若裝置無法連接

- 如果您的流動裝置揚聲器清單上已有現存的 Soundbar (例如：「[AV] Samsung Soundbar Q6B-Series」)，請將其刪除。
- 然後重複第 1 和 2 步。

BT READY 和 BT PAIRING 有什麼不同？

- **BT READY**：在這個模式下，您可以重新連接任何以前連接過的電視或流動裝置。
- **BT PAIRING**：在這個模式，您可以將新裝置連接至 Soundbar。(按下遙控器上的  PAIR 按鈕，或在 Soundbar 處於「BT」模式時按住 Soundbar 上方面板的  (來源) 按鈕超過 5 秒。)

藍牙連接注意事項

- 把新裝置放置在 1 米 內的地方，以透過連接藍牙通訊連接。
- 如果系統在連接藍牙裝置時要求輸入 PIN 碼，請輸入 <0000>。
- 在藍牙連接模式下，若 Soundbar 和藍牙裝置相距超過 10 米，藍牙連接會中斷。
- 在待機狀態下，Soundbar 會在 18 分鐘後自動關閉。
- 在以下情況下，Soundbar 可能不會執行藍牙搜尋，或正確連接：
 - 若 Soundbar 附近的電場強烈。
 - 若數部藍牙裝置同時配對至 Soundbar。
 - 若藍牙裝置已關閉、不存在或發生故障。
- 電子裝置可能會導致無線電干擾。發放電磁波的裝置必須與 Soundbar 主設備保持遠距離，當中包括微波爐、無線 LAN 裝置等。
- Soundbar 支援 SBC 資料 (44.1kHz、48kHz)。
- 只連接支援 A2DP (AV) 功能的藍牙裝置。
- 您不可將 Soundbar 連接至只支援免提功能的藍牙裝置。
- 將 Soundbar 配對至藍牙裝置後，從裝置的掃描裝置清單選擇「[AV] Samsung Soundbar Q6B-Series」，Soundbar 便會自動切換至「BT」模式。
 - 只在 Soundbar 出現在藍牙裝置的配對裝置清單時可用。
(藍牙裝置和 Soundbar 必須曾經配對最少一次。)
- 只有 Soundbar 顯示「BT READY」時，Soundbar 才會在藍牙裝置的搜尋裝置清單上出現。
- 將 Soundbar 連接至藍牙裝置時，將兩者盡量靠近。
- Soundbar 和藍牙裝置相距愈遠，音質愈低。若裝置超出有效範圍，藍牙連接可能會中斷。
- 若接收情況欠佳，藍牙連接可能無法如預期運作。

- 在以下情況下，藍牙裝置可能會發出嘈音或無法正常運作：
 - 身體接觸到 Bluetooth 裝置或 Soundbar 上的訊號收發器時。
 - 位於角落或附近有障礙物 (例如：牆壁或隔板) 的地方，電磁場都可能產生變化。
 - 受相同頻段下運作的產品的無線電干擾，例如醫療設備、微波爐和無線 LAN 裝置。
 - 即使裝置處於有效範圍，門和牆壁等阻礙物仍可能會影響音質。
- 請注意，使用藍牙選項時，您的 Soundbar 不可與其他藍牙裝置配對。
- 該無線裝置在運行時可能產生電子干擾。

Bluetooth Power 開 (SOUND MODE)

若想將曾經配對過的藍牙裝置與 Soundbar 配對，則當 Bluetooth Power 開功能打開時，即使 Soundbar 為關閉狀態，Soundbar 也會自動開啟。

1. 當 Soundbar 開啟時，按住 **SOUND MODE** 按鈕 5 秒以上。
2. 「ON-BLUETOOTH POWER」出現在 Soundbar 的顯示螢幕上。

從 Soundbar 解除連接藍牙裝置

您可以從 Soundbar 解除連接藍牙裝置。如需指引，請參閱藍牙裝置的使用者手冊。

- Soundbar 將會解除連接。
- Soundbar 從藍牙裝置解除連接後，Soundbar 的顯示螢幕上會顯示「BT DISCONNECTED」。

從藍牙裝置解除連接 Soundbar

按下上方面板或遙控器上的  (來源) 按鈕，然後變更為「BT」以外的模式。

- 由於藍牙裝置必須接收 Soundbar 的回應，因此解除連接需要時間。(解除連接的時間可能有異，視乎藍牙裝置而定)
- Soundbar 從藍牙裝置解除連接後，Soundbar 的顯示螢幕上會顯示「BT DISCONNECTED」。

藍牙多重連接

Soundbar 可同時連接兩個藍牙裝置。

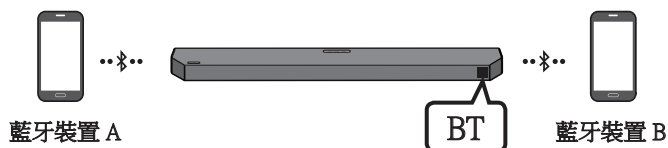

1. 把最多兩個藍牙裝置連接至 Soundbar。(請參閱第 28 頁。)
2. 連接兩個裝置時，從其中一個已連接的藍牙裝置播放音樂。
3. 當 Bluetooth 裝置「B」開始播放裝置「A」正在播放的音樂時，裝置「B」開始播放音樂，而裝置「A」則自動停止/暫停播放。
4. 如果是 AVRCP V1.4 或更舊的版本，切換播放音樂的裝置時可能會花費更多時間。

備註

- 部分裝置可以透過通知或鬧鐘來切換裝置。
- 部分裝置無法支援 Bluetooth 多重連接。
- 3 分鐘內沒有配對任何裝置時，「BT PAIRING」模式便會停止。
- 透過部分應用程式切換裝置可能大約需時 7 秒。
- 如嘗試連接第三方藍牙裝置，裝置 A 或 B 會解除連接。
(目前沒在播放的裝置會解除連接。)
- 同時只可連接一部三星電視或 2 部藍牙裝置。
- 有 Soundbar 接到 Samsung 電視的連接要求時，會與藍牙裝置解除連接。

一拍即“聽”用法

透過流動裝置輕點一下 Soundbar，可透過 Soundbar 播放流動裝置的音訊內容。

- 此功能可能視乎流動裝置型號而無法使用。
- 此功能只與 Android 8.1 或更高版本的 Samsung 流動裝置兼容。

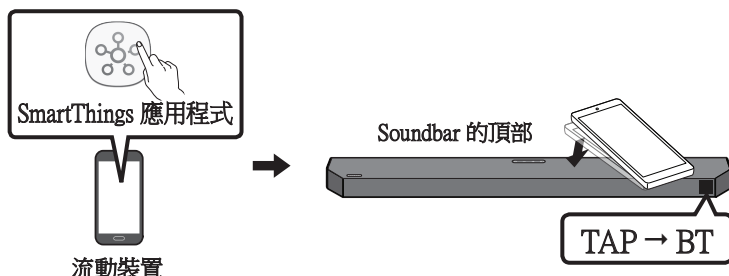

1. 開啟流動裝置上的一拍即“聽”功能。
 - 有關該功能的開啟方法，請參閱以下的「啟用一拍即“聽”功能」。
2. 以流動裝置輕點一下 Soundbar。在出現的訊息視窗中選擇「Start now」。
流動裝置會透過藍牙與 Soundbar 連接。
3. 透過 Soundbar 播放流動裝置的音訊內容。
 - 此功能透過偵測流動裝置碰觸 Soundbar 時產生的震動，從而以藍牙連接流動裝置至 Soundbar。
 - 請確保流動裝置沒有輕點 Soundbar 的尖角。否則 Soundbar 或流動裝置有可能刮花或受損。
 - 建議用保護殼包裹流動裝置。輕力點一下 Soundbar 頂部的寬廣部分，避免用力過度。
 - 為使用此功能，請將 **SmartThings** 應用程式更新為最新版本。
此功能可能視乎應用程式版本而無法使用。

啟用一拍即“聽”功能

使用 **SmartThings** 應用程式開啟一拍即“VIEW”，一拍即“聽”功能。

1. 在流動裝置執行 **SmartThings** 應用程式。
2. 在顯示於流動裝置的 **SmartThings** 應用程式畫面選擇 (☰ → ⚙️)。
3. 把「一拍即“VIEW”，一拍即“聽”」設定為開啟，以允許該功能於流動裝置靠近 Soundbar 時運作。

備註

- 流動裝置處於省電模式時，一拍即“聽”功能不會運作。
- 如 Soundbar 附近有可以造成電磁干擾的裝置，例如電子裝置，則一拍即“聽”功能有可能失靈。請確保讓有可能造成電磁干擾的裝置和 Soundbar 保持充足距離。

10 安裝牆壁安裝托架

牆壁安裝托架元件

安裝注意事項

- 只在垂直牆上安裝。
- 不要在高溫或潮濕的地方安裝。
- 確定牆壁可承受產品重量。否則，請強化牆壁或選擇另一個安裝位置。
- 購買或使用您牆壁類型 (石膏板、鐵板、木材等) 適合的固定螺絲或錨。可行的話，將支援螺絲固定在牆上的螺柱。
- 根據安裝 Soundbar 的牆壁的類型和厚度購買牆上的安裝螺絲。
 - 直徑: M5
 - 長度: 建議 35 毫米或以上。
- 在牆上安裝 Soundbar 前，從設備將連接線連接至外部裝置。
- 確保設備已經關閉而且已從電源拔除，然後才著手安裝，否則可能會造成觸電。

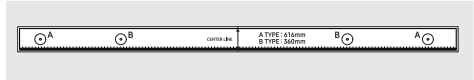

牆壁安裝托架指示圖



螺絲固定器



螺絲



牆壁安裝托架

1. 將**牆壁安裝托架指示圖**貼在牆面。
 - **牆壁安裝托架指示圖**必須為水平。
 - 如果您在牆上安裝電視，Soundbar 應安裝在電視下方最少 5 厘米位置。

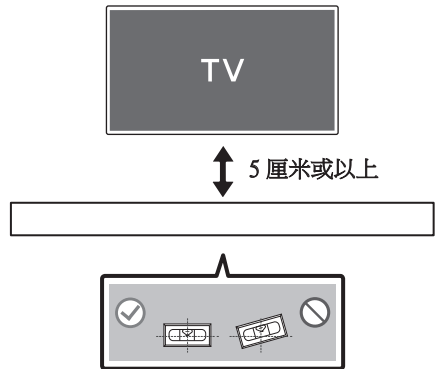

2. 將**牆壁安裝指引圖**的**中央線**對齊電視的中心位置 (若將 Soundbar 安裝在電視的下方), 再用膠紙將**牆壁安裝指引圖**固定在牆上。

- 若非安裝於電視下方, 請將**中線**對準安裝位置的中心。

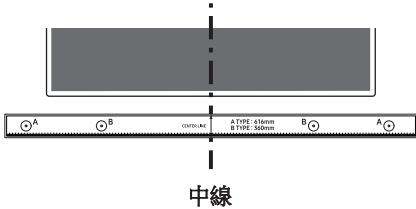

3. 用筆尖或削尖的鉛筆尖戳破安裝指引圖兩端的**A-TYPE**圖像中央, 以標記固定螺釘的位置, 然後拿開**牆壁安裝指引圖**。

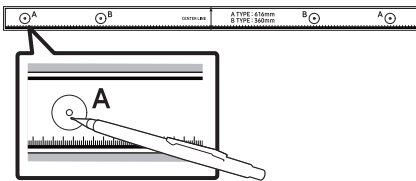

4. 用尺寸合適的鑽頭在各標記處鑽孔。

- 若標記與牆體上位置不符, 在插入固定螺釘前, 請確定您是否在孔中插入正確的螺釘。若使用螺釘, 請確保鑽孔足夠大可以插入螺釘。

5. 在每個**螺絲固定器**中插入一個螺釘 (未提供), 再將**支架螺釘**中的螺釘擰緊。

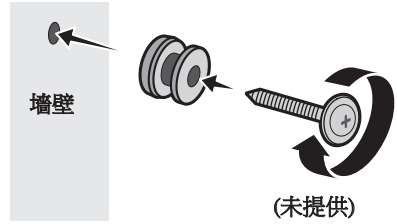

6. 使用 2 顆**螺釘**, 在 Soundbar 底部的正確方向安裝 2 顆**牆壁安裝托架**。

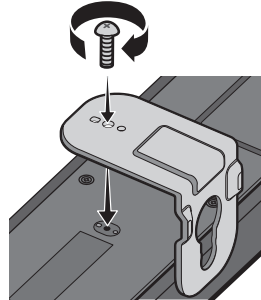

- 組裝時, 確定**牆壁安裝托架**的掛勾部分位於 Soundbar 的後方。

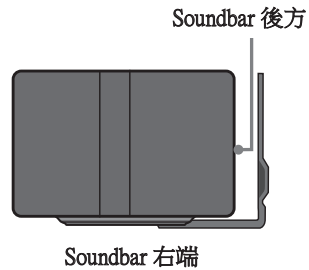

7. 將**牆壁安裝托架**懸掛在牆上的**螺絲固定器**上，即可透過**牆壁安裝托架**來安裝 Soundbar。

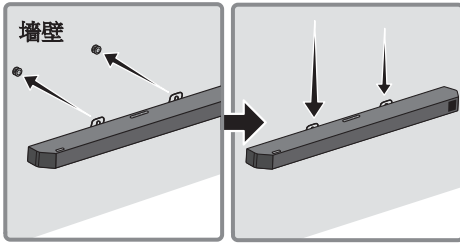

8. 向下拉動 Soundbar 如下所示，讓**牆壁安裝托架**安全擺放在**螺絲固定器**上。
- 將**螺絲固定器**插入**牆壁安裝托架**的寬(底部)部分，然後向下拉動**牆壁安裝托架**，讓**牆壁安裝托架**安全擺放在**螺絲固定器**上。

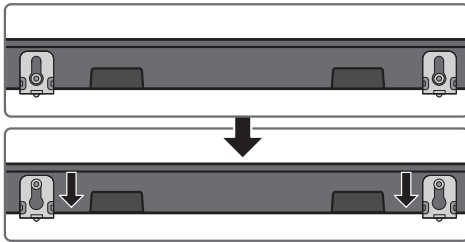

11 將 SOUNDBAR 安裝在電視前方

請將 Soundbar 放置在電視架上。

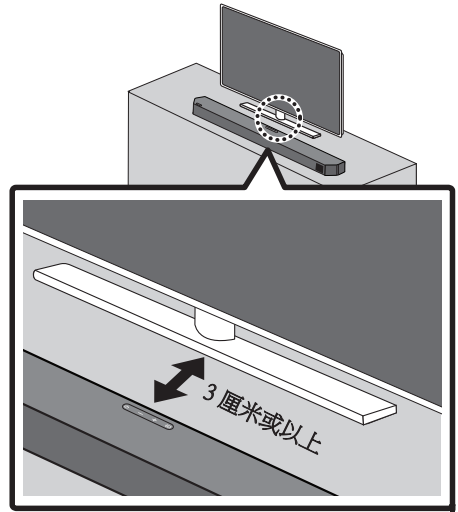

參考圖片所示，把 Soundbar 中心對準電視的中心，然後小心地將有源音箱放置到電視架上。

要達至最佳音效，應把 Soundbar 放在距離電視前方最少 3 厘米的位置。

備註

- 確保將 Soundbar 放置於平坦而穩固的平面上。
- 如果與電視距離過近，可能會對音質造成問題。

12 軟件更新

Samsung 可能會日後為 Soundbar 系統固件提供更新。

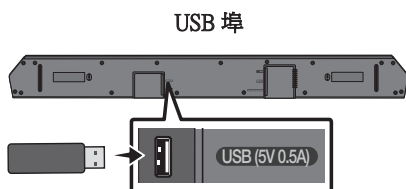

如有更新，可將包含韌體更新的 USB 裝置連接至 Soundbar 的 USB 連接埠，以更新韌體。

USB 更新

更新完成後，將會保留你的所有自訂使用者設定。

1. 將 USB 裝置連接至電腦的 USB 連接埠。
重要說明：確保 USB 裝置沒有音樂檔案。因為相關檔案可能會令韌體無法更新。
2. 前往 (samsung.com) → 選擇產品型號或輸入 Soundbar 型號，然後下載最新的升級檔案 (USB 類型)。
 - 如需進一步瞭解有關更新事宜，請參閱「升級指南」。
3. 解壓縮已下載的升級檔案，將 *.bin 檔案複製到 USB 裝置的根目錄下。

4. 關閉 Soundbar，並將放有韌體更新檔案的 USB 裝置連接至 Soundbar 的 USB 連接埠。
5. 開啟 Soundbar，並按下  (來源) 按鈕以選擇 USB 來源。畫面將顯示「UPDATE」，最多可能需時 3 分鐘。

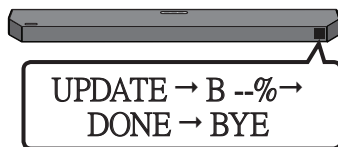

- 韌體更新期間會依次顯示 UPDATE → B --% → DONE → BYE，並可能會根據已更新的韌體顯示 B、D 或 H。

備註

- 更新完成後，Soundbar 將會自動重新啟動。
- 此產品擁有 DUAL BOOT 功能。如韌體更新失敗，可再次更新韌體。
- 更新期間，不要關閉產品或移除 USB。
- 如果沒有開始更新，請重新連接 Soundbar 電源線。
- 安裝最新版本後，便無需更新。
- 更新可能不受支援，視乎 USB 類型而定。
- 如果更新後沒有自動重新連接有源重低音音箱，請參閱第 16 頁。
- 如果軟件更新失敗，請檢查 USB 裝置是否有問題。
- Mac OS 使用者應使用 MS-DOS (FAT) 作為 USB 格式。

重設

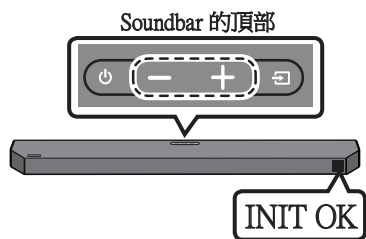

Soundbar 啟動後，同時按下機身的
- + (音量) 按鈕最少 5 秒。螢幕將會顯示
「INIT OK」，而 Soundbar 則會重設。

⚠ 注意

- Soundbar 所有設定都會重設。
請確保只於需要重設時才執行此程序。

13 解決疑難

在尋求幫助前，請檢查以下事項。

Soundbar 無法開啟。

- 檢查 Soundbar 的電源線有否正確插入插座。

Soundbar 運作異常。

- 拔下電源插頭，然後重新連接。
- 從外置裝置移除並重新連接電源線，然後再試一次。
- 如果沒有訊號，Soundbar 會在一定時間後自動關閉。關閉電源。(請參閱第 7 頁)。

如果遙控器無法使用。

- 直接將遙控器指向 Soundbar。
- 更換新電池。

Soundbar 聲音並無輸出。

- Soundbar 音量可能太低或開啟了靜音功能。調整音量。
- 如果連接了任何外置裝置 (STB、藍牙裝置、流動裝置等等)，請調整該外置裝置的音量。
- 關於電視的聲音輸出，請選擇 Soundbar。(Samsung 電視：首頁 (🏠) → 功能表 → 設定 (⚙️) → 所有設定 (⚙️) → 音效 → 音效輸出 → 選擇 Soundbar)
- 連接至 Soundbar 的連接線不得鬆脫。移除連接線並重新連接。
- 完全移除電源線、重新連接，並開啟電源。
- 初始化產品並重試。(請參閱第 37 頁)。

有源重低音音箱無法輸出任何聲音。

- 檢查低音炮後方的 LED 指示燈有否亮起藍色。若指示燈閃動藍色或轉為紅色，則重新連接 Soundbar 和低音炮。(請參閱第 16 頁)。
- 如果 Soundbar 和低音炮放置了阻礙物，可能會發生問題。將裝置移離阻礙物。
- 若附近設有傳送無線電頻訊號的裝置，可能會影響連接。請將揚聲器遠離這些裝置。
- 移除和重新連接電源插座。

低音炮音量過低。

- 您播放內容的原來音量可能過低。嘗試調校低音炮的音量。(請參閱第 12 頁)。
- 將低音炮揚聲器靠近您。



如果電視並非以 HDMI TO TV (eARC/ARC) 連接。

- 檢查 HDMI 纜線有否正確連接至 ARC 端子。(請參閱第 19 頁)。
- 可能會因已連接的外置裝置 (機頂盒、遊戲主機等等) 而無法進行連接。直接連接 Soundbar。
- 電視的 HDMI-CEC 可能未啟用。打開電視功能表的 CEC。(Samsung 電視：首頁 (🏠) → 功能表 → 設定 (⚙️) → 所有設定 (⚙️) → 連線 → 外置裝置管理員 → Anynet+ (HDMI-CEC)開)
- 如要連接至 eARC，電視功能表的 eARC 功能應設為開啟。(Samsung 電視：首頁 (🏠) → 功能表 → 設定 (⚙️) → 所有設定 (⚙️) → 音效 → 專家設定 → HDMI-eARC 模式 (自動))

連接至電視輸入 HDMI TO TV (eARC/ARC) 模式時，裝置不會發出聲音。

- 您的裝置無法播放輸入訊號。將電視的音訊輸出變更為 PCM 或 Dolby Digital。(若使用三星電視：首頁 (🏠) → 功能表 → 設定 (⚙️) → 所有設定 (⚙️) → 音效 → 專家設定 → 數碼輸出音頻格式)

Soundbar 無法透過 Bluetooth 進行連接。

- 連接新裝置時，切換至「BT PAIRING」，以進行連接。(按下遙控器上的  PAIR 按鈕，或按下機身的  (來源) 按鈕最少 5 秒。)
- 如果 Soundbar 連接至其他裝置，請先解除連接裝置，以切換至裝置。
- 從可連接裝置清單移除藍牙揚聲器清單後重新連接。(Samsung 電視：首頁 (🏠) → 功能表 → 設定 (⚙️) → 所有設定 (⚙️) → 音效 → 音效輸出 → 藍牙揚聲器列表)
- 自動電視連接可能已停用。Soundbar 處於「BT READY」時，按住 Soundbar 遙控器上的 **左** 按鈕 5 秒，以選擇 ON-TV CONNECT。如果您看到 OFF-TV CONNECT，再次按住 **左** 按鈕 5 秒以切換選擇。
- 移除和重新連接電源插座，然後重試。
- 初始化產品並重試。(請參閱第 37 頁)。

透過 Bluetooth 連接時沒有聲音。

- 微波爐、無線路由器等裝置距離 Soundbar 過近可能會造成電波干擾。
- 如果透過 Bluetooth 連接的裝置距離 Soundbar 太遠，便可能會沒有聲音。把裝置移近 Soundbar。
- 如果您身體的某部位接觸到 Bluetooth 收發器，或者產品安裝於金屬傢俱上，便可能會沒有聲音。
請檢查安裝環境和使用條件。

Bluetooth 多重連接無法運作。

- 連接電視和 Soundbar 後，Bluetooth 多重連接無法正常運作。從電視解除 Soundbar 的連接然後再試一次。
- 檢查是否已開啟 Bluetooth 多重連接設定。(請參閱「Soundbar 無法透過 Bluetooth 進行連接。」部分。)
- 解除連接正在播放內容的裝置，與要連接的裝置配對，然後再重新連接之前的裝置。
- 如果正確連接後仍然聽不到聲音，請參閱「透過 Bluetooth 連接時沒有聲音。」部分。

Soundbar 無法隨著電視自動開啟。

- 看電視時關閉 Soundbar，與電視之間的電源同步便會停止。請先把電視關掉。

14 授權



Dolby, Dolby Atmos, and the double-D symbol are registered trademarks of Dolby Laboratories Licensing Corporation. Manufactured under license from Dolby Laboratories. Confidential unpublished works. Copyright © 2012-2021 Dolby Laboratories. All rights reserved.



For DTS patents, see <http://patents.dts.com>. Manufactured under license from DTS, Inc. (for companies headquartered in the U.S./ Japan/Taiwan) or under license from DTS Licensing Limited (for all other companies). DTS, DTS:X, and the DTS:X logo are registered trademarks or trademarks of DTS, Inc. in the United States and other countries. © 2021 DTS, Inc. ALL RIGHTS RESERVED.



The terms HDMI and HDMI High-Definition Multimedia Interface, and the HDMI Logo are trademarks or registered trademarks of HDMI Licensing Administrator, Inc. in the United States and other countries.



The Bluetooth® word mark and logos are registered trademarks owned by Bluetooth SIG, Inc. and any use of such marks by Samsung Electronics Co., Ltd. is under license. Other trademarks and trade names are those of their respective owners.



[ENERGY STAR]

ENERGY STAR qualified model only

- Your Samsung product is ENERGY STAR qualified in its factory default setting. Change to certain features, settings and functionality in this product can change the power consumption, possibly beyond the limits required for ENERGY STAR qualification.
- Environmental Protection Agency and Department of Energy. ENERGY STAR is a joint program of the Government agencies, designed to promote energy efficient products and practices.

Refer to www.energystar.gov for more information of the ENERGY STAR Program.

ENERGY STAR qualified model only (Applicable to Thin Client models only)

As an ENERGY STAR® Partner, SAMSUNG has determined that this product meets the ENERGY STAR® guidelines for energy efficiency.

- The ENERGY STAR Program has been to reduced greenhouse gas emissions and save energy through voluntary labeling.
- Power management setting of this product have been enabled by default, and have various timing setting from 1 minutes to 5 hours.
- The product can wake with a button press on the chassis from sleep mode.

ENERGY STAR qualified model only (The other models)

- As an ENERGY STAR Partner, Samsung has determined that this product or product models meets the ENERGY STAR guideline for energy efficiency.

15 開源軟件許可聲明

如要提出有關開放源問題的查詢和要求，請聯絡三星開放源

(<http://opensource.samsung.com>)

16 有關維修的重要說明

本使用說明書中的圖片和圖解僅供參考，可能與實際的產品外觀有所不同。

17 規格和指南

規格

型號名稱	HW-Q600B
USB	5V/0.5A
重量	3.8 千克
尺寸 (寬 x 高 x 厚)	1030.0 x 57.0 x 105.0 毫米
工作溫度範圍	+5°C 到 +35°C
工作濕度範圍	10 % ~ 75 %
擴音器 額定輸出功率	200W (30W x 6 + 10W x 2)
支援的播放格式	Dolby 5.1ch / Dolby Digital Plus / Dolby TRUE HD / Dolby ATMOS / DTS:X MA / DTS:X / DTS-HD MA / DTS-HD HRA / DTS Express / DTS 96/24 / DTS-ES / DTS Digital Surround / LPCM 8ch

低音炮名稱	PS-WB67B
重量	5.5 千克
尺寸 (寬 x 高 x 厚)	184.0 x 343.0 x 295.0 毫米
擴音器 額定輸出功率	160W

備註

- Samsung Electronics Co., Ltd 保留隨時變更規格的權利，恕不另行通知。
- 重量和尺寸為估計值。



© 2022 Samsung Electronics Co., Ltd. All rights reserved.

Contact SAMSUNG WORLD WIDE

If you have any questions or comments relating to Samsung products, please contact the SAMSUNG customer care Centre.

Country / Area	Samsung Service Centre ☎	Web Site
■ Asia Pacific		
CHINA	400-810-5858	www.samsung.com/cn/support
TAIWAN	0800-329-999 0809-00-5237 (B2B / Dealer)	www.samsung.com/tw/support
HONG KONG	3698 4698 (All Product) 3698 4688 (B2B) 3698 4633 (eStore) 2121 9088 (Samsung pay)	www.samsung.com/hk/support (Chinese) www.samsung.com/hk_en/support (English)
MACAU	0800 333	
SINGAPORE	1800 7267864 1800-SAMSUNG	www.samsung.com/sg/support
AUSTRALIA	1300 362 603	www.samsung.com/au/support
NEW ZEALAND	0800 726 786	www.samsung.com/nz/support
VIETNAM	1800 588 889	www.samsung.com/vn/support
THAILAND	1800-29-3232 (Toll free for all product)	www.samsung.com/th/support
MYANMAR	+95-1-2399-888	www.samsung.com/mm/support
CAMBODIA	1800-20-3232 (Toll free)	
LAOS	+856-214-17333	www.samsung.com/th/support
MALAYSIA	1800-88-9999 +603-7713 7420 (Overseas contact)	www.samsung.com/my/support
INDONESIA	021-5699-7777 0800-112-8888 (All Product, Toll Free) 0800-112-7777 (All Product, Toll Free)	www.samsung.com/id/support
PHILIPPINES	Dedicated Hotline for Mobile Phones: #GALAXY (just dial #425299) All Products: 1-800-10-7267864 [PLDT - Toll Free] 1-800-8-7267864 [Globe - Toll Free] 84222111 [Landline]	www.samsung.com/ph/support
INDIA	1800 40 SAMSUNG (1800 40 7267864) (Toll-Free) 1800 5 SAMSUNG (1800 5 7267864) (Toll-Free)	www.samsung.com/in/support
NEPAL	16600172667 (Toll Free for NTC Only) 9801572667 (Toll Free for Ncell users)	www.samsung.com/in/support
BANGLADESH	08000-300-300 (Toll free) 09612-300-300	www.samsung.com/bd/support
SRI LANKA	011 SAMSUNG (011 7267864)	www.samsung.com/in/support