

# SAMSUNG

# USER MANUAL

SM-S901B/DS  
SM-S901E  
SM-S901E/DS  
SM-S906B/DS  
SM-S906E  
SM-S906E/DS  
SM-S908B/DS  
SM-S908E  
SM-S908E/DS

# Table of Contents

## Getting started

- 4 Device layout and functions
- 10 Charging the battery
- 15 Nano-SIM card and eSIM
- 17 Turning the device on and off
- 18 Initial setup
- 19 Samsung account
- 20 Transferring data from your previous device (Smart Switch)
- 22 Understanding the screen
- 30 Notification panel
- 32 Screen capture and screen record
- 33 Entering text

## Apps and features

- 36 Installing or uninstalling apps
- 37 S Pen (Galaxy S22 Ultra)
- 52 Phone
- 55 Contacts
- 57 Messages
- 58 Internet
- 59 Camera
- 76 Gallery
- 80 AR Zone
- 86 Bixby
- 88 Bixby Vision
- 89 Bixby Routines

- 91 Multi window
- 94 Samsung Pay
- 96 Samsung Health
- 97 Samsung Notes
- 102 Samsung Members
- 102 Samsung Kids
- 103 Samsung Global Goals
- 103 Samsung TV Plus
- 103 Galaxy Shop
- 103 Galaxy Wearable
- 104 PENUP (Galaxy S22 Ultra)
- 104 Calendar
- 105 Reminder
- 106 Voice Recorder
- 107 My Files
- 107 Clock
- 108 Calculator
- 108 Game Launcher
- 109 Game Booster
- 110 SmartThings
- 110 Sharing content
- 112 Music Share
- 113 Smart View
- 114 Link to Windows
- 115 Samsung DeX
- 121 Google apps

## Settings

- 122 Introduction
- 122 Samsung account
- 122 Connections
  - 124 Wi-Fi
  - 125 Bluetooth
  - 126 NFC and contactless payments
  - 128 Data saver
  - 128 Mobile data only apps
  - 128 Mobile Hotspot
  - 129 More connection settings
- 130 Sounds and vibration
  - 131 Sound quality and effects
  - 131 Separate app sound
- 132 Notifications
- 132 Display
  - 133 Motion smoothness
  - 134 Changing the screen mode or adjusting the display colour
- 135 Wallpaper and style
- 135 Themes
- 135 Home screen
- 135 Lock screen
  - 136 Smart Lock
  - 136 Always On Display
- 137 Biometrics and security
  - 138 Face recognition
  - 140 Fingerprint recognition
  - 143 Samsung Pass
  - 146 Secure Folder
  - 149 Secure Wi-Fi
- 150 Privacy
- 150 Location
- 151 Safety and emergency
- 151 Accounts and backup
  - 152 Samsung Cloud

- 152 Google
- 153 Advanced features
  - 154 Motions and gestures
  - 155 Video call effects
  - 156 Dual Messenger
- 157 Digital Wellbeing and parental controls
- 157 Battery and device care
  - 157 Optimising your device
  - 158 Battery
  - 158 Storage
  - 159 Memory
  - 159 Device protection
  - 159 Software update
  - 159 Diagnostics
- 159 Apps
- 160 General management
- 161 Accessibility
- 161 Software update
- 162 About phone

## Usage notices

- 163 Precautions for using the device
- 166 Notes on package contents and accessories
- 167 Maintaining water and dust resistance
- 168 Device overheating situations and solutions

## Appendix

- 171 Accessibility
- 185 Troubleshooting
- 190 Removing the battery

# Getting started

## Device layout and functions

### ► Galaxy S22 Ultra:

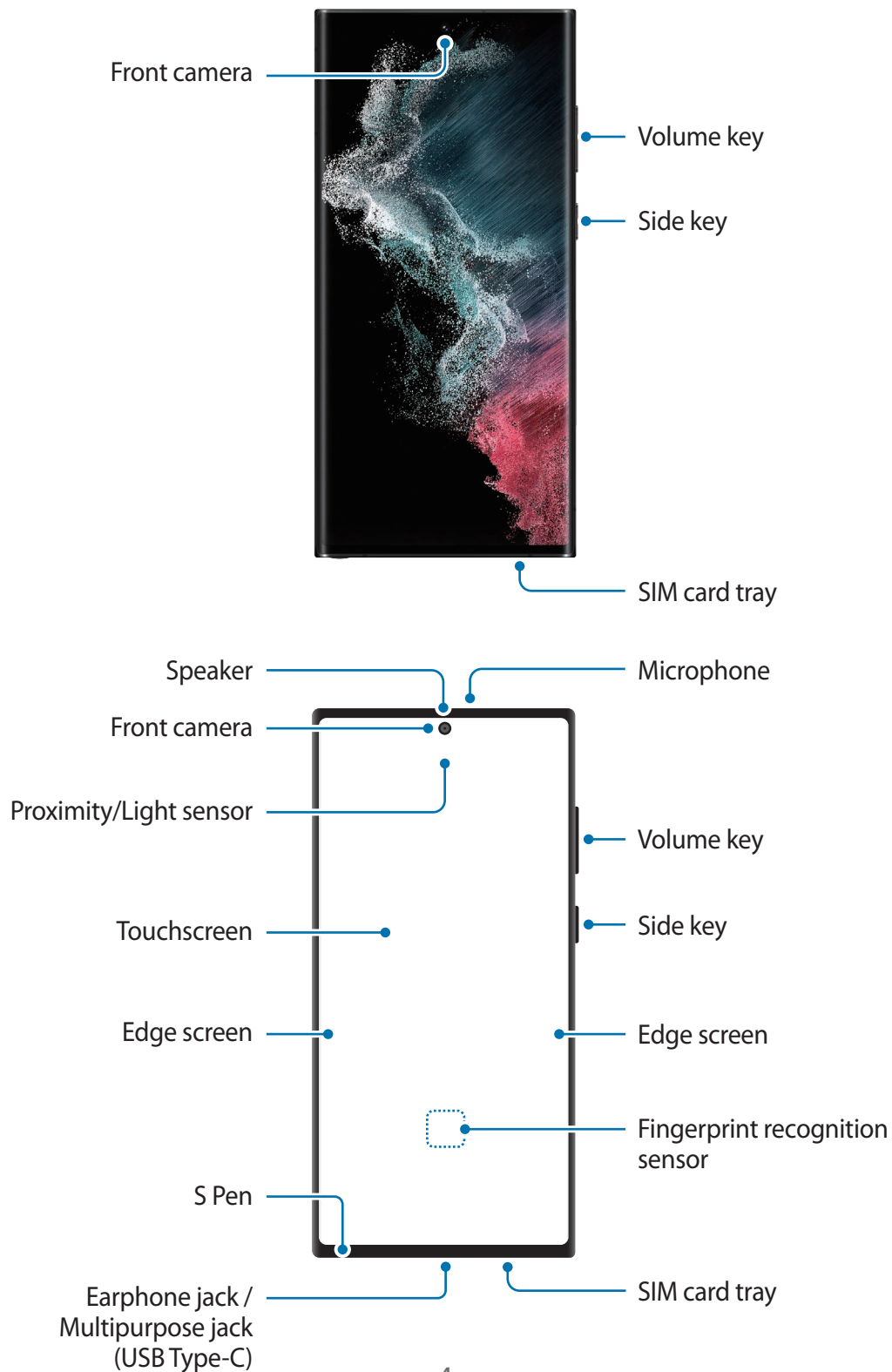

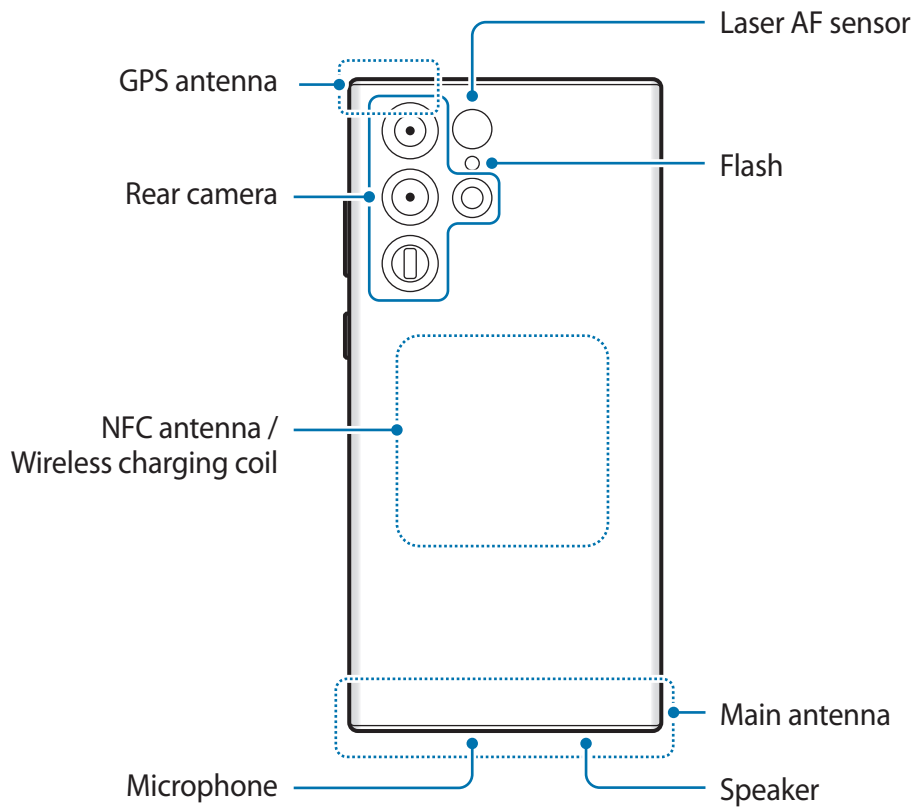

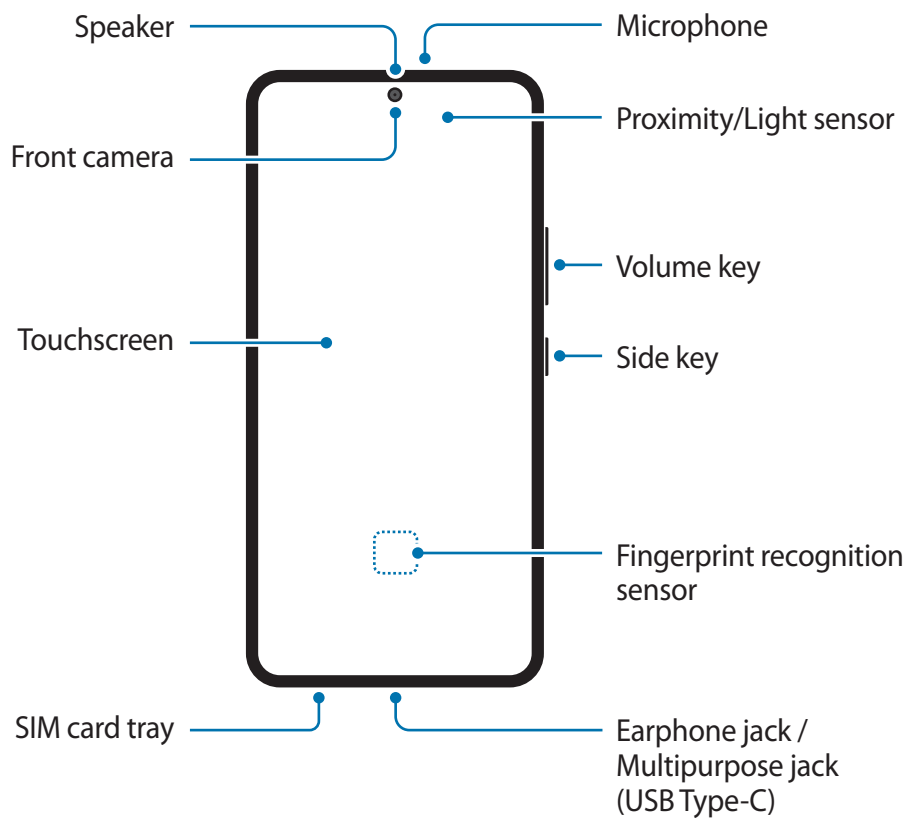
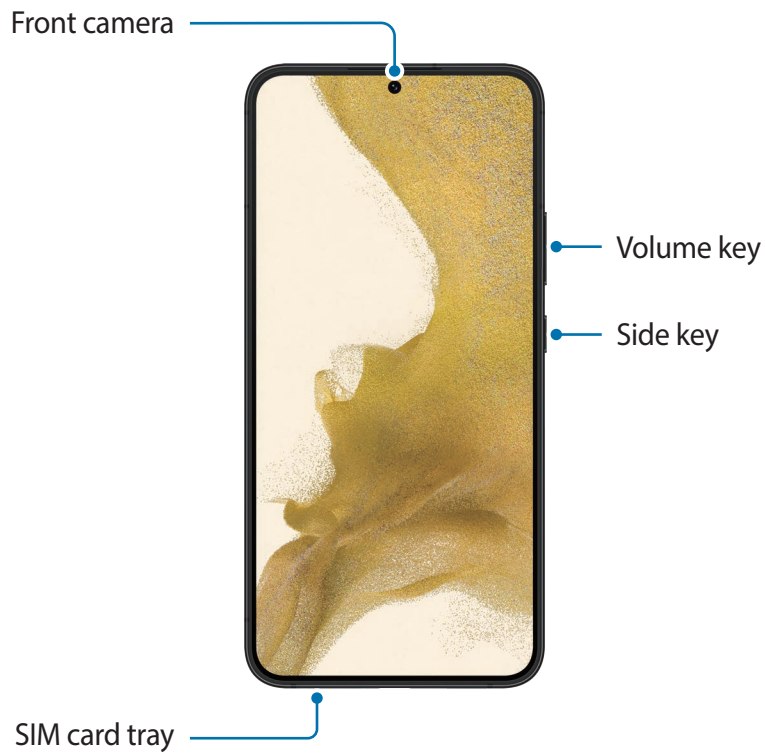

► **Galaxy S22+, Galaxy S22:**

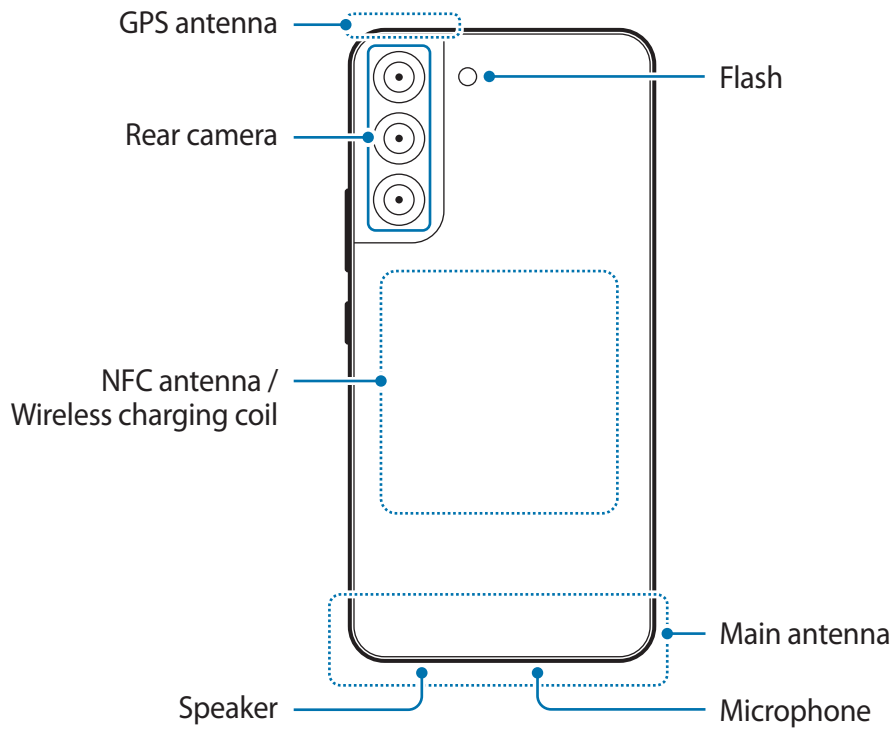



-  When using the speakers, such as when playing media files or using speakerphone, do not place the device close to your ears.
- Be careful not to expose the camera lens to a strong light source, such as direct sunlight. If the camera lens is exposed to a strong light source, such as direct sunlight, the camera image sensor may be damaged. A damaged image sensor is irreparable and will cause dots or spots in pictures.
- If you use the device with its glass or acrylic body broken, there may be a risk of injury. Use the device only after it has been repaired at a Samsung Service Centre.
- If dust or foreign materials enter the microphone, speaker, or receiver, the device's sound may become quiet or certain features may not work. If you attempt to remove the dust or foreign materials with a sharp object, the device may be damaged and its appearance may be affected.
-  Connectivity problems and battery drain may occur in the following situations:
  - If you attach metallic stickers on the antenna area of the device
  - If you attach a device cover made with metallic material to the device
  - If you cover the device's antenna area with your hands or other objects while using certain features, such as calls or the mobile data connection
- If the area around the rear camera is covered with accessories, such as a screen protector or stickers, unwanted noises may occur during calls or media playback.
- Do not cover the proximity/light sensor area with accessories, such as stickers or a cover. Doing so may cause the sensor to malfunction.
- The light may flicker at the top of the device during calls due to proximity sensor operation.
- The colours on the Edge screen may look different depending on your viewing position. (Galaxy S22 Ultra)



## Hard keys

Key	Function
Side key	<ul style="list-style-type: none"> <li>• When the device is off, press and hold to turn it on.</li> <li>• Press to turn on or lock the screen.</li> <li>• Press and hold to start a conversation with Bixby. Refer to <a href="#">Using Bixby</a> for more information.</li> <li>• Press twice or press and hold to launch the app or feature you set.</li> </ul>
Side key + Volume Down key	<ul style="list-style-type: none"> <li>• Press simultaneously to capture a screenshot.</li> <li>• Press and hold simultaneously to turn off the device.</li> </ul>

## Setting the Side key

Select an app or feature to launch by pressing the Side key twice or pressing and holding the Side key.

Launch the **Settings** app, tap **Advanced features** → **Side key**, and then select an option you want.

## Soft buttons

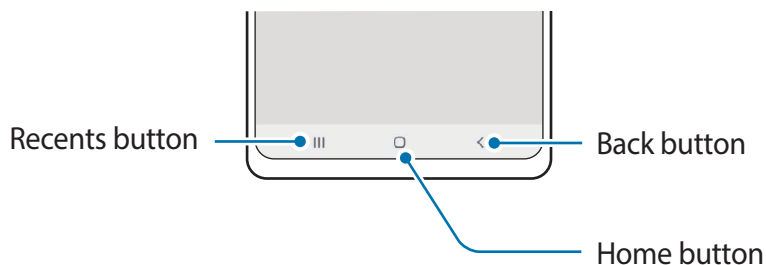

When you turn on the screen, the soft buttons will appear at the bottom of the screen. Refer to [Navigation bar \(soft buttons\)](#) for more information.

## Charging the battery

Charge the battery before using it for the first time or when it has been unused for extended periods.

### Wired charging

Connect the USB cable to the USB power adaptor and plug the cable into the device's multipurpose jack to charge the battery. After fully charging, disconnect the charger from the device.

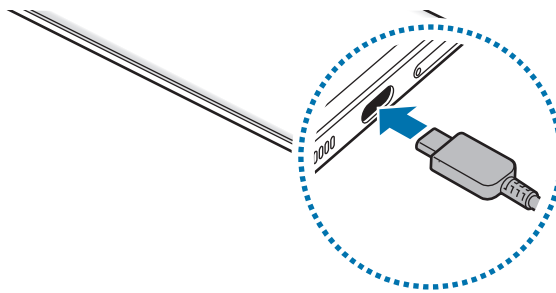

### Wireless charging

The device has a built-in wireless charging coil. You can charge the battery using a wireless charger (sold separately).

Place the centre of the device's back on the centre of the wireless charger to charge the battery. After fully charging, disconnect the device from the wireless charger.

The estimated charging time will appear on the notification panel. The actual charging time may vary depending on the charging conditions. Wireless charging may not work smoothly depending on the type of accessory or cover. For stable wireless charging, it is recommended to separate the cover or accessory from the device.

#### **Precautions for wireless charging**

If you do not follow the precautions below, the device may not charge properly or may overheat, or the device and any cards may be damaged.

- Do not place the device on the wireless charger with a credit card or radio-frequency identification (RFID) card (such as a transportation card or a key card) placed between the back of the device and the device cover.
- Do not place the device on the wireless charger when conductive materials, such as metal objects and magnets, are placed between the device and the wireless charger.

-  • If you use the wireless charger in areas with weak network signals, you may lose network reception.
- Use Samsung-approved wireless chargers. If you use other wireless chargers, the battery may not charge properly.



## Quick charging

Launch the **Settings** app, tap **Battery and device care** → **Battery** → **More battery settings**, and then activate the feature you want.

- **Fast charging:** To use the fast charging feature, use a battery charger that supports Adaptive fast charging.
  - **Super fast charging:** To use the super fast charging feature, use a USB PD (Power Delivery) charger that supports Super fast charging.
  - **Fast wireless charging:** To use this feature, use a charger and components that support the fast wireless charging feature.
-  • You can charge the battery more quickly while the device or its screen is turned off.
  - If the wireless charger has an internal fan, the fan may produce noise during fast wireless charging. Add a routine to set the fast wireless charging feature to turn off automatically at the preset time using **Bixby Routines**. When the fast wireless charging feature turns off, the charger's fan noise and the indicator light will be reduced.

## Wireless power sharing

You can charge another device with your device's battery. You can still charge another device even while charging your device. Depending on the type of accessories or cover being used, the Wireless power sharing feature may not work properly. It is recommended to remove any accessories and cover being used before using this feature.

- 1 Open the notification panel, swipe downwards, and then tap  (**Wireless power sharing**) to activate it. If you cannot find  (**Wireless power sharing**) on the quick panel, tap  and drag the button over to add it.
- 2 Place the other device on the centre of your device, with their backs facing.

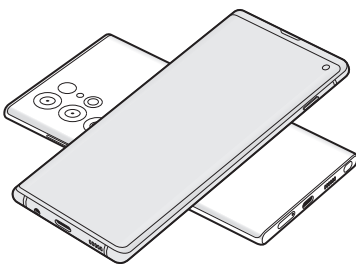

Smartphone

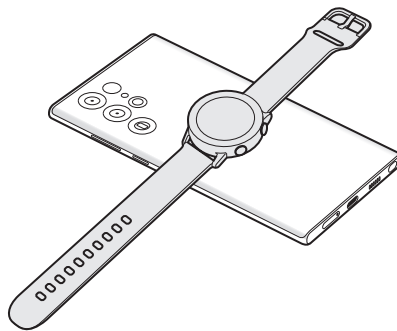

Galaxy Watch

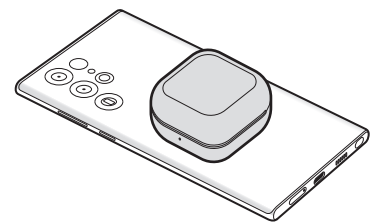

Galaxy Buds

- 3 When you are finished charging, disconnect the other device from your device.



Do not use earphones while sharing power. Doing so may affect nearby devices.



- The location of the wireless charging coil may vary by device model. Adjust the devices to connect with each other properly.
- Some features are not available while sharing power.
- Only devices that support the wireless charging feature can be charged using this feature. Some devices may not be charged. To see devices that support the Wireless power sharing feature, visit the Samsung website.
- To charge properly, do not move or use either device while charging.
- The power charged to the other device may be less than the amount shared to it by your device.
- If you charge the other device while charging your device, the charging speed may decrease or the device may not charge properly depending on the charger type.
- The charging speed or efficiency may vary depending on the device's condition or the surrounding environment.

## Setting the limit for power sharing

You can set the device to stop power sharing when the remaining battery power drops below a certain level.



Launch the **Settings** app, tap **Battery and device care** → **Battery** → **Wireless power sharing** → **Battery limit**, and then set the limit.

## Reducing the battery consumption

Your device provides various options that help you conserve battery power.

- Optimise the device using the device care feature.
- When you are not using the device, turn off the screen by pressing the Side key.
- Activate power saving mode.
- Close unnecessary apps.
- Deactivate the Bluetooth feature when not in use.
- Deactivate auto-syncing of apps that need to be synced.
- Decrease the backlight time.
- Decrease the screen brightness.

## Battery charging tips and precautions

-  Use only Samsung-approved battery, charger, and cable specifically designed for your device. Incompatible battery, charger, and cable can cause serious injuries or damage to your device.
- 
  - Connecting the charger improperly may cause serious damage to the device. Any damage caused by misuse is not covered by the warranty.
  - Use only USB Type-C cable supplied with the device. The device may be damaged if you use Micro USB cable.
  - If you charge the device while the multipurpose jack is wet, the device may be damaged. Thoroughly dry the multipurpose jack before charging the device.
- 
  - To save energy, unplug the charger when not in use. The charger does not have a power switch, so you must unplug the charger from the electric socket when not in use to avoid wasting power. The charger should remain close to the electric socket and easily accessible while charging.
  - When using a charger, it is recommended to use an approved wired or wireless charger that guarantees the charging performance.
  - If the battery is completely discharged, the device cannot be turned on immediately when the charger is connected. Allow a depleted battery to charge for a few minutes before turning on the device.
  - If you use multiple apps at once, network apps, or apps that need a connection to another device, the battery will drain quickly. To avoid losing power during a data transfer, always use these apps after fully charging the battery.
  - Using a power source other than the charger, such as a computer, may result in a slower charging speed due to a lower electric current.
  - The device can be used while it is charging, but it may take longer to fully charge the battery.
  - If the device receives an unstable power supply while charging, the touchscreen may not function. If this happens, unplug the charger from the device.
  - While charging, the device and the charger may heat up. This is normal and should not affect the device's lifespan or performance. If the battery gets hotter than usual, the charger may stop charging.
  - If the device is not charging properly, take the device and the charger to a Samsung Service Centre.

## Nano-SIM card and eSIM

Insert the SIM or USIM card provided by the mobile telephone service provider.

To have two phone numbers or service providers for a single device, activate the eSIM or insert two SIM cards. Differing from a physical nano-SIM card, an eSIM is an embedded digital SIM. Using both the nano-SIM card and the eSIM may result in slower data transfer speeds in some areas.

- ✎ • eSIM may not be available depending on the region, service provider, or model.
- Some services that require a network connection may not be available depending on the service provider.

## Installing the SIM or USIM card

► Galaxy S22 Ultra:

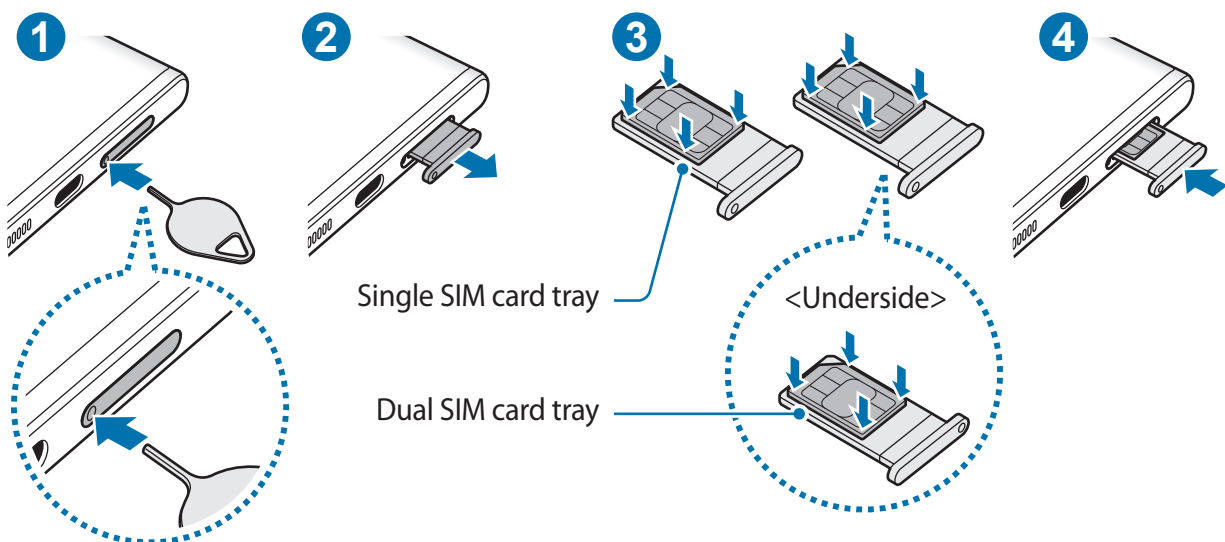

► Galaxy S22+, Galaxy S22:

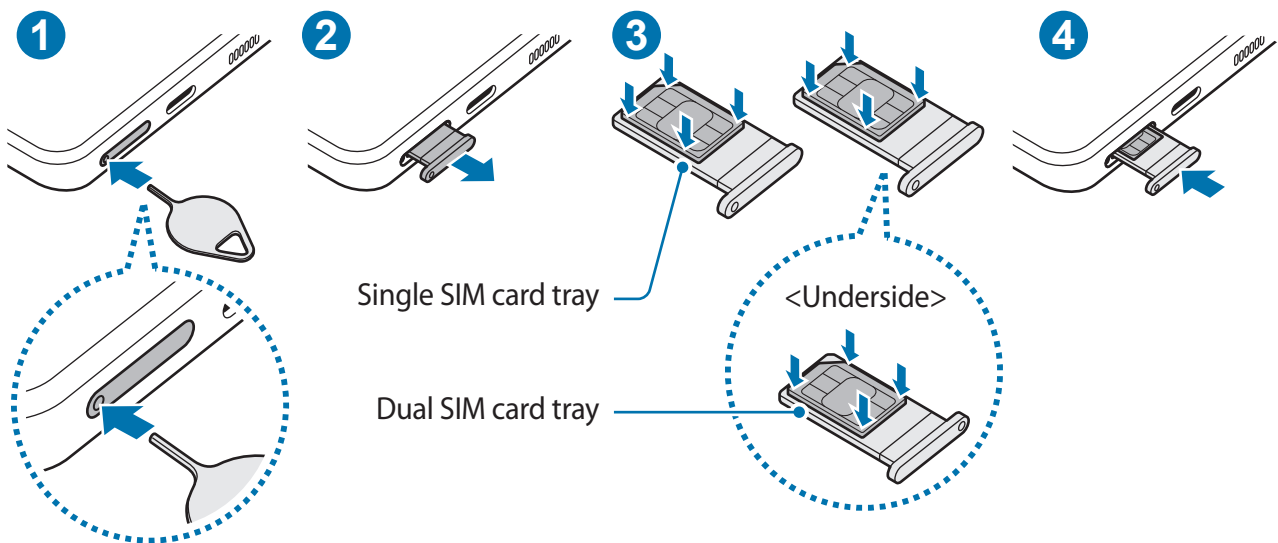

- 1 Insert the ejection pin into the hole on the tray to loosen the tray.
- 2 Pull out the tray gently from the tray slot.
- 3 Place the SIM or USIM card on the tray with the gold-coloured contacts facing upwards and gently press the SIM or USIM card into the tray to secure it.
- 4 Insert the tray back into the tray slot.

- ❗ • Insert the ejection pin into **the tray's hole** to remove the tray.
- Use only a nano-SIM card.
- Use caution not to lose or let others use the SIM or USIM card. Samsung is not responsible for any damages or inconveniences caused by lost or stolen cards.
- Ensure that the ejection pin is perpendicular to the hole. Otherwise, the device may be damaged.
- If the card is not fixed firmly into the tray, the SIM card may leave or fall out of the tray.
- If you insert the tray into your device while the tray is wet, your device may be damaged. Always make sure the tray is dry.
- Fully insert the tray into the tray slot to prevent liquid from entering your device.



## Activating an eSIM

Launch the **Settings** app and tap **Connections** → **SIM card manager** → **Add mobile plan**. When a mobile plan is found, follow the on-screen instructions to activate the eSIM.

If you have a QR code provided by your service provider, launch the **Settings** app, tap **Connections** → **SIM card manager** → **Add mobile plan** → **Scan carrier QR code**, and then scan the QR code.

## SIM card manager (dual SIM models)

Launch the **Settings** app and tap **Connections** → **SIM card manager**.

- **SIM cards:** Activate the SIM card to use and customise the SIM card settings.
- **eSIMs:** Activate the eSIM.
- **Preferred SIM card:** Select to use specific SIM cards for some features, such as voice calls, when two cards are activated.
- **Auto data switching:** Set the device to use another SIM card for data services if the preferred SIM card cannot connect to the network.
- **More SIM card settings:** Customise the call or eSIM settings.

## Turning the device on and off

- ☑ Follow all posted warnings and directions from authorised personnel in areas where the use of wireless devices is restricted, such as aeroplanes and hospitals.

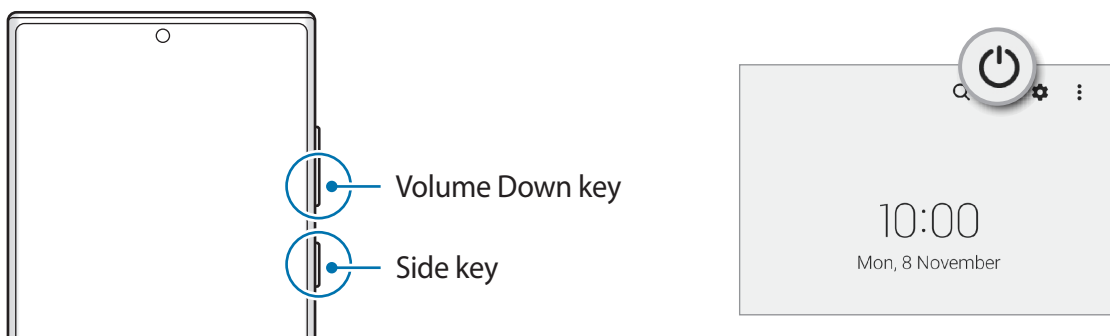

### Turning the device on

Press and hold the Side key for a few seconds to turn on the device.

## Turning the device off

1 To turn off the device, press and hold the Side key and the Volume Down key simultaneously. Alternatively, open the notification panel, swipe downwards, and then tap .

2 Tap **Power off**.

To restart the device, tap **Restart**.

 You can set the device to turn off when you press and hold the Side key. Launch the **Settings** app, tap **Advanced features** → **Side key**, and then tap **Power off menu** under **Press and hold**.

## Forcing restart

If your device is frozen and unresponsive, press and hold the Side key and the Volume Down key simultaneously for more than 7 seconds to restart it.

## Emergency mode

You can switch the device to emergency mode to reduce battery consumption. Some apps and functions will be restricted. In emergency mode, you can make an emergency call, send your current location information to others, sound an emergency alarm, and more.

To activate emergency mode, press and hold the Side key and the Volume Down key simultaneously, and then tap **Emergency mode**. Alternatively, open the notification panel, swipe downwards, and then tap  → **Emergency mode**.

To deactivate emergency mode, tap  → **Turn off Emergency mode**.

 The usage time left shows the time remaining before the battery power runs out. Usage time left may vary depending on your device settings and operating conditions.

## Initial setup

When you turn on your device for the first time or after performing a data reset, follow the on-screen instructions to set up your device.

 If you do not connect to a Wi-Fi network, you may not be able to set up some device features during the initial setup.

## Samsung account

Your Samsung account is an integrated account service that allows you to use a variety of Samsung services provided by mobile devices, TVs, and the Samsung website.

To check the list of services that can be used with your Samsung account, visit [account.samsung.com](https://account.samsung.com).

- 1 Launch the **Settings** app and tap **Samsung account**.  
Alternatively, launch the **Settings** app and tap **Accounts and backup** → **Manage accounts** → **Add account** → **Samsung account**.
- 2 If you already have a Samsung account, sign in to your Samsung account.
  - If you want to sign in using your Google account, tap **Continue with Google**.
  - If you do not have a Samsung account, tap **Create account**.

### Finding your ID and resetting your password

If you forget your Samsung account ID or password, tap **Find ID** or **Forgot password?** on the Samsung account sign-in screen. You can find your ID or reset your password after you enter the required information.

### Signing out of your Samsung account

When you sign out of your Samsung account, your data, such as contacts or events, will also be removed from your device.

- 1 Launch the **Settings** app and tap **Accounts and backup** → **Manage accounts**.
- 2 Tap **Samsung account** → **My profile** and tap **Sign out** at the bottom of the screen.
- 3 Tap **Sign out**, enter your Samsung account password, and then tap **OK**.

## Transferring data from your previous device (Smart Switch)

You can use Smart Switch to transfer data from your previous device to your new device.

Launch the **Settings** app and tap **Accounts and backup** → **Bring data from old device**.



- This feature may not be supported on some devices or computers.
- Limitations apply. Visit [www.samsung.com/smartswitch](http://www.samsung.com/smartswitch) for details. Samsung takes copyright seriously. Only transfer content that you own or have the right to transfer.

### Transferring data using a USB cable

You can connect your previous device to your device with the USB cable to easily and quickly transfer data.

- 1 Connect your device and the previous device using your device's USB cable.  
A USB connector may be needed depending on the previous device.
  - 2 When the app selection pop-up window appears, tap **Smart Switch** → **Receive data**.
  - 3 In the previous device, tap **Allow**.  
If you do not have the app, download it from **Galaxy Store** or **Play Store**.  
Your device will recognise the previous device and a list of data you can transfer will appear.
  - 4 On your device, select an option you want, tap **Next**, and then follow the on-screen instructions to transfer data.
- Do not disconnect the USB cable from the device when you are transferring files. Doing so may cause data loss or device damage.
  - Transferring data increases the battery power consumption of your device. Ensure that your device is sufficiently charged before transferring data. If the battery power is low, data transfer may be interrupted.

## Transferring data wirelessly

Transfer data from your previous device to your device wirelessly via Wi-Fi Direct.

- 1 On the previous device, launch **Smart Switch**.  
If you do not have the app, download it from **Galaxy Store** or **Play Store**.
- 2 On your device, launch the **Settings** app and tap **Accounts and backup** → **Bring data from old device**.
- 3 Place the devices near each other.
- 4 On the previous device, tap **Send data** → **Wireless**.
- 5 On your device, tap **Receive data**, select your previous device's operating system, and then tap **Wireless**.
- 6 On the previous device, tap **Allow**.
- 7 On your device, select an option you want, tap **Next**, and then follow the on-screen instructions to transfer data.

## Transferring backup data from a computer

Transfer data between your device and a computer. You must download the Smart Switch computer version app from [www.samsung.com/smartswitch](http://www.samsung.com/smartswitch). Back up data from your previous device to a computer and import the data to your device.

- 1 On the computer, visit [www.samsung.com/smartswitch](http://www.samsung.com/smartswitch) to download Smart Switch.
- 2 On the computer, launch Smart Switch.  
 If your previous device is not a Samsung device, back up data to a computer using a program provided by the device's manufacturer. Then, skip to the fifth step.
- 3 Connect your previous device to the computer using the device's USB cable.
- 4 On the computer, follow the on-screen instructions to back up data from the device. Then, disconnect your previous device from the computer.
- 5 Connect your device to the computer using the USB cable.
- 6 On the computer, follow the on-screen instructions to transfer data to your device.

# Understanding the screen

## Controlling the touchscreen

### Tapping

Tap the screen.

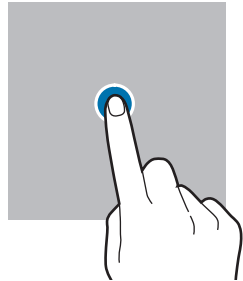

### Tapping and holding

Tap and hold the screen for approximately 2 seconds.

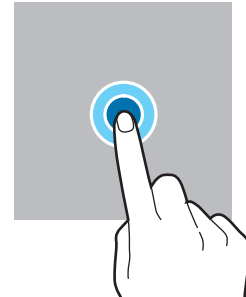

### Dragging

Tap and hold an item and drag it to the target position.

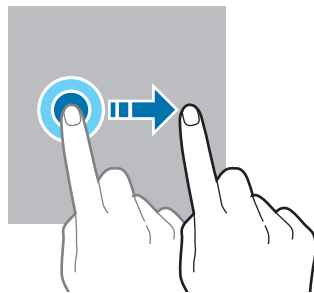

### Double-tapping

Double-tap the screen.

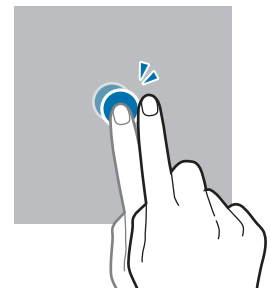

### Swiping

Swipe upwards, downwards, to the left, or to the right.

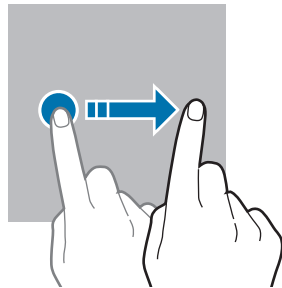

### Spreading and pinching

Spread two fingers apart or pinch on the screen.

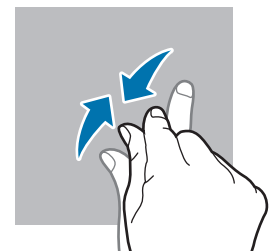
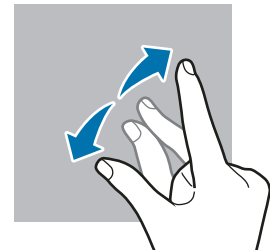

- Do not allow the touchscreen to come into contact with other electrical devices. Electrostatic discharges can cause the touchscreen to malfunction.
- To avoid damaging the touchscreen, do not tap it with anything sharp or apply excessive pressure to it with your fingertips.
- It is recommended not to use fixed graphics on part or all of the touchscreen for extended periods. Doing so may result in afterimages (screen burn-in) or ghosting.



The device may not recognise touch inputs close to the edges of the screen, which are outside of the touch input area.

## Navigation bar (soft buttons)

When you turn on the screen, the soft buttons will appear on the navigation bar at the bottom of the screen. The soft buttons are set to the Recents button, Home button, and Back button by default. The functions of the buttons can change according to the app currently being used or usage environment.

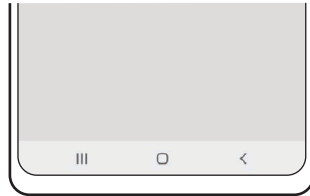

Button		Function
	Recents	<ul style="list-style-type: none"> <li>• Tap to open the list of recent apps.</li> </ul>
□	Home	<ul style="list-style-type: none"> <li>• Tap to return to the Home screen.</li> <li>• Tap and hold to launch the <b>Google Assistant</b> app.</li> </ul>
<	Back	<ul style="list-style-type: none"> <li>• Tap to return to the previous screen.</li> </ul>

## Hiding the navigation bar

View files or use apps on a wider screen by hiding the navigation bar.

Launch the **Settings** app, tap **Display** → **Navigation bar**, and then tap **Swipe gestures** under **Navigation type**. The navigation bar will be hidden and the gesture hints will appear. Tap **More options** and select an option you want.



Swipe from bottom



Swipe from sides and bottom

If you want to hide the gesture hints at the bottom of the screen, tap the **Gesture hint** switch to deactivate it.

## Home screen and Apps screen

The Home screen is the starting point for accessing all of the device's features. It displays widgets, shortcuts to apps, and more.

The Apps screen displays icons for all apps, including newly installed apps.

### Switching between Home and Apps screens

On the Home screen, swipe upwards to open the Apps screen.

To return to the Home screen, swipe upwards or downwards on the Apps screen.

Alternatively, tap the Home button or the Back button.

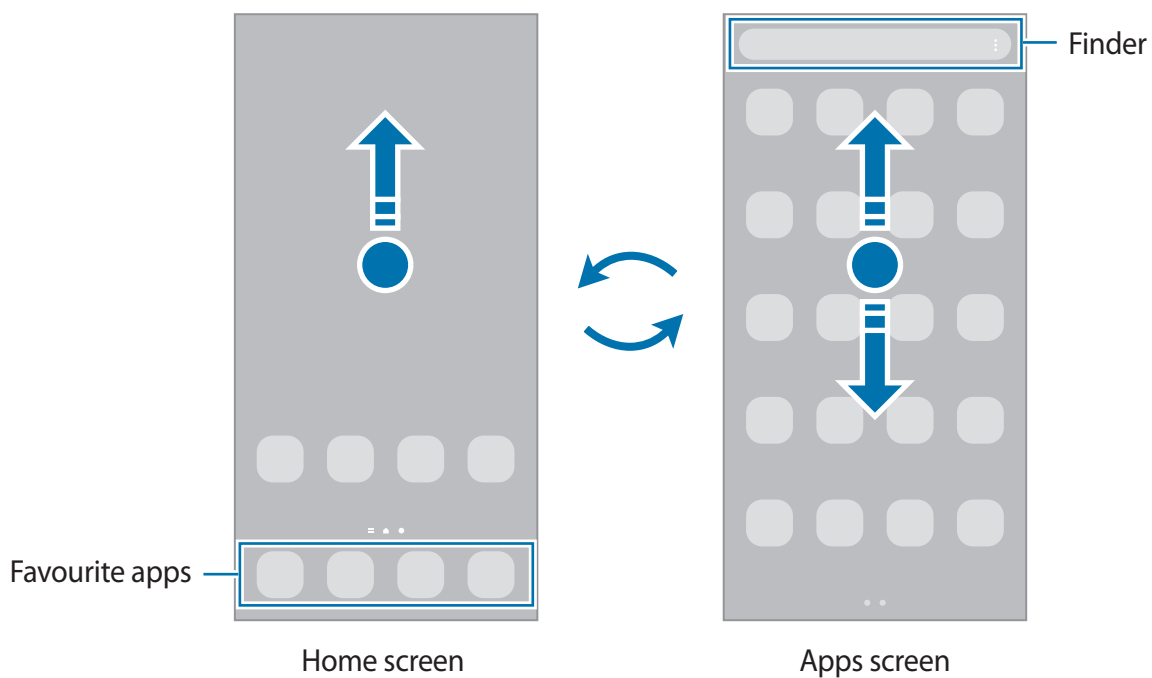



If you add the Apps button on the Home screen, you can open the Apps screen by tapping the button. On the Home screen, tap and hold an empty area, tap **Settings**, and then tap the **Show Apps screen button on Home screen** switch to activate it. The Apps button will be added at the bottom of the Home screen.





## Editing the Home screen

On the Home screen, tap and hold an empty area, or pinch your fingers together to access the editing options. You can set the wallpaper, add widgets, and more. You can also add, delete, or rearrange Home screen panels.

- Adding panels: Swipe to the left, and then tap .
- Moving panels: Tap and hold a panel preview, and then drag it to a new location.
- Deleting panels: Tap  on the panel.

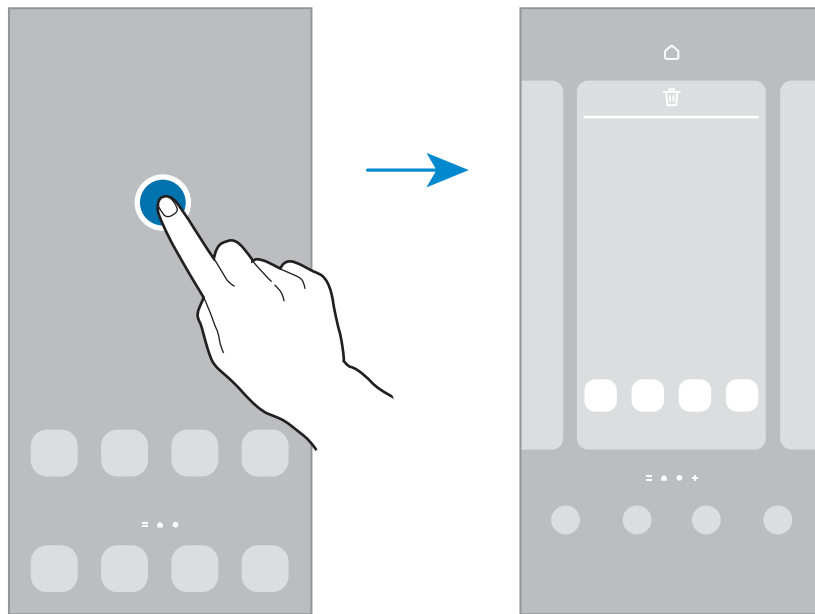

- **Wallpaper and style:** Change the wallpaper settings for the Home screen and the locked screen.
- **Themes:** Change the device's theme. Visual elements of interface, such as colours, icons, and wallpapers, will change depending on the selected theme.
- **Widgets:** Widgets are small apps that launch specific app functions to provide information and convenient access on your Home screen. Select a widget and tap **Add**. The widget will be added on the Home screen.
- **Settings:** Configure settings for the Home screen, such as the screen layout.

## Displaying all apps on the Home screen

Without using a separate Apps screen, you can set the device to display all apps on the Home screen. On the Home screen, tap and hold an empty area, and then tap **Settings** → **Home screen layout** → **Home screen only** → **Apply**.

You can now access all your apps by swiping to the left on the Home screen.

## Launching Finder

Search for content on the device quickly.

- 1 On the Apps screen, tap **Search**. Alternatively, open the notification panel, swipe downwards, and then tap **Q**.
- 2 Enter a keyword.  
Apps and content on your device will be searched.  
If you tap **Q** on the keyboard, you can search for more content.

## Moving items

Tap and hold an item, and then drag it to a new location. To move the item to another panel, drag it to the side of the screen.

To add a shortcut to an app on the Home screen, tap and hold an item on the Apps screen, and then tap **Add to Home**. A shortcut to the app will be added on the Home screen.

You can also move frequently used apps to the shortcuts area at the bottom of the Home screen.

## Creating folders

Create folders and gather similar apps to quickly access and launch apps.

On the Home screen or the Apps screen, tap and hold an app, and then drag it over another app.

A new folder containing the selected apps will be created. Tap **Folder name** and enter a folder name.

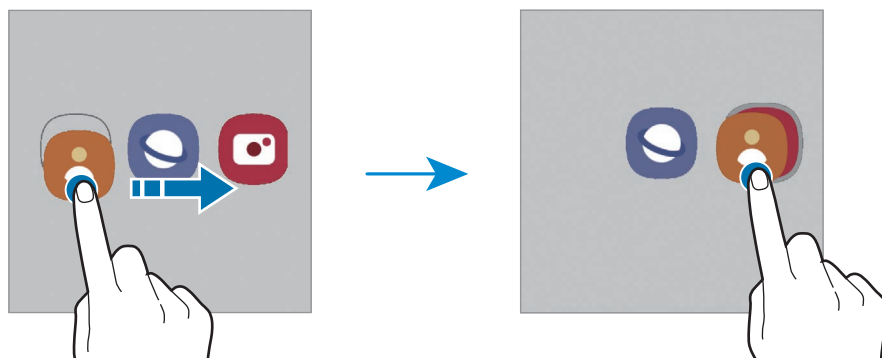

- **Adding more apps**

Tap **+** on the folder. Tick the apps to add and tap **Done**. You can also add an app by dragging it to the folder.

- **Moving apps from a folder**

Tap and hold an app to drag it to a new location.

- **Deleting a folder**

Tap and hold a folder, and then tap **Delete folder**. Only the folder will be deleted. The folder's apps will be relocated to the Apps screen.

## Edge panel

You can quickly access your favourite apps and features from the Edge panels.

Drag the Edge panel handle towards the centre of the screen.

If the Edge panel handle is not visible, launch the **Settings** app, tap **Display**, and then tap the **Edge panels** switch to activate it.

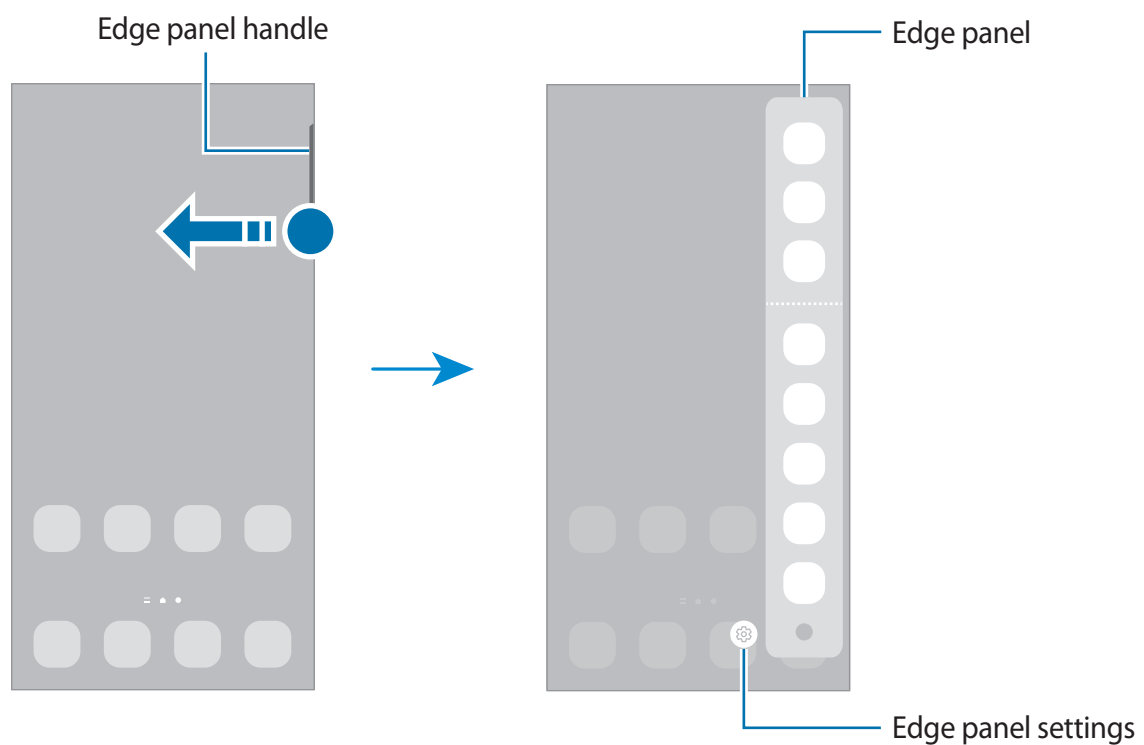

## Lock screen

Pressing the Side key turns off the screen and locks it. Also, the screen turns off and automatically locks if the device is not used for a specified period.

To unlock the screen, swipe in any direction when the screen turns on.

If the screen is off, press the Side key to turn on the screen. Alternatively, double-tap the screen.

## Changing the screen lock method









To change the screen lock method, launch the **Settings** app, tap **Lock screen** → **Screen lock type**, and then select a method.













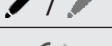

When you set a pattern, PIN, password, or your biometric data for the screen lock method, you can protect your personal information by preventing others from accessing your device. After setting the screen lock method, the device will require an unlock code whenever unlocking it.

 You can set your device to perform a factory data reset if you enter the unlock code incorrectly several times in a row and reach the attempt limit. Launch the **Settings** app, tap **Lock screen** → **Secure lock settings**, unlock the screen using the preset screen lock method, and then tap the **Auto factory reset** switch to activate it.

## Indicator icons

Indicator icons appear on the status bar at the top of the screen. The icons listed in the table below are most common.

Icon	Meaning
	No signal
	Signal strength
	Roaming (outside of normal service area)
	GPRS network connected
	EDGE network connected
	UMTS network connected
	HSDPA network connected
	HSPA+ network connected

Icon	Meaning
	LTE network connected
	5G network connected
	LTE network connected in LTE network that includes the 5G network
	Wi-Fi connected
	Bluetooth feature activated
	S Pen connected/disconnected
	S Pen battery power level
	Location services being used
	Call in progress
	Missed call
	New text or multimedia message
	Alarm activated
	Mute mode / Vibration mode
	Flight mode activated
	Error occurred or caution required
	Battery charging / Battery power level



- The status bar may not appear at the top of the screen in some apps. To display the status bar, drag down from the top of the screen.
- Some indicator icons appear only when you open the notification panel.
- The indicator icons may appear differently depending on the service provider or model.

# Notification panel

When you receive new notifications, indicator icons appear on the status bar. To see more information about the icons, open the notification panel and view the details.

To open the notification panel, drag the status bar downwards. To close the notification panel, swipe upwards on the screen.

You can use the following functions on the notification panel.

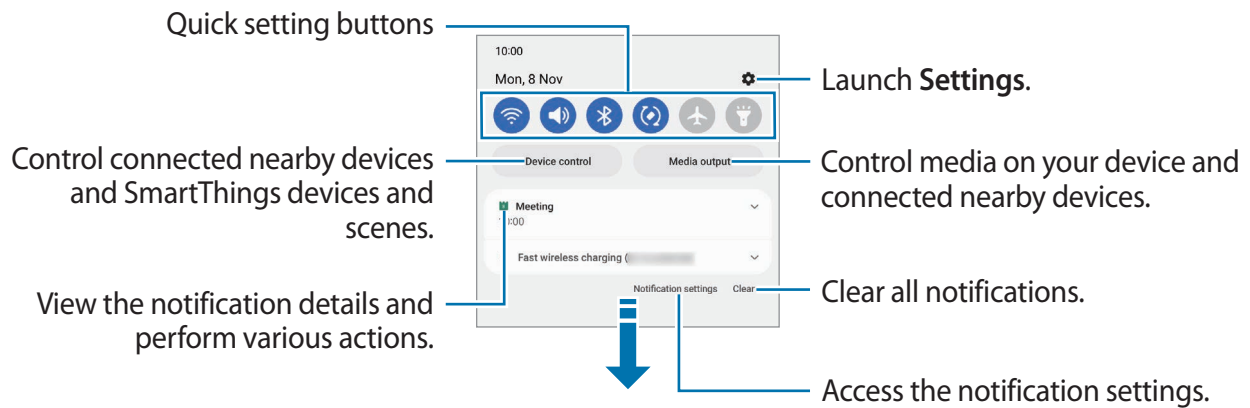

## Using quick setting buttons

Tap quick setting buttons to activate certain features. Swipe downwards on the notification panel to view more buttons. To add more buttons, tap .

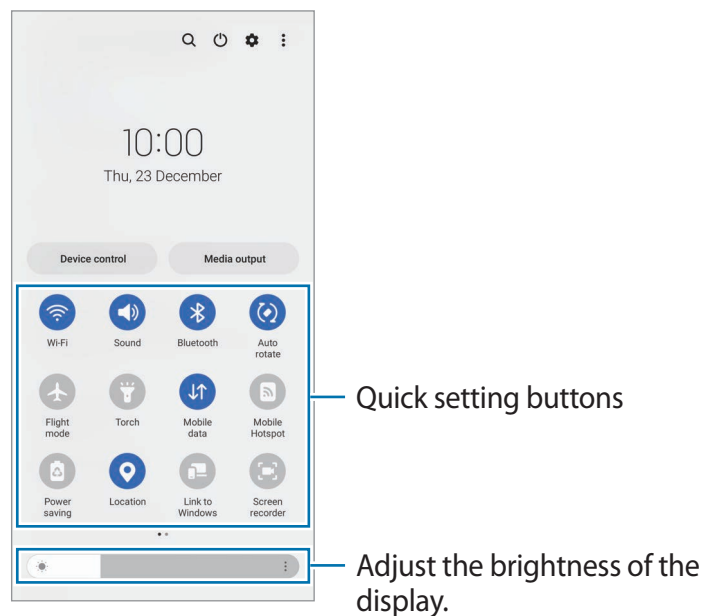

To change feature settings, tap the text under each button. To view more detailed settings, tap and hold a button.

To rearrange buttons, tap  → **Edit buttons**, tap and hold a button, and then drag it to another location.

### Controlling media playback

Take control of music or video playback easily using the Media feature.

- 1 Open the notification panel and tap **Media output**.
- 2 Tap the icons on the controller to control the playback.

### Controlling nearby devices

Launch quickly and take control of nearby connected devices and frequently used SmartThings devices and scenes on the notification panel.

- 1 Open the notification panel and tap **Device control**.  
Nearby connected devices and SmartThings devices and scenes will appear.
- 2 Select a nearby device or a SmartThings device to control it, or select a scene to launch it.

# Screen capture and screen record

## Screen capture

Capture a screenshot while using the device and write on, draw on, crop, or share the captured screen. You can capture the current screen and scrollable area.

### How to capture a screenshot

Use the following methods to capture a screenshot. You can view the captured screenshots in **Gallery**.

**Method 1) Key capture:** Press the Side key and the Volume Down key simultaneously.

**Method 2) Swipe capture:** With the edge of your hand, swipe your hand to the left or right across the screen.

- ✎ • It is not possible to capture a screenshot while using some apps and features.
- If capturing a screenshot by swiping is not activated, launch the **Settings** app, tap **Advanced features** → **Motions and gestures**, and then tap the **Palm swipe to capture** switch to activate it.

After capturing a screenshot, use the following options on the toolbar at the bottom of the screen:

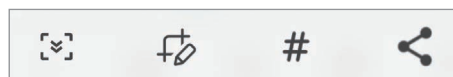







- ☞: Capture the current content and the hidden content on an elongated page, such as a webpage. When you tap ☞, the screen will automatically scroll down and more content will be captured.
  - ✎: Write or draw on the screenshot or crop a portion from the screenshot. You can view the cropped area in **Gallery**.
  - #: Add tags to the screenshot. To search for screenshots by tag, tap **Search** at the top of the Apps screen and tap **Screenshots** → **Q**. You can view the tags list and easily search for the screenshot you want.
  - ↗: Share the screenshot with others.
- ✎ If the options are not visible on the captured screen, launch the **Settings** app, tap **Advanced features** → **Screenshots and screen recorder**, and then tap the **Screenshot toolbar** switch to activate it.



## Screen record

Record the screen while using your device.

- 1 Open the notification panel, swipe downwards, and then tap  (**Screen recorder**) to activate it.
  - 2 Select a sound setting and tap **Start recording**.  
After a countdown, recording will start.
    - To write or draw on the screen, tap .
    - To show the S Pen pointer on the screen, tap . You can use this feature only when the S Pen is detached from the device. (Galaxy S22 Ultra)
    - To record the screen with a video overlay of yourself, tap .
  - 3 When you are finished recording the video, tap .  
You can view the video in **Gallery**.
-  To change the screen recorder settings, launch the **Settings** app and tap **Advanced features** → **Screenshots and screen recorder**.

## Entering text

### Keyboard layout

A keyboard appears automatically when you enter text.

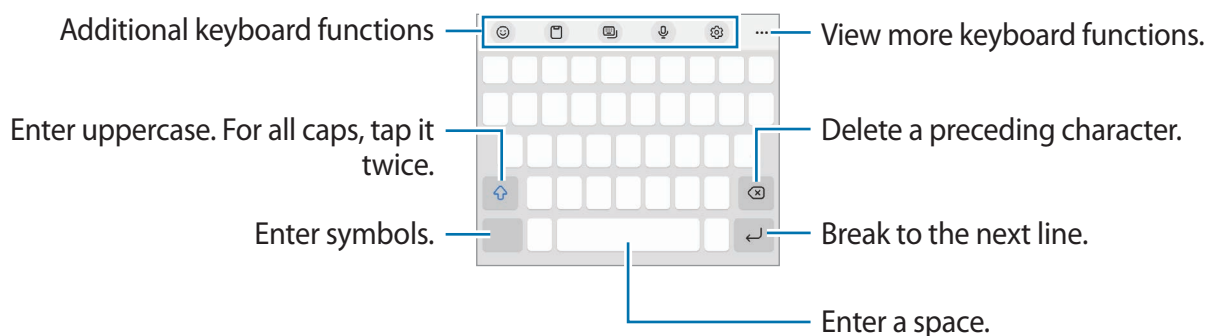

-  Text entry is not supported in some languages. To enter text, you must change the input language to one of the supported languages.



## Changing the input language

Tap  → **Languages and types** → **Manage input languages** and select the languages to use. When you select two or more languages, you can switch between the input languages by swiping to the left or right on the space key.





## Changing the keyboard

On the navigation bar, tap  to change the keyboard.









To change the keyboard type, tap  → **Languages and types**, select a language, and then select the keyboard type you want.





-  • If the keyboard button () does not appear on the navigation bar, launch the **Settings** app, tap **General management** → **Keyboard list and default**, and then tap the **Keyboard button on navigation bar** switch to activate it.
- On a 3 x 4 keyboard, a key has three or four characters. To enter a character, tap the corresponding key repeatedly until the desired character appears.

## Additional keyboard functions

-  : Enter emojis, stickers, and more. You can also enter your emoji stickers that look like you. Refer to [Using your AR emoji stickers in chats](#) for more information.
-  : Add an item from the clipboard.
-  : Change the keyboard mode.
-  : Enter text by voice.
-  : Change the keyboard settings.

Tap  to use more keyboard functions.



-  : Switch to handwriting mode.
-  : Search for content and enter it.
-  : Translate text and enter it.
-  : Enter your personal information registered to Samsung Pass.
-  : Share music links.
-  : Share video links.
-  : Enter emojis.
-  : Attach animated GIFs.

-  /  /  : Enter stickers.
-  : Change the keyboard size.
-  : Open the text editing panel.



Some features may not be available depending on the service provider or model.

## Copying and pasting

- 1 Tap and hold over text.
- 2 Drag  or  to select the desired text, or tap **Select all** to select all text.
- 3 Tap **Copy** or **Cut**.  
The selected text is copied to the clipboard.
- 4 Tap and hold where the text is to be inserted and tap **Paste**.  
To paste text that you have previously copied, tap **Clipboard** and select the text.



# Apps and features

## Installing or uninstalling apps

### Galaxy Store

Purchase and download apps. You can download apps that are specialised for Samsung Galaxy devices.

Launch the **Galaxy Store** app. Browse apps by category or tap **Q** to search for a keyword.

-  • This app may not be available depending on the service provider or model.
- To change the auto update settings, tap **Menu** →  → **Auto update apps**, and then select an option.

### Play Store

Purchase and download apps.

Launch the **Play Store** app. Browse apps by category or search for apps by keyword.

-  To change the auto update settings, tap your account icon, tap **Settings** → **Network preferences** → **Auto-update apps**, and then select an option.

## Managing apps

### Uninstalling or disabling apps

Tap and hold an app and select an option.

- **Uninstall:** Uninstall downloaded apps.
- **Disable:** Disable selected default apps that cannot be uninstalled from the device.

-  Some apps may not support this feature.

### Enabling apps

Launch the **Settings** app, tap **Apps** →  → **Disabled** → **OK**, select an app, and then tap **Enable**.

## Setting app permissions

For some apps to operate properly, they may need permission to access or use information on your device.

To view your app permission settings, launch the **Settings** app and tap **Apps**. Select an app and tap **Permissions**. You can view the app's permissions list and change its permissions.

To view or change app permission settings by permission category, launch the **Settings** app and tap **Apps** → ⋮ → **Permission manager**. Select an item and select an app.

 If you do not grant permissions to apps, the basic features of the apps may not function properly.

## S Pen (Galaxy S22 Ultra)

### Using the S Pen

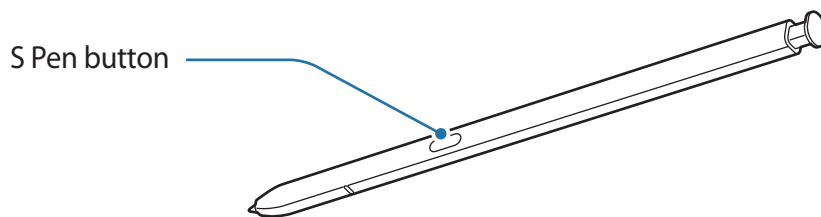

- ⚠ • Do not bend or apply excessive pressure with the S Pen while using it. The S Pen may be damaged or the nib may be deformed.
- Do not hard press on the screen with the S Pen. The pen nib may be deformed.
-  • If there is a magnet near the device, some S Pen actions, such as charging or tapping the touchscreen, may not work.
- Even if the S Pen has been fully discharged, you can use other S Pen features, such as tapping the touchscreen or the Air command features.
- If you use the S Pen at sharp angles on the screen, the device may not recognise the S Pen actions.
- If water enters the S Pen slot, gently shake the device to remove the water from the slot before using it.
- If the S Pen is not working properly, take it to a Samsung Service Centre.

## Detaching the S Pen

Press the end of the S Pen to disengage it. Then, pull the S Pen from the slot. To store the S Pen, reinsert it into the slot and push it until it clicks into place.

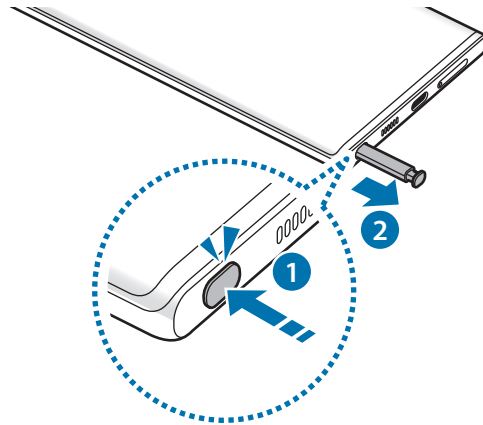

## Charging the S Pen

The S Pen must be charged before you can control apps remotely by using the S Pen button.



When you insert the S Pen into the slot, charging will start.

If the Air action feature is deactivated, the S Pen will be charged only when the device is charging.

## Air actions

Control apps remotely by using the S Pen connected to your device via Bluetooth Low Energy (BLE).

For example, you can quickly launch apps, such as the camera app, by pressing and holding the S Pen button. Also, while using the camera app, you can take a picture by pressing the button once. While playing music, you can turn the volume up if you lift the S Pen up while pressing and holding the S Pen button and turn the volume down if you lower it.

- ✍ • The S Pen must be charged before you can use the Air actions feature. Refer to [Charging the S Pen](#) for more information.
- When you detach the S Pen from the slot, the  icon will appear on the status bar. If the S Pen is discharged or far from the device, or if there are obstacles or there is external interference between the S Pen and the device, the S Pen will be disconnected from the device and the icon will turn grey (). To use the Air actions feature again, connect the S Pen with the device by reinserting the S Pen into the slot.

## Taking pictures with the S Pen

Even though you take pictures with your device placing for a distance, you can easily take pictures by pressing the S Pen button without setting a timer.

- 1 Launch the **Settings** app, tap **Advanced features** → **S Pen** → **Air actions**, and then tap the switch to activate the feature.
- 2 Launch the **Camera** app.
- 3 Press the S Pen button once to take a picture.
  - To take a series of pictures, press and hold the S Pen button.
  - To change the shooting mode, move the S Pen to the left or right while pressing and holding the S Pen button.
  - To switch between cameras, press the S Pen button twice.

## Changing apps or features to use

Change the app, feature, or actions you want to use with the S Pen feature. Launch the **Settings** app, tap **Advanced features** → **S Pen** → **Air actions**.

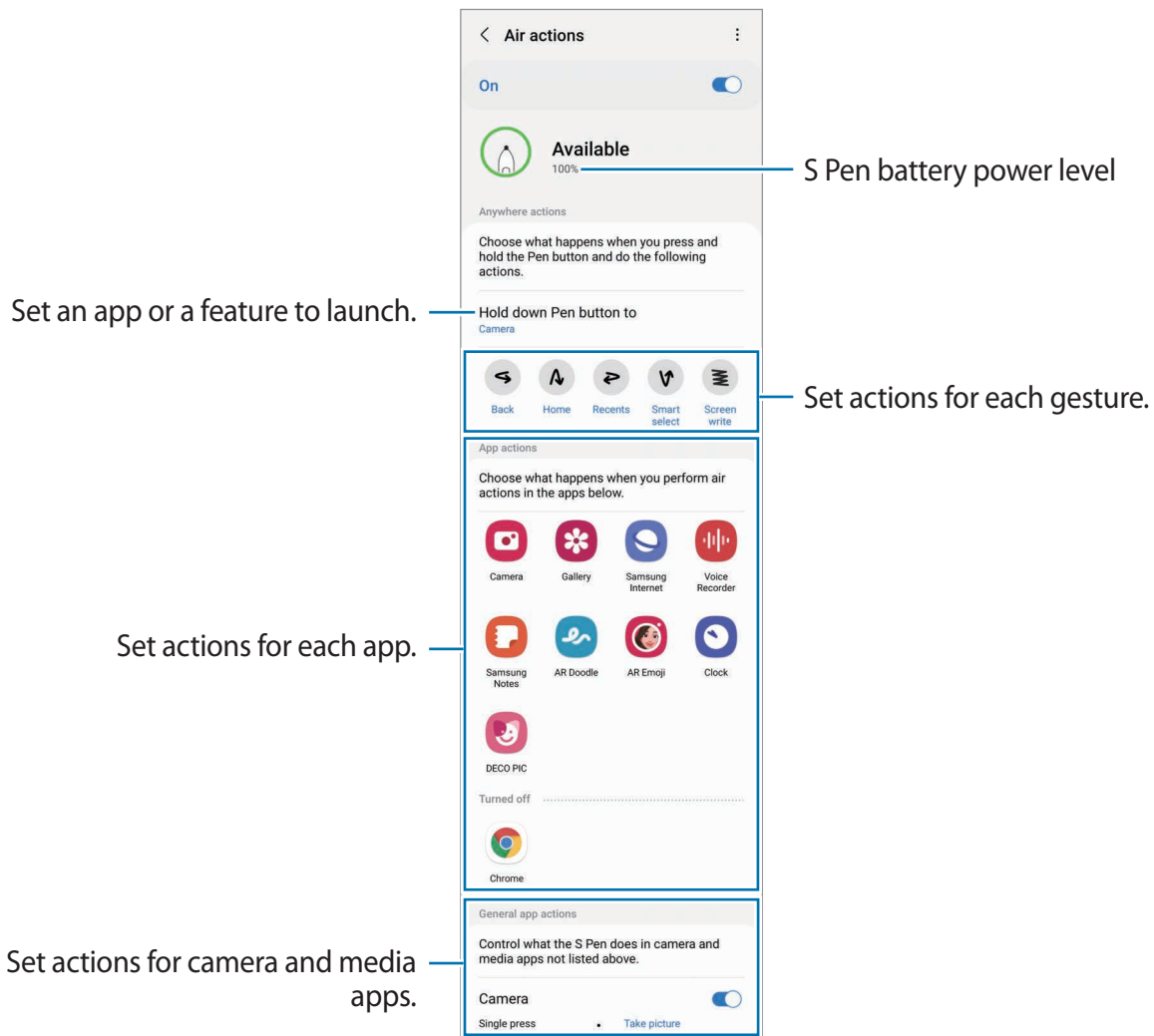

## Resetting your S Pen

If the S Pen has connection problems or the S Pen disconnects often, reset the S Pen and connect it again.

Insert the S Pen into the slot. Then, open the Air actions setting screen and tap  → **Reset S Pen**.

-  • You can only connect Samsung-approved S Pens that support Bluetooth Low Energy (BLE).
- Do not detach the S Pen from the device when it is being connected. Doing so will interrupt the process.

## Air command

Air command is a menu that provides S Pen features and quick access to frequently used apps.

To open the Air command panel, detach the S Pen from the slot or hover the S Pen over the screen and press the S Pen button. You can also tap the Air command icon () with the S Pen.

Select a function or app on the Air command panel.

-  When the screen is off or locked with a screen lock method, removing the S Pen will not open the Air command panel.

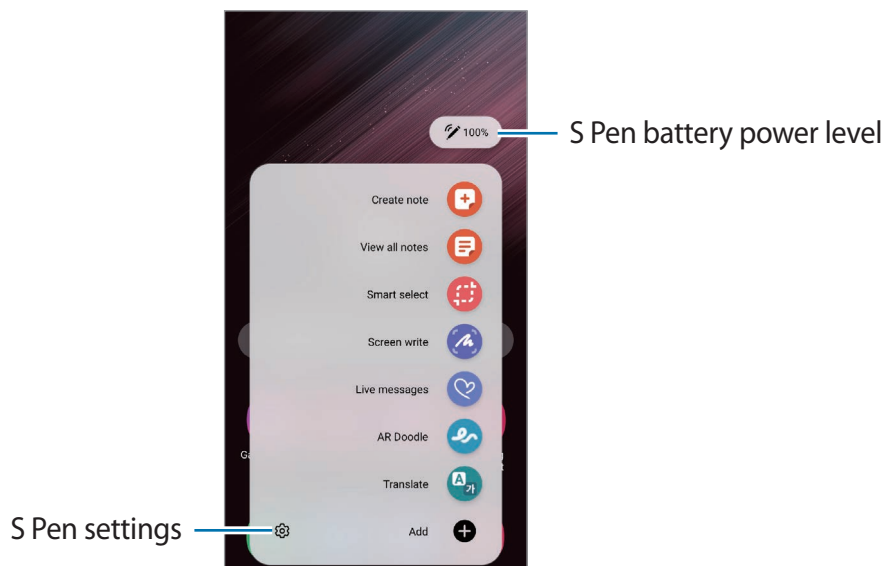

- **Create note:** Create notes easily in a pop-up window. You can also launch this feature by double-tapping the screen while pressing and holding the S Pen button. Refer to [Samsung Notes](#) for more information.



- **View all notes:** View all notes in the **Samsung Notes** app.
- **Smart select:** Use the S Pen to select an area and perform actions, such as sharing or saving. Refer to [Smart select](#) for more information.
- **Screen write:** Capture screenshots to write or draw on them or crop an area from the captured image. You can also capture the current content and the hidden content on an elongated page, such as a webpage. Refer to [Screen write](#) for more information.
- **Live messages:** Instead of text message, create and send a unique message by recording your actions while handwriting or drawing a live message and saving it as an animated file. Refer to [Live messages](#) for more information.
- **AR Doodle:** Record fun videos with virtual handwriting or drawings on faces or anywhere else. Refer to [AR Doodle](#) for more information.
- **Translate:** Hover the S Pen over a word to translate it. Refer to [Translate](#) for more information.
- **PENUP:** Post your artwork, view others' artwork, and get useful drawing tips.
- **Bixby Vision:** Use the Bixby Vision features to search for similar images, detect and translate text, and more. Refer to [Bixby Vision](#) for more information.
- **Magnify:** Hover the S Pen over an area of the screen to enlarge it.
- **Glance:** Reduce an app to a thumbnail and hover the S Pen over the thumbnail to open the app in full screen view. Refer to [Glance](#) for more information.
- **Colouring:** Add colours to images provided by PENUP using the S Pen.
- **Write on calendar:** Launch the **Calendar** app and write or draw on the screen. Refer to [Write on calendar](#) for more information.
- **Add:** Add shortcuts to frequently used apps to the Air command panel.

## Air command icon

When the Air command panel is closed, the Air command icon will remain on the screen. You can open the Air command panel by tapping the icon with the S Pen.

To move the icon, drag  to a new location.

To remove the icon, drag  to **Remove** at the top of the screen.

If the Air command icon does not appear on the screen, launch the **Settings** app, tap **Advanced features** → **S Pen**, and then tap the **Show air command icon** switch to activate it.





While using apps that support the Air actions feature, you can view actions available with each app by hovering the S Pen over the Air command icon.

## Smart select

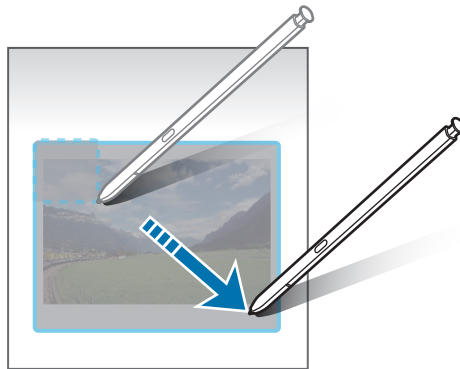
Use the S Pen to select an area and perform actions, such as sharing or saving. You can also select an area from a video and capture it as a GIF animation.

- 1 When there is content you want to capture, such as a part of an image, open the Air command panel and tap **Smart select**.
- 2 Select a desired shape icon on the toolbar and drag the S Pen across the content you want to select.



- 3 Select an option to use with the selected area.
  - **Pin/Insert:** Pin the selected area to the screen. You can also insert the image into other apps, such as **Samsung Notes**. Tap and hold the image, and drag it to the other app's screen.
  - : Automatically changes the appearance of the selected area.
  - : Write or draw on the selected area.
  - : Extract text from the selected area.
  - : Share the selected area with others.
  - : Save the selected area in **Gallery**.

## Capturing an area from a video

While playing a video, select an area and capture it as a GIF animation.

- 1 When there is content you want to capture during video playback, open the Air command panel and tap **Smart select**.
- 2 On the toolbar, tap .
- 3 Adjust the position and size of the capturing area.

Adjust the position.

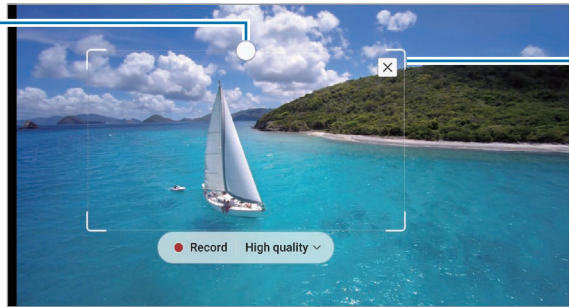

Drag a corner of the frame to resize.





- 4 Tap **Record** to start capturing.



- Before capturing a video, make sure that the video is playing.
- The maximum duration you can capture an area of the video for will be displayed on the screen.
- When capturing an area from a video, its sound will not be recorded.

- 5 Tap **Stop** to stop capturing.

- 6 Select an option to use with the selected area.

- : Write or draw on the selected area. Tap  to view the result before saving the file.
- : Share the selected area with others.
- : Save the selected area in **Gallery**.

## Screen write

Capture screenshots to write or draw on them or crop an area from the captured image.

- 1 When there is content you want to capture, open the Air command panel and tap **Screen write**.

The current screen is automatically captured and the editing toolbar appears.

- 2 Write a memo on the screenshot.

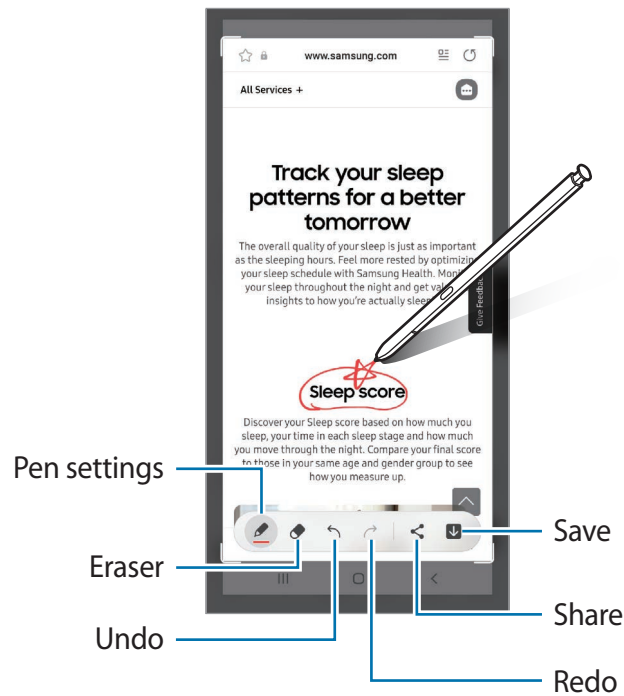

- 3 Share or save the screenshot.

You can view the captured screenshots in **Gallery**.

-  It is not possible to capture a screenshot while using some apps.

## Live messages

Instead of a text message, create and send a unique message by recording your actions while handwriting or drawing a live message and saving it as an animated file.



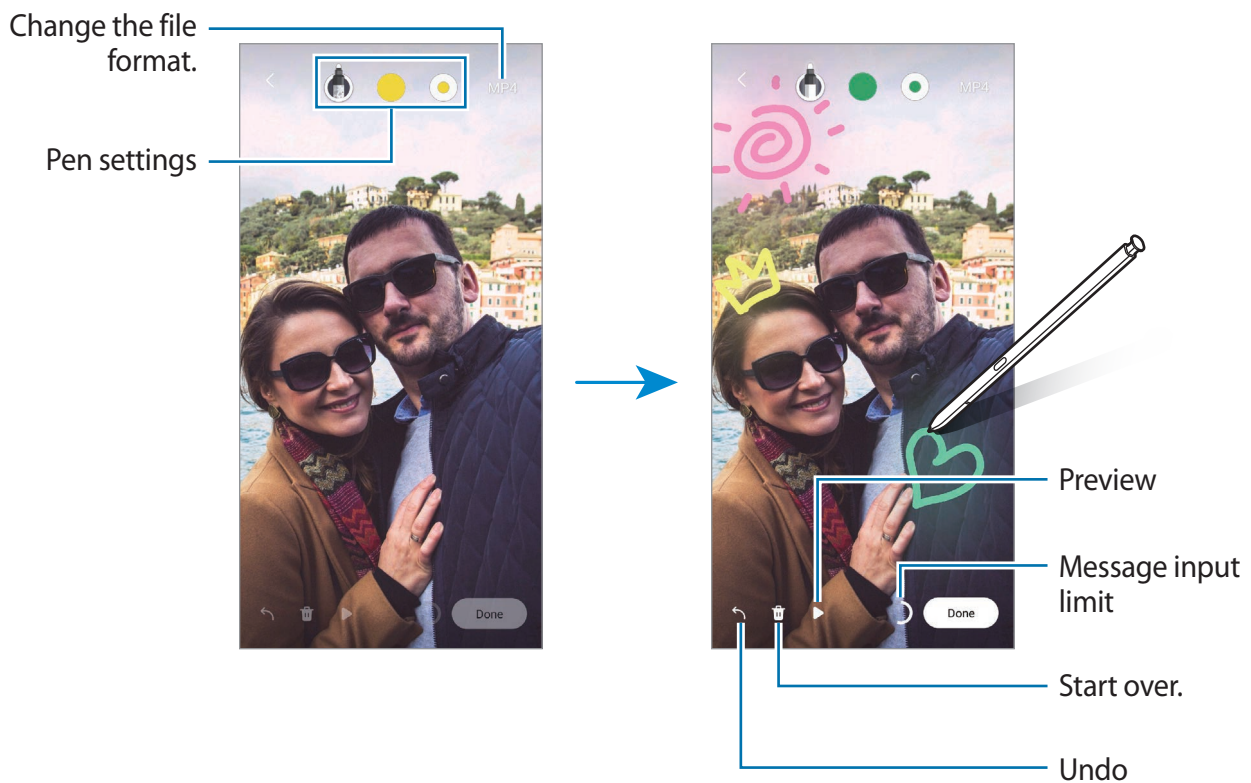

- 1 When you want to send an animated message, open the Air command panel and tap **Live messages**.
- 2 Customise background image and tap **Done** or **Start drawing**.
- 3 Write or draw on the live message screen.



- 4 Tap **Done**.  
The live message will be saved in **Gallery** as an animated GIF file or a video.
- 5 Tap **Share** and select a method.

## Translate

Hover the S Pen over the text you want to translate. The units included in the text will also be converted.

- 1 When there is text you want to translate, open the Air command panel and tap **Translate**.
- 2 Select the languages on the translator panel at the top of the screen.  
You can change the text between words and sentences by tapping  or .
- 3 Hover the S Pen over the text you want to translate or the unit you want to convert.  
The translated text will appear. To listen to the pronunciation of the original text, tap . The  icon may not appear depending on the language you select.

Select languages.

Text selecting granularity (word or sentence)

Translation result

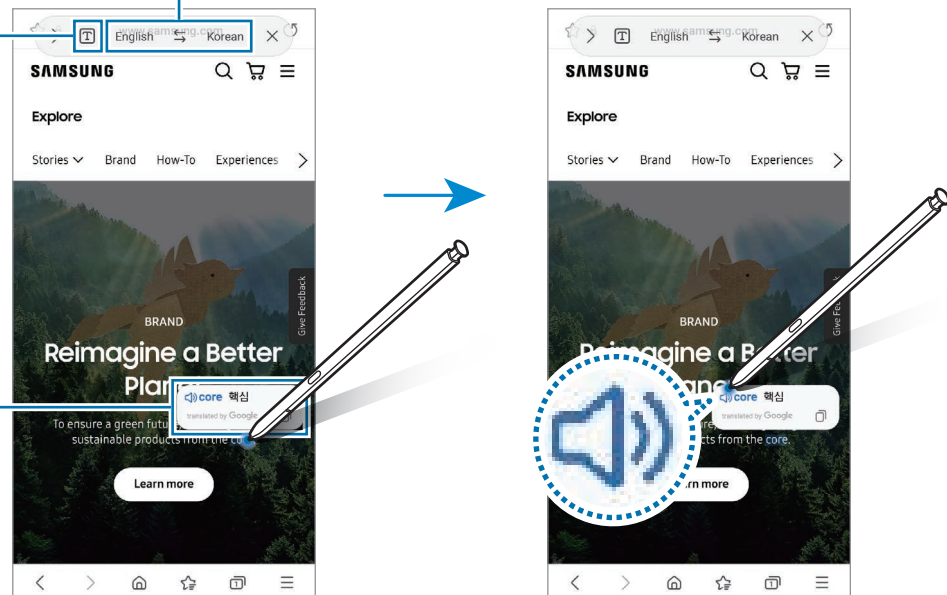

-  This feature does not support some languages.
- This feature is available only when detectable text is on the screen.

## Bixby Vision

When you hover the S Pen over the content, the content is recognised and available search icons will appear. Use the features to search for similar images, detect and translate text, and more. Refer to [Bixby Vision](#) for more information.

- 1 When there is an image you want to search for relevant information or extract text from, open the Air command panel and tap **Bixby Vision**.
- 2 Hover the S Pen over the content you want. When the available options appear on the screen, select an option you want.



## Glance

Reduce an app to a thumbnail and hover the S Pen over the thumbnail to open the app in full screen view.

For example, launch a map app, open the Air command panel, and then tap **Glance**. The app will be reduced to a thumbnail at the bottom of the screen. While browsing webpages, hover the S Pen over the thumbnail to open the map app on the full screen and quickly search for places.

Hover the S Pen away from the screen to reduce the app to a thumbnail again.

To close the minimised app, tap and hold the thumbnail and drag it to **Remove** at the top of the screen.



## Write on calendar

Fill in your plans easily and quickly by writing or drawing on the calendar screen.

Open the Air command panel, tap **Write on calendar**, and then fill in your plans on the calendar. When you are finished, tap **Save**. To edit it, tap .

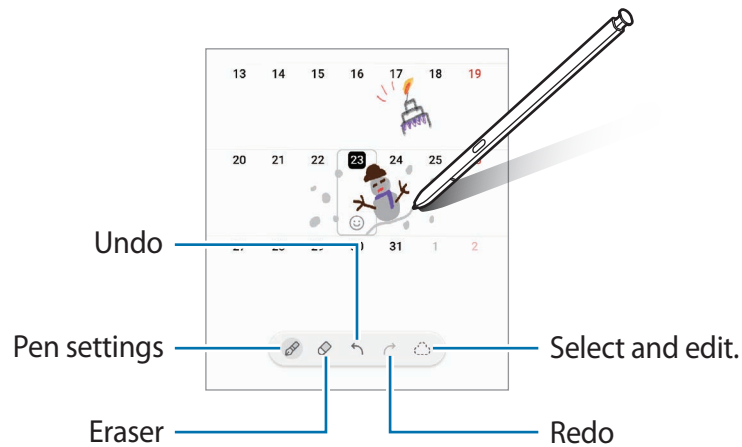

## S Pen to text

You can set the device to convert anything you write with the S Pen into text.

1 Launch the **Settings** app, tap **Advanced features** → **S Pen** → **S Pen to text**, and then tap the switch to activate it.

 To view how to edit text with the S Pen, tap **Learn how to edit with your S Pen**.

2 Write in a text input field, such as a search field or address bar, using the S Pen. The handwriting will be converted to text.

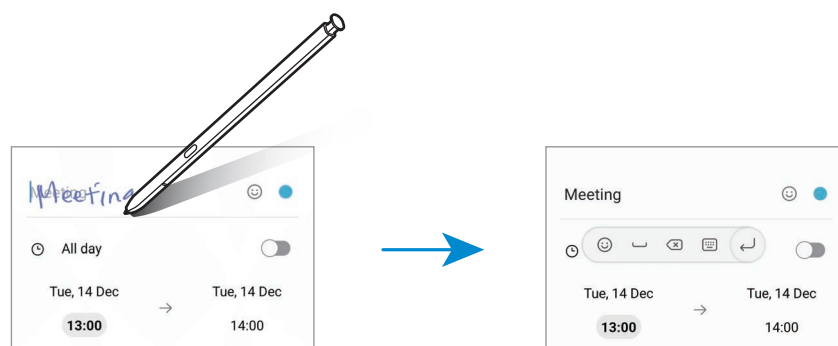





## Air view

Hover the S Pen over an item on the screen to preview content or view information in a pop-up window.

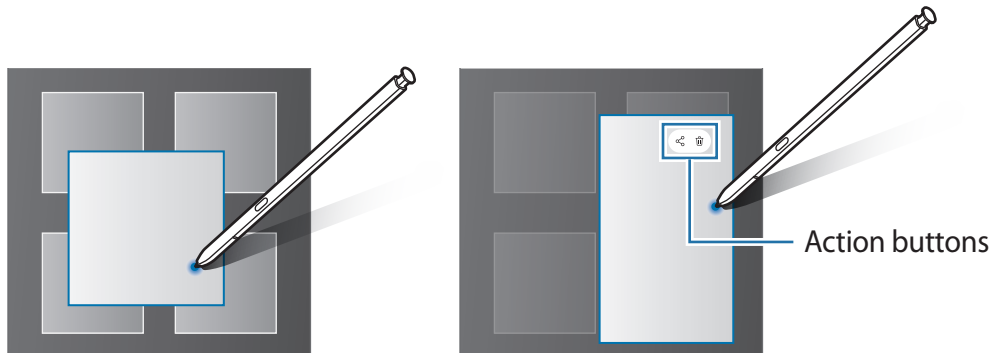
In some apps, Action buttons will be displayed on the preview window.



 If this feature is not activated, launch the **Settings** app, tap **Advanced features** → **S Pen**, and then tap the **Air view** switch to activate it.

## Pen Select

While pressing and holding the S Pen button, drag the S Pen over text or item lists to select multiple items or text. You can also copy and paste the selected items or text into another app or share them with others.

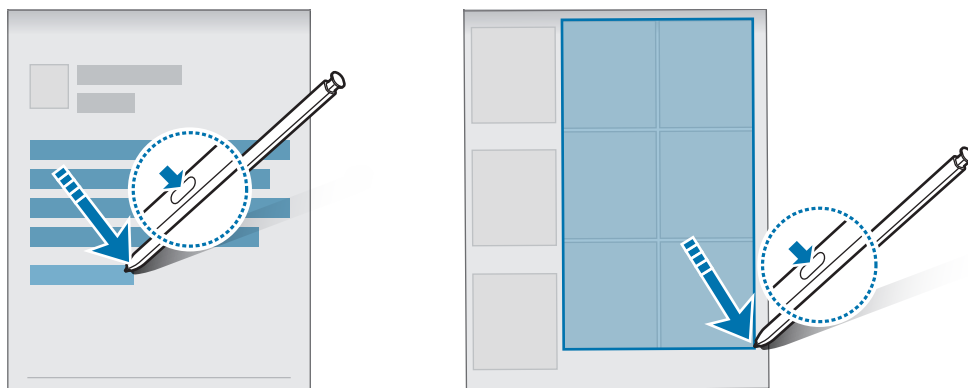

## Screen off memo

You can quickly create memos by writing on the screen without turning on it.

When the screen is off, detach the S Pen or hover the S Pen over the screen and press the S Pen button.

When you tap **Save** or reinsert the S Pen into the slot after writing a memo, the memo will be saved to **Samsung Notes**.

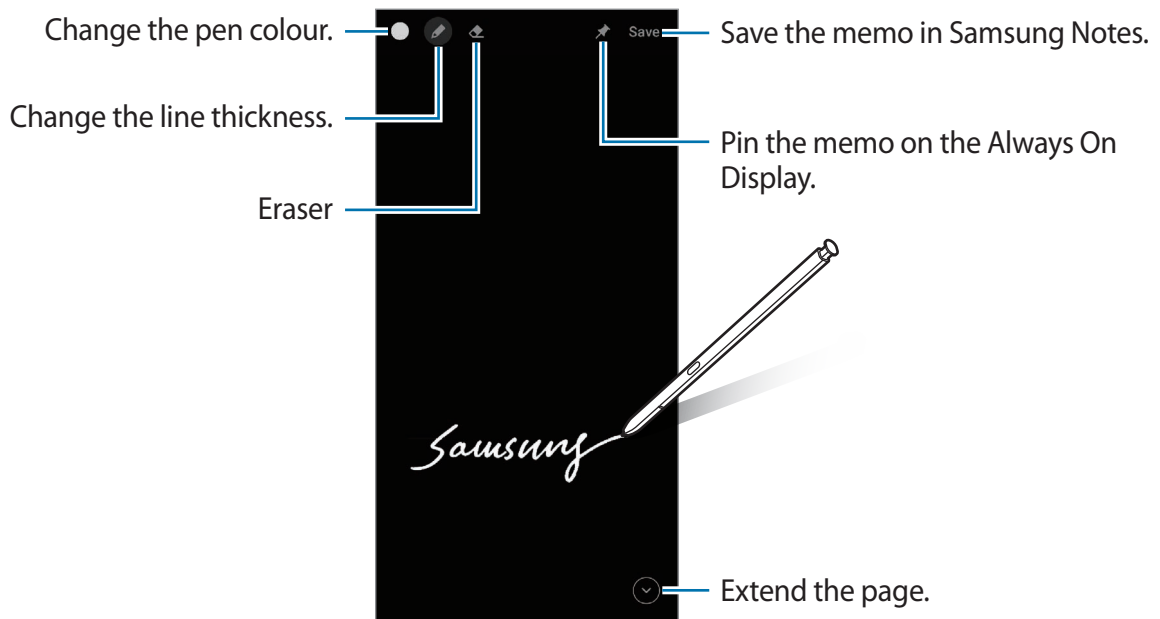



If this feature is not activated, launch the **Settings** app, tap **Advanced features** → **S Pen**, and then tap the **Screen off memo** switch to activate it.

## Pinning a memo on the Always On Display

To pin a screen off memo on the Always On Display, tap  → **Pin to Always On Display**. The pinned memo will not be saved yet.

To edit the pinned memo, double-tap the memo. If you pin the edited memo on the Always On Display again, the original memo will be saved to **Samsung Notes**.

To minimise the pinned memo, double-tap . The memo will be displayed as the  icon on the Always On Display. To view the memo again, double-tap .

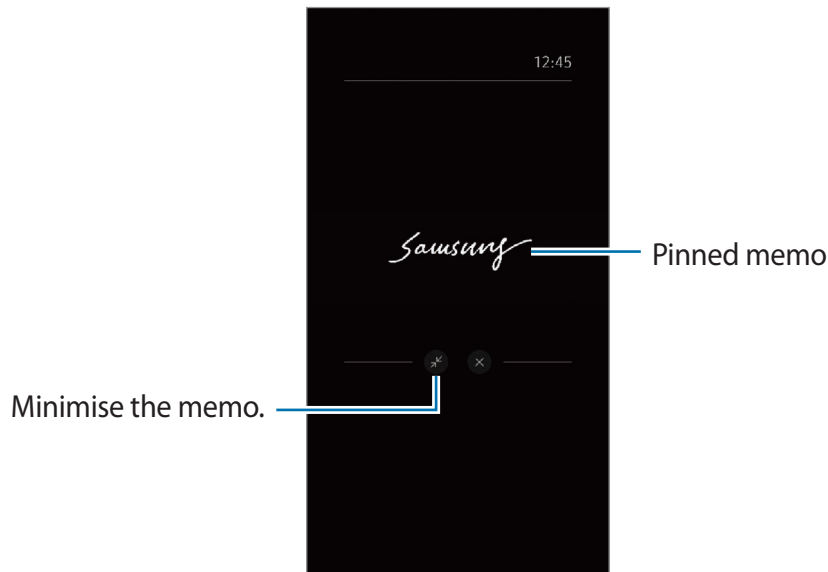

 If you do not perform any actions for a certain period after opening a memo, the memo will be automatically minimised.

## Unlocking the screen using the S Pen

If the screen is locked while the S Pen is connected, you can unlock the screen by pressing the S Pen button.

1 Launch the **Settings** app and tap **Advanced features** → **S Pen** → **S Pen unlock**.

2 Tap **Use S Pen unlock** → **OK**.

Now you can unlock the screen by pressing the S Pen button.



-  • The **Use S Pen unlock** feature is available only when the screen lock method is set.
- To use this feature, the S Pen must be connected to your device.

# Phone

## Introduction

Make or answer voice and video calls.

## Making calls

- 1 Launch the **Phone** app and tap **Keypad**.
- 2 Enter a phone number.
- 3 Tap  to make a voice call, or tap  or  to make a video call.

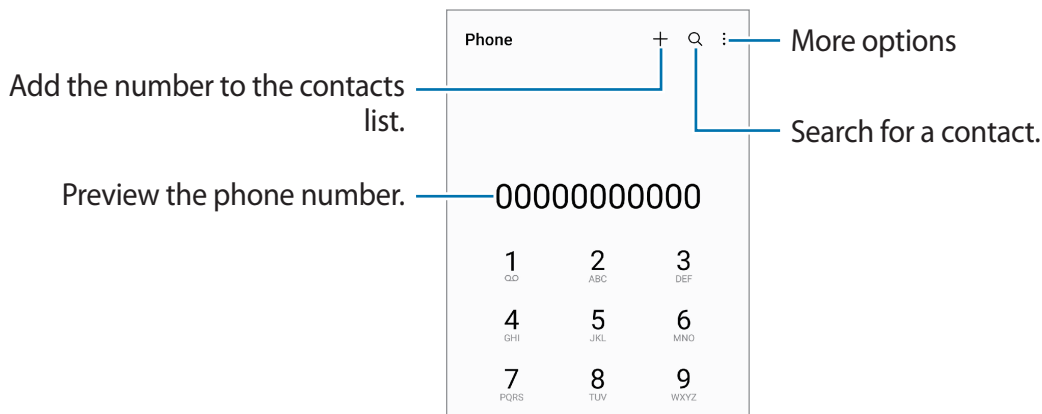

## Making calls from call logs or contacts list

Launch the **Phone** app, tap **Recents** or **Contacts**, and then swipe to the right on a contact or a phone number to make a call.

If this feature is deactivated, tap  → **Settings** → **Other call settings**, and then tap the **Swipe to call or text** switch to activate it.

## Using speed dial

To set a number to speed dial, launch the **Phone** app, tap **Keypad** or **Contacts** →  → **Speed dial numbers**, select a speed dial number, and then add a phone number.

To make a call, tap and hold a speed dial number on the keypad. For speed dial numbers 10 and up, tap the first digit(s) of the number, and then tap and hold the last digit.

For example, if you set the number **123** as a speed dial number, tap **1**, tap **2**, and then tap and hold **3**.

## Making an international call

- 1 Launch the **Phone** app and tap **Keypad**.
- 2 Tap and hold **0** until the + sign appears.
- 3 Enter the country code, area code, and phone number, and then tap .

## Receiving calls

### Answering a call

When a call comes in, drag  outside the large circle.

### Rejecting a call

When a call comes in, drag  outside the large circle.

To send a message when rejecting an incoming call, drag the **Send message** bar upwards and select a message to send.

To create various rejection messages, launch the **Phone** app, tap  → **Settings** → **Quick decline messages**, enter a message, and then tap **+**.

## Blocking phone numbers

Block calls from specific numbers added to your block list.

- 1 Launch the **Phone** app and tap  → **Settings** → **Block numbers**.
- 2 Tap **Recents** or **Contacts**, select contacts or phone numbers, and then tap **Done**.  
To manually enter a number, tap **Add phone number**, enter a phone number, and then tap **+**.

When blocked numbers try to contact you, you will not receive notifications. The calls will be logged in the call log.

-  You can also block incoming calls from people that do not show their caller ID. Tap the **Block unknown/private numbers** switch to activate the feature.

## Options during calls

- **Add call:** Dial a second call. The first call will be put on hold. When you end the second call, the first call will be resumed.
- **Hold call:** Hold a call.
- **Bluetooth:** Switch to a Bluetooth headset if it is connected to the device.
- **Speaker:** Activate or deactivate the speakerphone. When using the speakerphone, keep the device away from your ears.
- **Mute:** Turn off the microphone so that the other party cannot hear you.
- **Keypad / Hide:** Open or close the keypad.
-  : End the current call.
- **Camera:** During a video call, turn off the camera so that the other party cannot see you.
- **Switch:** During a video call, switch between the front and rear cameras.



Some features may not be available depending on the service provider or model.

# Contacts

## Introduction

Create new contacts or manage contacts on the device.

## Adding contacts

### Creating a new contact

- 1 Launch the **Contacts** app and tap **+**.
- 2 Select a storage location.
- 3 Enter contact information and tap **Save**.

### Importing contacts

Add contacts by importing them from other storages to your device.

- 1 Launch the **Contacts** app and tap **☰** → **Manage contacts** → **Import or export contacts** → **Import**.
- 2 Follow the on-screen instructions to import contacts.

### Syncing contacts with your web accounts





Sync your device contacts with online contacts saved in your web accounts, such as your Samsung account.

- 1 Launch the **Settings** app, tap **Accounts and backup** → **Manage accounts** and select the account to sync with.
- 2 Tap **Sync account** and tap the **Contacts** switch to activate it.

## Searching for contacts

Launch the **Contacts** app. Tap **Q** at the top of the contacts list and enter search criteria.

Tap the contact. Then take one of the following actions:

-  : Make a voice call.
-  /  : Make a video call.
-  : Compose a message.
-  : Compose an email.

## Deleting contacts

1 Launch the **Contacts** app and tap  → **Delete contacts**.

2 Select contacts and tap **Delete**.

To delete contacts one by one, tap a contact from the contacts list and tap **More** → **Delete**.

## Sharing contacts

You can share contacts with others by using various sharing options.

1 Launch the **Contacts** app and tap  → **Share contacts**.

2 Select contacts and tap **Share**.

3 Select a sharing method.

## Creating groups

You can add groups, such as family or friends, and manage contacts by group.

1 Launch the **Contacts** app and tap  → **Groups** → **Create group**.

2 Follow the on-screen instructions to create a group.

## Merging duplicate contacts

If your contacts list includes duplicate contacts, merge them into one to streamline your contacts list.

1 Launch the **Contacts** app and tap  → **Manage contacts** → **Merge contacts**.

2 Tick contacts and tap **Merge**.





# Messages

## Introduction

Send and view messages by conversation.

You may incur additional charges for sending or receiving messages when you are roaming.

## Sending messages

- 1 Launch the **Messages** app and tap .
- 2 Add recipients and enter a message.  
To record and send a voice message, tap and hold , say your message, and then release your finger. The recording icon appears only while the message input field is empty.
- 3 Tap  to send the message.

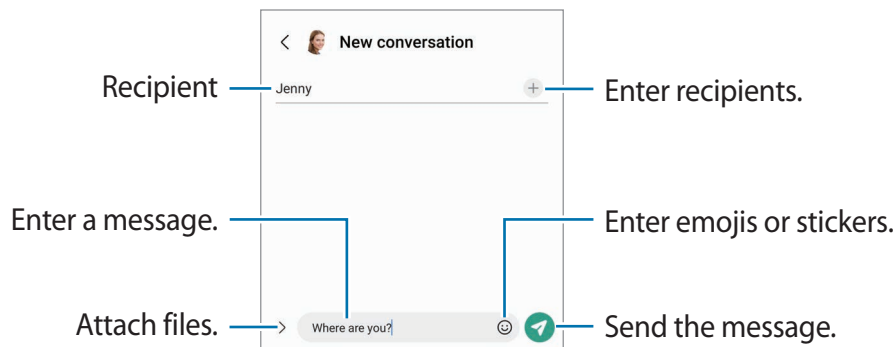

## Viewing messages

- 1 Launch the **Messages** app and tap **Conversations**.
- 2 On the messages list, select a contact or a phone number.
  - To reply to the message, tap the message input field, enter a message, and then tap .
  - To adjust the font size, spread two fingers apart or pinch on the screen.

## Sorting messages

You can sort messages by category and manage them easily.

Launch the **Messages** app and tap **Conversations** → .

If the category option does not appear, tap  → **Settings** and tap the **Conversation categories** switch to activate it.

## Deleting messages

Tap and hold a message to delete, then tap **Delete**.

## Changing message settings

Launch the **Messages** app, tap  → **Settings**. You can block unwanted messages, change notification settings, and more.

# Internet

Browse the Internet to search for information and bookmark your favourite webpages to access them conveniently.

- 1 Launch the **Internet** app.
- 2 Enter the web address or a keyword, and then tap **Go**.

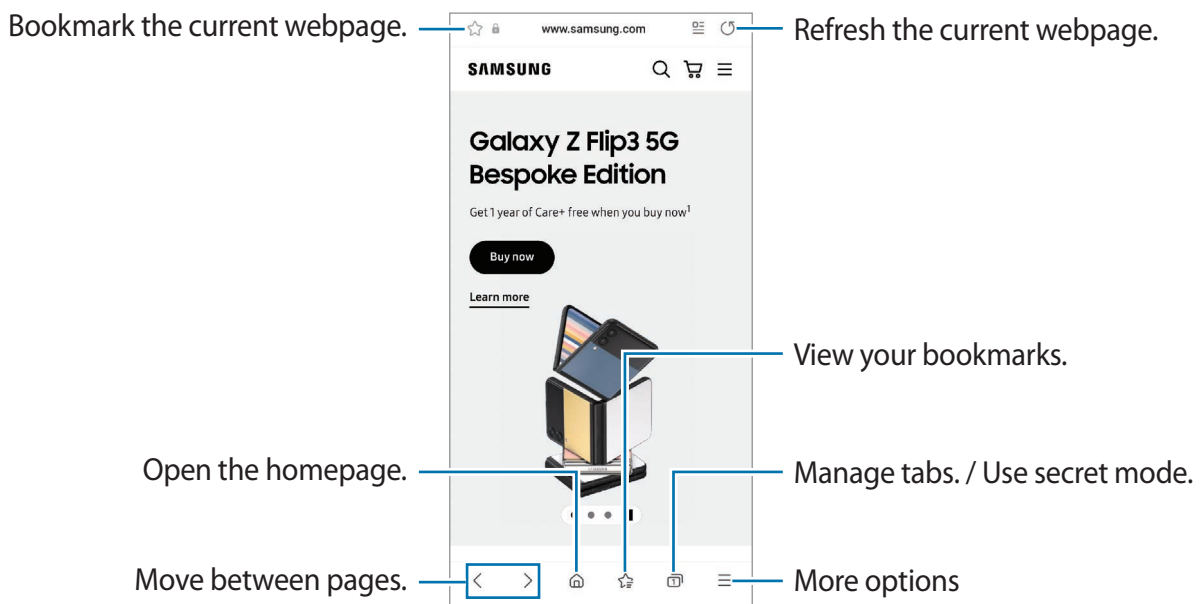

To view the toolbars, drag your finger downwards slightly on the screen.

To switch between tabs quickly, swipe to the left or right on the address field.



## Using secret mode

If you set a password for secret mode, you can prevent others from viewing your search history, browsing history, bookmarks, and saved pages.

- 1 Tap  → **Turn on Secret mode**.
- 2 Tap the **Lock Secret mode** switch to activate it, tap **Start**, and then set a password for secret mode.  
In secret mode, the device will change the colour of the toolbars. To deactivate secret mode, tap  → **Turn off Secret mode**.

 In secret mode, you cannot use some features, such as screen capture.

## Camera

### Introduction

Take pictures and record videos using various modes and settings.

#### Camera etiquette

- Do not take pictures or record videos of other people without their permission.
- Do not take pictures or record videos where legally prohibited.
- Do not take pictures or record videos in places where you may violate other people's privacy.

### Taking pictures

- 1 Launch the **Camera** app.

You can also launch the app by pressing the Side key twice quickly or dragging  to the left on the locked screen.

-  • Some camera features are not available when you launch the **Camera** app from the locked screen or when the screen is turned off while the screen lock method is set.
- The camera automatically shuts off when unused.
  - Some methods may not be available depending on the service provider or model.

- 2 Tap the image on the preview screen where the camera should focus.

To adjust the brightness of pictures, drag the adjustment bar that appears above or below the circular frame.

3 Tap  to take a picture.

To change the shooting mode, drag the shooting modes list to the left or right, or swipe to the left or right on the preview screen.

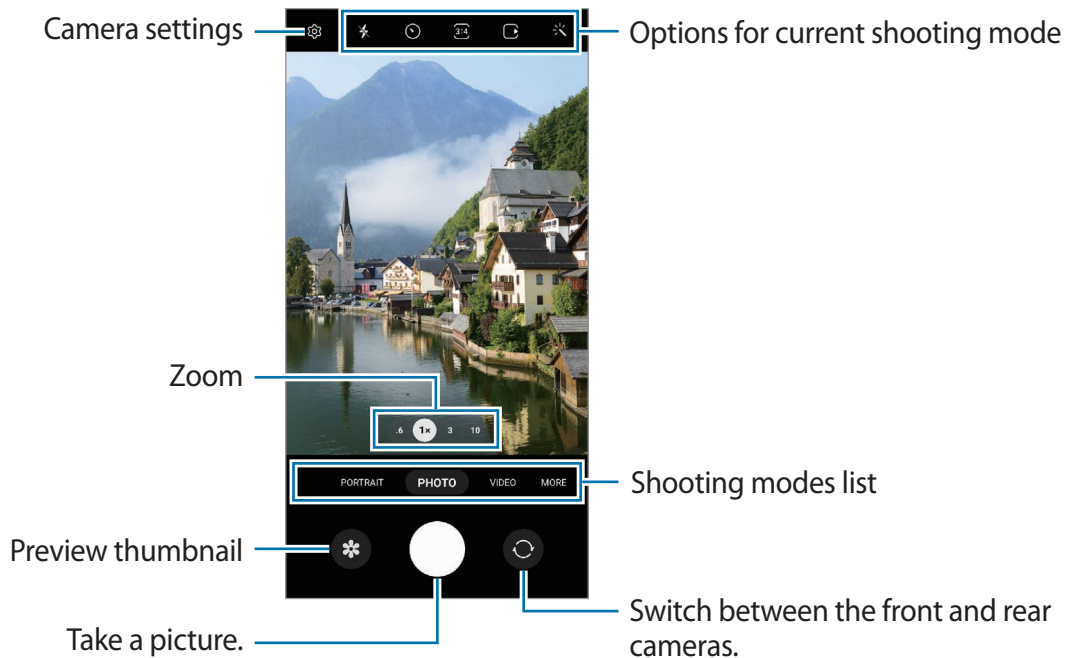

- The preview screen may vary depending on the shooting mode and which camera is being used.
- The focus may not be clear if the subject is close. Take pictures or videos from a good distance.
- If pictures you take appear blurry, clean the camera lens and try again.
- Make sure that the lens is not damaged or contaminated. Otherwise, the device may not work properly in some modes that require high resolutions.
- Your device's camera features a wide-angle lens. Minor distortion may occur in wide-angle pictures or videos and does not indicate device performance problems.
- The maximum capacity for recording a video may vary depending on the resolution.
- The camera may fog up or form condensation if the device is exposed to sudden changes in air temperature, due to the difference in temperature outside and inside the camera cover. Try to avoid such conditions when planning to use the camera. If fogging does occur, allow the camera to dry naturally at room temperature before taking pictures or recording videos, otherwise results may look blurry.

## Using zoom features

Select **.6/1/3/10** or drag it to the left or right to zoom in or out. Alternatively, spread two fingers apart on the screen to zoom in, and pinch to zoom out. If the zoom ratio exceeds a certain level, a zoom guide map will appear to indicate where you are zooming in on the image.

- **.6**: The Ultra wide camera lets you take wide-angle pictures or record wide-angle videos of things like landscapes.
- **1**: The wide-angle camera lets you take basic pictures or record normal videos.
- **3**: The telephoto camera (3x) lets you take pictures or record videos by enlarging the subject.
- **10**: The telephoto camera (10x) lets you take pictures or record videos by enlarging the subject. (Galaxy S22 Ultra)

 Zoom features are available only when using the rear camera.

## Locking the focus (AF) and exposure (AE)

You can lock the focus or exposure on a selected area to prevent the camera from automatically adjusting based on changes to the subjects or light sources.

Tap and hold the area to focus, the AF/AE frame will appear on the area and the focus and exposure setting will be locked. The setting remains locked even after you take a picture.























 This feature may not be available depending on the shooting mode.

## Using the camera button

- Tap and hold the camera button to record a video.
- To take burst shots, swipe the camera button to the edge of the screen and hold it.
- If you add another camera button, you can move it anywhere on the screen and take pictures more conveniently. On the preview screen, tap  → **Shooting methods** and tap the **Floating Shutter button** switch to activate it.

## Options for current shooting mode

On the preview screen, use the following options.

- : Activate or deactivate the flash.
- : Select the length of the delay before the camera automatically takes a picture.
- : Select an aspect ratio and resolution for pictures.
- : Activate or deactivate the motion photo feature. If you activate the feature, a video clip will also be taken from a few seconds before tapping the camera button.
- : Activate or deactivate the super steady feature.
- : Select a resolution for hyperlapse videos.
- : Select a frame rate.
- : Select an aspect ratio for videos.
- : Select a resolution for videos.
- : Apply a filter effect or beauty effects.
- : Select a metering method. This determines how light values are calculated.  **Centre-weighted metering** uses the light in the centre portion of the shot to calculate the exposure of the shot.  **Spot metering** uses the light in a concentrated centre area of the shot to calculate the exposure of the shot.  **Matrix metering** averages the entire scene.
- : Adjust the colour tone.
- : Display or hide a graph to check the light distribution in the video.
- : In **FOOD** mode, focus on a subject inside the circular frame and blur the image outside the frame.
- : In **FOOD** mode, adjust the colour tone.
- : Activate or deactivate the motion detection feature when recording super slow-mo videos.
- : In **DIRECTOR'S VIEW** mode, change the saving option.
- : In **DIRECTOR'S VIEW** mode, change the screen.
- : Customise the shooting options when taking single take shots.

 The available options may vary depending on the model or shooting mode.



## Photo mode

The camera adjusts the shooting options automatically depending on the surroundings to capture pictures easily.

On the shooting modes list, tap **PHOTO** and tap  to take a picture.

## Taking high-resolution pictures

Take high-resolution pictures.

In the shooting options, tap  →  or  and take a picture.

When you activate the **Detail enhancer** feature by tapping , you can take clearer pictures.

 The resolution may vary depending on the model.

## Shot suggestions

The camera suggests the ideal composition for the picture by recognising the position and angle of your subject.

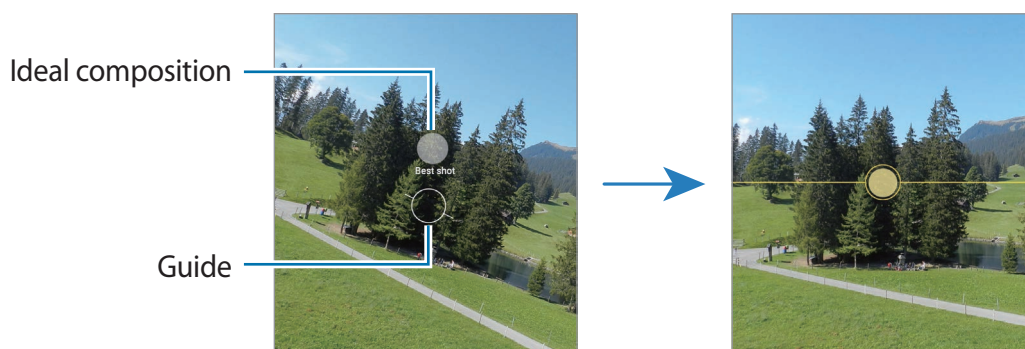

On the preview screen, tap  and tap the **Shot suggestions** switch to activate it.

- 1 On the shooting modes list, tap **PHOTO**.  
A guide will appear on the preview screen.
- 2 Point the guide at the subject.  
The camera recognises the composition, and the recommended composition appears on the preview screen.
- 3 Move the device so the guide matches the recommended composition.  
When the ideal composition is achieved, the guide will change to yellow.
- 4 Tap  to take a picture.







## Taking selfies

You can take self-portraits with the front camera.

- 1 On the preview screen, swipe upwards or downwards, or tap  to switch to the front camera for self-portraits.
- 2 Face the front camera lens.  
To take self-portraits with a wide-angle shot of the landscape or people, tap .
- 3 Tap  to take a picture.

## Taking clear close-up pictures (Galaxy S22 Ultra)

Take clear close-up pictures of your subject.

- 1 On the preview screen, tap 1.
  - 2 Put the camera near to the subject.
  - 3 When  appears, tap  to take a picture.
-  If this feature is not activated, tap  to activate it.

## Applying filter and beauty effects





You can select a filter effect and modify facial features, such as your skin tone or face shape, before taking a picture.

- 1 On the preview screen, tap .
- 2 Select effects and take a picture.  
If you use the My filters feature, you can create your own filter using an image with a colour tone you like from **Gallery**.



## Video mode

The camera adjusts the shooting options automatically depending on the surroundings to record videos easily.

- 1 On the shooting modes list, tap **VIDEO** and tap  to record a video.
  - To switch between the front and rear cameras while recording, swipe upwards or downwards on the preview screen or tap .
  - To capture an image from the video while recording, tap .
  - To record the sound from a specific direction at a higher volume while recording a video, point the camera towards that direction and adjust the zoom.
- 2 Tap  to stop recording the video.
  -  • If you use the video zoom feature for a long time while recording a video, the video quality may diminish to prevent your device from overheating.
  - The optical zoom may not work in low-light environments.

## Recording high-resolution videos

Record high-resolution videos with a maximum resolution of 8K.

Tap  →  and record a video.

When you finish recording a video, play the video in the **Gallery** app. When you tap  on a frame that you like, the frame will be saved as a high-resolution picture.

## Stabilising videos (Super steady)

If there is a lot of shaking when recording videos, use the Super steady feature for further video stabilisation.

Tap **VIDEO** on the shooting modes list, tap  on the shooting options to activate it, and then record a video.

## Using the auto framing feature





You can set the device to change the shooting angle and zoom automatically by recognising and tracking people while recording videos.

On the shooting modes list, tap **VIDEO**, tap  to activate it, and then record a video.

To track and adjust the shooting angle and zoom in on a selected person, tap the frame that is displayed around the person. To deactivate tracking, tap the frame again.

## Director's view mode

Record videos with various angles of view by changing cameras. In this mode, both the subject and the person who is filming can be recorded at the same time.

- 1 On the shooting modes list, tap **MORE** → **DIRECTOR'S VIEW**.
- 2 Select the screen and the camera thumbnail you want and tap  to record a video.
  - To change the screen before starting the recording, tap  and select the screen you want.
  - You can change the camera thumbnail while recording. If the thumbnail is hidden, tap  to display it.
- 3 Tap  to stop recording the video.

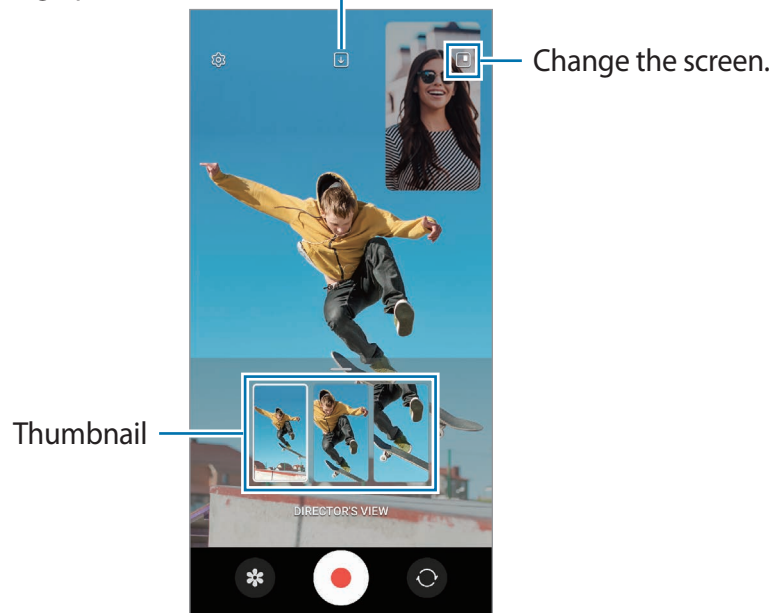

Change the saving option.



## Single take mode

Take various pictures and videos in just one shot.

Your device automatically selects the best shot and creates pictures with filters or videos with certain sections repeated.

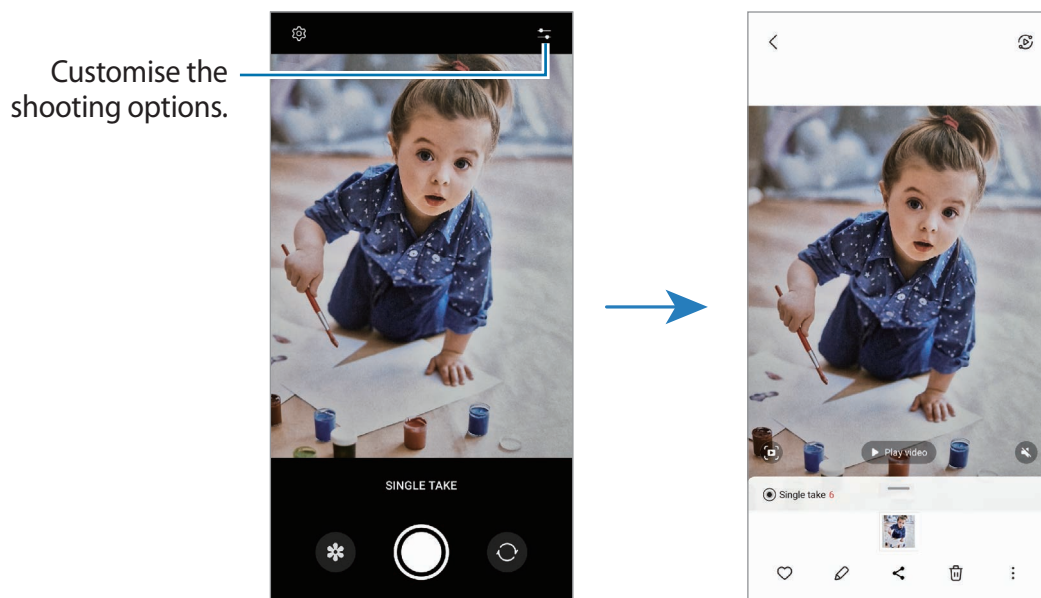

- 1 On the shooting modes list, tap **MORE** → **SINGLE TAKE**.
- 2 Tap  to capture the scene you want.
- 3 When you are finished, tap the preview thumbnail.  
To view other results, drag the — icon upwards. To save the results individually, tap **Select**, tick the items you want, and then tap .



## Portrait mode / Portrait video mode

The camera allows you to capture pictures or videos where the background is blurred and the subject stands out clearly. You can also apply a background effect and edit it after taking a picture.

- 1 On the shooting modes list, tap **PORTRAIT** or tap **MORE** → **PORTRAIT VIDEO**.
- 2 Tap  and select a background effect you want.  
To adjust the intensity of the background effect, drag the adjustment bar.



- 3 When **Ready** appears on the preview screen, tap  to take a picture or tap  to record a video.



-  • The available options may vary depending on the shooting mode.
- Use this feature in a place that has sufficient light.
- The background blur may not be applied properly in the following conditions:
  - The device or the subject is moving.
  - The subject is thin or transparent.
  - The subject has a similar colour to the background.
  - The subject or background is plain.

## Pro mode / Pro video mode

Capture pictures or videos while manually adjusting various shooting options, such as exposure value and ISO value.

On the shooting modes list, tap **MORE** → **PRO** or **PRO VIDEO**. Select options and customise the settings, and then tap  to take a picture or tap  to record a video.

### Available options

-  : Reset the settings.
- **ISO**: Select an ISO value. This controls camera light sensitivity. Low values are for stationary or brightly lit objects. Higher values are for fast-moving or poorly lit objects. However, higher ISO settings can result in noise in pictures or videos.
- **SPEED**: Adjust the shutter speed. A slow shutter speed allows more light in, so the picture or video becomes brighter. This is ideal for pictures or videos of scenery or pictures or videos taken at night. A fast shutter speed allows less light in. This is ideal for capturing pictures or videos of fast-moving subjects.
- **EV**: Change the exposure value. This determines how much light the camera's sensor receives. For low-light situations, use a higher exposure.
- **FOCUS**: Change the focus mode. Drag the adjustment bar to manually adjust the focus.
- **WB**: Select an appropriate white balance, so images have a true-to-life colour range. You can set the colour temperature.
- **MIC**: Select which direction's sound you want to record at a higher level. You can also use a USB or Bluetooth microphone by connecting it to your device (Pro video mode).
- **ZOOM**: Adjust the zoom speed (Pro video mode).

### Recording high-resolution pro videos

Record high-resolution pro videos with a maximum resolution of 8K.

Tap  →  and record a pro video.

When you finish recording a pro video, play it in the **Gallery** app. When you tap  on a frame that you like, the frame will be saved as a high-resolution picture.

## Separating the focus area and the exposure area

You can separate the focus area and the exposure area.

Tap and hold the preview screen. The AF/AE frame will appear on the screen. Drag the frame to the area where you want to separate the focus area and the exposure area.





## Night mode

Take a picture in low-light conditions, without using the flash. When you use a tripod, you can get brighter and steadier results.

- 1 On the shooting modes list, tap **MORE** → **NIGHT**.  
If you set the time that appears at the right bottom of the screen to **Max**, you may get clearer pictures.
- 2 Tap  and hold your device steady until shooting is complete.



## Food mode

Take pictures of food with more vibrant colours.

- 1 On the shooting modes list, tap **MORE** → **FOOD**.
- 2 Tap the screen and drag the circular frame over the area to highlight.  
The area outside the circular frame will be blurred.  
To resize the circular frame, drag a corner of the frame.
- 3 Tap  and drag the adjustment bar to adjust the colour tone.
- 4 Tap  to take a picture.



## Panorama mode

Using panorama mode, take a series of pictures and then stitch them together to create a wide scene.

- 1 On the shooting modes list, tap **MORE** → **PANORAMA**.
  - 2 Tap  and move the device slowly in one direction.  
Keep the image within the frame on the camera's viewfinder. If the preview image is out of the guide frame or you do not move the device, the device will automatically stop taking pictures.
  - 3 Tap  to stop taking pictures.
-  Avoid taking pictures of indistinct backgrounds, such as an empty sky or a plain wall.

## Super Slow-mo mode

Super slow motion is a feature that records a quickly passing moment slowly so that you can appreciate it later.

- 1 On the shooting modes list, tap **MORE** → **SUPER SLOW-MO** and tap  to record a video.  
The device will capture the moment in super slow motion and save it as a video.
- 2 On the preview screen, tap the preview thumbnail.  
To edit the super slow motion section, tap  and drag the section editing bar to the left or right.

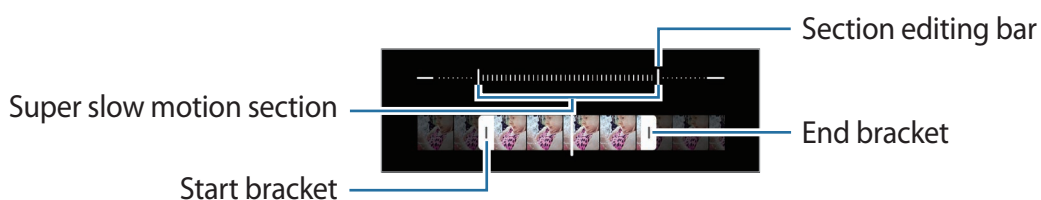

-  Use this feature in a place that has sufficient light. When recording a video indoors with insufficient or poor lighting, the screen may appear dark or be grainy. The screen may flicker in certain lighting conditions, such as in places with fluorescent lighting.

## Recording super slow motion videos automatically

To capture the moment in super slow motion when motion is detected in the motion detection area, tap  to activate it. The motion detection feature will be activated and the motion detection area will appear on the preview screen.



Tap  to start recording. When motion is detected, the device will begin recording in super slow motion and save it as a video.

 Super slow motion recording may start at an unwanted moment if there are conditions such as the following:

- When the device shakes or when another object is moving near the subject in the motion detection area.
- When recording under flickering light, such as in places with fluorescent lighting.

## Slow motion mode

Record a video for viewing it in slow motion. You can specify sections of your videos to be played in slow motion.

- 1 On the shooting modes list, tap **MORE** → **SLOW MOTION** and tap  to record a video.
- 2 When you are finished recording, tap  to stop.
- 3 On the preview screen, tap the preview thumbnail.

The fast section of the video will be set as a slow motion section and the video will start playing. Up to two slow motion sections will be created based on the video.



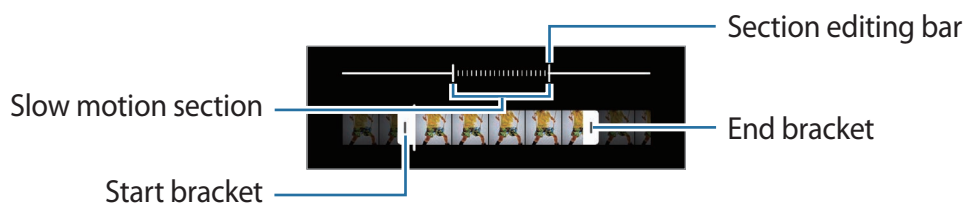

To edit the slow motion section, tap  and drag the section editing bar to the left or right.





## Hyperlapse mode

Record scenes, such as passing people or cars, and view them as fast-motion videos.

- 1 On the shooting modes list, tap **MORE** → **HYPERLAPSE**.
- 2 Tap  and select a frame rate option.  
If you set the frame rate to , the device will automatically adjust the frame rate according to the changing rate of the scene.
- 3 Tap  to start recording.
- 4 Tap  to finish recording.

## Customising camera settings

On the preview screen, tap . Some options may not be available depending on the shooting mode.

### Intelligent features

- **Scene optimiser:** Set the device to adjust the colour settings and apply the optimised effect automatically depending on the subject or scene.
- **Shot suggestions:** Set the device to suggest the ideal composition for the picture by recognising the position and angle of your subject.
- **Scan QR codes:** Set the device to scan QR codes from the preview screen.

### Pictures

- **Swipe Shutter button to:** Select an action to perform when you swipe the camera button to the edge of the screen and hold it.
- **Picture formats:** Select how you want to save picture.
  - **High efficiency pictures:** Take pictures in the High Efficiency Image Format (HEIF).
  - **RAW copies:** Set the device to save pictures as uncompressed RAW files (DNG file format) in pro mode. RAW files retain all of a picture's data for the best image quality, but they will take up more memory. When using the **RAW copies** feature, each picture is saved in two formats, DNG and JPG.

### Selfies

- **Save selfies as previewed:** Set the device to save pictures as they appear on the preview screen when taken with the front camera without flipping them.
- **Selfie colour tone:** Set a tone to apply when you take selfies.

## Videos

- **Auto FPS:** Set the device to record brighter videos in low-light conditions by automatically optimising the frame rate.
  - **Video stabilisation:** Activate anti-shake to reduce or eliminate blurry image resulting from camera shake while recording a video.
  - **Advanced recording options:** Set the device to use an advanced recording option.
    - **Reduce file size:** You can record videos in the High Efficiency Video Codec (HEVC) format. Your HEVC videos will be saved as compressed files to conserve the device's memory.
    - **HDR10+ videos:** You can record videos in which each scene's contrast and colour are optimised.
    - **Zoom-in mic:** While recording a video, you can record sound from the zoomed-in direction at a higher volume.
-  • You may not be able to play the HEVC videos on other devices or share them online.
- Super slow motion and slow motion videos cannot be recorded in the HEVC format.
  - To play the HDR10+ video properly, the device must support HDR10+.

## General

- **Auto HDR:** Take pictures with rich colours and reproduce details even in bright and dark areas.
  - **Tracking auto-focus:** Set the device to track and automatically focus on a selected subject. When you select a subject on the preview screen, the device will focus on the subject even if the subject is moving or you change the camera's position.
-  Tracking a subject may fail in the following conditions:
- The subject is too big or too small.
  - The subject moves excessively.
  - The subject is backlit or you are shooting in a dark place.
  - Colours or patterns on the subject and the background are the same.
  - The subject includes horizontal patterns, such as blinds.
  - The camera shakes excessively.
  - The video resolution is high.
  - When zooming in or out using the optical zoom.

- **Grid lines:** Display viewfinder guides to help composition when selecting subjects.
- **Location tags:** Attach a GPS location tag to the picture.
  -  • GPS signal strength may decrease in locations where the signal is obstructed, such as between buildings or in low-lying areas, or in poor weather conditions.
  - Your location may appear on your pictures when you upload them to the Internet. To avoid this, deactivate the location tag setting.
- **Shooting methods:** Select additional shooting methods for taking a picture or recording a video.
- **Settings to keep:** Keep the last settings you used, such as the shooting mode, when you launch the camera.
- **Vibration feedback:** Set the device to vibrate in certain situations, such as when you tap the camera button.

### Privacy

- **Privacy Notice:** View the privacy notice.
  - **Permissions:** View the permissions required to use the Camera app.
  - **Reset settings:** Reset the camera settings.
  - **About Camera:** View the Camera app version and legal information.
  - **Contact us:** Ask questions or view frequently asked questions.
-  Some features may not be available depending on the model.

# Gallery

## Introduction

View images and videos stored in your device. You can also manage images and videos by album or create stories.

## Using Gallery

Launch the **Gallery** app.

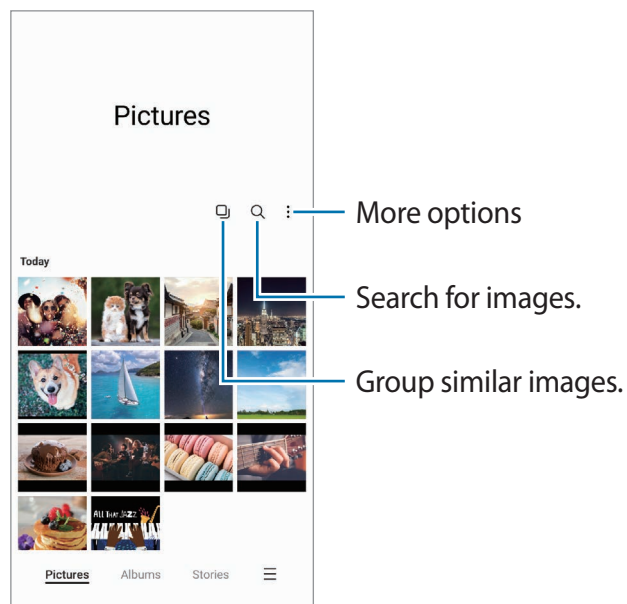

## Grouping similar images

Launch the **Gallery** app and tap  to group similar images and display only the best shots as a preview of the images. When you tap the image preview, you can view all the images in the group.

## Viewing images

Launch the **Gallery** app and select an image. To view other files, swipe to the left or right on the screen.

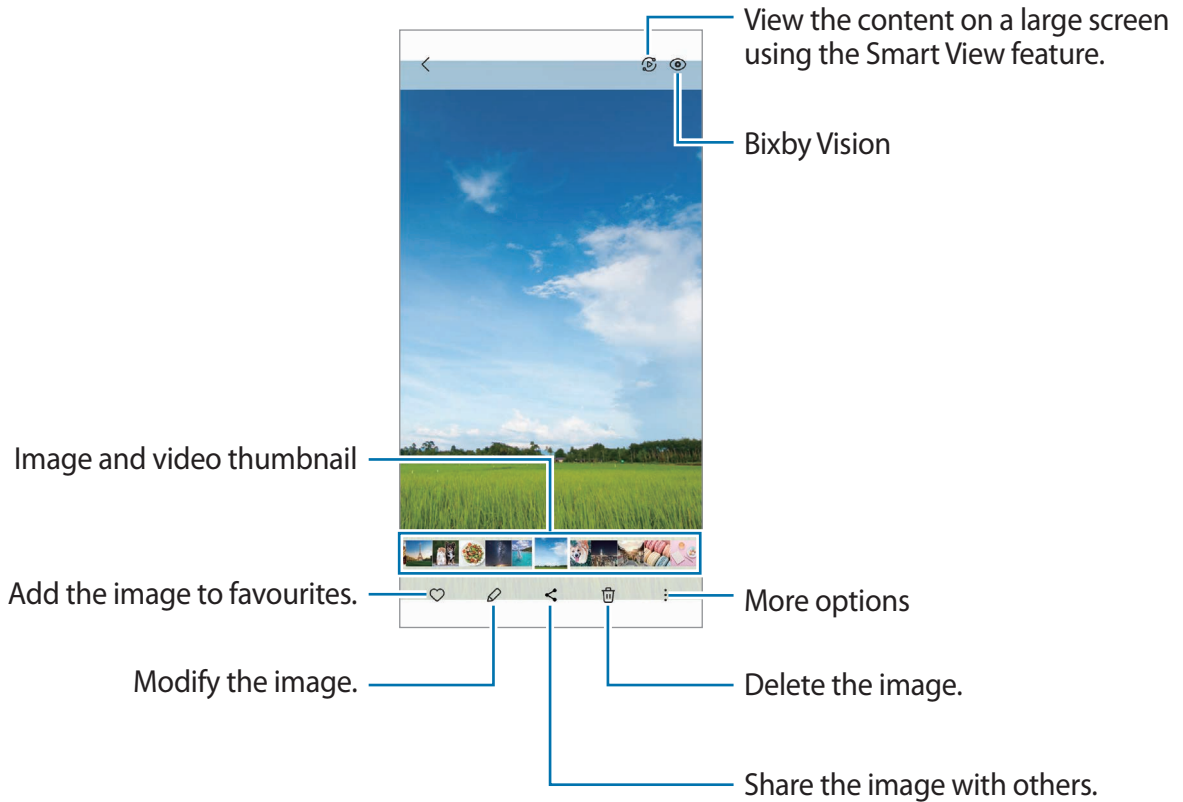

## Cropping enlarged images

- 1 Launch the **Gallery** app and select an image.
- 2 Spread two fingers apart on the area you want to save and tap . The cropped area will be saved as a file.

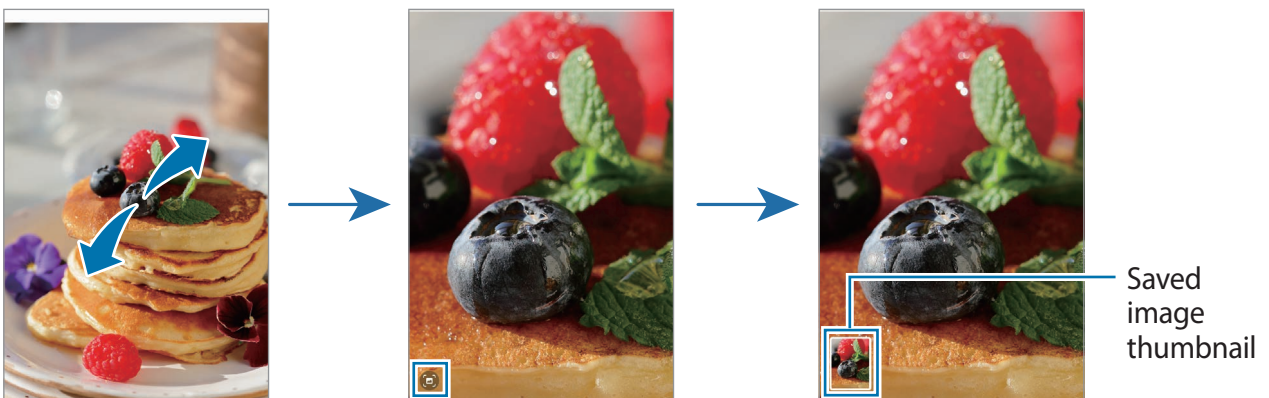

## Viewing videos

Launch the **Gallery** app and select a video to play. To view other files, swipe to the left or right on the screen.

To use more options during playback, tap  → **Open in Video player**.

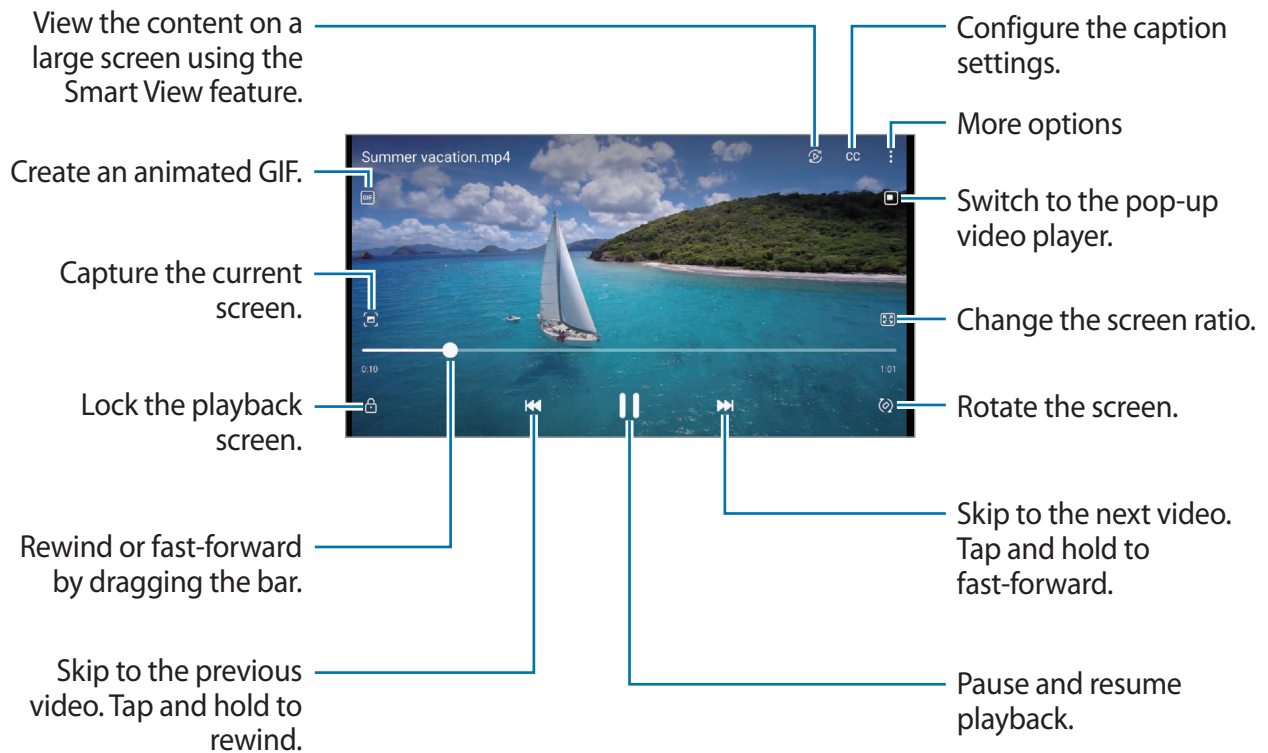

Drag your finger up or down on the left side of the playback screen to adjust the brightness, or drag your finger up or down on the right side of the playback screen to adjust the volume.

To rewind or fast-forward, swipe to the left or right on the playback screen.

## Viewing brighter and clearer videos

Enhance the image quality of your videos to enjoy brighter and more vivid colours. Launch the **Settings** app and tap **Advanced features** → **Video brightness** → **Bright**.



- This feature is only available in some apps.
- Using this feature will increase battery consumption.

## Albums

Create albums and sort your images and videos.

- 1 Launch the **Gallery** app and tap **Albums** →  → **Create album** to create an album.
- 2 Select the album, tap **Add items**, and then copy or move the images or videos you want.

## Stories

When you capture or save images and videos, the device will read their date and location tags, sort the images and videos, and then create stories.

Launch the **Gallery** app, tap **Stories**, and then select a story.

To add or delete images or videos, select a story and tap  → **Add** or **Edit**.

## Syncing images and videos

Launch the **Gallery** app, tap  → **Settings** → **Sync with OneDrive**, and then follow the on-screen instructions to complete the sync. The **Gallery** app and the cloud will be synced.

When your **Gallery** app is synced with the cloud, pictures and videos you take will also be saved in the cloud. You can view images and videos saved in the cloud in your **Gallery** app and from other devices.

-  When you connect your Samsung account and Microsoft account, you can set the cloud storage as Microsoft OneDrive.

## Deleting images or videos

Launch the **Gallery** app, tap and hold an image, a video, or a story to delete, and then tap **Delete**.

## Using the recycle bin feature

You can keep the deleted images and videos in the recycle bin. The files will be deleted after a certain period.

Launch the **Gallery** app, tap  → **Settings**, and then tap the **Recycle bin** switch to activate it.

To view files in the recycle bin, launch the **Gallery** app and tap  → **Recycle bin**.

## AR Zone

### Introduction

AR Zone provides you AR related features. Choose a feature and capture fun pictures or videos.

### Launching AR Zone

Use the following methods to launch AR Zone:

- Launch the **AR Zone** app.
- Launch the **Camera** app and tap **MORE** → **AR ZONE**.

 Some features may not be available depending on the service provider or model.

### AR Emoji Studio

Create emojis any way you want and have fun using them in various features.

### Creating an AR Emoji

- 1 Launch the **AR Zone** app and tap **AR Emoji Studio**.
  - 2 You can pick a pre-made emoji to get started quickly. Swipe to the left or right, select an emoji, and then tap .
- If you want to make your own emoji, take a selfie or select an image.



3 Follow the on-screen instructions to create an emoji.

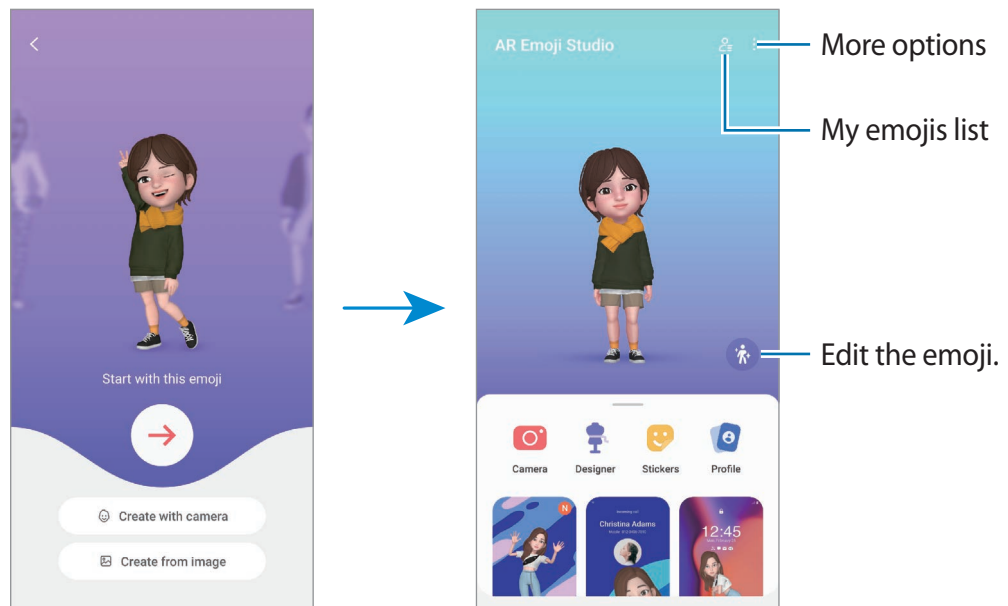

### Selecting an AR emoji to use

Launch the **AR Zone** app, tap **AR Emoji Studio** → , and then select an emoji you want.

### Deleting AR emojis

Launch the **AR Zone** app, tap **AR Emoji Studio** →  → , tick emojis to delete, and then tap **Delete**.

### Creating an AR emoji short video and decorating your device with it

You can create a short video with an emoji and use it as a wallpaper or call background image.

- 1 Launch the **AR Zone** app and tap **AR Emoji Studio**.
- 2 Select **Create video**, **Call screen**, or **Lock screen**.
- 3 Select a template you want.  
To change the background image, tap .
- 4 Tap **Save** to save the video.  
You can view the saved videos in **Gallery**.
- 5 To use the video directly, select an option at the bottom of the screen.

## Creating your contact profile with an AR emoji

Use an emoji as your profile picture for your Samsung account and in the **Contacts** app. You can choose from various poses or create your own expressions.

- 1 Launch the **AR Zone** app and tap **AR Emoji Studio**.
- 2 Tap **Profile** and select an emoji.
- 3 Tap  to capture your expression or select a pose you want.
- 4 Tap **Done** → **Save**.

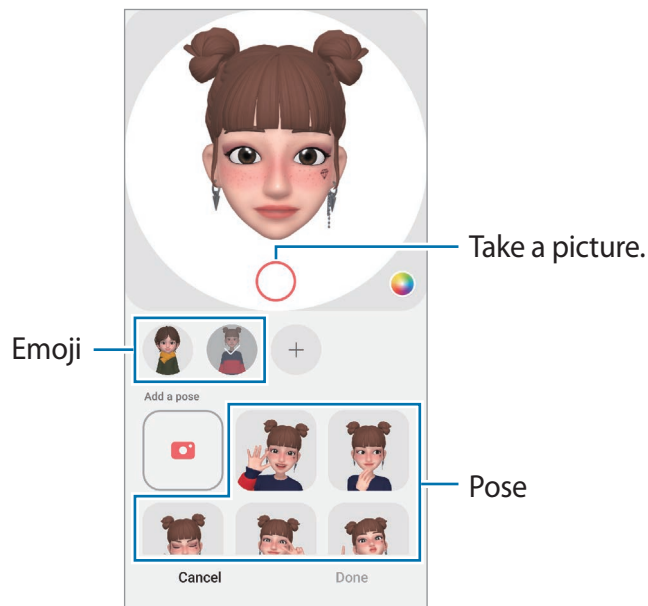

## AR Emoji Camera

Create fun pictures or videos with emojis using various shooting modes.

- 1 Launch the **AR Zone** app and tap **AR Emoji Camera**.
- 2 Select the emoji and the mode you want to use. The available modes may vary depending on the emoji you select.
  - **SCENE:** The emoji mimics your expressions. You can also change the background image.
  - **MASK:** The emoji's face appears over your face so it looks like you are wearing a mask.
  - **MIRROR:** The emoji mimics your body movements.
  - **PLAY:** The emoji moves on a real background.

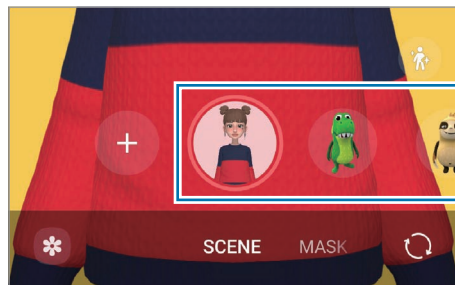

- 3 Tap the emoji icon to take a picture, or tap and hold the icon to record a video. You can view and share the pictures and videos that you have captured in **Gallery**.

## AR Emoji Stickers

Create your own stickers with your emoji's expressions and actions. You can use your emoji stickers when sending messages or on a social network.

### Creating your own stickers

- 1 Launch the **AR Zone** app and tap **AR Emoji Stickers**.
- 2 Tap **+** at the top of the stickers list.
- 3 Edit stickers how you want and tap **Save**. You can view the stickers you have created by tapping **Custom**.

## Deleting AR emoji stickers

Launch the **AR Zone** app and tap **AR Emoji Stickers** →  → **Delete stickers**. Select the emoji stickers to delete and tap **Delete**.

## Using your AR emoji stickers in chats

You can use your emoji stickers during a conversation via messages or on a social network. The following actions are an example of using your emoji stickers in the **Messages** app.

- 1 While composing a message in the **Messages** app, tap  on the Samsung keyboard.
- 2 Tap the emoji icon.
- 3 Select one of your emoji stickers.  
The emoji sticker will be inserted.

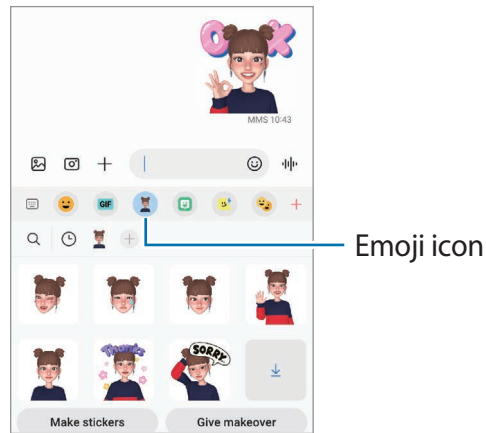

## AR Doodle

Record fun videos with virtual handwriting or drawings on people or pets' (cat and dogs) faces or anywhere else. When the camera recognises a face or space, the doodles on the face will follow the face as it moves, and the doodles in the space will be fixed in the same place even if the camera moves.

1 Launch the **AR Zone** app and tap **AR Doodle**.

When the camera recognises the subject, the recognition area will appear on the screen.

2 Tap  and write or draw in the recognition area.

- If you switch to the rear camera, you can also write or draw outside the recognition area.
- If you tap  and then begin to doodle, you can record yourself doodling.

Delete doodle.

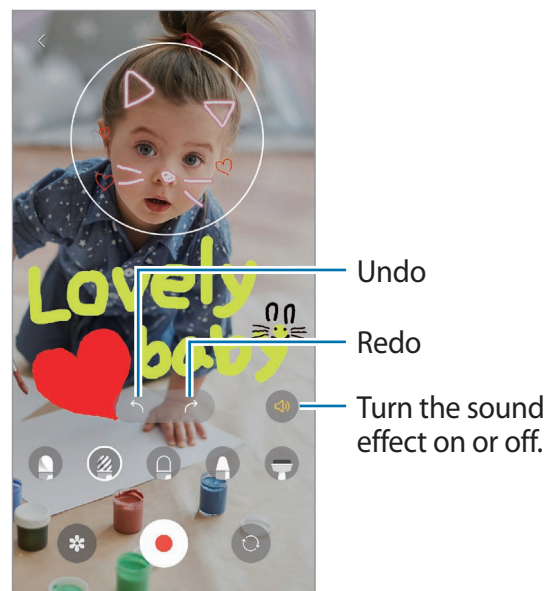
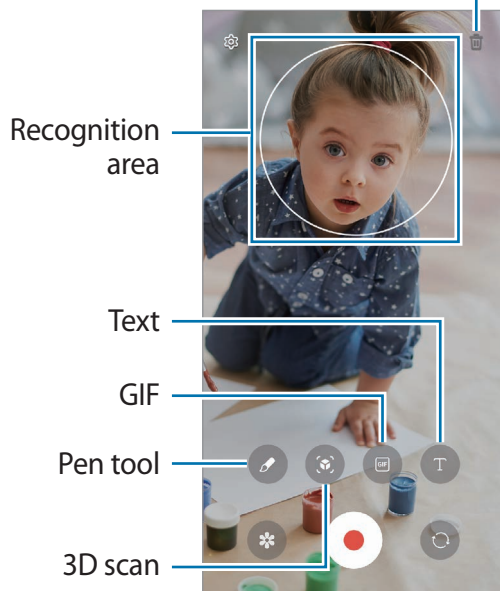

3 Tap  to record a video.

4 Tap  to stop recording the video.

You can view and share the video in **Gallery**.

 The available features on the preview screen may vary depending on which camera is being used.

## Deco Pic

Capture pictures or videos with various stickers.

Launch the **AR Zone** app and tap **Deco Pic**.

# Bixby

## Introduction

Bixby is a user interface that helps you use your device more conveniently.

You can talk to Bixby or type text. Bixby will launch a function you request or show the information you want. Visit [www.samsung.com/bixby](http://www.samsung.com/bixby) for more information.

 Bixby is only available in some languages, and it may not be available depending on the region.

## Starting Bixby

Press and hold the Side key to launch Bixby. The Bixby intro page will appear. After you select the language to use with Bixby, sign in to your Samsung account, and complete the setup by following the on-screen instructions, the Bixby screen will appear.



## Using Bixby

While pressing and holding the Side key, say what you want to Bixby, and then release your finger from the key. Alternatively, say “Hi, Bixby” and say what you want.

For example, while pressing and holding the Side key, say “How’s the weather today?” The weather information will appear on the screen.



If you want to know the weather tomorrow, while pressing and holding the Side key, just say “Tomorrow?”

If Bixby asks you a question during a conversation, while pressing and holding the Side key, answer Bixby. Or, tap  and answer Bixby.

If you are using headphones or Bluetooth audio devices, or start a conversation by saying “Hi, Bixby”, you can continue the conversation without tapping the icon. Launch the **Bixby** app and tap  →  → **Settings** → **Automatic listening** → **Hands-free only**.

## Waking up Bixby using your voice

You can start a conversation with Bixby by saying “Hi, Bixby”. Register your voice so that Bixby will respond to your voice when you say “Hi, Bixby”.

- 1 Launch the **Bixby** app and tap  →  → **Settings** → **Voice wake-up**.
- 2 Tap the **Wake with “Hi, Bixby”** switch to activate it.
- 3 Tap the **Recognise voice** switch to activate it.
- 4 Follow the on-screen instructions to complete the setup.  
Now you can say “Hi, Bixby” and start a conversation.

## Communicating by typing text

If your voice is not recognised due to noisy environments or if you are in a situation where speaking is difficult, you can communicate with Bixby via text.

Launch the **Bixby** app, tap , and then type what you want.

During the communication, Bixby also will answer you through text instead of voice feedback.

# Bixby Vision

## Introduction

Bixby Vision is a service that provides various features based on image recognition. You can use Bixby Vision to quickly search for information by recognising objects. Use a variety of useful Bixby Vision features.

-  • This feature may not be available or you may not get correct search results depending on the image size, format, or resolution.
- Samsung is not responsible for the product information provided by Bixby Vision.

## Launching Bixby Vision





Launch Bixby Vision using one of these methods.

- In the **Camera** app, tap **MORE** on the shooting modes list and tap **BIXBY VISION**.
- In the **Gallery** app, select an image and tap .
- In the **Internet** app, tap and hold an image and tap **Search with Bixby Vision**.
- If you added the Bixby Vision app icon to the Apps screen, launch the **Bixby Vision** app.

## Using Bixby Vision

1 Launch Bixby Vision.

2 Select a feature you want to use.

-  : Recognise text from documents or images and translate it.
-  : Recognise text from documents or images and extract it.
-  : Search for images similar to the recognised object online and related information.
-  : Search for information of products.

 The available features and search results may vary depending on the region or service provider.



# Bixby Routines

## Introduction

Add your repeated usage patterns as routines and use your device more conveniently.

For example, a 'before bed' routine will perform actions, such as turning on silent mode and dark mode, to not be jarring on your eyes and ears when you use the device before going to bed.

## Adding routines

- 1 Launch the **Settings** app and tap **Advanced features** → **Bixby Routines**.
- 2 On the **Discover** list, select a routine you want or tap **Add routine** to add your own routines.
  - You can set the conditions and actions of routines on the **Discover** list.
  - If you want to set the routine's running condition to manual, tap **Start manually**. This option will appear only when there are no running conditions set. When a pop-up window appears, tap **Add**. You can add the routine to the Home screen as a widget and access it quickly.

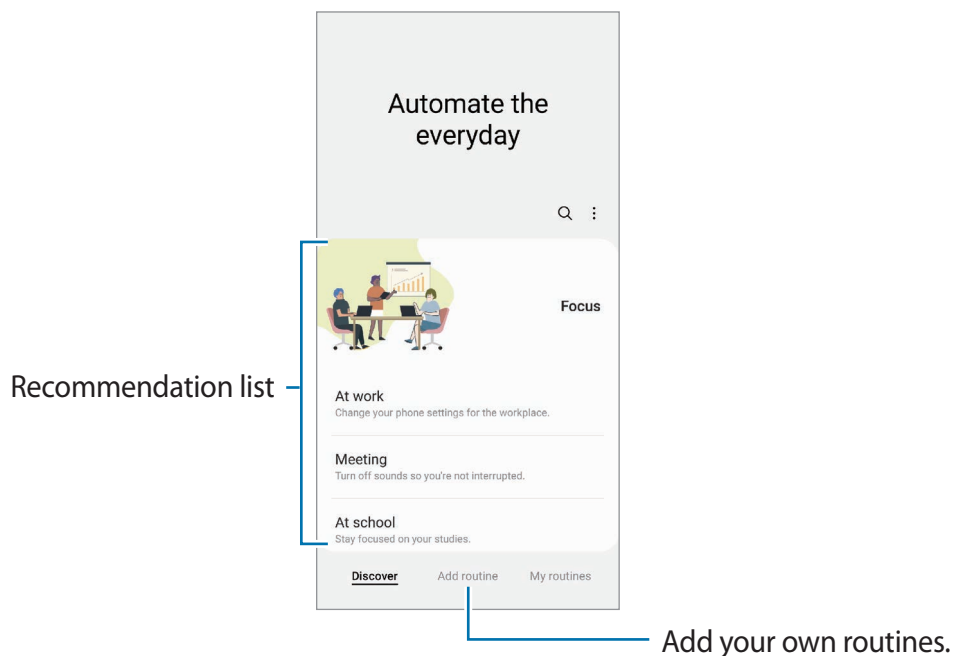

## Using routines

### Running auto routines

Auto routines will run automatically when their conditions are detected.

### Running manual routines

For routines which you set the running condition as **Start manually**, you can run them manually by tapping the button whenever you want.

Launch the **Settings** app and tap **Advanced features** → **Bixby Routines** → **My routines** and tap  next to the routine you want to run. Alternatively, tap the routine's widget on the Home screen.

### Viewing running routines

Currently running routines will appear on the notification panel. To view a routine's details, tap the notification.

You can also quickly stop running routines. On the notification panel, tap  next to a routine and tap **Stop**.

### Managing routines

Launch the **Settings** app and tap **Advanced features** → **Bixby Routines** → **My routines**. Your routines will appear.

To deactivate a routine, tap the routine → **More** → **Disable this routine**.

To delete routines, tap  → **Edit**, tick routines to delete, and then tap **Delete**.

# Multi window

## Introduction

Multi window lets you run two apps at the same time in the split screen view. You can also run multiple apps at the same time in the pop-up view.

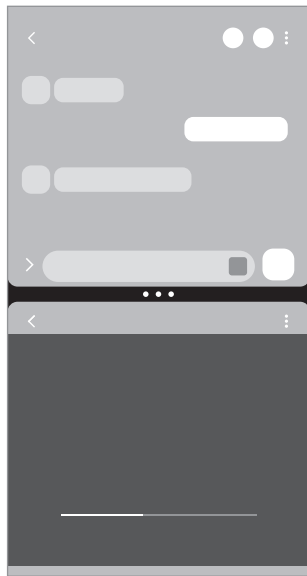

Split screen view

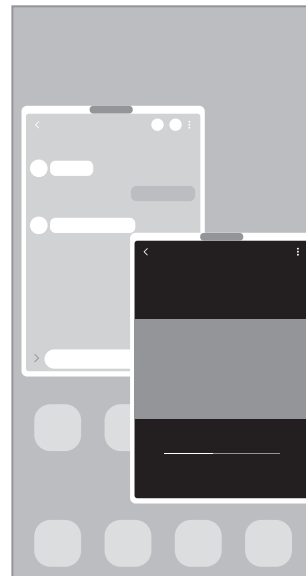

Pop-up view

 Some apps may not support this feature.



## Split screen view

- 1 Tap the Recents button to open the list of recently used apps.
- 2 Swipe to the left or right, tap an app's icon, and then tap **Open in split screen view**.
- 3 On the apps list, select another app to launch.

## Launching apps from the Edge panel

- 1 While using an app, drag the Edge panel handle towards the centre of the screen.
- 2 Tap and hold an app, drag it to the left, and then drop it where **Drop here to open** appears.

The selected app will launch in the split screen view.

-  You can set to launch an app in the split screen view by tapping it once. Tap  → **Edit** →  and tap **Tap** under **Open in split screen view**. If you tap the **Show recent apps** switch to activate it, you can launch the recently used apps in the split screen view from the Edge panel.

## Adding app pairs

Add frequently used apps to the Edge panel to launch them together in the split screen view with a single tap.

- 1 In the split screen view, tap the circles between the app windows.
  - 2 Tap .
- The apps you are using in the split screen view will be saved on the Edge panel as an app pair.

## Adjusting the window size

Drag the circles between the app windows to adjust the size of the windows.

When you drag the circles between the app windows to the edge of the screen, the window will be maximised.

## Pop-up view

- 1 Tap the Recents button to open the list of recently used apps.
- 2 Swipe to the left or right, tap an app's icon, and then tap **Open in pop-up view**.  
The app screen will appear in the pop-up view.  
If you tap the Home button while using a pop-up window, the window will be minimised and displayed as an app icon. To use the pop-up window again, tap the app icon.

## Launching apps from the Edge panel

- 1 Drag the Edge panel handle towards the centre of the screen.
- 2 Tap and hold an app, drag it to the left, and then drop it where **Drop here for pop-up view** appears.  
The selected app will launch in the pop-up view.

## Moving pop-up windows

To move a pop-up window, tap the window's toolbar and drag it to a new location.

# Samsung Pay

## Introduction

Register cards to Samsung Pay to make both online and offline payments quickly and securely.

You can view more information, such as cards that support this feature at [www.samsung.com/samsung-pay](http://www.samsung.com/samsung-pay).



- To make payments with Samsung Pay, the device may be required a connection to a Wi-Fi or mobile network depending on the region.
- This feature may not be available depending on the service provider or model.
- The procedures for the initial setup and card registration may vary depending on the service provider or model.

## Setting up Samsung Pay

When running this app for the first time or restart it after performing a data reset, follow the on-screen instructions to complete the initial setup.

- 1 Launch the **Samsung Pay** app.
- 2 Sign in to your Samsung account and read and agree to the terms and conditions.
- 3 Register your fingerprint and a PIN to use when making payments.  
This PIN will be used to verify various actions in Samsung Pay, such as making payments and unlocking the app.

## Registering cards

Launch the **Samsung Pay** app and follow the on-screen instructions to complete your card registration.

## Making payments

- 1 Tap and hold a card image at the bottom of the screen and drag it upwards. Alternatively, launch the **Samsung Pay** app. Then, on the cards list, swipe to the left or right and select a card to use.

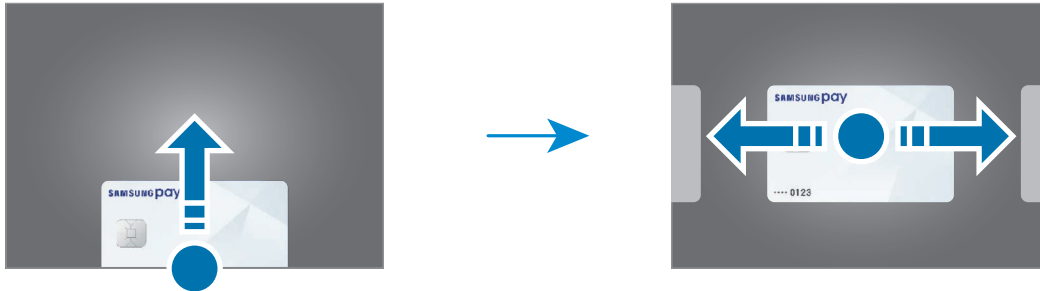

- 2 Scan your fingerprint or enter the payment PIN you set.
  - 3 Touch the back of your device to the card reader.  
When the card reader recognises the card information, the payment will be processed.
- Payments may not be processed depending on your network connection.
  - The verification method for payments may vary depending on the card readers.

## Cancelling payments

You can cancel payments by visiting the place where you made them.

On the cards list, swipe to the left or right to select the card you used. Follow the on-screen instructions to complete payment cancellation.

# Samsung Health

## Introduction

Samsung Health helps you manage your wellness and fitness. Set fitness goals, check your progress, and keep track of your overall wellness and fitness. You can also compare your step count records with other Samsung Health users and view health tips.

Visit [www.samsung.com/samsung-health](http://www.samsung.com/samsung-health) for more information.

## Using Samsung Health

Launch the **Samsung Health** app. When running this app for the first time or restarting it after performing a data reset, follow the on-screen instructions to complete the setup.

To edit items on the Samsung Health home screen, tap  → **Manage items**.

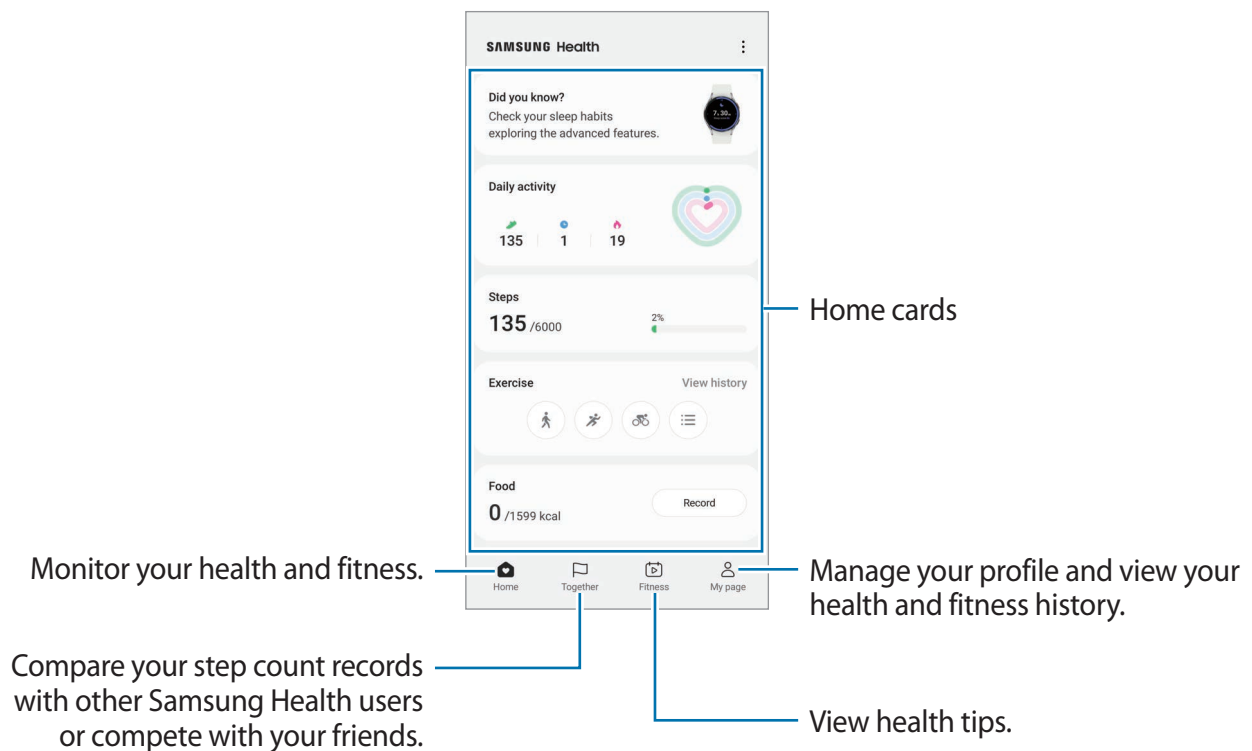

- Some features may not be available depending on the region.
- If you use the steps card while travelling by car or train, vibration may affect your step count.





# Samsung Notes

## Introduction

Create notes by entering text from the keyboard or by handwriting or drawing on the screen. You can also insert images or voice recordings into your notes.

 Some features may not be available depending on the model.

## Creating notes

- 1 Launch the **Samsung Notes** app, tap , and then create a note.  
You can change the input method by tapping  or .

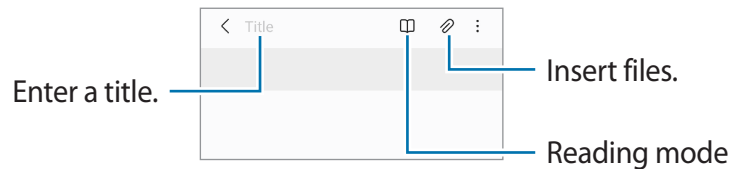

- 2 When you are finished composing the note, tap the Back button to save it.  
If you want to save the note in another file format, tap  → **Save as file**.

## Deleting notes



Tap and hold a note to delete and tap **Delete**.

## Composing notes with handwriting

On the note composer screen, tap  to draw or write in your own handwriting.

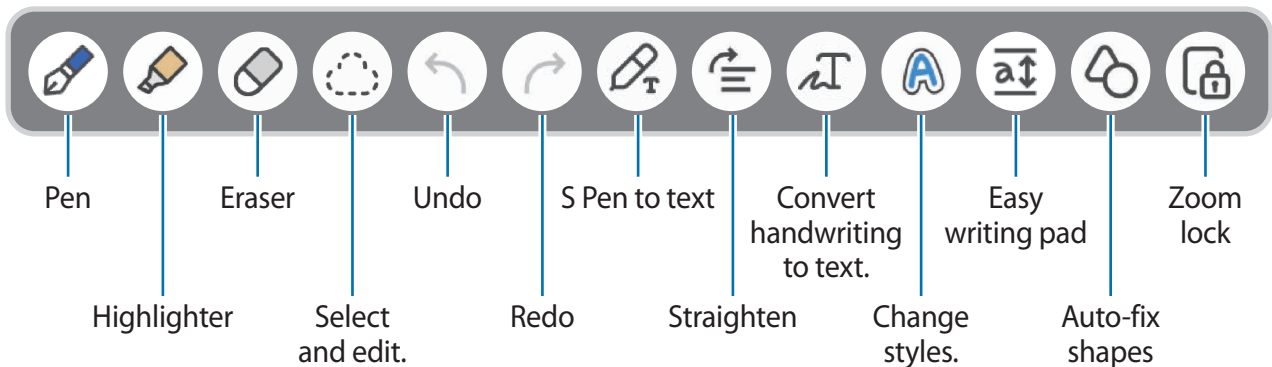
You can enter your handwriting more easily if you magnify the screen by spreading two fingers on it.



 If finger input does not work on a model that supports the S Pen, tap  → **Finger drawing on.**

### Using the eraser

When you want to erase handwriting from a note, tap  and select an area to erase. Alternatively, select an area while pressing and holding the S Pen button.



To change the eraser type, tap  once more.

- **Stroke eraser:** Erase the line you select.
- **Area eraser:** Erase only the area you select. You can adjust the size of the eraser by dragging the size adjustment bar.

 Even with a smaller eraser, you may still not be able to precisely erase the intended part.

### Editing handwritten notes

Edit handwritten notes using various editing options, such as cutting, moving, or resizing.

- 1 When there is handwriting on the note, tap .  
To change the shape of the selection, tap  once more.

2 Tap or draw a line around the input to select.

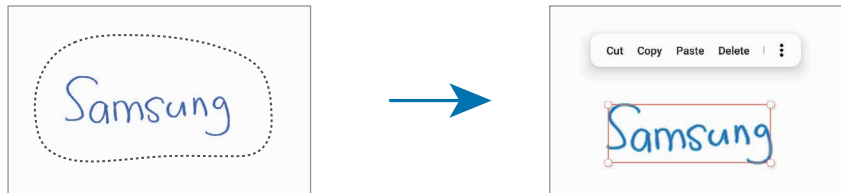

- To move the input to another location, select the input, and then drag it to a new location.
- To change the size of the selection, tap the input and drag a corner of the frame that appears.



3 Edit the input using the available options.

## Converting handwriting to text

Tap  and write on the screen with the S Pen. The handwriting will be replaced with text right away.

After writing on the screen, tap . Options will appear in the preview window. If you drag  or , you can select the handwriting you want. To replace the handwriting with the text, tap **Convert**.



## Straightening content horizontally

You can horizontally straighten your handwriting and drawings.

After writing or drawing on the screen, tap .

## Changing styles

You can change the style of your handwriting and drawings.

After writing or drawing on the screen, tap **A** twice and select a colour or line thickness you want. Then, point the S Pen toward where you want to apply the style. When the **→** icon appears, tap where you want to change the style.

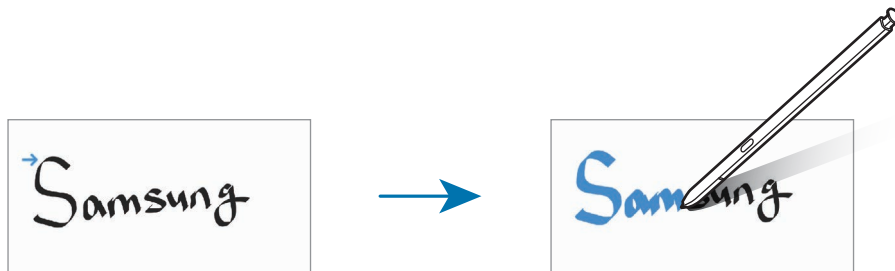

## Using the easy writing pad

Use the easy writing pad to enter your handwriting more easily.

On the note composer screen, tap **a↕**. The input field will be magnified and appear as the easy writing pad.

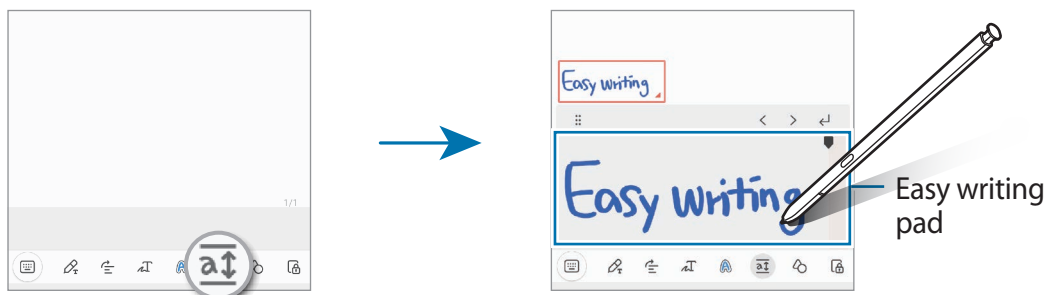

## Automatically fixing shapes

Tap **⏏** and draw a shape. The shape will be fixed.

## Recording voice to notes

Make a recording of your voice while creating a note, and then the content will be synchronised with the recording.

On the note composer screen, tap **🎙** → **Voice recording** and create a note.

Select a note from the list and tap **▶** to play the recording. Then the content you created while recording will be displayed on the screen along with the recording.

## Adding memos to PDF files

Launch the **Samsung Notes** app, tap , and then select a PDF file. You can add memos to the PDF file.

## Pinning a note to the Home screen

Pin a note to the Home screen to quickly view it or open and edit it.

- 1 Launch the **Samsung Notes** app.
- 2 Select a note and tap  → **Add to** → **Home screen**.  
The note will be added to the Home screen.

## Clipping content

You can quickly add content, such as a webpage link or an image, to a note.

- 1 When there is content you want to clip while using the **Internet**, **Messages**, or **Gallery** app, launch the **Samsung Notes** app in the split screen view or in the pop-up view. For more information about the split screen view or the pop-up view, refer to [Multi window](#).  
Alternatively, double-tap the screen while pressing and holding the S Pen button, or open the Air command panel and tap **Create note**.  
Options you can use will appear at the bottom of the note composer screen.
- 2 Select an option you want.

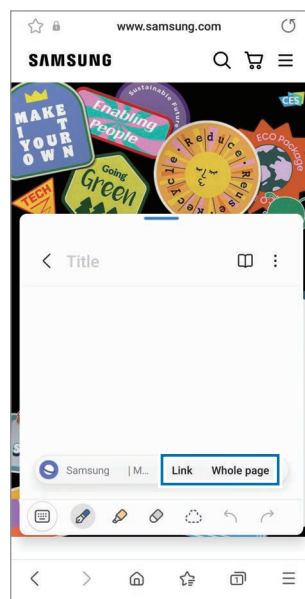



## Samsung Members

**Samsung Members** offers support services to customers, such as device problem diagnosis, and lets users submit questions and error reports. You can also share information with others in the Galaxy users' community or view the latest news and tips. **Samsung Members** can help you solve any problems you might encounter while using your device.

## Samsung Kids

You can restrict children's access to certain apps, set their usage times, and configure settings to provide a fun and safe environment for children when they use the device.

Open the notification panel, swipe downwards, and then tap  (**Kids**) to activate it. If you cannot find  (**Kids**) on the quick panel, tap  and drag the button over to add it. When starting Samsung Kids for the first time or after performing a data reset, follow the on-screen instructions to complete the setup.

On the Samsung Kids screen, select the app you want to use.

 Your preset screen lock method or your created PIN will be used when activating the **Parental controls** feature or closing Samsung Kids.

### Using parental control features

You can configure the settings for Samsung Kids and view the usage history.

On the Samsung Kids screen, tap  → **Parental controls** and enter your unlock code.

### Closing Samsung Kids

To close Samsung Kids, tap the Back button or tap  → **Close Samsung Kids**, and then enter your unlock code.

## Samsung Global Goals

The Global Goals, which were established by the United Nations General Assembly in 2015, consist of goals that aim to create a sustainable society. These goals have the power to end poverty, fight inequality, and stop climate change.

With Samsung Global Goals, learn more about the global goals and join the movement for a better future.

## Samsung TV Plus

Select the channels like you would use a TV and enjoy various video content free of charge.

Launch the **Samsung TV Plus** app.



This app may not be available depending on the service provider or model.

## Galaxy Shop

Access the Samsung website and view various information related to products.

Launch the **Galaxy Shop** app.

## Galaxy Wearable

Galaxy Wearable is an app that allows you to manage your wearable devices. When you connect your device to the wearable device, you can customise the wearable device's settings and apps.

Launch the **Galaxy Wearable** app.

Tap **Start** to connect your device to the wearable device. Follow the on-screen instructions to finish the setup. Refer to the wearable device's user manual for more information about how to connect and use the wearable device with your device.

## PENUP (Galaxy S22 Ultra)



PENUP is a social network service for sharing artwork drawn with the S Pen. Post your artwork, view others' artwork, and get useful drawing tips.

Launch the **PENUP** app.

## Calendar



Manage your schedule by entering upcoming events in your planner.

### Creating events

- 1 Launch the **Calendar** app and tap  or double-tap a date.  
If the date already has saved events or tasks in it, tap the date and tap .
- 2 Enter event details and tap **Save**.

### Syncing events with your accounts

- 1 Launch the **Settings** app, tap **Accounts and backup** → **Manage accounts**, and then select the account to sync with.
- 2 Tap **Sync account** and tap the **Calendar** switch to activate it.

To add accounts to sync with, launch the **Calendar** app and tap  →  → **Manage calendars** → . Then, select an account to sync with and sign in. When an account is added, a blue circle is displayed next to the account name.



## Reminder

Register to-do items as reminders and receive notifications according to the condition you set.



- To receive more accurate notifications, connect to a Wi-Fi or mobile network.
- To use location reminders, the GPS feature must be activated. Location reminders may not be available depending on the model.

### Starting Reminder

Launch the **Calendar** app and tap  → **Reminder**. The Reminder screen will appear and the Reminder app icon () will be added to the Apps screen.

### Creating reminders

- 1 Launch the **Reminder** app.
- 2 Tap , enter the details, and then tap **Save**.

### Completing reminders

On the reminders list, tap  or select a reminder and tap **Complete**.

### Restoring reminders

Restore reminders that have been completed.



- 1 On the reminders list, tap  → **Completed**.
- 2 Select a category and tap **Edit**.
- 3 Select a reminder to restore and tap **Restore**.  
Reminders will be added to the reminders list and you will be reminded again.

### Deleting reminders

To delete a reminder, select a reminder and tap **Delete**. To delete multiple reminders, tap and hold a reminder, tick reminders to delete, and then tap **Delete**.

## Voice Recorder

Record or play voice recordings.

- 1 Launch the **Voice Recorder** app.
- 2 Tap  to start recording. Speak into the microphone.
  - Tap  to pause recording.
  - While making a voice recording, tap **BOOKMARK** to insert a bookmark.
- 3 Tap  to finish recording.
- 4 Enter a file name and tap **Save**.

### Changing the recording mode

Select a mode from the top of the voice recorder screen.

- **Standard:** This is the normal recording mode.
  - **Interview:** The device records sound from the top and the bottom of the device at a high volume while reducing the volume of sound from the sides.
  - **Speech-to-text:** The device records your voice and simultaneously converts it to on-screen text. For best results, keep the device near your mouth and speak loudly and clearly in a quiet place.
-  If the voice memo system language does not match the language you are speaking, the device will not recognise your voice. In this case, before using this feature, tap the current language to set the voice memo system language.

## Playing selected voice recordings

When you review interview recordings, you can mute or unmute certain sound sources in the recording.

- 1 Tap **List** and select a voice recording made in interview mode.
- 2 To mute certain sound sources, tap **ON** for the corresponding direction that sound is to be muted.

The icon will change to **OFF** and the sound will be muted.

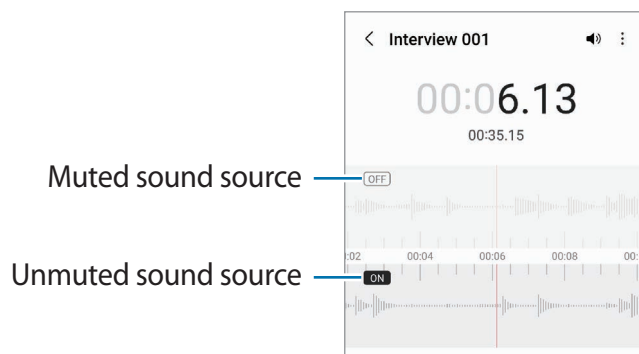

## My Files

Access and manage various files stored in the device.

Launch the **My Files** app.

To check for unnecessary data and free up the device's storage, tap **Analyse storage**.

To search for files or folders, tap **Q**.

## Clock





Set alarms, check the current time in many cities around the world, time an event, or set a specific duration.

Launch the **Clock** app.

## Calculator

Perform simple or complex calculations.



Launch the **Calculator** app.

-  : View the calculation history. To clear the history, tap **Clear history**. To close the calculation history panel, tap .
-  : Use the unit conversion tool. You can convert various values, such as area, length, or temperature, into other units.
-  : Display the scientific calculator.

## Game Launcher

Game Launcher gathers your games downloaded from **Play Store** and **Galaxy Store** into one place for easy access. You can set the device to game mode to play games more easily.

Launch the **Game Launcher** app and select the game you want.

-  If **Game Launcher** does not appear, launch the **Settings** app, tap **Advanced features**, and then tap the **Game Launcher** switch to activate it.
- Games downloaded from **Play Store** and **Galaxy Store** will be automatically shown on the Game Launcher screen. If you cannot see your games, tap **My games** →  → **Add games**.

### Removing a game from Game Launcher

Tap **My games**, tap and hold a game, and then tap **Remove**.

### Changing the performance mode

You can change the game performance mode.

Launch the **Game Launcher** app, tap  → **Game Booster** → **Game optimisation**, and then select the mode you want.









- **Performance**: This focuses on giving you the best possible performance while playing games.
- **Standard**: This balances the performance and the battery usage time.
- **Battery saver**: This saves battery power while playing games.

-  Battery power efficiency may vary by game.

## Game Booster

Game Booster lets you play games in a better environment. You can use Game Booster while playing games.

To open the Game Booster panel while playing games, tap  on the navigation bar. If the navigation bar is hidden, drag upwards from the bottom of the screen to show it. If you have set the navigation bar to use **Swipe gestures**, open the notification panel and tap **Tap to open Game Booster**.

-  : Lock the touchscreen while the game is being played. To unlock the touchscreen, drag the lock icon in any direction.
  -  : Hide the buttons on the navigation bar. To display the buttons, tap  on the navigation bar.
  -  : Capture screenshots.
  -  : Record your game sessions. To stop recording, tap .
  -  : Configure settings for Game Booster.
  - **Priority mode**: Set the device to block incoming calls and all notifications except for alarms to prevent your game from being disturbed.
  - **Monitoring temperature / Monitoring memory**: Set the device to automatically adjust the volume or video frame rate to prevent the device from overheating and to stop apps from running in the background when there is not enough memory.
-  • You can set to open the Game Booster panel from the navigation bar while the navigation bar is set to **Swipe gestures**. On the Game Booster panel, tap  → **Block during game** and tap the **Navigation gestures** switch to activate it.
- Available options may vary depending on the game.

### Launching apps in pop-up windows while playing games

You can launch apps in pop-up windows while playing a game.

Tap  and select an app from the apps list.

## SmartThings

Control and manage smart appliances and Internet of Things (IoT) products with your smartphone.

To view more information, launch the **SmartThings** app and tap **Menu** → **How to use**.

- 1 Launch the **SmartThings** app.
- 2 Tap **Devices** → **Add device** or **+**.
- 3 Select a device and connect to it by following the on-screen instructions.



- Connection methods may vary depending on the type of connected devices or the shared content.
- The devices you can connect may vary depending on the region. Available features may differ depending on the connected device.
- Connected devices' own errors or defects are not covered by the Samsung warranty. When errors or defects occur on the connected devices, contact the device's manufacturer.

## Sharing content

Share content by using various sharing options. The following actions are an example of sharing images.

- 1 Launch the **Gallery** app and select an image.
- 2 Tap and select a sharing method you want.



- You may incur additional charges when sharing files via the mobile network.

### Quick Share

#### Sharing content with nearby devices

Share content with nearby devices via Wi-Fi Direct or Bluetooth, or with SmartThings supported devices.

- 1 Launch the **Gallery** app and select an image.
- 2 On the other device, open the notification panel, swipe downwards, and then tap (**Quick Share**) to activate it. If you cannot find (**Quick Share**) on the quick panel, tap and drag the button over to add it.

3 Tap  → **Quick Share** and select a device to transfer the image to.

4 Accept the file transfer request on the other device.



 This feature does not support sharing videos with TVs or SmartThings supported devices. To watch videos on TV, use the Smart View feature.

### Pointing to share (Galaxy S22 Ultra, Galaxy S22+)

Share content by pointing the device among the nearby devices.

This feature is available only on Galaxy devices that support the Ultra-Wideband (UWB) feature. Also, the screen of the other device receiving files must be turned on.

1 Launch the **Gallery** app and select an image.

2 On the other device, open the notification panel, swipe downwards, and then tap  (**Quick Share**) to activate it. If you cannot find  (**Quick Share**) on the quick panel, tap  and drag the button over to add it.

3 On the other device, tap and hold  (**Quick Share**) and tap the **Show my position to others** switch to activate it.

4 Tap  → **Quick Share** and point the back of your device at the other device.

5 Tap the other device when it appears at the top of the screen.

6 Accept the file transfer request on the other device.

 The Ultra-Wideband (UWB) feature may not be available depending on the region.

### Setting who can find your device

Set who is allowed to find and send content to your device.

1 Open the notification panel, swipe downwards, and then tap  (**Quick Share**).

2 Select an option.

- **No one:** Do not allow others to find your device.
- **Contacts only:** Only allow Samsung users in your contacts to share with your device.
- **Anyone nearby:** Allow any nearby devices to share with your device.

## Sharing via Web link

Upload large files to the Samsung storage server and share them with others via Web link.

- 1 Launch the **Gallery** app and select an image.
- 2 Tap  → **Quick Share** and select an option you want under **Share as link**.
  - **Share using QR code:** The link to the server where the image was uploaded will be created as a QR code. Scan the QR code on the other device to share the link.
  - **Share in an app:** When you select an app, the link to the server where the image was uploaded will be displayed. Share the link with others.

## Music Share

### Introduction

The Music Share feature allows you to share your Bluetooth speaker that is already connected to your device with another person. You can also listen to the same music on your Galaxy Buds and another person's Galaxy Buds.

This feature is available only on devices that support the Music Share feature.

### Sharing a Bluetooth speaker

You can listen to music on your smartphone and your friend's smartphone via your Bluetooth speaker.

- 1 Make sure that your smartphone and your Bluetooth speaker are connected.  
Refer to [Pairing with other Bluetooth devices](#) for how to connect.
- 2 On your smartphone, launch the **Settings** app, tap **Connections** → **Bluetooth** →  → **Advanced**, and then tap the **Music Share** switch to activate it.  
You can use additional features, such as setting who to share your device with, by tapping **Music Share**.
- 3 On your friend's smartphone, select your speaker from the list of the Bluetooth devices.
- 4 On your smartphone, accept the connection request.  
Your speaker will be shared.  
When you play music via your friend's smartphone, the music playing via your smartphone will be paused.



## Listening to music together with Galaxy Buds

You can listen to music on your smartphone together through your Buds and your friend's Buds.

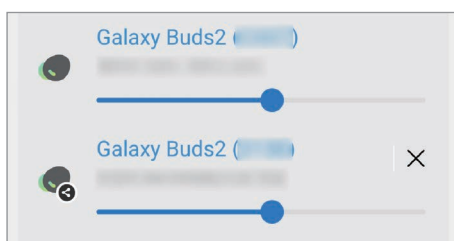

This feature is supported only on the Galaxy Buds series.

- 1 Make sure that each smartphone and pair of Buds are connected.  
Refer to [Pairing with other Bluetooth devices](#) for how to connect.
- 2 On your friend's smartphone, launch the **Settings** app, tap **Connections** → **Bluetooth** → **⋮** → **Advanced**, and then tap the **Music Share** switch to activate it.  
You can use additional features, such as setting who to share your device with, by tapping **Music Share**.
- 3 On your smartphone, open the notification panel and tap **Media output**.
- 4 Tap **Music Share** and select your friend's Buds from the detected devices list.
- 5 On your friend's smartphone, accept the connection request.  
When you play music via your smartphone, you can listen to it together via both Buds.



## Smart View

View your device's displayed content on a large screen by connecting your device to a screen mirroring-enabled TV or monitor.

- 1 Open the notification panel, swipe downwards, and then tap  (**Smart View**).
  - 2 Select a device to mirror your device's screen.
-  When you play a video with Smart View, the resolution may vary depending on the TV model.

## Link to Windows

You can connect your device to a Windows PC to instantly access your device's data, such as pictures or messages, on the computer.

When calls or messages come in, you can receive them on the computer.

- It is recommended to use the latest version of Windows and the **Your Phone** app to fully use this feature.
- A Microsoft account is required to use this feature. When you create a Microsoft account, you can sign in to all Microsoft devices and services, such as Microsoft Office programs and Windows 10.

### Connecting to a computer

- 1 Launch the **Settings** app and tap **Advanced features** → **Link to Windows**.
- 2 Follow the on-screen instructions to complete the connection.

Visit <https://aka.ms/setupltw> for details.

### Viewing data and notifications from your device on the computer

Launch the **Your Phone** app on the computer and select a category you want.

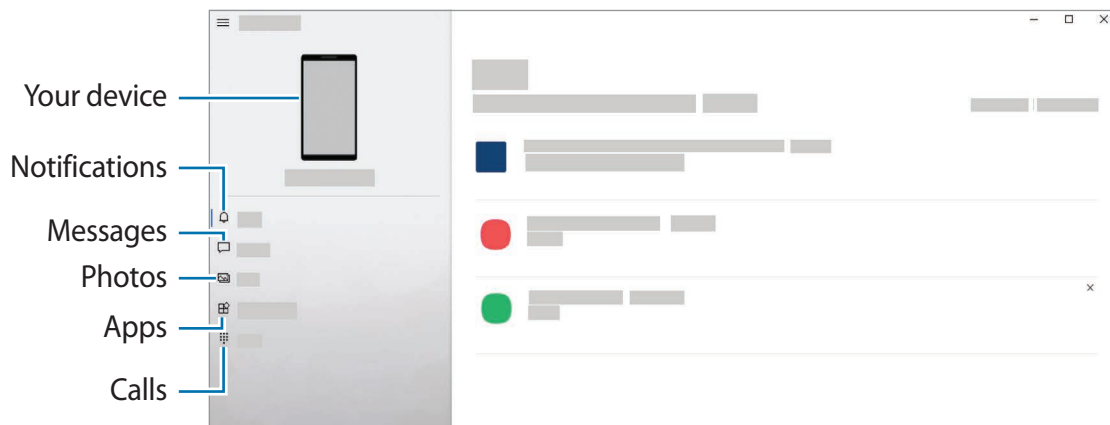

Available features and menus may vary depending on the software version or model.

# Samsung DeX

## Introduction

Samsung DeX is a service that allows you to use your smartphone like a computer by connecting the smartphone to an external display, such as a TV or monitor, or to a computer. Accomplish tasks you want done on your smartphone quickly and easily on a large screen using a keyboard and mouse. While using Samsung DeX, you can simultaneously use your smartphone.

## Connecting devices and starting Samsung DeX

### Wired connections to external displays

You can connect your smartphone to an external display using an HDMI adaptor (USB Type-C to HDMI).



Use only official Samsung DeX supported accessories that are provided by Samsung. Performance problems and malfunctions caused by using accessories that are not officially supported are not covered by the warranty.

- 1 Connect an HDMI adaptor to your smartphone.
- 2 Connect an HDMI cable to the HDMI adaptor and to a TV or monitor's HDMI port.

3 On your smartphone's screen, tap **Start**.

Without changing your smartphone's screen, the Samsung DeX screen will appear on the connected TV or monitor.

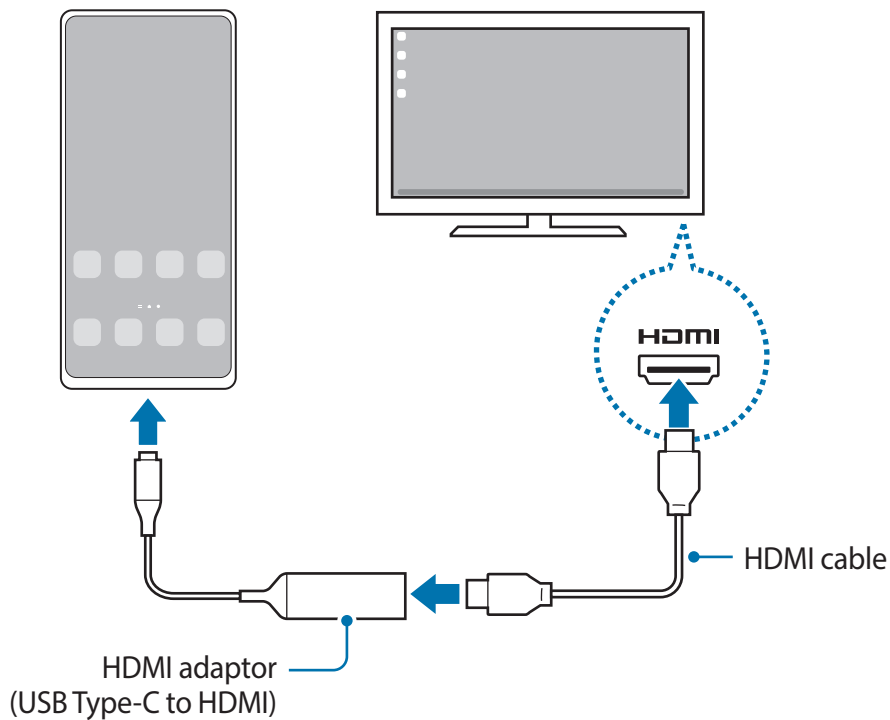

## Wired connections to computers

You can use Samsung DeX by connecting your smartphone to a computer using a USB cable. To use the USB cable supplied with the device, the computer must have a USB Type-C port.

- 1 On a computer, visit [www.samsung.com/samsung-dex](http://www.samsung.com/samsung-dex) and download the Samsung DeX app.
- 2 Connect your smartphone to a computer using a USB cable.

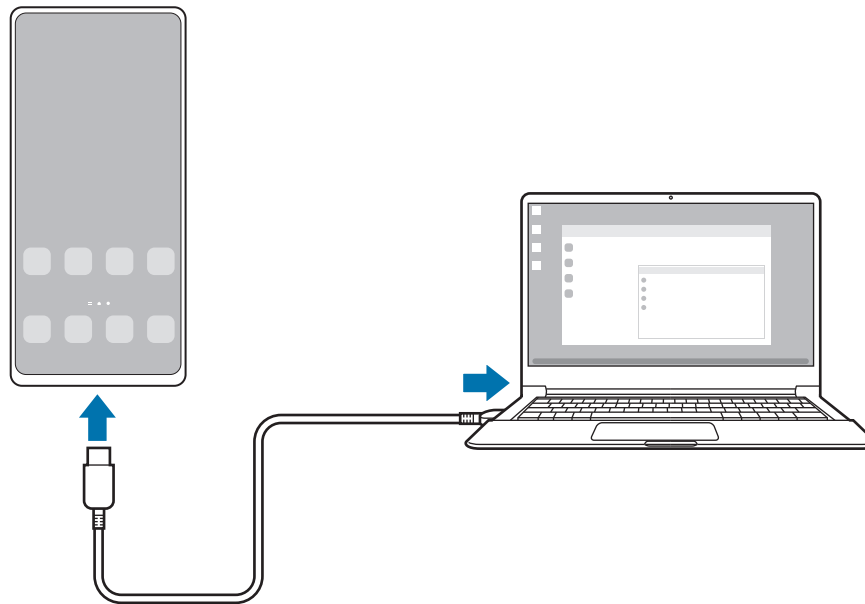

- 3 On your smartphone's screen, tap **Start now**.

When they are connected, the Samsung DeX screen will appear on the computer.



## Wireless connections

You can use Samsung DeX by connecting your smartphone to a TV or a computer wirelessly.

- 1 On your smartphone, open the notification panel, swipe downwards, and then tap  (DeX).
  - 2 Tap **DeX on TV or monitor** or **DeX on PC**.
  - 3 Select a TV or a computer from the detected devices list and tap **Start now**.  
Some TVs will only be detected when its screen mirroring mode is turned on.  
The computer must be connected to the same Wi-Fi network as your smartphone and the Samsung DeX app must be running on it.
  - 4 If the connection request window appears on the TV or the computer, accept the request.
  - 5 Follow the on-screen instructions to complete the connection.  
When they are connected, the Samsung DeX screen will appear on the TV or the computer.
-  • It is recommended to use a Samsung Smart TV manufactured after 2019.
  - Make sure that screen mirroring is supported on the TV you want to connect to.

## Controlling the Samsung DeX screen

### Controlling on an external display

#### Controlling with an external keyboard and mouse

You can use a wireless keyboard/mouse. Refer to the respective device's manual for more information.

- You can set the mouse pointer to flow from the external display to the smartphone's screen. Launch the **Settings** app, select **Samsung DeX** → **Mouse and trackpad**, and then select the **Flow pointer to phone screen** switch to activate it.
- You can also use the external keyboard on the smartphone's screen.

#### Using your smartphone as a touchpad

You can use your smartphone as a touchpad.

On your smartphone, tap  on the navigation bar. If you have set the navigation bar to use **Swipe gestures**, open the notification panel and tap **Use your phone as a touchpad**.

- If you double-tap  on the touchpad, you can view the gestures you can use with the touchpad.
- If your smartphone's case has a front cover, open the front cover to use your smartphone as a touchpad. If the front cover is closed, the touchpad may not work properly.
- If your smartphone's screen turns off, press the Side key or double-tap the screen to turn on the screen.

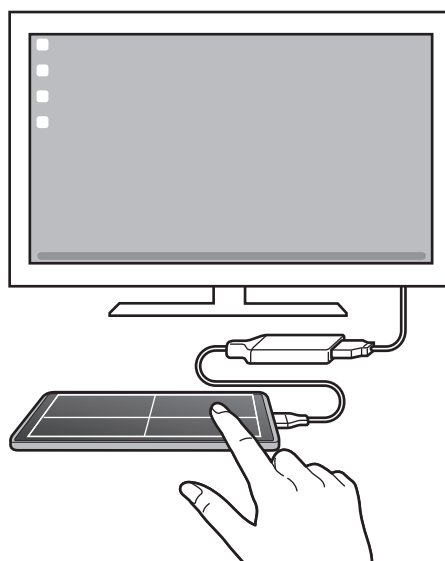

## Using the screen keyboard

When you enter text to send messages, create notes, or perform other tasks, a screen keyboard will appear automatically on your smartphone's screen without connecting an external keyboard.

## Controlling on a computer

Control the Samsung DeX screen using the keyboard and mouse connected to the computer. You can move files easily between the computer and Samsung DeX by drag and drop, and you can also copy and paste text.

- 📌 To view keyboard shortcuts available while using Samsung DeX, launch the **Settings** app and tap **General management** → **Physical keyboard** → **Keyboard shortcuts**.

## Using Samsung DeX

Use your smartphone's features in an interface environment similar to a computer. You can multitask by running multiple apps simultaneously. You can also check your smartphone's notifications and status.

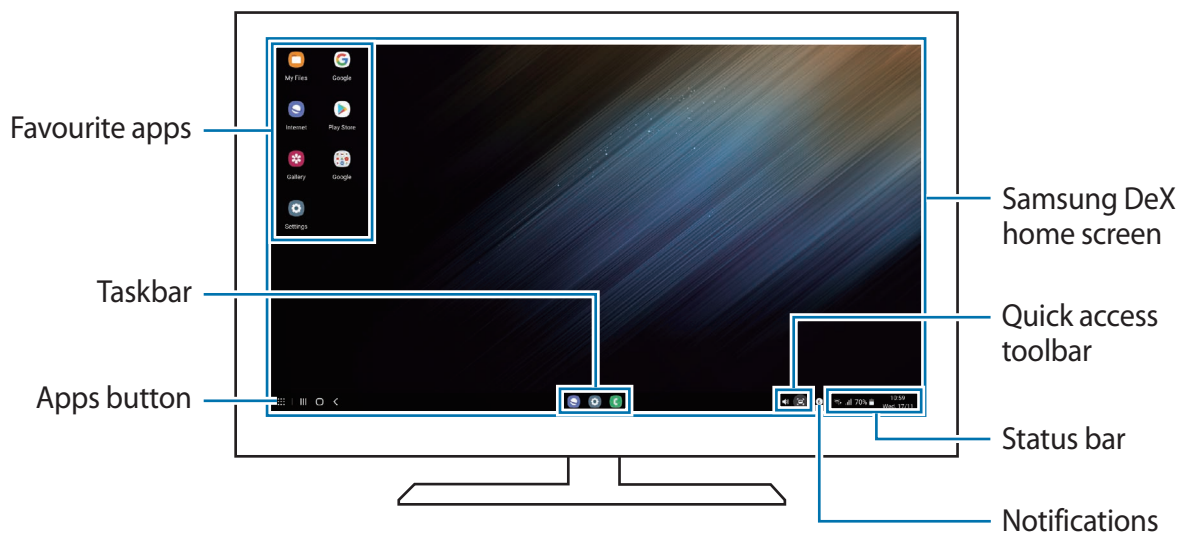

- 📌 • The Samsung DeX screen layout may differ depending on the connected device.
- When starting or ending Samsung DeX, running apps may be closed.
- Some apps or features may not be available when using Samsung DeX.
- To adjust the screen settings, use the connected TV or monitor's display settings.
- To change the audio output, tap the status bar, select **Media output**, and then select a device.

## Using Samsung DeX and smartphone simultaneously

While using Samsung DeX, you can use separate apps on the external display or the computer and your smartphone simultaneously.

For example, while watching a video on the connected TV or monitor, you can chat with your friend on a messenger.

On the connected TV or monitor, launch an app to run on the Samsung DeX screen. Then, launch another app on your smartphone.

## Locking the Samsung DeX screen

If you want to lock the Samsung DeX screen and your smartphone's screen while using Samsung DeX, select  → **Lock DeX**.

 While using Samsung DeX, you cannot lock the Samsung DeX screen and your smartphone's screen by pressing the Side key.

## Transferring data with a computer

### Copying files

On the Samsung DeX screen, click and hold a file to select it in the **My Files** app or **Gallery** app and drag it to the computer screen. On the computer screen, select a file and drag it to the Samsung DeX screen, the **My Files** app, or the **Gallery** app.

### Copying and pasting text

Using the keyboard shortcut keys, copy text on the Samsung DeX screen or computer screen and paste it in the text input field on the other screen.



## Google apps

Google provides entertainment, social network, and business apps. You may require a Google account to access some apps.

To view more app information, access each app's help menu.

- **Chrome:** Search for information and browse webpages.
- **Gmail:** Send or receive emails via the Google Mail service.
- **Maps:** Find your location on the map, search the world map, and view location information for various places around you.
- **YT Music:** Enjoy various music and videos provided by YouTube Music. You can also view the music collections stored on your device and play them.
- **Google Play Movies & TV:** Purchase or rent videos, such as movies and TV programmes, from **Play Store**.
- **Drive:** Store your content on the cloud, access it from anywhere, and share it with others.
- **YouTube:** Watch or create videos and share them with others.
- **Photos:** Search for, manage, and edit all your pictures and videos from various sources in one place.
- **Google:** Search quickly for items on the Internet or your device.
- **Duo:** Make a simple video call.
- **Messages:** Send and receive messages on your device or computer, and share various content, such as images and videos.



Some apps may not be available depending on the service provider or model.

# Settings

## Introduction

Customise device settings.

Launch the **Settings** app.

To search for settings by entering keywords, tap **Q**. You can also search for settings by selecting a tag under **Suggestions**.

## Samsung account

Sign in to your Samsung account and manage it.

On the Settings screen, tap **Samsung account**.

## Connections

### Options

Change settings for various connections, such as the Wi-Fi feature and Bluetooth.

On the Settings screen, tap **Connections**.

- **Wi-Fi:** Activate the Wi-Fi feature to connect to a Wi-Fi network and access the Internet or other network devices. Refer to [Wi-Fi](#) for more information.
- **Bluetooth:** Use Bluetooth to exchange data or media files with other Bluetooth-enabled devices. Refer to [Bluetooth](#) for more information.
- **NFC and contactless payments:** Set the device to allow you to read near field communication (NFC) tags that contain information about products. You can also use this feature to make payments and buy tickets for transportation or events after downloading the required apps. Refer to [NFC and contactless payments](#) for more information.

- **Flight mode:** Set the device to disable all wireless functions on your device. You can use only non-network services.

 Follow the regulations provided by the airline and the instructions of aircraft personnel. In cases where it is allowed to use the device, always use it in flight mode.

- **Mobile networks:** Configure your mobile network settings.
- **Data usage:** Keep track of your data usage amount and customise the settings for the limitation. Set the device to automatically disable the mobile data connection when the amount of mobile data you have used reaches your specified limit.

You can activate the data saver feature to prevent some apps running in the background from sending or receiving data. Refer to [Data saver](#) for more information.

You can also select apps to always use the mobile data even when your device is connected to a Wi-Fi network. Refer to [Mobile data only apps](#) for more information.

- **SIM card manager** (dual SIM models): Activate your SIM or USIM cards and customise the SIM card settings. Refer to [SIM card manager \(dual SIM models\)](#) for more information.
- **Mobile Hotspot and Tethering:** Use the device as a mobile hotspot to share the device's mobile data connection with other devices. For more information about the mobile hotspot, refer to [Mobile Hotspot](#).

 You may incur additional charges when using this feature.



- **More connection settings:** Customise settings to control other features. Refer to [More connection settings](#) for more information.

## Wi-Fi

Activate the Wi-Fi feature to connect to a Wi-Fi network and access the Internet or other network devices.

### Connecting to a Wi-Fi network

- 1 On the Settings screen, tap **Connections** → **Wi-Fi** and tap the switch to activate it.
- 2 Select a network from the Wi-Fi networks list.  
Networks with a lock icon require a password.

-  • Once the device connects to a Wi-Fi network, the device will reconnect to that network each time it is available without requiring a password. To prevent the device from connecting to the network automatically, tap  next to the network and tap the **Auto reconnect** switch to deactivate it.
- If you cannot connect to a Wi-Fi network properly, restart your device's Wi-Fi feature or the wireless router.

### Viewing the Wi-Fi network quality information

View the Wi-Fi network quality information, such as the speed and stability.

On the Settings screen, tap **Connections** → **Wi-Fi** and tap the switch to activate it. The network quality information will appear under the Wi-Fi networks. If it does not appear, tap  → **Advanced** and tap the **Show network quality info** switch to activate it.

-  The quality information may not appear depending on the Wi-Fi network.

### Sharing Wi-Fi network passwords

If you make a request to a person who is connected to a secured Wi-Fi network to share its password, you can connect to the network without entering the password. This feature is available between the devices which have contacts each other and the screen of the other device must be turned on.

- 1 On the Settings screen, tap **Connections** → **Wi-Fi** and tap the switch to activate it.
- 2 Select a network from the Wi-Fi networks list.
- 3 Tap **Request password**.
- 4 Accept the share request on the other device.  
The Wi-Fi password is entered on your device and it is connected to the network.

## Wi-Fi Direct

Wi-Fi Direct connects devices directly via a Wi-Fi network without requiring an access point.

- 1 On the Settings screen, tap **Connections** → **Wi-Fi** and tap the switch to activate it.
- 2 Tap  → **Wi-Fi Direct**.  
The detected devices are listed.  
If the device you want to connect to is not in the list, request that the device turns on its Wi-Fi Direct feature.
- 3 Select a device to connect to.  
The devices will be connected when the other device accepts the Wi-Fi Direct connection request.  
To end the device connection, select the device to disconnect from the list.

## Bluetooth

Use Bluetooth to exchange data or media files with other Bluetooth-enabled devices.

### Precautions for using Bluetooth

- Samsung is not responsible for the loss, interception, or misuse of data sent or received via Bluetooth.
- Always ensure that you share and receive data with devices that are trusted and properly secured. If there are obstacles between the devices, the operating distance may be reduced.
- Some devices, especially those that are not tested or approved by the Bluetooth SIG, may be incompatible with your device.
- Do not use the Bluetooth feature for illegal purposes (for example, pirating copies of files or illegally tapping communications for commercial purposes). Samsung is not responsible for the repercussion of illegal use of the Bluetooth feature.

### Pairing with other Bluetooth devices

- 1 On the Settings screen, tap **Connections** → **Bluetooth** and tap the switch to activate it.  
The detected devices will be listed.
- 2 Select a device to pair with.  
If the device you want to pair with is not on the list, set the device to enter Bluetooth pairing mode. Refer to the other device's user manuals.

 Your device is visible to other devices while the Bluetooth settings screen is open.

- 3 Accept the Bluetooth connection request on your device to confirm.  
The devices will be connected when the other device accepts the Bluetooth connection request.  
To unpair the devices, tap  next to the device name to unpair and tap **Unpair**.

## Sending and receiving data

Many apps support data transfer via Bluetooth. You can share data, such as contacts or media files, with other Bluetooth devices. The following actions are an example of sending an image to another device.

- 1 Launch the **Gallery** app and select an image.
- 2 Tap  → **Bluetooth** and select a device to transfer the image to.  
If the device you want to pair with is not in the list, request that the device turns on its visibility option.
- 3 Accept the Bluetooth connection request on the other device.

## NFC and contactless payments

Your device allows you to read near field communication (NFC) tags that contain information about products. You can also use this feature to make payments and buy tickets for transportation or events after downloading the required apps.

-  The device contains a built-in NFC antenna. Handle the device carefully to avoid damaging the NFC antenna.

## Reading information from NFC tags

Use the NFC feature to read product information from NFC tags.

- 1 On the Settings screen, tap **Connections** and tap the **NFC and contactless payments** switch to activate it.

- 2 Place the NFC antenna area on the back of your device near an NFC tag.  
The information from the tag appears.

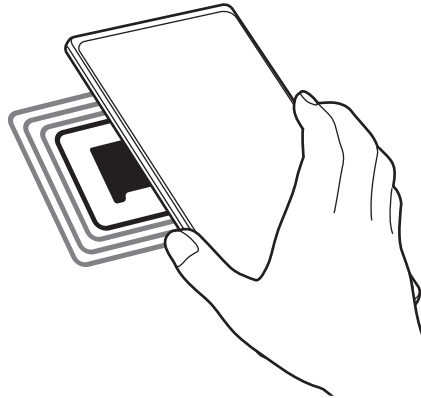

- ☑ Ensure that the device's screen is turned on and unlocked. Otherwise, the device will not read NFC tags or receive data.

## Making payments with the NFC feature

Before you can use the NFC feature to make payments, you must register for the mobile payment service. To register or get more information about the service, contact your service provider.

- 1 On the Settings screen, tap **Connections** and tap the **NFC and contactless payments** switch to activate it.
- 2 Touch the NFC antenna area on the back of your device to the NFC card reader.

To set the default payment app, open the Settings screen and tap **Connections** → **NFC and contactless payments** → **Contactless payments** → **Payment**, and then select an app.

- ☑ • The payment services list may not include all available payment apps.
- If you update the payment app or install a new one, the payment services that you used before may not work properly. If that is the case, on the Settings screen, tap **Connections** → **NFC and contactless payments** → **Contactless payments** → **Payment** or **Others**, and then select another app instead of the updated or newly installed app. Or, deselect the selected app.

## Data saver

Reduce your data usage by preventing some apps running in the background from sending or receiving data.

On the Settings screen, tap **Connections** → **Data usage** → **Data saver** and tap the switch to activate it.

When the data saver feature is activated, the  icon will appear on the status bar.



 To select apps to use data without restriction, tap **Allowed to use data while Data saver is on** and select apps.

## Mobile data only apps

Select apps to always use the mobile data even when your device is connected to a Wi-Fi network.

For example, you can set the device to use only mobile data for apps that you want to keep secure or streaming apps that can be disconnected. Even if you do not deactivate the Wi-Fi feature, the apps will launch using the mobile data.

On the Settings screen, tap **Connections** → **Data usage** → **Mobile data only apps** and tap the switches next to the apps you want.

 You may incur additional charges when using this feature.

## Mobile Hotspot

Use your device as a mobile hotspot to share your device's mobile data connection with other devices.

1 On the Settings screen, tap **Connections** → **Mobile Hotspot and Tethering** → **Mobile Hotspot**.

2 Tap the switch to activate it.

The  icon appears on the status bar.

You can change the level of security and the password by tapping **Configure**.



3 On the other device's screen, search for and select your device from the Wi-Fi networks list. Alternatively, tap **QR code** on the mobile hotspot screen and scan the QR code with the other device.

-  • If the mobile hotspot is not found, on your device, tap **Configure** and set **Band** to **2.4 GHz**, tap **Advanced**, and then tap the **Hidden network** switch to deactivate it.
- If you activate the **Auto Hotspot** feature, you can share your device's mobile data connection with other devices signed in to your Samsung account.

## More connection settings

Customise settings to control other connection features.

On the Settings screen, tap **Connections** → **More connection settings**.

- **Nearby device scanning:** Set the device to scan for nearby devices to connect to.
- **Printing:** Configure settings for printer plug-ins installed on the device. You can search for available printers or add one manually to print files. Refer to [Printing](#) for more information.
- **VPN:** Set up virtual private networks (VPNs) on your device to connect to a school or company's private network.
- **Private DNS:** Set the device to use the security enhanced private DNS.
- **Ethernet:** When you connect an Ethernet adaptor, you can use a wired network and configure network settings.

## Printing

Configure settings for printer plug-ins installed on the device. You can connect the device to a printer via Wi-Fi or Wi-Fi Direct, and print images or documents.

-  Some printers may not be compatible with the device.

### Adding printer plug-ins

Add printer plug-ins for printers you want to connect the device to.

- 1 On the Settings screen, tap **Connections** → **More connection settings** → **Printing** → **Download plugin**.
- 2 Select a printer plug-in and install it.
- 3 Select the installed printer plug-in.  
The device will automatically search for printers that are connected to the same Wi-Fi network as your device.

4 Select a printer to add.

 To add printers manually, tap  → **Add printer**.

## Printing content

While viewing content, such as images or documents, access the options list, tap **Print** → ▼ → **All printers...**, and then select a printer.

 Printing methods may vary depending on the content type.

# Sounds and vibration

## Options

Change settings for various sounds on the device.

On the Settings screen, tap **Sounds and vibration**.

- **Sound mode:** Set the device to use sound mode, vibration mode, or silent mode.
- **Vibrate while ringing:** Set the device to vibrate and play a ringtone for incoming calls.
- **Temporary mute:** Set the device to use silent mode for a certain period.
- **Ringtone:** Change the call ringtone.
- **Notification sound:** Change the notification sound.
- **System sound:** Change the sound to use for certain actions, such as charging the device.
- **Volume:** Adjust the device's volume level.
- **Call vibration pattern:** Change the call vibration pattern.
- **Notification vibration pattern:** Change the notification vibration pattern.
- **Vibration intensity:** Adjust the force of the vibration notification.
- **System sound/vibration control:** Set the device to sound or vibrate for actions, such as controlling the touchscreen.
- **Sound quality and effects:** Set the device's sound quality and effects. Refer to [Sound quality and effects](#) for more information.
- **Separate app sound:** Set the device to play media sound from a specific app separately on the other audio device. Refer to [Separate app sound](#) for more information.

 Some features may not be available depending on the model.

## Sound quality and effects

Set the device's sound quality and effects.

On the Settings screen, tap **Sounds and vibration** → **Sound quality and effects**.

- **Dolby Atmos:** Select a surround sound mode optimised for various types of audio, such as movies, music, and voice. With Dolby Atmos, you can experience moving audio sounds that flow all around you.
- **Dolby Atmos for gaming:** Experience the Dolby Atmos sound optimised for games while playing games.
- **Equaliser:** Select an option for a specific music genre and enjoy optimised sound.
- **UHQ upscaler:** Enhance the sound resolution of music and videos when using wired earphones.
- **Adapt sound:** Set the best sound for you.



Depending on the model, you must connect an earphone to use some features.

## Separate app sound

Set the device to play media sound from a specific app on the connected Bluetooth speaker or headset.

For example, you can listen to the Navigation app through your device's speaker while listening to playback from the Music app through the vehicle's Bluetooth speaker.

- 1 On the Settings screen, tap **Sounds and vibration** → **Separate app sound** and tap the switch to activate it.
- 2 Select an app to play media sounds separately and tap the Back button.
- 3 Select a device for playing the selected app's media sound.

## Notifications

Change the notification settings.

On the Settings screen, tap **Notifications**.

- **Notification pop-up style:** Select a notification pop-up style and change the settings.
- **Recently sent:** View the apps that received recent notifications and change the notification settings. To customise notification settings for more apps, tap **More** → ▼ → **All** and select an app from the apps list.
- **Do not disturb:** Set the device to mute all sounds except for allowed exceptions.
- **Advanced settings:** Configure advanced settings for notifications.

## Display

### Options

Change the display and the Home screen settings.

On the Settings screen, tap **Display**.

- **Light / Dark:** Activate or deactivate dark mode.
- **Dark mode settings:** Reduce eye strain by applying the dark theme when using the device at night or in a dark place. You can set a schedule for applying dark mode.  
 The dark theme may not be applied in some apps.
- **Brightness:** Adjust the brightness of the display.
- **Adaptive brightness:** Set the device to keep track of your brightness adjustments and apply them automatically in similar lighting conditions.
- **Extra brightness:** Set the display to be brighter than the maximum brightness. This feature is available when you deactivate the **Adaptive brightness** feature.
- **Motion smoothness:** Change the refresh rate of the screen. When a high refresh rate is set, the screen will scroll more smoothly. Refer to [Motion smoothness](#) for more information.
- **Eye comfort shield:** Reduce eye strain by limiting the amount of blue light emitted by the screen. You can set a schedule for applying this feature.
- **Screen mode:** Change the screen mode to adjust the display's colour and contrast. Refer to [Changing the screen mode or adjusting the display colour](#) for more information.

- **Font size and style:** Change the font size and style.
- **Screen zoom:** Make the items on the screen larger or smaller.
- **Screen resolution:** Change the screen resolution. Higher resolutions make the display more vivid, however they will consume more battery power. Some currently running apps may close when you change the resolution.
- **Full screen apps:** Select apps to use with the full screen aspect ratio.
- **Screen timeout:** Set the length of time the device waits before turning off the display's backlight.
- **Easy mode:** Switch to easy mode to display larger icons and apply a simpler layout to the Home screen.
- **Edge panels:** Change the settings for the Edge panel.
- **Navigation bar:** Change the navigation bar settings. Refer to [Navigation bar \(soft buttons\)](#) for more information.
- **Accidental touch protection:** Set the device to prevent the screen from detecting touch input when it is in a dark place, such as a pocket or bag.
- **Touch sensitivity:** Increase the touch sensitivity of the screen for use with screen protectors.
- **Show charging information:** Set the device to display the charging information, such as the remaining battery percentage when the screen is off.
- **Screen saver:** Set the device to launch a screensaver when the device is charging.



Some features may not be available depending on the model.

## Motion smoothness

The refresh rate is the number of times the screen is refreshed every second. Use a high refresh rate to prevent the screen from flickering when switching between screens. The screen will scroll more smoothly. When you select a standard refresh rate, you can use the battery longer.

- 1 On the Settings screen, tap **Display** → **Motion smoothness**.
- 2 Select a refresh rate.
  - **Adaptive:** Get smoother animations and scrolling by automatically adjusting your screen refresh rate up to 120 Hz.
  - **Standard:** Use a standard refresh rate in normal situations to conserve battery power.

## Changing the screen mode or adjusting the display colour

Change the screen mode or adjust the display colour to your preference.

### Changing the screen mode

On the Settings screen, tap **Display** → **Screen mode** and select a mode you want.

- **Vivid:** This optimises the colour range, saturation, and sharpness of your display. You can also adjust the display colour balance by colour value.
- **Natural:** This adjusts the screen to a natural tone.



- You can adjust the display colour only in **Vivid** mode.
- **Vivid** mode may not be compatible with third-party apps.

### Optimising the full screen colour balance

Optimise the display colour by adjusting the colour tones to your preference.

On the Settings screen, tap **Display** → **Screen mode** → **Vivid** and adjust the colour adjustment bar under **White balance**.

When you drag the colour adjustment bar towards **Cool**, the blue colour tone will increase. When you drag the bar towards **Warm**, the red colour tone will increase.

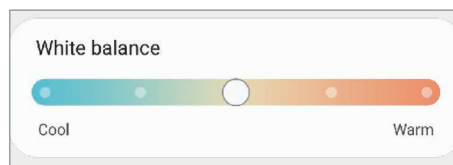

### Adjusting the screen tone by colour value

Increase or lower certain colour tones by adjusting the Red, Green, or Blue value individually.

- 1 On the Settings screen, tap **Display** → **Screen mode** → **Vivid**.
- 2 Tap **Advanced settings**.
- 3 Adjust the **R** (Red), **G** (Green), or **B** (Blue) colour bar to your preference. The screen tone will be adjusted.

## Wallpaper and style

Change the wallpaper settings for the Home screen and the locked screen.

On the Settings screen, tap **Wallpaper and style**.

## Themes

Apply various themes to the device to change the visual elements of the Home screen, locked screen, and icons.

On the Settings screen, tap **Themes**.

## Home screen

Configure settings for the Home screen, such as the screen layout.

On the Settings screen, tap **Home screen**.

## Lock screen

### Options

Change the settings for the locked screen.

On the Settings screen, tap **Lock screen**.

- **Screen lock type:** Change the screen lock method.
- **Smart Lock:** Set the device to unlock itself when trusted locations or devices are detected. Refer to [Smart Lock](#) for more information.
- **Secure lock settings:** Change screen lock settings for the selected lock method.
- **Always On Display:** Set the device to display information while the screen is turned off. Refer to [Always On Display](#) for more information.
- **Wallpaper services:** Set the device to use wallpaper services such as Dynamic Lock screen.
- **Clock style:** Change the type and colour of the clock on the locked screen.

- **Roaming clock:** Change the clock to show both the local and home time zones on the locked screen when roaming.
- **Widgets:** Change the settings of the items displayed on the locked screen.
- **Contact information:** Set the device to show contact information, such as your email address, on the locked screen.
- **Notifications:** Set how to show notifications on the locked screen.
- **Shortcuts:** Select apps to display shortcuts to them on the locked screen.
- **About Lock screen:** View the Lock screen version and legal information.



- Some features may not be available depending on the service provider or model.
- The available options may vary depending on the screen lock method selected.

## Smart Lock

You can set the device to unlock itself and remain unlocked when trusted locations or devices are detected.

For example, if you have set your home as a trusted location, when you get home your device will detect the location and automatically unlock itself.

On the Settings screen, tap **Lock screen** → **Smart Lock** and follow the on-screen instructions to complete the setup.



- This feature will be available to use after you set a screen lock method.
- If you do not use your device for four hours or when you turn on the device, you must unlock the screen using the pattern, PIN, or password you set.

## Always On Display

You can view information, such as the clock or calendar, or control music playback on the screen when it is turned off.

You can also check notifications for new messages or missed calls.

The Always On Display is set to appear only when you tap the screen. To change the settings to make it appear continuously, during a set time, or when receiving notifications, on the Settings screen, tap **Lock screen** → **Always On Display**, and then select a mode you want.





- The brightness of the Always On Display may change automatically depending on the lighting conditions.



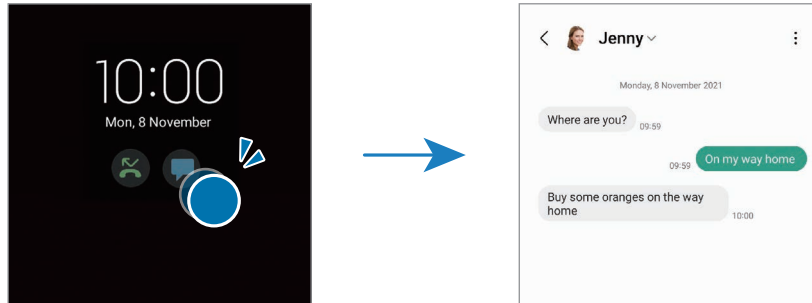

## Opening notifications on the Always On Display

When you receive message, missed call, or app notifications, notification icons will appear on the Always On Display. Double-tap a notification icon to view its notification.



 If the screen is locked, you must unlock it to view notifications.

## Deactivating the Always On Display feature

Open the notification panel, swipe downwards, and then tap  (**Always On Display**) to deactivate it. If you cannot find  (**Always On Display**) on the quick panel, tap  and drag the button over to add it.

Alternatively, on the Settings screen, tap **Lock screen**, and then tap the **Always On Display** switch to deactivate it.

# Biometrics and security

## Options

Change the settings for securing the device.

On the Settings screen, tap **Biometrics and security**.

- **Face recognition:** Set the device to unlock the screen by recognising your face. Refer to [Face recognition](#) for more information.
- **Fingerprints:** Register your fingerprints to unlock the screen. Refer to [Fingerprint recognition](#) for more information.
- **More biometrics settings:** Change the settings for biometric data. You can also view the version of the biometrics security patch and check for updates.
- **Google Play Protect:** Set the device to check for harmful apps and behaviour and warn about potential harm and remove them.
- **Security update:** View the version of your device's software and check for updates.

- **Find My Mobile:** Activate or deactivate the Find My Mobile feature. Access the Find My Mobile website ([findmymobile.samsung.com](http://findmymobile.samsung.com)) to track and control your lost or stolen device.
- **Samsung Pass:** Verify your identity easily and securely via your biometric data. Refer to [Samsung Pass](#) for more information.
- **Secure Folder:** Create a secure folder to protect your private content and apps from others. Refer to [Secure Folder](#) for more information.
- **Secure Wi-Fi:** Set the device to protect your data while using unsecured Wi-Fi networks. Refer to [Secure Wi-Fi](#) for more information.
- **Private Share:** Share files with others securely using blockchain technology.
- **Samsung Blockchain Keystore:** Manage your blockchain private key safely.
- **Install unknown apps:** Set the device to allow the installation of apps from unknown sources.
- **Other security settings:** Configure additional security settings.



Some features may not be available depending on the service provider or model.

## Face recognition

You can set the device to unlock the screen by recognising your face.



- If you use your face as a screen lock method, your face cannot be used to unlock the screen for the first time after turning on the device. To use the device, you must unlock the screen using the pattern, PIN, or password you set when registering the face. Be careful not to forget your pattern, PIN, or password.
- If you change the screen lock method to **Swipe** or **None**, which are not secure, all of your biometric data will be deleted.

## Precautions for using face recognition

Before using the face recognition to unlock your device, keep the following precautions in mind.

- Your device could be unlocked by someone or something that looks like your image.
- Face recognition is less secure than Pattern, PIN, or Password.

## For better face recognition

Consider the following when using face recognition:

- Consider the conditions when registering, such as wearing glasses, hats, masks, beards, or heavy makeup
- Ensure that you are in a well-lit area and that the camera lens is clean when registering
- Ensure your image is not blurry for better match results

## Registering your face

For better face registration, register your face indoors and out of direct sunlight.

- 1 On the Settings screen, tap **Biometrics and security** → **Face recognition**.
- 2 Read the on-screen instructions and tap **Continue**.
- 3 Set a screen lock method.
- 4 Position your face inside the frame on the screen.

The camera will scan your face.



- If unlocking the screen with your face is not working properly, tap **Remove face data** to remove your registered face and register your face again.
- To enhance the face recognition, tap **Add alternative appearance to enhance recognition** and add an alternate appearance.

## Unlocking the screen with your face

You can unlock the screen with your face instead of using a pattern, PIN, or password.

- 1 On the Settings screen, tap **Biometrics and security** → **Face recognition**.
- 2 Unlock the screen using the preset screen lock method.
- 3 Tap the **Face unlock** switch to activate it.
- 4 On the locked screen, look at the screen.

When your face is recognised, you can unlock the screen without using any additional screen lock method. If your face is not recognised, use the preset screen lock method.

## Deleting the registered face data

You can delete face data that you have registered.

- 1 On the Settings screen, tap **Biometrics and security** → **Face recognition**.
- 2 Unlock the screen using the preset screen lock method.
- 3 Tap **Remove face data** → **Remove**.

Once the registered face is deleted, all the related features will also be deactivated.

## Fingerprint recognition

In order for fingerprint recognition to function, your fingerprint information needs to be registered and stored in your device.



- This feature may not be available depending on the service provider or model.
- Fingerprint recognition uses the unique characteristics of each fingerprint to enhance the security of your device. The likelihood of the fingerprint sensor confusing two different fingerprints is very low. However, in rare cases where separate fingerprints are very similar the sensor may recognise them as identical.
- Thick protective film can affect performance. If you use a screen protector, check to make sure it's labeled as compatible with the on-screen fingerprint sensor. (such as screen protectors sold by Samsung)
- If you use your fingerprint as a screen lock method, your fingerprint cannot be used to unlock the screen for the first time after turning on the device. To use the device, you must unlock the screen using the pattern, PIN, or password you set when registering the fingerprint. Be careful not to forget your pattern, PIN, or password.
- If your fingerprint is not recognised, unlock the device using the pattern, PIN, or password you set when registering the fingerprint, and then re-register your fingerprints. If your pattern, PIN, or password is forgotten, you will not be able to use the device if you do not reset it. Samsung is not responsible for any data loss or inconvenience caused by forgotten unlock codes.
- If you change the screen lock method to **Swipe** or **None**, which are not secure, all of your biometric data will be deleted.

## For better fingerprint recognition

When you scan your fingerprints on the device, be aware of the following conditions that may affect the feature's performance:

- The device may not recognise fingerprints that are affected by wrinkles or scars.
- The device may not recognise fingerprints from small or thin fingers.
- To improve recognition performance, register the fingerprints of the fingers used most often to perform tasks on the device.
- Your device has a built-in fingerprint recognition sensor at the bottom centre of the screen. Ensure that the screen protector or the touchscreen on the fingerprint recognition sensor area is not scratched or damaged by objects, such as coins, keys, pens, and necklaces.
- Ensure that the fingerprint recognition sensor area at the bottom centre of the screen and your fingers are clean and dry.
- If you bend your finger or use a fingertip, the device may not recognise your fingerprints. Press the screen so that your fingertip spreads over the wide surface of the fingerprint recognition area.

## Registering fingerprints

- 1 On the Settings screen, tap **Biometrics and security** → **Fingerprints**.
- 2 Read the on-screen instructions and tap **Continue**.
- 3 Set a screen lock method.
- 4 Place your finger on the fingerprint recognition sensor. After the device detects your finger, lift it up and place it on the fingerprint recognition sensor again. Repeat this action until the fingerprint is registered.

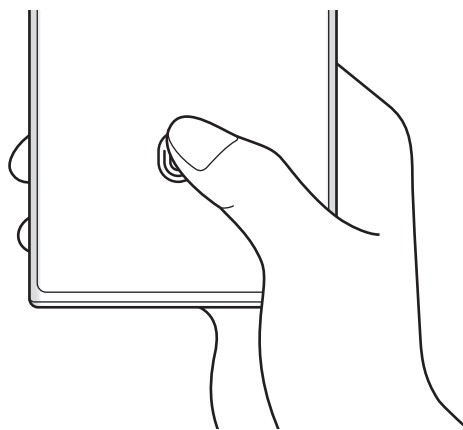

- 5 When you are finished registering your fingerprints, tap **Done**.  
You can check whether your fingerprint is registered by tapping **Check added fingerprints**.

## Unlocking the screen with your fingerprints

You can unlock the screen with your fingerprint instead of using a pattern, PIN, or password.

- 1 On the Settings screen, tap **Biometrics and security** → **Fingerprints**.
- 2 Unlock the screen using the preset screen lock method.
- 3 Tap the **Fingerprint unlock** switch to activate it.
- 4 On the locked screen, place your finger on the fingerprint recognition sensor and scan your fingerprint.

## Changing the fingerprint recognition icon setting

Set the device to show or hide the fingerprint recognition icon when you tap the screen while the screen is turned off.

- 1 On the Settings screen, tap **Biometrics and security** → **Fingerprints**.
- 2 Unlock the screen using the preset screen lock method.
- 3 Tap **Show icon when screen is off** and select an option.

## Deleting registered fingerprints

You can delete registered fingerprints.

- 1 On the Settings screen, tap **Biometrics and security** → **Fingerprints**.
- 2 Unlock the screen using the preset screen lock method.
- 3 Select a fingerprint to delete and tap **Remove**.

## Samsung Pass

Register your biometric data to Samsung Pass and easily verify your identity when using services which require your login or personal information.



- The website sign-in feature is only available for websites that you access via the **Internet** app. Some websites may not support this feature.
- Registered biometric data is only saved to your device and is not synced with other devices or servers.

### Registering Samsung Pass

Before using Samsung Pass, register your biometric data to Samsung Pass.

On the Settings screen, tap **Biometrics and security** → **Samsung Pass**. Follow the on-screen instructions to complete the setup.

### Verifying the Samsung account password

You can use your registered biometric data to verify your identity instead of entering your Samsung account password when, for example, you purchase content from **Galaxy Store**.

On the Samsung Pass main screen, tap  → **Settings** → **Account and syncing**, and then tap the **Verify with Samsung Pass** switch to activate it.

### Using Samsung Pass to sign in to websites

You can use Samsung Pass to easily sign in to websites that support ID and password autofill.

- 1 On the sign-in page of the website, enter your ID and password, and then tap the website's sign-in button.
- 2 When a pop-up window asking whether you want to save the sign-in information appears, tick **Sign in with Samsung Pass** and tap **Remember**.

### Using Samsung Pass to sign in to apps

You can use Samsung Pass to easily sign in to apps that support ID and password autofill.

- 1 On the sign-in page of the app, enter your ID and password, and then tap the app's sign-in button.
- 2 When a pop-up window asking whether you want to save the sign-in information appears, tap **Save**.

## Managing sign-in information

View the list of websites and apps you have set to use Samsung Pass and manage your sign-in information.

- 1 On the Samsung Pass main screen, tap **Apps** or **Websites** and select a website or app from the list.
- 2 Tap **Edit** and modify your ID, password, and the website's or app's name.  
To delete your sign-in information, tap **Delete**.

## Using Samsung Pass with websites and apps

When using websites or apps that support Samsung Pass, you can easily sign in with Samsung Pass.

To see the list of websites and apps that support Samsung Pass, on the Samsung Pass main screen, tap  → **Settings** → **Partners**. If there are no websites or apps that support Samsung Pass, **Partners** will not appear.



- Available websites and apps may vary depending on the service provider or model.
- Samsung is not responsible for any loss or inconvenience caused by signing in to websites or apps via Samsung Pass.

## Entering your personal information automatically

You can use Samsung Pass to easily enter your personal information, such as your address or payment card information, on apps that support autofill.

- 1 On the Samsung Pass main screen, select an option under **Private info**.
- 2 Enter the information and tap **Save**.  
You can now use the biometric data you registered to Samsung Pass when entering the personal information automatically on supported apps.



## Using a digital key with Samsung Pass

Register your vehicle's digital key to your smartphone so you can unlock or lock the vehicle's door and start the vehicle.

Start registering a digital key by installing your vehicle's digital key app or using the guide message, such as an email or text message, sent by your vehicle's manufacturer. Then, follow the on-screen instructions on your vehicle's navigation screen and your smartphone's Samsung Pass screen to complete the registration.

-  • This feature may not be available depending on the region.
- To use this feature, the vehicle must support the digital key function. Check with your vehicle's manufacturer for digital key support.
- The registered digital key is only saved to your smartphone and, if the smartphone is replaced, the digital key must be registered again.

## Using a digital key with the NFC feature

Touch the NFC antenna area of the smartphone with the digital key registered to the vehicle's door. The door will unlock or lock.

After you place the smartphone on the vehicle's wireless charging pad and the digital key is authenticated, you can start the vehicle using the start button.

-  • To use this feature, the smartphone and vehicle must support the NFC feature.
- To activate the NFC feature on the smartphone, launch the **Settings** app, tap **Connections** → **NFC and contactless payments**, and then tap the switch to activate it.
- To find out the location of the wireless charging pad and which of your vehicle's doors support NFC, refer to your vehicle's user manual.

## Using a digital key with the Ultra-Wideband (UWB) feature (Galaxy S22 Ultra, Galaxy S22+)

The vehicle's door will unlock when you get close to the vehicle with your smartphone, and will lock when you move away.

After the digital key is authenticated when you get inside the vehicle, you can start the vehicle using the start button.

-  • To use this feature, the smartphone and vehicle must support the Ultra-Wideband (UWB) feature.
- If the vehicle supports both the NFC and Ultra-Wideband (UWB) features, you can choose the method you want. Refer to your vehicle's user manual for more information.
- The Ultra-Wideband (UWB) feature may not be available depending on the region.

## Deleting the digital key

You can delete the registered digital key from your smartphone.

Launch the **Settings** app, tap **Biometrics and security** → **Samsung Pass**, tap the registered digital key, and then tap  → **Delete**.

## Deleting your Samsung Pass data

You can delete your biometric data, sign-in information, and app data registered to Samsung Pass.

On the Samsung Pass main screen, tap  → **Settings** → **See all devices using Samsung Pass** →  → **Leave Samsung Pass**.



-  • Your Samsung account will remain active.
- The Samsung Pass data on other devices signed in to your Samsung account will also be deleted.

## Secure Folder

Secure Folder protects your private content and apps, such as pictures and contacts, from being accessed by others. You can keep your private content and apps secure even when the device is unlocked.

-  Secure Folder is a separate, secured storage area. The data in Secure Folder cannot be transferred to other devices via unapproved sharing methods, such as USB or Wi-Fi Direct. Attempting to customise the operating system or modifying software will cause Secure Folder to be automatically locked and inaccessible. Before saving data in Secure Folder, make sure to back up a copy of the data in another secure location.

## Setting up Secure Folder

- 1 Launch the **Settings** app and tap **Biometrics and security** → **Secure Folder**.
- 2 Follow the on-screen instructions to complete the setup.  
The Secure Folder screen will appear and the Secure Folder app icon () will be added to the Apps screen.  
To change the name or icon of Secure Folder, tap  → **Customise**.

-  • When you launch the **Secure Folder** app, you must unlock the app using your preset lock method.
- If you forget your Secure Folder unlock code, you can reset it using your Samsung account. Tap the button at the bottom of the locked screen, and enter your Samsung account password.

## Setting an auto lock condition for Secure Folder

- 1 Launch the **Secure Folder** app and tap  → **Settings** → **Auto lock Secure Folder**.
- 2 Select a lock option.

 To manually lock your Secure Folder, tap  → **Lock and exit**.

## Moving content to Secure Folder

Move content, such as pictures and videos, to Secure Folder. The following actions are an example of moving an image from the default storage to Secure Folder.

- 1 Launch the **Secure Folder** app and tap  → **Add files**.
- 2 Tap **Images**, tick images to move, and then tap **Done**.
- 3 Tap **Move**.  
The selected items will be deleted from the original folder and moved to Secure Folder. To copy items, tap **Copy**.

 The method for moving content may vary depending on the content type.

## Moving content from Secure Folder

Move content from Secure Folder to the corresponding app in the default storage. The following actions are an example of moving an image from Secure Folder to the default storage.

- 1 Launch the **Secure Folder** app and tap **Gallery**.
- 2 Select an image and tap  → **Move out of Secure Folder**.  
The selected items will be moved to **Gallery** in the default storage.

## Adding apps

Add an app to use in Secure Folder.

- 1 Launch the **Secure Folder** app and tap **+**.
- 2 Tick one or more apps installed on the device and tap **Add**.

## Removing apps from Secure Folder

Tap and hold an app to delete, and tap **Uninstall**.

## Adding accounts

Add your Samsung and Google accounts, or other accounts, to sync with the apps in Secure Folder.

- 1 Launch the **Secure Folder** app and tap  → **Settings** → **Manage accounts** → **Add account**.
- 2 Select an account service.
- 3 Follow the on-screen instructions to complete the account setup.

## Hiding Secure Folder

You can hide the Secure Folder shortcut from the Apps screen.

Launch the **Secure Folder** app, tap  → **Settings**, and then tap the **Add Secure Folder to Apps screen** switch to deactivate it.

Alternatively, open the notification panel, swipe downwards, and then tap  (**Secure Folder**) to deactivate the feature. If you cannot find  (**Secure Folder**) on the quick panel, tap  and drag the button over to add it.

If you want to show the Secure Folder again, launch the **Settings** app, tap **Biometrics and security** → **Secure Folder**, and then tap the **Add Secure Folder to Apps screen** switch to activate it.

## Uninstalling Secure Folder

You can uninstall Secure Folder, including the content and apps in it.

Launch the **Secure Folder** app and tap  → **Settings** → **More settings** → **Uninstall**.

To back up content before uninstalling Secure Folder, tick **Move media files out of Secure Folder** and tap **Uninstall**. To access data backed up from Secure Folder, launch the **My Files** app and tap **Internal storage** → **Download** → **Secure Folder**.

 Notes saved in **Samsung Notes** will not be backed up.

## Secure Wi-Fi

Secure Wi-Fi is a service that secures your Wi-Fi network connection. It encrypts data using Wi-Fi networks and disables tracking apps and websites so that you can use Wi-Fi networks safely. For example, when using an unsecure Wi-Fi network in public places, such as cafes or airports, Secure Wi-Fi is automatically activated so that no one can hack your login information or monitor your activity in apps and websites.

On the Settings screen, tap **Biometrics and security** → **Secure Wi-Fi** and follow the on-screen instructions to complete the setup.

When Secure Wi-Fi is activated, the  icon will appear on the status bar.

-  • Using this feature may result in a slower Wi-Fi network speed.
- This feature may not be available depending on the Wi-Fi network, service provider, or model.

## Selecting apps to protect using Secure Wi-Fi

Select apps to protect using Secure Wi-Fi so that you can safely protect data, such as your password or your activity in apps, from being accessed by others.

On the Settings screen, tap **Biometrics and security** → **Secure Wi-Fi** →  → **Settings** → **Protected apps** and tap the switches next to the apps you want to protect using Secure Wi-Fi.

-  Some apps may not support this feature.

## Purchasing protection plan

You are provided with a free protection plan for Wi-Fi networks every month. You can also purchase paid protection plans and have unlimited bandwidth protection for a limited time.

1 On the Settings screen, tap **Biometrics and security** → **Secure Wi-Fi**.

2 Tap **Protection plan** → **Upgrade** and select the plan you want.

-  For certain protection plans, you can transfer the protection plan to another device signed in to your Samsung account.

3 Follow the on-screen instructions to complete the purchase.

## Privacy

Change the settings for privacy.

On the Settings screen, tap **Privacy**.

- **Permissions used in last 24 hours:** View the app or feature's permission usage history.
- **Permission manager:** View the list of features and apps that have permission to use them. You can also edit the permission settings.
- **Controls and alerts:** Configure settings for app access.
- **Samsung:** Manage personal data related to your Samsung account and change the settings for Customisation Service.
- **Google:** Configure advanced settings for privacy.



Some features may not be available depending on the service provider or model.

## Location

Change settings for location information permissions.

On the Settings screen, tap **Location**.

- **App permissions:** View the list of apps that have permission to access the device's location and edit the permission settings.
- **Location services:** View the location services your device is using.
- **Recent access:** View which apps request your current location information.

## Safety and emergency

Manage your medical information and emergency contacts. You can also change settings for emergency features, such as wireless emergency alerts.

On the Settings screen, tap **Safety and emergency**.

- **Medical info:** Enter your medical information.
- **Emergency contacts:** Enter your emergency contacts.
- **Send SOS messages:** Set the device to send help messages by pressing the Side key several times.
- **Wireless emergency alerts:** Change the settings for wireless emergency alerts.
- **Emergency Location Service:** Activate the Emergency Location Service (ELS) feature.
- **Emergency mode:** Switch the device to emergency mode to reduce battery consumption. Refer to [Emergency mode](#) for more information.

 Some features may not be available depending on the model.

## Accounts and backup

### Options

Sync, back up, or restore your device's data using Samsung Cloud. You can also sign in to accounts, such as your Samsung account or Google account, or transfer data to or from other devices via Smart Switch.

On the Settings screen, tap **Accounts and backup**.

- **Manage accounts:** Add your Samsung and Google accounts, or other accounts, to sync with.
- **Samsung Cloud:** Back up your data and settings, and restore the previous device's data and settings even when you do not have it. Refer to [Samsung Cloud](#) for more information.
- **Google Drive:** Keep your personal information, app data, and settings safe on your device. You can back up your sensitive information. You must sign in to your Google account to back up data.

- **Smart Switch:** Launch Smart Switch and transfer data from your previous device. Refer to [Transferring data from your previous device \(Smart Switch\)](#) for more information.



Regularly back up your data to a safe location, such as Samsung Cloud or a computer, so that you can restore it if the data is corrupted or lost due to an unintended factory data reset.

## Samsung Cloud

Back up your device's data to Samsung Cloud and restore it later.

### Backing up data

You can back up your device's data to Samsung Cloud.

- 1 On the Settings screen, tap **Accounts and backup** and tap **Back up data** under **Samsung Cloud**.
- 2 Tap the switches next to the items you want to back up and tap **Back up now**.
- 3 Tap **Done**.



- Some data will not be backed up. To check which data will be backed up, on the Settings screen, tap **Accounts and backup** and tap **Back up data** under **Samsung Cloud**.
- To view the backup data for other devices in your Samsung Cloud, on the Settings screen, tap **Accounts and backup** → **Restore data**, and then select a device you want.

### Restoring data

You can restore your backup data from Samsung Cloud to your device.

- 1 On the Settings screen, tap **Accounts and backup**.
- 2 Tap **Restore data** and select a device you want.
- 3 Tick items you want to restore and tap **Restore**.

## Google

Configure settings for some features provided by Google.

On the Settings screen, tap **Google**.



# Advanced features

## Options



Activate advanced features and change the settings that control them.

On the Settings screen, tap **Advanced features**.

- **Link to Windows:** Instantly access data saved in your device on your computer. Refer to [Link to Windows](#) for more information.
- **Call & text on other devices:** Use your device's calling and messaging features on other devices signed in to your Samsung account.
- **Continue apps on other devices:** Use your device's apps on other devices signed in to your Samsung account.
- **Samsung DeX:** Set the device to use like a computer. Refer to [Samsung DeX](#) for more information.
- **Android Auto:** Connect your device to a vehicle and control some of your device's features on the vehicle's display.
- **Quick Share:** Change the Quick Share settings. Refer to [Quick Share](#) for more information.
- **Labs:** Use new features of the device.
- **S Pen:** Change the settings for using the S Pen. Refer to [S Pen \(Galaxy S22 Ultra\)](#) for more information.
- **Side key:** Select an app or feature to launch using the Side key. Refer to [Setting the Side key](#) for more information.
- **Motions and gestures:** Activate the motion feature and configure settings. Refer to [Motions and gestures](#) for more information.
- **One-handed mode:** Activate one-handed operation mode for your convenience when using the device with one hand.
- **Bixby Routines:** Add routines to automate settings that you use repeatedly. The device also suggests useful routines according to your frequent situations. Refer to [Bixby Routines](#) for more information.
- **Smart suggestions:** Set the device to analyse key information in the selected text or received message, such as events and addresses, and suggest that they be added as events to the calendar or to use related apps. You can also get suggestions for useful actions or text to enter based on your app usage history. When you receive smart suggestions, the ✨ icon will appear.



Collected information is stored and used only in this device to protect your personal information.

- **Screenshots and screen recorder:** Change the settings for screenshots and screen recorder.
- **Show contacts when sharing content:** Set the device to display the people you contacted on the sharing options panel to allow you to share content directly.
- **Video call effects:** Set to use the feature that changes the background or block background noise during video calls. Refer to [Video call effects](#) for more information.
  -  • This feature is only available in some apps.
  - Some features may not be available depending on the model.
- **Game Launcher:** Activate the Game Launcher. Refer to [Game Launcher](#) for more information.
- **Video brightness:** Enhance the image quality of your videos to enjoy brighter and more vivid colours.
  -  This feature may not be available in some apps.
- **Dual Messenger:** Install the second app and use two separate accounts for the same messenger app. Refer to [Dual Messenger](#) for more information.
  -  Some features may not be available depending on the service provider or model.

## Motions and gestures

Activate the motion feature and configure settings.

On the Settings screen, tap **Advanced features** → **Motions and gestures**.

- **Lift to wake:** Set the device to turn on the screen when you pick it up.
- **Double tap to turn on screen:** Set the device to turn on the screen by double-tapping anywhere on the screen while the screen is turned off.
- **Double tap to turn off screen:** Set the device to turn off the screen by double-tapping an empty area on the Home screen or the locked screen.
- **Keep screen on while viewing:** Set the device to prevent the display from turning off while you are looking at it.
- **Alert when phone picked up:** Set the device to alert you if you have missed calls or new messages when you pick up the device.
  -  This feature may not work if the screen is turned on or the device is not on a flat surface.

- **Mute with gestures:** Set the device to mute certain sounds by using motions or gestures.
- **Palm swipe to capture:** Set the device to capture a screenshot when you swipe your hand to the left or right across the screen. You can view the captured images in **Gallery**. It is not possible to capture a screenshot while using some apps and features.

 Excessive shaking or an impact to the device may cause an unintended input for some features using sensors.

## Video call effects

You can use features that change the background or block background noise during video calls.

On the Settings screen, tap **Advanced features** → **Video call effects** and tap the switch to activate it. The  icon will be added on the video calling app's screen.

### Using video call effects

On the video calling app's screen, tap .

- **Reset all:** Reset the settings.
- **Background:** Change or blur the background during video calls.
- **Auto framing:** Activate or deactivate the auto framing feature. When you activate this feature, the device changes the shooting angle and zoom automatically by recognising and tracking people during video calls.
- **Mic mode:** Block background noise to make the sound clearer.
  - **Standard:** Remove noise so that it sounds like a normal voice call.
  - **Voice focus:** Focus on the sound coming from the direction of the front camera.
  - **All sound:** Transmit all the sounds around you, such as the sound of music.
- **Settings:** Select or add background colours or images to use during video calls.



- Some features may not be available depending on the model.
- Some features are available only when using the front camera.

## Dual Messenger

Install the second app and use two separate accounts for the same messenger app.

- 1 On the Settings screen, tap **Advanced features** → **Dual Messenger**.  
Supported apps will appear.
- 2 Tap the switch of an app to install the second app.  
The second app will be installed. The second app's icon will be displayed with .



-  • The Dual Messenger feature may not be available depending on the app.
- Some features of the app may be limited for the second app.

## Uninstalling a second app

- 1 On the Settings screen, tap **Advanced features** → **Dual Messenger**.
  - 2 Tap the switch of the app you want to uninstall and tap **Uninstall**.  
All data related to the second app will be deleted.
-  If you uninstall the first app, the second app will also be deleted.

## Digital Wellbeing and parental controls

View the history of your device usage and use features to prevent your device from interfering with your life. You can also set up parental controls for your children and manage their digital use.

On the Settings screen, tap **Digital Wellbeing and parental controls**.

- **Screen time:** Set goals for how much you use your device a day.
- **App timers:** Limit the daily usage time for each app by setting a timer. When you reach the limit, the app will be deactivated and you cannot use it.
- **Focus mode:** Activate focus mode to avoid distractions from your device and stay focused on what you want. You can use the apps you allowed to be used in focus mode.
- **Bedtime mode:** Activate bedtime mode to reduce eye strain before sleeping and prevent your sleep from being disturbed.
- **Volume monitor:** Activate the volume monitor to protect your hearing.
- **Driving monitor:** Activate the driving monitor to monitor the amount of the time you use your device while driving.
- **Parental controls:** Manage your children's digital use.

## Battery and device care

### Introduction

The device care feature provides an overview of the status of your device's battery, storage, memory, and system security. You can also automatically optimise the device with a tap of your finger.

### Optimising your device

On the Settings screen, tap **Battery and device care** → **Optimise now**.

The quick optimisation feature improves device performance through the following actions.

- Closing apps running in the background.
- Managing abnormal battery usage.
- Scanning for crashed apps and malware.

## Using the auto optimisation feature

You can set the device to perform auto optimisation when your device is not in use. Tap  → **Automation** → **Auto optimise daily** and tap the switch to activate it. If you want to set the time to perform auto optimisation, tap **Time**.

## Battery

Check the remaining battery power and time to use the device. For devices with low battery levels, conserve battery power by activating power saving features.

On the Settings screen, tap **Battery and device care** → **Battery**.

- **Power saving:** Activate power saving mode to extend the battery's usage time.
- **Background usage limits:** Limit battery usage for apps that you do not use often.
- **Wireless power sharing:** Charge another device with your device's battery. Refer to [Wireless power sharing](#) for more information.
- **More battery settings:** Configure advanced settings for the battery.



- The usage time left shows the time remaining before the battery power runs out. Usage time left may vary depending on your device settings and operating conditions.
- You may not receive notifications from some apps that use power saving mode.

## Storage

Check the status of the used and available memory.

On the Settings screen, tap **Battery and device care** → **Storage**. To delete files or uninstall apps that you do not use anymore, select a category. Then, tap and hold, or select, an item and tap **Delete** or **Uninstall**.



- The actual available capacity of the internal memory is less than the specified capacity because the operating system and default apps occupy part of the memory. The available capacity may change when you update the device.
- You can view the available capacity of the internal memory in the Specification section for your device on the Samsung website.

## Memory

On the Settings screen, tap **Battery and device care** → **Memory**.

To speed up your device by stopping apps running in the background, tick apps from the apps list, and tap **Clean now**.

## Device protection

Check the device's security status. This feature scans your device for malware.

On the Settings screen, tap **Battery and device care** → **Device protection** → **Scan phone**.

## Software update

Update your device's software via the firmware over-the-air (FOTA) service. You can also schedule software updates.

On the Settings screen, tap **Battery and device care** → **Software update**.

## Diagnostics

Test your device using Samsung Members.

On the Settings screen, tap **Battery and device care** → **Diagnostics**. Select an item to test or tap **Test all** to test all items.

## Apps

Manage the device's apps and change their settings. You can view the apps' usage information, change their notification or permission settings, or uninstall or disable unnecessary apps.

On the Settings screen, tap **Apps**.

## General management

Customise your device's system settings or reset the device.

On the Settings screen, tap **General management**.

- **Language:** Select device languages. Refer to [Adding device languages](#) for more information.
- **Text-to-speech output:** Change the settings for text-to-speech features used when TalkBack is activated, such as languages, speed, and more.
- **Date and time:** Access and alter the settings to control how the device displays the time and date.
  -  If the battery remains fully discharged, the time and date is reset.
- **Samsung Keyboard settings:** Change the settings for the Samsung keyboard.
- **Keyboard list and default:** Select a keyboard to use by default and change the keyboard settings.
- **Physical keyboard:** Change the settings for an external keyboard.
- **Mouse and trackpad:** Change the settings for an external mouse or trackpad.
- **Passwords and autofill:** Select an autofill service to use.
- **Reset:** Reset your device's settings or perform a factory data reset.
- **Customisation Service:** Set to get personalised service based on your interests and how you use your device.
- **Contact us:** Ask questions or view frequently asked questions.

### Adding device languages

You can add languages to use on your device.

1 On the Settings screen, tap **General management** → **Language** → **Add language**.

To view all the languages that can be added, tap  → **All languages**.

2 Select a language to add.

3 To set the selected language as the default language, tap **Set as default**. To keep the current language setting, tap **Keep current**.

The selected language will be added to your languages list. If you changed the default language, the selected language will be added to the top of the list.

To change the default language from your languages list, select the language you want and tap **Apply**. If an app does not support the default language, the next supported language in the list will be used.



## Accessibility

Configure various settings to improve accessibility to the device. Refer to [Accessibility](#) for more information.

On the Settings screen, tap **Accessibility**.

## Software update

Update your device's software via the firmware over-the-air (FOTA) service. You can also schedule software updates.

On the Settings screen, tap **Software update**.

- **Download and install:** Check for and install updates manually.
- **Auto download over Wi-Fi:** Set the device to download updates automatically when connected to a Wi-Fi network.
- **Last update:** View information about the last software update.

 If emergency software updates are released for your device's security and to block new types of security threats, they will be installed automatically without your agreement.

### Security updates information

Security updates are provided to strengthen the security of your device and protect your personal information. For security updates for your model, visit [security.samsungmobile.com](https://security.samsungmobile.com).

 The website supports only some languages.

## About phone

Access your device's information.

On the Settings screen, tap **About phone**.

To change your device's name, tap **Edit**.

- **Status information:** View various device information, such as the SIM card status, Wi-Fi MAC address, and serial number.
- **Legal information:** View legal information related to the device, such as safety information and the open source licence.
- **Software information:** View the device's software information, such as its operating system version and firmware version.
- **Battery information:** View the device's battery status and information.

# Usage notices

## Precautions for using the device

Please read this manual when using the device to ensure safe and proper use.

- Descriptions are based on the device's default settings.
- Some content may differ from your device depending on the region, service provider, model specifications, or device's software.
- The device may require a connection to a Wi-Fi or mobile network when using some apps or features.
- Content (high quality content) that requires high CPU and RAM usage will affect the overall performance of the device. Apps related to the content may not work properly depending on the device's specifications and the environment that it is used in.
- Samsung is not liable for performance issues caused by apps supplied by providers other than Samsung.
- Samsung is not liable for performance issues or incompatibilities caused by edited registry settings or modified operating system software. Attempting to customise the operating system may cause the device or apps to work improperly.
- Software, sound sources, wallpapers, images, and other media provided with this device are licensed for limited use. Extracting and using these materials for commercial or other purposes is an infringement of copyright laws. Users are entirely responsible for illegal use of media.
- You may incur additional charges for data services, such as messaging, uploading and downloading, auto-syncing, or using location services depending on your data plan. For large data transfers, it is recommended to use the Wi-Fi feature.
- Default apps that come with the device are subject to updates and may no longer be supported without prior notice.
- Modifying the device's operating system or installing software from unofficial sources may result in device malfunctions and data corruption or loss. These actions are violations of your Samsung licence agreement and will void your warranty.

- You can see the touchscreen clearly even in strong outdoor sunlight by automatically adjusting the contrast range based on the surrounding environment. Due to the nature of the product, displaying fixed graphics for extended periods may result in afterimages (screen burn-in) or ghosting.
  - It is recommended not to use fixed graphics on part or all of the touchscreen for extended periods and turn off the touchscreen when not using the device.
  - You can set the touchscreen to turn off automatically when you are not using it. Launch the **Settings** app, tap **Display** → **Screen timeout**, and then select the length of time you want the device to wait before turning off the touchscreen.
  - To set the touchscreen to automatically adjust its brightness based on the surrounding environment, launch the **Settings** app, tap **Display**, and then tap the **Adaptive brightness** switch to activate it.

- Depending on the region or model, some devices are required to receive approval from the Federal Communications Commission (FCC).

If your device is approved by the FCC, you can view the FCC ID of the device. To view the FCC ID, launch the **Settings** app and tap **About phone** → **Status information**. If your device does not have an FCC ID, it means that the device has not been authorised for sale in the U.S. or its territories and may only be brought to the U.S. for the owner's personal use.

- The use of mobile devices on aeroplanes or ships may be subject to federal and local guidelines and restrictions. The use of Ultra-Wideband (UWB) transmitters is prohibited when aboard an aeroplane or ship. Flight mode will disable UWB. Check with appropriate authorities and always follow crew instructions regarding when and how you may use your device. (Galaxy S22 Ultra, Galaxy S22+)
- The use of Ultra-Wideband (UWB) transmitters is prohibited when activated within a nominated distance of a specified Australian radio astronomy site. (Check the Radio communications Class Licence 2015 published by the Australian Communications and Media Authority for further details). How to turn off UWB: Turn on flight mode. (Galaxy S22 Ultra, Galaxy S22+)
- Depending on the region, you can view the regulatory information on the device. To view the information, launch the **Settings** app and tap **About phone** → **Regulatory information**.
- The bandwidths supported by the device may vary depending on the region or service provider.
- 5G network availability may vary depending on the country, network provider, and user environment.

- Your device contains magnets. Keep a safe distance between your device and objects that may be affected by magnets such as credit cards and implantable medical devices. If you have an implantable medical device, consult your physician before use.

## Instructional icons



**Warning:** situations that could cause injury to yourself or others



**Caution:** situations that could cause damage to your device or other equipment



**Notice:** notes, usage tips, or additional information

## Notes on package contents and accessories

Refer to the quick start guide for package contents.

- The items supplied with the device and any available accessories may vary depending on the region or service provider.
- The supplied items are designed only for this device and may not be compatible with other devices.
- Appearances and specifications are subject to change without prior notice.
- You can purchase additional accessories from your local Samsung retailer. Make sure they are compatible with the device before purchase.
- Use only Samsung-approved accessories. Using unapproved accessories may cause the performance problems and malfunctions that are not covered by the warranty.
- Availability of all accessories is subject to change depending entirely on manufacturing companies. For more information about available accessories, refer to the Samsung website.
- Earphones (USB Type-C) that support digital output can be used with the device. However, the device may not be compatible with earphones that use a different audio output method or were made by a different manufacturer.

## Maintaining water and dust resistance

This device has been tested in a controlled environment and received the IP68 rating under the IEC 60529 standard from an accredited testing lab. (Test conditions: fresh water, 1.5 m, 30 minutes, 15-35 °C, 86-106 kPa)

You must follow the guidelines below to maintain the water- and dust-resistance of your device.

- Do not immerse the device in water deeper than 1.5 m for more than 30 minutes.
- Do not expose the device to unclean water or other liquids, such as salty water, swimming pool water, soapy water, oil, perfume, sunscreen, hand cleaner, chemical products such as cosmetics, or liquids that include the alcohol.
- Do not expose the device to water moving with force.
- Do not use the device in places where the temperature is higher than the normal range or there is a lot of humidity, such as a sauna.
- Do not drop the device or subject it to a heavy impact.

If the device is exposed to water or pollutants, follow the guidelines below:

- Wipe the device with a soft and clean cloth, drying it thoroughly.
- If the microphone or speaker is not completely dry, it may result in the sound not being clear during a call.
- The touchscreen and other features may not work properly if the device is used in water.
- Do not connect the charger or any accessories until the device is completely dry. The device can be damaged if an accessory or charger is connected when the multipurpose jack is not yet dry.

## Device overheating situations and solutions

### When the device heats up while charging the battery

While charging, the device and the charger may become hot. During wireless charging or fast charging, the device may feel hotter to the touch. This does not affect the device's lifespan or performance and is in the device's normal range of operation. If the battery becomes too hot, the charging speed may decrease or the charger may stop charging.

#### Do the following when the device heats up:

- Disconnect the charger from the device and close any running apps. Wait for the device to cool down and then begin charging the device again.
- If the lower part of the device overheats, it could be because the connected USB cable is damaged. Replace the damaged USB cable with a new Samsung-approved one.
- When using a wireless charger, do not place foreign materials, such as metal objects, magnets, and magnetic stripe cards, between the device and the wireless charger.



The wireless charging or fast charging feature is only available on supported models.

### When the device heats up during use

When you use features or apps that require more power or use them for extended periods, your device may temporarily heat up due to increased battery consumption. Close any running apps and do not use the device for a while.

Refer to the following examples of situations in which the device may overheat.

- During the initial setup after purchase or when restoring data
- When downloading large files
- When using apps that require more power or using apps for extended periods
  - When playing high-quality games for extended periods
  - When recording videos for extended periods
  - When streaming videos while using the maximum brightness setting
  - When connecting to a TV



- While multitasking (or, when running many apps in the background)
  - When using Multi window
  - When updating or installing apps while recording videos
  - When downloading large files during a video call
  - When recording videos while using a navigation app
- When using large amount of data for syncing with the cloud, email, or other accounts
- When using a navigation app in a car while the device is placed in direct sunlight
- When using the mobile hotspot and tethering feature
- When using the device in areas with weak signals or no reception
- When charging the battery with a damaged USB cable
- When the device's multipurpose jack is damaged or exposed to foreign materials, such as liquid, dust, metal powder, and pencil lead
- When you are roaming

### **Do the following when the device heats up:**

- Keep the device updated with the latest software.
- Conflicts between running apps may cause the device to heat up. Restart the device.
- Deactivate the Wi-Fi, GPS, and Bluetooth features when not using them.
- Close apps that increase battery consumption or that run in the background when not in use.
- Delete unnecessary files or unused apps.
- Decrease the screen brightness.
- If the device overheats or feels hot for a prolonged period, do not use it for a while. If the device continues to overheat, contact a Samsung Service Centre.

## Precautions for device overheating

If you begin to feel uncomfortable due to the device overheating, stop using the device.

When the device heats up, the features and performance may be limited or the device may turn off to cool down. The feature is only available on supported models.

- If the device overheats and reaches a certain temperature, a warning message will appear to prevent device failure, skin irritations and damages, and battery leakage. To lower the device's temperature, the screen brightness and the performance speed will be limited and battery charging will stop. Running apps will be closed and all calling and other features will be limited, except for emergency calls, until the device cools down.
- If the second message appears due to a further increase of the device's temperature, the device will turn off. Do not use the device until the device's temperature drops below the specified level. If the second warning message appears during an emergency call, the call will not be disconnected by a forced shut down.

## Precautions for operating environment

Your device may heat up due to the environment in the following conditions. Use caution to avoid shortening the battery's lifespan, damaging the device, or causing a fire.

- Do not store your device in very cold or very hot temperatures.
- Do not expose your device to direct sunlight for extended periods.
- Do not use or store your device for extended periods in very hot areas, such as inside a car in the summertime.
- Do not place the device in any areas that may overheat, such as on an electric heating mat.
- Do not store your device near or in heaters, microwaves, hot cooking equipment, or high pressure containers.
- Do not use a cable whose covering is peeled off or damaged, and do not use any charger or battery that is damaged or malfunctioning.

# Appendix

## Accessibility

### About Accessibility

Improve accessibility with features that make the device easier to use for users who have impaired vision, hearing, and reduced dexterity.

Launch the **Settings** app and tap **Accessibility**. To check recommended features and the accessibility features you are using, tap **Recommended for you**. To disable the features in use, tap **Turn off**.

### TalkBack (Voice feedback)

#### Activating or deactivating TalkBack

When you activate TalkBack, the device will start voice feedback. When you tap the selected feature once, the device will read the text on the screen aloud. Tapping the feature twice will activate the feature.

Launch the **Settings** app, tap **Accessibility** → **TalkBack**, and then tap the switch to activate it. To deactivate TalkBack, tap the switch and tap anywhere on the screen twice quickly.

To view how to use TalkBack, tap **Settings** → **Tutorial and help**.

 Some features are not available while you are using TalkBack.

#### Controlling the screen with finger gestures

You can use various finger gestures to control the screen while you are using TalkBack.

To view and customise available finger gestures, launch the **Settings** app and tap **Accessibility** → **TalkBack** → **Settings** → **Customise gestures**.

## Using the reading menu

While you are using TalkBack, swipe to the left or right with three fingers. The reading menu will appear and the device will read the options aloud. Swipe to the left or right with three fingers to scroll through the options. When you hear the option you want, swipe upwards or downwards to use the option or adjust the settings for the option. For example, when you hear **Speech rate**, you can adjust the speech rate by swiping upwards or downwards.

## Adding and managing image labels

You can assign labels to images on the screen. The device reads aloud the labels when the images are selected. Add labels to unlabelled images by swiping upwards or downwards, then to the right. Then, tap **Add label** when the TalkBack menus appear.

To manage the labels, launch the **Settings** app and tap **Accessibility** → **TalkBack** → **Settings** → **Advanced settings** → **Custom labels**.

## Configuring settings for TalkBack

Configure settings for TalkBack for your convenience.

Launch the **Settings** app and tap **Accessibility** → **TalkBack** → **Settings**.

- **New features in TalkBack:** Check for key updates and changes to TalkBack.
- **Text-to-speech settings:** Change the settings for text-to-speech features used when TalkBack is activated, such as languages, speed, and more.
- **Verbosity:** Customise the detailed settings for voice feedback.
- **Speak passwords:** Set the device to read the characters aloud when you enter your password. If you deactivate this feature, the device will only read the password aloud when you are using earphones.
- **Sound and vibration:** Change sound settings for TalkBack.
- **Customise focus indicator:** Set the device to thicken the border of the focus indicator that appears when you tap items. You can also change the colour of the indicator.
- **Customise gestures:** View various finger gestures to control the screen while you are using TalkBack and customise the settings for gestures.
- **Customise menus:** Select which TalkBack menus and reading menus to use.
- **Braille keyboard:** Easily enter letters and numbers on the screen using a 6-dot braille keyboard.

- **Tutorial and help:** Learn how to use TalkBack.
- **Advanced settings:** Configure advanced settings for TalkBack.
- **Open TalkBack in the Galaxy Store:** Launch TalkBack from the **Galaxy Store** and check for updates.

## Entering text using the keyboard

To display the keyboard, tap the text input field, and then tap anywhere on the screen twice quickly.

To activate the rapid key input feature, launch the **Settings** app and tap **Accessibility** → **TalkBack** → **Settings** → **Advanced settings** → **Typing preference** → **Hold finger to select key, then lift**.

When you touch the keyboard with your finger, the device reads aloud the character keys under your finger. When you hear the character you want, release your finger from the screen to select it. The character is entered and the device reads the text aloud.

If **Hold finger to select key, then double-tap** is selected, release your finger from the character you want, and then tap anywhere on the screen twice quickly.

## Entering additional characters

Tap and hold a key on the keyboard to enter additional characters available for the key. A pop-up window appears above the key showing available characters. To select a character, drag your finger on the pop-up window until you hear the character you want, and release it.

## Visibility enhancements

### Display mode

Change the display mode.

Launch the **Settings** app, tap **Accessibility** → **Visibility enhancements**, and then select a mode you want under **Display mode**.

### Using the high contrast theme

Apply a clear theme that displays light-coloured content on a dark background.

Launch the **Settings** app, tap **Accessibility** → **Visibility enhancements** → **High contrast theme**, and then select a theme you want.

## Using the high contrast font

Adjust the colour and outline of fonts to increase the contrast between the text and the background.

Launch the **Settings** app, tap **Accessibility** → **Visibility enhancements**, and then tap the **High contrast fonts** switch to activate it.

## Using the high contrast keyboard

Change the colours of the Samsung keyboard to increase the contrast between the text and the background.

Launch the **Settings** app, tap **Accessibility** → **Visibility enhancements**, and then tap the **High contrast keyboard** switch to activate it.

## Displaying button shapes

Display button shapes with frames to make them stand out.

Launch the **Settings** app, tap **Accessibility** → **Visibility enhancements**, and then tap the **Highlight buttons** switch to activate it.

## Reversing the display colours

Improve screen visibility to help users recognise text on the screen more easily.

Launch the **Settings** app, tap **Accessibility** → **Visibility enhancements**, and then tap the **Colour inversion** switch to activate it.

## Colour adjustment

Adjust how colours are displayed on the screen if you have difficulty in distinguishing colours. The device changes the colours into more recognisable colours.

Launch the **Settings** app, tap **Accessibility** → **Visibility enhancements** → **Colour adjustment**, and then tap the switch to activate it. Select an option.

To adjust the intensity of colour, drag the adjustment bar under **Intensity**.

If you select **Personalised colour**, you can personalise the colour of the screen. Follow the on-screen instructions to complete the colour adjustment procedure.

## Add colour filter

Adjust the screen colours if you have difficulty in reading the text.

Launch the **Settings** app, tap **Accessibility** → **Visibility enhancements** → **Add colour filter**, and then tap the switch to activate it. Select a colour you want.

To adjust the transparency level, drag the adjustment bar under **Opacity**.

## Reducing screen motion effects

Reduce animation effects if you are sensitive to animations or screen movement.

Launch the **Settings** app, tap **Accessibility** → **Visibility enhancements**, and then tap the **Remove animations** switch to activate it.

## Reducing transparency and blur effects

Reduce the transparency and blur effects to make the content on the screen more visible.

Launch the **Settings** app, tap **Accessibility** → **Visibility enhancements**, and then tap the **Reduce transparency and blur** switch to activate it.

## Dimming the screen

Dim the screen below the minimum brightness setting for a more comfortable viewing experience.

Launch the **Settings** app, tap **Accessibility** → **Visibility enhancements**, and then tap the **Extra dim** switch to activate it.

## Magnifying the screen

Magnify the screen and zoom in on a specific area.

Launch the **Settings** app, tap **Accessibility** → **Visibility enhancements** → **Magnification** → **Magnification shortcut**, and then tap the switch to activate it. Then tick the actions to use to start using this feature directly.

- **Tap Accessibility button:** Zoom in by tapping  on the navigation bar, and then tapping where you want to magnify the screen. To temporarily magnify the screen, tap and hold where you want to magnify the screen.
- **Press and hold Volume up and down keys for 3 seconds:** Zoom in by pressing and holding the Volume Up key and the Volume Down key simultaneously for 3 seconds, and then tapping where you want to magnify the screen. To temporarily magnify the screen, tap and hold where you want to magnify the screen.

- **Press Side and Volume up keys:** Zoom in by pressing the Side key and the Volume Up key simultaneously, and then tapping where you want to magnify the screen. To temporarily magnify the screen, tap and hold where you want to magnify the screen.
- **Triple-tap screen:** Zoom in by tapping the screen three times. To temporarily magnify the screen, tap the screen three times and hold.

To magnify only a portion of the screen using the magnifier window, tap . To move the magnifier, drag the edge of the magnifier frame.

To explore the screen, drag two fingers across the magnified screen.

To adjust zoom ratio, pinch two fingers on the magnified screen or spread them apart.



- Keyboards and the navigation bar on the screen cannot be magnified.
- When this feature is activated, the performance of some apps may be affected.

## Enlarging mouse or touchpad pointers

Enlarge the pointer when using an external mouse or touchpad.

Launch the **Settings** app, tap **Accessibility** → **Visibility enhancements**, and then tap the **Large mouse/touchpad pointer** switch to activate it.

## Changing font

Change the font size and style.

Launch the **Settings** app and tap **Accessibility** → **Visibility enhancements** → **Font size and style**.

## Changing screen zoom

Make the items on the screen larger or smaller.

Launch the **Settings** app and tap **Accessibility** → **Visibility enhancements** → **Screen zoom**.



## Hearing enhancements

### Live Transcribe

Set the device to capture speech using the device's microphone and convert it to on-screen text.

Launch the **Settings** app, tap **Accessibility** → **Hearing enhancements** → **Live Transcribe** → **Live Transcribe shortcut**, and then tap the switch to activate it. Then, tap  to transcribe speech.

### Live Caption

Set the device to detect speech and automatically generate captions when you play media content, such as videos or podcasts.

Launch the **Settings** app, tap **Accessibility** → **Hearing enhancements** → **Live Caption**, and then tap the **Use Live Caption** switch to activate it.

### Caption settings



Launch the **Settings** app, tap **Accessibility** → **Hearing enhancements** → **Caption preference**, and then tap the **Show captions** switch to activate it.

Select an option for configuring the caption settings.

### Sound notifications

Set the device to detect sounds, such as the beeping of smoke detectors or crying babies. The device will vibrate when it detects sound and the alert will be saved as a log.

 While this feature is enabled, the voice recognition will not operate.

- 1 Launch the **Settings** app and tap **Accessibility** → **Hearing enhancements** → **Sound notifications** → **Open Sound notifications**.
- 2 Follow the on-screen instructions to activate the sound notification feature.  
When sound is detected, the log will be displayed on the timeline. To view the log, tap .
- 3 If you want to deactivate this feature, tap  and tap the **Sound notifications are active** switch to deactivate it.

## Hearing aid support

Set the device to enhance the sound quality to work better with hearing aids.

Launch the **Settings** app, tap **Accessibility** → **Hearing enhancements** → **Hearing aid support**, and then tap the **Hearing aid compatibility** switch to activate it.

## Amplify ambient sound

Set the device to amplify the sound around you to help you hear better when using an earphone.

- 1 Launch the **Settings** app, tap **Accessibility** → **Hearing enhancements** → **Amplify ambient sound**, and then tap the **Amplify ambient sound shortcut** switch to activate it.
- 2 Connect an earphone to the device and wear it.
- 3 Tap .

## Adapt sound

Optimise the sound setting to find the best sound quality and use it for calls or media playback.

Launch the **Settings** app, tap **Accessibility** → **Hearing enhancements** → **Adapt sound**, and then optimise the sound setting.

## Turning off all sounds

Set the device to mute all device sounds, such as media sounds, and the caller's voice during a call.

Launch the **Settings** app, tap **Accessibility** → **Hearing enhancements**, and then tap the **Mute all sounds** switch to activate it.

## Mono audio

Mono output combines stereo sound into one signal that is played through all earphone speakers. Use this if you have a hearing impairment or if a single earbud is more convenient.

Launch the **Settings** app, tap **Accessibility** → **Hearing enhancements**, and then tap the **Mono audio** switch to activate it.

## Adjusting the sound balance

Set the device to adjust the sound balance.

- 1 Launch the **Settings** app and tap **Accessibility** → **Hearing enhancements**.
- 2 Drag the adjustment bar under **Left/right sound balance** to the left or right and adjust the sound balance.

## Interaction and dexterity

### Universal switch

You can control the touchscreen by connecting an external switch or by using head movements and face gestures.

- 1 Launch the **Settings** app and tap **Accessibility** → **Interaction and dexterity** → **Universal switch**.
- 2 Read the on-screen instructions and tap **Done**.
- 3 Tap the switch to activate it.
- 4 If the universal switches are not registered on the device, tap **Add switch** and set switches to control the device.

 To activate the universal switch feature, at least one switch must be registered on the device.

To set switches to control the device, tap the switch under **Switches**.

To deactivate this feature, press the Side key and the Volume Up key simultaneously.

### Assistant menu

#### Displaying the assistive shortcut icon

Set the device to display the assistive shortcut icon for accessing apps, features, and settings. You can easily control the device by tapping the assistive menus in the icon.

- 1 Launch the **Settings** app and tap **Accessibility** → **Interaction and dexterity** → **Assistant menu**.

- 2 Tap the switch to activate it.

The assistive shortcut icon appears at the bottom right of the screen.

To adjust the assistant shortcut icon's transparency level, drag the adjustment bar under **Transparency**.

## Accessing assistive menus







The assistive shortcut icon appears as a floating icon for easy access to the assistive menus from any screen.

When you tap the assistive shortcut icon, the icon expands slightly and the assistive menus appear on the icon. Tap the left or right arrow, or swipe to the left or right, to select other menus.

## Using the cursor

On the assistive menu, tap **Cursor**. You can control the screen using small finger movements on the touch area. Drag your finger on the touch area to move the cursor. Also, tap the screen to select items under the cursor.

Use the following options:

- : Scroll left or right on the screen.
- : Scroll up or down the screen.
- : Magnify the area where the cursor is located.
- : Change the touchpad and cursor settings.
- : Move the touch area to another location.
- : Close the touch area.

## Using enhanced assistive menus

Set the device to display enhanced assistive menus for selected apps.

Launch the **Settings** app, tap **Accessibility** → **Interaction and dexterity** → **Assistant menu** → **Select apps to show contextual menus with**, and then tap the switches next to the apps you want to activate.

## Voice Access

Use this feature to control your device by voice.

Launch the **Settings** app, tap **Accessibility** → **Interaction and dexterity** → **Voice Access**, and then tap the switch to activate it.

## Answering or ending calls

Change the method for answering or ending calls.

Launch the **Settings** app, tap **Accessibility** → **Interaction and dexterity** → **Answering and ending calls**, and then tap the switch of the method you want.

## Interaction control

Activate interaction control mode to restrict the device's reaction to inputs while using apps.

- 1 Launch the **Settings** app and tap **Accessibility** → **Interaction and dexterity** → **Interaction control**.
- 2 Tap the **Interaction control shortcut** switch to activate it.
- 3 Press the Side key and the Volume Up key simultaneously while using an app.
- 4 Adjust the size of the frame or draw a line around an area that you want to restrict.
- 5 Tap **Done**.  
The device displays the restricted area. The restricted area will not react when you touch it and the device's keys will be disabled. However, you can enable functions for the Side key, Volume key, and keyboard in interaction control mode.

To deactivate interaction control mode, press the Side key and the Volume Up key simultaneously.

To set the device to lock the screen after deactivating interaction control mode, launch the **Settings** app, tap **Accessibility** → **Interaction and dexterity** → **Interaction control**, and then tap the **Lock screen when deactivated** switch to activate it.

## Touch and hold delay

Set the recognition time for tapping and holding the screen.

Launch the **Settings** app, tap **Accessibility** → **Interaction and dexterity** → **Touch and hold delay**, and then select an option.

## Tap duration

Set the duration you must touch the screen for the device to recognise it as a tap.

Launch the **Settings** app, tap **Accessibility** → **Interaction and dexterity** → **Tap duration**, tap the switch to activate it, and then set the time.

## Ignore repeated touches

Set the device to recognise only the first tap within a set time when you tap the screen repeatedly.

Launch the **Settings** app, tap **Accessibility** → **Interaction and dexterity** → **Ignore repeated touches**, tap the switch to activate it, and then set the time.

## Auto action after pointer stops

Set the device to select an item automatically when you place the mouse pointer over the item.

Launch the **Settings** app, tap **Accessibility** → **Interaction and dexterity** → **Auto action after pointer stops** → **Auto action**, and then select an option.

## Sticky keys

Set an external keyboard's modifier key, such as the Shift, Ctrl, or Alt keys, to stay pressed. This helps you use keyboard shortcuts without pressing two keys at the same time.

Launch the **Settings** app, tap **Accessibility** → **Interaction and dexterity**, and then tap the **Sticky keys** switch to activate it.

## Slow keys

Set the recognition time for pressing a key on the external keyboard.

Launch the **Settings** app, tap **Accessibility** → **Interaction and dexterity** → **Slow keys**, tap the switch to activate it, and then set the time.

## Bounce keys

Set the device to recognise only the first time you press a key within a set time when you press the same key repeatedly.

Launch the **Settings** app, tap **Accessibility** → **Interaction and dexterity** → **Bounce keys**, tap the switch to activate it, and then set the time.

## Advanced settings

### Launching accessibility features quickly

Set to open the accessibility features quickly.

Launch the **Settings** app and tap **Accessibility** → **Advanced settings**. Tap **Accessibility button** → **Select actions**, or select **Side and Volume up keys** or **Volume up and down keys**, and then tick the accessibility features you want to use.

### Setting light notification

Set the device to blink the flash or the screen when an alarm sounds or when you have notifications, such as incoming calls or new messages.

Launch the **Settings** app, tap **Accessibility** → **Advanced settings** → **Flash notification**, and then tap the switches next to the options you want to activate.

### Time to take action

Set the amount of time to display pop-up windows that ask you to take action, such as notifications or volume controller.

Launch the **Settings** app, tap **Accessibility** → **Advanced settings** → **Time to take action**, and then select an option.

### Speak keyboard input aloud

Set the device to read aloud what you enter on the keyboard.





Launch the **Settings** app, tap **Accessibility** → **Advanced settings** → **Speak keyboard input aloud**, tap the switch to activate it, and then select an option.

### Bixby Vision for accessibility

When you activate the Bixby Vision accessibility features, you can use additional Bixby Vision features.

- 1 Launch the **Settings** app, tap **Accessibility** → **Advanced settings** → **Bixby Vision for accessibility**, and then tap the switch to activate it.
- 2 Tap **Open Bixby Vision**.

3 Select a feature you want to use.

-  : Analyse the scene you captured and describe it by voice.
-  : Recognise objects and describe them by voice.
-  : Recognise text and read them aloud.
-  : Detect the colour of the object and say it aloud.

 Some features may not be available depending on the service provider or model.

## Adding voice recordings to voice labels

You can use voice labels to distinguish objects of similar shape by attaching labels to them. You can record and assign a voice recording to an NFC-enabled voice label. The voice recording is played back when you place your device near the label.

 Turn on the NFC feature before using this feature.

1 Launch the **Settings** app and tap **Accessibility** → **Advanced settings** → **Voice Label**.

The voice recorder will launch.

2 Tap  to start recording. Speak into the microphone.

3 When you are finished recording, tap **Done** to stop.

4 Hold the back of your device over the voice label.

The information in the voice recording will be written to the voice label.

## Installed apps

View accessibility services installed on the device.

Launch the **Settings** app and tap **Accessibility** → **Installed apps**.



## Troubleshooting

Before contacting a Samsung Service Centre, please attempt the following solutions. Some situations may not apply to your device.

You can also use Samsung Members to solve any problems you might encounter while using your device.

### When you turn on your device or while you are using the device, it prompts you to enter one of the following codes:

- **Password:** When the device lock feature is enabled, you must enter the password you set for the device.
- **PIN:** When using the device for the first time or when the PIN requirement is enabled, you must enter the PIN supplied with the SIM or USIM card. You can disable this feature by using the Lock SIM card menu.
- **PUK:** Your SIM or USIM card is blocked, usually as a result of entering your PIN incorrectly several times. You must enter the PUK supplied by your service provider.
- **PIN2:** When you access a menu requiring the PIN2, you must enter the PIN2 supplied with the SIM or USIM card. For more information, contact your service provider.

### Your device displays network or service error messages

- When you are in areas with weak signals or poor reception, you may lose reception. Move to another area and try again. While moving, error messages may appear repeatedly.
- You cannot access some options without a subscription. For more information, contact your service provider.

### Your device does not turn on

When the battery is completely discharged, your device will not turn on. Fully charge the battery before turning on the device.

## The touchscreen responds slowly or improperly

- If you attach a screen protector or optional accessories to the touchscreen, the touchscreen may not function properly.
- If you are wearing gloves, if your hands are not clean while touching the touchscreen, or if you tap the screen with sharp objects or your fingertips, the touchscreen may malfunction.
- The touchscreen may malfunction in humid conditions or when exposed to water.
- Restart your device to clear any temporary software bugs.
- Ensure that your device software is updated to the latest version.
- If the touchscreen is scratched or damaged, visit a Samsung Service Centre.

## Your device freezes or encounters a fatal error

Try the following solutions. If the problem is still not resolved, contact a Samsung Service Centre.

### Restarting the device

If your device freezes or hangs, you may need to close apps or turn off the device and turn it on again.

### Forcing restart

If your device is frozen and unresponsive, press and hold the Side key and the Volume Down key simultaneously for more than 7 seconds to restart it.

### Resetting the device

If the methods above do not solve your problem, perform a factory data reset.

Launch the **Settings** app and tap **General management** → **Reset** → **Factory data reset** → **Reset** → **Delete all**. Before performing the factory data reset, remember to make backup copies of all important data stored in the device.

## Calls are not connected

- Ensure that you have accessed the right cellular network.
- Ensure that you have not set call barring for the phone number you are dialling.
- Ensure that you have not set call barring for the incoming phone number.

## Others cannot hear you speaking on a call

- Ensure that you are not covering the built-in microphone.
- Ensure that the microphone is close to your mouth.
- If using an earphone, ensure that it is properly connected.

## Sound echoes during a call

Adjust the volume by pressing the Volume key or move to another area.

## A cellular network or the Internet is often disconnected or audio quality is poor

- Ensure that you are not blocking the device's internal antenna.
- When you are in areas with weak signals or poor reception, you may lose reception. You may have connectivity problems due to issues with the service provider's base station. Move to another area and try again.
- When using the device while moving, wireless network services may be disabled due to issues with the service provider's network.

## The battery does not charge properly (For Samsung-approved chargers)

- Ensure that the charger is connected properly.
- Visit a Samsung Service Centre and have the battery replaced.

## The battery depletes faster than when first purchased

- When you expose the device or the battery to very cold or very hot temperatures, the useful charge may be reduced.
- Battery consumption will increase when you use certain features or apps, such as GPS, games, or the Internet.
- The battery is consumable and the useful charge will get shorter over time.

## Error messages appear when launching the camera

Your device must have sufficient available memory and battery power to operate the camera app. If you receive error messages when launching the camera, try the following:

- Charge the battery.
- Free some memory by transferring files to a computer or deleting files from your device.
- Restart the device. If you are still having trouble with the camera app after trying these tips, contact a Samsung Service Centre.

## Picture quality is poorer than the preview

- The quality of your pictures may vary, depending on the surroundings and the photography techniques you use.
- If you take pictures in dark areas, at night, or indoors, image noise may occur or images may be out of focus.

## Error messages appear when opening multimedia files

If you receive error messages or multimedia files do not play when you open them on your device, try the following:

- Free some memory by transferring files to a computer or deleting files from your device.
- Ensure that the music file is not Digital Rights Management (DRM)-protected. If the file is DRM-protected, ensure that you have the appropriate licence or key to play the file.
- Ensure that the file formats are supported by the device. If a file format is not supported, such as DivX or AC3, install an app that supports it. To confirm the file formats that your device supports, visit the Samsung website.
- Your device supports pictures and videos captured with the device. Pictures and videos captured by other devices may not work properly.
- Your device supports multimedia files that are authorised by your network service provider or providers of additional services. Some content circulated on the Internet, such as ringtones, videos, or wallpapers, may not work properly.

## Bluetooth is not working well

If another Bluetooth device is not located or there are connection problems or performance malfunctions, try the following:

- Ensure that the device you wish to connect with is ready to be scanned or connected to.
- Ensure that your device and the other Bluetooth device are within the maximum Bluetooth range (10 m).
- On your device, launch the **Settings** app, tap **Connections**, and then tap the **Bluetooth** switch to re-activate it.
- On your device, launch the **Settings** app, tap **General management** → **Reset** → **Reset network settings** → **Reset settings** → **Reset** to reset network settings. You may lose registered information when performing the reset.

If the tips above do not solve the problem, contact a Samsung Service Centre.

## The screen brightness adjustment bar does not appear on the notification panel

Open the notification panel by dragging the status bar downwards, and then drag the notification panel downwards. Tap  → **Quick panel layout** → **Brightness control** → **Show always**.

## A connection is not established when you connect the device to a computer

- Ensure that the USB cable you are using is compatible with your device.
- Ensure that you have the proper driver installed and updated on your computer.

## Your device cannot find your current location

GPS signals may be obstructed in some locations, such as indoors. Set the device to use Wi-Fi or a mobile network to find your current location in these situations.

## Data stored in the device has been lost

Always make backup copies of all important data stored in the device. Otherwise, you cannot restore data if it is corrupted or lost. Samsung is not responsible for the loss of data stored in the device.

## A small gap appears around the outside of the device case

- This gap is a necessary manufacturing feature and some minor rocking or vibration of parts may occur.
- Over time, friction between parts may cause this gap to expand slightly.

## There is not enough space in the device's storage

Delete unnecessary data, such as cache, using the device care feature or manually delete unused apps or files to free up storage space.

## The Home button does not appear

The navigation bar containing the Home button may disappear while using certain apps or features. To view the navigation bar, drag upwards from the bottom of the screen.

## Removing the battery

- **To remove the battery, contact an authorised service centre. To obtain battery removal instructions, please visit [www.samsung.com/global/ecodesign\\_energy](http://www.samsung.com/global/ecodesign_energy).**
- For your safety, you **must not attempt to remove** the battery. If the battery is not properly removed, it may lead to damage to the battery and device, cause personal injury, and/or result in the device being unsafe.
- Samsung does not accept liability for any damage or loss (whether in contract or tort, including negligence) which may arise from failure to precisely follow these warnings and instructions, other than death or personal injury caused by Samsung's negligence.

## Copyright

Copyright © 2022 Samsung Electronics Co., Ltd.

This manual is protected under international copyright laws.

No part of this manual may be reproduced, distributed, translated, or transmitted in any form or by any means, electronic or mechanical, including photocopying, recording, or storing in any information storage and retrieval system.

## Trademarks

- SAMSUNG and the SAMSUNG logo are registered trademarks of Samsung Electronics Co., Ltd.
- Bluetooth® is a registered trademark of Bluetooth SIG, Inc. worldwide.
- Wi-Fi®, Wi-Fi Direct™, Wi-Fi CERTIFIED™, and the Wi-Fi logo are registered trademarks of the Wi-Fi Alliance.
- Manufactured under license from Dolby Laboratories. Dolby, Dolby Atmos, and the double-D symbol are trademarks of Dolby Laboratories.
- All other trademarks and copyrights are the property of their respective owners.