



RAZER PRO TYPE

MASTER GUIDE

A big part of producing top-quality work comes from the quality of your office equipment—so why settle for anything less? Take your productivity to the next level with a wireless keyboard that offers a superior typing experience, engineered for the optimal balance of performance and comfort. The **Razer Pro Type** is built to keep up with the rigors of demanding office work and is well-suited to deliver consistent, reliable performance over long periods of intense use.

# CONTENTS

1. WHAT'S INSIDE / WHAT'S NEEDED.....	3
2. LET'S GET YOU COVERED.....	5
3. TECHNICAL SPECIFICATIONS.....	6
4. SETTING UP YOUR KEYBOARD.....	7
5. USING YOUR RAZER PRO TYPE.....	10
6. CONFIGURING YOUR RAZER PRO TYPE.....	12
7. SAFETY AND MAINTENANCE.....	26
8. LEGALESE.....	28

---

# 1. WHAT'S INSIDE / WHAT'S NEEDED

## WHAT'S INSIDE

- Razer Pro Type

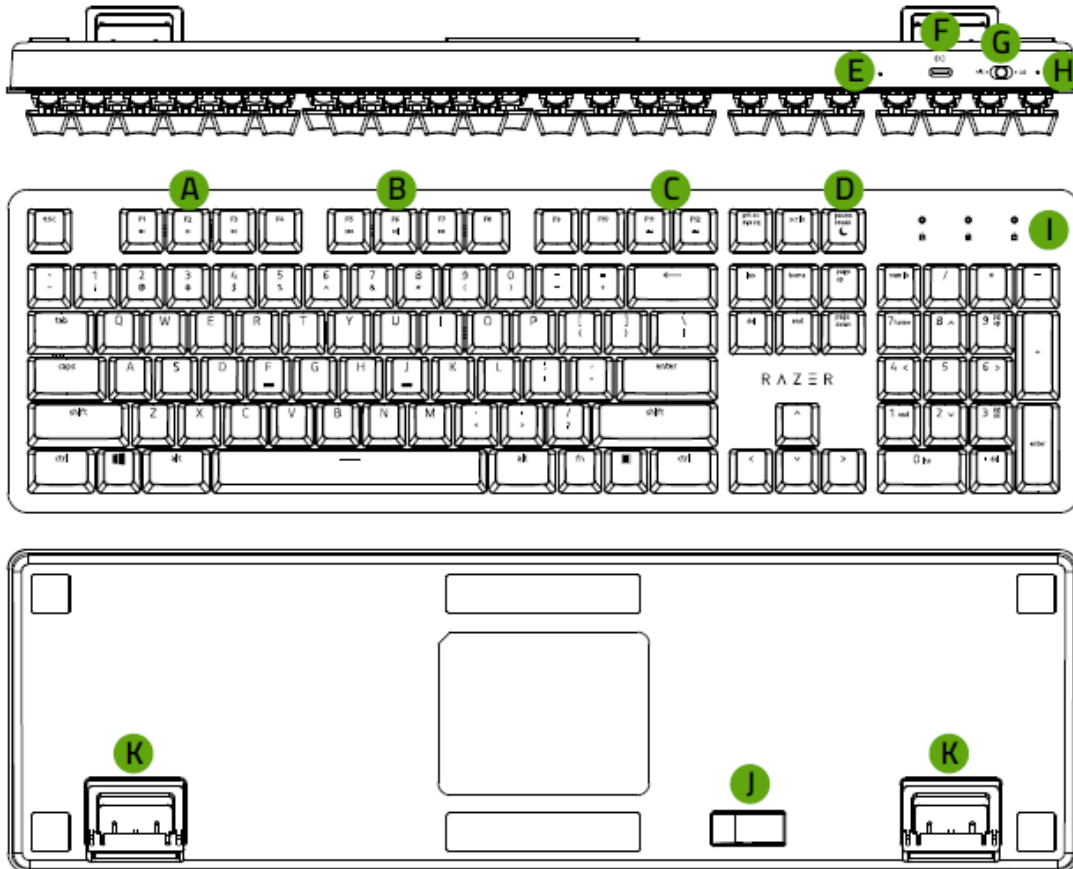

- A. Volume control keys
- B. Media keys
- C. Backlight control keys
- D. Sleep mode key
- E. Reset button
- F. Type C charging-only port
- G. Mode switch (2.4 / OFF / BT)
- H. Power indicator
- I. LED indicators\*
- J. Magnetic USB dongle compartment
- K. Kickstand

*\*Limited functionality on selected devices.*

- USB wireless dongle

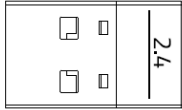

- Type C to Type A cable

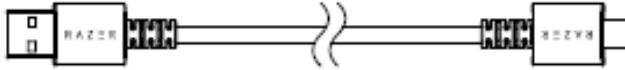

- Important Product Information Guide

## WHAT'S NEEDED

### Product Requirements

- PC with a free USB port or Bluetooth 4.0 connectivity

### Razer Synapse Requirements

- Windows® 7 64-bit (or higher)
- Internet connection for software installation

---

## 2. LET'S GET YOU COVERED

You've got a great device in your hands, complete with a 2-year limited warranty coverage. Now maximize its potential and score exclusive Razer benefits by registering at [razerid.razer.com](https://razerid.razer.com)

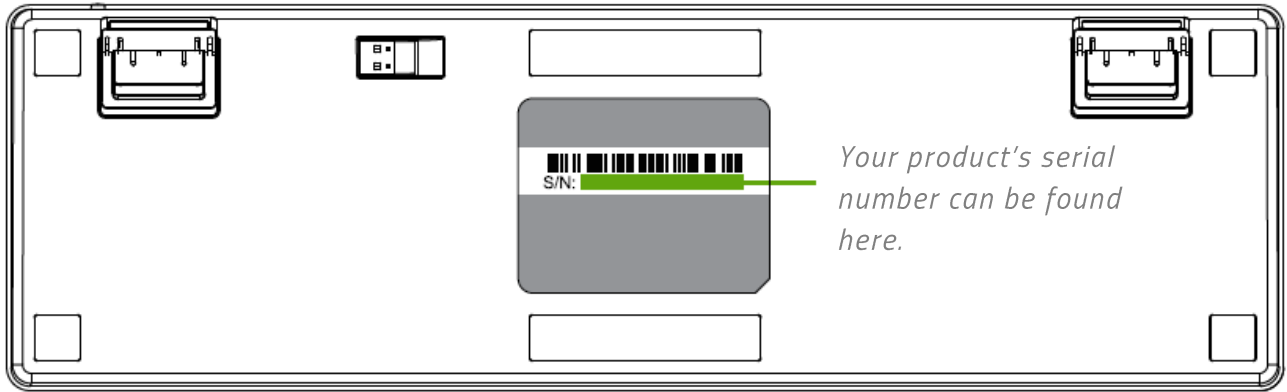

Got a question? Ask the Razer Support Team at [support.razer.com](https://support.razer.com)

---

## 3. TECHNICAL SPECIFICATIONS

### FEATURES

- Razer™ Orange Mechanical Switch with 80 million keystroke lifespan
- Full-sized keyboard with soft-touch coating
- Wireless connection via Bluetooth® and 2.4GHz
- Detachable USB-C braided fiber cable
- Multi-host connection for up to 4 devices
- Fully programmable keys with macro recording
- Backlit keys (white LED)
- 10-key rollover
- Battery Life: Up to ~12 hours on Bluetooth® and 2.4GHz with back-lighting on, or up to ~84 hours without back-lighting on Bluetooth® and ~78 hours on 2.4GHz
- Metal top cover
- Razer Synapse 3 enabled

### APPROXIMATE SIZE & WEIGHT

- Length: 441 mm / 17.4 in
- Width: 133 mm / 5.2 in
- Height: 39.8 mm / 1.6 in
- Weight: 906 g / 2.0 lbs

---



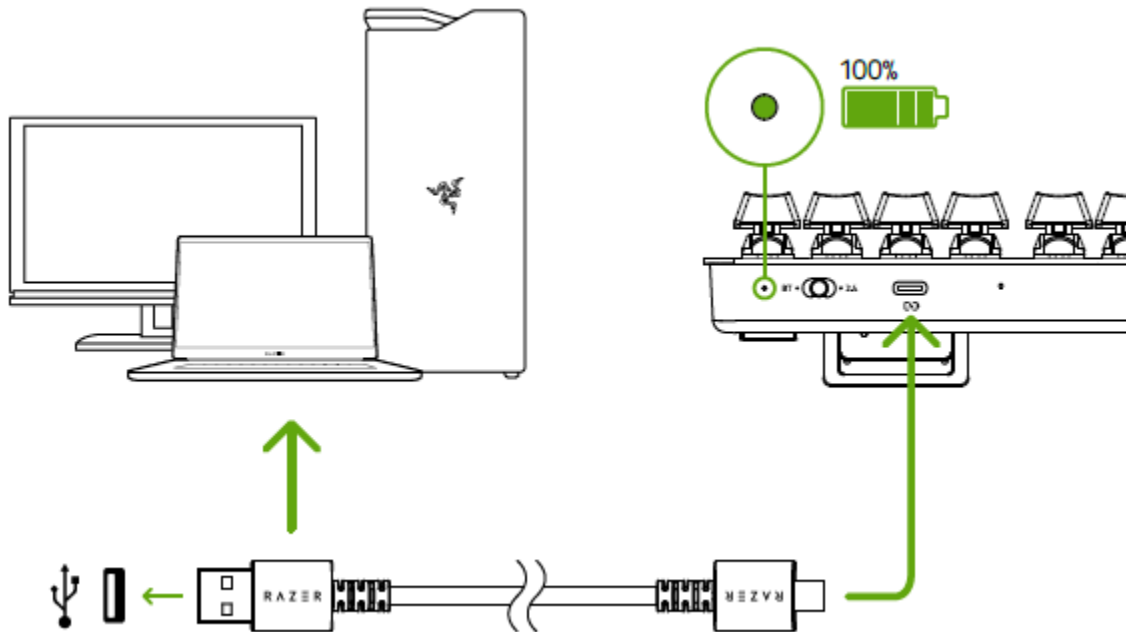

## 4. SETTING UP YOUR KEYBOARD

1. Connect your keyboard to a powered USB port using the Type C to Type A cable to charge your keyboard. The power indicator will turn solid green when the keyboard is fully charged.



**i** For best results, fully charge your keyboard before using it for the first time. It takes approximately 2 hours to fully charge your keyboard. You may continue using the keyboard while plugged in.

When your keyboard is not charging, the power indicator will only briefly display its battery status.

Mode	Charged	Low	Critical*
2.4 / BT			
OFF			

\*Critical status indicates that the keyboard's battery is less than 3%. This lighting sequence will repeat until the battery is drained or the keyboard is being charged.



2. Set the mode switch to your preferred mode.

### 2.4 GHz mode

1. Set the mode switch to 2.4.

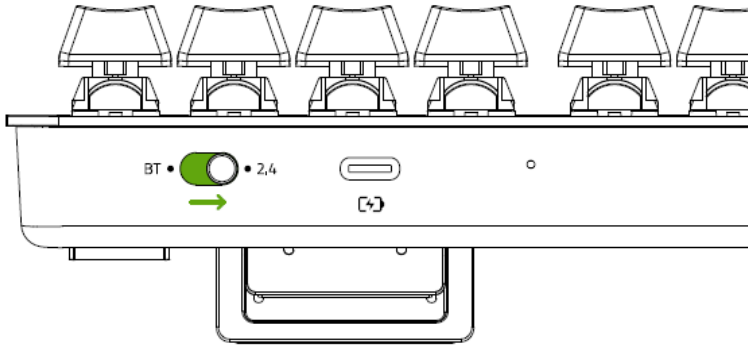

2. Detach the USB wireless dongle from the dongle compartment and connect it to your computer.

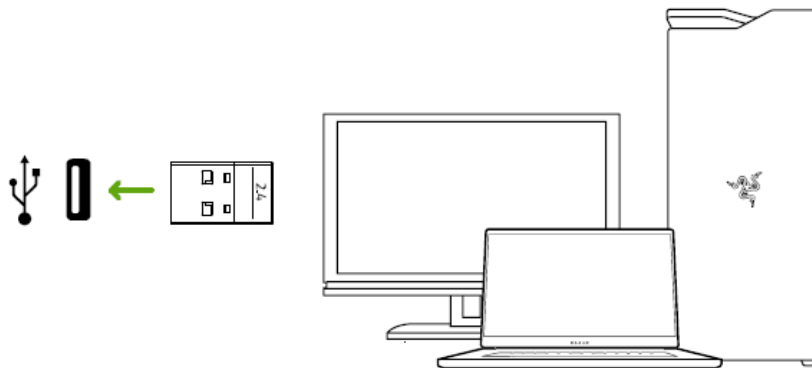

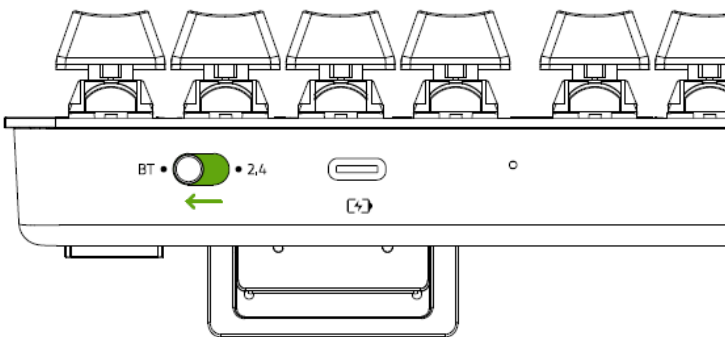

### BT mode

1. Set the mode switch to BT.



- Up to 3 Bluetooth devices can be paired and registered to your keyboard (one for each profile). To activate the pairing mode of your preferred profile, press and hold its corresponding shortcut for 5 seconds. The LED indicators will then display which Profile has been activated.

Shortcut	Profile	Status
fn + 1	Profile 1	
fn + 2	Profile 2	
fn + 3	Profile 3	

- Enable Bluetooth on your device and select Razer Pro Type from the list of devices found. The device will pair with your keyboard and the connection will be registered on the active profile.

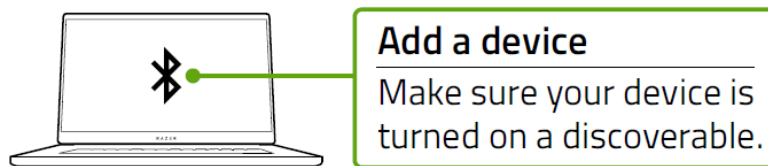

**i** Pressing the fn key will display which profile is active on the LED indicators. Moreover, when pairing new devices with your keyboard, it is recommended that you register the new device on a different profile so you may still use the other profiles to reconnect with previous devices. [Learn more about Bluetooth profiles](#)

- Use the Razer Synapse\* app to change your keyboard's lighting effect and even customize other features available on your keyboard.

\*Install Razer Synapse when prompted or download the installer from [razer.com/synapse](https://razer.com/synapse).

## 5. USING YOUR RAZER PRO TYPE

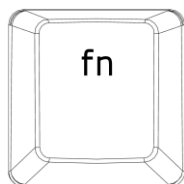

Pressing the fn key in combination with the function keys will activate their secondary features on your PC.

Function Keys	Features Description
Three square keys with rounded corners. The first is labeled "F1" with a speaker icon and a small "x" (mute). The second is labeled "F2" with a speaker icon and a small "v" (decrease volume). The third is labeled "F3" with a speaker icon and a small "v" (increase volume).	The audio volume controls allow you to mute (  ), decrease (  ) and increase (  ) the audio output.
Three square keys with rounded corners. The first is labeled "F5" with a double left arrow icon (skip backward). The second is labeled "F6" with a play/pause icon. The third is labeled "F7" with a double right arrow icon (skip forward).	The media keys allow you to play/pause (  ) a track or skip tracks backward (  ) and forward (  ).
Two square keys with rounded corners. The first is labeled "F11" with a crown icon (decrease brightness). The second is labeled "F12" with a crown icon (increase brightness).	The backlight control keys allow you to decrease (  ) or increase (  ) the brightness of your keyboard's LEDs.
A square key with rounded corners, labeled "pause break" with a crescent moon icon.	The sleep key allows you to suspend all operating system activities. This function allows you to save electricity while the computer is idle.

## UNDERSTANDING BLUETOOTH PROFILES

### Switching between profiles

To switch between any of the Bluetooth profiles available on your keyboard, simply press the corresponding shortcut of the profile your device is registered to.

### Activating a profile pairing mode

Press and hold the corresponding shortcut of the profile that you want to activate. The status of the corresponding profile will start blinking to show that the profile is now in pairing mode.

### Displaying the active profile

The LED indicators will display which profile is currently active while the fn key is pressed.

## USING THE RESET BUTTON

If your keyboard freezes or suddenly stops responding, simply press the Reset button on the keyboard using a paper clip or any similar object to restart your device.

---

## 6. CONFIGURING YOUR RAZER PRO TYPE

**i** *Internet connection is required for installation, updates and cloud-based features. Registering for a Razer ID account is recommended, but optional. All listed features are subject to change based on the current software version, connected device(s), and supported apps and software.*

### SYNAPSE TAB

The Synapse tab is your default tab when you first launch Razer Synapse.

#### Dashboard

The Dashboard subtab is an overview of your Razer Synapse where you can access all your Razer devices, modules, and online services.

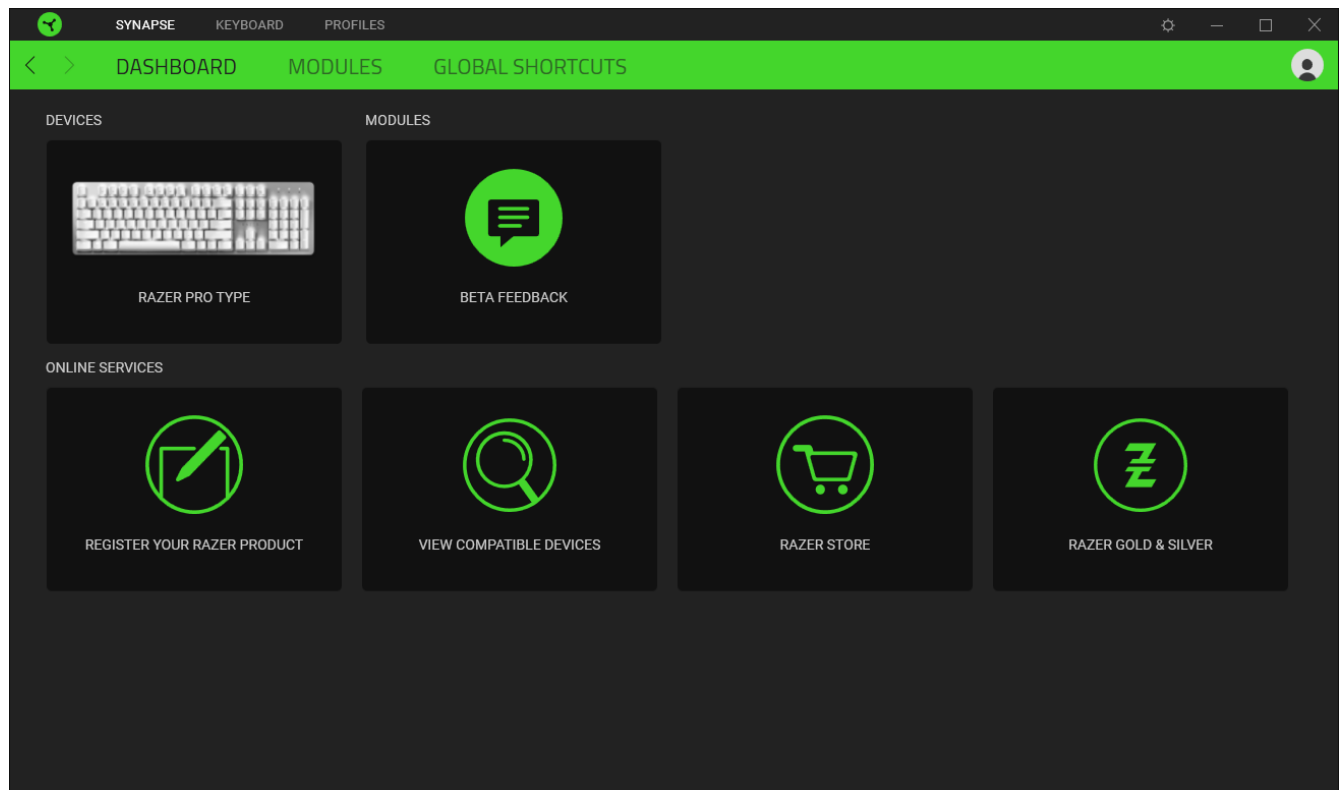

## Modules

The Modules subtab displays all installed and available modules for installation.

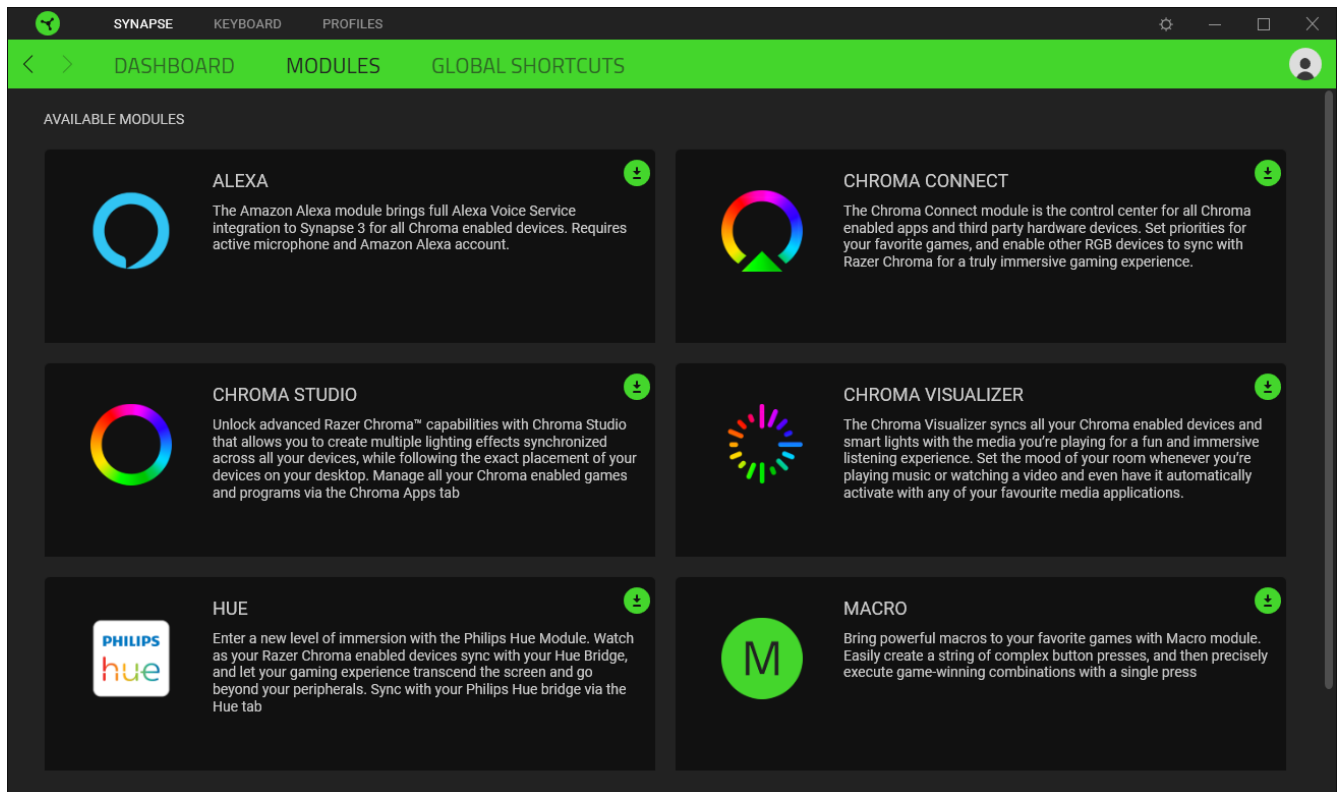

## Global Shortcuts

Bind operations or Razer Synapse functions to custom key-combinations from any Razer Synapse-enabled device inputs which apply across all device profiles. [Learn more about Profiles](#)

**!** *Only Razer Synapse-enabled device inputs will be recognized.*

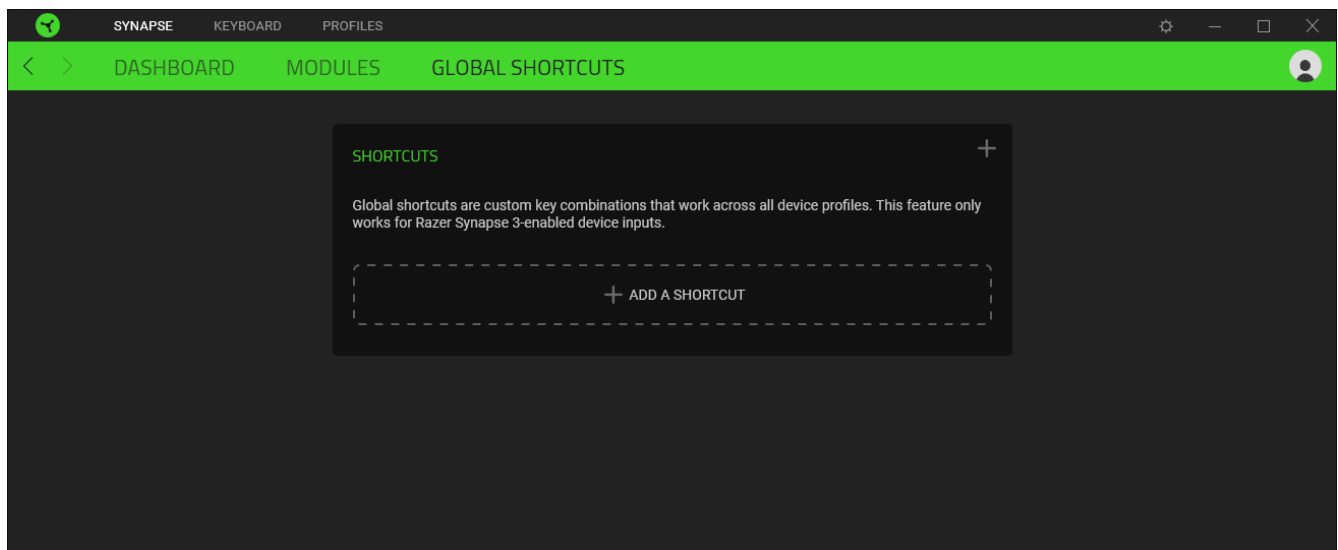

## KEYBOARD

The Keyboard tab is the main tab for your Razer Pro Type. From here, you can change your device settings such as key assignments and your device's lighting. Changes made under this tab are automatically saved to your system and cloud storage.

### Customize

The Customize subtab is for modifying your keyboard's key assignments.

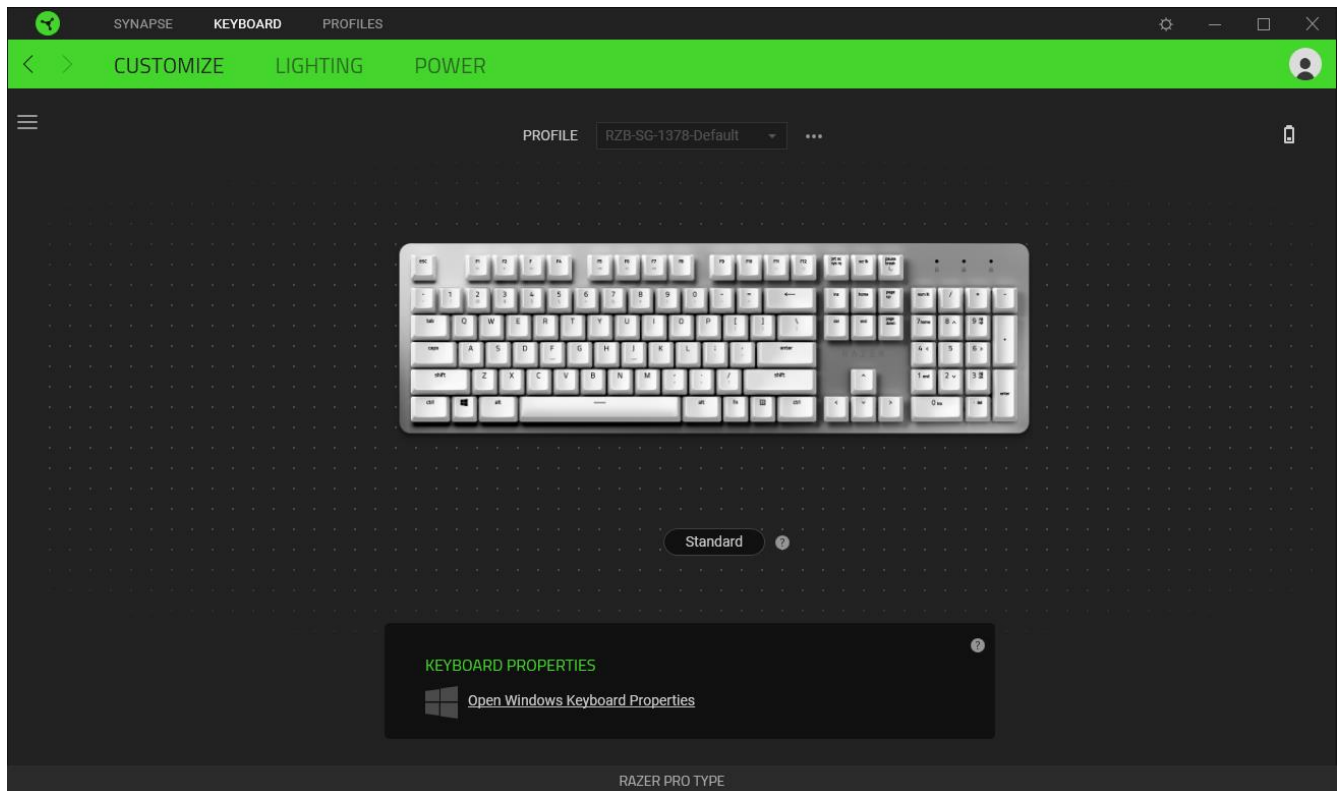

### Profile

Profile is a data storage for keeping all your Razer peripheral's settings. By default, the profile name is based on your system's name. To add, import, rename, duplicate, export, or delete a profile, simply press the profile's corresponding Miscellaneous button (•••).

### Keyboard Properties

Allows you to open the Windows Keyboard Properties where you can modify other keyboard settings such as Repeat delay, Repeat Rate, and Cursor blink rate, or view all keyboard drivers installed in your PC.

## Hypershift

Hypershift mode is a secondary set of key assignments that is activated when the Hypershift key is held down. By default, the Hypershift key is assigned to the fn key of your Razer Synapse supported keyboard however, you can also assign any key as a Hypershift key.

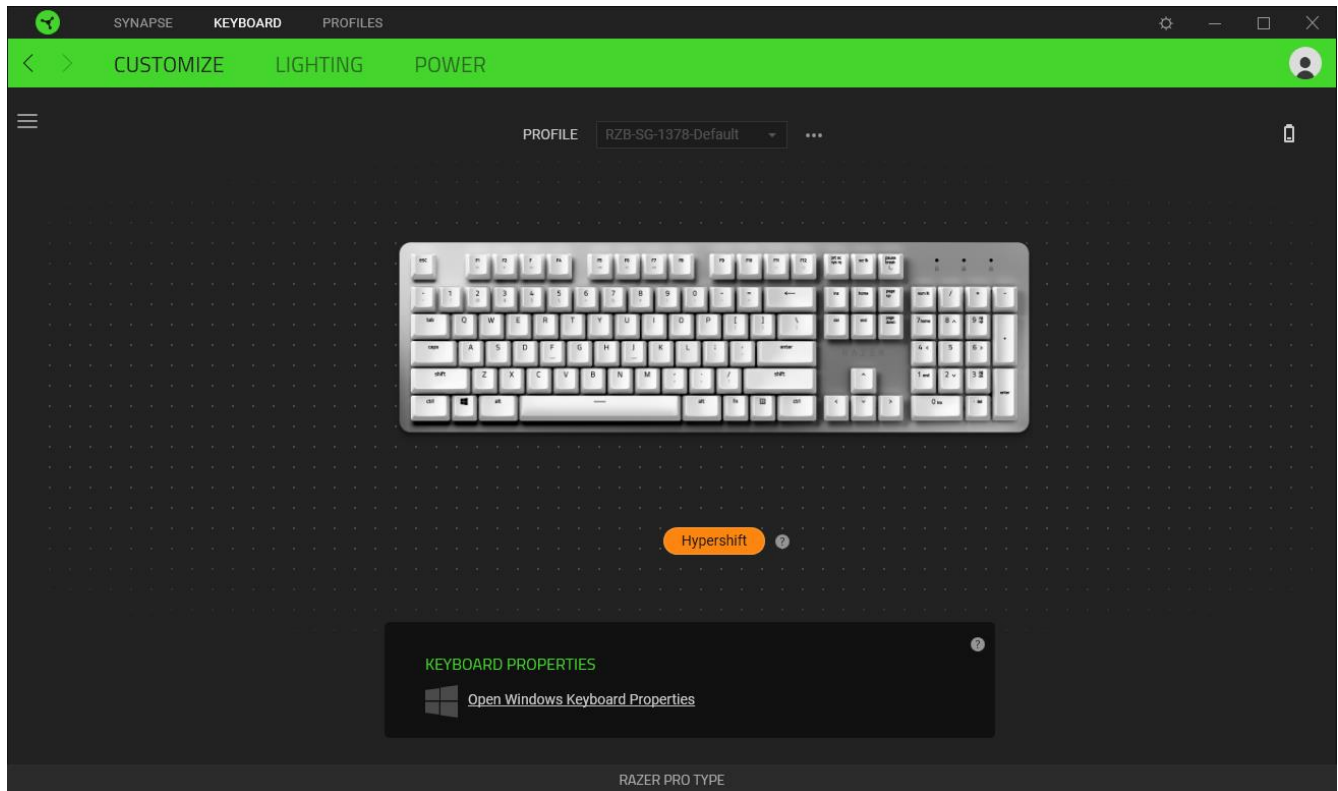



## Sidebar

Clicking the Sidebar button (☰) will reveal all current key assignments for your Razer Pro Type.

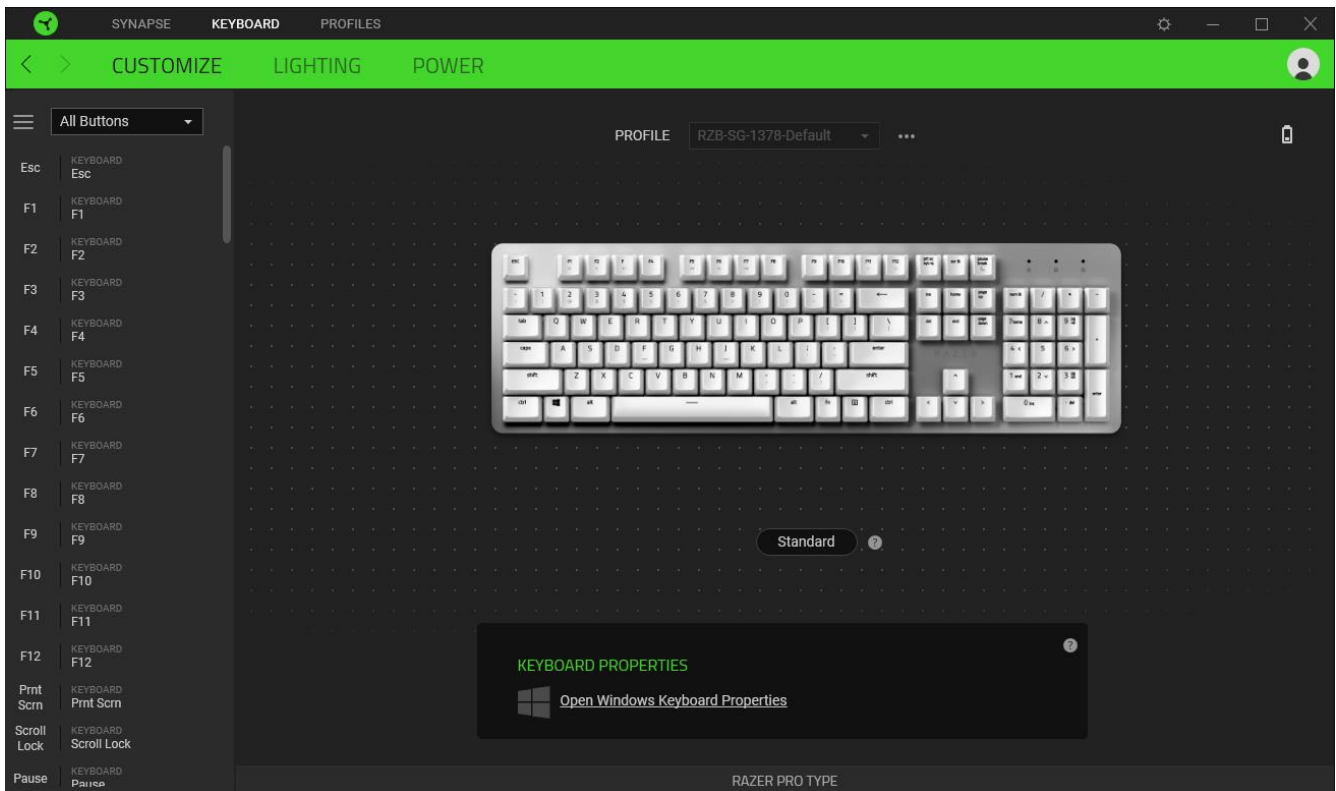

Alternatively, you can skip to a specific key assignment by selecting it on the Customize tab.

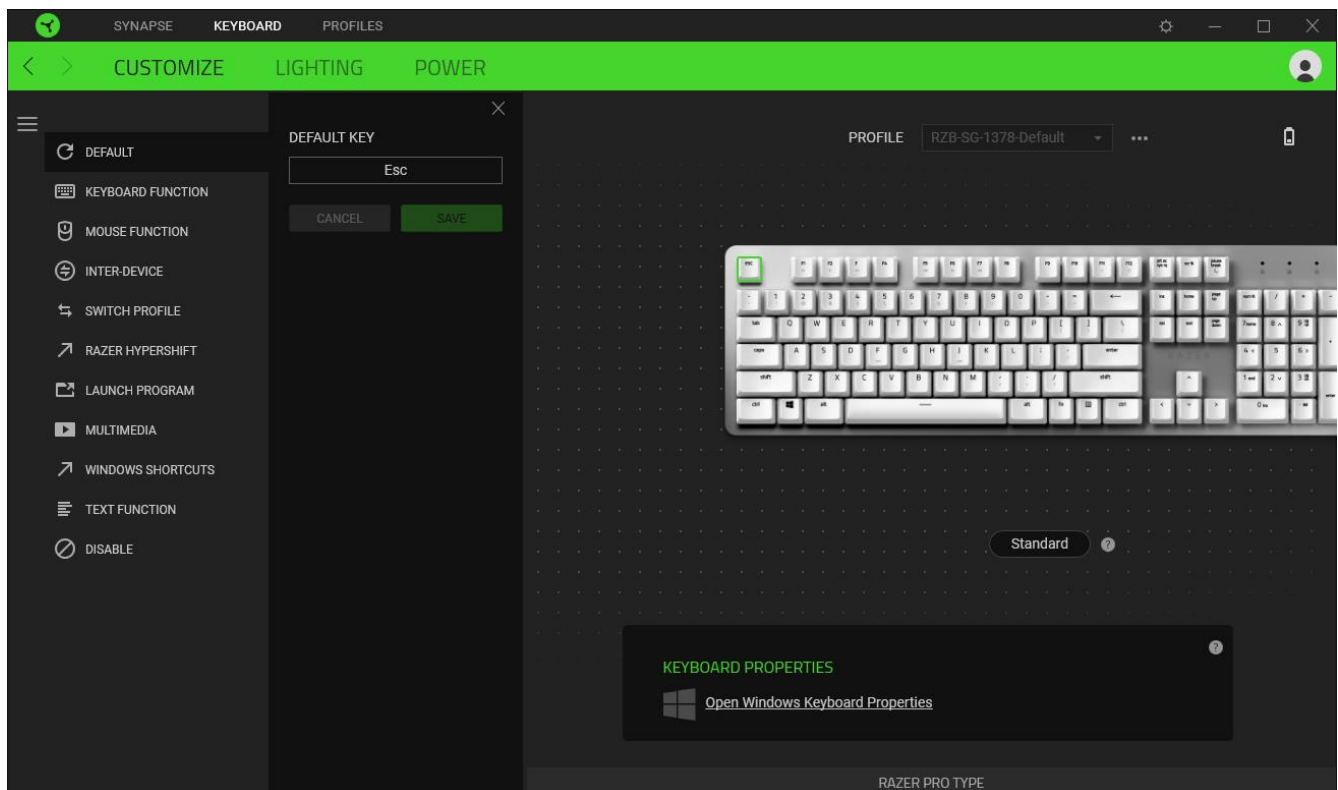

Upon selecting a key assignment, you may then change it to one of the following functions:

### Default

This option enables you to return the selected key to its original setting.

### Keyboard Function

This option changes the key assignment into a keyboard function. You can also choose enable Turbo mode which allows you to emulate repeatedly pressing the keyboard function while the key is held down.

### Mouse Function

This option allows you to change any key into a mouse function. You can also choose to enable Turbo mode in some of the mouse functions to control how many times the function will be pressed while the key is held down.

### Inter-device

Inter-device allows you to change the functionality of other Razer Synapse-enabled devices. Some of these functionalities are device-specific such as using your Razer gaming keyboard to change the Sensitivity Stage of your Razer gaming mouse.

### M Macro

A Macro is a prerecorded sequence of keystrokes and button presses that is executed with precise timing. By setting the key function to Macro, you can conveniently execute a chain of commands. This function will only be visible when the Macro module is installed.

### Switch Profile

Switch Profile enables you to quickly change profiles and load a new set of key assignments. An on-screen notification will appear whenever you switch profiles.

### Switch Lighting

Switch Lighting allows you to easily switch between all advanced lighting effects. This function will only be visible when the Chroma Studio module is installed.

## Razer Hypershift

Setting the key to Razer Hypershift will allow you to activate Hypershift mode if the key is held down.

## Launch Program

Launch Program enables you to open an app or a website using the assigned key. When you select Launch Program, two choices will appear which requires you to search for a specific app you want to open, or write the address of the website you want to visit.

## Multimedia

This option allows you to assign multimedia controls to your Razer device.

## Windows Shortcuts

This option allows you to assign your preferred key into a Windows Operating System shortcut command. For more information, please visit: [support.microsoft.com/kb/126449](https://support.microsoft.com/kb/126449)

## Text Function

Text Function enables you to type a prewritten text with a touch of a key. Simply write your desired text on the given field and your text will be typed whenever the assigned key is pressed. This function has full Unicode support and you can also insert special symbols from character maps.

## Disable

This option renders the assigned key unusable. Use Disable if you do not want to use the selected key or if it interferes with your gaming.

## Lighting

The Lighting subtab enables you to modify your Razer device's light settings.

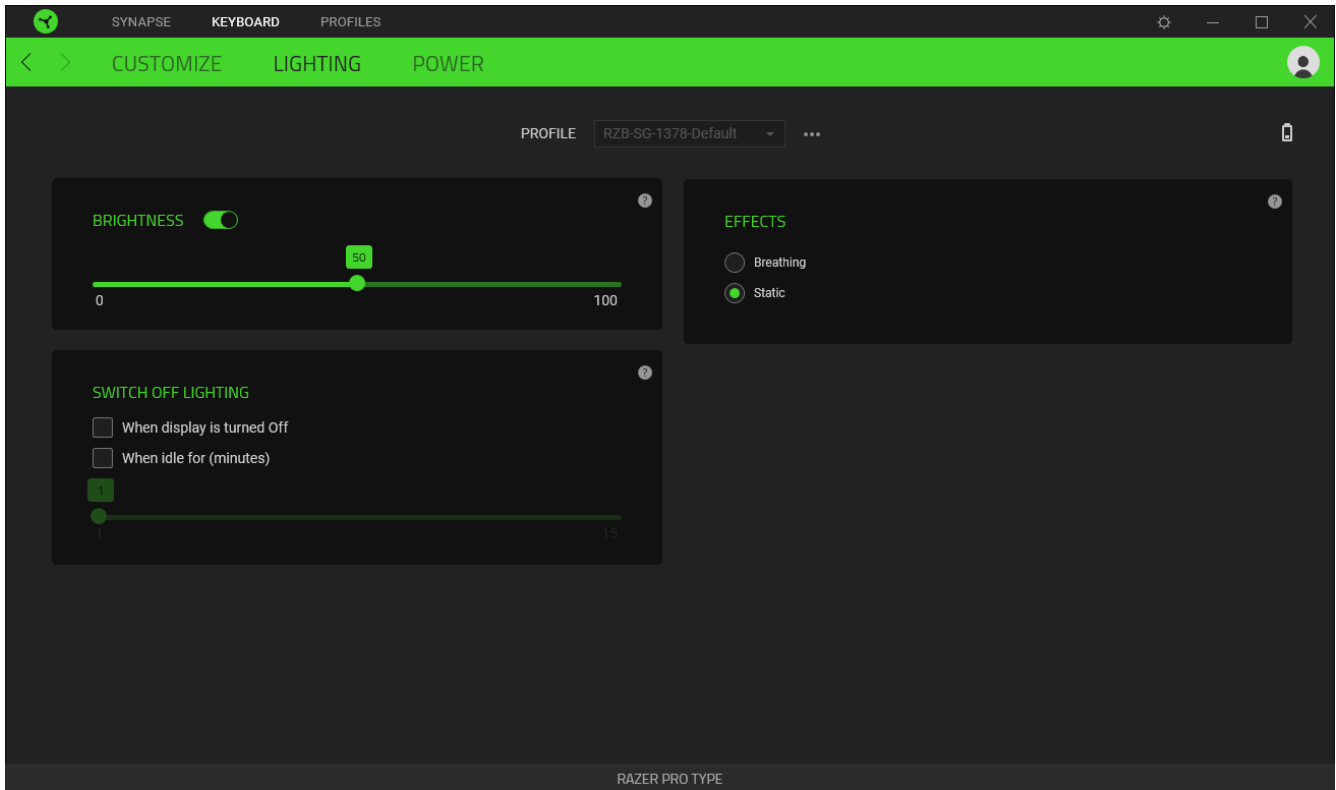

### *Brightness*

You can turn off your Razer device's lighting by toggling the Brightness option or increase/decrease the luminance using the slider.



### *Switch Off Lighting*

This is a power saving tool which allows you to disable your device's lighting in response to your system's display turning off and/or automatically power down when your Razer Pro Type has been idle for a set amount of time.

## Effects

Select an effect to apply on your device's lighting.

 *LED indicators are not customizable.*

	Name	Description
	Breathing	The lighting will fade in and out
	Static	The LEDs will remain lit

## Power

The Power subtab allows you to manage your device's energy consumption when running on batteries.

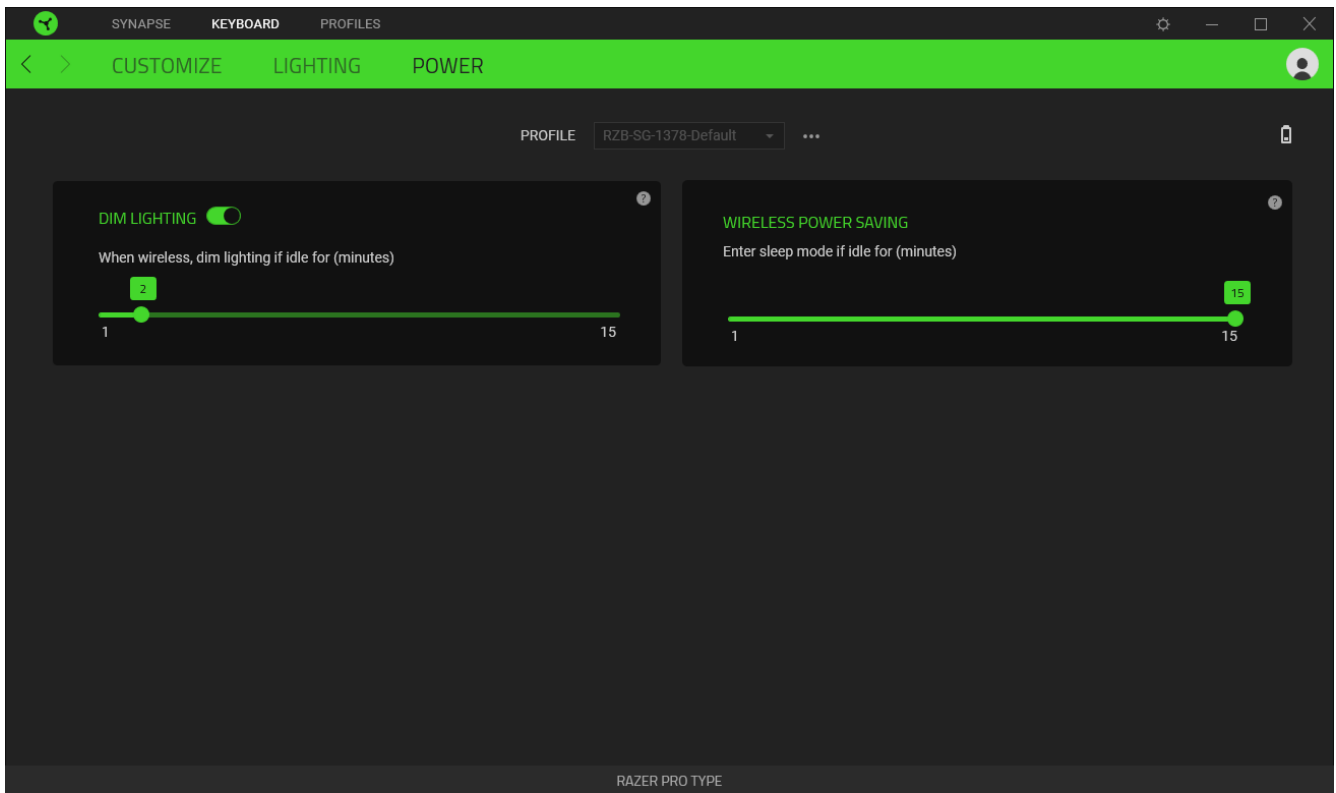

### *Dim Lighting*

Set how long your device should be idle before it lowers its brightness.

### *Wireless Power Saving*

Set your device to enter sleep mode when it has been idle for a certain amount of time.



## PROFILES TAB

The Profiles tab is a convenient way of managing all your profiles and linking them to your games and applications.

### Devices

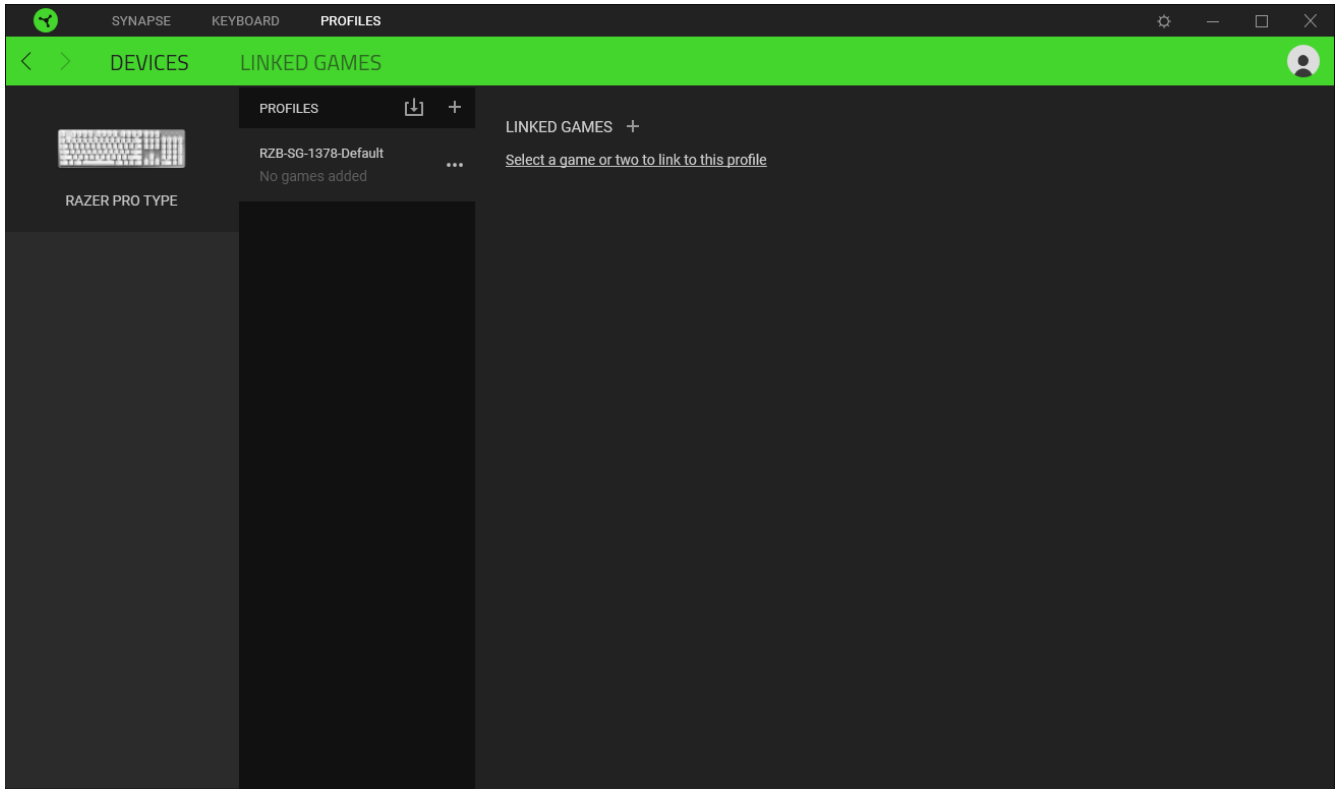
View which Razer device is using a specific profile using the Devices subtab.



You can import Profiles from your computer or from the cloud through the import button (  ) or create new profiles within the selected device using the add button (  ). To rename, duplicate, export, or delete a profile, simply press the Miscellaneous button (  ). Each profile can be set to automatically activate when you run an application using the Linked Games option.

## Linked Games

The Linked Games subtab gives you the flexibility to add games, view peripherals that are linked to games, or search for added games. You can also sort games based on alphabetical order, last played, or most played. Added games will still be listed here even if it is not linked to a Razer device.

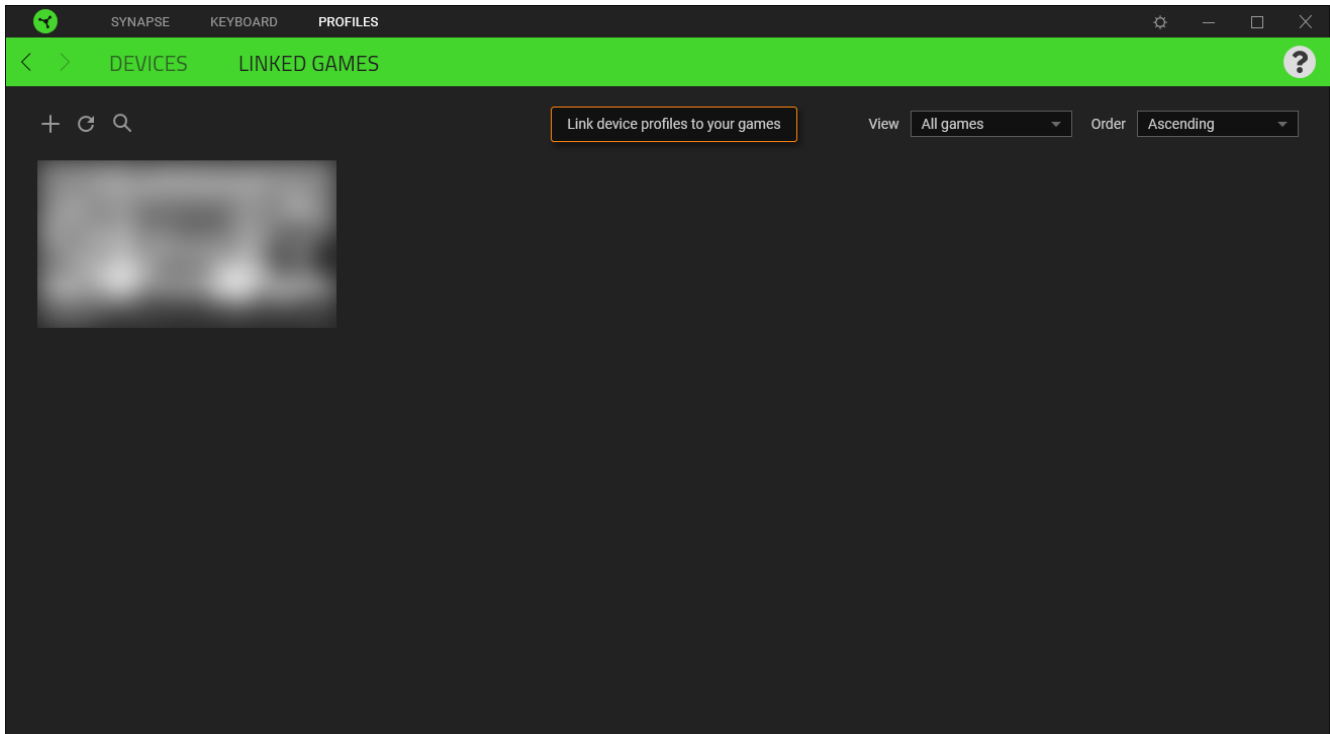

To link games to connected Razer devices, simply click on a game from the list, and then click **Select a device and its profile to launch automatically during gameplay** link to select the Razer device it will link with. Once linked, you may click on the Miscellaneous button ( ●●● ) of the corresponding device to select a specific profile.



## SETTINGS WINDOW

The Settings window, accessible by clicking the (⚙️) button on Razer Synapse, enables you to configure the startup behavior and display language of Razer Synapse, view the master guides of each connected Razer device, or perform factory reset on any connected Razer device.

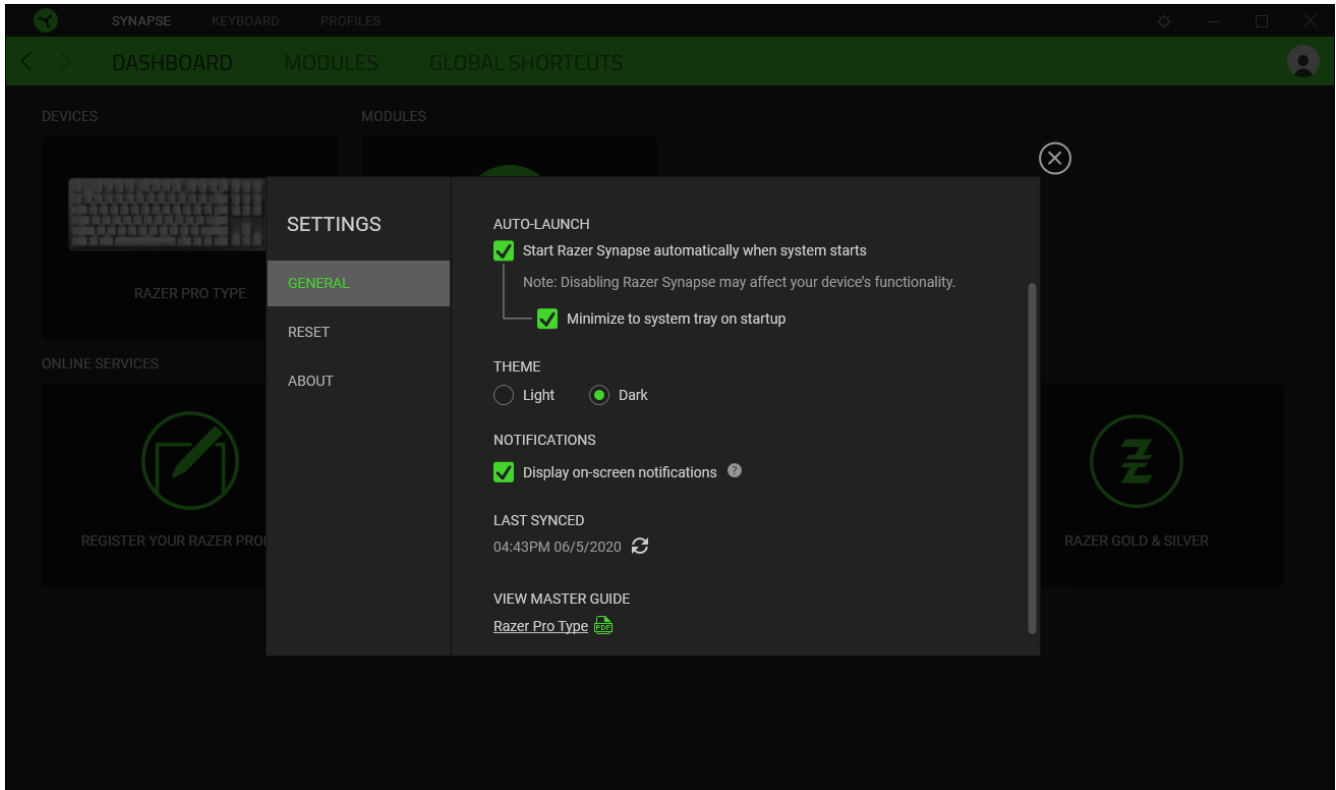

### General tab

The default tab of the Settings window. The General tab enables you to change the software's display language, start-up behavior, and display theme. You may also manually sync your profiles to the cloud (↻) or view the master guide of all connected Razer devices and installed modules.

### Reset tab

The Reset tab allows you to perform a factory reset on any connected Razer device and/or reset Razer Synapse tutorials to acquaint yourself again with Razer Synapse's new features on its next launch.

**!** *By resetting a Razer device, all profiles on the selected device and its on-board memory (if present) will be erased.*

**About tab**

The About tab displays brief software information and copyright statement and provides relevant links for its terms of use. You may also use this tab to check for software updates, or as a quick access to Razer's social communities.

---

## 7. SAFETY AND MAINTENANCE

### SAFETY GUIDELINES

In order to achieve maximum safety while using your Razer Pro Type, we suggest that you adopt the following guidelines:

Should you have trouble operating the device properly and troubleshooting does not work, unplug the device and contact the Razer hotline or go to [support.razer.com](https://support.razer.com) for assistance.

Don't take apart the device (doing so will void your warranty) and don't attempt to operate it under abnormal current loads.

Keep the device away from liquid, humidity or moisture. Operate the device only within the specific temperature range of 0°C (32°F) to 40°C (104°F). Should the temperature exceed this range, unplug and/or switch off the device in order to let the temperature stabilize to an optimal level.

### COMFORT

Research has shown that long periods of repetitive motion, improper positioning of your computer peripherals, incorrect body position, and poor habits may be associated with physical discomfort and injury to nerves, tendons, and muscles. Below are some guidelines to avoid injury and ensure optimum comfort while using your Razer Pro Type.

1. Position your keyboard and monitor directly in front of you with your mouse next to it. Place your elbows next to your side, not too far away and your keyboard within easy reach.
2. Adjust the height of your chair and table so that the keyboard and mouse are at or below elbow height.
3. Keep your feet well supported, posture straight and your shoulders relaxed.
4. During gameplay, relax your wrist and keep it straight. If you do the same tasks with your hands repeatedly, try not to bend, extend or twist your hands for long periods.
5. Don't rest your wrists on hard surfaces for long periods.
6. Use a wrist rest to support your wrist while gaming.
7. Customize the keys on your keyboard to suit your style of gaming in order to minimize repetitive or awkward motions while gaming.
8. Don't sit in the same position all day. Get up, step away from your desk and do exercises to stretch your arms, shoulders, neck and legs.

If you should experience any physical discomfort while using your keyboard, such as pain, numbness, or tingling in your hands, wrists, elbows, shoulders, neck or back, please consult a qualified medical doctor immediately.

## **MAINTENANCE AND USE**

The Razer Pro Type requires minimum maintenance to keep it in optimum condition. Once a month we recommend you switch off, unplug the device from the computer, and clean it using a soft cloth or cotton swab to prevent dirt buildup. Don't use soap or harsh cleaning agents.

---

## 8. LEGALESE

### **COPYRIGHT AND INTELLECTUAL PROPERTY INFORMATION**

©2020 Razer Inc. All rights reserved. Razer, the triple-headed snake logo, Razer logo, and “For Gamers. By Gamers.”, are trademarks or registered trademarks of Razer Inc. and/or affiliated companies in the United States or other countries. All other trademarks are the property of their respective owners.

The Bluetooth® word mark and logos are registered trademarks owned by Bluetooth SIG, Inc. and any use of such marks by Razer is under license.

Windows and the Windows logo are trademarks of the Microsoft group of companies.

Razer Inc. (“Razer”) may have copyright, trademarks, trade secrets, patents, patent applications, or other intellectual property rights (whether registered or unregistered) concerning the product in this guide. Furnishing of this guide does not give you a license to any such copyright, trademark, patent or other intellectual property right. The Razer Pro Type (the “Product”) may differ from pictures whether on packaging or otherwise. Razer assumes no responsibility for such differences or for any errors that may appear. Information contained herein is subject to change without notice.

### **LIMITED PRODUCT WARRANTY**

For the latest and current terms of the Limited Product Warranty, please visit [razer.com/warranty](https://www.razer.com/warranty).

### **LIMITATION OF LIABILITY**

Razer shall in no event be liable for any lost profits, loss of information or data, special, incidental, indirect, punitive or consequential or incidental damages, arising in any way out of distribution of, sale of, resale of, use of, or inability to use the Product. In no event shall Razer’s liability exceed the retail purchase price of the Product.

### **GENERAL**

These terms shall be governed by and construed under the laws of the jurisdiction in which the Product was purchased. If any term herein is held to be invalid or unenforceable, then such term (in so far as it is invalid or unenforceable) shall be given no effect and deemed to be excluded without

invalidating any of the remaining terms. Razer reserves the right to amend any term at any time without notice.