



# KoiBox-100W

## User Guide

# Contents

## 1. Preface

About This Guide.....	3
Audience.....	3
Document Conventions.....	3

## 2. Product Overview

About KoiBox-100W.....	4
Hardware Specifications.....	4
Components.....	5
Front Panel.....	6
Rear Panel.....	6
Drive Numbering.....	7
Package Contents.....	7
Safety Information.....	7
Installation Requirements.....	8

## 3. Installation and Configuration

Hardware Installation.....	10
Drive Installation.....	10
Setting Up KoiBox.....	13
Initializing KoiMeeter.....	15

## 4. Basic Operations

Power Button.....	17
Reset Button.....	17
Audio Alert.....	18
LEDs.....	18
User Interface.....	18
HDMI Display Interface.....	19
Web Browser Interface.....	19
Using the App.....	20
Remote Control.....	20
Keyboard Controls.....	21
Mouse Control.....	22

## 5. Private Meeting

Starting a One-to-One Video Conference.....	24
Starting a 4-Way Video Conference.....	25
Joining or Declining a Video Conference.....	26

## 6. Cloud Meeting

Joining a Cloud Meeting.....	28
------------------------------	----

## 7. Video Recordings

Recording a Video Conference.....	29
Making a Video Tutorial.....	29
Managing Recording Files.....	30

## 8. Chat

Sending Messages Using Chat.....	32
----------------------------------	----

Sending Files Using Chat.....	34
<b>9. Wireless Projection</b>	
Insight View Interface.....	36
PIN Code Screen.....	36
Meeting Room Name.....	36
People Count.....	36
Wireless Projection Settings.....	36
Accessing Insight View.....	37
Wireless Screen Sharing.....	37
<b>10. System Settings</b>	
Configuring Network Settings.....	40
Configuring Recording Disk Settings.....	41
Performing Equipment Test.....	42
Updating KoiMeeter.....	43
<b>11. Meeting &amp; Contact Settings</b>	
Logging in to the Meeting & Contact Settings.....	44
Meeting & Contact Settings Interface.....	44
Meeting Minutes.....	46
AddressBook.....	47
Settings.....	47
Link Manager.....	49
Share Screen.....	50
<b>12. Troubleshooting</b>	
Forcing Qfinder Pro or myQNAPcloud to Locate the Device.....	51
Support and Other Resources.....	51
<b>13. Glossary</b>	
KoiBox.....	52
KoiMeeter.....	52
myQNAPcloud.....	52
Qfinder Pro.....	52
QNE Embedded.....	52
<b>14. Notices</b>	
Limited Warranty.....	53
Disclaimer.....	53
GNU Public License.....	53
CE Notice.....	61
UKCA Notice.....	61
FCC Notice.....	61
VCCI Notice.....	62
BSMI Notice.....	62
SJ/T 11364-2006.....	62

# 1. Preface





## About This Guide

This guide provides information about the device and step-by-step instructions on installing the hardware. It also provides instructions on basic operations and troubleshooting information.

## Audience

This document is intended for consumers and storage administrators. This guide assumes that the user has a basic understanding of storage and backup concepts.

## Document Conventions

Symbol	Description
	Notes provide default configuration settings and other supplementary information.
	Important notes provide information on required configuration settings and other critical information.
	Tips provide recommendations or alternative methods of performing tasks or configuring settings.
	Warnings provide information that, when ignored, may result in potential loss, injury, or even death.

## 2. Product Overview

This chapter provides basic information about the QNAP device.

### About KoiBox-100W

The KoiBox-100W is a dedicated video conference solution that runs the QNAP video conference software, KoiMeeter. The KoiBox-100W comes with expandable storage that supports one 2.5-inch hard drive for easy backup and recording of video conference meetings, an HDMI 1.4b port for high-resolution videos during conferences, and 4 USB Type-A ports for connecting video conference equipment. The KoiBox-100W allows you to host up to four-way video conferences, record ongoing video conferences, or make video tutorials for sharing. The device also offers flexible network connectivity, including stable 1GbE Ethernet connectivity or wireless WiFi 6 connectivity.

### Hardware Specifications



#### Warning

If your QNAP product has hardware defects, return the product to QNAP or a QNAP-authorized service center for maintenance or replacement. Any attempt to repair or perform maintenance procedures on the product by you or an unauthorized third party invalidates the warranty.

QNAP is not responsible for any damage or data loss caused by unauthorized modifications and installation of unsupported third-party applications.

For details, see the [QNAP Warranty Terms and Conditions](#).



#### Tip

Model specifications are subject to change without prior notice. To see the latest specifications, go to <https://www.qnap.com>.

Ordering P/N	CPU	Memory	Power supply
KoiBox-100W	Intel® Celeron® Processor 6305	4 GB	Single

Component	KoiBox-100W
Processor	
CPU	Intel® Celeron® Processor 6305
Frequency	Dual-core/ 2-thread 1.8GHz
Architecture	x86 64-bit
Encryption engine	AES-NI
Memory	
Pre-installed memory	4 GB RAM
Maximum memory	4 GB RAM: 1 x 4 GB
Flash memory	30 GB SSD
Storage	
Drive bays	1 x 2.5-inch SATA 6 Gbps
Drive compatibility	2.5-inch bays: <ul style="list-style-type: none"> <li>• 2.5-inch SATA hard disk drives</li> <li>• 2.5-inch SATA solid-state drives</li> </ul>

Component	KoiBox-100W
Network	
Gigabit network interface	1 x GbE RJ45
Wi-Fi	Intel Wi-Fi 6 AX201 (802.11ax)
Bluetooth	Bluetooth 5.2
External I/O Ports & Expansion Slots	
USB ports	4 x USB 3.1 Gen 2 Type-A
HDMI ports	1 x HDMI 1.4b (up to 3840 x 2160 resolution at 30 Hz)
Interface	
IR sensor	1
Buttons	<ul style="list-style-type: none"> <li>• Power</li> <li>• Reset</li> </ul>
Dimensions	
Dimensions (H x W x D)	232 x 152.05 x 45 mm (9.13 x 5.99 x 1.77 inch)
Net weight	1.09 kg (2.40 lbs)
Others	
Power supply unit	36W, 100-240V DC, 50/60Hz
System battery	CR2032 lithium battery (3V, 225 mAh)
Sound level	16.0 dB(A) <div style="margin-top: 10px;">  <p><b>Note</b> The sound level was tested at a bystander position, which is within one meter of the NAS. The test NAS operated at low speed with the maximum number of drives installed.</p> </div>
Fans	CPU: 1 x 60 mm 12V DC fan
Operating temperature	0°C to 40°C (32°F to 104°F)
Relative humidity	<ul style="list-style-type: none"> <li>• Non-condensing relative humidity: 5% to 95%</li> <li>• Wet-bulb temperature: 27°C (80.6°F)</li> </ul>
Security slot	Kensington security slot

**Tip**

For the list of compatible drive models, go to <https://www.qnap.com/compatibility>.

## Components

## Front Panel

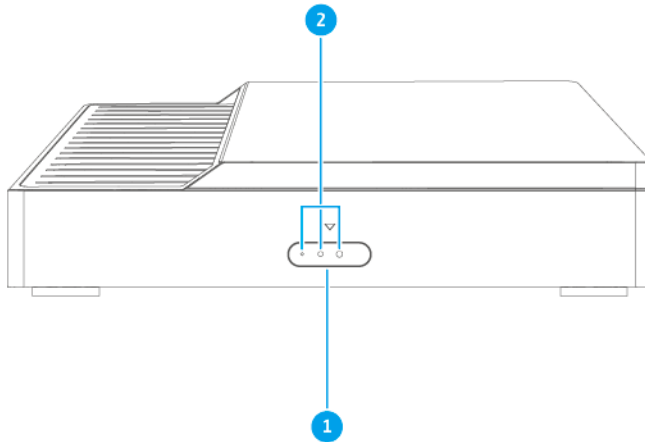

No.	Component	No.	Component
1	Power button	2	Status LED

## Rear Panel

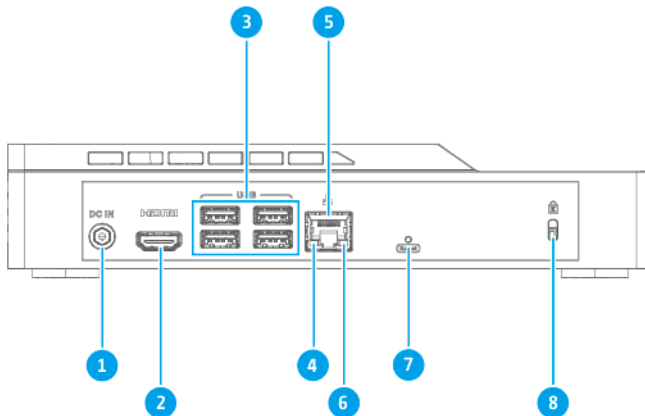

No.	Component	No.	Component
1	Power input	5	Gigabit Ethernet port (RJ45)
2	HDMI 1.4b port	6	Gigabit Ethernet speed LED
3	USB 3.1 Gen 2 Type-A ports	7	Reset button
4	Gigabit Ethernet activity LED	8	Kensington security slot

## Drive Numbering

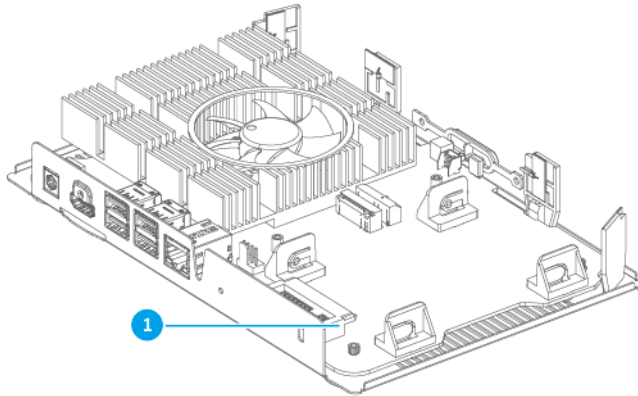

### Note

This image shows the KoiBox-100W drive bay with the cover removed.

## Package Contents

Item	Quantity
KoiBox-100W	1
AC power adapter	1
Power cord	1
Ethernet cable	1 x 1GbE (Cat5e)
Remote control	1
Quick Installation Guide (QIG)	1

## Safety Information

The following instructions help ensure personal safety and environmental safety. Read these instructions carefully before performing any operation.

### General Instructions

- The device should be stored in a secure location with restricted access, controlled through the use of a tool, lock and key, or any means of security.
- Only qualified, skilled, and authorized persons with knowledge of all restrictions, safety precautions, and installation and maintenance procedures should have physical access to the device.
- To avoid potential injury or damage to components, ensure that the drives and other internal system components have cooled before touching them.
- Observe electrostatic discharge (ESD) procedures to avoid potential injury or damage to components.



**Power**

- To reduce the risk of fire or electric shock, ensure that you only connect the power cord to a properly grounded electrical outlet.



Devices with redundant power supply may have one or more power supply unit (PSU) cords. To avoid serious injuries, a trained service technician must disconnect all PSU cords from the device before installing or replacing system components.

**System Battery**

- To avoid potential battery explosion, causing injury or damage to components, ensure that you replace the existing battery with a battery of the same type.
- Dispose of used batteries properly according to local regulations or the instructions of the battery manufacturer.

**Moving Parts**



**Moving fan blades:** Keep your body parts away from moving fan blades while the device is connected to a power source.



**Moving components:** Keep your body parts away from other moving components.

**Installation Requirements**

Category	Item
Environment	<ul style="list-style-type: none"> <li>• Room temperature: 0°C to 40°C (32°F to 104°F)</li> <li>• Non-condensing relative humidity: 5% to 95%</li> <li>• Wet-bulb temperature: 27°C (80.6°F)</li> <li>• Flat, anti-static surface without exposure to direct sunlight, liquids, or chemicals</li> <li>• Free from objects that may obstruct the device ventilation or apply pressure to the device or power cord</li> </ul>
Hardware and peripherals	<ul style="list-style-type: none"> <li>• Storage drives</li> <li>• Network cable</li> <li>• Remote control</li> </ul>

Category	Item
Tools	<ul style="list-style-type: none"><li data-bbox="614 255 981 286">• Phillips #1 or #2 screwdriver</li><li data-bbox="614 315 901 347">• Flat head screwdriver</li><li data-bbox="614 376 901 407">• Anti-static wrist strap</li></ul>

## 3. Installation and Configuration

This chapter provides specific hardware and firmware installation and configuration steps.

### Hardware Installation

This section provides information on installing drives.

#### Drive Installation

The KoiBox-100W is compatible with 2.5-inch hard drive and 2.5-inch solid-state drives.

#### Installing a 2.5-inch Hard Drive or Solid-State Drive



##### Warning

- Installing a drive deletes all data on the drive.
- Observe electrostatic discharge (ESD) procedures to avoid damage to components.

•



**Moving fan blades:** Keep your hands and other body parts away from moving fan blades.

•



**Other moving components:** Keep your hands and other body parts away from other moving components.

1. Power off the device.
2. Disconnect all cables.
3. Remove the case cover.
  - a. Turn the device upside down.
  - b. Remove the screws.

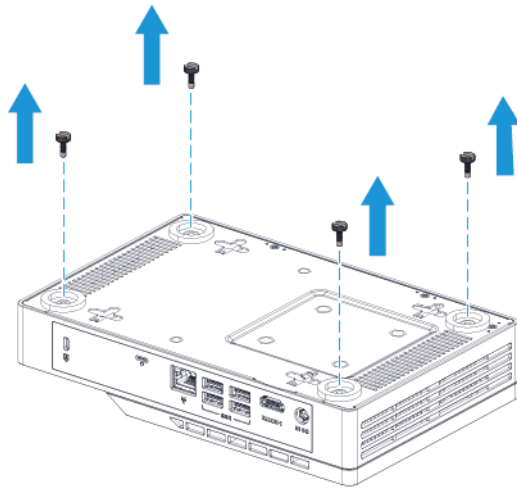

- c. Position the device in its upright position.
- d. Lift the cover off the device.

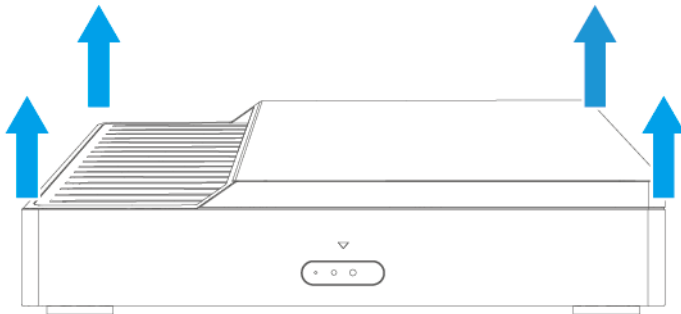

- 4. Insert the drive into the drive bay.

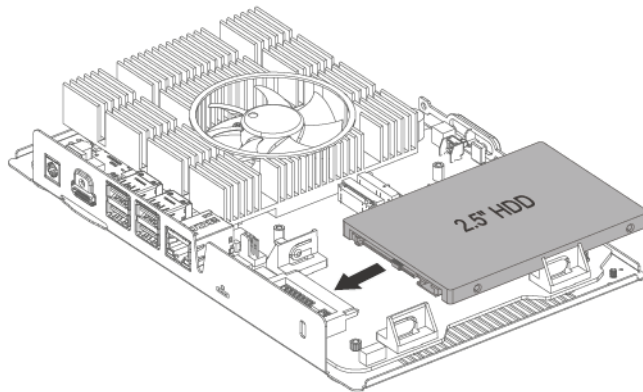
**Note**

Push the drive until it is fully connected to the drive connector and the clips secure the drive into place.

5. Attach the case cover.
  - a. Place the cover onto the device.

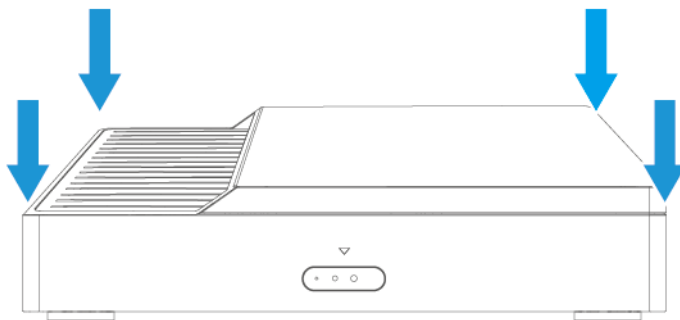

- b. Turn the device upside down.
    - c. Attach the screws.

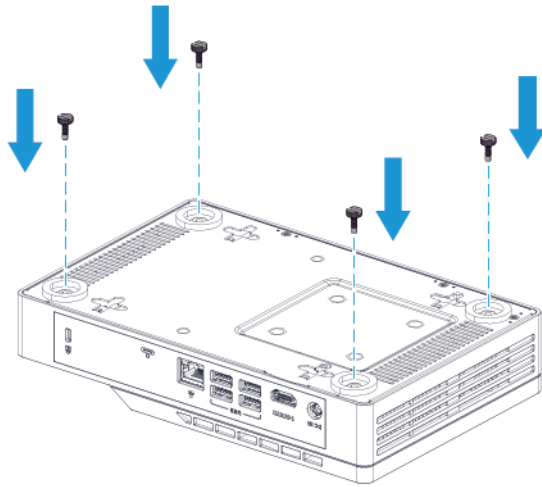

6. Position the device in its upright position.

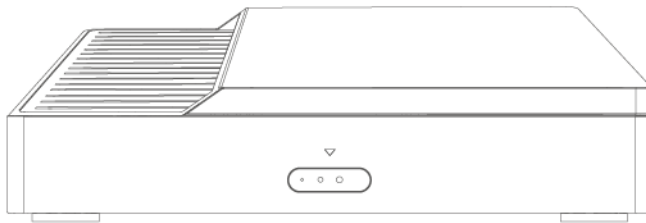

7. Power on the device.

## Setting Up KoiBox



### Important

- You must connect a USB camera or microphone to KoiBox-100W to enable video conference features.
- You must connect a USB keyboard to KoiBox-100W to enable Self-Encrypted Disk (SED) encryption.
- Connecting a USB mouse to KoiBox-100W is optional.

For more information about KoiMeeter compatible devices, go to <https://www.qnap.com/go/product/koibox-100w>.

1. Connect the router to the device.
  - a. Connect the Gigabit Ethernet cable to the Gigabit Ethernet port on the device.
  - b. Connect the Gigabit Ethernet cable to the Gigabit Ethernet port on the router.
2. Connect an HDMI display to the device.
  - a. Connect the HDMI cable to the HDMI port on the device.
  - b. Connect the HDMI cable to the HDMI port on the HDMI display.
3. Connect the device to a power source.
  - a. Connect the device to a power adapter.
  - b. Connect the device power adapter to an electrical outlet.
4. Power on the device.

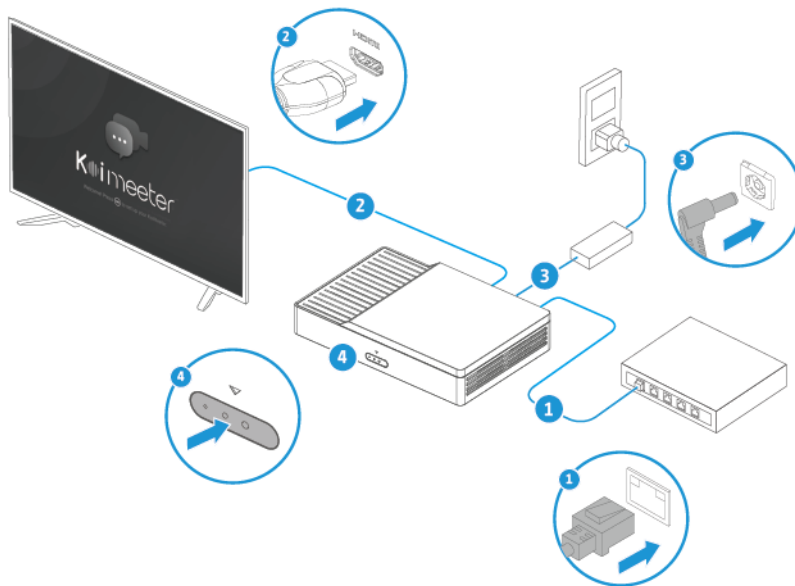

5. Connecting USB devices to KoiBox-100W.
  - a. Connect the USB cable to the USB 3.1 Gen 2 Type-A port on KoiBox-100W.
  - b. Connect the USB cable to the USB 3.1 Gen 2 Type-A port on the USB device.
6. Power on the device.

7. The welcome page appears.



**Note**  
The welcome page may take a few minutes to load.

## Initializing KoiMeeter

**Warning**  
Formatting a hard disk will delete all data on it.

**Note**  
The hard disk is optional and requires additional purchase.

1. Power on the device.  
The **Welcome** page appears.

**Note**  
The welcome page may take a few minutes to load.

2. Press **OK** on the remote control.
3. Select a language.
4. Select **Next**.  
The **Network Settings** page appears.
5. Configure the Ethernet network settings.  
For details, see [Configuring Network Settings](#).



6. Select **Next**.  
The **Hard Disk Settings** page appears.
7. Configure the recording hard disk settings.  
For details, see [Configuring Recording Disk Settings](#).
8. Select **Next**.  
The **Perform Equipment Tests** page appears.
9. Perform equipment tests.  
For details, see [Performing Equipment Test](#).
10. Select **Return to Home**.  
The **KoiMeeter Guide** page appears.
11. Select **Navigation** to view the guide.
12. Optional: Select **OK** to skip the guide.
13. Return to the main page.
  - Setup is completed.
  - The KoiCode is automatically generated and saved on your device.

**Important**

The KoiCode is required for starting a 4-way video conference.  
For details, see [Starting a 4-Way Video Conference](#).

## 4. Basic Operations

This chapter describes basic KoiBox-100W operations.

### Power Button

Operation	User Action	Result
Power on	Press the button once.	The device powers on.
Power off	Press and hold the button for 3 seconds.	The device powers off.
Force power off	Press and hold the button for 8 seconds.	The device powers off.   <b>Important</b> Use this method only when the device is unresponsive.

### Reset Button



#### Important

- If you forget the password, you can reset the device and log in to manage your account and password. A temporary account "system-maintainer" is created after resetting the device. You can log in with the "system-maintainer" account to change the default "user" account password. The default "user" account has administrator privileges.
- For security reasons, the "system-maintainer" account is only valid for 24 hours. You must log in and manage your account settings within 24 hours, or press and hold the reset button again to re-activate the account.

Operation	User Action	Result
Basic system reset	Press and hold the button for 3 seconds.	The following settings are reset to default: <ul style="list-style-type: none"> <li>• System maintainer password: The default password is the first MAC address in uppercase letters without special characters. For example, if the first MAC address is 00-08-9B-F6-15-75, then the system maintainer password would be 00089BF61575.</li> </ul>  <b>Tip</b> You can find the first MAC address with Qfinder Pro or attached to a label on the device listed as MAC1. <ul style="list-style-type: none"> <li>• Reset to the default "system-maintainer" account.</li> </ul>

## Audio Alert

Duration	Frequency	Description
Short beep (0.5 seconds)	1	<ul style="list-style-type: none"> <li>The device is starting up.</li> <li>The device is shutting down.</li> <li>The user pressed the reset button.</li> <li>The operating system was updated.</li> </ul>
Long beep (1.5 seconds)	3 (every 5 minutes)	<ul style="list-style-type: none"> <li>A power error occurred.</li> <li>The system fan is not functioning.</li> </ul>
	2	<ul style="list-style-type: none"> <li>The disk volume is about to reach full capacity</li> <li>The disk volume has reached full capacity.</li> </ul>
	1	<ul style="list-style-type: none"> <li>The device was powered off by force shutdown (hardware shutdown).</li> </ul>

## LEDs

LEDs indicate the system status and related information when the device is powered on. The following LED information applies only when the drive is correctly installed and when the device is connected to the network or to a host.

For details on the location of the LEDs, see [Components](#).

LED	Status	Description
System Status	Red	The device is powered off.
	Flashes red every 0.5 seconds	<ul style="list-style-type: none"> <li>The system fan is not functioning.</li> <li>An error occurred when accessing (read/write) the data.</li> </ul>
	Blue	The device is powered on.
	Flashes blue	The device is on standby.
Gigabit Ethernet speed	Green	The network connection is operating at 1 Gbps.
	Orange	The network connection is operating at 100 Mbps.
	Off	There is no network connection.
Gigabit Ethernet activity	Green	A network connection has been established.
	Flashes green	The device is being accessed from the network.
	Off	There is no network connection.

## User Interface

The KoiBox-100W supports both HDMI display and web browser interfaces for performing video conference and wireless projection operations.

## HDMI Display Interface

The **Wireless Presentation** screen displays the wireless projection IP address and PIN code. From this screen you can create private meetings, join cloud meetings, place video calls, and configure wireless projection settings.



## Web Browser Interface

### PIN Code Screen

The screen appears after you enter the screen sharing IP address in your browser’s address bar.

**Tip** The PIN code is shown on the HDMI display.

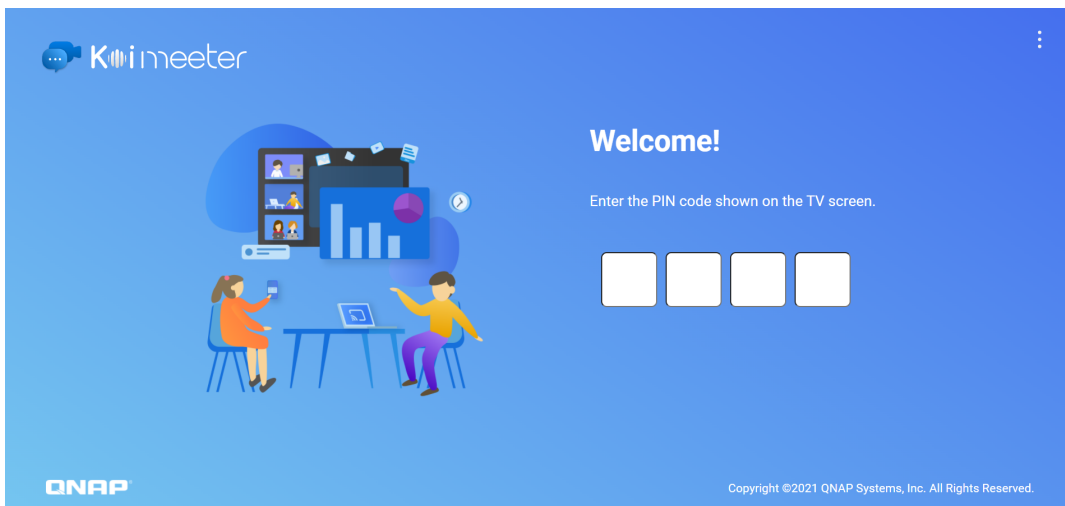

### Select Role Screen

Select a role based on the usage scenario.

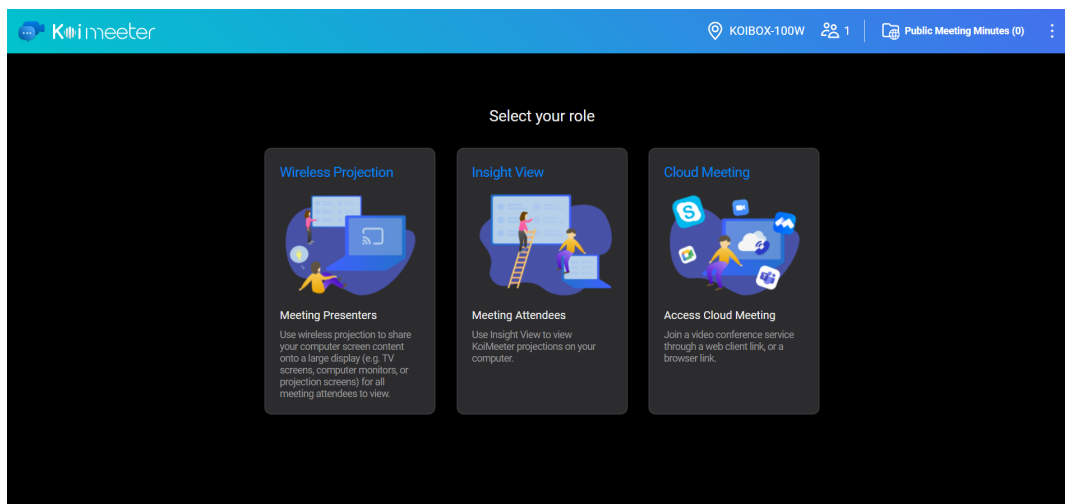

Element	Description
Wireless Projection	Select a share screen content.
Insight View	Select to view projections on your computer.
Cloud Meeting	Select to input the meeting invitation link.
Public Meeting Minutes	Select to view and play back any recorded meetings with public access permissions.
Room Name	Show the name of a meeting room.
People Count	Show the total number of people that joined the current screen sharing session.
Settings	Click to configure settings.
Share	Click to replace the content on the display with your shared content.
Chat	Send group messages or files to other participants during a screen sharing session.

## Using the App

KoiMeeter provides multiple input and control methods. In addition to keyboard control, it also supports remote control and computer mouse navigation.

## Remote Control

If your QNAP device has a built-in IR sensor, you can navigate KoiMeeter with a remote control. The following table describes the remote control general navigation functions.



### Note

Your QNAP device remote control may require a separate purchase. For details, see your device user guide Hardware Specification topic or go to [QNAP Accessories Store](#).

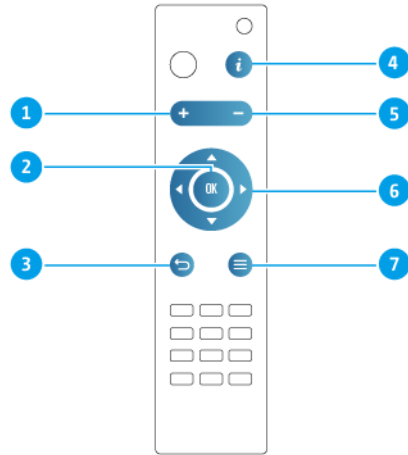







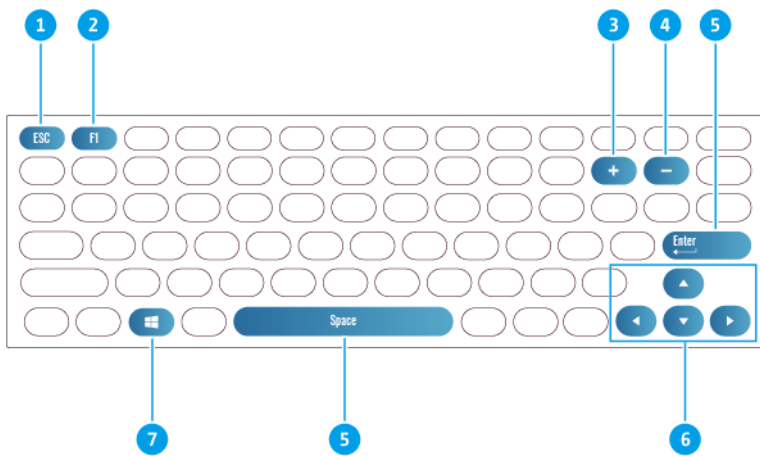



No.	Button	Action	No.	Button	Action
1	+	Volume up	6	<b>Up</b>	Navigate up
2	<b>OK</b>	Select		<b>Right</b>	Navigate to the right
3	<b>Return</b>	Returns to previous page		<b>Down</b>	Navigate down
4	<b>i</b>	Displays information about the KoiMeeter app		<b>Left</b>	Navigate to the left
5	-	Volume down	7	<b>Menu</b>	Displays the menu

### Keyboard Controls

The following table describes KoiMeeter keyboard controls and functions.



No.	Key	Action	No.	Key	Action
1		Returns to previous page	6		Navigate up
2		Displays information about the KoiMeeter app			Navigate to the right
3		Volume up			Navigate down
4		Volume down			Navigate to the left
5	 	Select options	7		Displays menu

## Mouse Control

The following table lists common mouse commands for navigating KoiMeeter.

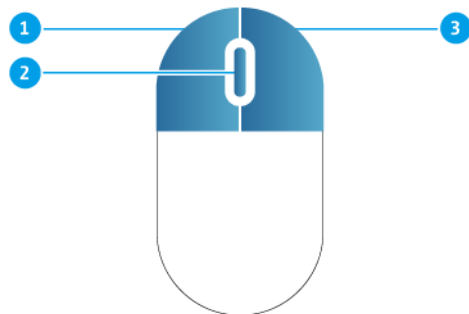

No.	Button	Action
1	<b>Left click</b>	Click once to select options
2	<b>Scroll wheel</b>	Roll the wheel up or down to scroll vertically
3	<b>Right click</b>	Click to return to the previous page





## 5. Private Meeting

### Starting a One-to-One Video Conference









KoiMeeter's HDMI interface allows you to make video calls.



1. Select **Private Meeting**.  
The **Calls** screen appears.
2. Enter an IP address using one of the following methods:
  - a. Go to **Call History** or **AddressBook** to select an IP address.
  - b. Go to **Dial Pad** to manually enter an IP address.
3. Choose the **Select** option from one of the following control methods:

Control Methods	Process
Keyboard	Press <b>Enter</b> or <b>Space bar</b> .
Remote Control	Click <b>OK</b> .
Mouse	Single click.

KoiMeeter calls the specified room or IP address. You can proceed to the next step if the room or IP address answers the call.

4. Perform any of the following actions during a call.

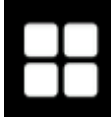
Task	Action
End the call	Click  .
Record the session	Click   <b>Tip</b> Click the icon again to stop recording.  <b>Note</b> This feature is only available on the licensed version of KoiMeeter.
Turn off the camera	Click   <b>Tip</b> Click the icon again to turn on the camera.
Mute the microphone	Click   <b>Tip</b> Click the icon again to unmute.

Task	Action
Change layout	<p>Click .</p> <p> <b>Tip</b> Change to different video call and screen sharing layouts based on your needs.</p>

- Optional: Start wireless screen sharing.



#### Note

For details, see [Wireless Screen Sharing](#).

## Starting a 4-Way Video Conference

KoiMeeter's HDMI interface allows you to make a 4-way video call using KoiCode.



#### Important

You must end an ongoing one-on-one video conference before starting a 4-way video call.



#### Tip

The KoiCode for your device can be located on the KoiMeeter main page or go to **Settings** > **About**.









- Select **Private Meeting**.  
The **Calls** screen appears.
- Select one of the following call methods:

Method	User Action
<b>AddressBook</b>	<ol style="list-style-type: none"> <li>Go to <b>AddressBook</b>.</li> <li>Select a KoiCode.</li> </ol>
<b>Call History</b>	<ol style="list-style-type: none"> <li>Go to <b>Call History</b>.</li> <li>Select a KoiCode.</li> </ol>
<b>Dial Pad</b>	<ol style="list-style-type: none"> <li>Go to <b>Dial Pad</b>.</li> <li>Enter the KoiCode.</li> </ol>

- Choose the **Select** options from one of the following control methods:

Control Methods	Process
Remote control	Click <b>OK</b> .
Keyboard	Press <b>Enter</b> or <b>Space bar</b> .
Mouse	Single click.

- Perform any of the following actions during a call.

Task	Action
End the call	Click  .
Record the session	Click  .  <b>Tip</b> Click the icon again to stop recording.  <b>Note</b> This feature is only available on the licensed version of KoiMeeter.
Turn off the camera	Click  .  <b>Tip</b> Click the icon again to turn on the camera.
Turn on the camera	Click  .
Mute the microphone	Click  .  <b>Tip</b> Click the icon again to unmute.
Unmute the microphone	Click  .
Change layout	Click  .  <b>Tip</b> Change to different video call and screen sharing layouts based on your needs.

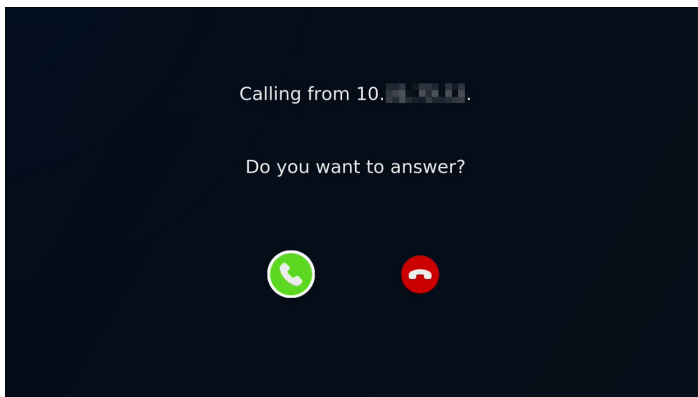

## Joining or Declining a Video Conference

You must have a compatible KoiMeeter device to join a video conference.



**Shows an incoming video call.**

Perform any of the following actions.

Task	Action
Accept call	Click  .
Decline call	Click  .



**Note**

If you have disabled **Auto answer calls** in the KoiMeeter app, the video call automatically cancels when there is no response after more than one minute.

## 6. Cloud Meeting

### Joining a Cloud Meeting

KoiMeeter's HDMI interface supports Cloud Meeting applications, including Zoom, Skype, and Microsoft Teams. Cloud Meeting is a communication technology that allows people to conduct online video conferences through the public cloud via a digital device, such as a laptop, computer, or mobile phone. KoiMeeter allows you to join a Cloud Meeting application video conference through the application web client link or a web browser link. For details, see the instructions below.



#### Important

A keyboard and mouse are required for the Cloud Meeting feature.

1. Select **Cloud Meeting**.
2. Select one of the following methods:

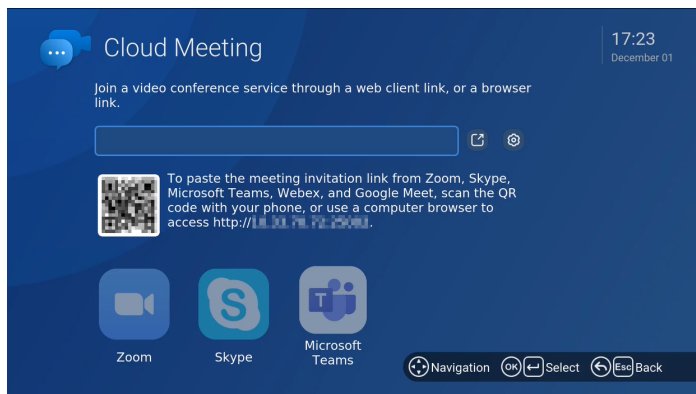

Method	Steps
Enter the web browser link	<ol style="list-style-type: none"> <li>a. Enter the browser link.</li> <li>b. Click .</li> </ol>
Scan the QR code	<ol style="list-style-type: none"> <li>a. Use a mobile phone to scan the QR code.</li> <li>b. Enter the meeting invitation link into the input field on the phone.</li> <li>c. Click <b>OK</b>.</li> </ol>
Enter the web client link	Select one of the applications.

## 7. Video Recordings

KoiMeeter allows you to record a meeting, make a video tutorial, and manage your video recordings.

### Recording a Video Conference

KoiMeeter allows all video conference attendees to record the ongoing video conference.







For details, see the following topics:



- [Starting a One-to-One Video Conference](#)
- [Starting a 4-Way Video Conference](#)

### Making a Video Tutorial

KoiMeeter will only record content displayed by the tutorial creator.

1. Select **Record**.  
The local camera screen appears and starts recording automatically.
2. Perform any of the following actions during this private session.

Task	Action
End the session	Click  .
Stop recording the session	Click  .   <b>Tip</b> Click the icon again to start recording.
Turn off the camera	Click  .
Turn on the camera	Click  .
Mute the microphone	Click  .
Unmute the microphone	Click  .

Task	Action
Change Layout	 <p>Click .</p> <p> <b>Tip</b> KoiMeeter provides different camera and screen sharing layouts to fit your specific use cases.</p>



## Managing Recording Files

KoiMeeter's HDMI interface allows you to view and play back recording files with public access permission.

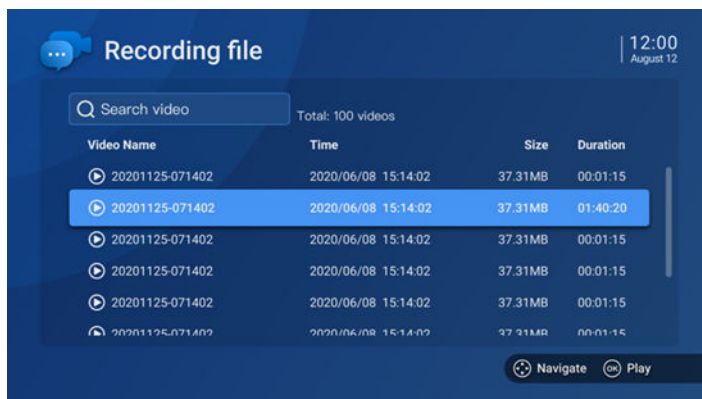
1. Select **Recordings**.  
The recording files list screen appears.





2. Choose the **Navigate** option from one of the following control methods.



Control Methods	Process
Remote Control	Click <b>Up/Down</b> .
Keyboard	Press   .
Mouse	Move the cursor.

3. Choose the **Play** option from one of the following control methods.

Control Methods	Process
Remote Control	Click <b>OK</b> .
Keyboard	Press <b>Enter</b> or <b>Space bar</b> .
Mouse	Single click.

4. Perform any of the following actions during video playback.

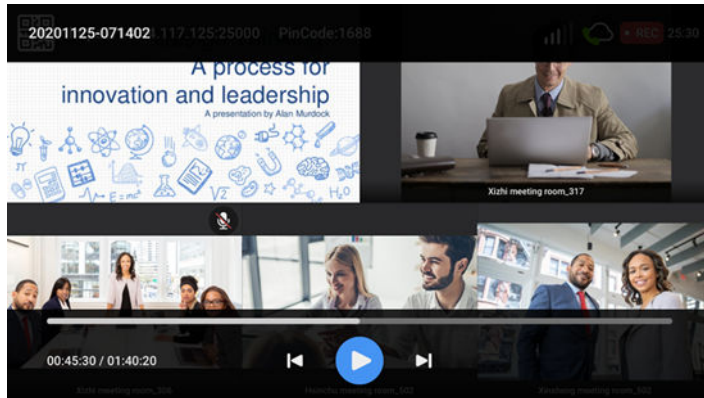

Task	Process
Play video	Click  .
Pause video	Click  .

Task	Process
Move to the next video clip	Click  .
Move to the previous video clip	Click  .
Exit playback and return to the recording files list	Click <b>Back</b> .



## 5. Search videos.

- a. Select the **Search videos** area using one of the following methods:

Control Methods	Process
Remote Control	Press  to return to the top.
Keyboard	Press  to return to the top.
Mouse	Click on the <b>Search videos</b> area.

- b. Enter a keyword.  
KoiMeeter displays the videos that match the keywords.





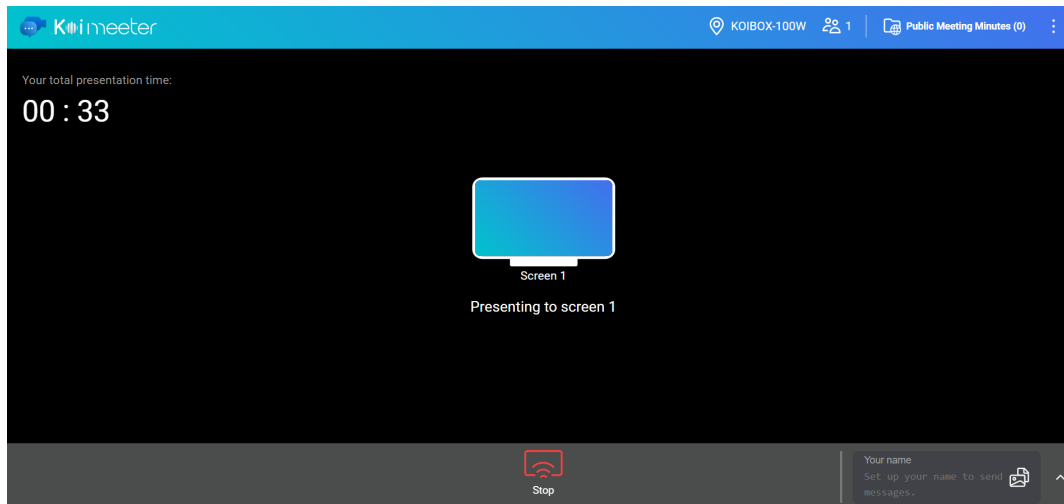

## 8. Chat

You can use the Insight View built-in chat feature to send group messages or files to other conference participants during a wireless screen-sharing session.

For details about wireless screen sharing, see [Wireless Screen Sharing](#).



The following table describes actions you can perform in Chat:

No.	Element	Action
1	The <b>Messages</b> window	Click  to view chat history.
2	Username	Click on the blue text to specify or modify your chat username.
3	Text box	Click on the gray text to enter your chat message.
4	Upload files	Click  .
5	Expand or collapse	<ul style="list-style-type: none"> <li>Click  to expand the <b>Messages</b> window.</li> <li>Click  to collapse the <b>Messages</b> window.</li> </ul>

### Sending Messages Using Chat

1. Click the chat box in Insight View.

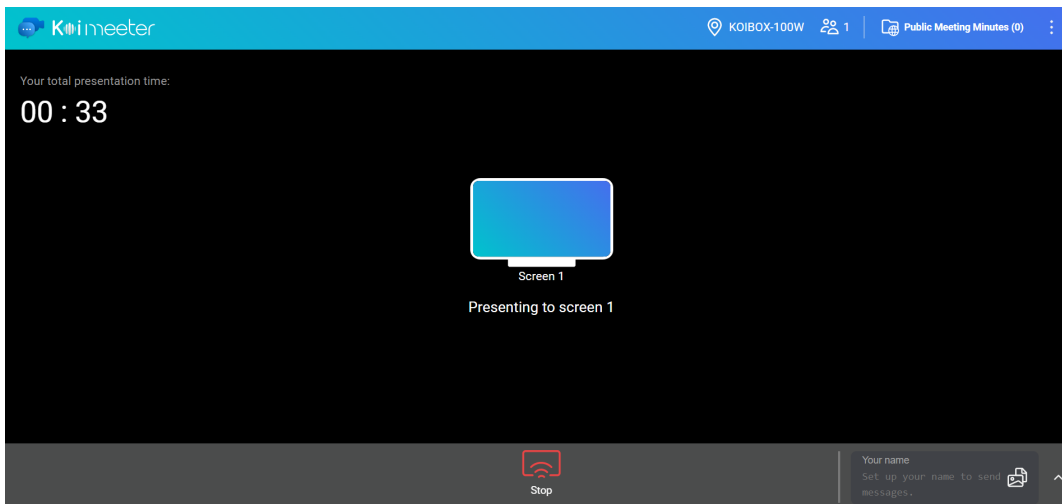

2. Optional: Set a chat username.



### Tip

You must specify a username when you use chat for the first time.

- a. Click **Your name**.
  - b. Specify your chat username.  
Username requirements:
    - Valid characters: A-Z, a-z, 0-9
    - Valid special characters: Exclamation mark (!), At symbol (@), Number sign (#), Dollar sign (\$), Percentage (%), Circumflex (^), Ambersand (&), Asterisk (\*), and Hyphen (-).
3. Click **Set up your name to send messages** or **Enter your message**.
  4. Type your message.
  5. Press **Enter**.  
The message is sent to other conference participants.
  6. Optional: Click  to view chat history.

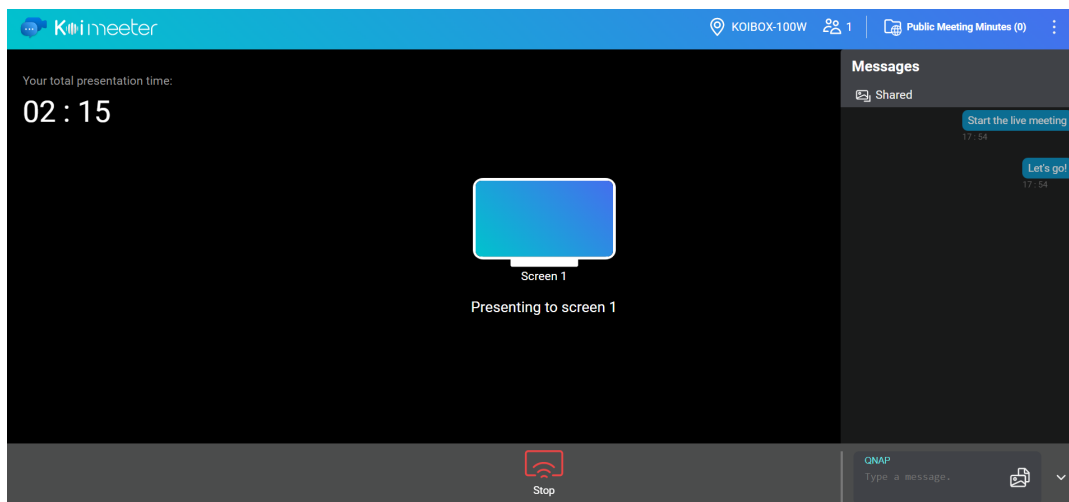

- The **Messages** window appears in the right panel.
- All sent messages will appear in the **Messages** window.



#### Note

All chat messages are automatically saved and uploaded to **Meeting Minutes** in the KoiMeeter app when the wireless screen sharing session ends.

## Sending Files Using Chat

1. Click the chat box in Insight View.

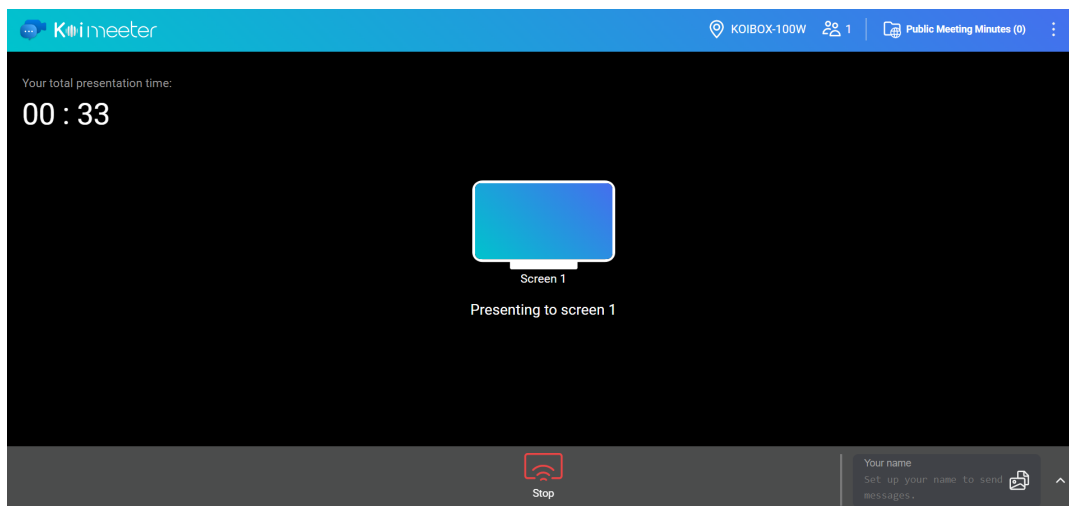

2. Optional: Set a chat username.



#### Tip

You must specify a username when you use chat for the first time.

- a. Click **Your name**.

b. Specify your chat username.

Username requirements:

- Valid characters: A-Z, a-z, 0-9
- Valid special characters: Exclamation mark (!), At symbol (@), Number sign (#), Dollar sign (\$), Percentage (%), Circumflex (^), Ambersand (&), Asterisk (\*), and Hyphen (-).

3. Click .

The upload file window appears.

4. Select a file.



**Note**

- KoiMeeter Chat supports sending texts, images, videos, and audio files.
- QNAP discourages sending large files that may exceed your network bandwidth capacity and affect the video conference or wireless screen sharing quality.

5. Click **Open**.

6. Click **OK**.

The file is uploaded.

7. Click  to view uploaded files.

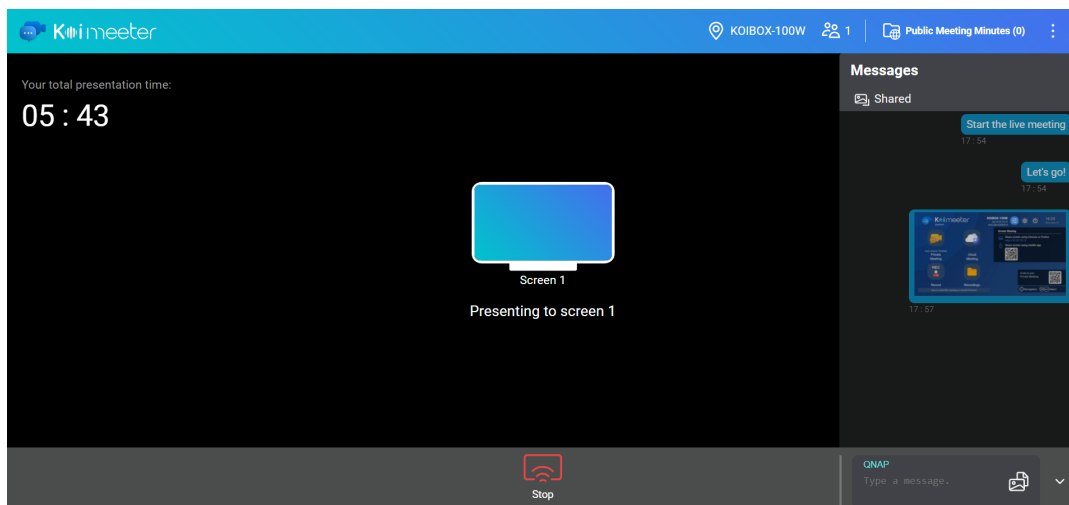

- The **Messages** window appears in the right panel.
- All uploaded files are displayed in the **Messages** window.



**Note**

All chat files are automatically saved and uploaded to **Meeting Minutes** in the KoiMeeter app when the wireless screen sharing session ends.

## 9. Wireless Projection

You can use KoiMeeter to share your presentation with others on HDMI displays or through Insight View. You can use wireless screen sharing for collaboration and for sharing content in a local conference room or remotely during a video conference.

### Insight View Interface

Insight View is a browser-based interface built into KoiMeeter for performing wireless screen sharing in real time. This interface allows you to share screens and switch between multiple HDMI display layouts. Conference participants can view your shared content by logging into the Insight View interface using the same KoiMeeter wireless projection IP address and PIN code. Insight View currently supports Google Chrome and Mozilla Firefox browsers.

### PIN Code Screen

The PIN code screen appears after you enter the wireless projection IP address in your browser's address bar.

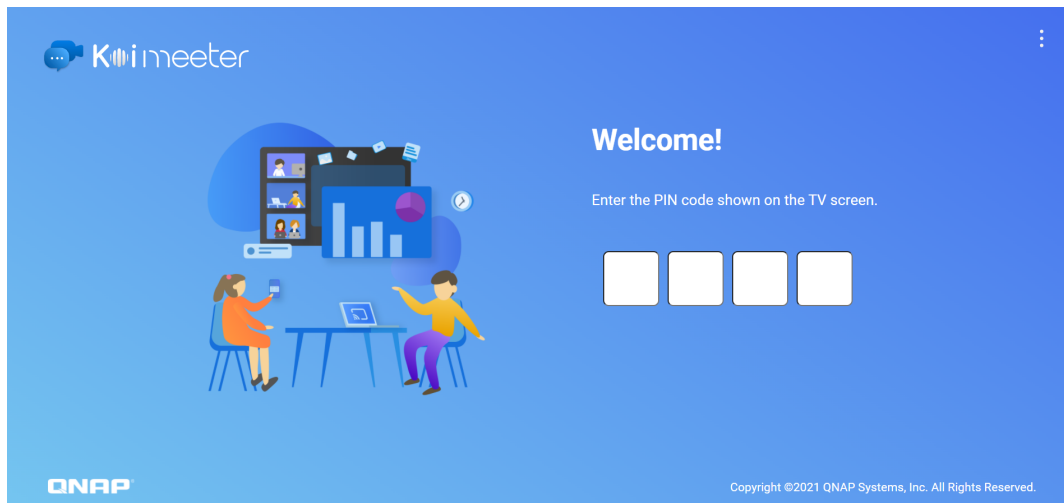

### Meeting Room Name

The  icon indicates the name of the meeting room that you have joined.

### People Count

The  icon indicates the total number of attendees that have joined the current wireless screen sharing session.

### Wireless Projection Settings

Click  to configure the Wireless Projection settings.

Settings	Description
Languages	Select Insight View language settings.

Settings	Description
<b>Tutorials</b>	View the online KoiMeeter tutorials.
<b>About</b>	View the information of version and license type.
<b>Meeting &amp; Contact Settings</b>	Access additional KoiMeeter app settings from Meeting & Contact Settings.
<b>Hardware Settings</b>	Switch to the device operating system QNE Embedded for more settings.   <b>Note</b> You must have administrator permission or the KoiBox-100W device account to access Meeting & Contact Settings and QNE Embedded.

## Accessing Insight View



### Note

KoiMeeter only supports Google Chrome and Mozilla Firefox.

1. Enter the IP address shown on the **Wireless Presentation** screen in the address bar.  
A network security warning appears.
2. Select one of the following methods:

Web Browser	Steps
Google Chrome	<ol style="list-style-type: none"> <li>a. Click <b>Advanced</b>. A warning appears.</li> <li>b. Click <b>Proceed to [wireless projection IP address] (unsafe)</b>.</li> </ol>
Mozilla Firefox	<ol style="list-style-type: none"> <li>a. Click <b>Advanced...</b> The website certificate verification information box appears.</li> <li>b. Click <b>Accept the Risk and Continue</b>.</li> </ol>

The **PIN Code Screen** window appears.



### Tip

The PIN code is shown on the HDMI display.

3. Enter the PIN code.  
The **Select** your role screen appears.
4. Select a role.



### Note

Select **Wireless Projection** if you are a presenter to share your screen with meeting members or select **Insight View** to view the shared screen on your computer as a meeting attendee.

## Wireless Screen Sharing



### Note

- KoiMeeter supports a single HDMI display setup, where the shared screen replaces the previously displayed content.

- KoiMeeter only supports Google Chrome and Mozilla Firefox.

1. Access Insight View.  
For details, see [Accessing Insight View](#).
2. Click **Share**.  
The **Share Settings** window appears.
3. Optional: Select **Auto** display setting.
4. Click **Next**.
5. Select the content that you want to share.

**Note**

Both Google Chrome and Mozilla Firefox can share your screen or a specific application. Minimizing the application will stop the wireless presentation. You can only choose to share a specific browser tab when using Google Chrome.

6. Click **Share**.



**Note**

Clicking **Share** replaces the content on the display with your shared content.

The screen you are projecting is highlighted in blue and a timer showing the presentation time appears in the left corner.

## 10. System Settings

KoiMeeter's HDMI interface allows you to view and configure settings for KoiMeeter operations.

Setting	Description
Language	Select KoiMeeter language settings.
Keyboard Layout	Select keyboard layout settings.
About	<p>Display basic software and hardware information.</p> <ul style="list-style-type: none"> <li>• Software version</li> <li>• Model</li> <li>• Serial number</li> <li>• IP/MAC address</li> </ul>
Software update	Upgrade to the latest software version.
Network	<p>View network configurations and configure Ethernet or Wi-Fi settings.</p> <p> <b>Note</b> For details, see <a href="#">Configuring Network Settings</a>.</p>
Bluetooth	<p>View Bluetooth devices connection status and perform Bluetooth pairing with KoiBox-100W.</p> <p>KoiMeeter supported Bluetooth devices include keyboards, mouse, speakers, headphones, and microphones.</p> <p>Go to <b>Added Device</b> page to view all paired devices or <b>Other Device</b> page to view available Bluetooth devices that can be connected or paired.</p>
Time Zone	Select time zone settings.
Background	Select the background pattern of the KoiMeeter home screen.
Calibrate echo canceller	Select to perform echo cancellation calibration.
Screen resolution	Select the display resolution setting.
Advanced settings	<p>Allows you to set up a recording disk, configure recording settings, and enhance video conference security and privacy.</p> <p> <b>Important</b> You must log in with an administrator account to configure advanced settings.</p> <ul style="list-style-type: none"> <li>• <b>Recording disk settings:</b> Select the hard disk you want to set up as the recording disk.</li> <li>• <b>Video recording:</b> Enable or disable the recording function.</li> <li>• <b>Recordings access permission:</b> Set the recordings access permission. You can make the recording publicly accessible or assign access permission to specific users.</li> </ul> <p> <b>Important</b> If you set the access permission to the public, all users can view the recording.</p>
Legal	Display EULA, Privacy Policy, and third-party license information.



Setting	Description
Reset	Reset system settings or restore the device to factory default settings.
Power	Execute <b>Sleep</b> , <b>Restart</b> , or <b>Shutdown</b> of the device.
Overscan	Perform overscan to prevent the edge content from being cut off on the HDMI display.
Customer Service	Contains information to contact QNAP customer support.

## Configuring Network Settings

You can view and configure Ethernet or Wi-Fi settings.



### Important

- If the Ethernet is disconnected, check the Ethernet cable connections and your network router first.
- For Wi-Fi settings, you must select the correct Wi-Fi region in compliance with local WLAN frequency laws. Note that selecting an incorrect region can cause interference.

#### 1. Select **Ethernet** or **Wi-Fi**.

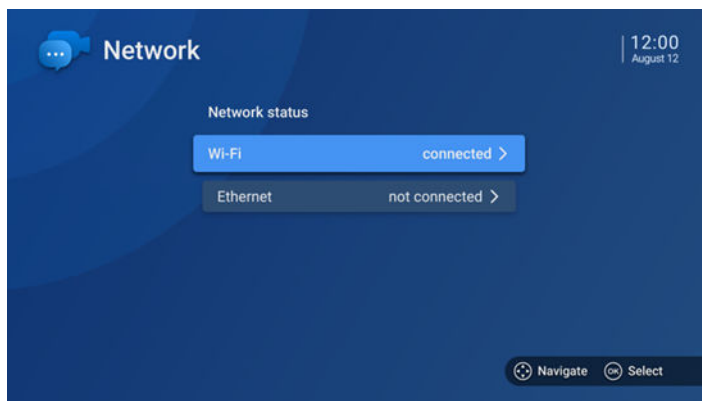

### Note

KoiMeeter runs a network connection test during initialization.

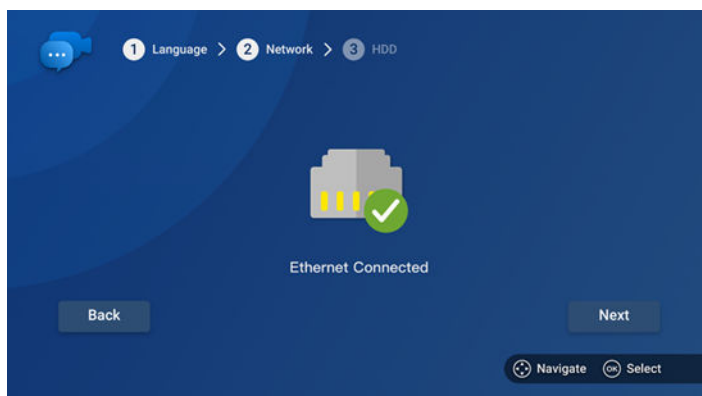

**KoiMeeter running a network connection test during initialization.**

2. Select one of the following network configuration methods:

Connectivity Type	Connectivity Status	User Actions
Ethernet	Ethernet connected	<p><b>a.</b> Select <b>Ethernet</b>.</p> <p><b>b.</b> Set an IP address.</p> <p><b>c.</b> Set a DNS address.</p>
Wi-Fi	<ul style="list-style-type: none"> <li>Ethernet disconnected</li> <li>Normal Wi-Fi connection</li> </ul>	<p><b>a.</b> Select a Wi-Fi region. The <b>Select Wi-Fi Network</b> page appears.</p> <p> <b>Tip</b> This step only appears when initializing KoiMeeter.</p> <p><b>b.</b> Select a Wi-Fi network.</p> <p><b>c.</b> View the network connectivity status.</p> <p><b>d.</b> Select the Wi-Fi connection on top to view the detailed network information.</p> <p><b>e.</b> Connect to a Wi-Fi network.</p>

3. Press **Enter**.

## Configuring Recording Disk Settings

You can set up a hard disk for storing recording files.



### Warning

You must format the hard disk before configuring disk storage. Formatting the hard disk will erase all data on the hard disk.



### Important

If the installed hard disk is a self-encrypting drive (SED), QNAP recommends configuring the SED encryption key to prevent unauthorized access and ensure the security of your recordings.



### Note

- The hard disk is an optional purchase.
- To install 2.5-inch hard disks in KoiBox-100W, see the Quick Installation Guide.

- Go to **Advanced Settings**.
- Log in to **Advanced Settings**.
- Select **Recording disk settings**.  
The **Hard Disk Setup** page appears.
- Select **OK**.  
KoiMeeter starts formatting the hard disk.



### Note

It may take several minutes to format the hard disk.

- Optional: Enable the self-encrypting drive (SED).



**Important**

Remember this SED encryption key. If you forget it, all data on this disk will become inaccessible and unrecoverable.

- Restart KoiMeeter.



**Note**

You can click **OK** to immediately restart KoiMeeter or wait 10 seconds for the app to automatically restart.

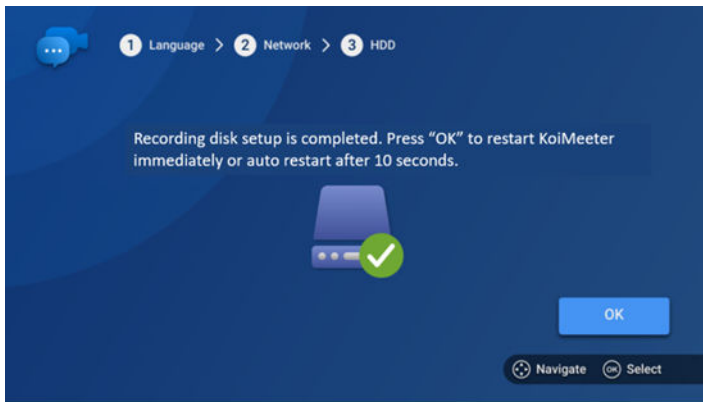

## Performing Equipment Test

KoiMeeter’s HDMI interface allows you to check the status of the connected microphone, camera, and audio output devices.

- Select **Equipment Test**.  
The **Equipment Test** screen appears.

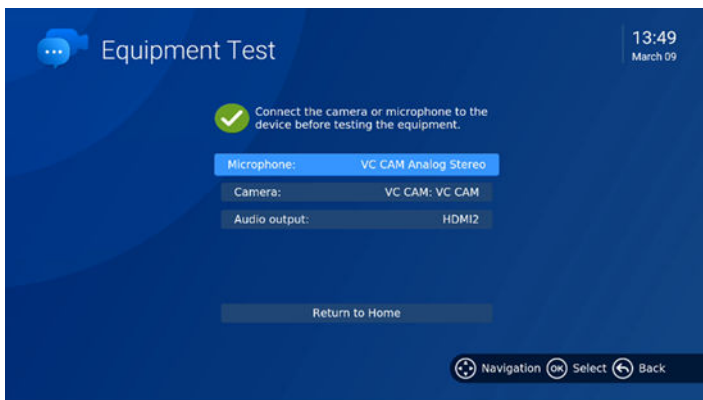

- Select the equipment you want to test:

Equipment Tests	User Actions
<b>Microphone</b>	Check the microphone volume or select other microphone sources.
<b>Camera</b>	Check the camera preview or select other camera sources.

Equipment Tests	User Actions
<b>Audio Output</b>	<p><b>a.</b> Select an audio output.</p> <p><b>b.</b> Enter <b>Play</b>. Test the sound quality or select another audio output.</p>

## Updating KoiMeeter



### Warning

- To prevent data loss, QNAP recommends backing up all data on your device before updating the software.
- Do not power off your device during the software update process.



### Important

- QNAP recommends updating the software using wired Ethernet connections to ensure your network connection is reliable during firmware updates.
- The update may require several minutes or longer, depending on your hardware configuration and network connection.
- You must restart the device for the software update to take effect which may disrupt ongoing device services or operations.

1. Go to **System Settings**.
2. Select **Software Update**.  
KoiMeeter automatically detects the latest software version.
3. Enter **OK**.  
KoiMeeter downloads the latest software version.
4. Restart the device.

## 11. Meeting & Contact Settings

You can configure the KoiMeeter app settings by logging into the app backend on a QNE device. You must have administrator permissions or the QNE device account to access the Meeting & Contact Settings.

### Logging in to the Meeting & Contact Settings

KoiBox-100W supports DHCP clients by default. When connected to a network, an IP address is obtained from a DHCP server automatically. The IP address will show on the home screen of the HDMI display.



#### Note

If your network is not connected to a DHCP server, you can manually configure the video conference appliance IP. For details, see [Configuring Network Settings](#).



1. Enter the following in the address bar of the web browser: the IP address followed by a colon (:), the port number 25001, and "/#/CMS".  
For example, "xxx.xxx.xxx.xxx:25001/#/CMS".
2. Log in with the device username and password.



#### Note

The default login details as following:

- Default username: `user`
- Default password: The first MAC address in uppercase letters without special characters.  
For example, if the first MAC address is 00-08-9B-F6-15-75, then the admin password will be 00089BF61575.







#### Important

For security purposes, QNAP strongly recommends you set a new password after logging in to the device the first time.

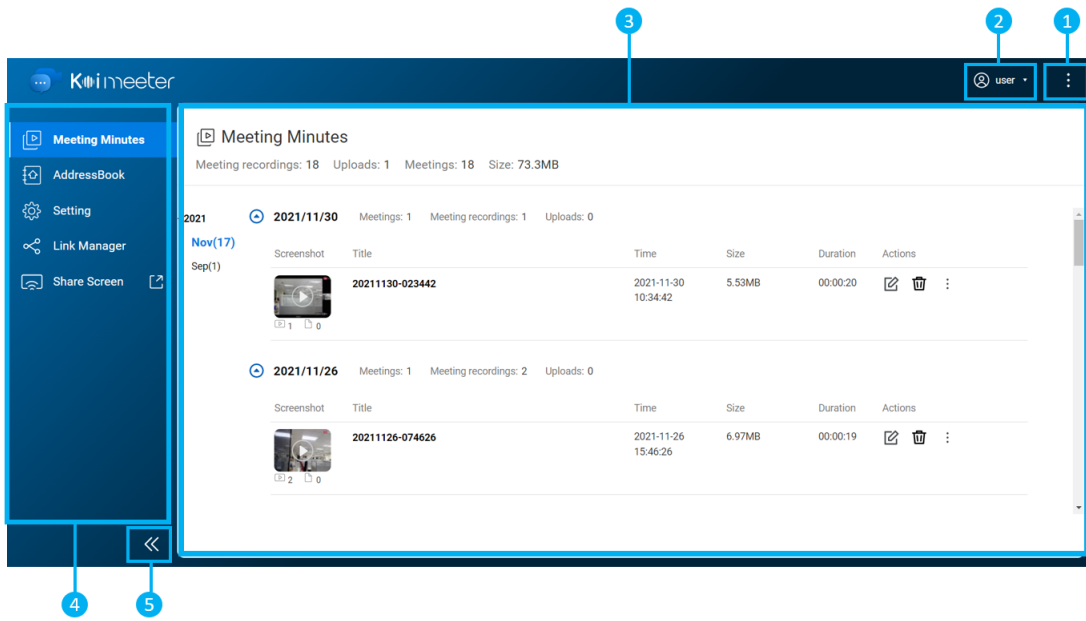
### Meeting & Contact Settings Interface

The following table describes the Meeting & Contact Settings interface elements and features.



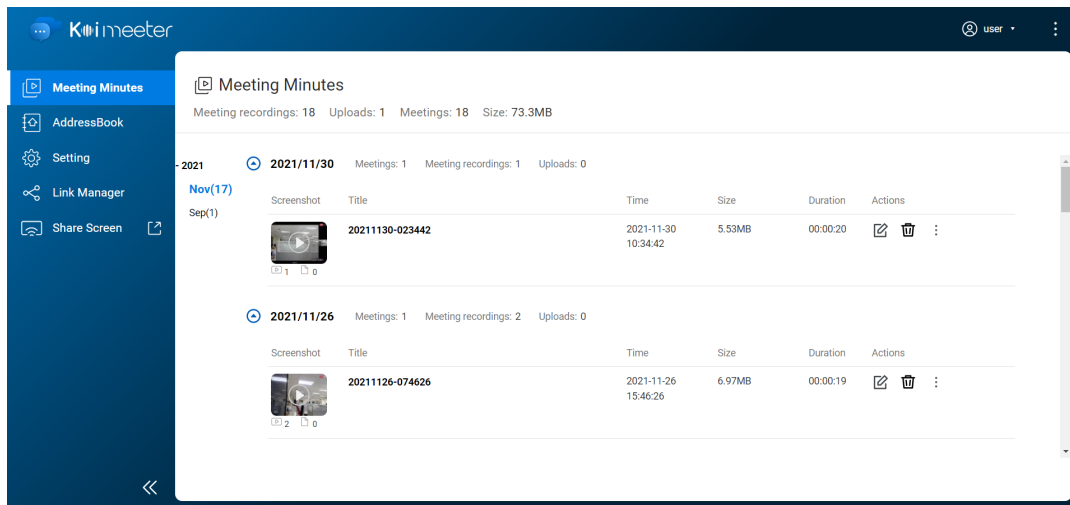

No.	Element	Description
1	Settings	Click  to select KoiMeeter app language settings, view the online tutorials, view the KoiMeeter app information, or view Quick Start.
2	Account	Shows current user logged into the KoiMeeter app or the app log out option.
3	Right panel	Displays selected app feature information.
4	Left panel	Lists all KoiMeeter app features.
5	Expand or collapse	<ul style="list-style-type: none"> <li>Click  to expand the right panel.</li> <li>Click  to collapse the right panel.</li> </ul>

## Meeting Minutes









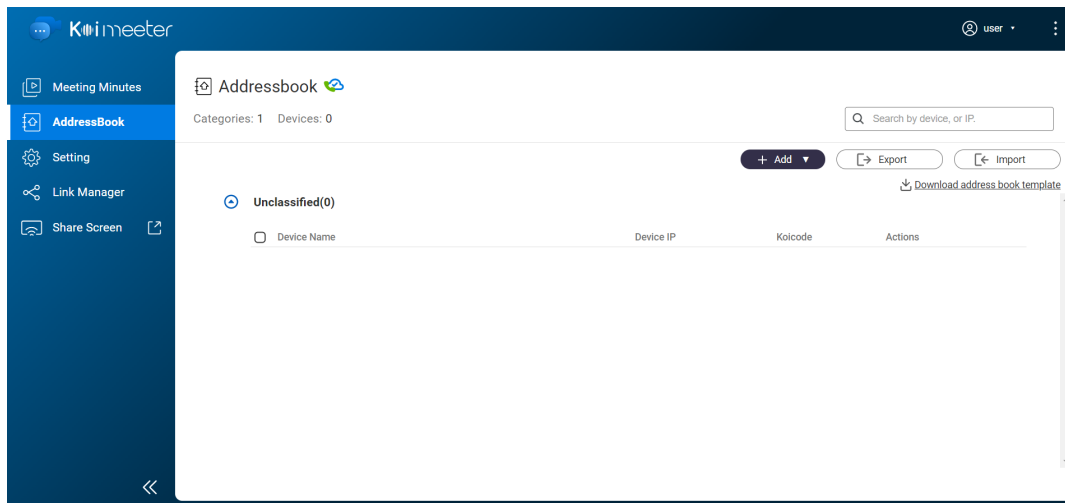

On the **Meeting Minutes** screen, you can view the number of meeting recordings, chat records, automatically uploaded files, meetings, and meeting file sizes. You can also manage the recorded meeting files. The following table describes **Meeting Minutes** features and functions.

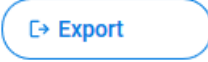
Task	Action
Edit meeting file information	Click  .
Delete meeting file	Click  .
Display other actions in a drop-down menu	Click  .
Open meeting file	Select <b>Open</b> from the drop-down menu.
Play back meeting recording files	Select <b>Play</b> from the drop-down menu.
Download meeting file	Select <b>Download</b> from the drop-down menu.
Set access permission of meeting file	Select <b>Access Permission</b> from the drop-down menu.
Create the share link of a meeting file	Select <b>Share</b> from the drop-down menu.
Display meeting file details	Select <b>Information</b> from the drop-down menu.

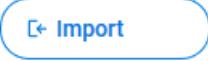
## AddressBook



On the **AddressBook** screen, you can view the device names, device IP addresses, and device KoiCode. You can also import, export, add, and edit device names, device IP addresses, device KoiCode, and categorize devices. The following table describes **AddressBook** features and functions.

Task	Action
Export device information	Click  .   <b>Note</b> KoiMeeter supports exporting device information in JSON file format.
Import device information	Click  .   <b>Note</b> KoiMeeter supports importing device information in JSON file format.
Add categories or devices	Click  .
Edit device information	Click  .
Change device category	Click  .
Delete device	Click  .
Display action options	Click  .



## Settings

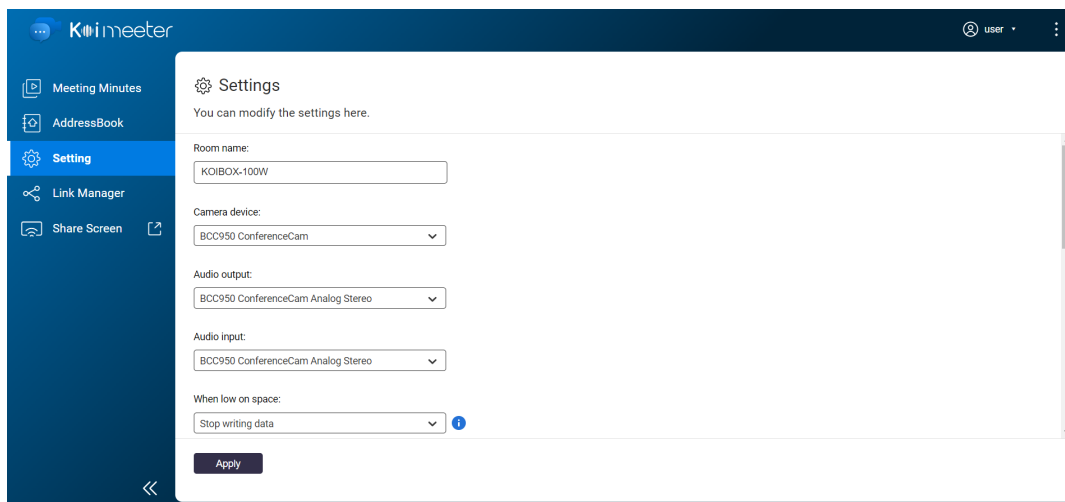

On the **Settings** screen, you can modify the KoiMeeter app configurations.





The following table describes the settings you can change in KoiMeeter.



Settings	Description
<b>Room name</b>	Change the meeting room name shown on Insight View.
<b>Camera device</b>	Change the selected camera device.
<b>Audio output</b>	Change the selected audio output device.
<b>Audio input</b>	Change the selected audio input device.
<b>When low on space</b>	Change the action when the system storage is less than 15 GB.
<b>PIN code required</b>	<p>Enable or disable PIN code.</p> <p> <b>Note</b> When <b>PIN code required</b> is enabled, the conference participants must enter the PIN code every time to join a KoiMeeter video conference or wireless screen sharing session.</p>
<b>Meeting session countdown</b>	<p>Configure the countdown time until KoiMeeter automatically ends wireless screen sharing or a video conference.</p> <p> <b>Important</b> You must enable the <b>PIN code required</b> to configure the <b>Meeting session countdown</b>.</p>
<b>Wireless projection IP address</b>	<p>Select the IP address you want to use for wireless projection.</p> <p> <b>Note</b> The wireless projection IP address will list all network settings configured on your device, including IP addresses of multiple network adapters or virtual switches. Make sure you select an IP address that your computer can access. For details, see <a href="#">Accessing Insight View</a>.</p>
<b>Auto record sessions</b>	Enable to automatically record video conference sessions.

Settings	Description
<b>Auto answer calls</b>	Enable to automatically answer all incoming video calls.   <b>Tip</b> If <b>Auto answer calls</b> are disabled, the video call automatically ends when there is no response for more than 1 minute.
<b>Apply</b>	Click  to save setting changes.

## Link Manager

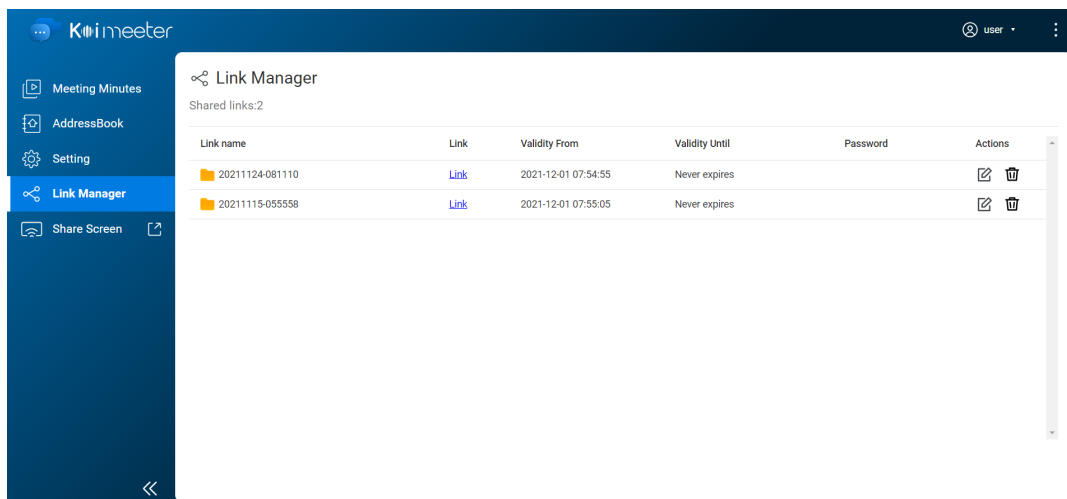
On the **Link Manager** screen, you can view the number of shared links, the name of shared folders, the link information of shared folders, the validity period of shared links, and the password information of shared links. You can also manage the shared links. The following table describes **Link Manager** features and functions.



Task	Action
Edit the share link	Click  . You can modify the following shared link settings: <ul style="list-style-type: none"> <li>• Change the link name.</li> <li>• Change domain name or IP.</li> <li>• Change expiration date.</li> <li>• Enable or disable password protection.</li> </ul>
Stop sharing the link	Click  . KoiMeeter stops sharing the link and deletes the share link.
Copy the share link to the clipboard	Click <b>Links</b> .

## Share Screen

Clicking **Share Screen** redirects you to the Insight View share screen interface. For details, see [Wireless Screen Sharing](#).

## 12. Troubleshooting

This chapter describes basic troubleshooting information.

### Forcing Qfinder Pro or myQNAPcloud to Locate the Device

If Qfinder Pro or myQNAPcloud is unable to locate the NAS during QNE Embedded installation, the drives or data may be faulty.

1. Power off the device.
2. Remove the drive.
3. Power on the device.
4. Locate the device using Qfinder Pro or myQNAPcloud.
5. Reinsert the drive.
6. Continue with the QNE Embedded installation.

### Support and Other Resources

QNAP provides the following resources:

Resource	URL
Documentation	<a href="https://download.qnap.com">https://download.qnap.com</a>
Compatibility List	<a href="https://www.qnap.com/compatibility">https://www.qnap.com/compatibility</a>
NAS Migration Compatibility	<a href="https://www.qnap.com/go/nas-migration">https://www.qnap.com/go/nas-migration</a>
Expansion Unit Compatibility	<a href="https://www.qnap.com/go/compatibility-expansion">https://www.qnap.com/go/compatibility-expansion</a>
Service Portal	<a href="https://service.qnap.com">https://service.qnap.com</a>
Product Support Status	<a href="https://www.qnap.com/go/product/eol.php">https://www.qnap.com/go/product/eol.php</a>
Downloads	<a href="https://download.qnap.com">https://download.qnap.com</a>
Community Forum	<a href="https://forum.qnap.com">https://forum.qnap.com</a>
QNAP Accessories Store	<a href="https://shop.qnap.com">https://shop.qnap.com</a>

## 13. Glossary

### **KoiBox**

A video conference device specializing in cross-team collaboration

### **KoiMeeter**

KoiMeeter is a video conferencing solution with built-in wireless projection and video recording features

### **myQNAPcloud**

Provides various remote access services such as DDNS and myQNAPcloud Link

### **Qfinder Pro**

QNAP utility that lets you locate and access QNAP NAS devices in your local area network

### **QNE Embedded**

QNE Embedded is the in-built operating system designed for QNAP networking devices

## 14. Notices

This chapter provides information about warranty, disclaimers, licensing, and federal regulations.

### Limited Warranty

QNAP offers limited warranty service on our products. Your QNAP-branded hardware product is warranted against defects in materials and workmanship for a period of one (1) year or more from the date printed on the invoice. ("Warranty Period"). Please review your statutory rights at [www.qnap.com/warranty](http://www.qnap.com/warranty), which may be amended from time to time by QNAP in its discretion.

### Disclaimer

Information in this document is provided in connection with products of QNAP Systems, Inc. (the "QNAP"). No license, express or implied, by estoppels or otherwise, to any intellectual property rights is granted by this document. Except as provided in QNAP's terms and conditions of sale for such products, QNAP assumes no liability whatsoever, and QNAP disclaims any express or implied warranty, relating to sale and/or use of QNAP products including liability or warranties relating to fitness for a particular purpose, merchantability, or infringement of any patent, copyright or other intellectual property right.

QNAP products are not intended for use in medical, life saving, life sustaining, critical control or safety systems, or in nuclear facility applications.

In no event shall QNAP's liability exceed the price paid for the product from direct, indirect, special, incidental, or consequential damages resulting from the use of the product, its accompanying software, or its documentation. QNAP makes no warranty or representation, expressed, implied, or statutory, with respect to its products or the contents or use of this documentation and all accompanying software, and specifically disclaims its quality, performance, merchantability, or fitness for any particular purpose. QNAP reserves the right to revise or update its products, software, or documentation without obligation to notify any individual or entity.

Back up the system periodically to avoid any potential data loss is recommended. QNAP disclaims any responsibility of all sorts of data loss or recovery.

Should you return any components of the package of QNAP products such as NAS (Network Attached Storage) for refund or maintenance, make sure they are carefully packed for shipping. Any form of damages due to improper packaging will not be compensated.

All the features, functionality, and other product specifications are subject to change without prior notice or obligation. Information contained herein is subject to change without notice.

Further, the ® or ™ symbols are not used in the text.

### GNU Public License

Version 3, 29 June 2007

Everyone is permitted to copy and distribute verbatim copies of this license document, but changing it is not allowed.

#### Preamble

The GNU General Public License is a free, copy left license for software and other kinds of works.

The licenses for most software and other practical works are designed to take away your freedom to share and change the works. By contrast, the GNU General Public License is intended to guarantee your freedom to share and change all versions of a program--to make sure it remains free software for all its users. We,

the Free Software Foundation, use the GNU General Public License for most of our software; it applies also to any other work released this way by its authors. You can apply it to your programs, too.

When we speak of free software, we are referring to freedom, not price. Our General Public Licenses are designed to make sure that you have the freedom to distribute copies of free software (and charge for them if you wish), that you receive source code or can get it if you want it, that you can change the software or use pieces of it in new free programs, and that you know you can do these things.

To protect your rights, we need to prevent others from denying you these rights or asking you to surrender the rights. Therefore, you have certain responsibilities if you distribute copies of the software, or if you modify it: responsibilities to respect the freedom of others.

For example, if you distribute copies of such a program, whether gratis or for a fee, you must pass on to the recipients the same freedoms that you received. You must make sure that they, too, receive or can get the source code. And you must show them these terms so they know their rights.

Developers that use the GNU GPL protect your rights with two steps: (1) assert copyright on the software, and (2) offer you this License giving you legal permission to copy, distribute and/or modify it.

For the developers' and authors' protection, the GPL clearly explains that there is no warranty for this free software. For both users' and authors' sake, the GPL requires that modified versions be marked as changed, so that their problems will not be attributed erroneously to authors of previous versions.

Some devices are designed to deny users access to install or run modified versions of the software inside them, although the manufacturer can do so. This is fundamentally incompatible with the aim of protecting users' freedom to change the software. The systematic pattern of such abuse occurs in the area of products for individuals to use, which is precisely where it is most unacceptable. Therefore, we have designed this version of the GPL to prohibit the practice for those products. If such problems arise substantially in other domains, we stand ready to extend this provision to those domains in future versions of the GPL, as needed to protect the freedom of users.

Finally, every program is threatened constantly by software patents. States should not allow patents to restrict development and use of software on general-purpose computers, but in those that do, we wish to avoid the special danger that patents applied to a free program could make it effectively proprietary. To prevent this, the GPL assures that patents cannot be used to render the program non-free.

The precise terms and conditions for copying, distribution and modification follow.

## Terms and Conditions

### 1. Definitions.

"This License" refers to version 3 of the GNU General Public License.

"Copyright" also means copyright-like laws that apply to other kinds of works, such as semiconductor masks.

"The Program" refers to any copyrightable work licensed under this License. Each licensee is addressed as "you". "Licensees" and "recipients" may be individuals or organizations.

To "modify" a work means to copy from or adapt all or part of the work in a fashion requiring copyright permission, other than the making of an exact copy. The resulting work is called a "modified version" of the earlier work or a work "based on" the earlier work.

A "covered work" means either the unmodified Program or a work based on the Program.

To "propagate" a work means to do anything with it that, without permission, would make you directly or secondarily liable for infringement under applicable copyright law, except executing it on a computer or modifying a private copy. Propagation includes copying, distribution (with or without modification), making available to the public, and in some countries other activities as well.

To "convey" a work means any kind of propagation that enables other parties to make or receive copies. Mere interaction with a user through a computer network, with no transfer of a copy, is not conveying.

An interactive user interface displays "Appropriate Legal Notices" to the extent that it includes a convenient and prominently visible feature that (1) displays an appropriate copyright notice, and (2)

tells the user that there is no warranty for the work (except to the extent that warranties are provided), that licensees may convey the work under this License, and how to view a copy of this License. If the interface presents a list of user commands or options, such as a menu, a prominent item in the list meets this criterion.

## 2. Source Code.

The “source code” for a work means the preferred form of the work for making modifications to it.

“Object code” means any non-source form of a work.

A “Standard Interface” means an interface that either is an official standard defined by a recognized standards body, or, in the case of interfaces specified for a particular programming language, one that is widely used among developers working in that language.

The “System Libraries” of an executable work include anything, other than the work as a whole, that (a) is included in the normal form of packaging a Major Component, but which is not part of that Major Component, and (b) serves only to enable use of the work with that Major Component, or to implement a Standard Interface for which an implementation is available to the public in source code form. A “Major Component”, in this context, means a major essential component (kernel, window system, and so on) of the specific operating system (if any) on which the executable work runs, or a compiler used to produce the work, or an object code interpreter used to run it.

The “Corresponding Source” for a work in object code form means all the source code needed to generate, install, and (for an executable work) run the object code and to modify the work, including scripts to control those activities. However, it does not include the work’s System Libraries, or general-purpose tools or generally available free programs which are used unmodified in performing those activities but which are not part of the work. For example, Corresponding Source includes interface definition files associated with source files for the work, and the source code for shared libraries and dynamically linked subprograms that the work is specifically designed to require, such as by intimate data communication or control flow between those subprograms and other parts of the work.

The Corresponding Source need not include anything that users can regenerate automatically from other parts of the Corresponding Source.

The Corresponding Source for a work in source code form is that same work.

## 3. Basic Permissions.

All rights granted under this License are granted for the term of copyright on the Program, and are irrevocable provided the stated conditions are met. This License explicitly affirms your unlimited permission to run the unmodified Program. The output from running a covered work is covered by this License only if the output, given its content, constitutes a covered work. This License acknowledges your rights of fair use or other equivalent, as provided by copyright law.

You may make, run and propagate covered works that you do not convey, without conditions so long as your license otherwise remains in force. You may convey covered works to others for the sole purpose of having them make modifications exclusively for you, or provide you with facilities for running those works, provided that you comply with the terms of this License in conveying all material for which you do not control copyright. Those thus making or running the covered works for you must do so exclusively on your behalf, under your direction and control, on terms that prohibit them from making any copies of your copyrighted material outside their relationship with you.

Conveying under any other circumstances is permitted solely under the conditions stated below.

Sublicensing is not allowed; section 10 makes it unnecessary.

## 4. Protecting Users' Legal Rights From Anti-Circumvention Law.

No covered work shall be deemed part of an effective technological measure under any applicable law fulfilling obligations under article 11 of the WIPO copyright treaty adopted on 20 December 1996, or similar laws prohibiting or restricting circumvention of such measures.

When you convey a covered work, you waive any legal power to forbid circumvention of technological measures to the extent such circumvention is effected by exercising rights under this License with respect to the covered work, and you disclaim any intention to limit operation or modification of the work as a means of enforcing, against the work’s users, your or third parties’ legal rights to forbid circumvention of technological measures.

## 5. Conveying Verbatim Copies.



You may convey verbatim copies of the Program's source code as you receive it, in any medium, provided that you conspicuously and appropriately publish on each copy an appropriate copyright notice; keep intact all notices stating that this License and any non-permissive terms added in accord with section 7 apply to the code; keep intact all notices of the absence of any warranty; and give all recipients a copy of this License along with the Program.

You may charge any price or no price for each copy that you convey, and you may offer support or warranty protection for a fee.

#### 6. Conveying Modified Source Versions.

You may convey a work based on the Program, or the modifications to produce it from the Program, in the form of source code under the terms of section 4, provided that you also meet all of these conditions:

- a. The work must carry prominent notices stating that you modified it, and giving a relevant date.
- b. The work must carry prominent notices stating that it is released under this License and any conditions added under section 7. This requirement modifies the requirement in section 4 to "keep intact all notices".
- c. You must license the entire work, as a whole, under this License to anyone who comes into possession of a copy. This License will therefore apply, along with any applicable section 7 additional terms, to the whole of the work, and all its parts, regardless of how they are packaged. This License gives no permission to license the work in any other way, but it does not invalidate such permission if you have separately received it.
- d. If the work has interactive user interfaces, each must display Appropriate Legal Notices; however, if the Program has interactive interfaces that do not display Appropriate Legal Notices, your work need not make them do so.

A compilation of a covered work with other separate and independent works, which are not by their nature extensions of the covered work, and which are not combined with it such as to form a larger program, in or on a volume of a storage or distribution medium, is called an "aggregate" if the compilation and its resulting copyright are not used to limit the access or legal rights of the compilation's users beyond what the individual works permit. Inclusion of a covered work in an aggregate does not cause this License to apply to the other parts of the aggregate.

#### 7. Conveying Non-Source Forms.

You may convey a covered work in object code form under the terms of sections 4 and 5, provided that you also convey the machine-readable Corresponding Source under the terms of this License, in one of these ways:

- a. Convey the object code in, or embodied in, a physical product (including a physical distribution medium), accompanied by the Corresponding Source fixed on a durable physical medium customarily used for software interchange.
- b. Convey the object code in, or embodied in, a physical product (including a physical distribution medium), accompanied by a written offer, valid for at least three years and valid for as long as you offer spare parts or customer support for that product model, to give anyone who possesses the object code either (1) a copy of the Corresponding Source for all the software in the product that is covered by this License, on a durable physical medium customarily used for software interchange, for a price no more than your reasonable cost of physically performing this conveying of source, or (2) access to copy the Corresponding Source from a network server at no charge.
- c. Convey individual copies of the object code with a copy of the written offer to provide the Corresponding Source. This alternative is allowed only occasionally and noncommercially, and only if you received the object code with such an offer, in accord with subsection 6b.
- d. Convey the object code by offering access from a designated place (gratis or for a charge), and offer equivalent access to the Corresponding Source in the same way through the same place

at no further charge. You need not require recipients to copy the Corresponding Source along with the object code. If the place to copy the object code is a network server, the Corresponding Source may be on a different server (operated by you or a third party) that supports equivalent copying facilities, provided you maintain clear directions next to the object code saying where to find the Corresponding Source. Regardless of what server hosts the Corresponding Source, you remain obligated to ensure that it is available for as long as needed to satisfy these requirements.

- e. Convey the object code using peer-to-peer transmission, provided you inform other peers where the object code and Corresponding Source of the work are being offered to the general public at no charge under subsection 6d.

A separable portion of the object code, whose source code is excluded from the Corresponding Source as a System Library, need not be included in conveying the object code work.

A "User Product" is either (1) a "consumer product", which means any tangible personal property which is normally used for personal, family, or household purposes, or (2) anything designed or sold for incorporation into a dwelling. In determining whether a product is a consumer product, doubtful cases shall be resolved in favor of coverage. For a particular product received by a particular user, "normally used" refers to a typical or common use of that class of product, regardless of the status of the particular user or of the way in which the particular user actually uses, or expects or is expected to use, the product. A product is a consumer product regardless of whether the product has substantial commercial, industrial or non-consumer uses, unless such uses represent the only significant mode of use of the product.

"Installation Information" for a User Product means any methods, procedures, authorization keys, or other information required to install and execute modified versions of a covered work in that User Product from a modified version of its Corresponding Source. The information must suffice to ensure that the continued functioning of the modified object code is in no case prevented or interfered with solely because modification has been made.

If you convey an object code work under this section in, or with, or specifically for use in, a User Product, and the conveying occurs as part of a transaction in which the right of possession and use of the User Product is transferred to the recipient in perpetuity or for a fixed term (regardless of how the transaction is characterized), the Corresponding Source conveyed under this section must be accompanied by the Installation Information. But this requirement does not apply if neither you nor any third party retains the ability to install modified object code on the User Product (for example, the work has been installed in ROM).

The requirement to provide Installation Information does not include a requirement to continue to provide support service, warranty, or updates for a work that has been modified or installed by the recipient, or for the User Product in which it has been modified or installed. Access to a network may be denied when the modification itself materially and adversely affects the operation of the network or violates the rules and protocols for communication across the network.

Corresponding Source conveyed, and Installation Information provided, in accord with this section must be in a format that is publicly documented (and with an implementation available to the public in source code form), and must require no special password or key for unpacking, reading or copying.

## 8. Additional Terms.

"Additional permissions" are terms that supplement the terms of this License by making exceptions from one or more of its conditions. Additional permissions that are applicable to the entire Program shall be treated as though they were included in this License, to the extent that they are valid under applicable law. If additional permissions apply only to part of the Program, that part may be used separately under those permissions, but the entire Program remains governed by this License without regard to the additional permissions.

When you convey a copy of a covered work, you may at your option remove any additional permissions from that copy, or from any part of it. (Additional permissions may be written to require their own removal in certain cases when you modify the work.) You may place additional permissions on material, added by you to a covered work, for which you have or can give appropriate copyright permission.

Notwithstanding any other provision of this License, for material you add to a covered work, you may (if authorized by the copyright holders of that material) supplement the terms of this License with terms:

- a. Disclaiming warranty or limiting liability differently from the terms of sections 15 and 16 of this License; or
- b. Requiring preservation of specified reasonable legal notices or author attributions in that material or in the Appropriate Legal Notices displayed by works containing it; or
- c. Prohibiting misrepresentation of the origin of that material, or requiring that modified versions of such material be marked in reasonable ways as different from the original version; or
- d. Limiting the use for publicity purposes of names of licensors or authors of the material; or
- e. Declining to grant rights under trademark law for use of some trade names, trademarks, or service marks; or
- f. Requiring indemnification of licensors and authors of that material by anyone who conveys the material (or modified versions of it) with contractual assumptions of liability to the recipient, for any liability that these contractual assumptions directly impose on those licensors and authors. All other non-permissive additional terms are considered “further restrictions” within the meaning of section 10. If the Program as you received it, or any part of it, contains a notice stating that it is governed by this License along with a term that is a further restriction, you may remove that term. If a license document contains a further restriction but permits relicensing or conveying under this License, you may add to a covered work material governed by the terms of that license document, provided that the further restriction does not survive such relicensing or conveying.

If you add terms to a covered work in accord with this section, you must place, in the relevant source files, a statement of the additional terms that apply to those files, or a notice indicating where to find the applicable terms.

Additional terms, permissive or non-permissive, may be stated in the form of a separately written license, or stated as exceptions; the above requirements apply either way.

## 9. Termination.

You may not propagate or modify a covered work except as expressly provided under this License. Any attempt otherwise to propagate or modify it is void, and will automatically terminate your rights under this License (including any patent licenses granted under the third paragraph of section 11).

However, if you cease all violation of this License, then your license from a particular copyright holder is reinstated (a) provisionally, unless and until the copyright holder explicitly and finally terminates your license, and (b) permanently, if the copyright holder fails to notify you of the violation by some reasonable means prior to 60 days after the cessation.

Moreover, your license from a particular copyright holder is reinstated permanently if the copyright holder notifies you of the violation by some reasonable means, this is the first time you have received notice of violation of this License (for any work) from that copyright holder, and you cure the violation prior to 30 days after your receipt of the notice.

Termination of your rights under this section does not terminate the licenses of parties who have received copies or rights from you under this License. If your rights have been terminated and not permanently reinstated, you do not qualify to receive new licenses for the same material under section 10.

## 10. Acceptance Not Required for Having Copies.

You are not required to accept this License in order to receive or run a copy of the Program. Ancillary propagation of a covered work occurring solely as a consequence of using peer-to-peer transmission to receive a copy likewise does not require acceptance. However, nothing other than this License grants you permission to propagate or modify any covered work. These actions infringe copyright if you do not accept this License. Therefore, by modifying or propagating a covered work, you indicate your acceptance of this License to do so.

**11. Automatic Licensing of Downstream Recipients.**

Each time you convey a covered work, the recipient automatically receives a license from the original licensors, to run, modify and propagate that work, subject to this License. You are not responsible for enforcing compliance by third parties with this License.

An "entity transaction" is a transaction transferring control of an organization, or substantially all assets of one, or subdividing an organization, or merging organizations. If propagation of a covered work results from an entity transaction, each party to that transaction who receives a copy of the work also receives whatever licenses to the work the party's predecessor in interest had or could give under the previous paragraph, plus a right to possession of the Corresponding Source of the work from the predecessor in interest, if the predecessor has it or can get it with reasonable efforts.

You may not impose any further restrictions on the exercise of the rights granted or affirmed under this License. For example, you may not impose a license fee, royalty, or other charge for exercise of rights granted under this License, and you may not initiate litigation (including a cross-claim or counterclaim in a lawsuit) alleging that any patent claim is infringed by making, using, selling, offering for sale, or importing the Program or any portion of it.

**12. Patents.**

A "contributor" is a copyright holder who authorizes use under this License of the Program or a work on which the Program is based. The work thus licensed is called the contributor's "contributor version". A contributor's "essential patent claims" are all patent claims owned or controlled by the contributor, whether already acquired or hereafter acquired, that would be infringed by some manner, permitted by this License, of making, using, or selling its contributor version, but do not include claims that would be infringed only as a consequence of further modification of the contributor version. For purposes of this definition, "control" includes the right to grant patent sublicenses in a manner consistent with the requirements of this License.

Each contributor grants you a non-exclusive, worldwide, royalty-free patent license under the contributor's essential patent claims, to make, use, sell, offer for sale, import and otherwise run, modify and propagate the contents of its contributor version.

In the following three paragraphs, a "patent license" is any express agreement or commitment, however denominated, not to enforce a patent (such as an express permission to practice a patent or covenant not to sue for patent infringement). To "grant" such a patent license to a party means to make such an agreement or commitment not to enforce a patent against the party.

If you convey a covered work, knowingly relying on a patent license, and the Corresponding Source of the work is not available for anyone to copy, free of charge and under the terms of this License, through a publicly available network server or other readily accessible means, then you must either (1) cause the Corresponding Source to be so available, or (2) arrange to deprive yourself of the benefit of the patent license for this particular work, or (3) arrange, in a manner consistent with the requirements of this License, to extend the patent license to downstream recipients. "Knowingly relying" means you have actual knowledge that, but for the patent license, your conveying the covered work in a country, or your recipient's use of the covered work in a country, would infringe one or more identifiable patents in that country that you have reason to believe are valid.

If, pursuant to or in connection with a single transaction or arrangement, you convey, or propagate by procuring conveyance of, a covered work, and grant a patent license to some of the parties receiving the covered work authorizing them to use, propagate, modify or convey a specific copy of the covered work, then the patent license you grant is automatically extended to all recipients of the covered work and works based on it.

A patent license is "discriminatory" if it does not include within the scope of its coverage, prohibits the exercise of, or is conditioned on the non-exercise of one or more of the rights that are specifically granted under this License. You may not convey a covered work if you are a party to an arrangement with a third party that is in the business of distributing software, under which you make payment to the third party based on the extent of your activity of conveying the work, and under which the third party grants, to any of the parties who would receive the covered work from you, a discriminatory patent license (a) in connection with copies of the covered work conveyed by you (or copies made from those copies), or (b) primarily for and in connection with specific products or compilations that contain the covered work, unless you entered into that arrangement, or that patent license was granted, prior to 28 March 2007.

Nothing in this License shall be construed as excluding or limiting any implied license or other defenses to infringement that may otherwise be available to you under applicable patent law.

**13. No Surrender of Others' Freedom.**

If conditions are imposed on you (whether by court order, agreement or otherwise) that contradict the conditions of this License, they do not excuse you from the conditions of this License. If you cannot convey a covered work so as to satisfy simultaneously your obligations under this License and any other pertinent obligations, then as a consequence you may not convey it at all. For example, if you agree to terms that obligate you to collect a royalty for further conveying from those to whom you convey the Program, the only way you could satisfy both those terms and this License would be to refrain entirely from conveying the Program.

**14. Use with the GNU Affero General Public License.**

Notwithstanding any other provision of this License, you have permission to link or combine any covered work with a work licensed under version 3 of the GNU Affero General Public License into a single combined work, and to convey the resulting work. The terms of this License will continue to apply to the part which is the covered work, but the special requirements of the GNU Affero General Public License, section 13, concerning interaction through a network will apply to the combination as such.

**15. Revised Versions of this License.**

The Free Software Foundation may publish revised and/or new versions of the GNU General Public License from time to time. Such new versions will be similar in spirit to the present version, but may differ in detail to address new problems or concerns.

Each version is given a distinguishing version number. If the Program specifies that a certain numbered version of the GNU General Public License "or any later version" applies to it, you have the option of following the terms and conditions either of that numbered version or of any later version published by the Free Software Foundation. If the Program does not specify a version number of the GNU General Public License, you may choose any version ever published by the Free Software Foundation.

If the Program specifies that a proxy can decide which future versions of the GNU General Public License can be used, that proxy's public statement of acceptance of a version permanently authorizes you to choose that version for the Program.

Later license versions may give you additional or different permissions. However, no additional obligations are imposed on any author or copyright holder as a result of your choosing to follow a later version.

**16. Disclaimer of Warranty.**

THERE IS NO WARRANTY FOR THE PROGRAM, TO THE EXTENT PERMITTED BY APPLICABLE LAW. EXCEPT WHEN OTHERWISE STATED IN WRITING THE COPYRIGHT HOLDERS AND/OR OTHER PARTIES PROVIDE THE PROGRAM "AS IS" WITHOUT WARRANTY OF ANY KIND, EITHER EXPRESSED OR IMPLIED, INCLUDING, BUT NOT LIMITED TO, THE IMPLIED WARRANTIES OF MERCHANTABILITY AND FITNESS FOR A PARTICULAR PURPOSE. THE ENTIRE RISK AS TO THE QUALITY AND PERFORMANCE OF THE PROGRAM IS WITH YOU. SHOULD THE PROGRAM PROVE DEFECTIVE, YOU ASSUME THE COST OF ALL NECESSARY SERVICING, REPAIR OR CORRECTION.

**17. Limitation of Liability.**

IN NO EVENT UNLESS REQUIRED BY APPLICABLE LAW OR AGREED TO IN WRITING WILL ANY COPYRIGHT HOLDER, OR ANY OTHER PARTY WHO MODIFIES AND/OR CONVEYS THE PROGRAM AS PERMITTED ABOVE, BE LIABLE TO YOU FOR DAMAGES, INCLUDING ANY GENERAL, SPECIAL, INCIDENTAL OR CONSEQUENTIAL DAMAGES ARISING OUT OF THE USE OR INABILITY TO USE THE PROGRAM (INCLUDING BUT NOT LIMITED TO LOSS OF DATA OR DATA BEING RENDERED INACCURATE OR LOSSES SUSTAINED BY YOU OR THIRD PARTIES OR A FAILURE OF THE PROGRAM TO OPERATE WITH ANY OTHER PROGRAMS), EVEN IF SUCH HOLDER OR OTHER PARTY HAS BEEN ADVISED OF THE POSSIBILITY OF SUCH DAMAGES.

**18. Interpretation of Sections 16 and 17.**

If the disclaimer of warranty and limitation of liability provided above cannot be given local legal effect according to their terms, reviewing courts shall apply local law that most closely approximates an absolute waiver of all civil liability in connection with the Program, unless a warranty or assumption of liability accompanies a copy of the Program in return for a fee.

END OF TERMS AND CONDITIONS

## CE Notice



This device complies with CE Compliance Class A.

## UKCA Notice



This device complies with the UKCA requirements for products sold in Great Britain.

## FCC Notice

### FCC Class A Notice



This device complies with Part 15 of the FCC Rules. Operation is subject to the following two conditions:

1. This device may not cause harmful interference.
2. This device must accept any interference received, including interference that may cause undesired operation.



### Note

This equipment has been tested and found to comply with the limits for a Class A digital device, pursuant to Part 15 of the FCC Rules. These limits are designed to provide reasonable protection against harmful interference when the equipment is operated in a commercial environment. This equipment generates, uses, and can radiate radio frequency energy, and if not installed and used in accordance with the instruction manual, may cause harmful interference to radio communications. Operation of this equipment in a residential area is likely to cause harmful interference, in which case the user will be required to correct the interference at his own expense.



### Important

Any modifications made to this device that are not approved by QNAP Systems, Inc. may void the authority granted to the user by the FCC to operate this equipment.

## VCCI Notice



この装置は、クラス A 情報技術装置です。この装置を家庭環境で使用すると電波妨害を引き起こすことがあります。この場合には使用者が適切な対策を講ずるよう要求されることがあります。

VCCI-A

## BSMI Notice



D33B77  
RoHS

警告使用者：這是甲類的資訊產品，在居住的環境中使用時，可能會造成射頻干擾，在這種情況下，使用者會被要求採取某些適當的對策。

## SJ/T 11364-2006



本产品符合中国 RoHS 标准。以下表格标示此产品中某有毒物质的含量符合中国 RoHS 标准规定的限量要求。

本产品上会附有“环境友好使用期限”的标签，此期限是估算这些物质“不会有泄漏或突变”的年限。本产品可能包含有较短的环境友好使用期限的可替换元件，像是电池或灯管，这些元件将会单独标示出来。

部件名称	有毒有害物质或元素					
	铅 (Pb)	汞 (Hg)	镉 (Cd)	六价铬 (CR(VI))	多溴联苯 (PBB)	多溴二苯醚 (PBDE)
壳体	0	0	0	0	0	0
显示	0	0	0	0	0	0
印刷电路板	0	0	0	0	0	0
金属螺帽	0	0	0	0	0	0
电缆组装	0	0	0	0	0	0

部件名称	有毒有害物质或元素					
	铅 (Pb)	汞 (Hg)	镉 (Cd)	六价铬 (CR(VI))	多溴联苯 (PBB)	多溴二苯醚 (PBDE)
风扇组装	0	0	0	0	0	0
电力供应组装	0	0	0	0	0	0
电池	0	0	0	0	0	0
O: 表示该有毒有害物质在该部件所有物质材料中的含量均在 SJ/T11363-2006 标准规定的限量要求以下。						
X: 表示该有毒有害物质至少在该部件的某一均质材料中的含量超出 SJ/T11363-2006 标准规定的限量要求。						