

EVOLV SHIFT 2 SHIFT 2 air



Thank you
for choosing

PHANTEKS

■ 1. WHAT'S INSIDE?

Introduction	3
Specifications	4
Exploded View	5
Accessories	6

■ 2. CHOOSE YOUR SETUP

Getting started	7
Installing the bottom fan	9
Installing the Power Supply	10
Installing cooling	12
Installing the Motherboard	14
Installing the GPU	15
Installing drives	18
Connecting Front I/O	20
Cable Management (internal ext)	21
Lighting Control	23
Dust Filters	24
Optional Upgrades	25

■ 3. SUPPORT

Contact us	26
Warranty	27



Welcome to Phanteks!

The Evolv Shift 2 (air) builds on the unique form factor of the original Evolv Shift and brings a compact chassis that packs plenty of power and is extremely space efficient with its small footprint. The Evolv Shift 2 (air) will look impressive anywhere with the tempered glass or mesh fabric panels on both sides.

*Phanteks believes that meaningful designs are created through
the fusion of form and function.*

The Phanteks team



CASE SPECIFICATIONS

Dimensions	
Shift 2	170x490x274mm (6.7x19.3x10.8 in)
Shift 2 air	186x490x274mm (7.3x19.3x10.8 in)
Form Factor	Vertical SFF
Materials	Steel chassis, Aluminium panels, <i>Tempered glass window*, Fabric Side panels*</i>
MB Support	Mini-ITX
Front I/O	Power button, 2x USB 3.0, D-RGB Mode, D-RGB Color
Connectors	Power switch, USB 3.0, SATA, D-RGB expansion, D-RGB third-party, D-RGB MB

PCI SLOTS & DRIVE BAYS

PCI slots	2x (2.9 slot)
Internal 3.5"	1x
Internal 2.5"	4x (2 included)

FAN	120 MM	140MM
Rear	2x	2x (1x included)
Bottom	1x	1x

RADIATOR

Rear	1x
-------------	----

INCLUDED ACCESSORIES

140 mm SK D-RGB PWM Fan	1x
GPU bracket	1x
Riser Cable PCI-e 3.0 x 16	1x
Dual SSD bracket	1x
Toolbox	1x
Accessory Bag	1x

CLEARANCE

CPU cooler height	85 mm (3.3 in)
GPU length	335 mm (13.2 in)
GPU cooler thickness	Up to 2.9 slots, 59mm
GPU width	Up to 150mm (5.9 in)
Rear 120mm radiator	Max 157x148mm 45mm thickness with SFX 30mm thickness with SFX-L

SUPPORT

Contact (International)	support@phanteks.com
Contact (America)	support@phanteksusa.com
Warranty	5 Years, see page 27

**Depends on model.*

1. Chassis
2. Front Panel
3. Rear Panel
4. Left Side Panel
5. Right Side Panel
6. Top Grill
7. Bottom Grill
8. GPU Bracket
9. Dual SSD Bracket
10. Bottom Dust Filter



DUAL 2.5" SSD BRACKET

- Pre-installed
- For 2x 2.5" SSD drives



GPU BRACKET WITH RISER CABLE

- Pre-installed
- PCI-e 3.0 x16 riser cable
- Reversible mounting options



SK (D-RGB*) PWM FAN 140 MM

- Pre-installed
- High static pressure
- Silent operation

* Shift 2 Air comes with non D-RGB version

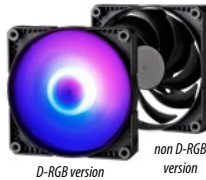



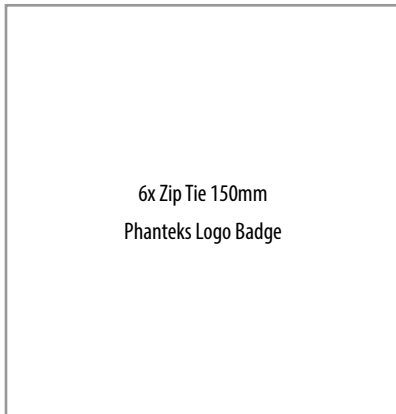

ACCESSORY BAG AND TOOLBOX

Accessory bag



Toolbox

Fan screw	M3x5 mm Motherboard / SSD screw	PSU screw	Silver Thumb Screw	
				
8x	20x	8x	1x	

RECOMMENDED INSTALLATION PROCESS

A unique chassis design like the Shift 2 (air) comes with a different approach to the installation process.

That is why we recommend to follow these installation tips:

- Follow the component installation order as shown in this manual.
- Pre-route the cables for each installed component as shown at each step.
- Wait with connecting cables until the end of the installation process.

Depending on hardware components such as power cable length the cable routing can be different.



1. INSTALL COMPONENT

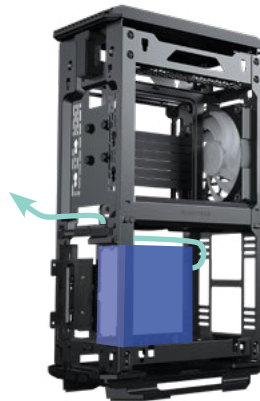

2. PRE-ROUTE CABLES TO THE OUTSIDE



3. CONNECT ALL CABLES AT THE END OF THE INSTALLATION PROCESS

PREPARATIONS

- The Evolv Shift 2 case is designed to support installation in a standing position.
- Don't turn on the power to your system until installation is complete.
- Discharge your body's static electric charge by touching a grounded surface before performing any hardware procedure.
- Make sure to consult the manuals of your hardware before installation.

1. PRESS THE TOP GRILL TO OPEN IT
2. LOOSEN ALL THUMB SCREWS

LOOSEN:

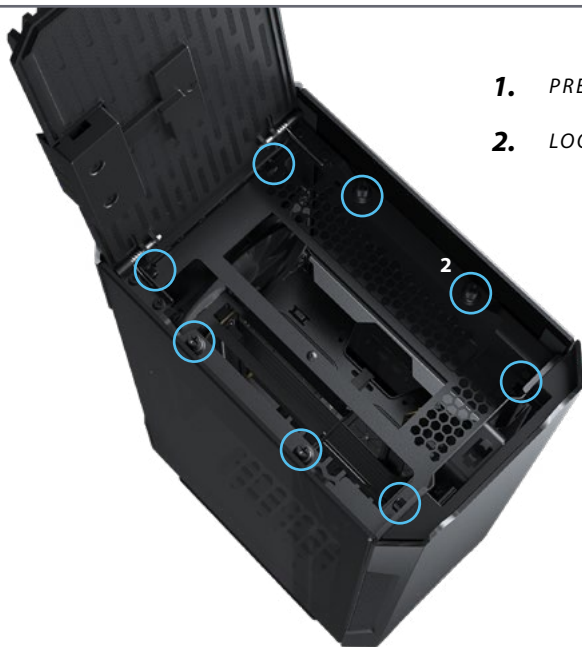

3. SLIDE THE PANELS UP
4. TAKE THE PANELS OUT



PRO TIP

To remove or mount the rear panel the top grill must be closed.

If you want to install a bottom fan we recommend to do it first before proceeding with the installation process.

REQUIRES:



4 x

1. LAY THE EVOLV SHIFT 2 ON ITS SIDE

2. PULL OFF THE BOTTOM GRILL

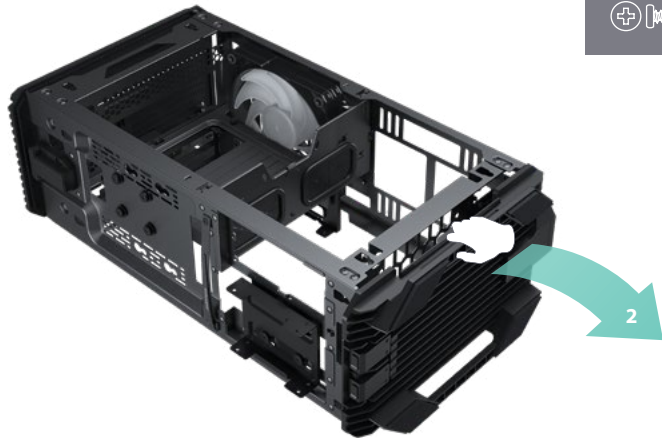

3. INSTALL THE FAN WITH 4X FAN SCREWS

4. PRE-ROUTE THE FAN CABLE OUTSIDE THE CHASSIS

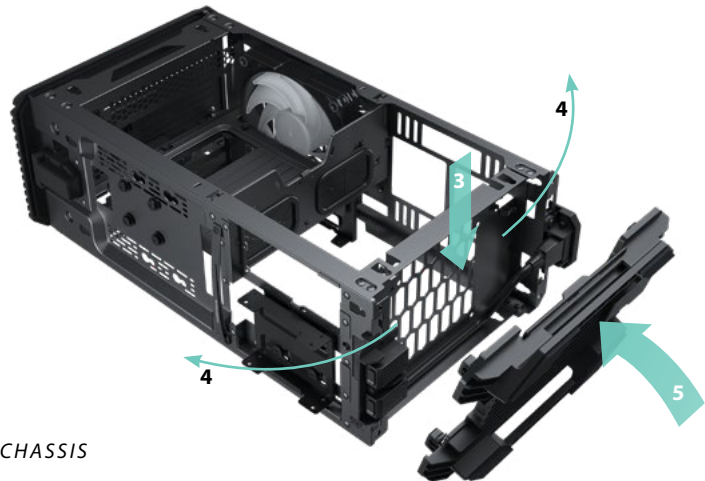

5. PUT THE BOTTOM GRILL BACK ON THE CHASSIS

The SFX power supply fan can be faced towards the side panel or the inside of the chassis. For the Shift 2 with tempered glass side panels we recommend facing the inside of the chassis.

REQUIRES:



1. *PLACE THE SFX PSU ON ITS POSITION*
2. *SECURE THE SFX PSU WITH 4X PSU SCREWS*
3. *CONNECT THE POWER EXTENSION CORD TO THE PSU
MAKE SURE THE PSU SWITCH IS TURNED ON*
4. *PLUG-IN ALL NEEDED CABLES TO THE PSU*
5. *PRE-ROUTE THE CABLES OUTSIDE THE CHASSIS
(SEE NEXT PAGE FOR MORE DETAILS)*

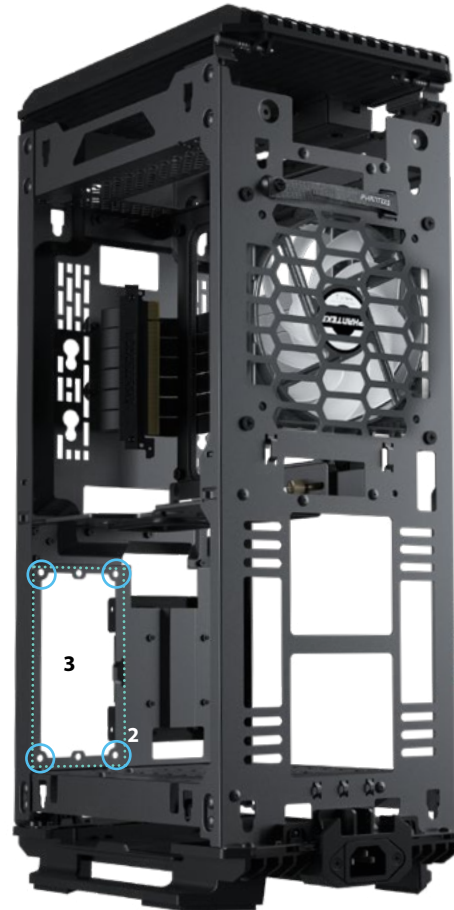

Install the power supply in the correct orientation for the best performance depending on your model

After plugging in all needed power cables to the PSU, the power cables can be pre-routed to make the installation process of other components easier.

4.1 CPU CABLE

Route the CPU Cable through the grommet and the rear cut-out, outside the chassis.

4.2 SATA/MOLEX CABLE

Route the SATA and MOLEX Cables through the front cut-out, outside the chassis.

4.3 GPU CABLE

Route the GPU Cable(s) through the front cut-out, outside the chassis.

4.4 24-PIN MOTHERBOARD CABLE

Route the Motherboard Cable through the left or right grommet and out the side of the chassis. This depends on the length of the 24-Pin cable.

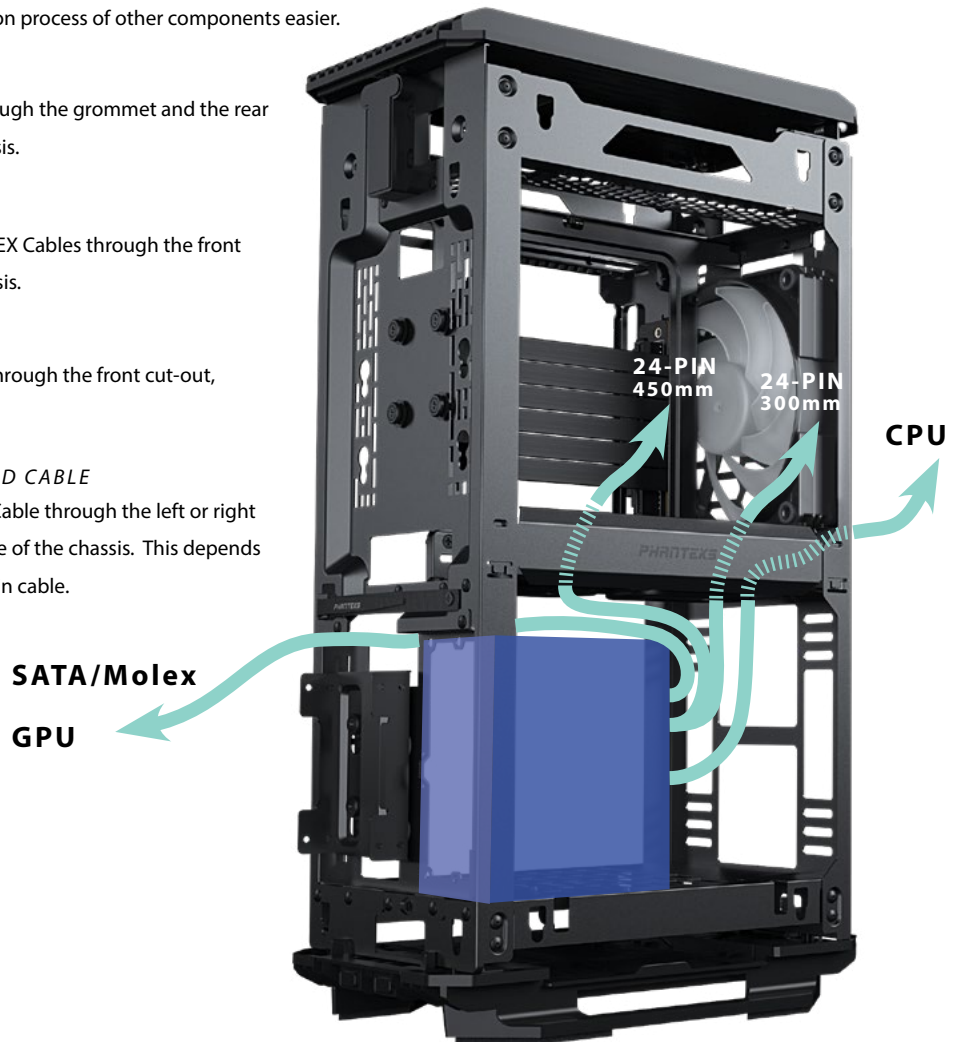

It is recommended to install all cooling case fans and/or AIO cooler in the chassis at this stage.

REQUIRES:



1. MOUNT THE FAN WITH 4 FAN SCREWS

REAR, top location

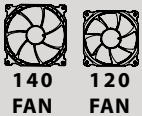

REAR, lower location

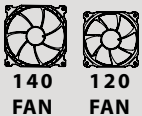

2. PRE-ROUTE THE FAN (AND D-RGB) CABLE OUTSIDE THE CHASSIS

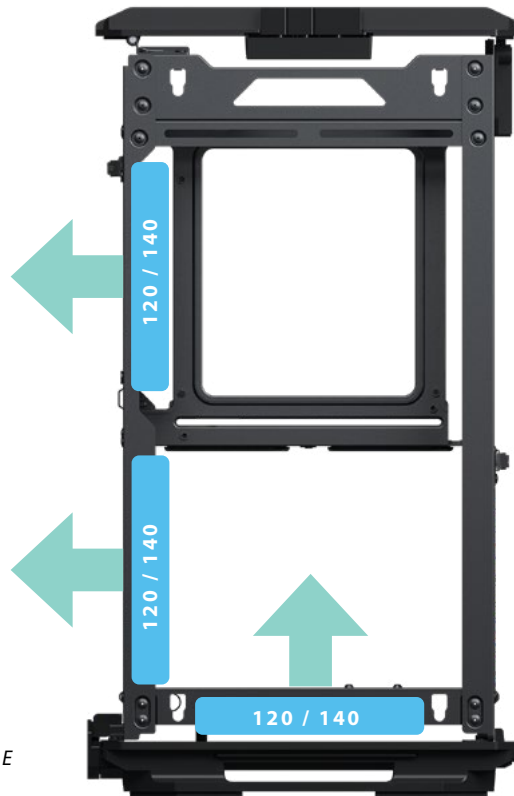

BOTTOM

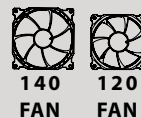

The arrows in the picture show our recommended installation orientation for all fans

An 120 AIO cooler can be installed in the lower rear fan position.

1. MOUNT THE FAN AND RADIATOR ON THE LOWER REAR FAN POSITION
2. FOLLOW THE INSTALLATION INSTRUCTIONS FROM THE AIO COOLER

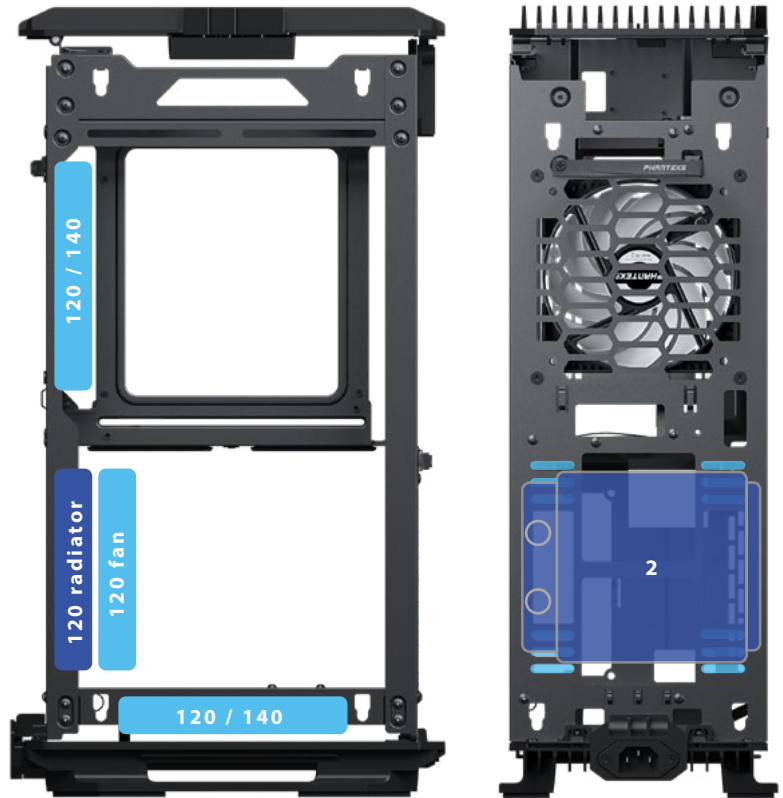

120mm aio location

Max. radiator size supported:

(LxW): 157x148mm

Thickness: 45mm with SFX power supply

30mm with SFX-L power supply



Positioning the radiator sideways ensures a silent and reliable operation for the aio pump.

Install the mini-ITX motherboard with 4x motherboard screws.

REQUIRES:



Wait until the end to connect all cables for easier installation of all the components.

Remove the GPU Bracket and riser cable before mounting the GPU.

1. UNSCREW THE SILVER THUMB SCREW
2. UNSCREW THE 2X SCREWS HOLDING THE BRACKET



Install the GPU on the GPU bracket first before placing it in the chassis. The GPU bracket is configured to face the GPU cooler towards the side panel out of the box. If you prefer to face the GPU cooler towards the motherboard, please move the stand-off as shown in step 3.

REQUIRES:



2 x

1. *PLACE THE GPU ONTO THE GPU BRACKET*
2. *SECURE THE GPU WITH 2X SCREWS (PSU SCREWS)*



3. *OPTIONAL: MOVE THE STAND-OFF IF YOU WANT TO FACE THE GPU COOLER TOWARDS THE MOTHERBOARD. THE STAND-OFF CAN BE EASILY LOOSENED AND REPOSITIONED WITH A FLAT SCREWDRIVER*

Place the GPU Bracket with GPU in the chassis.

1. ROUTE THE RISER CABLE TO THE MOTHERBOARD SIDE
2. POSITION THE GPU BRACKET TO ITS POSITION
3. MOUNT THE GPU BRACKET WITH 2X SCREWS

REQUIRES:



2 x



1 x

4. SECURE THE GPU BRACKET WITH THE SILVER THUMB SCREW



The silver thumbscrew needs to be installed on the other side of the chassis



Don't fully tighten the screws yet so you can adjust the exact GPU position.

2.5" SSD INSTALLATION

Two 2.5" SSD drives can be installed in the Dual SSD Bracket. Orientation of the drives is important for easy cable management, so please follow the following steps for correct installation. Optionally, a second Dual SSD Bracket can be installed in a second location if no 3.5" HDD is installed.

REQUIRES:



1. *SLIDE THE DUAL SSD BRACKET FROM THE CHASSIS*
2. *INSTALL ONE OR TWO SSD DRIVES IN THE BRACKET WITH 4X SSD SCREWS PER DRIVE*



Mind the orientation of the SSD drives in the bracket, this will make connecting the Sata cables easier.



3. *PLACE THE SSD BRACKET BACK ON TO THE CHASSIS*



2 More SSD drives can be installed with an optional extra Dual SSD Bracket (PH-SDBKT_02)



3.5" HDD INSTALLATION

A 3.5" HDD can be installed using the rubber grommets that are pre-installed on the chassis.

1. UNSCREW THE 4 RUBBER GROMMETS
2. MOUNT THE 4 RUBBER GROMMETS ON THE BOTTOM OF THE HDD DRIVE

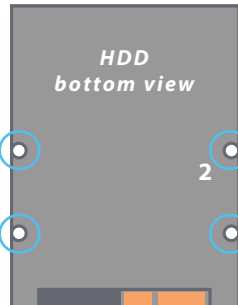

3. SLIDE THE HDD DOWN ON THE CHASSIS



Install the HDD drive with the connectors facing downwards for easier cable management.

Please consult the motherboard manual for additional instructions.

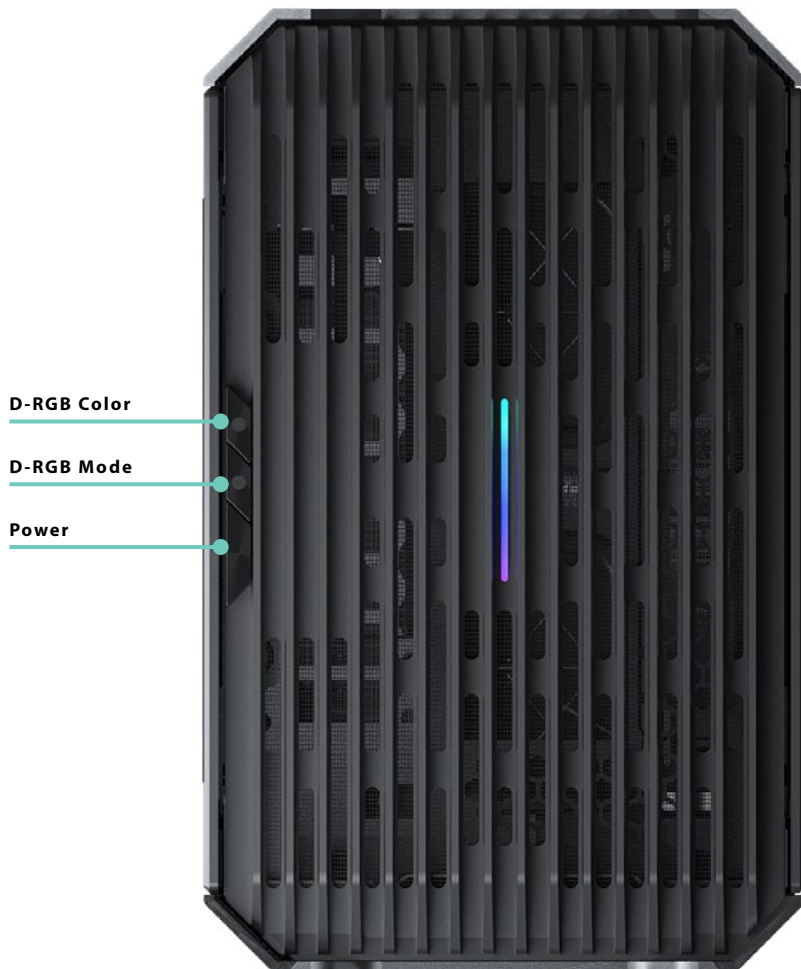

D-RGB Color

D-RGB Mode

Power

TO MOTHERBOARD

POWER BUTTON



USB 3.0

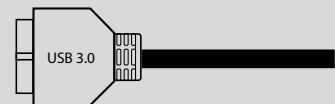

D-RGB Motherboard (OPTIONAL)



TO POWER SUPPLY

D-RGB POWER LED / CONTROLLER

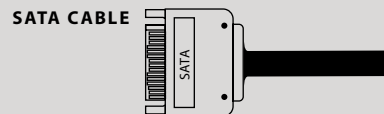

TO D-RGB PRODUCTS

PHANTEKS D-RGB



THIRD PARTY D-RGB



At this stage all cables can be connected to the system components.
For easier cable management we recommend to connect all small cables first and power cables last.

1. **SMALL CABLES**

Connect all small cables to the motherboards; Power Switch, fans, D-RGB, SATA Data.

2. **USB 3.0**

Connect the USB 3.0 cable to the motherboard.

3. **CPU CABLE**

Route the CPU Cable to the cut-out at the top where it can be connected to the motherboard.

4. **24-PIN MOTHERBOARD CABLE**

Connect the 24-PIN Motherboard cable to the motherboard.

5. **AIO TUBING**

Route the tubing in the cut-out. Optionally you can use zip-ties to hold them in place here.

6. **CABLE COVER**

The magnetic cable cover securely snaps into place on the inside of the chassis by magnets.



7. GPU CABLE

Route the GPU Cable(s) under the Dual SSD Bracket to the cable cut-out toward the GPU.

8. SATA/MOLEX CABLES

Connect the SATA/Molex cables to the Storage Drives and make a bundle with the excess cables. Use the velcro strap to tie them down.

9. EXCESS CABLES

Use the velcro ties and zip-tie locations to bundle any excess cables on the outside of the chassis as much as possible. This will create a clean interior and keeps components within reach.

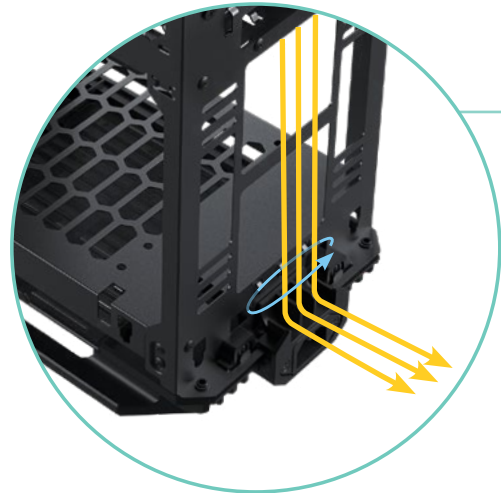
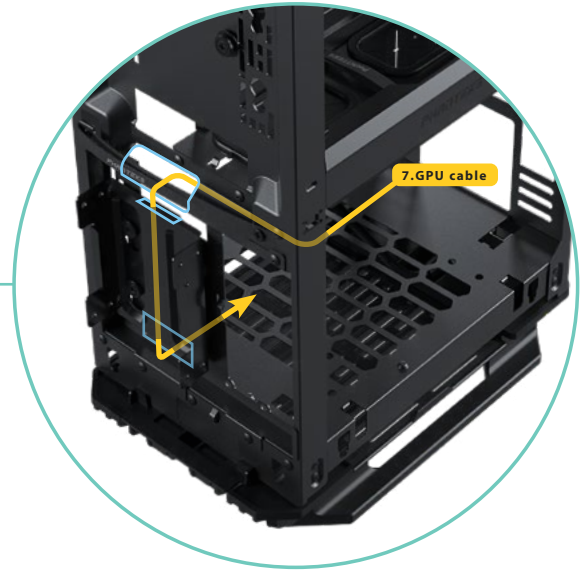
**10. EXTERNAL CABLES**

Use the channels at the power connector to route external cables such as HDMI, USB and audio cables underneath the aluminium panels.

Secure the external cables with a zip-tie.

The Digital-RGB lighting can be easily controlled with the 2 buttons on the top of the chassis.



D-RGB MODE BUTTON*



D-RGB COLOUR BUTTON*



D-RGB CONTROLS

M MODE

C COLOR

- Solid
 - Breathing
 - Radar
 - Sparkle
 - Rainbow
-

2 sec Press & Hold **MODE**: Turn off Front LED's.
2 sec Press & Hold **MODE** 2 sec again: Turn off all LED's.
 (allows the controller to sync to motherboard input)

CONNECT MORE D-RGB PRODUCTS

To DIGITAL-RGB Products



SYNC TO MOTHERBOARD

To D-RGB Motherboard (optional)

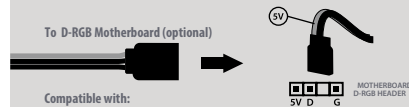

Compatible with:



addressable



addressable



rainbow



The Evolv Shift 2 is equipped with a bottom and top dust filter. The bottom dust filter is removable for easy cleaning (2). The top dust filter is built into the top panel (1). The front and rear panel have metal ultra-fine mesh parts that also act as dust filters (3 & 4). We recommend to clean these filters every month to keep your cooling performance optimized.



If cleaning the dust filters with water, make sure to properly dry them before placing them back.

140 SK (D-RGB) PWM FAN

PH-F140SK_BBK_PWM / PH-F140SK_DRGB_PWM

The Phanteks SK PWM fans deliver optimized and enhanced static pressure for better cooling performance. The nine blades design is highly efficient in producing optimal air pressure and balanced airflow. Available in D-RGB and Black versions.

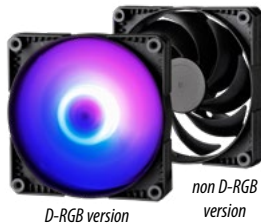

120 SK (D-RGB) PWM FAN

PH-F120SK_BBK_PWM / PH-F120SK_DRGB_PWM

The Phanteks SK PWM fans deliver optimized and enhanced static pressure for better cooling performance. The nine blades design is highly efficient in producing optimal air pressure and balanced airflow. Available in D-RGB and Black versions.

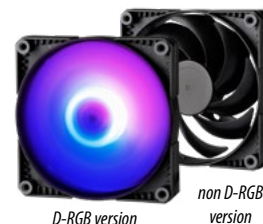

DUAL 2.5" SSD BRACKET

PH-SDBKT_02

This dual bracket offers you room for two more 2.5" SSD drive in your case.



SINGLE 2.5" SSD BRACKET

PH-SDBKT_01

This bracket offers you room for one more 2.5" SSD drive in your case.



Y-SPLITTER CABLE

PH-CB-Y4P / PH-CB-Y3P

The 4-pin / 3-pin Fan splitters are a great solution if you are short of fan headers on your motherboard.



NEON STRIPS

PH-NELEDKT_M5 / PH-NELEDKT_CM80 / PH-NELEDKT_M1

Phanteks' NEON Digital-RGB LED STRIPS provide the smoothest lighting effect with many mounting positions to highlight your system. It's easy to use and secure mounting set lets you choose which hardware to highlight with a diffuse ray of light from the NEON LED strip.



As a Phanteks customer, you are priority number one. We have a dedicated team of employees across the globe working hard every day to make sure we deliver the superior experience you deserve. We are here for you. If you have a question or a concern about our products, we have numerous ways you can reach us. Please choose one most convenient for you to connect with our team.

CUSTOMER CARE

RMA AND TECHNICAL SUPPORT INTERNATIONAL

Email : support@phanteks.com

Facebook : @Phanteks

RMA AND TECHNICAL SUPPORT AMERICAS

Hours : Monday-Friday 9:00-5:00 PST

Phone number : +1(909)598-2115

Email : support@phanteksusa.com

Facebook : @Phanteks



For up-to-date information please check www.phanteks.com

For spare parts and optional upgrades please visit:

www.axpertec.com (EU) | www.phanteksusa.com (US)

PHANTEKS
EVOLV SHIFT 2 PAGE

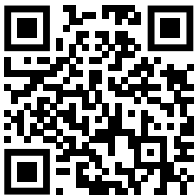

PHANTEKS
FACEBOOK PAGE



PHANTEKS
INSTAGRAM PAGE



PHANTEKS warrants its products to be free from defects in material and workmanship during the warranty period; when given normal, proper and intended usage. If a product proves to be defective in material or workmanship during the warranty period, PHANTEKS will, at its sole option, repair or replace the product with same product or similar product. The replacement product assumes the remaining warranty of the original product or 30 days, whichever provides longer coverage for the customer.

DURATION OF WARRANTY:

1. Fans - 2 years
2. I/O Ports - 2 years
3. LED Lighting - 2 years
4. Buttons - 2 years
5. Chassis - 5 years
6. Front and Top Panels - 5 years
7. Riser Cable - 2 years

Please check <http://www.phanteks.com/Warranty.html> for more information.

