

# ≡ CLIPSE ≡ P600S

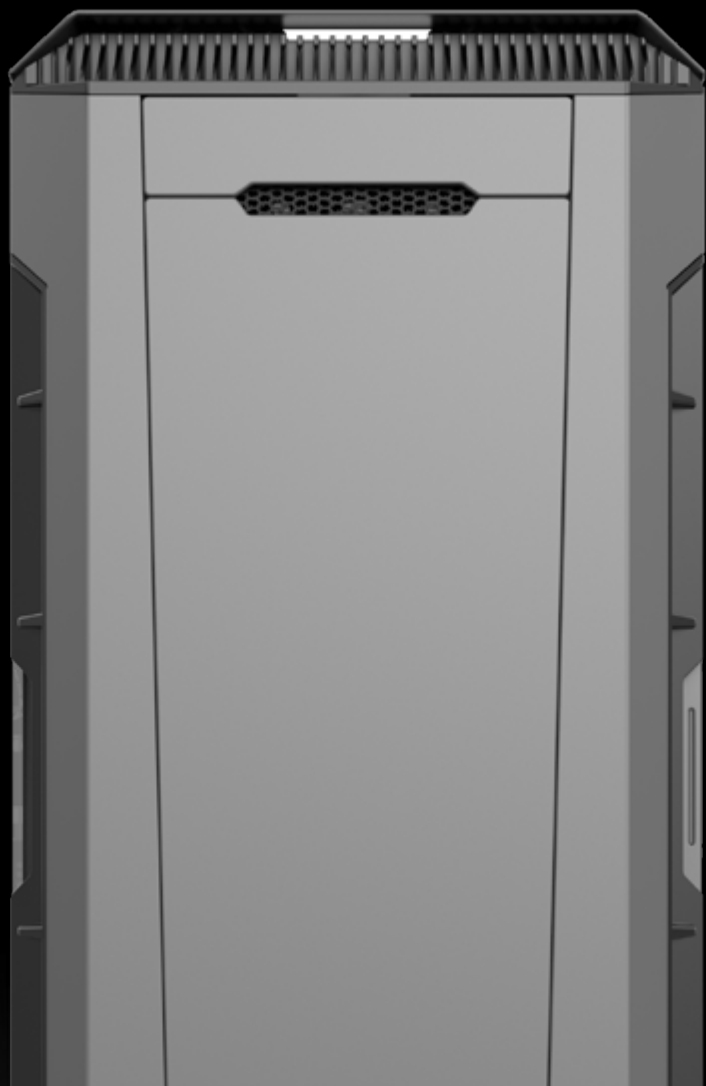

**Thank you**  
for choosing

***PHANTEKS***

## ■ 1. WHAT'S INSIDE?

Introduction	3
Specifications	4
Exploded View	5
Accessories	6

## ■ 2. CHOOSE YOUR SETUP

Configure your P600S	7
Get Started	9
Installing the Motherboard	11
Installing the Power Supply	12
Installing Fans	13
<i>Connecting the Fan Hub</i>	
Installing Drives	15
Installing Water Cooling	18
<i>Radiator Installation</i>	
<i>Pump/Reservoir Installation</i>	
Installing GPU Anti-Sag Bracket	21
Connecting Front I/O	22
Cable Management	23
Maintenance	24

Optional Upgrades:	26
Installing A Vertical GPU	28
Installing A Dual System	29

## ■ 3. SUPPORT

Contact Us	32
Warranty	33

# INTRODUCTION

---

Welcome to Phanteks!

The P600S combines the best of 2 worlds with its high quality sound dampening panels and the ultra high airflow fabrics from Phanteks. Achieving both a quiet system and a high airflow configuration.

The durable fabric, carefully selected by Phanteks, results in a much lower airflow resistance compared to standard mesh panels. Keeping air speed higher and noise levels lower.

*Phanteks believes that meaningful designs are created through  
the fusion of form and function.*

*The Phanteks team*

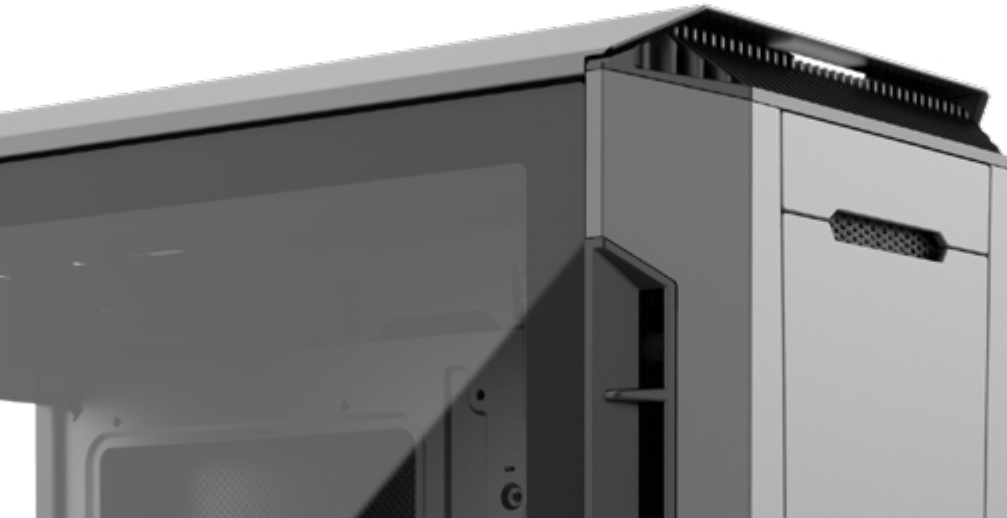

## CASE SPECIFICATIONS

Dimension (WxHxD)	240 mm x 520 mm x 510 mm (9.45 in x 20.5 in x 20.1 in)
Form Factor	Mid-Tower
Materials	Powder coated steel chassis Sound Dampening Panels Tempered glass side panel
MB Support	E-ATX, ATX, Micro-ATX, Mini ITX
Front I/O	Power button, 2x USB 3.0, Microphone, Headphone, Reset Button, USB 3.1 GEN 2 Type-C
Side Window	Yes, Tempered glass

## PCI SLOTS & DRIVE BAYS

PCI slots	7x
Internal 3.5"	10x (4 included)
Internal 2.5"	3x (3 included)

FAN	120 MM	140 MM
Front	3x	3x (2 installed)
Top	3x	2x
Rear	1x	1x (1 installed)

RADIATOR	120 MM	140 MM
Front	Up to 360	Up to 420
Top	Up to 360	Up to 280
Rear	120	140

## INCLUDED ACCESSORIES

Premium Fan 140mm	3x (installed)
Universal Fan Hub	1x (installed)
3.5" Stackable HDD Bracket	4x
Vertical GPU Mount	1x
Accessory Bag	1x
GPU Anti-Sag Bracket	1x
Airflow Cover	1x
Toolbox	1x

## CLEARANCE

E-ATX Motherboard width	280mm	(11.1 in)
CPU Cooler Clearance	190 mm	(7.48 in)
GPU Clearance	435 mm	(17.24 in)
Front Radiator Clearance	95 mm	(3.74 in)
Top Radiator Clearance	65 mm	(2.56 in)

## SUPPORT

Contact (International)	support@phanteks.com
Contact (America)	support@phantekusa.com
Warranty	5 Years*

\*see page 31

## EXPLODED VIEW

1. Chassis
2. Front Panel
3. Top Panel
4. Side Panels
5. Radiator Bracket
6. PSU Bracket
7. Front Silent Cover
8. Top Silent Cover
9. Airflow Cover
10. Front Dust Filter
11. PSU Filter

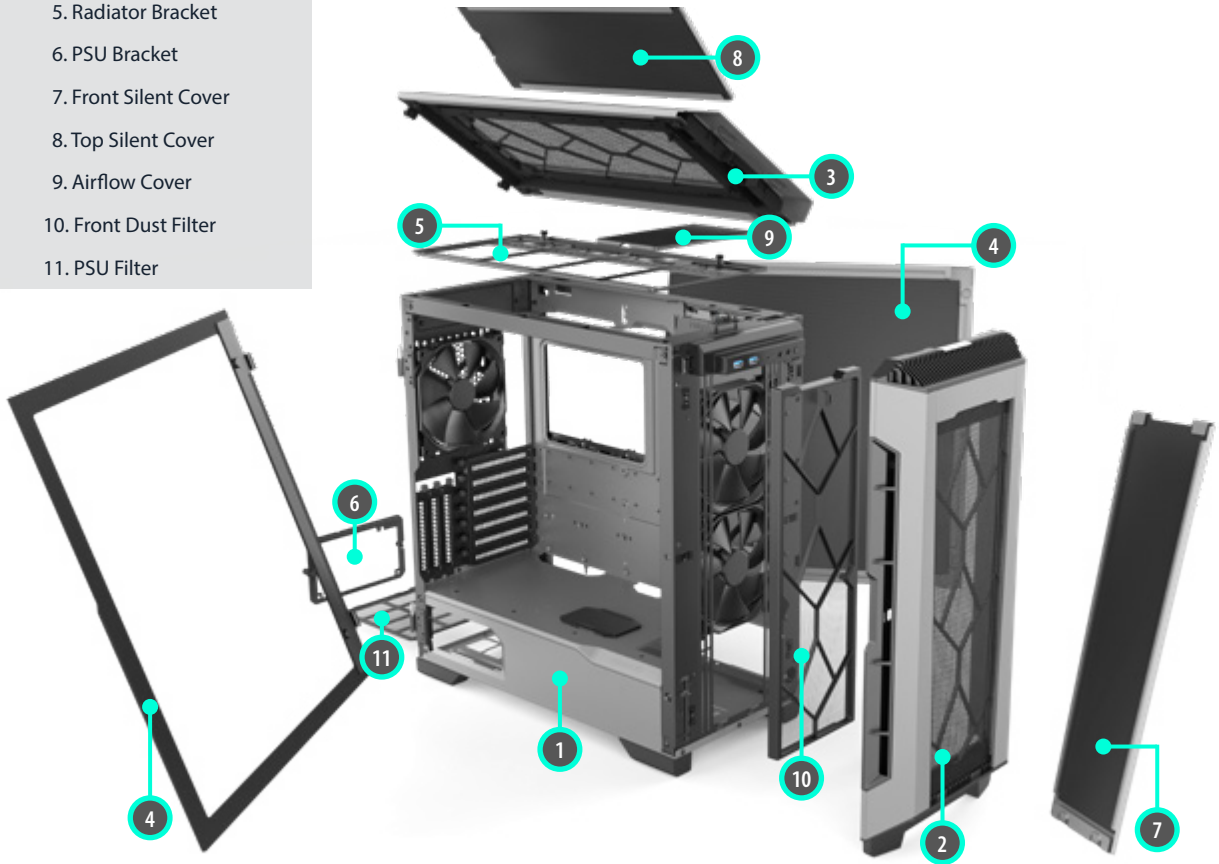

## 3.5" MODULAR HDD BRACKET

- 4 included in accessory box
- For 3.5" or 2.5" Drive



## PREMIUM FAN 140 MM

- 3 Pre-installed
- High static pressure
- Silent operation



## VERTICAL GPU MOUNT

- Included in accessory box
- Riser Cable is sold separately



## AIRFLOW COVER

- Included in accessory box
- Magnetic

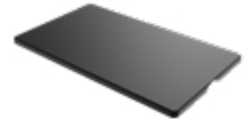









## ACCESSORY BAG AND TOOLBOX

### Accessory bag



GPU Anti-Sag Bracket  
6x Zip Tie 150mm  
Phanteks Logo Badge

### Toolbox

	M3x5 mm Motherboard / SSD screw	Fan screw	Motherboard Standoff + tool	
			 1x  1x	
	22x	12x	1x	
6-32x6 mm Hex screw	6-32x6 mm Thumb screw	6-32x5 mm Case screw	6-32x9 mm HDD screw	Riser Cable screw
				
7x	12x	6x	16x	3x



## CONFIGURE YOUR P600S

The P600S has the most versatile chassis design, providing you with a myriad of options. With so many possibilities to pick from, you can use this overview to choose and plan the best configuration for your build.

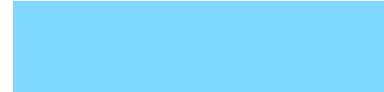
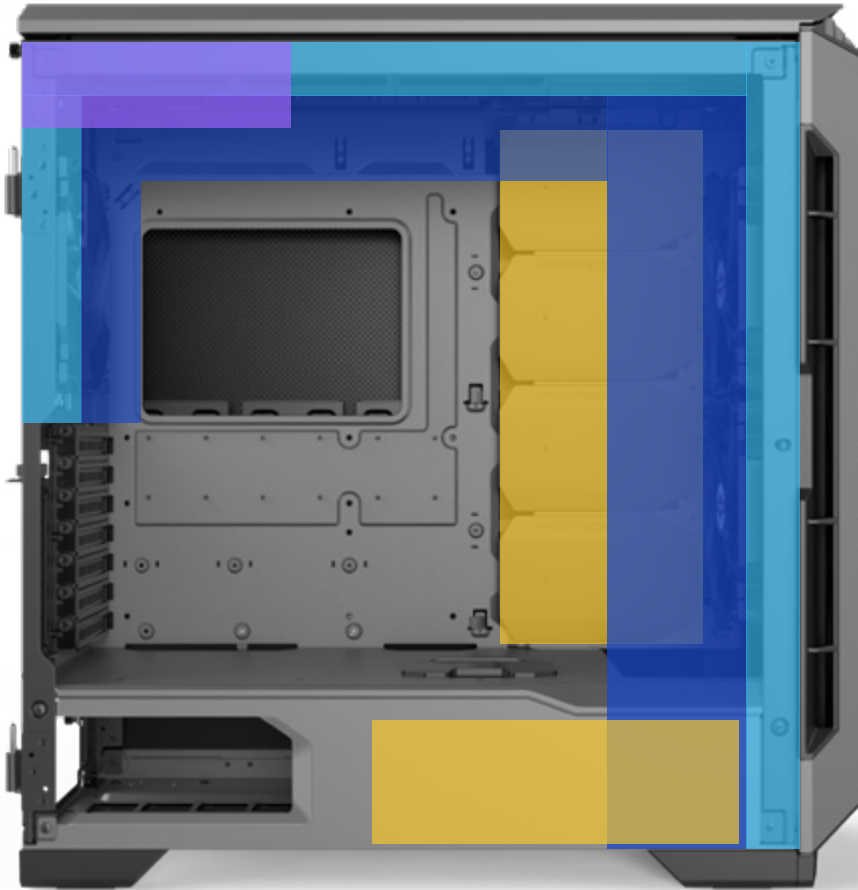

**AIR COOLING - P13.**



**STORAGE - P15.**



**WATERCOOLING - P18.**



**DUAL SYSTEM - P27.**

# ECLIPSE P600s CONFIGURE YOUR P600S

The P600S can be transformed from a Silent to a High Airflow configuration. The magnetic front and top Silent Covers can be easily removed or installed. By removing the Silent Covers the air intake and outtake surface area is increased dramatically, allowing a much higher cooling capacity.



Heavy and sound dampening panels reduce noise levels and improve acoustics.

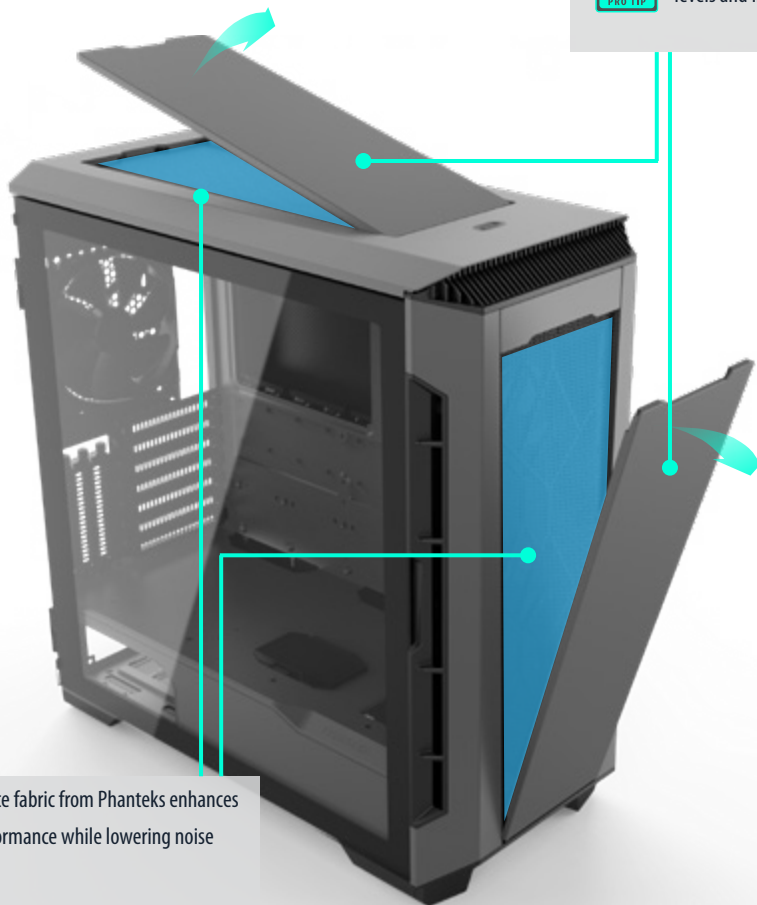

High performance fabric from Phanteks enhances the cooling performance while lowering noise levels.

# GET STARTED

## PREPARATIONS

- The P600S case is designed to support installation in a standing position.
- Don't turn on the power to your system until installation is complete.
- Discharge your body's static electric charge by touching a grounded surface before performing any hardware procedure.
- Make sure to consult the manuals of your hardware before installation.



*If you do not feel comfortable with performing the installation procedure, consult a qualified computer technician.*

### 1. REMOVING FRONT PANEL



### 2. REMOVING TOP PANEL



**LOOSEN:**

4 x



### 3. REMOVING SIDE PANEL

Open the side panel more than 90 degrees and lift it up near the hinges.



# INSTALLING MOTHERBOARD

Use the motherboard screws from the toolbox to install your motherboard on the pre-installed standoffs.

## REQUIRES:

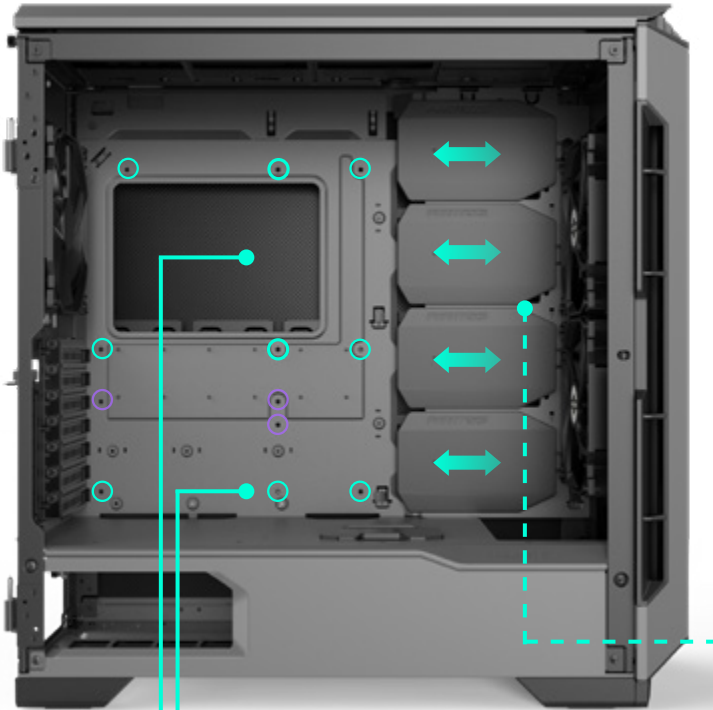

## STANDOFF POSITIONING

**ATX / E-ATX** (Pre-installed) 

**Micro ATX** (install extra standoffs) 

 *Some motherboards require installation or repositioning of the standoffs. Please consult your motherboard manual for the correct standoff positioning.*

   For repositioning standoffs

 **PRO TIP** By loosening the thumb screws you can slide the Cable Covers left and right for optimal cable management.



These standoffs have a special collar to keep the motherboard in place when installing vertically.

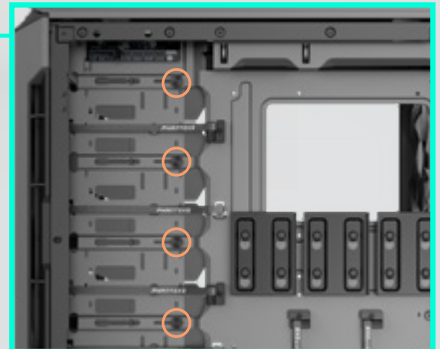

# ECLIPSE P600s INSTALLING POWER SUPPLY

The power supply can be installed by removing the PSU bracket on the rear of the case chassis.

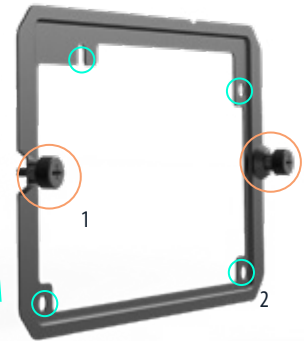

## REQUIRES:

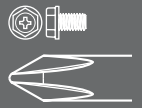

## LOOSEN:

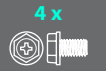
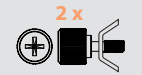

Connect all needed cables to the power supply before installing it in the case.

# INSTALLING FANS

Configure your airflow-path with this overview. All fan locations support both 120mm and 140mm fans.



Install the magnetic Airflow Cover to prevent air from re-circulating when you install 2x 120 mm or 2x 140 mm fans.

## REQUIRES:

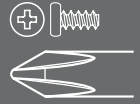

### TOP

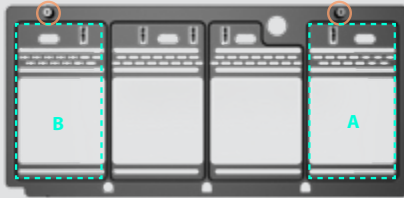
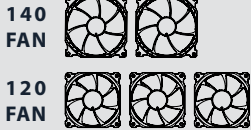

AIRFLOW COVER

### FRONT

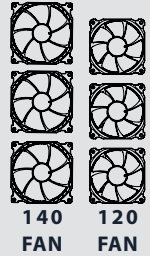

### LOOSEN:

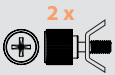

### REAR

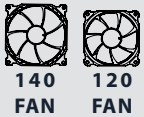

## CONNECTING THE UNIVERSAL FAN HUB

1. CONNECT THE FAN HUB 4-PIN INPUT CABLE TO YOUR MOTHERBOARD FAN HEADER
2. CONNECT EXTRA FANS TO THE CORRESPONDING CONNECTOR ON THE UNIVERSAL FAN HUB
3. CONNECT THE SATA CABLE TO THE POWER SUPPLY

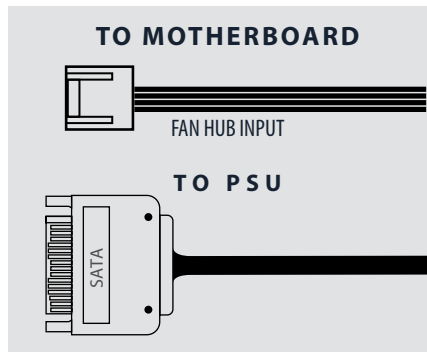

You can choose a PWM or DC output in the motherboard settings. The Fan Hub will automatically translate the signal to all connected 3- and 4-pin fans. Check [WWW.PHANTEKS.COM/FAQ](http://WWW.PHANTEKS.COM/FAQ) for more technical details.



Choosing a PWM output provides the most customization options in the motherboard settings.



Expand the number of fans with splitter cables up to a maximum of 4A total power. Splitter cables are sold separately:  
**PH-CB-Y4P / Y3P**

BLACK 3-PIN DC

BLACK 4-PIN PWM

WHITE 3-/4-PIN  
UNIVERSAL

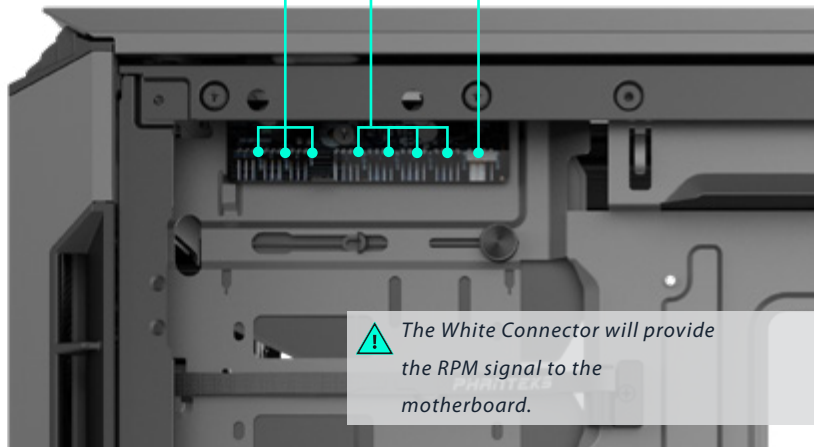



# INSTALLING DRIVES

## 2.5" SSD INSTALLATION

Install the SSD in to the SSD brackets before placing them in the chassis.



Make sure to install the screws into the SSD once it rests in the SSD bracket to secure its position.

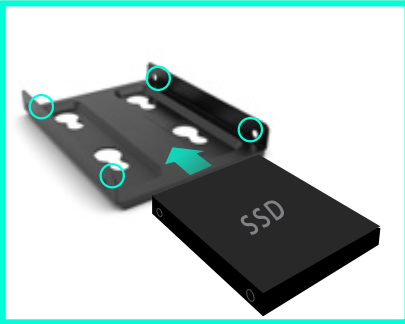

4 x



### REQUIRES:

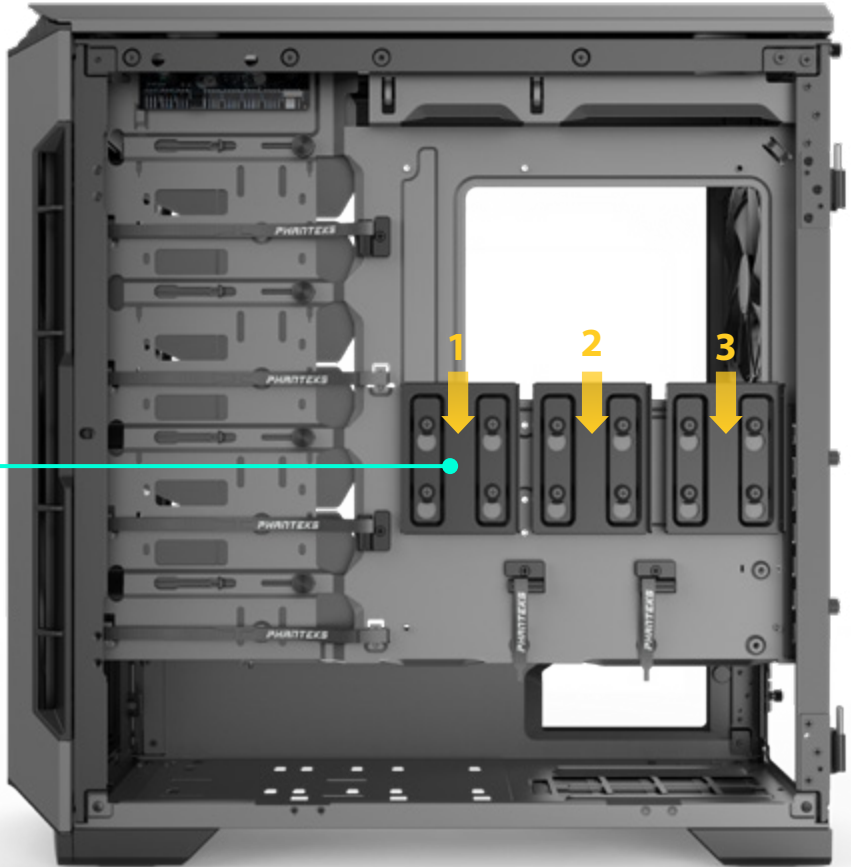
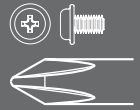

## 3.5" HDD INSTALLATION

4x Phanteks Stackable 3.5" HDD Brackets are included.

Additional brackets are sold separately (PH-HDDKT\_03).

REQUIRES:

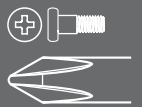

The HDD bracket can also house a 2.5" SSD instead of a 3.5" HDD.

### HDD INSTALLATION

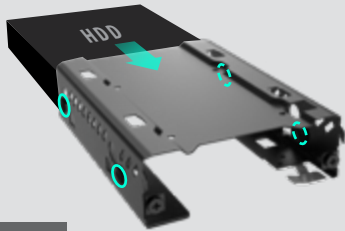

### STACK / INSTALL

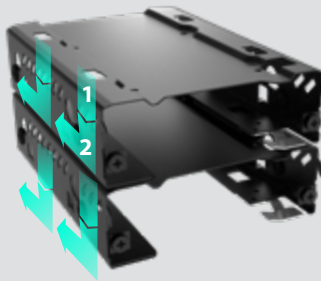

### REMOVE

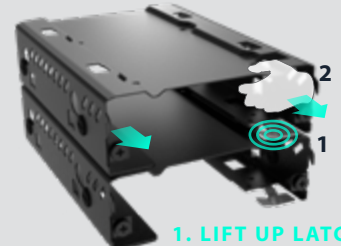

1. LIFT UP LATCH  
2. PULL OUT

4 x



Each HDD bracket can be stacked together to offer more flexibility.

## BOTTOM COMPARTMENT

The Bottom Compartment can house up to 2 or 4 Stackable HDD trays. Using Position B will not limit PSU or Front radiator clearance.

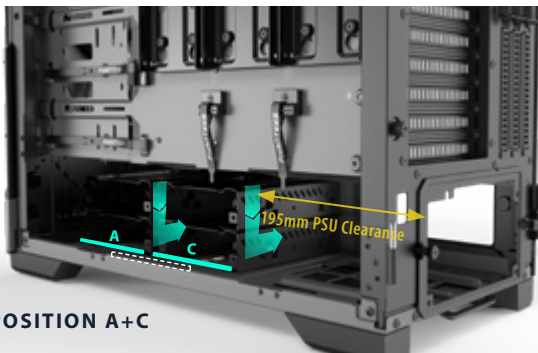

POSITION A+C

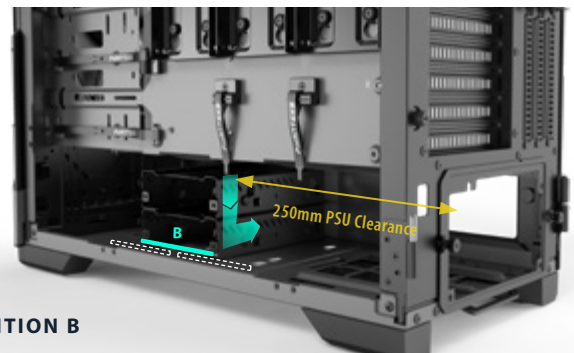

POSITION B

## MAIN COMPARTMENT

Up to 6 Stackable HDD Brackets can be installed in the main compartment.

REQUIRES:



1. REMOVE THE CABLE COVER(S) TO REVEAL THE HDD MOUNTS

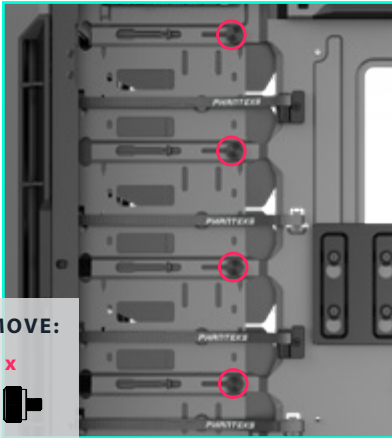

REMOVE:

1 x



3. SECURE WITH 2 THUMBSCREWS

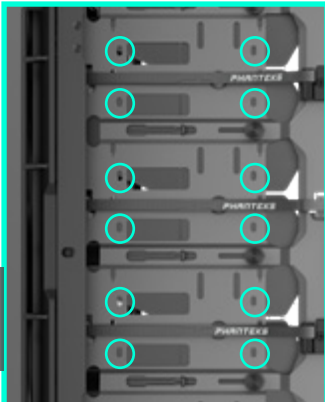

2 x



2. MOUNT THE (SINGLE / STACKED) HDD BRACKETS IN POSITION

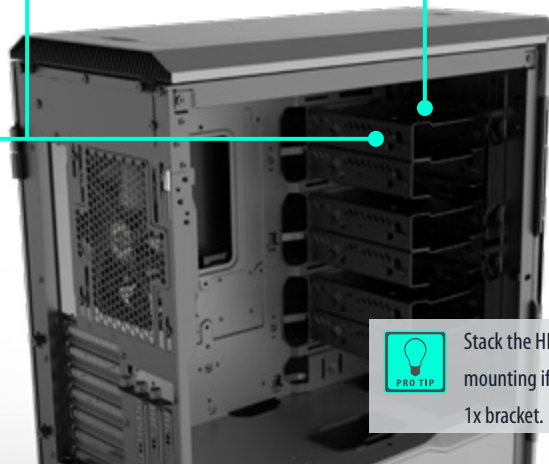
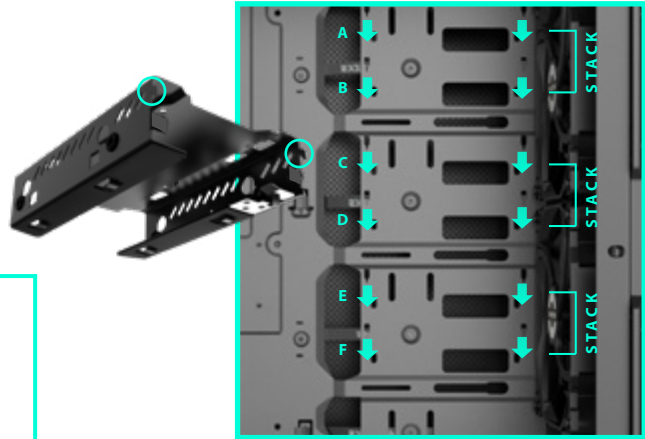

PRO TIP

Stack the HDD brackets before mounting if you install more than 1x bracket.

REQUIRES:



## TOP

### 120 FORM FACTOR



### 140 FORM FACTOR

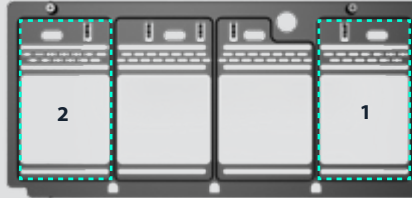

Use the Airflow Cover to prevent hot air from circulating.

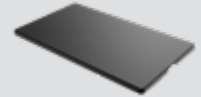

## REAR

### 120 FORM FACTOR



### 140 FORM FACTOR



## FRONT

### 120 FORM FACTOR



### 140 FORM FACTOR



## TOP

### MAX. RADIATOR CLEARANCE

140mm Radiators: **A:405mm B:146mm C:65mm**

120mm Radiators: **A:405mm B:126mm C:65mm\***

*\*If the motherboard and its components (e.g. memory) are 50mm or lower there is no limit in Radiator thickness.*

## FRONT

### MAX. RADIATOR CLEARANCE:

**A:465mm B:148mm C:95mm**

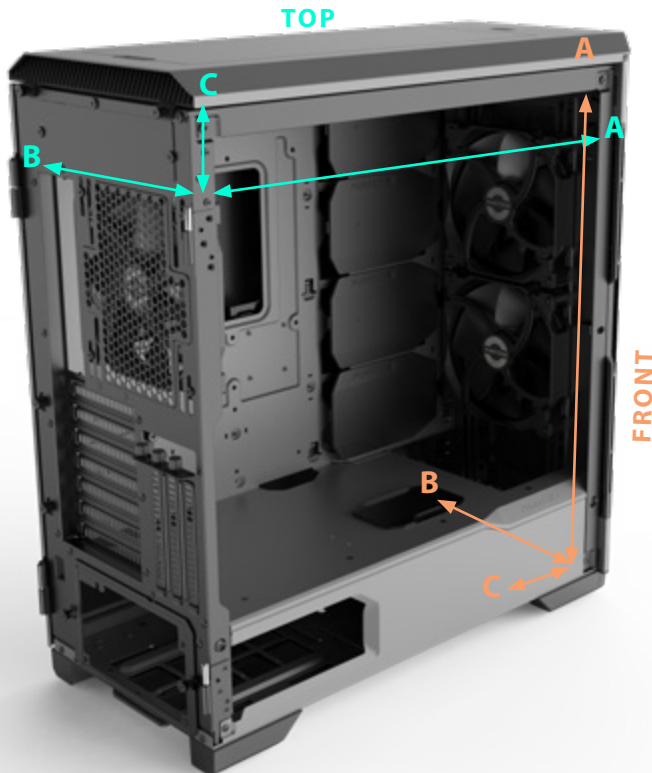

Installing a fill port in the top radiator bracket and/or a drain port in the front of the case makes water cooling maintenance much easier. The port diameters are 20.5mm.

Phanteks Passthrough fitting: **PH-PTF\_BK/CR\_G1/4**

Phanteks Ball-Valve fitting: **PH-BVA\_BK/CR\_G1/4**

FILL PORT

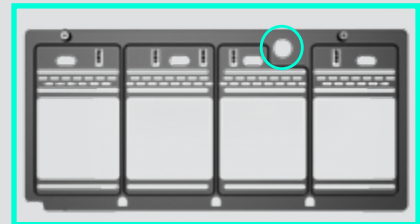

DRAIN PORT

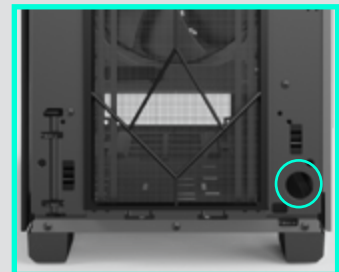

Reservoir mounting points are accessed by removing the Cable Covers.

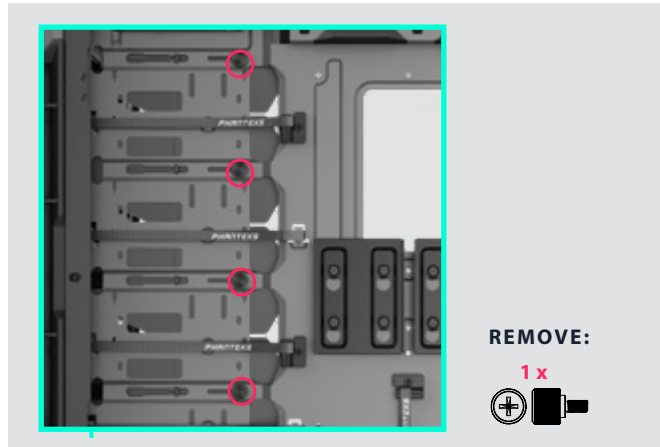
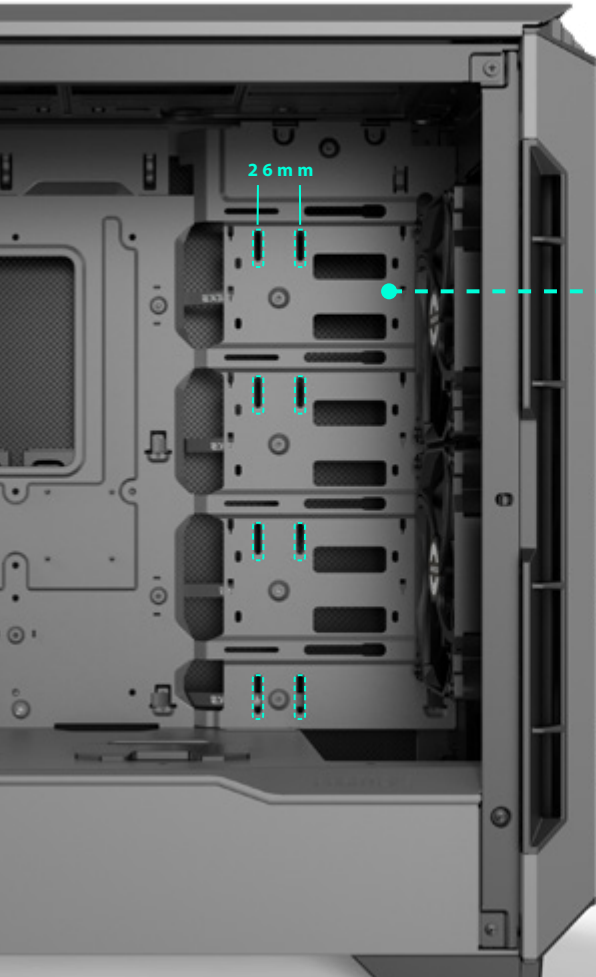

## OPTIONAL PUMP BRACKET

The universal Pump Bracket can be installed in the bottom compartment using 4 case screws.

*Pump Bracket sold separately*

*(PH-PUMBKT\_01)*

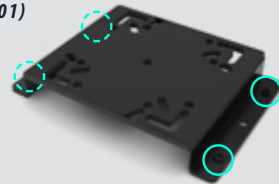

4 x

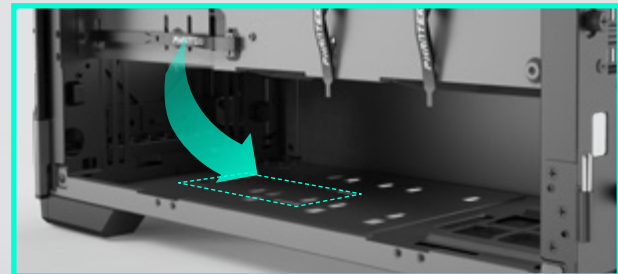

# INSTALLING GPU ANTI-SAG BRACKET

To prevent your GPU from tipping down you can install the GPU Anti-Sag Bracket.

## REQUIRES:

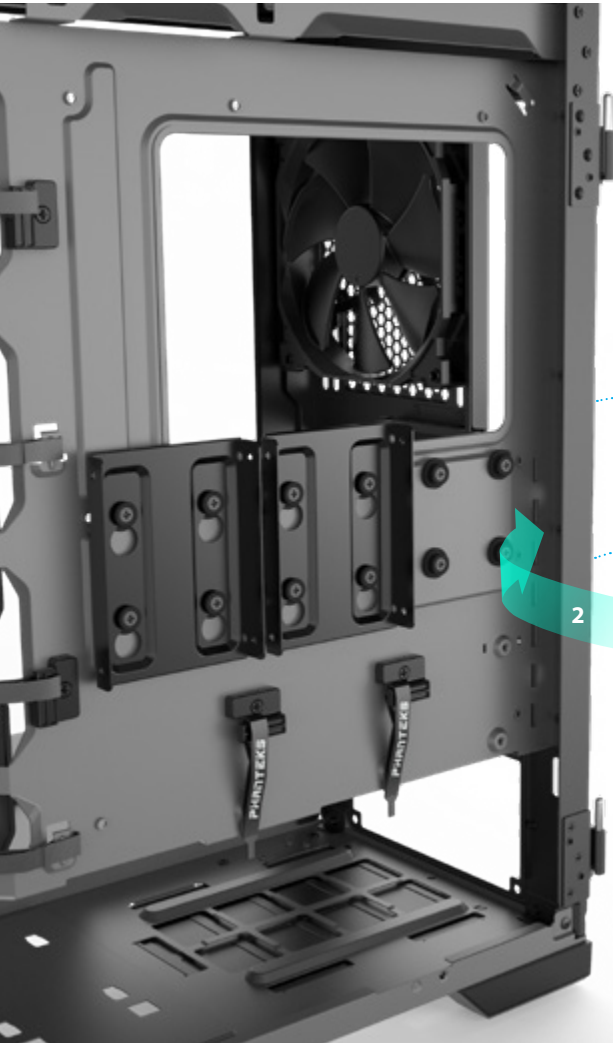
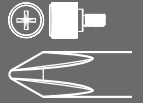

## INSTALLING GPU ANTI-SAG BRACKET

1. *INSTALL ALL GPU AND PCI CARDS*
2. *PLACE THE GPU ANTI-SAG BRACKET*
3. *INSERT THE THUMBSCREWS WITHOUT TIGHTENING THEM*
4. *PRESS DOWN AND LOCK THE THUMBSCREWS IN POSITION.*

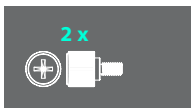

 *Always loosen the 2 thumb screws before removing any GPU or PCI cards.*

 **PRO TIP** Hold the GPU in the correct position when tightening the thumbscrews.



Please consult the motherboard manual for additional instructions.

 Please make sure to consult your motherboard manual before connecting your front I/O.

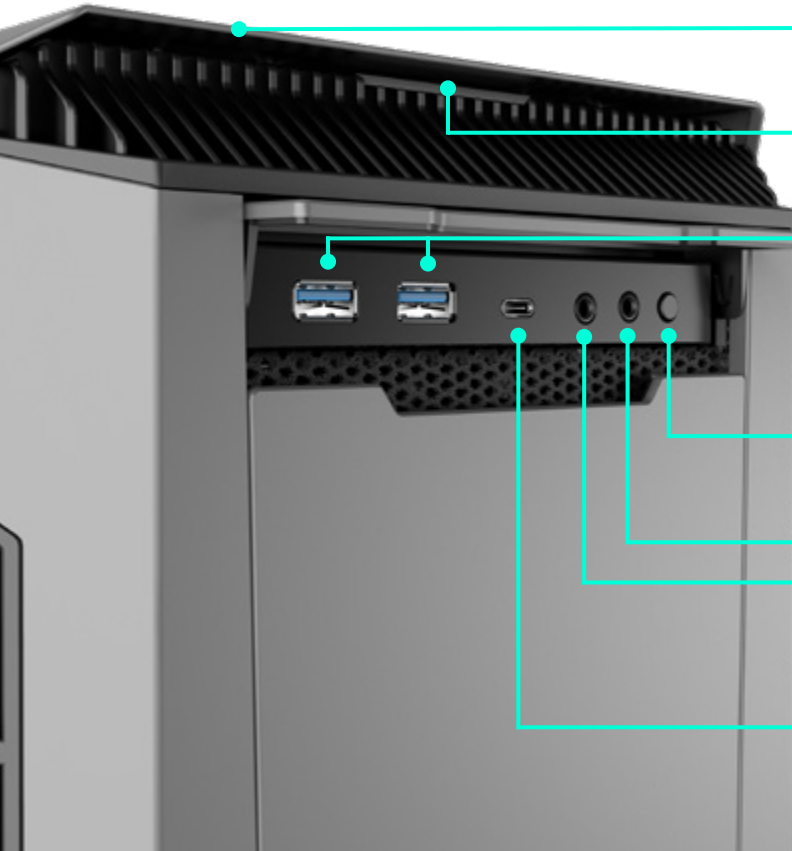

## TO MOTHERBOARD

### POWER BUTTON



### POWER LED

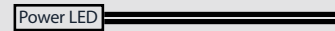

### 2X USB 3.0



### RESET BUTTON



### HEADPHONE

### MICROPHONE



### USB 3.1 GEN 2 TYPE-C





## CABLE MANAGEMENT

Use the double-loop Velcro ties to route your cables. Zip ties are included in the accessory bag to manage any excess cables.

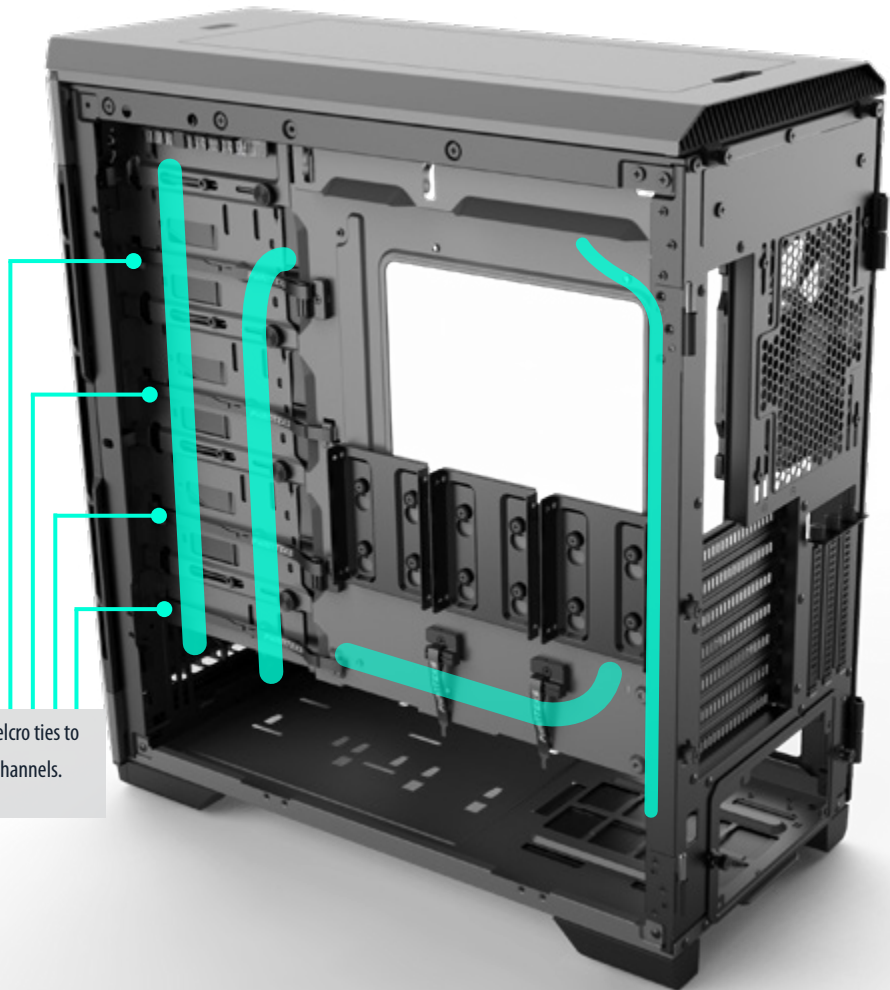

Use the double-loop Velcro ties to split the cables into 2 channels.

The P600S is equipped with a front and bottom PSU filter. We recommend to clean these filters every month to keep your cooling performance optimized.

## PSU DUSTFILTER



## FRONT DUSTFILTER



*If cleaning the dust filters with water, make sure to properly dry them before placing them back.*

The high-performance fabric on the front and top of the P600S acts as an extra dust filter and can be easily cleaned with a vacuum cleaner. There is no need to remove the panels from the case.

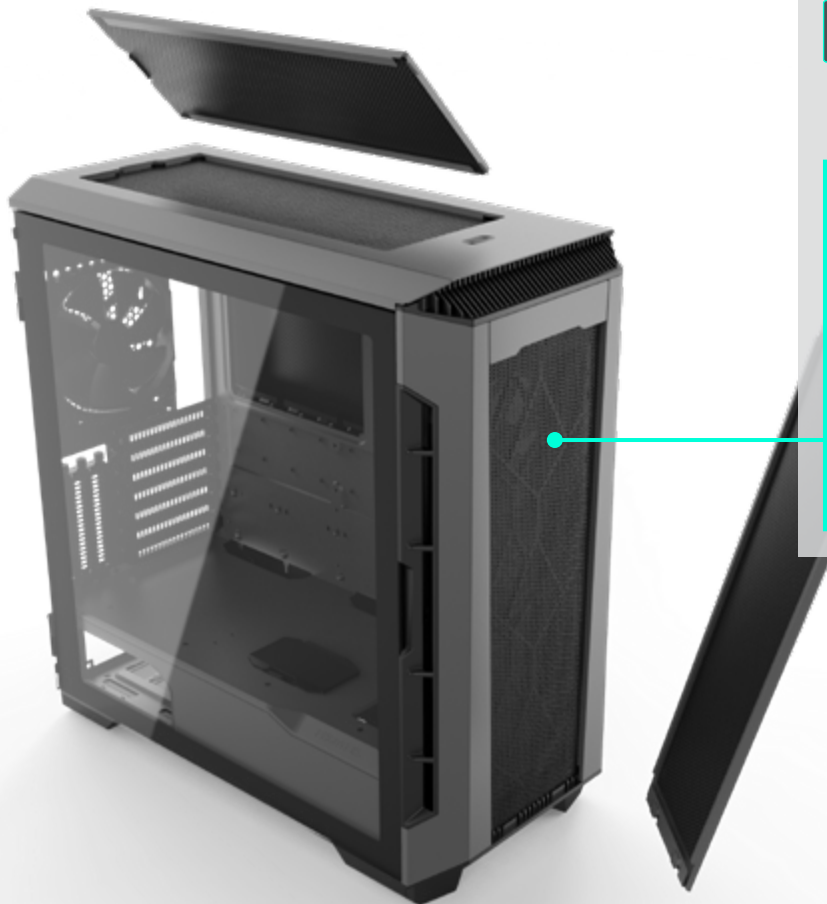

The high-performance fabric from Phanteks is made from durable nylon to resist wear-and-tear for a long period of time.



## 3.5" STACKABLE HDD BRACKETS

PH-HDDKT\_03

For 3.5" or 2.5" Drive

Upgrade up to 6x additional 3,5" HDDs with the optional HDD brackets.

Contains 2x Stackable HDD Brackets.

Page 15



## HIGH STATIC PRESSURE MP FAN

PH-F120MP / PH-F140MP

More fans can be installed in the P600S and connected to the Universal Fan Hub.

Page 12



## Y-SPLITTER CABLES

PH-CB-Y4P / PH-CB-Y3P

4-pin / 3-pin Fan splitters

Using splitter-cables you can install more than 8 fans to the Universal Fan Hub.

Page 13



## CABLE EXTENSION SET

PH-CBCMBO

- Available in multiple colors
- Includes clear cable combs
- Also available as separate cables



### Included cables:

- Motherboard 24-pin
- CPU 4+4-pin
- 2x GPU 6+2-pin

### 220mm Slimline PCI-e x16 Riser Cable 90°

PH-CBRS\_SL22

### 220mm Premium Shielded High Speed PCI-e x16 Riser Cable 90°

PH-CBRS\_PR22

### 220mm Flatline PCI-e x16 Riser Cable 90°

PH-CBRS\_FL22

With the optional Riser Cable you can place any 2-slot or 3-slot GPU vertically.\*

Page 27

\* For System 1 only.

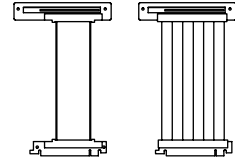

### Revolt X Power Supply

PH-P1000PS / PH-P1200PS

The Revolt X power supply unlocks the Dual System Configuration.

But also works great as a “single system” power supply.

Page 11



### ITX Upgrade Kit

PH-ITXKT\_R01

The Streamer Kit contains an ITX bracket and a 600mm X1 Riser Cable. This allows for an ITX motherboard in the top of the chassis and a vertically placed PCI-e card.

Page 28

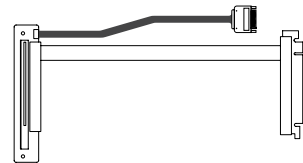

### 600mm Premium Shielded High Speed PCI-E x16 Riser Cable 90°

PH-CBRS\_PR6

With the optional Riser Cable you can place any 2-slot or 3-slot GPU vertically for your 2nd ITX system. With 16 lanes and high quality shielding it maximizes any GPUs' performance.

Page 29

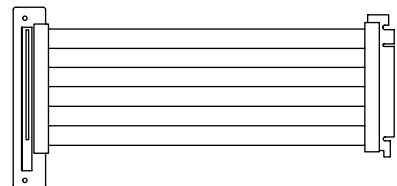

# ECLIPSE P600s INSTALLING A VERTICAL GPU

## 1. INSTALL RISER CABLE WITH 2X RISER CABLE SCREWS

Riser Cable sold separately  
(PH-CBRS\_SL22)

2 x



### REQUIRES:

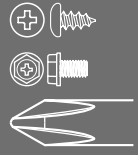

## 2. INSTALL VERTICAL GPU MOUNT WITH 2X HEX SCREWS

2 x



The GPU Mount has 2 mounting positions. Position A allows for better air cooling and 3-slot GPU cards.

# INSTALLING A DUAL SYSTEM

1. REMOVE THE TOP PANEL AND THE DUAL SYSTEM COVER FROM THE CHASSIS

## REMOVE:



2. INSTALL YOUR ITX MOTHERBOARD ON THE BRACKET USING THE INCLUDED MOTHERBOARD SCREWS



3. CONNECT THE POWER SWITCH AND LED CABLE

## TO ITX MOTHERBOARD

Power SW

Power LED

4. INSTALL THE ITX BRACKET WITH 4X ITX BRACKET SCREWS



## REQUIRES:

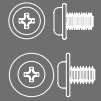

Screws are included in the kit.



The Revolt X power supply from Phanteks is required for this configuration.

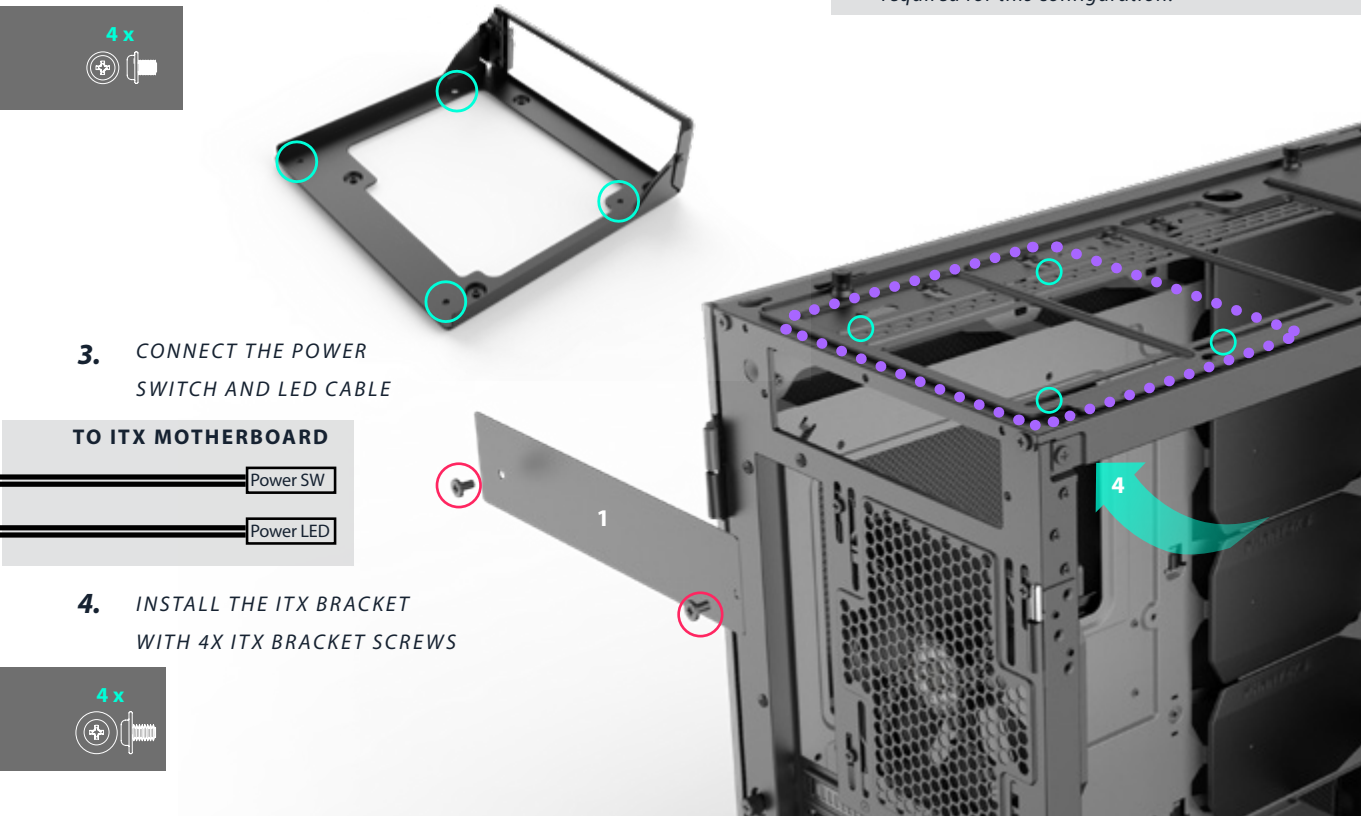

To minimize cable-clutter we recommend the following cable routing for the System 2 cables.

## SYSTEM 2 CABLES

### RISER CABLE

### CPU CABLE

### MOTHERBOARD CABLE

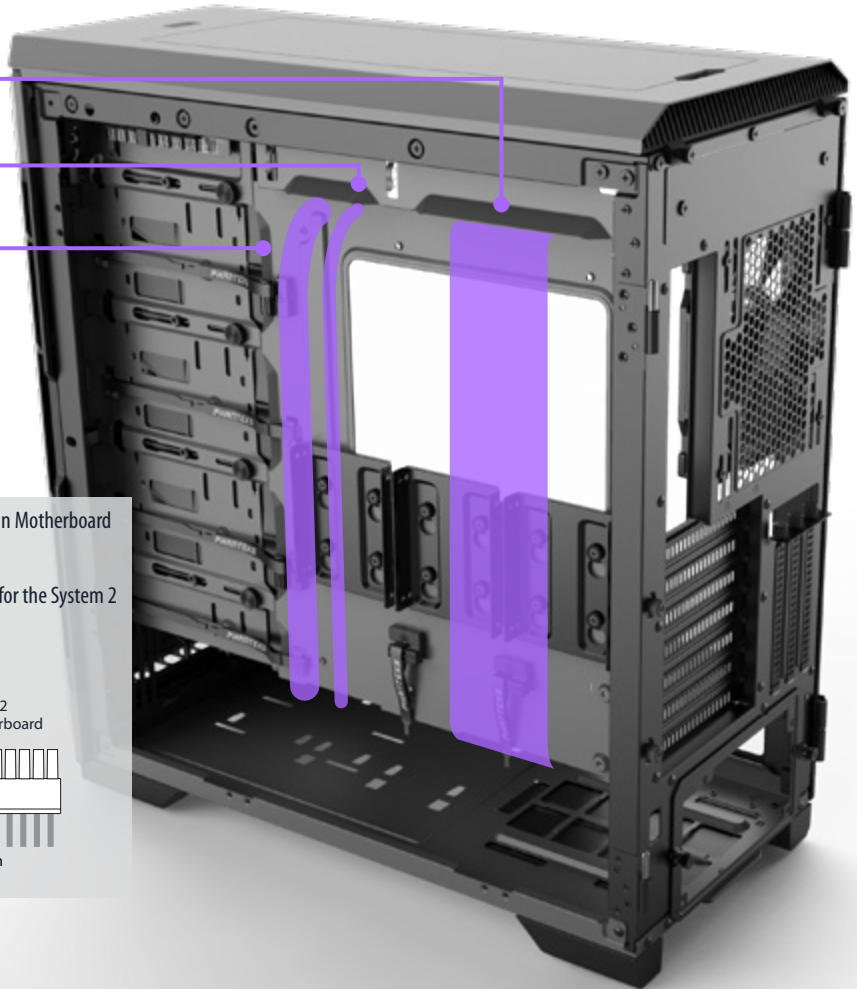

The Revolt X includes 2 different 24-pin Motherboard cable lengths; 610mm and 710mm.

Use the longer, 710mm, 24-pin cable for the System 2 ITX motherboard.

SYSTEM 1  
24-pin Motherboard

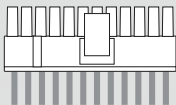

610 mm

SYSTEM 2  
24-pin Motherboard

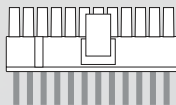

710 mm



# 1. INSTALL RISER CABLE ON THE VERTICAL GPU MOUNT

2 x



## REQUIRES:



Depending on your needs, it's not always necessary to install a GPU for your second system when your CPU is equipped with an integrated GPU.

# 2. INSTALL VERTICAL GPU MOUNT WITH 2 X SCREWS

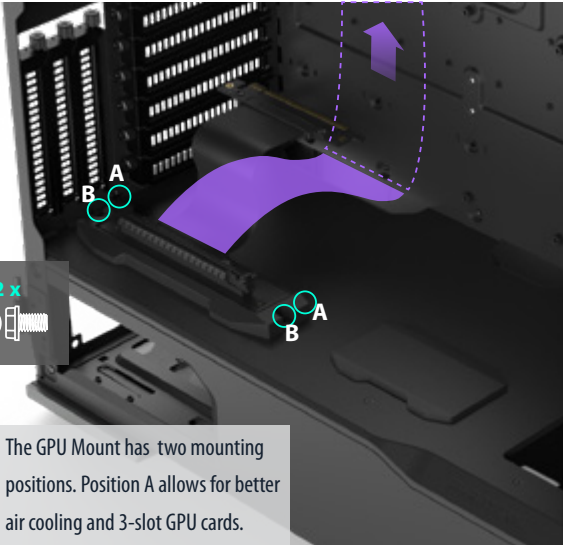

2 x



The GPU Mount has two mounting positions. Position A allows for better air cooling and 3-slot GPU cards.

# 3. MOVE VELCRO TIE

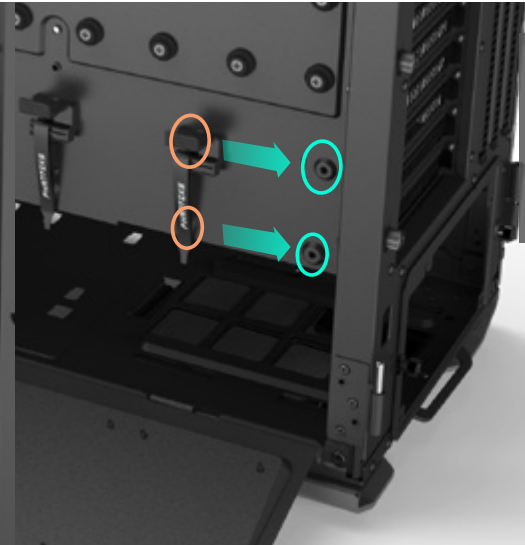

## MOVE:

1 x



1 x



# 4. CONNECT SATA CABLE (only for X1 Riser cable)

TO POWER SUPPLY



As a Phanteks customer, you are priority number one. We have a dedicated team of employees across the globe working hard every day to make sure we deliver the superior experience you deserve. We are here for you. If you have a question or a concern about our products, we have numerous ways you can reach us. Please choose one most convenient for you to connect with our team.

## CUSTOMER CARE

### RMA AND TECHNICAL SUPPORT INTERNATIONAL

Email : [support@phanteks.com](mailto:support@phanteks.com)

Facebook : @Phanteks

### RMA AND TECHNICAL SUPPORT AMERICAS

Hours : Monday-Friday 9:00-5:00 PST

Phone number : +1(909)598-2115

Email : [support@phanteksusa.com](mailto:support@phanteksusa.com)

Facebook : @Phanteks



**For up-to-date information please check [www.Phenteks.com](http://www.Phenteks.com)**

**Eclipse P600S  
PRODUCT PAGE**



**PHANTEKS  
FACEBOOK PAGE**



# WARRANTY

---

PHANTEKS warrants its products to be free from defects in material and workmanship during the warranty period; when given normal, proper and intended usage. If a product proves to be defective in material or workmanship during the warranty period, PHANTEKS will, at its sole option, repair or replace the product with same product or similar product. The replacement product assumes the remaining warranty of the original product or 30 days, whichever provides longer coverage for the customer.

## **DURATION OF WARRANTY:**

1. Fans - 5 years
2. I/O Ports - 2 years
3. Fan Hub - 2 years
4. LED Lighting - 2 years
5. Buttons - 2 years
6. Chassis - 5 years
7. Front and Top Panels - 5 years

Please check [www.phanteks.com/Warranty](http://www.phanteks.com/Warranty) for more information.

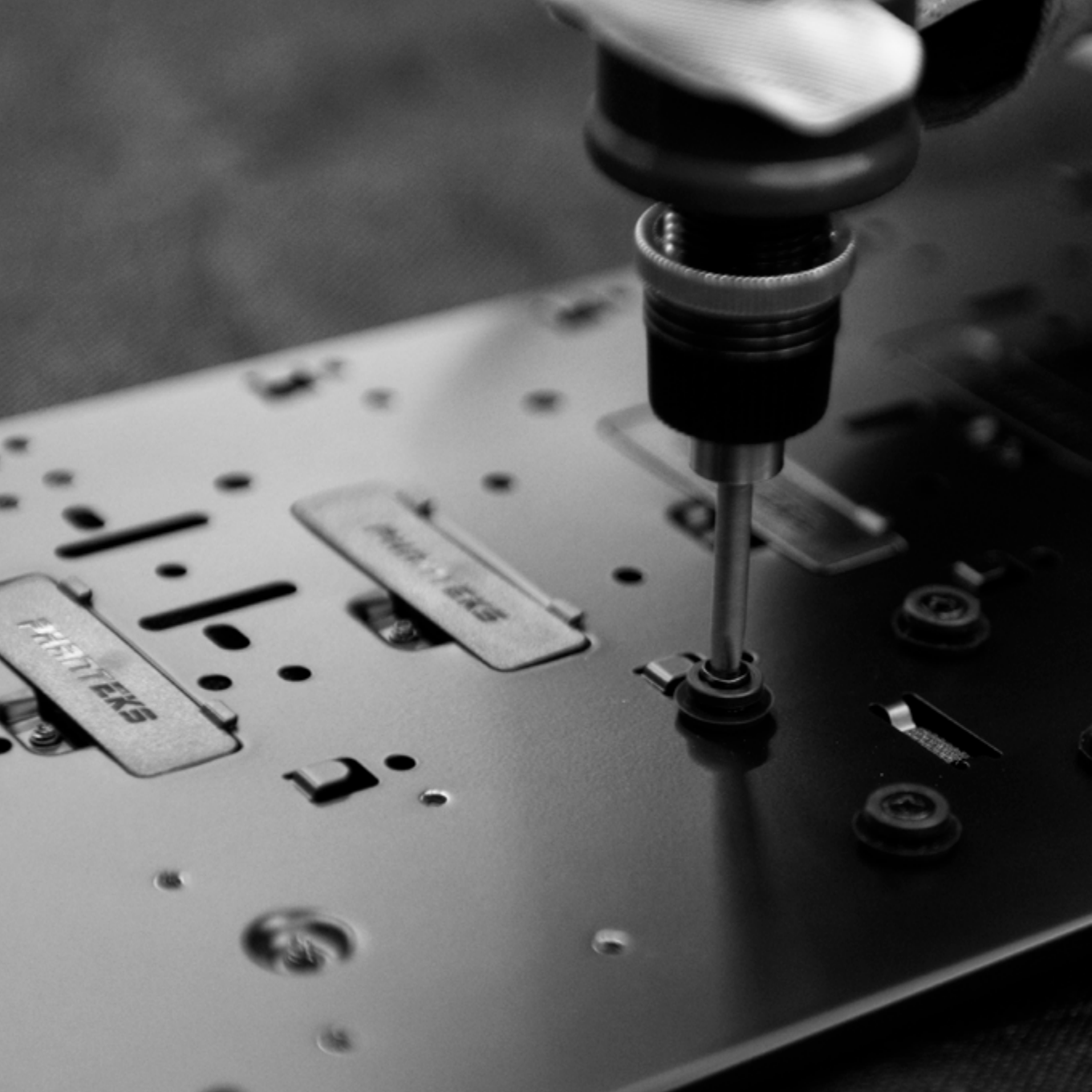

***PHANTEKS***