



Questo manuale d'istruzione è fornito da trovaprezzi.it. Scopri tutte le offerte per [Panasonic W60A 43"](#) (TB-43W60AEY) o cerca il tuo prodotto tra le [migliori offerte di Televisori](#)

Panasonic®

OPERATING INSTRUCTIONS

TB-43W60AEY

TB-50W60AEY

TB-55W60AEY

TB-65W60AEY

LED TV

e-MANUAL

You can find instructions for your TV's features in the **E-Manual**. To access the **E-Manual**, enter **Settings>System>More** menu, select **Manuals** and press **OK**. For quick access press **Settings** button and then **Info** button.

Contents

Safety Information	2	BBC Red Button+ (RB+).....	30
Markings on the Product.....	2	Software Upgrade.....	30
Maintenance.....	4	Troubleshooting & Tips.....	30
Display panel, Cabinet, Pedestal.....	4	HDMI Signal Compatibility.....	31
Mains plug.....	4	Supported File Formats for USB Mode	32
Assembling / Removing the pedestal	4	Video File Formats	32
When using the wall-hanging bracket.....	5	Picture File Formats	32
Environmental Information	5	Audio File Formats	32
Features	6	Subtitle File Formats.....	32
Ultra HD (UHD).....	6	Supported DVI Resolutions	33
High Dynamic Range (HDR) / Hybrid Log-Gamma (HLG).....	6	Connectivity.....	34
Dolby Vision.....	6	Wired Connectivity.....	34
Accessories Included.....	6	Wireless Connectivity	34
Standby Mode Picture	6	Handling of the customer information.....	36
Standby Notifications.....	7	Networked Standby Mode	36
TV Control & Operation	7	Wireless Display	36
Watching TV	8	Connecting Bluetooth Devices	36
Inserting the Batteries into the Remote	9	Connectivity Troubleshooting	37
Power Connection	9	Using Audio Video Sharing Network Service.....	38
Antenna Connection.....	9	Apps	38
Licence Notification	10	Freely Platform	38
Disposal of Old Equipment and Batteries.....	10	Internet Browser	39
Declaration of Conformity (DoC)	10	HBBTV System.....	39
UK Declaration of Conformity (DoC)	11	DVB functionality information	40
Sales and Support Information	11	Important Instruction.....	41
Specification	12		
Notice	13		
Remote Control	14		
Connections.....	15		
Switching On/Off.....	16		
First Time Installation.....	16		
Media Playback via USB Input	18		
Media Browser.....	18		
FollowMe TV.....	19		
CEC.....	19		
Game Mode.....	20		
E-Manual	20		
Settings Menu Content	21		
General TV Operation	28		
Using the Channel List	28		
Configuring Parental Settings.....	28		
Electronic Programme Guide	28		
Teletext Services (where available).....	29		
MHEG Teletext	29		

Safety Information

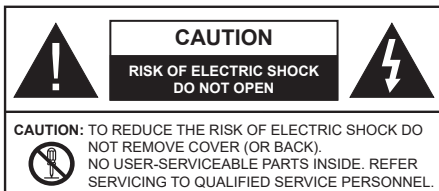

In extreme weather (storms, lightning) and long inactivity periods (going on holiday) disconnect the TV set from the mains.

The mains plug is used to disconnect TV set from the mains and therefore it must remain readily operable. If the TV set is not disconnected electrically from the mains, the device will still draw power for all situations even if the TV is in standby mode or switched off.

Note: Follow the on screen instructions for operating the related features.

IMPORTANT - Please read these instructions fully before installing or operating

WARNING: This device is intended to be used by persons (including children) who are capable / experienced of operating such a device unsupervised, unless they have been given supervision or instruction concerning the use of the device by a person responsible for their safety.



- Use this TV set at an altitude of less than 5000 metres above the sea level, in dry locations and in regions with moderate or tropical climates.
- The TV set is intended for household and similar indoor use but may also be used in public places.
- For ventilation purposes, leave at least 5cm of free space around the TV.
- The ventilation should not be impeded by covering or blocking the ventilation openings with items, such as newspapers, table-cloths, curtains, etc.
- The power cord/plug should be easily accessible. Do not place the TV, furniture, etc. on the power cord. A damaged power cord/plug can cause fire or give you an electric shock. Handle the power cord by the plug, do not unplug the TV by pulling the power cord. Never touch the power cord/plug with wet hands as this could cause a short circuit or electric shock. Never make a knot in the power cord or tie it with other cords. When damaged it must be replaced, this should only be done by qualified personnel.
- Do not expose the TV to dripping or splashing of liquids and do not place objects filled with liquids, such as vases, cups, etc. on or over the TV (e.g. on shelves above the unit).
- Do not expose the TV to direct sunlight or do not place open flames such as lit candles on the top of or near the TV.

- Do not place any heat sources such as electric heaters, radiators, etc. near the TV set.
- Do not place the TV on the floor or inclined surfaces.
- To avoid danger of suffocation, keep plastic bags out of the reach of babies, children and domestic animals.
- Carefully attach the stand to the TV. If the stand is provided with screws, tighten the screws firmly to prevent the TV from tilting. Do not over-tighten the screws and mount the stand rubbers properly.
- Do not dispose of the batteries in fire or with hazardous or flammable materials.

WARNING

- Batteries must not be exposed to excessive heat such as sunshine, fire or the like.
- Excessive sound pressure from earphones or headphones can cause hearing loss.

ABOVE ALL - NEVER let anyone, especially children, push or hit the screen, push anything into holes, slots or any other openings in the TV.

 Caution	Serious injury or death risk
 Risk of electric shock	Dangerous voltage risk
 Maintenance	Important maintenance component

Markings on the Product

The following symbols are used on the product as a marker for restrictions and precautions and safety instructions. Each explanation shall be considered where the product bears related marking only. Note such information for security reasons.



Class II Equipment: This appliance is designed in such a way that it does not require a safety connection to electrical earth.



Hazardous Live Terminal: The marked terminal(s) is/are hazardous live under normal operating conditions.



Caution, See Operating Instructions: The marked area(s) contain(s) user replaceable coin or button cell batteries.



Class 1 Laser Product: This product contains Class 1 laser source that is safe under reasonably foreseeable conditions of operation.

WARNING

- Do not ingest the battery, Chemical Burn Hazard.
- This product or the accessories supplied with the product may contain a coin/button cell battery. If the coin/button cell battery is swallowed, it can cause severe internal burns in just 2 hours and can lead to death.
- Keep new and used batteries away from children.
- If the battery compartment does not close securely, stop using the product and keep it away from children.
- If you think batteries might have been swallowed or placed inside any part of the body, seek immediate medical attention.

A television may fall, causing serious personal injury or death. Many injuries, particularly to children, can be avoided by taking simple precautions such as:

- ALWAYS use cabinets or stands or mounting methods recommended by the manufacturer of the television set.
- ALWAYS use furniture that can safely support the television set.
- ALWAYS ensure the television set is not overhanging the edge of the supporting furniture.
- ALWAYS educate children about the dangers of climbing on furniture to reach the television set or its controls.
- ALWAYS route cords and cables connected to your television so they cannot be tripped over, pulled or grabbed.
- NEVER place a television set in an unstable location.
- NEVER place the television set on tall furniture (for example, cupboards or bookcases) without anchoring both the furniture and the television set to a suitable support.
- NEVER place the television set on cloth or other materials that may be located between the television set and supporting furniture.
- NEVER place items that might tempt children to climb, such as toys and remote controls, on the top of the television or furniture on which the television is placed.
- The equipment is only suitable for mounting at heights ≤ 2 m.

If the existing television set is going to be retained and relocated, the same considerations as above should be applied.

Apparatus connected to the protective earthing of the building installation through the MAINS connection or through other apparatus with a connection to protective earthing – and to a television distribution system using coaxial cable, may in some circumstances create a fire hazard. Connection to a television distribution system

has therefore to be provided through a device providing electrical isolation below a certain frequency range (galvanic isolator).

WALL MOUNTING WARNINGS

- Read the instructions before mounting your TV on the wall.
- The wall mount kit is optional. You can obtain from your local dealer, if not supplied with your TV.
- Do not install the TV on a ceiling or on an inclined wall.
- Use the specified wall mounting screws and other accessories.
- Tighten the wall mounting screws firmly to prevent the TV from falling. Do not over-tighten the screws.

-
- Using other wall-hanging brackets, or installing a wall-hanging bracket by yourself have the risk of personal injury and product damage. In order to maintain the unit's performance and safety, be absolutely sure to ask your dealer or a licensed contractor to secure the wall-hanging brackets. Any damage caused by installing without a qualified installer will void your warranty.
 - Carefully read the instructions accompanying optional accessories, and be absolutely sure to take steps to prevent the TV from falling off.
 - Handle the TV carefully during installation since subjecting it to impact or other forces may cause product damage.
 - Take care when fixing wall brackets to the wall. Always ensure that there are no electrical cables or pipes in the wall before hanging bracket.
 - To prevent fall and injury, remove the TV from its fixed wall position when it is no longer in use.

DAMAGES

- Excepting cases where responsibility is recognised by local regulations, Panasonic accepts no responsibility for malfunctions caused by misuse or use of the product, and other problems or damages caused by use of this product.
- Panasonic accepts no responsibility for loss, etc., of data caused by disasters.
- External devices separately prepared by the customer are not covered by the warranty. Care for the data stored in such devices is the responsibility of the customer. Panasonic accepts no responsibility for abuse of this data.

Figures and illustrations in these operating instructions are provided for reference only and may differ from the actual product appearance. Product design and specifications may be changed without notice.

Maintenance

First, remove the mains plug from the mains socket.

Display panel, Cabinet, Pedestal

Regular care:

Gently wipe the surface of the display panel, cabinet, or pedestal by using a soft cloth to remove dirt or fingerprints.

For stubborn dirt:

1. First clean the dust from the surface.
2. Dampen a soft cloth with clean water or diluted neutral detergent (1 part detergent to 100 parts water).
3. Wring out the cloth firmly. (Please note, do not let liquid enter the TV inside as it may lead to product failure.)
4. Carefully wipe moisten and wipe away the stubborn dirt.
5. Finally, wipe away all the moisture.

Caution

Do not use a hard cloth or rub the surface too hard, otherwise this may cause scratches on the surface.

- Take care not to subject the surfaces to insect repellent, solvent, thinner or other volatile substances. This may degrade surface quality or cause peeling of the paint.
- The surface of the display panel is specially treated and may be easily damaged. Take care not to tap or scratch the surface with your fingernail or other hard objects.
- Do not allow the cabinet and pedestal to make contact with a rubber or PVC substance for a long time. This may degrade surface quality.

Mains plug

Wipe the mains plug with a dry cloth at regular intervals.

Moisture and dust may cause fire or electrical shock.

Assembling / Removing the pedestal

Preparations

Take out the pedestal(s) and the TV from the packing case and put the TV onto a work table with the screen panel down on the clean and soft cloth (blanket, etc.)

- Use a flat and firm table bigger than the TV.
- Do not hold the screen panel part.
- Make sure not to scratch or break the TV.

CAUTION: Please refrain from inserting pictured screws to the TV body when not using the TV stand e.g. wall hanging. Inserting screws without pedestal may cause a damage of the TV.

Assembling the pedestal

1. The stand of the TV consists of two pieces. Install these pieces together.

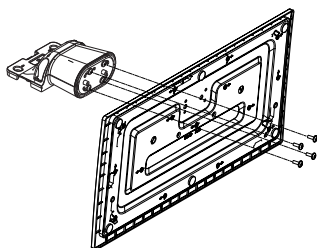

2. Place the stand(s) on the stand mounting pattern(s) on the rear side of the TV.

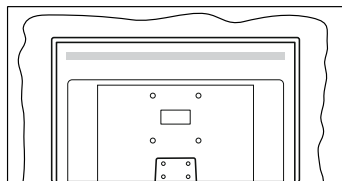

3. Insert the screws (M4 x 12 mm) provided and tighten them gently until the stand is properly fitted.

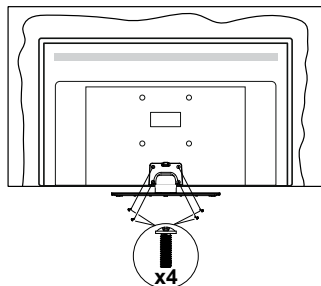

Removing the pedestal from the TV

Be sure to remove the pedestal in the following way when using the wall-hanging bracket or repacking the TV.

- Put the TV onto a work table with the screen panel down on the clean and soft cloth. Leave the stand(s) protruding over the edge of the surface.
- Unscrew the screws that fixing the stand(s).
- Remove the stand(s).

When using the wall-hanging bracket

Please contact your local Panasonic dealer to purchase the recommended wall-hanging bracket.

Holes for wall-hanging bracket installation;

Rear of the TV

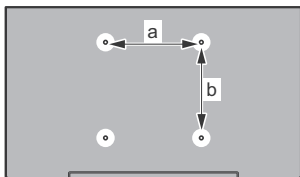

	43"	50"	55"	65"
a (mm)	100	200	200	400
b (mm)	100	200	200	200

View from the side

VESA
Bracket

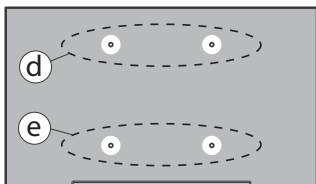
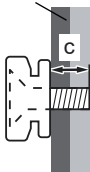

		(d)		(e)	
		43"	50" 55"	43"	50" 55"
Diameter		M4	M6	M4	M6
Depth of screw (c)	min.	7 mm		5 mm	
	max.	10 mm		6 mm	
		(d)		(e)	
		65"			
Depth of screw (c)	min.	7 mm			
	max.	10 mm			
Diameter		M6			

Note: The screws for fixing the TV onto the wall-hanging bracket are not supplied with the TV.

Environmental Information

This television is designed to be environmentally friendly. To reduce energy consumption, you can follow these steps:

If you set the **Energy Saving** to **Minimum**, **Medium**, **Maximum** or **Auto** the TV will adjust the energy consumption accordingly. Set as **Off** to turn this setting off. If you like to set the backlight to a fixed value set as **Custom**, highlight **Backlight** (will be located under the **Energy Saving** setting) and then adjust manually using the Left or Right directional buttons on the remote.

Note: Available **Energy Saving** options may differ depending on the selected **Mode** in the **Settings>Picture** menu.

The **Energy Saving** settings can be found in the **Settings>Picture** menu. Go to Home screen and highlight **Settings** in the Navigation Carousel and press **OK** to access the **Settings** menu. Note that some picture settings will be unavailable to be changed.

You can also turn the screen off using the **Screen Off** option, if you want to hear the sound only and don't need to watch. If pressed Right button or Left button consecutively **Screen Off** option will be selected and "**Screen will be off in 15 seconds.**" message will be displayed on the screen. Select **Proceed** and press **OK** to turn the screen off immediately. If you don't press any button, the screen will be off in 15 seconds. Press any button on the remote or on the TV to turn the screen on again.

Note: **Screen Off** option is not available if the **Mode** is set to **Game**.

When the TV is not in use, please switch off or disconnect the TV from the mains plug. This will also reduce or stop the energy consumption.

Features

- Remote controlled colour TV
- Fully integrated digital terrestrial/cable/satellite TV (DVB-T-T2/C/S-S2)
- HDMI inputs to connect other devices with HDMI sockets
- USB input
- OSD menu system
- Stereo sound system
- Teletext
- Headphone connection
- Automatic programming system
- Manual tuning
- Automatic power down after up to eight hours.
- Sleep timer
- Child lock
- Automatic sound mute when no transmission.
- NTSC playback
- AVL (Automatic Volume Limiting)
- PLL (Frequency Search)
- Game Mode (Optional)
- Picture off function
- Ethernet (LAN) for Internet connectivity and service
- 802.11 a/b/g/n built in WLAN Support
- Audio Video Sharing
- HbbTV

Ultra HD (UHD)

TV supports Ultra HD (Ultra High Definition - also known as 4K) which provides resolution of 3840 x 2160 (4K:2K). It equals 4 times the resolution of Full HD TV by doubling the pixel count of the Full HD TV both horizontally and vertically. Ultra HD content is supported via native and market applications, HDMI, USB input(s) and over DVB-T2 and DVB-S2 broadcasts.

High Dynamic Range (HDR) / Hybrid Log-Gamma (HLG)

Using this feature the TV can reproduce greater dynamic range of luminosity by capturing and then combining several different exposures. HDR/HLG promises better picture quality thanks to brighter, more realistic highlights, more realistic colour and other improvements. It delivers the look that filmmakers intended to achieve, showing the hidden areas of dark shadows and sunlight with full clarity, colour and detail. HDR/HLG content is supported via native and market applications, HDMI, USB inputs and over DVB-S broadcasts. Set the related HDMI source input as **Enhanced** from the **Sources** option in the

Settings>System menu in order to watch HDR/HLG content, if the HDR/HLG content is received through an HDMI input. The source device should also be at least HDMI 2.0a compatible in this case.

Dolby Vision

Dolby Vision™ delivers a dramatic visual experience, astonishing brightness, exceptional contrast, and vivid colour, that brings entertainment to life. It achieves this stunning image quality by combining HDR and wide colour gamut imaging technologies. By increasing the brightness of the original signal and using a higher dynamic colour and contrast range, Dolby Vision presents amazing true-to-life images with stunning detail that other post-processing technologies in the TV aren't able to produce. Dolby Vision is supported via native and market applications, HDMI and USB inputs. Set the related HDMI source input as **Enhanced** from the **Sources** option in the **Settings>System** menu in order to watch Dolby Vision content, if the Dolby Vision content is received through an HDMI input. The source device should also be at least HDMI 2.0a compatible in this case. In the **Settings>Picture>Mode** menu two predefined picture modes will be available if Dolby Vision content is detected: **Dolby Vision Bright** and **Dolby Vision Dark**. Both allow the user to experience the content in the way the creator originally intended with different ambient lighting conditions.

Accessories Included

- Remote Control
- Batteries: 2 x AAA
- Power Cord
- Quick Start Guide
- Detachable stand
- Stand mounting screws (M4 x 12 mm)

Standby Mode Picture

You can use your TV as a digital picture frame using the Standby Mode Picture feature. In order to do this follow the steps below.

- Set the **Standby Mode Picture** option in the **Settings>System>More** menu as **On**. This option is set as **Off** by default. You can also define interval for standby mode picture slideshow using the **Standby Mode Picture Interval** option in this menu.
- Create a separate folder named as **standby_picture** in the USB storage device's root directory and copy the files you want to use into that folder and then connect the USB storage device to your TV.
- Press the **Standby** button on the remote briefly to switch your TV into standby mode picture state.

Note that once the **Standby Mode Picture** option is set as **On**, the function of the **Standby** button on the remote will change. After this you will need to press

and hold the button to switch the TV into standby mode while the TV is in normal operating mode.

If there are more than 1 picture file available in the folder all picture files will be displayed as a slide show in succession. If the necessary folder is not created or there isn't any picture file in the folder, a warning message will be displayed on the screen for a few seconds and then disappear.

In standby mode picture state the backlight level of the screen will be decreased by 50 % and Smart Center features will not be usable, if Smart Center is available for your TV model.

To switch your TV from standby mode picture state back to normal operating mode press the **Standby** button on the remote briefly.

Beside the remote control you can also use the control unit on the TV to switch into standby mode picture state and back to normal operating mode. In order to do that follow the same instructions as described in the **TV Control & Operation** section for switching the TV into the standby mode. Note that you will not be able to switch the TV into standby mode using the control unit on the TV while the TV is in standby mode picture state.

Note: The availability of this feature depends on the TV model and its features.

Refer to the **Supported File Formats for USB Mode** section for the supported media file formats.

Standby Notifications

If the TV does not receive any input signal (e.g. from an aerial or HDMI source) for 3 minutes, it will go into standby. When you next switch-on, the following message will be displayed: **"TV switched to stand-by mode automatically because there was no signal for a long time."** You can disable this functionality by setting the **Timer of No Signal** option in the **Settings>Devices** menu accordingly.

The **Auto Power Down** option (in the **Settings>System >More** menu) could have been set to a value between 1 and 8 hours by default. If this setting is not set as **Off** and the TV has been left on and not been operated during the set time, it will switch into standby mode after the set time has expired. When you next switch-on the TV, the following message will be displayed: **"TV switched to stand-by mode automatically because no operation was made for a long time."** Before the TV switches into standby mode a dialogue window will be displayed. If you do not press any button the TV will switch into the standby mode after a waiting period of about 5 minutes. You can highlight **Yes** and press **OK** to switch the TV into standby mode immediately. If you highlight **No** and press **OK**, the TV will remain on. You can also choose to cancel the **Auto Power Down** function from this dialogue. Highlight **Disable** and press **OK**, the TV will remain on and the function will be set as **Off**. You can enable this function again by

changing the setting of the **Auto Power Down** option from the **Settings>System>More** menu.

TV Control & Operation

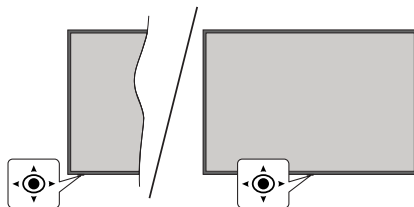

This TV has a joystick as shown in the above drawing. It allows you to control the Volume / Programme / Source and Turn Off - On functions of the TV.

Note: The position of the joystick may differ depending on the model.

To change volume: Increase or decrease the volume by pushing the joystick right or left.

To change channel: Scroll through the stored channels by pushing the joystick forwards or pulling it towards yourself.

To change source: Press the centre of the joystick in, the sources list will appear on the screen. Scroll through the available sources by pushing the joystick forwards or pulling it towards yourself.

To turn the TV off (Hard Standby): Press the centre of the joystick in and hold it down for more than 3 seconds, the TV will turn into hard standby mode.

In hard standby mode the remote control will not function and the standby LED on the TV will not lit. The functions such as networked standby mode (if available) and timers will be disabled. You can turn on the TV from the hard standby only via joystick.

To turn on the TV: Press the centre of the joystick in, the TV will turn on.

Note: Main menu OSD cannot be displayed via joystick.

Operation with the Remote Control

Press the **TiVo** button on your remote control to display Home screen. Use the directional buttons and **OK** button to navigate and set. Press **Back/Return** to quit a menu screen.

Input Selection

Once you have connected external systems to your TV, you can switch to different input sources. Press the **Source** button on your remote control consecutively to select the different sources.

Changing Channels and Volume

You can change the channel and adjust the volume by using the **Programme +/-** and **Volume +/-** buttons on the remote.

Reset and Power Off via Standby Button

Press and hold the **Standby** button to see additional actions for this button. **Restart**, **Standby** (Normal Standby), and **Power off** (Forced Standby) options will be available. Highlight one and press **OK** to perform the selected action. If a problem occurs that prevents the TV from switching into standby mode properly, you can use the **Power off** option to force the TV to switch into standby mode.

If your TV stops responding to commands and the actions menu can not be displayed, the TV will be forced to restart when the button is kept pressed for about 5 seconds. This will terminate the process.

Watching TV

1. Home

The Home screen is your starting point for browsing. It gathers all the TV shows and movies that matter to you - trending titles on all your streaming apps, recently watched shows, live TV channels, and recommended shows based on your ratings and viewing habits.

Content in each carousel changes dynamically based on your usage. Even carousel categories update as TiVo OS gets to know you better. For example, based on what you've been watching, you might see a Comedy Movies or Health & Fitness carousel one day and an Oscar Winners carousel a few days later.

1.1. My Apps Carousel

The **My Apps** carousel on the Home screen contains all the apps from which TiVo OS is making TV show and movie recommendations. You can select the apps that appear here on the **Manage Apps** screen.

When you prefer searching and browsing for shows within an app, select the app in this carousel and press **OK** on your remote control to open it.

1.2. Manage Apps Screen

Use the **Manage Apps** screen to control which apps TiVo OS uses to recommend titles from on the Home, TV Shows, and Movies screens. The apps you select display in the **My Apps** carousel on the Home screen. Your app selections do not affect search results. TiVo OS shows results from all apps to help you find what you want to watch. When an app you're not using has the title, you can then decide to sign up for it.

2. Navigation Carousel

The navigation carousel on the Home screen gives you easy access to common features: **Live TV**, **Guide**, **All Apps**, **Freely**, **Sources**, **Channel List**, **Recordings** (depends on the model), **Timers**, and **Settings**.

3. Browse Screens

Selecting **Free**, **TV Shows**, **Movies**, and **Watchlist** in the Main Menu to focus your browsing on those content types.

4. Content Details

When you find content that interests you, highlight it and press **OK** on your remote control to view details about it. You can also learn about cast and crew, and see recommendations for similar content.

4.1. Watch Now

Choose to watch the show from any of your selected applications that have the show available. These are the applications you enabled for recommendations on the **Manage Apps** screen. Others that have the content display in the More Ways to Watch.

4.2. Watchlist

Use the Watchlist to save shows you want to start or continue watching later and favourites to return to. What you add helps personalise recommendations for you.

The titles you add also appear in a **Watchlist** carousel on the Home screen.

To add a show, select + **Watchlist** on its Content Details screen. The plus changes to a bookmark.

To remove a show, go to its Content Details screen and select **Watchlist**. The bookmark changes to a plus.

4.3. Rate

Tell TiVo OS how you feel about a TV show or movie with a Thumbs Up or Thumbs Down. In return you'll get recommendations that better reflect what you enjoy watching. Go to the Content Details screen of a show and select **Rate**. Choose Thumbs Up or Thumbs Down. Content that you rate Thumbs Down will no longer appear in recommendations.

4.4. Report Content

Go to the Content Details screen of a show and select flag. Report content screen will be displayed. After selecting the pre-defined reasons that suit you, highlight **Report** and press **OK**. You can also select the **Something else** option and enter your reason using the virtual keyboard in case the pre-defined reasons do not suit you.

4.5. Browse All Episodes

Select **Episodes** on the Content Details screen for an episodic TV show series to see its episodes ordered by Season.

5. Text Search

Select **Search** in the Main Menu to search for movies and TV shows across all your applications. Press **OK** and enter a title or actor using the virtual keyboard. Then highlight **Done** and press **OK** to start the search. Results display on the screen. Highlight the desired result using the directional buttons and press **OK** to open.

6. Voice Search and Control

Use your voice to search for TV shows and movies. It's faster and more accurate than typing on a remote control. You can also navigate screens and control volume by speaking naturally. Press the **Voice** button on your remote control (depends on the model of the remote control and the remote control should be paired with the TV before use; refer to the **Remote Control** section for more information), then ask for content by criteria like title, genre, actor, director, rating, age appropriateness, quote, or decade. You can continue to talk to refine search results after they display: "Show me Tom Cruise movies. Just the ones from the 90s."

Note: Voice search and voice control may not be available in some countries.

7. Need Help?

Get answers to common questions and learn to experience the most from TiVo OS at: <https://www.tivo.com/support>

Inserting the Batteries into the Remote

The remote may have a screw that secures the battery compartment cover onto the remote control (or this may be in a separate bag). Remove the screw, if the cover is screwed on previously. Then remove the battery compartment cover to reveal the battery compartment. Insert two 1.5V - size **AAA** batteries. Make sure the (+) and (-) signs match (observing correct polarity). Do not mix old and new batteries. Replace only with same or equivalent type. Place the cover back on. Secure the cover again with the screw, if any.

A message will be displayed on the screen when the batteries are low and must be replaced. Note that when the batteries are low, the performance of the remote control may be impaired.

Batteries should not be exposed to excessive heat such as sunshine, fire or the like.

Power Connection

IMPORTANT: The TV set is designed to operate on a **220-240V AC, 50 Hz** supply. After unpacking, allow the TV set to reach the ambient room temperature before you connect the set to the mains.

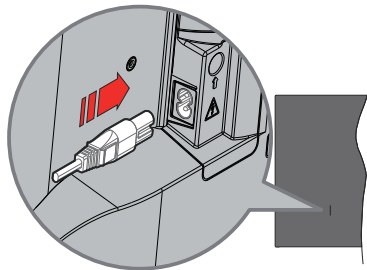

Plug one end (the two-hole plug) of the supplied detachable power cord into the power cord inlet on the rear side of the TV as shown above. Then plug the other end of the power cord into the mains socket outlet.

Note: The position of the power cord inlet may differ depending on the model.

Antenna Connection

Connect the aerial or cable TV plug to the aerial input (ANT) socket or satellite plug to the satellite input (LNB) socket located on the rear-left side of the TV.

Rear-left side of the TV

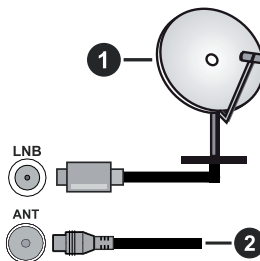

1. Satellite
2. Aerial or cable



If you want to connect a device to the TV, make sure that both the TV and the device are turned off before making any connection. After the connection is done, you can turn on the units and use them.

Licence Notification

The terms HDMI, HDMI High-Definition Multimedia Interface, HDMI trade dress and the HDMI Logos are trademarks or registered trademarks of HDMI Licensing Administrator, Inc.



Dolby, Dolby Vision, Dolby Atmos, and the double-D symbol are registered trademarks of Dolby Laboratories Licensing Corporation. Manufactured under licence from Dolby Laboratories. Confidential unpublished works. Copyright © 2012-2022 Dolby Laboratories. All rights reserved.



YouTube and the YouTube logo are trademarks of Google Inc.

The *Bluetooth*® word mark and logos are registered trademarks owned by the Bluetooth SIG, Inc. and any use of such marks by Vestel Elektronik Sanayi ve Ticaret A.S. is under licence. Other trademarks and trade names are those of their respective owners.

This product contains technology subject to certain intellectual property rights of Microsoft. Use or distribution of this technology outside of this product is prohibited without the appropriate licence(s) from Microsoft.

Content owners use Microsoft PlayReady™ content access technology to protect their intellectual property, including copyrighted content. This device uses PlayReady technology to access PlayReady-protected content and/or WMDRM-protected content. If the device fails to properly enforce restrictions on content usage, content owners may require Microsoft to revoke the device's ability to consume PlayReady-protected content. Revocation should not affect unprotected content or content protected by other content access technologies. Content owners may require you to upgrade PlayReady to access their content. If you decline an upgrade, you will not be able to access content that requires the upgrade.

The "CI Plus" Logo is a trademark of CI Plus LLP.

This product is protected by certain intellectual property rights of Microsoft Corporation. Use or distribution of such technology outside of this product is prohibited without a licence from Microsoft or an authorised Microsoft subsidiary.



Disposal of Old Equipment and Batteries

Only for European Union and countries with recycling systems



These symbols on the products, packaging, and/or accompanying documents mean that used electrical and electronic products and batteries must not be mixed with general household waste.

For proper treatment, recovery and recycling of old products and batteries, please take them to applicable collection points in accordance with your national legislation.

By disposing of them correctly, you will help to save valuable resources and prevent any potential negative effects on human health and the environment.

For more information about collection and recycling, please contact your local municipality.

Penalties may be applicable for incorrect disposal of this waste, in accordance with national legislation.

Note for the battery symbol (bottom symbol):



This symbol might be used in combination with a chemical symbol. In this case it complies with the requirement set by the Directive for the chemical involved.

Declaration of Conformity (DoC)

Hereby, Panasonic Marketing Europe GmbH, declares that this TV is in compliance with the essential requirements and other relevant provisions of the Directive 2014/53/EU.

If you want to get a copy of the original DoC of this TV, please visit the following website:

<http://www.ptc.panasonic.eu/compliance-documents>

Authorised Representative:

Panasonic Testing Centre

Panasonic Marketing Europe GmbH

Winsberg 15, 22525 Hamburg, Germany

Web Site: <http://www.panasonic.com>

UK Declaration of Conformity (DoC)

Hereby, Panasonic Marketing Europe GmbH declares that this product is in compliance with the essential requirements and other relevant provisions of the Radio Equipment Regulations 2017 No. 1206.

If you want to get a copy of the original DoC of this product, please visit the following website:

<http://www.ptc.panasonic.eu/compliance-documents>

Panasonic Marketing Europe GmbH, Wiesbaden, Germany

Importer for UK:

Panasonic UK, a branch of Panasonic Marketing Europe GmbH

Maxis 2, Western Road, Bracknell, Berkshire, RG12 1RT

Sales and Support Information

Customer Communication Centre

- For customers within the UK: **0344 844 3899**
- For customers within Ireland: **01289 8333**
- Monday - Friday 9:00am - 5:00pm, (Excluding public holidays).
- For further support on your product, please visit our website: **www.panasonic.co.uk**

Direct Sales at Panasonic UK

- Order accessory and consumable items for your product with ease and confidence by phoning our Customer Communications Centre Monday - Friday 9:00am - 5:00pm, (Excluding public holidays).
- Or go on line through our Internet Accessory ordering application at **www.pas-europe.com**.
- Most major credit and debit cards accepted.
- All enquiries transactions and distribution facilities are provided directly by Panasonic UK.
- It couldn't be simpler!
- Also available through our Internet is direct shopping for a wide range of finished products. Take a browse on our website for further details.

Specification

TV Broadcasting	PAL BG/I/DK SECAM BG/DK			
Receiving Channels	VHF (BAND I/III) - UHF (BAND U) - HYPERBAND			
Digital Reception	Fully integrated digital terrestrial-cable-satellite TV (DVB-T-C-S) (DVB-T2, DVB-S2 compliant)			
Number of Preset Channels	11 000			
Channel Indicator	On Screen Display			
RF Aerial Input	75 Ohm (unbalanced)			
Operating Voltage	220-240V AC, 50Hz.			
Audio	Dolby Atmos			
Headphone	3.5 mm mini stereo jack			
Networked Standby Mode Power Consumption (W)	< 2			
	TB-43W60AEY	TB-50W60AEY	TB-55W60AEY	TB-65W60AEY
Audio Output Power (WRMS.) (10% THD)	2 x 10 W	2 x 10 W	2 x 10 W	2 x 12 W
Power Consumption (W)	150 W	135 W	140 W	200 W
Weight (kg)	7,5 Kg	9,5 Kg	13 Kg	22 Kg
TV Dimensions DxLxH (with stand) (mm)	235 x 965 x 619	235 x 1120 x 706	235 x 1233 x 770	275 x 1453 x 896
TV Dimensions DxLxH (without stand) (mm)	87 x 965 x 561	87 x 1120 x 648	87 x 1233 x 712	82 x 1453 x 836
Display	16/9 43"	16/9 50"	16/9 55"	16/9 65"
Operation temperature and operation humidity	0°C up to 40°C, 85% humidity max			

For more product information, please visit EPREL: <https://eprel.ec.europa.eu>.
EPREL registration number is available on <https://eprel.panasonic.eu/product>.

Wireless LAN Transmitter Specifications

Frequency Ranges	Max Output Power
2400 - 2483,5 MHz (CH1 - CH13)	< 100 mW
5150 - 5250 MHz (CH36 - CH48)	< 200 mW
5250 - 5350 MHz (CH52 - CH64)	< 200 mW
5470 - 5725 MHz (CH100 - CH140)	< 200 mW

Country Restrictions

The Wireless LAN equipment is intended for home and office use in all EU countries, the UK and Northern Ireland (and other countries following the relevant EU and/or UK directive). The 5.15 - 5.35 GHz band is restricted to indoor operations only in the EU countries, in the UK and Northern Ireland (and other countries following the relevant EU and/or UK directive). Public use is subject to general authorisation by the respective service provider.

Country	Restriction
Russian Federation	Indoor use only

The requirements for any country may change at any time. It's recommended that user checks with local authorities for the current status of their national regulations for both 2.4 GHz and 5 GHz wireless LAN's.

Standard

IEEE 802.11.a/b/g/n

Host Interface

USB 2.0

Security

WEP 64/128, WPA, WPA2, TKIP, AES, WAPI

Notice

DVB / Data broadcasting / IPTV functions

- This TV is designed to meet the standards (as of March, 2021) of DVB-T / T2 (MPEG2, MPEG4-AVC(H.264) and HEVC(H.265)) digital terrestrial services, DVB-C (MPEG2, MPEG4-AVC(H.264) and HEVC(H.265)) digital cable services and DVB-S (MPEG2, MPEG4-AVC(H.264) and HEVC(H.265)) digital satellite services.

Consult your local dealer for availability of DVB-T / T2 or DVB-S services in your area.

Consult your cable service provider for availability of DVB-C services with this TV.

- This TV may not work correctly with the signal which does not meet the standards of DVB-T / T2, DVB-C or DVB-S.
 - Not all the features are available depending on the country, area, broadcaster, service provider, satellite and network environment.
 - Not all CI modules work properly with this TV. Consult your service provider about the available CI module.
 - This TV may not work correctly with CI module that is not approved by the service provider.
 - Additional fees may be charged depending on the service provider.
 - The compatibility with future services is not guaranteed.
 - Internet apps are provided by their respective service providers, and may be changed, interrupted, or discontinued at any time.
- Panasonic assumes no responsibility and makes no warranty for the availability or the continuity of the services.
- Panasonic does not guarantee operation and performance of peripheral devices made by other manufacturers; and we disclaim any liability or damage arising from operation and/or performance from usage of such other maker's peripheral devices.

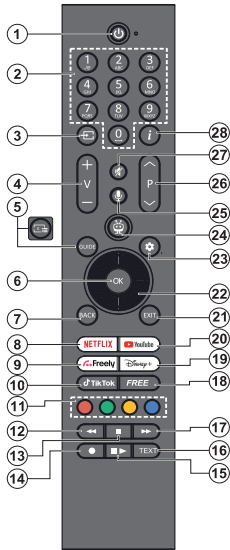

1. **Standby (*)**: Standby / On (press briefly)
Restart / Power Off (press and hold)
2. **Numeric buttons**: Switches the channel in Live TV mode, enters a number in the text box on the screen
3. **Source**: Shows available broadcast and content sources, is also used in pairing process of the remote
4. **Volume +/-**: Increases/decreases the volume level
5. **Guide**: Displays the electronic programme guide for digital TV channels. The current channel (if on the TV source) or the last channel watched (if on the Home screen) should be a digital channel
6. **OK**: Confirms user selections, enters sub-menus, holds the page (in Live TV-Teletext mode), views channel list (in Live TV mode)
7. **Back/Return**: Returns to previous menu screen, goes one step back, closes open windows, opens index page (in Live TV-Teletext mode). Quickly cycles between previous and current channels or sources
8. **Netflix**: Launches the Netflix application
9. **Freely**: Launches the Freely platform (UK only)
10. **TikTok**: Launches the Tiktok application
11. **Coloured Buttons**: Follow the on-screen instructions for coloured button functions
12. **Rewind**: Moves frames backwards in media such as movies
13. **Stop**: Stops the media being played
14. No function
15. **Pause**: Pauses the media being played
16. **Play**: Starts to play selected media
17. **Text**: Displays teletext (where available). Press the button a second time to superimpose the teletext

17. **Fast Forward**: Moves frames forward in media such as movies
18. **Free**: Displays free content from various applications on the Home screen
19. **Disney+**: Launches the Disney+ application
20. **YouTube**: Launches the YouTube application
21. **Exit**: Closes and exits from displayed menus, returns to previous screen, exits from any running application or OSD banner, closes the Home screen and switches to last source used
22. **Directional buttons**: Helps navigate menus, setting options, moves the focus or cursor, etc. and displays the subpages in Live TV-Teletext mode when pressed Right or Left. Follow the on-screen instructions
23. **Settings**: Opens the **Settings** menu
24. **TiVo**: Returns you to Home screen within TiVo OS from places like a movie you're watching or the Settings screen
25. **Voice**: Activates the microphone on the remote
Note: Voice search and voice control may not be available in some countries
26. **Programme +/-**: Increases/decreases channel number in Live TV mode
27. **Mute**: Completely turns off the volume of the TV
28. **Info**: Displays information about on-screen content, shows hidden information (reveal - in Live TV-Teletext mode)

(*) Standby Button

Press and hold the **Standby** button to see additional actions for this button. Highlight one of the **Restart**, **Standby** (Normal Standby), and **Power off** (Forced Standby) options and press **OK** to perform the selected action. If your TV stops responding to commands and the actions menu can not be displayed, the TV will be forced to restart when the button is kept pressed for about five seconds.

Press briefly and release the button to switch the TV into standby mode or to switch it on when it's in standby mode.



















To pair remote with the TV

In order to pair your remote, you can go to **Settings>>Devices>Pair Remote Control or Other Device (Bluetooth)** menu, set the **Pair Remote Control or Other Device (Bluetooth)** option to **Enabled**, then highlight **Discover** and press **OK** to start the device discovery. Press and hold the **Source** button on the remote until the LED on the remote starts to blink, then release the **Source** button. That means the remote is in pairing mode.

Now you will wait for the TV to find your remote. Select the name of your remote and press **OK** when it appears on the TV screen.

When the pairing process is successful, the LED on the remote will go off. If the pairing process fails the remote will enter sleep mode after 30 seconds.

Connections

Connector	Type	Cables	Device
	HDMI Connection		
SPDIF 	SPDIF (Optical Out) Connection		
HEADPHONE 	Headphone Connection		
	USB Connection		
	CI Connection		
LAN 	Ethernet Connection	 LAN / Ethernet Cable	

When using the wall mounting kit (available from a third party in the market, if not supplied), we recommend that you plug in all cables before mounting the TV on the wall. Insert or remove the CI module only when the TV is SWITCHED OFF. You should refer to the module instruction manual for details of the settings. The/ Each USB input of your TV supports devices up to 500mA. Connecting devices that have current value above 500mA may damage your TV. When connecting equipment using a HDMI cable to your TV, to guarantee sufficient immunity against parasitic frequency radiation and trouble-free transmission of high definition signals, such as 4K content, you have to use a high speed shielded (high grade) HDMI cable with ferrites.



If you want to connect a device to the TV, make sure that both the TV and the device are turned off before making any connection. After the connection is done, you can turn on the units and use them.

Switching On/Off

To Switch the TV On

Connect the power cord to a power source such as a wall socket (220-240V AC, 50 Hz).

To switch on the TV from standby

- Press the **Standby** button, **Programme +/-** or a numeric button on the remote control.
- Press the centre of the joystick on the TV in or push it up/down.

To switch on the TV from hard standby

- Press the centre of the joystick on the TV in.

To switch the TV into standby

Press the **Standby** button on the remote control, the TV will switch into standby mode.

To switch the TV into hard standby

Press the centre of the joystick on the TV in and hold it down for more than 3 seconds, the TV will switch into hard standby mode.

To switch off the TV

To power down the TV completely, unplug the power cord from the mains socket.

***Note:** When the TV is switched into standby mode, the standby LED can blink to indicate that features such as Standby Mode Search, Over Air Download or Timer is active. The LED can also blink when you switch on the TV from standby mode.*

First Time Installation

When turned on for the first time, the language selection screen is displayed. Select the desired language and press **OK**. In the following steps of the installation guide, set your preferences using the directional buttons and **OK** button.

After the language selection, you will be asked whether you want to change accessibility settings. Highlight **Yes** and press **OK** to change. Refer to the **System Menu Content** section for detailed information on available options.

Set your country preference on the next screen. Depending on the country selection you may be asked to set and confirm a PIN at this point. You have to enter it if you are asked to enter a PIN for any menu operation later.

You can activate **Store Mode** in the next step. This feature will configure your TV's settings for store environment and depending on the TV model, the supported features of it may be displayed on the screen as an info banner or the pre-installed video file may be played back. This feature is intended only for store use. It is recommended to select **Home Mode** for home use. The **Store Mode** option will be available in the

Settings>System>More menu and your preference for this setting can be changed later. Make your selection and press **OK** to continue.

Depending on the model of your TV, the picture mode selection screen may appear at this point. In order for your TV to consume less energy and be more environmentally friendly select **Natural** and press **OK** to continue. If you select **Dynamic** and press **OK**, a confirmation dialogue will be displayed. Select **Yes** and press **OK** to proceed. You can change your selection later using the **Mode** option in the **Settings>Picture** menu.

Depending on the model of your TV and the country selection **Summary of Consent Settings** screen may appear at this point. Using the options on this screen you can manage your consent settings. Highlight a feature and press **OK** to enable or disable. Read the related explanations displayed on the screen for each highlighted feature before making any changes. You can press the Right directional button to highlight the text and use the **Programme +/-** or Up/Down directional buttons to scroll up and down to read the entire text. You will be able to change your preferences at any time later from the **Settings>Legal>Consent Settings** menu. If the **Internet Connection** option is disabled the **Network/Internet Settings** step will be skipped and not displayed. If you have any questions, complaints or comments regarding the privacy policies or their enforcement, please contact by email at privacyrequest@xperi.com and smarttvsecurity@vosshub.com. Highlight **Submit Consent Choices** and press **OK** to continue.

On the next screen you need to agree to the terms and conditions of TiVo Smart TV Service to make use of the related services. Scroll the page to read the entire text using the **Programme +/-** or Up/Down directional buttons. Highlight **Accept** and press **OK** on the remote to confirm and proceed. Highlight **Cancel** and press **OK** to proceed without confirmation.

You will need to agree to the terms and conditions of the Manufacturer next to make use of the related services. Scroll the page to read the entire text using the **Programme +/-** or Up/Down directional buttons. Highlight **Accept** and press **OK** on the remote to confirm and proceed. Highlight **Cancel** and press **OK** to proceed without confirmation.

The **Network/Internet Settings** screen will be displayed next. Please refer to the **Connectivity** section if you need information on configuring a wired or a wireless connection (availability depends on the model) and other available options. If you want your TV to consume less power in standby mode, you can disable the **Networked Standby Mode** option for the selected network type by setting it as **Off**. After the settings are completed highlight **Next** and press **OK** button to continue. If the **Network Type** is set to

Wireless Device, available networks will be listed. Highlight **Next** again when you are done and press **OK** to continue.

Depending on the model of your TV and supplied remote controls, an automatic pairing screen may be displayed at this point. Follow the on-screen instructions to pair your wireless remote control (depends on the model of the remote control) with your TV. Refer to the **Remote Control** section for more information. If you want to pair your remote control at a later time, highlight **Setup Later** and press **OK**.

On the next screen the **Add Devices** menu will be displayed. You can connect external wireless audio devices, remotes, keyboards, and mice to your TV. For audio devices use the **Pair Audio Link Device (Bluetooth)** option, for wireless remotes, keyboards, and mice use the **Pair Remote Control or Other Device (Bluetooth)** option. Highlight the option you prefer, press **OK** and wait for the TV to complete device discovery. If you select **Pair Remote Control or Other Device (Bluetooth)** option, instructions to pair your remote will be displayed first. Highlight **Discover** and press **OK** when you are ready. Available devices will be listed. Highlight your device from the list and press **OK**. Highlight **Connect** from the options menu and press **OK** to complete the pairing process. You can use the **Discover** option on the bottom side to repeat device discovery. Highlight **Continue** and press **OK** to proceed. You can also use the related options in the **Settings>Devices** menu to add/remove devices later. Refer to the **Connectivity** section for more information on connecting wireless devices. To continue highlight **Next** and press **OK**.

On the next screen you need to agree to the manufacturer's terms and conditions for Freely to make use of the related services. Scroll the page to read the entire text using the **Programme +/-** or Up/Down directional buttons. Highlight **Yes** and press **OK** on the remote to confirm and proceed. Highlight **No** and press **OK** to proceed without confirmation. For further requirements for Freely services refer to the **Freely Platform** section.

On next screen you can set broadcast types to be searched, set your encrypted channel searching and time zone (depending on the country selection) preferences. Additionally you can set a broadcast type as your favourite one. Priority will be given to the selected broadcast type during the search process and the channels of it will be listed on the top of the channel list. When finished, highlight **Next** and press **OK** to continue.

About Selecting Broadcast Type

To turn a search option on for a broadcast type highlight it and press the **OK**, Left or Right directional button. To turn the search option off press the **OK**, Left or Right

directional button after moving the focus on the desired broadcast type option.

Digital Aerial: If the **D. Aerial** broadcast search option is turned on, the TV will search for digital terrestrial broadcasts after other initial settings are completed.

Digital Cable: If the **D. Cable** broadcast search option is turned on, the TV will search for digital cable broadcasts after other initial settings are completed. A dialogue may be displayed depending on the country selection before starting to search asking whether you want to perform cable network search. If you select **Yes** and press **OK** you can select **Network** or set values such as **Frequency**, **Network ID**, and **Search Step** on the next screen. If you select **No** and press **OK** or the network search dialogue is not displayed, you can set **Start Frequency**, **Stop Frequency**, and **Search Step** on the next screen. When finished, highlight **Next** and press **OK** to continue.

Note: Searching duration will change depending on the selected Search Step.

Satellite: If the **Satellite** broadcast search option is turned on, the TV will search for digital satellite broadcasts after other initial settings are completed. Before satellite search is performed some settings should be made.

Depending on the model and the selected country the next step may be the selection of the installation type for satellite. You can select to start an operator installation or a standard installation at this point. If you want to perform an operator installation, set the **Install Type** as **Operator** and then set the **Satellite Operator** according to your operator preference. Some of the following steps may differ or be skipped depending on the selected operator in this step. If you set the **Install Type** as **Standard**, you can continue with regular satellite installation and watch satellite channels. Press **OK** to proceed.

Antenna type selection screen may be displayed next. You can select **Antenna type** as **Direct**, **Single Satellite Cable** or **DiSEqC switch** by using the Left or Right directional buttons. After selecting your antenna type press **OK**. On the next screen press **OK** to see the options to proceed. **Continue**, **Transponder list** and **Configure LNB** options may be available. You can change the transponder and LNB settings using the related menu options.

- **Direct:** If you have a single receiver and a direct satellite dish, select this antenna type. Press **OK** to continue. Select an available satellite on the next screen and press **OK**, highlight **Continue** and press **OK** again to scan for services.
- **Single Satellite Cable:** If you have multiple receivers and a single satellite cable system, select this antenna type. Press **OK** to continue. Configure settings by following instructions on the next screen.

Press **OK**, highlight **Continue** and press **OK** again to scan for services.

- **DiSEqC switch:** If you have multiple satellite dishes and a DiSEqC switch, select this antenna type. Then set the DiSEqC version and press **OK** to continue. You can set up to four satellites (if available) for version v1.0 and sixteen satellites for version v1.1 on the next screen. Press **OK**, highlight **Continue** and press **OK** again to scan the selected satellite/s.

Note: Depending on the model of your TV, DiSEqC version v1.1 may not be supported and therefore the DiSEqC version selection step may not be available.

Analogue: If the **Analogue** broadcast search option is turned on, the TV will search for analogue broadcasts after other initial settings are completed.

Internet (IP) Services: If the **Internet (IP) Services** search option is turned on, the TV will search for available Internet services after other initial settings are completed.

After the initial settings are completed the TV will start to search for available broadcasts of the selected broadcast types.

While the search continues current scan results will be displayed at the bottom of the screen. You can press the **TiVo**, **Back** or **Exit** button to cancel the search. The channels that have already been found will be stored in the channel list.

Postcode Selection screen will be displayed next. Enter your postcode to receive your regional channels.

Freely TV-App installation screen will be displayed at this point. In order to access Freely services, this application needs to be installed. When you install the application, the elements of the user interface such as channel info banner and electronic programme guide, which are normally provided by the TV, will be replaced by this application. If you want to install the application at a later time, go to the navigation carousel on the Home screen and select **Freely** or press the **Freely** button on the remote control. You will have to agree to the terms and conditions for Freely services first if you did not agree them during the first time installation. Highlight **Yes** and press **OK** to confirm and proceed. Then a dialogue will be displayed asking whether you want to install Freely TV-App. Highlight **Yes** and press **OK** to continue with the installation. You will be directed to a screen where you can carry out the installation.

After the first time installation is completed, Home screen will be displayed. You can press the **Exit** button to watch TV channels. You can press the **OK** button to display the channel list when watching TV channels and customise the channel list according to your preferences using the **Edit** and **Filter** tab options.

While the search continues a dialogue may appear, asking whether you want to sort channels according to the LCN(*). Select **Yes** and press **OK** to confirm.

(* *LCN is the Logical Channel Number system that organises available broadcasts in accordance with a recognisable channel number sequence (if available).*

Note: Do not turn off the TV while performing first time installation. Note that, some options may not be available depending on the country selection.

Media Playback via USB Input

You can connect 2.5" and 3.5" inch (HDD with external power supply) external hard disk drives or USB memory stick to your TV by using the USB input(s) of the TV.

IMPORTANT! Back up the files on your storage devices before connecting them to the TV. Manufacturer will not be responsible for any file damage or data loss. Certain types of USB devices (e.g. MP3 Players) or USB hard disk drives/memory sticks may not be compatible with this TV. The TV supports FAT32 and NTFS disk formatting.

Wait a little while before each plugging and unplugging as the player may still be reading files. Failure to do so may cause physical damage to the USB player and the USB device itself. Do not pull out your drive while playing a file.

You can use USB hubs with your TV's USB input(s). External power supplied USB hubs are recommended in such a case.

It is recommended to use the TV's USB input(s) directly, if you are going to connect a USB hard disk.

Note: When viewing media files the **Media Browser** menu can only display a maximum of 1000 media files per folder.





Media Browser

You can play back music and movie files and display photo files stored on a USB storage device by connecting it to your TV. Connect a USB storage device to one of the USB inputs located on the side of the TV.

After connecting a USB storage device to your TV a message stating that the USB device is connected will be displayed on the screen. You can access the content of the connected USB device from the **Sources** menu on the Home screen. You can also press the **Source** button on the remote and then select your USB storage device from the list of sources.

You can set your media browser preferences by using the **Settings** menu. **Settings** menu can be accessed via the information bar which is displayed on the bottom of the screen while playing back a video or an audio file or displaying a picture file. Press the **Info** button if the information bar has disappeared, highlight the gear wheel symbol positioned on the right side of the information bar and press **OK**. **Picture Settings, Sound Settings, Media Browser Settings**

and **Options** menus may be available depending on the media file type and the model of your TV and its features. The content of these menus may also differ according to the type of the currently open media file. Only the **Sound Settings** menu will be available while playing back audio files.

Loop/Shuffle Mode Operation	
Start playback and activate 	All files in the list will be continuously played in original order
Start playback and activate 	The same file will be played continuously (repeat)
Start playback and activate 	All files in the list will be played once in random order
Start playback and activate  	All files in the list will be continuously played in the same random order

To use the functions on the information bar highlight the symbol of the function and press **OK**. To change the status of a function highlight the symbol of the function and press **OK** as much as needed. If the symbol is marked with a red cross, that means it is deactivated.

Custom Boot Up Logo

You can personalise your TV and see your favourite image or photo on the screen each time your TV boots up. To do this, copy your favourite image files onto a USB disk and open them in the Media Browser. Select USB input from the **Sources** menu on the Home screen and press **OK**. You can also press the **Source** button on the remote and then select your USB storage device from the list of sources. When you have chosen the desired image, highlight it and press **OK** to view it in full screen. Press the **Info** button, highlight the gear wheel symbol on the information bar and press **OK**. Select **Options** and press **OK** to enter. **Set Boot Logo** option will be available. Highlight it and press **OK** again to choose the image as custom boot logo. A confirmation message will be displayed. Select **Yes** and press **OK** again. If the image is suitable (*) you will see it on the screen during the TV's next boot up.

Note: You can use the **Restore Default Boot Logo** option in the **Settings>System>More** menu to restore the default boot logo. If you perform **First Time Installation** the boot logo will also be restored to its default.

(*) Images must have an aspect ratio between 4:3 to 16:9 and they must be in .jpeg or .jpg file formats. The image cannot be set as boot logo, if its resolution doesn't appear on the info banner.

FollowMe TV

With your mobile device you can stream the current broadcast from your smart TV using the **FollowMe TV** feature. Install the appropriate Smart Center application to your mobile device. Start the application.

For further information on using this feature refer to the instructions of the application you use.

Note: Depending on model, your TV may not support this function. The application may not be compatible with all mobile devices. Both of the devices must be connected to the same network. This feature is only functional on TV source.

CEC

This function allows the user to control the CEC-enabled devices, that are connected through HDMI ports by using the remote control of the TV.

The **CEC** option in the **Settings>Devices** menu should be set as **Enabled** at first. Press the **Source** button and select the HDMI input of the connected CEC device from the **Sources List** menu. When a new CEC source device is connected, it will be listed in **Sources List** menu with its own name instead of the connected HDMI port's name (such as DVD Player, Recorder 1, etc.).

The TV remote is automatically able to perform the main functions after the connected HDMI source has been selected. To terminate this operation and control the TV via the remote again, press and hold the "0-Zero" button on the remote control for 3 seconds.

You can disable the CEC functionality by setting the related option under the **Settings>Devices** menu accordingly.

The TV supports ARC (Audio Return Channel). This feature is an audio link meant to replace other cables between the TV and an audio system (A/V receiver or speaker system).

When ARC is active, the TV will mute its other audio outputs, except the headphone jack, automatically and volume control buttons are directed to the connected audio device. To activate ARC set the **Sound Output** option in the **Settings>Sound** menu as **HDMI ARC**.

Note: ARC is supported only via the HDMI2 input.

Enhanced Audio Return Channel (eARC)

Similar to ARC, the eARC feature enables the transfer of the digital audio stream from your TV to a connected audio device via the HDMI cable. eARC is an improved version of ARC. It has a much higher bandwidth than its predecessor. Bandwidth represents the range of frequencies or amount of data that is being transferred at a time. Higher bandwidth translates into a higher amount of data that can be transferred. Higher bandwidth also means that digital audio signal doesn't have to be compressed and is much more detailed, rich, and vibrant.

When eARC is enabled from the sound menu, TV first tries to establish eARC link. If eARC is supported by the connected device, the output turns into eARC mode and the "eARC" indicator can be observed on the connected device's OSD. If an eARC link cannot be established (for example, the connected device is not supporting eARC but supporting ARC only) or if eARC is disabled from the sound menu, then TV initiates ARC.

For eARC to function properly;

- The connected audio device should also support eARC.
- Some HDMI cables do not have enough bandwidth to carry high-bit-rate audio channels, use an HDMI cable with eARC support (HDMI High Speed Cables with Ethernet and the new Ultra High Speed HDMI Cable - check hdmi.org for latest info).
- Set the **Sound Output** option in the **Settings>Sound** menu to **HDMI ARC**. The **eARC** option in the **Sound** menu will be enabled. Check to see if it is set to **On**. If not, set it to **On**.

Note: eARC is supported only via the HDMI2 input.

System Audio Control

Allows an Audio Amplifier/Receiver to be used with the TV. The volume can be controlled using the remote control of the TV. To activate this feature set the **Sound Output** option in the **Settings>Sound** menu as **HDMI ARC**. When **HDMI ARC** option is selected, **CEC** option will be set as **Enabled** automatically, if it is not already set. The TV speakers will be muted and the sound of the watched source will be provided from the connected sound system.

Note: The audio device should support System Audio Control feature.

Game Mode

You can set your TV to achieve lowest latency for games. Go to **Settings>Picture** menu and set the **Mode** option to **Game**. **Game** option will be available when the TV's input source is set to HDMI. When set the picture will be optimised for low latency.

Auto Low Latency Mode

You can also enable the **ALLM** (Auto Low Latency Mode) option in the **Settings>Devices** menu. If this function is enabled the TV automatically switches the picture mode to **Game** when ALLM mode signal is received from the current HDMI source. TV switches back to previous picture mode setting when the ALLM signal is lost. So you won't need to change the settings manually.

If the **ALLM** option is enabled, picture mode can not be changed as long as ALLM signal is received from the current HDMI source.

In order for the ALLM feature to be functional the related HDMI source setting should be set to **Enhanced**. You can change this setting from the **Settings>System>Sources** menu.

E-Manual

You can find instructions for your TV's features in the E-Manual.

To access the E-Manual, enter the **Settings>System>More** menu, select **Manuals** and press **OK**. For quick access press the **Settings** button and then the **Info** button.

By using the directional buttons select a desired topic and press **OK** to read instructions. To close the E-Manual screen press the **Back/Return**, **Exit** or **TiVo** button.

Note: Depending on model, your TV may not support this function. The content of the E-Manual may vary according to the model.

Settings Menu Content

Devices Menu Content	
Pair Audio Link Device (Bluetooth)	Press OK to open the pairing screen. Using this screen you can discover and connect the Bluetooth wireless technology enabled sound devices to your TV. Refer to the Connecting Bluetooth Devices section for further information.
Pair Remote Control or Other Device (Bluetooth)	Press OK to open the pairing screen. Using this screen you can discover and the connect Bluetooth wireless technology enabled remotes, keyboards and mice to your TV. Refer to the Connecting Bluetooth Devices section for further information. <i>Note: Your TV may not be compatible with all keyboard and mouse models in the market. For more information contact your local dealer or retail outlet where you bought your TV.</i>
Virtual Remote	Enable or disable the virtual remote feature.
Audio Video Sharing	This feature allows you to share files stored on your smartphone or tablet pc. If you have a compatible smartphone or tablet pc and the appropriate software is installed, you can share/play photos, music and videos on your TV. See instructions of your sharing software for more information.
ALLM	ALLM (Auto Low Latency Mode) function allows the TV to activate or deactivate low latency settings depending on playback content. If this option is enabled the picture mode will be set to Game automatically when ALLM mode signal is received from the current HDMI source. Refer to the Game Mode section for more information.
Timer of No Signal	If your TV does not receive any input signal (e.g. from an aerial or HDMI source) for 3 minutes, it will go into standby mode. You can enable or disable this functionality by setting this option accordingly.
CEC	With this setting you can enable and disable CEC functionality completely. Press the Left or Right button to enable or disable the feature.
CEC Auto Power On	This function allows the connected HDMI-CEC compatible device to turn on the TV and switch to its input source automatically. Press the Left or Right button to enable or disable the feature.
Picture Menu Content	
Mode	You can change the picture mode to suit your preference or requirements. Picture mode can be set to one of these options: Cinema, Game, Sports, Dynamic and Natural . <i>Note: Available options may differ depending on the input source.</i> Dolby Vision Modes: If Dolby Vision content is detected Dolby Vision Dark and Dolby Vision Bright picture mode options will be available instead of Cinema and Natural modes.
Contrast	Adjusts the light and dark values on the screen.
Brightness	Adjusts the brightness values on the screen.
Sharpness	Sets the sharpness value for the objects displayed on the screen.
Colour	Sets the colour value, adjusting the colours.
Energy Saving	For setting the Energy Saving to Custom, Minimum, Medium, Maximum, Auto, Screen Off or Off . <i>Note: Available options may differ depending on the selected Mode.</i>
Backlight	This setting controls the backlight level. This option (will be located under the Energy Saving setting) will be available if the Energy Saving is set to Custom . Highlight and use the Left/Right directional buttons to set.
Picture Zoom	Sets the desired image size format.
Picture Shift	This option (will be located under the Picture Zoom setting) may be available depending on the Picture Zoom setting. Highlight and press OK , then use directional buttons to shift the picture upwards or downwards.

Pixelence Demo	<p>Pixelence function optimises the TV's video settings and helps to acquire a better image quality. Press OK to activate Pixelence demo mode to experience Pixelence quality. Press OK button again to cancel. If the Mode option is set to Game this option will not be available.</p> <p><i>Note: This option may not be available depending on the TV model and its features.</i></p>
Advanced Settings	
Dynamic Contrast	You can change the dynamic contrast ratio to desired value.
Colour Temp	Sets the desired colour temperature value. Cool, Normal, Warm and Custom options are available.
White Point	If the Colour Temp option is set as Custom , this setting will be available (will be located under the Colour Temp setting). Increase the 'warmth' or 'coolness' of the picture by pressing Left or Right buttons.
Vivid Blue	White colour enhancement function that makes white colour more cooler in order to make more bright picture. Set as On to enable.
Vivid Dimming	Low, Medium, High and Off options are available. While Vivid Dimming is active, it will enhance contrast locally for each defined zone.
Noise Reduction	Low, Medium, High and Off options are available. If the signal is weak and the picture is noisy, use the Noise Reduction setting to reduce the amount of noise.
MEMC	Press left/right buttons to set MEMC to Low, Medium, High or Off . While MEMC is active, it will optimise the TV's video settings for motional images to acquire a better quality and readability.
MEMC Demo	When MEMC option is set to Low, Medium or High , this option will be available. Press OK button to activate the demo mode. While demo mode is active, the screen will be divided into two sections, one displaying the MEMC activity, the other displaying the normal settings for TV screen. Press OK button again to cancel.
Film Mode	Films are recorded at a different number of frames per second to normal television programmes. Set to Auto when you are watching films to see the fast motion scenes clearly.
Skin Tone	Skin tone can be changed between -5 and 5.
Colour Shift	Adjust the desired colour tone.
Colour Tuner	Opens colour tuner settings. Set the Colour Tuner as Enabled to adjust the Hue, Colour and Brightness values manually.
Gamut Mapping	You can use this option to set the range of colours displayed on your TV screen. When set as On , colours are set according to the source signal. When set as Off , the TV's maximum colour capacity is used by default (recommended option). <i>Note: This option may not be available depending on the TV model and its features.</i>
Gamma	You can use this option to set your gamma preference. Press the Left/Right directional buttons to set to Normal, Bright or Dark . <i>Note: This option may not be available depending on the TV model and its features and you may not be able to change this setting depending on the current content.</i>
HDMI Full Range	While watching from a HDMI source, this feature will be visible. You can use this feature to enhance blackness in the picture.
11 Point White Balance Correction	White balance feature calibrates TV's colour temperature in detailed grey levels. By visually or measurement, grey scale uniformity can be improved. Adjust the strength of the Red, Green, Blue colours and Gain value manually. Highlight this option, press OK , and then set the desired white balance correction option (11 point or 2 point) to Enabled to turn it on.
Reset	Resets the current picture mode settings to factory default settings.

Sound Menu Content	
Dolby Atmos	Your TV supports Dolby Atmos technology. By means of this technology the sound moves around you in three-dimensional space, so you feel like you're inside the action. You will have best experience if input audio bitstream is Atmos. Auto , On and Off options will be available. If set as Auto , the TV will switch between On and Off modes automatically depending on the input audio bitstream information, if the input audio bitstream is Atmos this feature will work as if it is set as On . Set as Off to disable.
Mode	Smart , Movie , Music , News , and Off options will be available. Set as Off to disable. <i>Note: Some items in the Sound menu will be greyed out and unavailable if set to an option other than Off.</i>
Surround Sound	Enables or disables the surround sound mode.
Sound Output	Sets the sound output preference. TV , S/PDIF , HDMI ARC , Headphone Only and Lineout options will be available. There will be no sound output except through the selected option and the headphone jack. Note that, if this option is set as Headphone Only , TV speakers will be muted when headphone set is plugged in. When you connect an external amplifier to your TV using the headphone jack, you can select this option as Lineout . If you have connected headphones to the TV, set this option as Headphone Only . Please ensure before using headphones that this menu item is set to Headphone Only . If it is set to Lineout , the output from the headphone socket will be set to maximum which could damage your hearing. If the HDMI ARC option is selected, CEC feature will be enabled. <i>Note: Depending on the selected option some items in the Sound menu will appear as greyed out and will be unavailable.</i>
eARC	When the Sound Output option is set to HDMI ARC , the eARC menu option will be available. Otherwise, it will be greyed out. This option will be set to On by default. Set to Off to disable. Refer to the CEC section for more information.
AVL (Automatic Volume Limiting)	Sets the sound to obtain fixed output level between programmes. If the Mode menu item is set to an option other than Off the AVL setting options will change. Auto , Night , Normal and Off options will be available. In Auto mode the TV will switch to Normal or Night mode automatically according to the current time information. If no time information is available this option will always function as Normal . When the TV switches to Night mode for the first time after setting this option as Auto , an information bar will pop up on the screen. Please note that compared to Normal mode Night mode provides more aggressive dynamic compression control which is suitable for silent environments.
Advanced Settings	
Equalizer	Selects the equalizer mode. Custom settings can be made only when in User mode.
Dynamic Bass	Enables or disables the Dynamic Bass.
Sound Mode	You can select a sound mode if the channel you are watching supports it. This option will not be available if no channels are installed.
Digital Out	Sets digital out audio type. PCM , Auto , and Passthrough options will be available. PCM : This option provides two-channel uncompressed digital audio output. You can use this option if you experience compatibility problems such as not hearing sound. Auto : This option provides multi-channel digital audio output (up to 5.1 channel). Passthrough : This option provides original audio output as such in HDMI ARC. It is recommended to use this option if you have an A/V receiver with eARC support. If your A/V receiver does not support source audio format you may experience compatibility problems such as not hearing sound.
Headphone	Sets headphone volume. This option will not be available if the Sound Output option is set as Lineout . Please ensure before using headphones that the headphone volume is set to a low level, to prevent damage to your hearing.
Balance	Adjusts the balance level of the TV speakers and headphones together.
Reset	Resets some of the sound settings to factory defaults.

Network Menu Content	
Network Type	Disable the network connection or change the connection type.
Scan Wireless Networks	Start a search for wireless networks. This option will be available if the Network Type is set as Wireless Device .
Disconnect	To disconnect from a wireless network and delete your saved wireless network profile (if previously saved), highlight this option and press OK . This option will not be available if you did not connect to a wireless network. Refer to Connectivity section for more information.
Press WPS on your wifi router	If your modem/router device has WPS, you can directly connect to it using this option. Highlight this option and press OK . Go to your modem/router device and press the WPS button on it to make the connection. This option will be available if the Network Type is set as Wireless Device .
Internet Speed Test	Start a speed test to check your connection bandwidth. The result will be displayed on the screen when finished.
Advanced Settings	Change the IP and DNS configurations of your TV.
Networked Standby Mode	Enable or disable this feature by setting it as On or Off .
<i>Note: For detailed information on the options of this menu refer to the Connectivity section.</i>	

Installation Menu Content	
Automatic Channel Scan (Retune)	Displays automatic tuning options. D. Aerial: Searches and stores aerial DVB stations. D. Cable: Searches and stores cable DVB stations. Analogue: Searches and stores analogue stations. Satellite: Searches and stores satellite stations. Internet (IP) Services only: Searches and stores Internet (IP) services. This option will not be available if the Scan Internet (IP) Services option in the Internet (IP) Services Settings menu is set to Off .
Manual Channel Scan	This feature can be used for direct broadcast entry.
Network Channel Scan	Searches for the linked channels in the broadcast system. D. Aerial: Searches for aerial network channels. D. Cable: Searches for cable network channels. Satellite: Searches for satellite network channels.
Analogue Fine Tune	You can use this setting for fine tuning analogue channels. This feature is not available if no analogue channels are stored and if currently watched channel is not an analogue channel.
Satellite Settings	Displays satellite settings. Satellite list: Displays available satellites. You can Add , Delete satellites or Edit satellite settings on the list. Press OK to open the Options menu. Antenna installation: You can change satellite antenna settings and/or start a satellite scan. Press OK to open the Options menu.
Installation Settings (optional)	Displays installation settings menu. Standby Mode Search (*): Your TV will search for new or missing channels while in standby. Any new found broadcasts will be shown. Channel Management (*): If this option is set as Enabled , the changes on the broadcasts such as frequency, channel name, subtitle language, etc. will be applied automatically while watching. <i>(* Availability depends on model.</i>
Clear Service List	Use this setting to clear channels stored. This setting is visible only when the Country option is set to Denmark, Sweden, Norway or Finland.
Select Active Network	This setting allows you to select only the broadcasts within the selected network to be listed in the channel list. This feature is available only for the country option of Norway.
Signal Information	You can use this menu item to monitor signal related information such as signal level/quality, network name, etc. for available frequencies.
Internet (IP) Services Settings	Displays Internet (IP) services settings. Scan Internet (IP) Services: You can enable or disable the search for available Internet services by setting this option to On or Off .
Factory Reset	Deletes all stored channels and settings, resets TV to factory settings.

System Menu Content	
Accessibility	Displays accessibility options of the TV. Some options will not be available if no channels are installed.
High Contrast	Increase the contrast of the menu options and texts to make them easier to read. White Text, Yellow Text and Off options will be available.
Subtitle	Turns the subtitles on or off.
Hard Of Hearing	Enables any special feature sent from the broadcaster.
Audio Description	A narration track will be played for the blind or visually impaired audience. Press OK to see all available Audio Description menu options. This feature is available only if the broadcaster supports it. <i>Note: Audio description sound feature is not available in recording or time shifting mode (availability depends on the model of your TV and its features).</i>
Dialogue Enhancement	This feature provides sound postprocessing options for speech-gated dialogue enhancement. Off, Low, Medium and High options will be available. Set according your preference. <i>Note: This feature has an effect only if input audio format is AC-4 and this effect only applies to TV loudspeaker output.</i>
Spoken Subtitles	Default preference of spoken subtitles is selected with this setting option. To make spoken subtitles priority higher than normal ones, this option should be set to On . This option may not be available depending on the model of your TV.
Magnification	Enables the use of button combinations to magnify the screen. On and Off options will be available. Set as On to enable. Magnification support will be enabled or disabled with long-press of the numeric button 5 . First top-left quadrant of the screen will be zoomed. After the magnification support is enabled, long-press of the numeric buttons 2, 4, 6, 8 will move the zoomed area to up, left, right and down.
Minimap	Minimap is enabled and deactivated by default. It will be activated when Magnification feature is enabled. With this option, you can prevent magnification feature from displaying the minimap.
Highlight programmes with	
[S] Subtitle	If this option is enabled and if any electronic programme guide event has "Subtitle" access service, these events will be highlighted with another colour.
[SL] Sign Language	If this option is enabled and if any electronic programme guide event has "Sign Language" access service, these events will be highlighted with another colour.
[AD] Audio Description	If this option is enabled and if any electronic programme guide event has "Audio Description" access service, these events will be highlighted with another colour.
Language	You may set a different language depending on the broadcaster and the country.
Conditional Access	Controls conditional access modules when available.
Parental	Enter correct PIN to change parental settings. You can easily adjust Menu Lock, Maturity Lock, Child Lock or Guidance in this menu. You can also set a new PIN or change the Default CICAM PIN using the related options. <i>Note: Some menu options may not be available depending on the country you selected during the first time installation process. Default PIN could have been set to 0000 or 1234. If you have defined the PIN (is requested depending on the country selection) during the first time installation process, use the PIN that you have defined.</i>
Date/Time	Sets date and time.

Sources	Edit the names, enable or disable selected source options. There are also Regular and Enhanced options available for HDMI sources. These options are affecting the colour settings of the selected HDMI source. To be able to watch 4K or HDR/HLG images from an HDMI source, related source setting should be set as Enhanced if the connected device is compatible with HDMI 2.0 and subsequent versions. Set as Regular if the connected device is HDMI 1.4 compatible. Set accordingly or disable the related HDMI source by setting as Disabled .
Netflix	If this feature is supported by your TV, you can view your ESN(*) number and deactivate Netflix. <i>(*) ESN number is an unique ID number for Netflix, created especially to identify your TV.</i> Note: For 4K video streaming, a minimum 25Mb/s internet connection speed is required – For an example of the requirements for streaming 4K content you may find more information on the Netflix website (https://help.netflix.com/en/node/13444). When you start to stream video content via the internet the quality of your connection will be analysed and the full HD or 4K quality may take a short time to be realised, or in the event of a slow connection not be possible. You should check your internet capabilities with your internet provider if you are at all unsure.
TiVo	You can view the HSN and DLID information of your TV.
Freely TV-App	You can configure the Freely TV-App settings or uninstall the application. If you have not previously installed the Freely TV-App, only the Install option will be available. Highlight this option and press OK to start the installation.
More	Displays other setting options of the TV.
Menu Timeout	Changes timeout duration for menu screens.
Home Screen Saver	Set the screensaver options for Home screen. You can set a wait time for the screensaver or disable it by using the available options.
Standby Mode LED	If set as Off the standby mode LED will not light up when the TV is in standby mode.
Device Identification	When this option is enabled it causes a 'Device ID' to be generated internally for each Web origin visited. When disabled all the current 'Device ID's' are cleared for each Web origin that was visited. You can enable or disable this feature by setting it as On or Off .
Software Upgrade	Ensures that your TV has the latest software. Press OK to see the menu options.
Application Version	Displays current software version.
Subtitle Mode	This option is used to select which subtitle mode will be on the screen (DVB subtitle / Teletext subtitle) if both are available. Default value is DVB subtitle. This feature is available if channels are installed and the country option is set as Norway during the first time installation.
Auto Power Down	Sets the desired time for the TV to automatically go into standby mode when not being operated. This option can be set from 1 to 8 hours in steps of 1 hour. You can also disable this option by setting as Off .
Standby On Mode	Configures your TV's auto launch preference. The Home Screen and Last Source options are available.
Sleep Timer	Define a time after which you want your TV to enter sleep mode automatically. Set as Off to disable.
Biss Key	Biss is a satellite signal scrambling system that is used for some broadcasts. If you need to enter Biss key on a broadcast, you can use this setting. Highlight Biss Key and press OK to enter keys on the desired broadcast. This option will appear if satellite channels are installed. Availability depends on the model of your TV and its features.
Store Mode	Select this mode for store display purposes. Whilst Store Mode is enabled, some items in the TV menu may not be available. For some models Enabled with video option may also be available. If this option is set, the TV will switch to store mode and the pre-installed video file will be played back.

Power Up Mode	This setting configures the power up mode preference. Last State and Standby Mode options are available.
OSS	Displays Open Source Software licence information.
Restore Default Boot Logo	Restores the default boot logo. A confirmation message will be displayed. Select Yes and press OK . This option may not be available depending on the model of your TV and its features.
Change Friendly Name	Using this option you can change the device name that is used to identify your TV when connecting a device to the TV wirelessly. The default device name will be restored if the device name is left blank or first time installation is performed.
Application Priority	You can set your preference regarding the priority between the broadcast applications and CICAM App MMI applications using this option. In case a CICAM is inserted into the TV and a contention occurs between the applications the priority will be given to the selected type of application.
Dolby Notification	Sets the notification appearance preference for Dolby content. When set as On , Dolby logo will be displayed on the screen when Dolby content is detected.
Manuals	Displays the E-Manual. You can find instructions for your TV's features in the E-Manual.

Note: Some options may not be available depending on the model of your TV, its features and the selected during the first time installation process.

Legal Menu Content	
Privacy Policies	Displays the privacy policy information.
Terms & Conditions	Displays the terms and conditions for TiVo Smart TV Service and manufacturer.
Consent Settings	You can use the options here to manage your consent settings. Highlight a feature and press OK to enable or disable. You can read the related explanations displayed on the screen for each highlighted feature before making changes. You can press the Right directional button to highlight the text and then use the Programme +/- or Up/Down directional buttons to scroll up and down to read the entire text.
Advertising ID	Displays the advertising ID. You can also reset it using the related option here.
Company Information	Displays the company information.
Transparency Disclosure	Displays the transparency disclosure.
Cookies	
Show All Cookies	Displays all saved cookies.
Delete All Cookies	Deletes all saved cookies.
Do Not Track	You can set your preference regarding the tracking behaviour for HbbTV services using this option.
Samba TV Privacy Manager	Samba Interactive TV powers recommendations and other apps by gathering data regarding consumption of specific on-screen content to enhance your viewing experience. Using this option you can access Samba Interactive TV settings menu, review Samba TV's Terms of Service, Privacy and manage your advertising preferences, etc. Internet connection will be required in order to access HTML based settings. You can manage your preferences at any time from the Samba Interactive TV menu. This option may not be available depending on the selected country during the First Time Installation process, the model of your TV and its features.

General TV Operation

Using the Channel List

The TV sorts all stored stations in the channel list. You can edit this channel list or set favourites by using the **Channels** menu options. While watching live TV channels press the **OK** button to open the channel list or go to the Navigation carousel on the Home screen and select **Channel List**. You can filter the listed channels or make advanced changes in the current list using the **Filter** and **Edit** tab options. Highlight the tab you want and press **OK** to see available options.

Managing the Favourite Lists

You can create four different lists of your favourite channels. Go to the Navigation carousel on the Home screen and select **Channel List** to open the **Channels** menu. Highlight the **Edit** tab and press **OK** to see the editing options and select the **Tag/Untag channel** option. Select the desired channel on the list by pressing the **OK** button while the channel is highlighted. You can make multiple choices. You can also use the **Tag/Untag all** option to select all channels on the list. Then press the **Back/Return** or Right directional button to return to the Edit menu options. Select the **Add/Remove Favourites** option and press the **OK** button again. Favourite channel list options will be displayed. Set the desired list option to **On**. The selected channel/s will be added to the list. In order to remove a channel or channels from a favourite list follow the same steps and set the desired list option to **Off**.

You can use the filtering function in the **Channels** menu to filter the channels in the channel list permanently according to your preferences. For instance, using the options of the **Filter** tab, you can set one of your four favourite lists to be displayed every time the channel list is opened. The selected filtering options will be shown on the top of the **Channels** menu screen.

Configuring Parental Settings

The **Parental** menu options can be used to prohibit users from viewing of certain programmes, channels and the usage of menus. These settings are located in the **Settings>System>Parental** menu.

To display parental lock menu options, a PIN should be entered. After coding the correct PIN, parental setting options will be displayed.

Menu Lock: This setting enables or disables access to all menus or installation menus of the TV.

Maturity Lock: If this option is set, the TV gets the maturity information from the broadcast and if this maturity level is disabled, prohibits access to the broadcast.

Note: If the country option in the **First Time Installation** is set as **France, Italy or Austria**, **Maturity Lock's** value will be set to 18 as default.

Child Lock: If this option is set to **On**, the TV can only be controlled by the remote control. In this case the control buttons on the TV will not work.

Guidance: This setting enables or disables access to some of the MHEG applications. Disabled applications can be released by entering the right PIN.

Internet Lock: If this option is set to **ON**, the internet using applications will be disabled. Set to **OFF** to release these applications again.

Set PIN: Defines a new PIN number.

Default CICAM PIN: This option will appear as greyed out if no CI module is inserted into the CI slot of the TV. You can change the default PIN of the CI CAM using this option.

Note: Default PIN could have been set to **0000** or **1234**. If you have defined the PIN (is requested depending on the country selection) during the **First Time Installation** use the PIN that you have defined. In case the PIN is entered incorrectly five times in succession, PIN entry will be blocked and it will no longer be possible to make a new entry for 30 minutes. However, you can unblock the PIN entry or reset the retry count to zero by turning the TV off and on.

Some options may not be available depending on the model and/or on the country selection in the **First Time Installation**.

Electronic Programme Guide

Freely TV-App Not Installed

By means of electronic programme guide function of your TV, you can browse the event schedule of the currently installed digital channels on your channel list. It depends on the related broadcast whether this feature is supported or not.

To access the programme guide, press the **Guide** button on your remote. You can also use the **Guide** option on the Home screen. The current channel (if on the TV source) or the last channel watched (if on the Home screen) should be a digital channel. Otherwise, the guide cannot be displayed.

There are 2 different types of schedule layouts available, **Timeline Schedule** and **Now/Next**. To switch between these layouts highlight the tab with the name of the alternative layout on the upper side of the screen and press **OK**.

Use the directional buttons to navigate through the programme guide. Use the **Back/Return** button to use the tab options on the upper side of the screen.

Timeline Schedule

In this layout option, all events of the listed channels will be displayed by timeline. You can use the directional buttons to scroll through the list of the events. Highlight an event and press **OK** to display event options menu.

Press the **Back/Return** button to use available tab options. Highlight the **Filter** tab and press **OK** to see the filtering options. To change the layout highlight **Now/Next** and press **OK**. You can use the **Previous**

Day and **Next Day** options to display the events of the previous and next day.

Highlight the **Extras** tab and press **OK** to access below options.

Highlight Genre: Displays the **Highlight Genre** menu. Select an option and press **OK**. The events in the programme guide matching the selected genre will be highlighted.

Guide Search: Displays searching options. Using these options, you can search the programme guide database in accordance with the selected criteria. Matching results will be listed.

Now: Returns back to the current time on the timeline.

Zoom: Highlight and press **OK** to change the time interval on the timeline.

Now/Next Schedule

In this layout option, only the current and next events of the listed channels will be displayed. You can use the directional buttons to scroll through the list of the events.

Press the **Back/Return** button to use available tab options. Highlight the **Filter** tab and press **OK** to see the filtering options. To change the layout highlight **Timeline Schedule** and press **OK**.

Event Options

Use the directional buttons to highlight an event and press the **OK** button to display the **Options** menu. The following options are available.

Select Channel: Using this option, you can switch to the selected channel in order to watch it. The programme guide will be closed.

More Info: Display detailed information on the selected event. Use up and down directional buttons to scroll through the text.

Set Timer on Event / Delete Timer on Event: Select the **Set Timer on Event** option and press **OK**. You can set timers for future events. The event will be added to Timers list. To cancel an already set timer, highlight that event and press the **OK** button. Then select the **Delete Timer on Event** option. The timer will be cancelled.

Notes: *You cannot switch to any other channel while there is an active timer on the current channel.*

It is not possible to set timer for two or more individual events at the same time interval.

Freely TV-App Installed

By means of the electronic programme guide function of your TV, you can browse the event schedule of the currently installed channels on your channel list. It depends on the related broadcast whether this feature is supported or not.

To access the programme guide, press the **Guide** button on your remote. You can also use the **Guide** option on the Home screen. Or you can press the **Freely** button on your remote control to connect to

the Freely platform. Then highlight the **TV Guide** tab on the main screen and press **OK**.

Use the directional buttons to navigate through the programme guide.

Integrated Catch-Up Services

You can enjoy Freely catch-up TV services that work directly through the electronic programme guide. Whilst you are on a channel, use the directional buttons to scroll back in time. You will see content from last few days. Available catch-up content may vary by channel and will be indicated by a play icon. Highlight the content you want to play back and press the **OK** button.

Make sure that your TV is connected to your home network in order to use the catch-up services. For further information regarding this matter and other requirements for Freely services refer to the **Connectivity** and **Freely Platform** sections.

Teletext Services (where available)

Press the **Text** button to enter. Press again to activate mix mode, which allows you to see the teletext page and the TV broadcast at the same time. Press once more to exit. If available, sections in the teletext pages will become colour-coded and can be selected by pressing the coloured buttons. Follow the instructions displayed on the screen.

Digital Teletext

Press the **Text** button to view digital teletext information. Operate it with the coloured buttons, directional buttons and **OK** button. The operation method may differ depending on the content of the digital teletext. Follow the instructions displayed on the digital teletext screen. When the **Text** button is pressed again, the TV returns to television broadcast.

MHEG Teletext

With digital terrestrial broadcasting (DVB-T), in addition to pictures and sound, you can also view digital teletext. Digital teletext is sometimes broadcast at the same time with the normal broadcasting.

- Press the **Text** or **Red** button
- The digital teletext information appears
- Operate it with the coloured buttons, directional buttons and **OK** button

The operation method may differ depending on the contents of the digital teletext. Follow the instructions displayed on digital teletext screen. Press the **Text** button to return to television broadcast.

BBC Red Button+ (RB+)

While watching BBC channels, press the **Red** button or **Text** button to access **Red Button+** services provided by the BBC. On the opening page you can access BBC's main services such as BBC iPlayer, BBC News, BBC Sport and many others. There are also links to the home pages of the related applications available. Use the navigation buttons on the TV's remote control to move through the application. Press the **Exit** button to close and exit.

Software Upgrade

Your TV is capable of finding and updating the software automatically via the broadcast signal or via Internet.

Software upgrade search via user interface

Press the **Settings** button on the remote or select **Settings** on the Home screen. Highlight the **Software Upgrade** option in the **System>More** menu and press **OK**. Then highlight the **Scan for upgrade** option and press **OK** to check for a new software upgrade. You can select the satellite which is used for updating process and configure its parameters by using the **Edit Upgrade for Satellite** menu options.

If a new upgrade is found, it starts to download the upgrade. After the download is completed, a warning will be displayed, press **OK** to complete software upgrade process and restart TV.

3 AM search and upgrade mode

Your TV will search for new upgrades at 3:00 o'clock if the **Automatic scanning** option is set to **Enabled** and the TV is connected to an aerial signal or to the Internet. If a new software is found and downloaded successfully, it will be installed at the next power on.

***Note:** Do not unplug the power cord while led is blinking during the reboot process. If the TV fails to come on after the upgrade, unplug, wait for two minutes then plug it back in.*

All updates are automatically controlled. If a manual search is carried out and no software is found then this is the current version.

Troubleshooting & Tips

TV will not turn on

Make sure the power cord is plugged in securely to a wall outlet. Press the **Standby** button on the remote.

Poor picture

- Check if you have correctly tuned the TV.
- Low signal level can cause picture distortion. Please check antenna connections.
- Check if you have entered the correct channel frequency if you have performed manual tuning.

No picture

- TV is not receiving any signal. Make sure the correct source has been selected.
- Is the antenna connected properly?
- Is the antenna cable damaged?
- Are suitable plugs used to connect the antenna?
- If the content is received through an HDMI input, try changing the related HDMI source input setting to **Enhanced** or **Regular** from the **Sources** option in the **Settings>System** menu.
- If you are in doubt, consult your dealer.

No sound

- Check if the TV sound is muted. Press the **Mute** button or increase the volume to check.
- Sound is coming from only one speaker. Check the balance setting from the **Sound** menu.
- Check if the **Sound Output** option is set correctly from the **Sound** menu.
- If the content is received through an HDMI input, try changing the related HDMI source input setting to **Enhanced** or **Regular** from the **Sources** option in the **Settings>System** menu.

Remote control - no operation

- The batteries may be exhausted. Replace the batteries.
- The batteries maybe inserted incorrectly. Refer to the **Inserting the Batteries into the Remote** section.

No signal on an input source

- It is possible that no device is connected.
- Check the AV cables and connections from your device.
- Check the device is switched on.

HDMI Signal Compatibility

Source	Supported Signals	Available	
HDMI	480i	60Hz	O
	480p	60Hz	O
	576i, 576p	50Hz	O
	720p	50Hz,60Hz	O
	1080i	50Hz,60Hz	O
	1080p	24Hz, 25Hz, 30Hz, 50Hz, 60Hz	O
	3840x2160p	24Hz, 25Hz, 30Hz, 50Hz, 60Hz	O
	4096x2160p	24Hz, 25Hz, 30Hz, 50Hz, 60Hz	O

(X: Not Available, O: Available)

In some cases a signal on the TV may not be displayed properly. The problem may be an inconsistency with standards from the source equipment (DVD, Set-top box, etc.). If you do experience such a problem please contact your dealer and also the manufacturer of the source equipment.

Supported File Formats for USB Mode

Video File Formats

File Extension	Format	
	Video Codec	Audio
.mpeg/.mpeg/.dat/.vob	MPEG1/2, H.264, VC1	MPEG Layer 1/2/3, AC3
.ts/.trp/.m2ts	MPEG1/2, H.264, VC1, HEVC/H.265	MPEG Layer 1/2/3, AC3, E-AC3
.avi	MPEG1/2, MPEG4, H.264, MJPEG	MPEG Layer 1/2/3, AC3, AAC, WMA
.mp4/.m4a/.m4v/.mov/.qt/.3gp/.3g2/.3gpp	MPEG1/2, H.263, MPEG4, H.264, HEVC/H.265, AV1	MPEG Layer 1/2/3, AAC LC, AC3
.mkv	MPEG 1/2, MPEG4, H.264, HEVC/H.265, AV1	MPEG Layer 1/2/3, AAC, AC3
.flv	Sorenson Spark, MPEG4, H.264	MPEG Layer 3, ADPCM, AAC LC
.asf/.wmv	MPEG4, WMV3, VC1	WMA, AMR-NB
.webm	VP9, VP8, AV1	OPUS, Vorbis

Picture File Formats

File Extension	Format
.jpg/.jpeg	JPEG, PJPEG
.bmp	BMP
.png	PNG

Audio File Formats

File Extension	Format	
	Video Codec	Audio
.mp3		mp3
.aac		AAC
.wma		WMA
.wav		MPEG Layer 1/2/3, AAC, PCM
.m4a	M4A	AAC

Subtitle File Formats

External Subtitles	
Extension	Specification
.ssa	SubStation Alpha
.ass	Advanced SubStation Alpha
.srt	Subrippler
.sub	Micro DVD / SubViewer
.txt	Micro DVD / TMPlayer / MPL2
.smi	Sami

Internal Subtitles	
Extension	Specification
.mkv	VOBSub
.mkv	ASS / SSA / TEXT
.dat, .mpg, .mpeg, .vob	DVD Subtitle
.mp4	DVD Subtitle, TEXT

Supported DVI Resolutions

When connecting devices to your TV's connectors by using DVI converter cable (DVI to HDMI cable - not supplied), you can refer to the following resolution information.

	56Hz	60Hz	66Hz	70Hz	72Hz	75Hz
640x480		x				x
800x600	x	x				x
1024x768		x		x		x
1280x768		x				x
1280x960		x				
1360x768		x				
1366x768		x				
1280x1024		x		x		x
1400x1050		x				
1600x900		x				
1920x1080		x				

Connectivity

Wired Connectivity

To Connect to a Wired Network

- You must have a modem/router connected to an active broadband connection.
- Connect your TV to your modem/router via an Ethernet cable. There is a LAN port at the rear-left side of your TV.

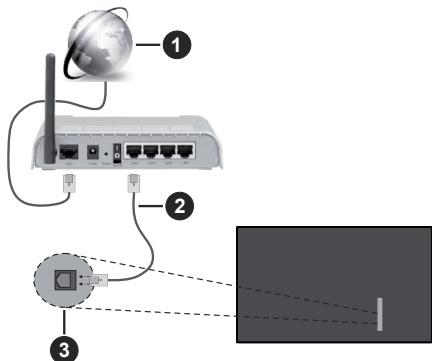

- 1 Broadband ISP connection
- 2 LAN (Ethernet) cable
- 3 LAN input on the rear-left side of the TV

- You might be able to connect your TV to your LAN depending on your network's configuration. In such a case, use an Ethernet cable to connect your TV directly to the network wall outlet.

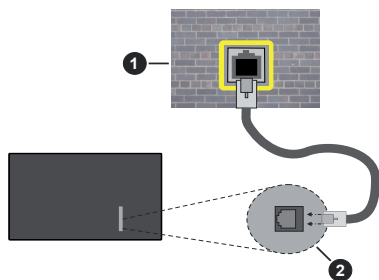

- 1 Network wall socket
- 2 LAN input on the rear-left side of the TV

Configuring Wired Device Settings

To configure wired connection settings go to the **Settings>Network** menu.

Network Type

Set **Network Type** as **Wired Device** if you are connecting via an Ethernet cable.

Internet Speed Test

Highlight **Internet Speed Test** and press the **OK** button. TV will check the internet connection bandwidth and display the result when complete.

Advanced Settings

Highlight **Advanced Settings** and press the **OK** button. On the next screen you can change the IP and DNS settings of the TV. Highlight the desired one and press **Left** or **Right** button to change the setting from **Automatic** to **Manual**. Now you can enter the IP and / or DNS values manually. Select the related item in the drop down menu and enter the new values using the numeric buttons of the remote. Highlight **Save** and press the **OK** button to save settings when complete.

Networked Standby Mode

You can enable or disable the Networked Standby Mode feature by setting this option accordingly. Refer to the **Networked Standby Mode** section for further information.

Other Information

The status of the connection will be displayed as **Connected** or **Not Connected** and the current IP address, if a connection is established. The MAC address of your TV will also be displayed on the screen.

Wireless Connectivity

To Connect to a Wireless Network

- You must have a wireless modem/router connected to an active broadband connection.

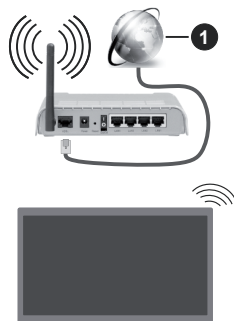

- 1 Broadband ISP connection

A Wireless-N router (IEEE 802.11a/b/g/n) with simultaneous 2.4 and 5 GHz bands is designed to increase bandwidth. These are optimised for smoother and faster HD video streaming, file transfers and wireless gaming.

The frequency and channel differ depending on the area.

The transmission speed differs depending on the distance and number of obstructions between the transmission products, the configuration of these products, the radio wave conditions, the line traffic and the products that you use. The transmission may also be cut off or may get disconnected depending on the radio wave conditions, DECT phones or any other WLAN 11b appliances. The standard values of the transmission speed are the theoretical maximum values for the wireless standards. They are not the actual speeds of data transmission.

The location where the transmission is most effective differs depending on the usage environment.

The TV supports 802.11 a, b, g & n type modems. It is highly recommended that you should use the IEEE 802.11n communication protocol in order to avoid any possible problems while watching videos.

You must change your modem's SSID when there are any other modems around with the same SSID. You can encounter connection problems otherwise. Use a wired connection if you experience problems with a wireless connection.

Configuring Wireless Device Settings

To configure wireless connection settings go to the **Settings>Network** menu.

Network Type

Set **Network Type** as **Wireless Device** to start connection process.

Scan Wireless Networks

Highlight the **Scan Wireless Networks** option and press **OK** to start a search for available wireless networks. All found networks will be listed. Highlight your desired network from the list and press **OK** to connect. A network with hidden SSID can not be detected by other devices. If you want to connect to a network with hidden SSID, scroll down the list of detected wireless networks, highlight the **Add New Network** option and press **OK**. Enter the name of the network and select the security type using the related options to connect.

Note: If the modem supports N mode, you should set N mode settings.

If the selected network is password-protected, enter the correct key by using the virtual keyboard. You can use this keyboard via the directional buttons and the **OK** button on the remote control.

Wait until the IP address is shown on the screen. This means that the connection is now established.

Disconnect

If you have connected to a wireless network the **Disconnect** option will appear in the **Network** menu and

your wireless network profile will also be saved, thus your TV will connect to the same network automatically whenever you switch to wireless connection. To disconnect from a wireless network and delete the saved wireless network profile, highlight **Disconnect** and press **OK**.

Press WPS on your wifi router

If your router has WPS, you can directly connect to the modem/router without entering a password or adding the network first. Highlight the **Press WPS on your wifi router** option and press **OK**. Go to your modem/router device and press the WPS button on it to make the connection. You will see a connection confirmation on your TV once the devices have paired. Select **OK** to proceed. No further configuration is required.

Internet Speed Test

Highlight **Internet Speed Test** and press the **OK** button to check your internet connection speed.

Advanced Settings

Highlight **Advanced Settings** and press the **OK** button to open the advanced setting menu. Use directional and numeric buttons to set. The procedure is the same as explained for wired connectivity. Highlight **Save** and press the **OK** button to save settings when complete.

Networked Standby Mode

You can enable or disable the Networked Standby Mode feature by setting this option accordingly. Refer to the **Networked Standby Mode** section for further information.

Other Information

The status of the connection will be displayed as **Connected** or **Not Connected** and the current IP address, if a connection is established. The MAC address of your TV will also be displayed on the screen.

Connecting to your mobile device via WLAN

- If your mobile device has WLAN feature, you can connect it to your TV via a router, in order to access the content in your device. For this, your mobile device must have an appropriate sharing software.

Connect your TV to your router by following the steps mentioned in the sections above.

Afterwards, connect your mobile device to the same network as your TV and then activate the sharing software on your mobile device. Then, select files that you want to share with your TV.

If the connection is established correctly, you will be able to access the shared files installed on your mobile device via the Audio Video Sharing feature of your TV.

Go to the Navigation carousel on the Home screen and select **Sources**. Then highlight the **Audio Video Sharing** option in the **Sources** menu and press **OK**, available media server devices in the network will be

displayed. Select your mobile device and press the **OK** button to continue.

- If available, you can download a virtual remote controller application from the server of your mobile device application provider.

Note: This feature may not be supported on all mobile devices.

Handling of the customer information

When using Internet connecting function of this TV, after agreeing to Panasonic's terms of service / privacy policy (hereinafter referred to as terms and conditions etc.), Customer Information on the use of this unit may be collected and used according to terms and conditions etc.

For details of terms of service / privacy policy, refer to **[TiVo] Settings>Legal**

Customer's personal information may be recorded on this TV by broadcasting organisation or application provider. Before repairing, transferring or discarding this TV, erase all the information recorded on this TV according to the following procedure.

[TiVo] Settings>Installation>Factory Reset

Customer information may be collected by provider via application provided by third parties on this TV or website. Please confirm the terms and conditions etc. of provide in advance.

- Panasonic will not be held responsible for collecting or using customer Information via application provided by third party on this TV or website.
- When entering your credit card number, name, etc., pay special attention to the trustworthiness of the provider.
- Registered information may be registered in the server etc. of provider. Before repairing, transferring or discarding this TV, be sure to erase the information according to the terms and conditions etc. of provider.

Networked Standby Mode

Networked Standby Mode is a standard that allows a device to be turned on or woken up by a network message. The message is sent to the device by a program executed on a remote device connected to the same local area network, such as a smartphone.

To enable this feature set the **Networked Standby Mode** option in the **Network** menu as **On**. It is necessary that both the device, from which the network message will be sent to the TV, and the TV are connected to the same network. Networked Standby Mode feature is only supported for Android OS devices and can only be used via YouTube and Netflix applications.

In order to use this feature the TV and the remote device should be connected at least once while the TV is on. If the TV is powered off, the connection

should be re-established, the next time it is switched on. Otherwise this feature will be unavailable. This does not apply, when the TV is switched into the standby mode.

If you want your TV to consume less power in standby mode, you can disable this feature by setting the **Networked Standby Mode** option as **Off**.

Wireless Display

Wireless Display is a standard for streaming video and sound content. This feature provides the ability to use your TV as wireless display device.

Using with mobile devices

There are different standards which enable sharing of screens including graphical, video and audio content between your mobile device and TV.

Press the **Source** button on the remote and switch to **Wireless Display** source.

A screen appears stating that the TV is ready for connection.

Open the sharing application on your mobile device. These applications are named differently for each brand, refer to the instruction manual of your mobile device for detailed information.

Scan for devices. After you select your TV and connect, the screen of your device will be displayed on your TV.

Note: This feature can be used only if the mobile device supports this feature. If you experience problems with the connection check if the operating system version you use supports this feature. There may be incompatibility problems with the operating system versions which are released after the production of this TV. Scanning and connecting processes differ according to the program you use.

Connecting Bluetooth Devices

Your TV supports Bluetooth wireless connection technology too. A pairing is required before using Bluetooth devices with the TV set. You should do the following to pair your device with the TV:

- Set the device to pairing mode
- Start device discovery on the TV

Note: Refer to the user manual of the Bluetooth device to learn how to set the device to pairing mode.

You can connect audio devices, remotes, keyboards, and mice to your TV using the Bluetooth wireless technology. Unplug or switch off any other connected audio device in order for wireless connection feature to work correctly. For audio devices you should use the **Pair Audio Link Device (Bluetooth)** option, for remotes, keyboards, and mice the **Pair Remote Control or Other Device (Bluetooth)** option in the **Settings>Devices** menu. Select the menu option and press the **OK** button to open the related menu. Using this menu you can discover and connect the devices that use the Bluetooth wireless technology and start to use them. Set the **Pair Audio Link Device (Bluetooth)**

or **Pair Remote Control or Other Device (Bluetooth)** option to **Enabled**, then highlight **Discover** on the bottom side of the menu screen and press **OK** to start the device discovery. Follow the on-screen instructions. Start the device discovery. A list of available Bluetooth devices will be displayed. Select the device you want to connect from the list and press the **OK** button to connect. If "**Device connected**" message is displayed, the connection is successfully established. If the connection fails try it again.

Note: Your TV may not be compatible with all remote, keyboard and mouse models in the market. For more information contact your local dealer or retail outlet where you bought your TV.

Image transfer and audio streaming

You can also use Bluetooth connection to transfer images or stream audio from your mobile device to your TV.

Pair the mobile device and the TV as described before. Start a device search in your hand-held device. Select your TV from listed devices. Confirm the request for connection on your TV screen and do the same on your hand held device screen. If no pairing is done, image transfer or audio streaming to the TV will not be possible.

The images sent by mobile device will be displayed on the TV without confirmation request, if the image file is suitable. You can also save the image file to a connected USB memory drive or set as boot logo, if this feature is supported and the file is suitable. Press the **Exit** button to terminate displaying the image.

The audio will be routed through the speakers of the TV, after confirmation is given. To start audio streaming unpair the device from your TV if it is paired with your TV previously. After pairing is completed, a confirmation message will be displayed asking whether you want to start audio streaming from your mobile device. Select **Yes** and press the **OK** button on the remote of the TV. If the connection is successful, all audio will be routed through the speakers of the TV. A symbol will appear on the upper side of the TV screen as long as the audio streaming connection is active. To terminate the audio streaming, you should turn off the Bluetooth connection of your mobile device.

Close all running applications and all the menus on the TV for a trouble-free transfer. Only image files with sizes smaller than 5 MB and in the following file formats are suitable; *.jpg, .jpeg, .png, .bmp*. If a file sent by the mobile device does not suit these requirements, it will not be displayed on the TV.

If the **Audio Video Sharing** option in the **Settings>> Devices** menu is disabled, the TV will ignore pairing requests and no information message will be displayed on the screen. If a device is already paired prior to disabling the **Audio Video Sharing** with the TV even if the **Audio Video Sharing** option is disabled.

Note: Wireless devices may operate within the same radio frequency range and may interfere with one another. To improve the performance of your wireless device place it at least 1 metre away from any other wireless devices.

Connectivity Troubleshooting

Wireless Network Not Available

- Ensure that any firewalls of your network allow the TV wireless connection.
- Try searching for wireless networks again, using the **Network** menu screen.

If the wireless network does not function properly, try using the wired network in your home. Refer to the **Wired Connectivity** section for more information on the process.

If the TV does not function using the wired connection, check the modem (router). If the router does not have a problem, check the internet connection of your modem.

Connection is Slow

See the instruction book of your wireless modem to get information on the internal service area, connection speed, signal quality and other settings. You need to have a high speed connection for your modem.

Disruption during playback or slow reactions

You could try the following in such a case:

Keep at least three metres distance from microwave ovens, mobile telephones, bluetooth devices or any other WLAN compatible devices. Try changing the active channel on the WLAN router.

Internet Connection Not Available / Audio Video Sharing Not Working

If the MAC address (a unique identifier number) of your PC or modem has been permanently registered, it is possible that your TV might not connect to the internet. In such a case, the MAC address is authenticated each time when you connect to the internet. This is a precaution against unauthorised access. Since your TV has its own MAC address, your internet service provider cannot validate the MAC address of your TV. For this reason, your TV cannot connect to the internet. Contact your internet service provider and request information on how to connect a different device, such as your TV, to the internet.

It is also possible that the connection may not be available due to a firewall problem. If you think this causes your problem, contact your internet service provider. A firewall might be the reason of a connectivity and discovery problem while using the TV in Audio Video Sharing mode or while browsing via Audio Video Sharing feature.

Invalid Domain

Ensure that you have already logged on to your PC with an authorised username/password and also ensure that your domain is active, prior to sharing any files in your media server program on your PC. If the domain

is invalid, this might cause problems while browsing files in Audio Video Sharing mode.

Using Audio Video Sharing Network Service

Audio Video Sharing feature uses a standard that eases the viewing process of digital electronics and makes them more convenient to use on a home network.

This standard allows you to view and play photos, music and videos stored on the media server connected to your home network.

1. Server Software Installation

The Audio Video Sharing feature cannot be used if the server program is not installed onto your PC or if the required media server software is not installed onto the companion device. Prepare your PC with a proper server program.

2. Connect to a Wired or Wireless Network

See the **Wired/Wireless Connectivity** sections for detailed configuration information.

3. Enable Audio Video Sharing

Enter the **Settings>Devices** menu and enable the **Audio Video Sharing** option.

4. Play Shared Files via Media Browser

Go to the Navigation carousel on the Home screen and select **Sources**. Then highlight the **Audio Video Sharing** option in the **Sources** menu by using the directional buttons and press **OK**. Available media server devices in the network will be listed. Select one and press **OK** to continue. The media browser will then be displayed.

Refer to the **Media Browser** section for further information on file playback.

If a problem occurs with the network, switch your television off at the wall socket and back on again.

PC/HDD/Media Player or any other devices that are compatible should be used with a wired connection for higher playback quality.

Use a LAN connection for quicker file sharing between other devices like computers.

Note: There may be some PC's which may not be able to utilize the Audio Video Sharing feature due to administrator and security settings (such as business PC's).

Apps

You can access the applications installed on your TV from the Home screen. The apps of the streaming services are integrated for the best search and viewing experience. Press the **TiVo** button on the remote, Home screen will be displayed. Highlight an app and press **OK** to launch.

Use the **Manage Apps** screen to control which apps TiVo OS uses to recommend titles from on the Home, Free, TV Shows, and Movies screens. The apps you select display in the **My Apps** carousel on the Home screen.

Your app selections do not affect search results. TiVo OS shows results from all apps to help you find what you want to watch. When an app you're not using has the title, you can then decide to sign up for it.

Notes: While many apps are free, a subscription, rental, or purchase may be needed to watch titles from some apps. Possible application dependent problems may be caused by the content service provider. Third party internet services may change, be discontinued or restricted at any time.

Freely Platform

Freely platform provides catch-up TV and On Demand services. Simply press the **Freely** button on your remote control to connect to the Freely platform.

The Freely platform can also be accessed from the navigation carousel. Go to the Home screen and scroll to the navigation carousel. Then highlight **Freely** and press the **OK** button.

You will have to agree to the terms and conditions for Freely services first if you did not agree them during the first time installation. Highlight **Yes** and press **OK** to confirm and proceed. Then a dialogue will be displayed asking whether you want to install Freely TV-App. Highlight **Yes** and press **OK** to continue with the installation. You will be directed to a screen where you can carry out the installation.

The Freely platform main screen will be displayed. Here you can access content such as live TV channels, TV apps, TV shows, and movies divided into categories. Select a content that you want to play back and press **OK** to watch.

Catch-up content can also be accessed and played back directly from the TV Guide. Highlight the **TV Guide** tab on the Freely platform main screen and press **OK** or press the **Guide** button on the remote control to open the TV Guide. Refer to the section **Electronic Programme Guide** for more information.

Requirements

The Freely services may only be used if the following requirements are fulfilled:

- Connecting the TV to the internet. A minimum broadband speed of 2Mbps is required for proper operation of catch-up and on demand services

- Agreeing to the terms and conditions of Freely
- Installing the Freely TV-App

Note: Freely platform usage will count towards any monthly broadband data allowance. Only selected channels provide 7-day catch-up.

Internet Browser

You can launch the internet browser from the **My Apps** carousel on the Home screen.

In the initial screen of the browser, the thumbnails of the predefined (if any) links to web sites available will be displayed as **Speed Dial** options along with the **Edit Speed Dial** and the **Add to Speed Dial** options.

To navigate the web browser, use the directional buttons on the remote or a connected mouse. To see the browser options bar, move the cursor to the top of the page. **History**, **Tabs** and **Bookmarks** options and the browser bar which contains previous/next buttons, the refresh button, the address/search bar, the **Speed Dial** and the **Vewd** buttons are available.

To add a desired website to the **Speed Dial** list for quick access, move the cursor to the top of the page. The browser bar will appear. Highlight the **Speed Dial** button and press the **OK** button. Then select **Add to Speed Dial** option and press the **OK** button. Fill in the blanks for **Name** and **Address**, highlight **OK** and press the **OK** button to add. Whilst you are on the site you wish to add to the **Speed Dial** list, highlight the **Vewd** button and press the **OK** button. Then highlight **Add to Speed Dial** option in the submenu and press the **OK** button again. **Name** and **Address** will be filled automatically according to the site you are visiting. Highlight **OK** and press the **OK** button to add.

You can also use the **Vewd** menu options to manage the browser. Highlight the **Vewd** button and press the **OK** button to see available page specific and general options.

There are various ways to search or visit websites using the web browser.

Enter the address of a website(URL) into the search/address bar and highlight the **Submit** button on the virtual keyboard and press the **OK** button to visit the site.

Enter keyword/s into the search/address bar and highlight the **Submit** button on the virtual keyboard and press the **OK** button to start a search for the related websites.

Highlight a Speed Dial thumbnail and press the **OK** button to visit the related website.

Your TV is compatible with USB mice. Plug your mouse or wireless mouse adaptor into the USB input of your TV for easier and quicker navigation.

Some web pages include flash content. These are not supported by the browser.

Your TV does not support any download processes from the internet via the browser.

All sites on the internet might not be supported. According to the site; content problems may occur. In some circumstances video content might not be able to be played.

HBBTV System

HbbTV (Hybrid Broadcast Broadband TV) is a new industry standard that seamlessly combines TV services delivered via broadcast with services delivered via broadband and also enables access to Internet only services for consumers using connected TVs and set-top boxes. Services delivered through HbbTV include traditional broadcast TV channels, catch-up services, video-on-demand, electronic programme guide, interactive advertising, personalisation, voting, games, social networking and other multimedia applications.

HbbTV applications are available on channels where they are signalled by the broadcaster. The broadcaster marks one application as "autostart" and this one is started by the platform automatically. The autostart applications are generally launched with a small red button icon to notify the user that there is an HbbTV application on that channel. Press the red button to open the application page. After the page is displayed you can go back to the initial red button icon state by pressing the red button again. You can toggle between the red button icon mode and full UI mode of the application via pressing red button. It should be noted that the red button switching capability is provided by the application and some applications may behave differently (other colour buttons such as green, yellow, blue, may be defined for some other functions, e.g. shortcuts).

If you switch to another channel while an HbbTV application is active (either in red button icon mode or full UI mode), the following scenarios can occur.

- The application can continue running.
- The application can be terminated.
- The application can be terminated and another autostart red button application can be launched.

HbbTV allows the applications to be retrieved both from broadband or broadcast. The broadcaster may enable both ways or one of them. If the platform does not have an operational broadband connection, the platform can still launch applications transmitted on broadcast.

The autostart red button applications generally provide links to other applications. The user then can switch to other applications by using the links provided. The applications should provide a way to terminate themselves, usually the **Exit** button is used for this.

HbbTV applications use keys on the remote control to interact with the user. When an HbbTV application is launched, the control of some keys are owned by the application. For example, numeric channel selection

may not work on a teletext application where the numbers indicate teletext pages.

HbbTV requires AV streaming capability for the platform. There are numerous applications providing VOD (video on demand) and catch-up TV services. The user can use play, pause, stop, forward, and rewind keys on the remote control to interact with the AV content.

If you need to change the audio description settings of your TV you should do it before a HbbTV playback starts. You will not be able to access related settings during a playback. Go to the **Settings>System>Accessibility>Audio Description** menu and adjust according to your need.

Note: You can enable or disable this feature from the **Settings>Legal>Consent Settings** menu.

DVB functionality information

This DVB receiver is only suitable for use in the country which it was designed to be used in.

Although this DVB receiver conforms to the latest DVB specifications at the time of manufacture, we cannot guarantee compatibility with future DVB transmissions due to changes that may be implemented in broadcast signals and technologies.

Some digital television functions may not be available in all countries.

We continually strive to improve our products; therefore, specifications may change without prior notice.

For advice on where to purchase accessories, please contact the store where you purchased your equipment.

Important Instruction

For your own safety read following instruction carefully before attempting to connect this unit to the mains supply.

MAINS (AC) OPERATION

The wires in the mains lead are coloured in accordance with the following code :

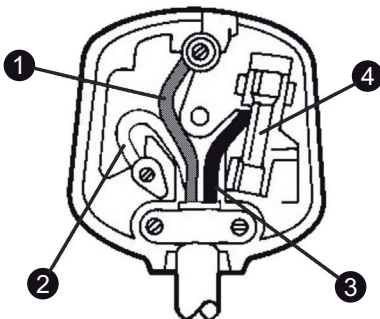

1. Green&Yellow (Earth) (if there is earth cable)
2. Blue (Neutral)
3. Brown (Live)
4. Fuse

IMPORTANT

As the colours of the wires in the mains lead of this appliance may not correspond with the coloured markings identifying the terminals in your plug, proceed as follows:

The wire which is coloured green and yellow must be connected to the terminal which is marked with the letter E, or by the earth symbol, or coloured green or green and yellow.

The wire which is coloured blue or black must be connected to the terminal which is marked with the letter N or coloured Black.

The wire which is coloured brown or red must be connected to the terminal which is marked with the letter L or coloured Red.

For continued protection against risk of fire, replace only with same type and rating of fuse (ASTA approved 5A 250VAC fuse).

CAUTION

TO PREVENT ELECTRIC SHOCK DISCONNECT FROM THE MAINS BEFORE REMOVING COVER. NO USER SERVICEABLE PARTS INSIDE. REFER SERVICING TO QUALIFIED SERVICE PERSONNEL.

SAFETY PRECAUTION

THIS EQUIPMENT MUST BE DISCONNECTED FROM THE MAINS WHEN NOT IN USE. DO NOT ALLOW THIS UNIT TO BE EXPOSED TO RAIN OR MOISTURE.