



ROLLER BEAST

**OUTDOOR WIRELESS
PORTABLE SPEAKER**

ENGLISH | FRANÇAIS | ESPAÑOL | DEUTSCH | ITALIANO | PORTUGUÊS
POLSKI | NEDERLANDS | ČEŠTINA | SLOVENČINA | ΕΛΛΗΝΙΚΑ | MAGYAR
SLOVENŠČINA | NORSK | SUOMI | SVENSKA | DANSK | LIETUVIŲ





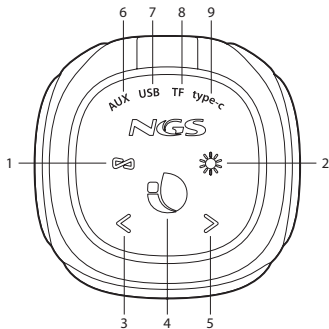

www.ngs.eu

CONTROL BUTTONS

- 1 Mode button / TWS**
Short press: TWS / Long press: Changing mode
- 2 Light button**
Short press to switch the light / Long press to turn on/off the light
Press twice to unpair the Bluetooth device
- 3 Volume - / Previous song**
Short press to move to the next track/radio station
Long press to increase volume
- 4 Play / Pause button**
Short press: play/pause / Long press to turn on/off
In FM mode: Press twice to search for the programme
- 5 Volume + / Next song**
Short press to move to the next track/radio station
Long press to increase volume
- 6 AUX interface**
- 7 USB interface**
- 8 TF card interface**
- 9 Type-C interface**
USB C charging port









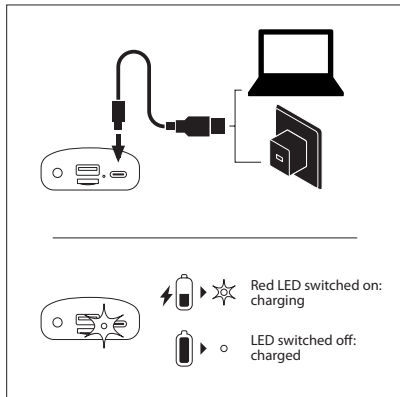









BLUETOOTH MODE









<p>1</p>  <p>Press and hold the button for 3 seconds to switch on the speaker</p>	<p>2</p>  <p>The LED will flash because the speaker is in search mode</p>
<p>3</p>  <p>Search for NGS Roller Beast in the Bluetooth options of the mobile device</p>	<p>4</p>  <p>Fixed LED: connected</p>

HOW TO CHARGE?







TWS





<p>1</p> 	 <p>2</p> 
<p>1</p>   <p>3s</p> <p>Press and hold for 3 seconds to switch on the speakers</p>	<p>1</p>   <p>3s</p> <p>Press and hold for 3 seconds to switch on the speakers</p>
<p>2</p>   <p>x2</p>    <p>0.5s</p> <p>Press the * button twice on both speakers to unpair them and place them in search mode</p>	<p>2</p>   <p>x2</p>    <p>0.5s</p> <p>Press the * button twice on both speakers to unpair them and place them in search mode</p>



<p>3</p>  <p>x1</p> <p>Press the TWS button to pair them</p>	<p>3</p>  <p>x1</p> <p>Press the TWS button to pair them</p>
<p>4</p>  <p>"Beep"</p> <p>You will hear a beeping sound on both speakers</p>	<p>4</p>  <p>"Beep"</p> <p>You will hear a beeping sound on both speakers</p>
<p>5</p>   <p>The LED on the first speaker will remain fixed and the other will flash</p>	<p>5</p>    <p>The LED on the first speaker will remain fixed and the other will flash</p>

RADIO MODE

<p>6</p>  <p>Search the Bluetooth options on the mobile device for "NGS Roller Beast"</p>	
--	---

<p>1</p>  <p>3s</p>	<p>2</p>  <p>2s</p>	<p>3</p>  <p>channel search x2</p>
--	---	---

<p>1</p> 	 <p>2</p> 
 <p>x1</p> <p>Press the TWS button again to exit TWS mode</p>	

<p>4</p> <p>channel -</p> 	<p>channel +</p>  <p>Note: Connect the USB C cable for a better radio signal</p>
---	---

USB/TF MODE

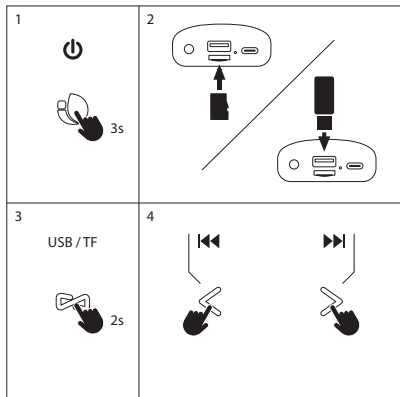

AUX IN MODE

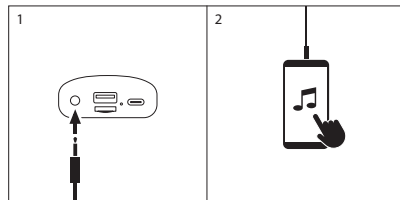

TECHNICAL SPECIFICATIONS

Compatible with bluetooth 5.0 TWS (get double power connecting 2 speakers at the same time without cables)	Yes
Output power	32W
RMS power	16W
AUX audio input	Yes
USB audio input	Yes
TF audio input	Yes
Volume control	Yes
Battery	Ion-Li 6000mAh
Battery life	7 hours*
Waterproof	IPX5

* with lights

11 hours at 50% volume

7 hours at 70% volume

4 hours at 100% volume

without lights

30 hours at 50% volume

20 hours at 70% volume

7 hours at 100% volume

Battery warranty

The battery is a consumer product, and as such it is under warranty for 12 months.



If at any time in the future you should need to dispose of this product please note that: Waste electrical products should not be disposed of with household waste. Please recycle where facilities exist.

Check with your Local Authority or retailer for recycling advice.

(Waste Electrical and Electronic Equipment Directive)

BOUTONS DE COMMANDE

1 Bouton de mode / TWS

Courte pression : TWS / Longue pression : Changement de mode

2 Bouton de lumière

Une pression pour changer la lumière / Longue pression pour allumer/éteindre la lumière

Appuyez deux fois pour désappairier le dispositif Bluetooth

3 Volume - / Chanson précédente

Appuyez et relâchez pour aller à la piste/station de radio précédente

Appuyez et maintenez pour baisser le volume

4 Bouton Lecture/Pause

Courte pression : lecture/pause / Longue pression pour allumer/éteindre

En mode FM : Double pression pour rechercher un programme

5 Volume + / Chanson suivante

Appuyez et relâchez pour aller à la piste/station de radio suivante

Appuyez et maintenez pour augmenter le volume

6 Interface AUX

7 Interface USB



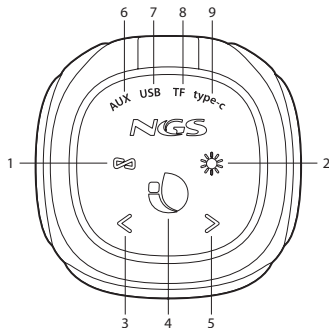

8 Interface carte SD

9 Interface type-C

Port de charge USB type-C









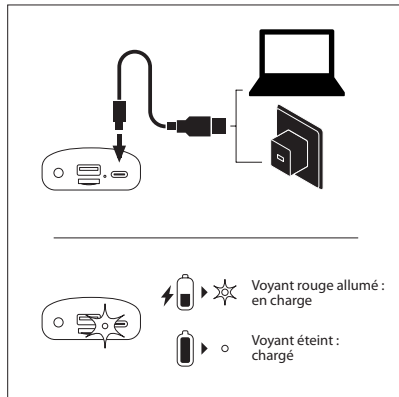







MODE BLUETOOTH









<p>1</p>  <p>Appuyez pendant 3 secondes sur le bouton pour allumer l'enceinte</p>	<p>2</p>  <p>Le voyant va clignoter pour indiquer que l'enceinte est en mode recherche</p>
<p>3</p>  <p>Cherchez NGS Roller Beast dans les options Bluetooth de l'appareil mobile</p>	<p>4</p>  <p>Voyant fixe : connecté</p>

COMMENT CHARGER ?







TWS



1 	 2 
1   3s Appuyez pendant 3 secondes pour allumer les enceintes	  3s Appuyez pendant 3 secondes pour allumer les enceintes
2   x2   0.5s Appuyez sur le bouton * deux fois sur les deux enceintes pour les désappairer et les mettre en mode recherche	  x2   0.5s Appuyez sur le bouton * deux fois sur les deux enceintes pour les désappairer et les mettre en mode recherche



3  x1 Appuyez sur le bouton TWS pour les appairer	 x1 Appuyez sur le bouton TWS pour les appairer
4  "Beep" Vous entendrez un bip sur les deux enceintes	 "Beep" Vous entendrez un bip sur les deux enceintes
5   Le voyant sur la première enceinte va rester fixe et l'autre va clignoter	   Le voyant sur la première enceinte va rester fixe et l'autre va clignoter

MODE RADIO

<p>6</p>  <p>Recherchez dans les options Bluetooth sur l'appareil mobile « NGS Roller Beast »</p>	
--	---

<p>1</p>  <p>3s</p>	<p>2</p>  <p>2s</p>	<p>3</p>  <p>recherche de station x2</p>
--	---	---

<p>1</p> 		<p>2</p>  <p>x1</p> <p>Appuyez sur le bouton TWS encore une fois pour sortir du mode TWS</p>
--	---	---

<p>4</p> <p>station -</p> 	<p>station +</p>  <p>Remarque : Connecter le câble USB C pour un meilleur signal radio</p>
---	---

MODE USB/TF

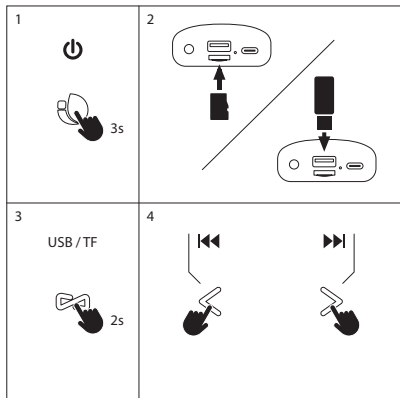

MODE AUX IN

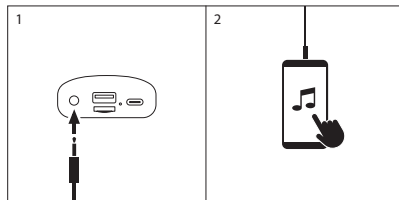

SPÉCIFICITÉS TECHNIQUES

Compatible Bluetooth 5.0	Oui
TWS (double alimentation en connectant 2 enceintes sans fil en même temps)	Oui
Puissance de sortie	32W
Puissance RMS	16W
Entrée audio AUX	Oui
Entrée audio USB	Oui
Entrée audio SD	Oui
Contrôle du volume	Oui
Batterie	Ion-Li 6000mAh
Durée de fonctionnement	7 heures*
Étanche	IPX5

- * avec les voyants
- 11 heures à 50 % du volume
 - 7 heures à 70 % du volume
 - 4 heures à 100 % du volume
- sans voyants
- 30 heures à 50 % du volume
 - 20 heures à 70 % du volume
 - 7 heures à 100 % du volume

Garantie de la batterie

La batterie est un consommable, et en tant que telle sa garantie est de 12 mois.



Si dans l'avenir vous deviez vous débarrasser de ce produit veuillez remarquer que :
Les déchets électriques ne doivent pas être jetés avec les déchets ménagers. Veuillez recycler les produits dans une déchetterie.



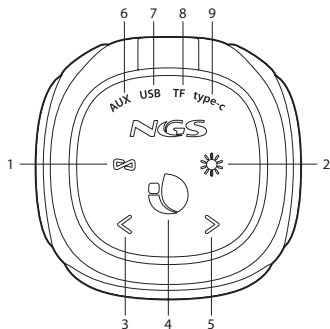

■ Consulter votre responsable local ou votre revendeur pour un conseil sur le recyclage.
(Directive sur les déchets des équipements électriques et électroniques)

BOTONES DE CONTROL

- 1 Botón para cambiar de modo / TWS**
Pulsación corta: TWS / Pulsación larga: Cambiar de modo
- 2 Botón de luz**
Pulsación corta para cambiar la luz / Pulsación larga para encender/apagar la luz
Doble pulsación para desemparejar el dispositivo bluetooth
- 3 Volumen - / Canción anterior**
Pulsación corta para ir a la pista / canal de radio anterior
Pulsación larga para bajar volumen
- 4 Botón reproducir/pausa**
Pulsación corta: reproducir/pausa / Pulsación larga para encender/apagar
En el modo FM: doble pulsación para buscar el programa
- 5 Volumen + / Canción siguiente**
Pulsación corta para ir a la pista / canal de radio siguiente
Pulsación larga para subir volumen
- 6 Interfaz AUX**
- 7 Interfaz USB**
- 8 Interfaz de la tarjeta TF**
- 9 Interfaz tipo C**
Puerto de carga tipo USB C









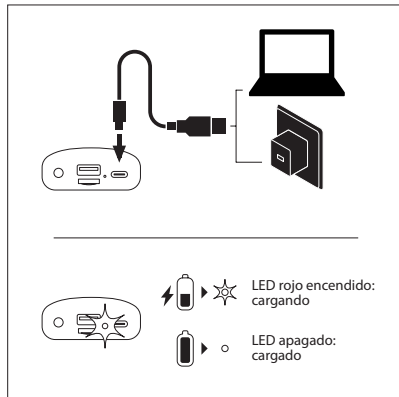







MODO BLUETOOTH









<p>1</p>  <p>Pulsar 3 segundos el botón para encender el altavoz</p>	<p>2</p>  <p>El LED parpadea porque el altavoz está en modo búsqueda</p>
<p>3</p>  <p>Buscar en las opciones bluetooth del dispositivo móvil NGS Roller Beast</p>	<p>4</p>  <p>LED fijo: conectado</p>

¿CÓMO CARGAR?



TWS

1			2	
1	  3s		  3s	
Pulsar 3 segundos para encender los altavoces				
2	  x2		  x2	
 		 		
0.5s		0.5s		
Doble click en el botón * en ambos altavoces para desemparejarlos y ponerlos en modo búsqueda				

3	 x1		 x1
Pulsar el botón TWS para emparejarlos			
4			
"Beep"			"Beep"
Oirá el sonido "beep" en ambos altavoces			
5			 
			
El LED del primer altavoz se queda fijo y el otro parpadea			

MODO RADIO

6

Busque en las opciones bluetooth del dispositivo móvil "NGS Roller Beast"

1

3s

2

2s

3

búsqueda de canal
x2

1

x1

2

Vuelva a pulsar el botón TWS para salir del modo TWS

4

canal -

canal +

Nota: Conecte el cable USB C para una mejor recepción de la señal de radio

MODO USB/TF

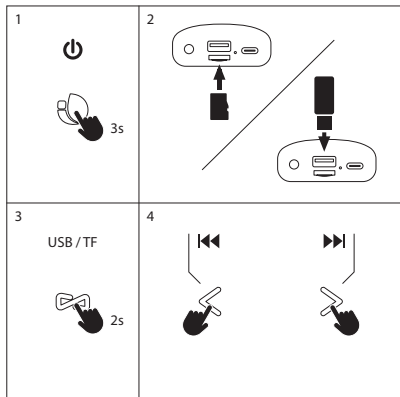

MODO AUX IN

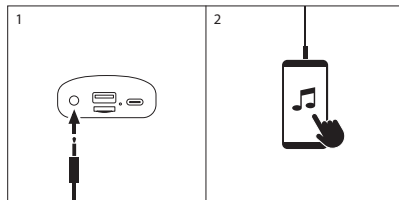

ESPECIFICACIONES TÉCNICAS

Compatible con bluetooth TWS (consigue doble potencia conectando 2 altavoces al mismo tiempo sin cables)	Sí
Potencia pico de salida	32W
Potencia RMS	16W
Entrada de audio AUX	Sí
Entrada de audio USB	Sí
Entrada de audio TF	Sí
Control de volumen	Sí
Batería	Ion-Li 6000mAh
Tiempo de funcionamiento	7 horas*
Resistente al agua	IPX5

* con luces

11 horas al 50% del volumen

7 horas al 70% del volumen

4 horas al 100% del volumen

sin luces

30 horas al 50% del volumen

20 horas al 70% del volumen

7 horas al 100% del volumen

Garantía de la batería

La batería es un consumible, y como tal, la garantía de la misma es de 12 meses.



Si en el futuro tiene que desechar este producto, tenga en cuenta que:

Los residuos de productos eléctricos no se tienen que tirar con la basura doméstica. Recíclelo en las instalaciones disponibles.

Consulte a las Autoridades Locales o al distribuidor para que le de instrucciones sobre el reciclaje.



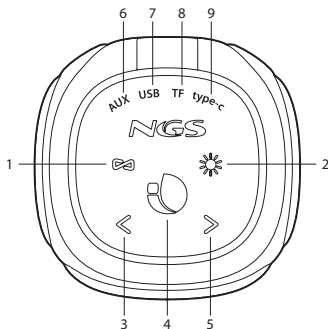

(Directiva sobre la eliminación de Aparatos Electrónicos y Eléctricos)

STEUERTASTEN

- 1 Modus-Taste / TWS**
Kurzes Drücken: TWS / Langes Drücken: Ändern des Modus
- 2 Licht-Taste**
Drücken, um das Licht einzuschalten / Längeres Drücken, um das Licht ein-/ auszuschalten
Zweimal drücken, um die Koppelung mit dem Bluetooth-Gerät zu löschen
- 3 Lautstärke - / Vorheriges Lied**
Drücken und loslassen, um zum vorherigen Titel/Radiosender zu springen
Drücken und halten, um die Lautstärke zu verringern
- 4 Wiedergabe-/Pause-Taste**
Kurzes Drücken: Wiedergabe/Pause / Langes Drücken zum ein/aus
Im FM-Modus: Zweimal drücken, um nach dem Programm zu suchen
- 5 Lautstärke + / Nächster Lied**
Drücken und loslassen, um zum nächsten Titel/Radiosender zu springen
Drücken und halten, um die Lautstärke zu erhöhen
- 6 AUX-Schnittstelle**
- 7 USB-Schnittstelle**
- 8 TF-Kartenschnittstelle**
- 9 Typ-C-Schnittstelle**
USB-Ladeanschluss Typ-C









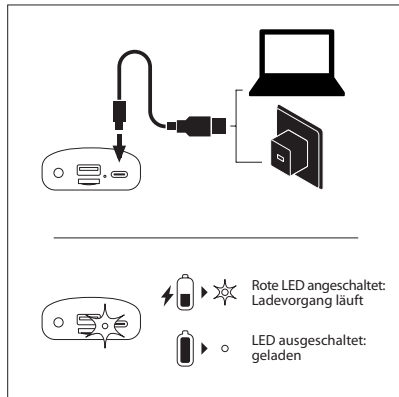





BLUETOOTH-MODUS

<p>1</p>  <p>Die Taste 3 Sekunden lang drücken und halten, um den Lautsprecher anzuschalten</p>	<p>2</p>  <p>Die LED-Lampe blinkt, weil sich der Lautsprecher im Suchmodus befindet</p>
<p>3</p>  <p>In den Bluetooth-Optionen des Mobilgeräts nach „NGS Roller Beast“ suchen</p>	<p>4</p>  <p>Leuchtende LED: gekoppelt</p>

WIE WIRD ES GELADEN?





TWS

1	2
  3s Die Taste 3 Sekunden lang drücken und halten, um die Lautsprecher anzuschalten	  3s Die Taste 3 Sekunden lang drücken und halten, um die Lautsprecher anzuschalten
2   x2   0.5s An beiden Lautsprechern die ✨-Taste zweimal drücken, um die Koppelung zu löschen und sie in den Suchmodus zu versetzen	  x2   0.5s An beiden Lautsprechern die ✨-Taste zweimal drücken, um die Koppelung zu löschen und sie in den Suchmodus zu versetzen



3	3
4	4
5	5





 x1
 Die TWS-Taste drücken, um sie zu koppeln





 "Beep"
 Beide Lautsprecher geben einen Piepton ab





 Die LED-Lampe am ersten Lautsprecher leuchtet durchgängig und die andere LED-Lampe blinkt

RADIO-MODUS

<p>6</p>  <p>Auf dem Mobilgerät die Bluetooth-Optionen durchsuchen nach „NGS Roller Beast“</p>	 
---	--

<p>1</p>   3s	<p>2</p>  2s	<p>3</p>  Kanalsuche  x2
--	--	--

<p>1</p> 		<p>2</p> 
 x1 Die TWS-Taste erneut drücken, um den TWS-Modus zu verlassen		

<p>4</p>  Kanal -	 Kanal + Hinweis: Schließen Sie das USB C-kabel für ein besseres Radiosignal an.
--	--

USB/TF-MODUS

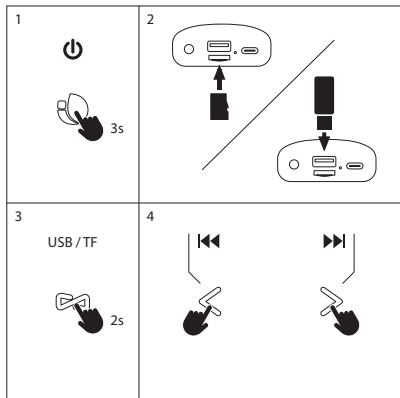

AUX IN-MODUS

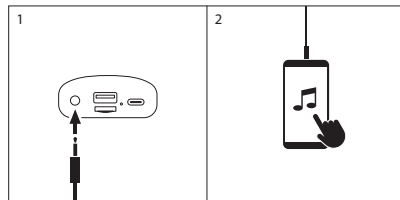

TECNISCHE SPEZIFIKATIONEN

Kompatibel mit Bluetooth 5.0	Ja
TWS (doppelte Leistung durch gleichzeitigen Anschluss von 2 Lautsprechern ohne Kabel)	Ja
Ausgangsleistung	32W
RMS	16W
AUX-Audioeingang	Ja
USB-Audioeingang	Ja
TF-Audioeingang	Ja
Lautstärkeregler	Ja
Batterie	Ion-Li 6000mAh
Betriebszeit	7 Stunden*
Wasserdicht	IPX5

- * mit Lichtern
 11 Stunden bei 50% der Lautstärke
 7 Stunden bei 70% der Lautstärke
 4 Stunden bei 100% der Lautstärke
 ohne Lichter
 30 Stunden bei 50% der Lautstärke
 20 Stunden bei 70% der Lautstärke
 7 Stunden bei 100% der Lautstärke

Garantie für den Akku

Der Akku ist ein Verbrauchsteil, und als solches hat er eine Garantie für 12 Monate.



Sollten Sie dieses Produkt später einmal entsorgen müssen, beachten Sie bitte, dass elektrische Abfallprodukte nicht mit dem Haushaltsmüll entsorgt werden dürfen. Bitte führen Sie das Produkt dem Recycling zu, sofern eine entsprechende Einrichtung (Wertstoffhof) vorhanden ist.

Fragen Sie bei Ihren Behörden vor Ort nach Möglichkeiten zum Recycling.



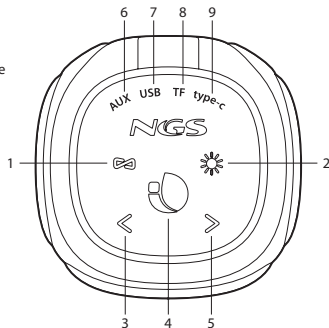

(Richtlinie über Elektro- und Elektronik-Altgeräte).

TASTI DI CONTROLLO

- 1 Pulsante modalità / TWS**
Premere brevemente: TWS / premere a lungo: Cambio di modalità
- 2 Pulsante luce**
Premere per accendere la luce / premere a lungo per accendere/spengere la luce
Premere due volte per annullare l'abbinamento con il dispositivo Bluetooth
- 3 Volume - / Traccia precedente**
Premere e rilasciare per passare alla traccia/stazione radio precedente
Tenere premuto per diminuire il volume
- 4 Pulsante play/pausa**
Premere brevemente: play/pausa / premere a lungo per accendere/spengere
In modalità FM: Premere due volte per cercare il programma
- 5 Volume + / Traccia successiva**
Premere e rilasciare per passare alla traccia/stazione radio successiva
Tenere premuto per aumentare il volume
- 6 Interfaccia AUX**
- 7 Interfaccia USB**
- 8 Interfaccia TF card**
- 9 Interfaccia Type-C**
Porta di ricarica USB Type-C



MODE BLUETOOTH





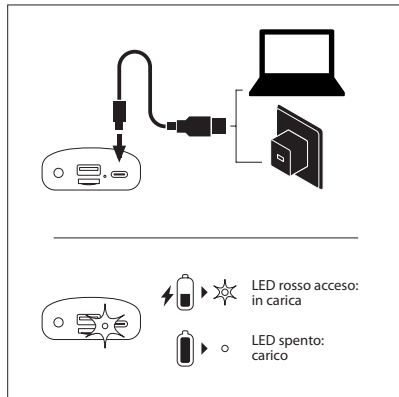







<p>1</p>  <p>Tenere premuto il pulsante per 3 secondi per accendere l'altoparlante</p>	<p>2</p>  <p>Il LED lampeggia perché l'altoparlante è in modalità di ricerca</p>
<p>3</p>  <p>Cercare "NGS Roller Beast" nelle opzioni Bluetooth del dispositivo mobile</p>	<p>4</p>  <p>LED fisso: connesso</p>









COME RICARICARE?





ISTRUZIONI D'USO



TWS



1	2
1   3s Tenere premuto per 3 secondi per accendere gli altoparlanti	1   3s Tenere premuto per 3 secondi per accendere gli altoparlanti
2   x2  ○  0.5s Premere due volte il pulsante * su entrambi gli altoparlanti per annullare l'abbinamento e metterli in modalità di ricerca	2   x2  ○  0.5s Premere due volte il pulsante * su entrambi gli altoparlanti per annullare l'abbinamento e metterli in modalità di ricerca



3  x1 Premere il pulsante TWS per abbinarli	3  x1 Premere il pulsante TWS per abbinarli
4  "Beep" Si sentirà un segnale acustico su entrambi gli altoparlanti	4  "Beep" Si sentirà un segnale acustico su entrambi gli altoparlanti
5   Il LED del primo altoparlante rimane fisso, mentre quello dell'altro lampeggia	5  ○   Il LED del primo altoparlante rimane fisso, mentre quello dell'altro lampeggia

MODE RADIO

<p>6</p>  <p>Cercare nelle opzioni Bluetooth del dispositivo mobile "NGS Roller Beast"</p>	
---	---

<p>1</p>  <p>3s</p>	<p>2</p>  <p>2s</p>	<p>3</p>  <p>ricerca del canale x2</p>
--	---	---

<p>1</p> 		<p>2</p> 
<p>Premere di nuovo il pulsante TWS per uscire dalla modalità TWS</p>		

<p>4</p> <p>canale -</p> 	<p>canale +</p> 
<p>Nota: collegare il cavo USB C per un migliore segnale radio</p>	

ISTRUZIONI D'USO

MODE USB/TF

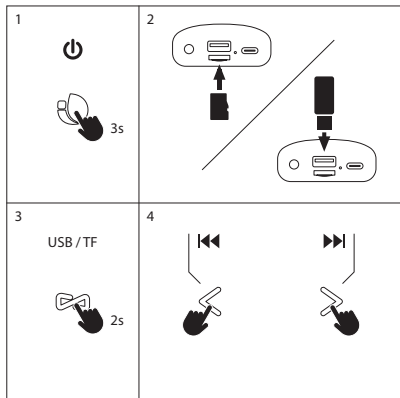

MODE AUX IN

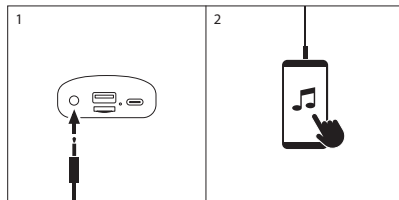

SPECIFICHE TECNICHE

Compatibile con Bluetooth 5.0 TWS (doppia potenza collegando 2 altoparlanti contemporaneamente senza fili)	Sì
Potenza massima in uscita	32W
Potenza RMS	16W
Ingresso audio AUX	Sì
Ingresso audio USB	Sì
Ingresso audio TF	Sì
Controllo del volume	Sì
Batteria	Ion-Li 6000mAh
Tempo di funzionamento	7 ore*
Impermeabile	IPX5

- * con luci
 11 ore al 50% del volume
 7 ore al 70% del volume
 4 ore al 100% del volume
- senza luci
 30 ore al 50% del volume
 20 ore al 70% del volume
 7 ore al 100% del volume

Garanzia della batteria

La batteria è un materiale di consumo e, come tale, ha una garanzia di 12 mesi.



Se in futuro dovesse essere necessario smaltire questo prodotto, si prega di notare che: I rifiuti elettrici non devono essere smaltiti insieme ai rifiuti domestici. Riciclare in apposite strutture.



Verificare con l'Autorità locale o Rivenditore dove poter riciclare il dispositivo.



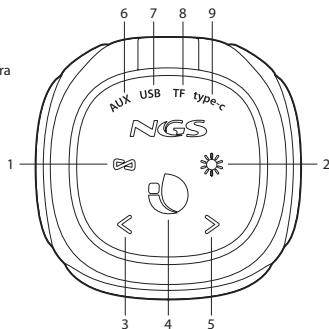

(Direttiva sullo smaltimento dei rifiuti elettrici ed elettronici)

BOTÕES DE CONTROLE

- 1 Botão de modo / TWS**
Premir brevemente: TWS / Premir durante alguns segundos: Modo de mudança
- 2 Botão de luz**
Clicar para mudar a luz/Premir durante alguns segundos para ligar/desligar a luz
Prima duas vezes para desemparelhar o dispositivo Bluetooth
- 3 Volume - / Faixa anterior**
Prima e solte para mudar para a faixa/ estação de rádio anterior
Prima e mantenha premido para diminuir o volume
- 4 Botão Reproduzir/Pausa**
Premir brevemente; reproduzir/pausa / Premir durante alguns segundos para ligar/desligar
No modo FM: Prima duas vezes para pesquisar o programa
- 5 Volume + / Faixa seguinte**
Prima e solte para avançar para a próxima faixa/ estação de rádio
Prima e mantenha premido para aumentar o volume
- 6 Interface AUX**
- 7 Interface USB**
- 8 Interface para cartão TF**
- 9 Interface Tipo C**
Porta de carregamento USB Tipo C









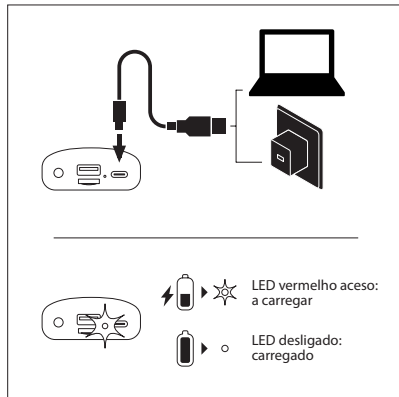









MODO BLUETOOTH









<p>1</p>  <p>Prima e mantenha premido o botão durante 3 segundos para ligar o altifalante</p>	<p>2</p>  <p>O LED piscará porque o altifalante está no modo de pesquisa</p>
<p>3</p>  <p>Procure por NGS Roller Beast nas opções de Bluetooth do dispositivo móvel</p>	<p>4</p>  <p>LED fixo: conectado</p>

COMO CARREGAR?



TWS

1			2	
1	  3s		  3s	
Prima e mantenha premido durante 3 segundos para ligar os altifalantes				
2	  x2  o  0.5s		  x2  o  0.5s	
Prima o botão  duas vezes em ambos os altifalantes para desemparelhar e colocá-los no modo de pesquisa				

3	 x1	 x1
Prima o botão TWS para emparelhá-los		
4	 "Beep"	 "Beep"
Ouvirá um som de bipe em ambos os altifalantes		
5	 	 o  
O LED do primeiro altifalante permanecerá fixo e o outro piscará		

MODO RADIO

6		
<p>Pesquise as opções de Bluetooth no dispositivo móvel para "NGS Roller Beast"</p>		

1			2	
x1		<p>Prima o botão TWS novamente para sair do modo TWS</p>		

1		2	3s	3	<p>pesquisa de canais</p> x2
<p>canal -</p>		<p>canal +</p>		<p>Nota: ligue o cabo USB C para um sinal de rádio melhor</p>	

MODO USB/TF

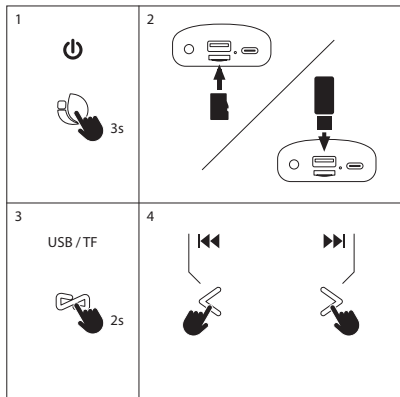

AUX IN MODE

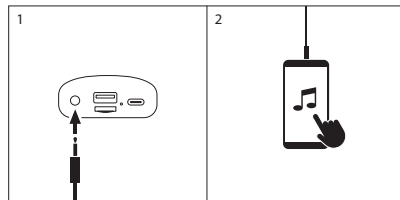

ESPECIFICAÇÕES TÉCNICAS

Compatível com bluetooth 5.0 TWS (obtenha uma dupla potência conectando 2 altifalantes sem fios ao mesmo tempo)	Sim
Pico de potência de saída	Sim
Potência RMS	32W
Entrada de áudio AUX	16W
Entrada de áudio USB	Sim
Entrada de áudio TF	Sim
Controlo de volume	Sim
Bateria	Ion-Li 6000mAh
Tempo de funcionamento	7 horas*
Resistente à água	IPX5

* com luzes

11 horas a 50% do volume

7 horas a 70% do volume

4 horas a 100% do volume

sem luzes

30 horas a 50% do volume

20 horas a 70% do volume

7 horas a 100% do volume

Garantia da bateria

A bateria é um consumível e, como tal, a garantia da mesma é de 12 meses.



Se a qualquer momento no futuro tiver que se desfazer deste produto, por favor note que:

Os resíduos dos produtos eléctricos não deverão ser misturados juntamente com os resíduos domésticos. Por favor recicle onde seja possível.

Verifique junto da sua Autoridade Local ou comerciante informação acerca de reciclagem.



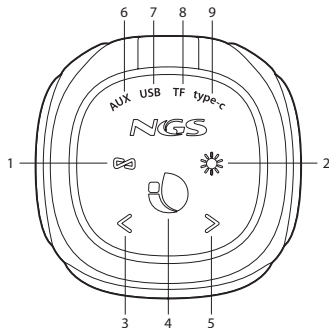

(Directiva sobre Resíduos de Equipamento Eléctrico e Electrónico)

PRZYCISKI STEROWANIA

- 1 Przycisk trybów / TWS**
Przytrzymaj krótko: TWS / Przytrzymaj długo: Zmiana trybu
- 2 Przycisk podświetlenia**
Przyciśnij, aby włączyć podświetlenie / Przyciśnij długo, aby włączyć/wyłączyć podświetlenie
Naciśnij dwukrotnie, aby anulować sparowanie urządzenia Bluetooth
- 3 Głośność – / Poprzedni utwór**
Naciśnij i zwolnij, aby przejść do poprzedniej ścieżki/stacji radiowej
Naciśnij i zwolnij, aby zmniejszyć głośność
- 4 Przycisk Odtwarzaj/Pauza**
Przytrzymaj krótko: odtwarzaj/pauza / Przytrzymaj długo, aby włączyć/ wyłączyć
W trybie FM: Naciśnij dwukrotnie, aby wyszukać program
- 5 Głośność + / Następny utwór**
Naciśnij i zwolnij, aby przejść do następnej ścieżki/stacji radiowej
Naciśnij i zwolnij, aby zwiększyć głośność
- 6 Złącze AUX**
- 7 Złącze USB**
- 8 Wejście karty TF**
- 9 Port dla złącza typu C**
Port ładowania kablem USB typu C



TRYB BLUETOOTH





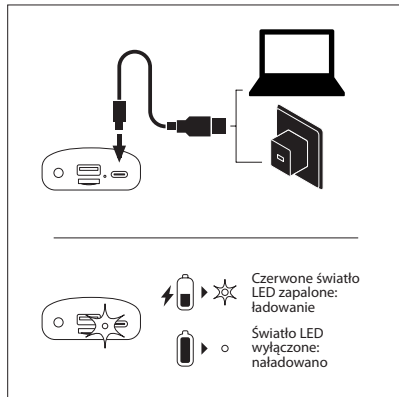







<p>1</p>  <p>Naciśnij i przytrzymaj przycisk przez 3 sekundy, aby wyłączyć głośnik</p>	<p>2</p>  <p>Światło LED będzie migać, ponieważ głośnik będzie w trybie wyszukiwania</p>
<p>3</p>  <p>Wyszukaj „NGS Roller Beast” w opcjach Bluetooth na urządzeniu mobilnym</p>	<p>4</p>  <p>Stale światło LED: połączono</p>









JAK ŁADOWAĆ?





PODRĘCZNIK UŻYTKOWNIKA





TWS







1			2	
1	  3s		  3s	
Naciśnij i przytrzymaj przez 3 sekundy, aby włączyć głośniki				
2	  x2  0.5s		  x2  0.5s	
Naciśnij dwukrotnie przycisk * na obu głośnikach, aby anulować sparowanie i wprowadzić je w tryb wyszukiwania				

3	 x1	 x1
Aby je sparować, naciśnij przycisk TWS		
4	 "Beep"	 "Beep"
Usłyszysz pikający dźwięk z obu głośników		
5	 	 o  
Światło LED na pierwszym głośniku pozostanie stałe, a na drugim będzie migać		

TRYB RADIO

<p>6</p>  <p>Wyszukaj opcje Bluetooth na mobilnym urządzeniu dla „NGS Roller Beast”</p>	
--	---

<p>1</p> 	 <p>2</p> 
 x1 <p>Naciśnij ponownie przycisk TWS, aby wyjść z trybu TWS</p>	

<p>1</p>   3s	<p>2</p>  2s	<p>3</p>  <p>wyszukiwanie kanałów</p>  x2
<p>4</p> <div style="display: flex; justify-content: space-around;"> <div style="text-align: center;"> <p>kanal -</p>  </div> <div style="text-align: center;"> <p>kanal +</p>  </div> </div>		<p>Uwaga: Podłącz kabel USB C, aby wzmocnić sygnał radiowo</p>

TRYB USB/TF

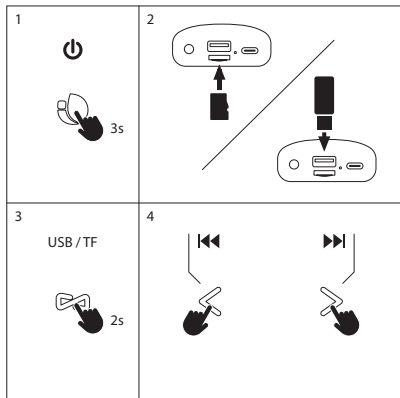

TRYB AUX IN

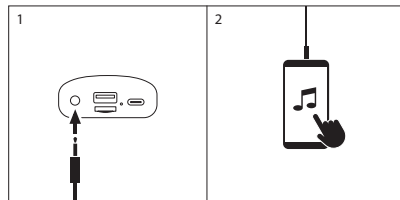

SPECYFIKACJA TECHNICZNA

Kompatybilny z Bluetooth 5.0 TWS (podwójna moc po bezprzewodowym połączeniu 2 głośników)	Tak
Maksymalna moc wyjściowa RMS	Tak 32W 16W
Wejście audio AUX	Tak
Wejście audio USB	Tak
Wejście audio TF	Tak
Regulacja głośności	Tak
Akumulator	Ion-Li 6000mAh
Czas pracy	7 godzin*
Wodoodporność	IPX5

* ze światłami
11 godzin przy 50% głośności
7 godzin przy 70% głośności
4 godzin przy 100% głośności
bez światel
30 godzin przy 50% głośności
20 godzin przy 70% głośności
7 godzin przy 100% głośności

Gwarancja baterii

Akumulator jest materiałem eksploatacyjnym i jako takiemu, zapewnia się 12 miesięcy gwarancji.



Jeżeli w przyszłości zajdzie potrzeba utylizacji niniejszego produktu należy pamiętać, że: Zużyte urządzenia elektryczne i elektroniczne nie mogą być wyrzucane wraz z innymi odpadami pochodzącymi z gospodarstwa domowego. Tego typu urządzenia należy przekazać do punktu składowania zużytych urządzeń elektrycznych i elektronicznych.

Informacje na temat punktów składowania można uzyskać od miejscowych władz i u sprzedawcy.



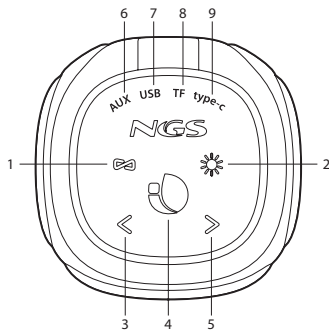

(Dyrektywa WEEE w sprawie zużytego sprzętu elektrycznego i elektronicznego)

BEDIENINGSTOETSEN

- 1 Modusknop / TWS**
Kort drukken: TWS / Lang drukken: Modus wijzigen
- 2 Lichtknop**
Klik om licht te wijzigen / Lang drukken om licht in/uit te schakelen
Druk tweemaal om het Bluetooth-apparaat los te koppelen
- 3 Volume - / Vorige nummer**
Druk op en laat los om naar het vorige nummer/radiostation te gaan
Houd ingedrukt om het volume te verlagen
- 4 Afspelen- / Pauzeknop**
Kort drukken: afspelen/pauzeren / Lang indrukken om aan/uit te zetten
In FM-modus: Druk tweemaal om het programma te zoeken
- 5 Volume + / Volgende nummer**
Druk op en laat los om naar het volgende nummer/radiostation te gaan
Houd ingedrukt om het volume te verhogen
- 6 AUX-interface**
- 7 USB-interface**
- 8 TF-kaart interface**
- 9 Type-C interface**
USB type-C oplaadpoort



MODUS BLUETOOTH





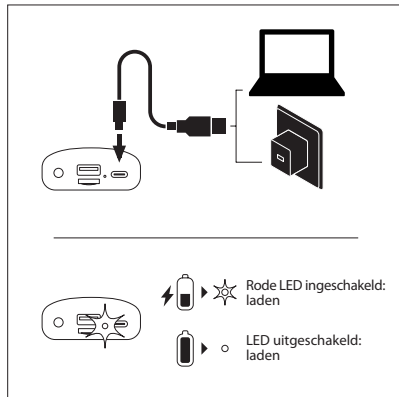







<p>1</p>  <p>Houd de knop 3 seconden ingedrukt om de luidspreker in te schakelen</p>	<p>2</p>  <p>De LED knippert omdat de luidspreker in de zoekmodus staat</p>
<p>3</p>  <p>Zoek naar "NGS Roller Beast" in de Bluetooth-opties van het mobiele apparaat</p>	<p>4</p>  <p>Vaste LED: aangesloten</p>









HOE OPLADEN?



GEBRUIKSAANWIJZING

TWS

1	
1	2
  3s	  3s
Houd 3 seconden ingedrukt om de luidsprekers in te schakelen	
2	2
  x2  ○  0.5s	  x2  ○  0.5s
Druk tweemaal op de * -knop op beide luidsprekers om ze los te koppelen en in de zoekmodus te plaatsen	

3	3
 x1	 x1
Druk op de TWS-knop om ze te koppelen	
4	4
 "Beep"	 "Beep"
U hoort een piepend geluid op beide luidsprekers	
5	5
 	 ○  
De LED op de eerste luidspreker blijft vast en de andere knippert	

MODUS RADIO

6		
<p>Zoek in de Bluetooth-opties op het mobiele apparaat naar "NGS Roller Beast"</p>		

1			2	
x1		<p>Druk nogmaals op de TWS-knop om de TWS-modus te verlaten</p>		

1		2	3s	3	<p>zender zoeken</p> x2
<p>zender -</p>		<p>zender +</p>		<p>Opmerking: Sluit de USB C kabel aan voor een beter radiosignaal</p>	

GEBRUIKSAANWIJZING

MODUS USB/TF

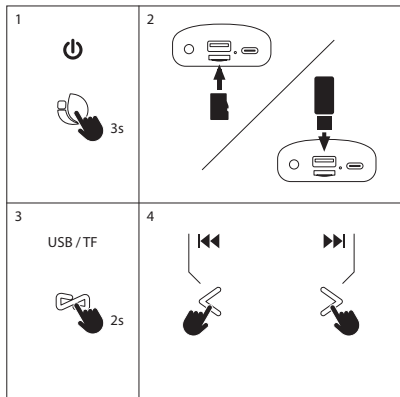

AUX IN MODE

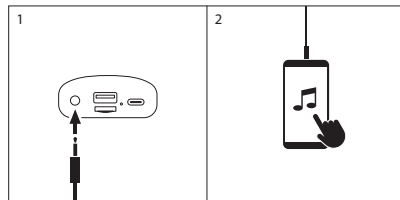

TECHNISCHE SPECIFICATIES

Compatibel met Bluetooth 5.0	Ja
TWS (krijg dubbel vermogen door 2 luidsprekers tegelijkertijd aan te sluiten zonder kabels)	Ja
Piekuitgangsvermogen	32W
RMS	16W
AUX-audioinvoer	Ja
USB-audioinvoer	Ja
TF-audioinvoer	Ja
Volumeregeling	Ja
Batterij	Ion-Li 6000mAh
Bedrijfstijd	7 uur*
Waterdicht	IPX5

* met lichten

11 uur bij 50% volume

7 uur bij 70% volume

4 uur bij 100% volume

zonder lichten

30 uur bij 50% volume

20 uur bij 70% volume

7 uur bij 100% volume

Batterij garantie

De batterij is een verbruiksartikel en als zodanig bedraagt de garantie 12 maanden.



Indien u dit product in de toekomst wilt afdanken, dan moet u er rekening mee houden dat:

elektrische producten niet bij het huishoudelijk afval mogen geplaatst worden. Recyclen in de beschikbare installaties.

Raadpleeg de lokale autoriteiten of dealer voor instructies over recycling.



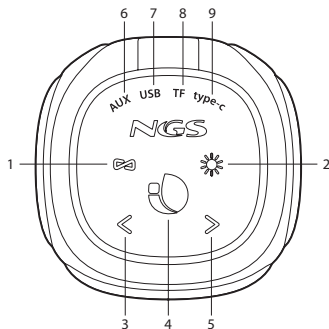

(Richtlijn betreffende de verwijdering van elektrische en elektronische apparatuur)

TLAČÍTKO OVLÁDÁNÍ

- 1 Tlačítko režimu / TWS**
Krátké stisknutí: TWS / Dlouhé stisknutí: Změna režimu
- 2 Tlačítko osvětlení**
Kliknutím zapnete světlo / Dlouhým stisknutím zapnete/vypnete světlo
Dvojitým stisknutím zrušíte spárování zařízení Bluetooth
- 3 Hlasitost – / Předchozí píseň**
Stisknutím a uvolněním přejdete na předchozí skladbu/rozhlasovou stanici
Stisknutím a podržením snížíte hlasitost
- 4 Tlačítko Přehrát / Pozastavit**
Krátké stisknutí: přehrávání/pauza / Dlouhým stisknutím zapnete/vypnete
V režimu FM: Dvakrát stiskněte pro vyhledání programu
- 5 Hlasitost + / Další písnička**
Stisknutím a uvolněním přejdete na další skladbu/rozhlasovou stanici
Stisknutím a podržením zvýšíte hlasitost
- 6 AUX Rozhraní**
- 7 USB rozhraní**
- 8 Rozhraní karty TF**
- 9 Rozhraní typu C**
Nabíjecí port USB typu C



REŽIM BLUETOOTH

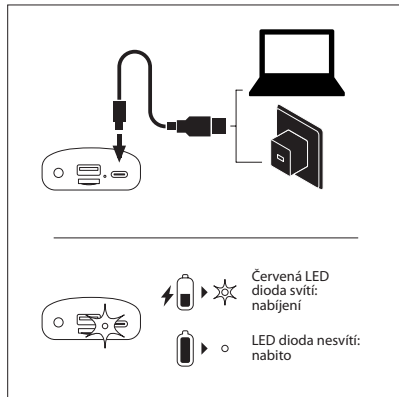

<p>1</p>  <p>3s</p> <p>Stisknutím a podržením tlačítka na 3 sekundy zapnete reproduktor</p>	<p>2</p>  <p>LED dioda bude blikat, protože reproduktor je v režimu vyhledávání</p>
<p>3</p>  <p>NGS Roller Beast</p> <p>V možnostech Bluetooth mobilního zařízení vyhledejte položku „NGS Roller Beast“</p>	<p>4</p>  <p>Stálá LED dioda: připojeno</p>

JAK NABÍJET?



UŽIVATELSKÁ PŘÍRUČKA

TWS

1		1	3s
Stisknutím a podržením po dobu 3 sekund zapnete reproduktory			
2		x2	0.5s
Dvojm stisknutím tlačítka * na obou reproduktorech zrušíte jejich spárování a přepnete je do režimu vyhledávání			

3	x1
Stisknutím tlačítka TWS je spárujete	
4	"Beep"
Na obou reproduktorech uslyšíte pípnutí	
5	LED dioda na prvním reproduktoru zůstane stálá a druhá bude blikat

REŽIM RADIO

6		
<p>Vyhledejte v možnostech Bluetooth v mobilním zařízení „NGS Roller Beast“</p>		

1			2	
x1		<p>Opětovným stisknutím tlačítka TWS ukončete režim TWS</p>		

1		2	3s	3	<p>Hledání kanálu</p> x2
<p>Kanál -</p>		<p>Kanál +</p>		<p>Poznámka: Pro lepší rádiový signál připojte USB C kabel</p>	

REŽIM USB/TF

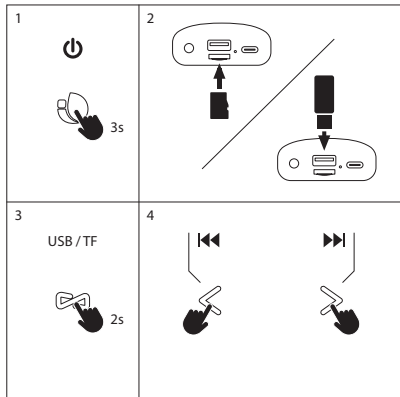

REŽIM AUX IN

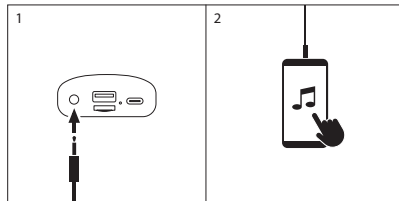

TECHNICKÉ SPECIFIKACE

Kompatibilní s Bluetooth 5.0	Ano
TWS (dosáhne dvojnásobného výkonu připojením 2 reproduktorů současně bez kabelů)	Ano
Maximální výstupní výkon	32W
RMS	16W
AUX audio vstup	Ano
USB audio vstup	Ano
TF audio vstup	Ano
Ovládání hlasitosti	Ano
Baterie	Ion-Li 6000mAh
Provozní doba	7 hodin*
Vodotěsné	IPX5

* se světly

11 hodin při 50% hlasitosti

7 hodin při 70% hlasitosti

4 hodin při 100% hlasitosti

bez světél

30 hodin při 50% hlasitosti

20 hodin při 70% hlasitosti

7 hodin při 100% hlasitosti

Záruka na baterie

Baterie je spotřební produkt a jako takový má záruku na 12 měsíců.



Pokud bude tento výrobek třeba v budoucnu zlikvidovat, upozorňujeme, že:

Elektrické produkty nesmí být likvidovány společně s komunálním odpadem. Je třeba je recyklovat v příslušných zařízeních.

Pro pokyny k recyklaci se obraťte na místní úřady nebo na prodejce.



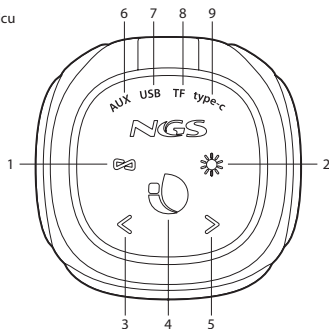

(Směrnice o likvidaci elektrických a elektronických zařízení)

OVLÁDACIE TLAČIDLÁ

- 1 Tlačidlo režimu / TWS**
Krátke stlačenie: TWS / dlhé stlačenie: Zmena režimu
- 2 Tlačidlo pre svetlo**
Kliknutím zapnete svetlo / Dlhým stlačením zapnete / vypnete svetlo
Dvojitém stlačením zrušíte spárovanie zariadenia Bluetooth
- 3 Hlasitosť – / Predchádzajúca pieseň**
Stlačením a uvoľnením prejdete na predchádzajúcu skladbu/rozhlasovú stanicu
Stlačením a podržaním znížite hlasitosť
- 4 Tlačidlo prehrať/pozastaviť**
Krátke stlačenie: prehrávanie / Dlhým stlačením zapnete / vypnete
V režime FM: Stlačte dvakrát pre vyhľadanie programu
- 5 Hlasitosť + / Nasledujúca pieseň**
Stlačením a uvoľnením prejdete na nasledujúcu skladbu/rozhlasovú stanicu
Stlačením a podržaním zvýšite hlasitosť
- 6 AUX rozhranie**
- 7 USB rozhranie**
- 8 TF karta rozhranie**
- 9 Typ C rozhranie**
USB nabíjací port typu C



REŽIM BLUETOOTH





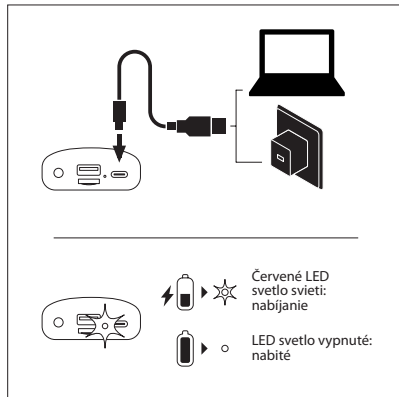









<p>1</p>  <p>Reproduktor zapnete stlačením a podržaním tlačidla na 3 sekundy</p>	<p>2</p>  <p>LED svetlo bude blikať, pretože reproduktor je v režime vyhľadávania</p>
<p>3</p>  <p>V možnostiach Bluetooth mobilného zariadenia vyhľadajte „NGS Roller Beast“</p>	<p>4</p>  <p>Nehybné LED svetlo: pripojené</p>









AKO NABÍJAŤ?





POUŽÍVATEĽSKÁ PRÍRUČKA





TWS









1			2	
1	  3s		  3s	
Stlačením a podržaním na 3 sekundy zapnete reproduktory				
2	  x2  ○  0.5s		  x2  ○  0.5s	
Dvojitým stlačením tlačidla * na oboch reproduktoroch zrušíte ich spárovanie a prepnete ich do režimu vyhľadavania				

3	 x1	 x1
Spárujte ich stlačením tlačidla TWS		
4	 "Beep"	 "Beep"
Z oboch reproduktorov budete počuť pípnutie		
5	 	 ○  
LED na prvom reproduktore zostane nehybné a druhé bude blikať		

REŽIM RADIO

<p>6</p>  <p>Vyhľadajte možnosti Bluetooth na mobilnom zariadení „NGS Roller Beast“</p>	
--	---

<p>1</p> 	 <p>2</p> 
 x1 <p>Opätovným stlačením tlačidla TWS ukončíte režim TWS</p>	

<p>1</p>   3s	<p>2</p>   2s	<p>3</p>  <p>Vyhľadávanie kanálov</p>  x2
<p>4</p> <div style="display: flex; justify-content: space-around;"> <div style="text-align: center;"> <p>Kanál -</p>  </div> <div style="text-align: center;"> <p>Kanál +</p>  </div> </div>		<p>Poznámka: Pripojte USB C kábel, aby bol rádiový signál lepší</p>

REŽIM USB/TF

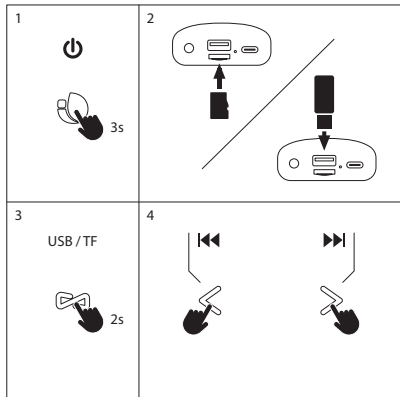

REŽIM AUX IN

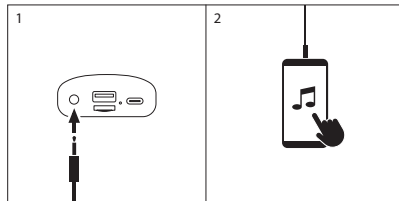

TECHNICKÉ ŠPECIFIKÁCIE

Kompatibilné s Bluetooth 5.0 TWS (dvojnásobný výkon získate pripojením dvoch reproduktorov súčasne bez káblov)	Áno
Výstupný výkon RMS	Áno 32W 16W
AUX audio vstup	Áno
USB audio vstup	Áno
TF audio vstup	Áno
Ovládanie hlasitosti	Áno
Batérie	Ion-Li 6000mAh
Prevádzková doba	7 hodín*
Vodotesnosť	IPX5

* so svetlami

11 hodín pri 50 % hlasitosti

7 hodín pri 70 % hlasitosti

4 hodín pri 100 % hlasitosti

bez svetiel

30 hodín pri 50 % hlasitosti

20 hodín pri 70 % hlasitosti

7 hodín pri 100 % hlasitosti

Záruka batérie

Batéria je spotrebný materiál, a preto záruka je 12 mesiacov.



Ak v budúcnosti budete musieť tento produkt vyhodiť, vezmite prosím na vedomie, že: Odpad z elektronických výrobkov sa nesmie likvidovať s domovým odpadom. Recyklujte ho v dostupných zariadeniach.

Informujte sa u miestnych úradov alebo u predajcu a požiadajte o pokyny na recykláciu.



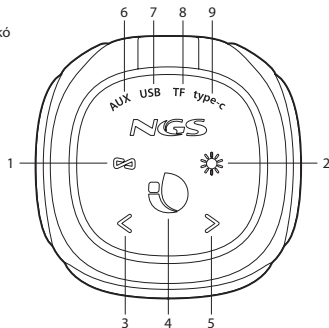

(Smernica o likvidácii elektrických a elektronických zariadení)

ΚΟΥΜΠΙΑ ΕΛΕΓΧΟΥ

- 1 Κουμπί λειτουργίας / TWS**
Σύντομη πίεση: TWS / Παρατεταμένη πίεση: Αλλαγή λειτουργίας
- 2 Κουμπί φωτισμού**
Κάντε κλικ για να ανάψετε τη λυχνία / Παρατεταμένη πίεση για λειτουργία λυχνίας on/off
Πατήστε δυο φορές για να αποσυνδέσετε την συσκευή Bluetooth
- 3 Ένταση ήχου - / Προηγούμενο τραγούδι**
Πιέστε και αφήστε για να μεταβείτε στο προηγούμενο τραγούδι/ραδιοφωνικό σταθμό
Πιέστε και κρατήστε πατημένο για να μειώσετε την ένταση του ήχου
- 4 Κουμπί αναπαραγωγής/παύσης**
Σύντομη πίεση: αναπαραγωγή/παύση / Παρατεταμένη πίεση για λειτουργία on/off
Σε λειτουργία FM: Πιέστε δυο φορές για να αναζητήσετε το πρόγραμμα
- 5 Ένταση ήχου + / Επόμενο τραγούδι**
Πιέστε και αφήστε για να μεταβείτε στο επόμενο τραγούδι/ραδιοφωνικό σταθμό
Πιέστε και κρατήστε πατημένο για να αυξήσετε την ένταση του ήχου
- 6 Διεπαφή AUX**
- 7 Διεπαφή USB**
- 8 Διεπαφή κάρτας TF**
- 9 Διεπαφή τύπου-C**
Πύλη φόρτισης USB τύπου-C



ΛΕΙΤΟΥΡΓΙΑ ΒΛΥΕΤΟΟΤΗ





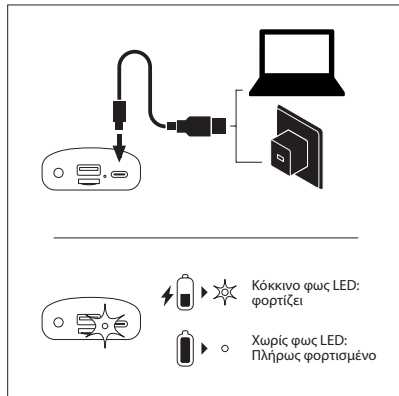









<p>1</p>  <p>Πιέστε και κρατήστε πατημένο για 3 δευτ. για να ενεργοποιήσετε το ηχείο</p>	<p>2</p>  <p>Το φως LED θα αναβοσβήνει καθώς το ηχείο είναι σε λειτουργία αναζήτησης</p>
<p>3</p>  <p>Αναζητείστε το "NGS Roller Beast" στις επιλογές Bluetooth της κινητής σας συσκευής</p>	<p>4</p>  <p>Σταθερό φως LED: συνδεδεμένο</p>









ΠΡΑΓΜΑΤΟΠΟΙΗΣΗ ΦΟΡΤΙΣΗΣ





ΟΔΗΓΙΕΣ ΧΡΗΣΗΣ



TWS



1			2	
1	  3s		  3s	
Πιέστε και κρατήστε πατημένο για 3 δευτ. για να ενεργοποιήσετε τα ηχεία				
2	  x2		  x2	
 ○  0.5s		 ○  0.5s		
Πιέστε δυο φορές το κουμπί * και στα δυο ηχεία για να τα αποσυνδέσετε και να τα βάλετε σε λειτουργία αναζήτησης				



3	 x1	 x1
Πιέστε το κουμπί TWS για να τα συνδέσετε		
4	 "Beep"	 "Beep"
Θα ακούσετε έναν ήχο «μπιπ» και στα δυο ηχεία		
5	 	 ○  
Το φως LED στο πρώτο ηχείο θα είναι σταθερό και το άλλο θα αναβοσβήνει		

ΛΕΙΤΟΥΡΓΙΑ RADIO

<p>6</p>  <p>Αναζητήστε στις επιλογές Bluetooth της κινητής συσκευής το "NGS Roller Beast"</p>	
---	---

<p>1</p>  <p>3s</p>	<p>2</p>  <p>2s</p>	<p>3</p>  <p>Αναζήτηση προγράμματος x2</p>
--	---	---

<p>1</p>  <p>x1</p>	<p>2</p> 
<p>Πιέστε ξανά το κουμπί TWS για να βγείτε από την λειτουργία TWS</p>	

<p>4</p> <p>Πρόγραμμα - Πρόγραμμα +</p>  	<p>Σημείωση: Συνδέστε το καλώδιο USB C για καλύτερο σήμα ραδιοφώνου</p>
--	--

ΛΕΙΤΟΥΡΓΙΑ USB/TF

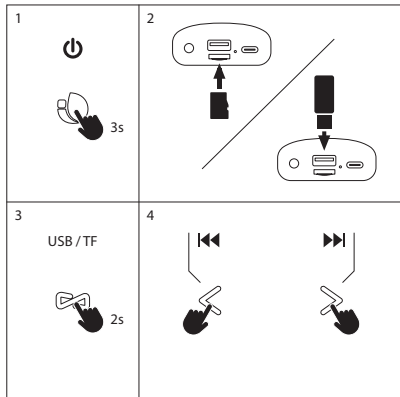

ΛΕΙΤΟΥΡΓΙΑ AUX IN

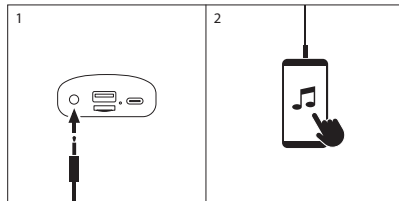

ΤΕΧΝΙΚΕΣ ΠΡΟΔΙΑΓΡΑΦΕΣ

Συμβατό με bluetooth 5.0	Ναί
TWS (λήψη διπλάσιας ισχύος με την ταυτόχρονη σύνδεση 2 ηχείων χωρίς καλώδια)	Ναί
Μέγιστη ισχύς εξόδου	32W
RMS	16W
Είσοδος ήχου AUX	Ναί
Είσοδος ήχου USB	Ναί
Είσοδος ήχου TF	Ναί
Έλεγχος έντασης ήχου	Ναί
Μπαταρία	Ion-Li 6000mAh
Χρόνος λειτουργίας	7 ώρες*
Αδιάβροχο	IPX5

* με φώτα

11 ώρες στο 50% της έντασης ήχου

7 ώρες στο 70% της έντασης ήχου

4 ώρες στο 100% της έντασης ήχου

χωρίς φώτα

30 ώρες στο 50% της έντασης ήχου

20 ώρες στο 70% της έντασης ήχου

7 ώρες στο 100% της έντασης ήχου

Εγγύηση μπαταρίας

Η μπαταρία είναι αναλώσιμη, και ως τέτοια, η παρεχόμενη εγγύηση είναι για 12 μήνες.



Αν στο μέλλον παραστεί η ανάγκη απόρριψης του προϊόντος, λάβετε υπόψη:

Πως τα απόβλητα ηλεκτρονικών προϊόντων δεν επιτρέπεται να απορρίπτονται μαζί με τα οικιακά απορρίμματα. Ανακυκλώστε το στις διαθέσιμες εγκαταστάσεις.

Αποταθείτε στις αρμόδιες Τοπικές Αρχές ή στον εμπορικό αντιπρόσωπο για πληροφορίες σχετικά με την ανακύκλωση.



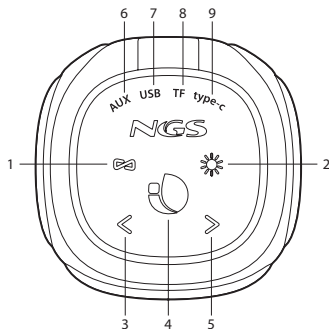

(Οδηγία περί απόρριψης Ηλεκτρονικών και Ηλεκτρικών Συσκευών)

VEZÉRLŐ GOMBOK

- 1 Üzem mód gomb / TWS**
Rövid megnyomás: TWS / Hosszú megnyomás: Módváltás
- 2 Fény gomb**
Kattintson ide a világítás bekapcsolásához / Hosszan nyomja meg a lámpa be- / kikapcsolásához
Nyomja meg kétszer a Bluetooth-eszköz párosításának megszüntetéséhez
- 3 Hangerő – / Előző dal**
Nyomja meg és engedje el az előző számra/rádióállomásra lépéshez
Nyomja meg és tartsa lenyomva a hangerő csökkentéséhez
- 4 Lejátszás / Szünet gomb**
Rövid megnyomás: lejátszás / szünet / Hosszan nyomja meg a be- / kikapcsolásához
FM módban: Nyomja meg kétszer a program kereséséhez
- 5 Hangerő + / Következő dal**
Nyomja meg és engedje fel a következő műsorszámra/rádióállomásra lépéshez
Nyomja meg és tartsa lenyomva a hangerő növeléséhez
- 6 AUX interfész**
- 7 USB interfész**
- 8 TF kártya interfész**
- 9 C típusú interfész**
C típusú USB töltőport



BLUETOOTH MÓD





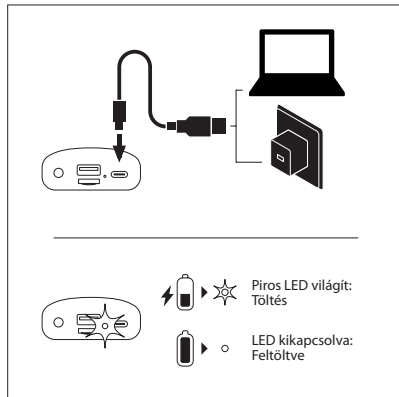







<p>1</p>  <p>Nyomja meg és tartsa lenyomva a gombot 3 másodpercig a hangszóró bekapcsolásához</p>	<p>2</p>  <p>A LED villogni fog, mert a hangszóró keresés módban van</p>
<p>3</p>  <p>Keresse meg az „NGS Roller Beast” kifejezést a mobilkészít Bluetooth beállításai között</p>	<p>4</p>  <p>Fix LED: csatlakoztatva</p>









HOGYAN KELL TÖLTENI?





FELHASZNÁLÓI ÚTMUTATÓ



TWS





1			2	
1	  3s		  3s	
Nyomja meg és tartsa lenyomva 3 másodpercig a hangszórók bekapcsolásához				
2	  x2		  x2	
 o  0.5s				
Nyomja meg kétszer az * gombot mindkét hangszórón a párosítás megszüntetéséhez és keresési módba helyezéséhez				



3	 x1	 x1
Nyomja meg a TWS gombot a párosításhoz		
4	 "Beep"	 "Beep"
Mindkét hangszóróból sípoló hangot fog hallani		
5	 	 o  
Az első hangszóró LED-je állandó marad, a másik pedig villogni fog		

RADIO MÓD

<p>6</p>  <p>Keresse meg a Bluetooth-beállításokat a mobilkészülékén: "NGS Roller Beast"</p>	
---	---

<p>1</p>  <p>3s</p>	<p>2</p>  <p>2s</p>	<p>3</p>  <p>csatornakeresés x2</p>
--	---	--

<p>1</p> 	 <p>2</p> 
 <p>x1</p> <p>Nyomja meg ismét a TWS gombot a TWS módból való kilépéshez</p>	

<p>4</p> <p>csatorna -</p> 	<p>csatorna +</p>  <p>Megjegyzés: A jobb rádiójel érdekében csatlakoztassa a USB C-kábelt</p>
--	--

USB/TF MÓD

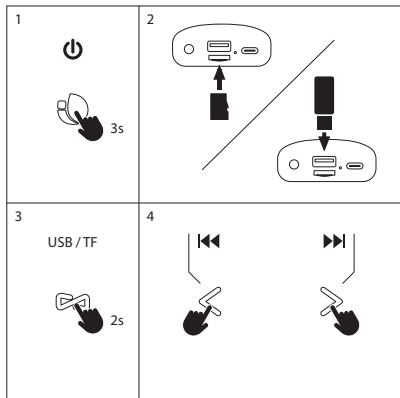

AUX IN MÓD

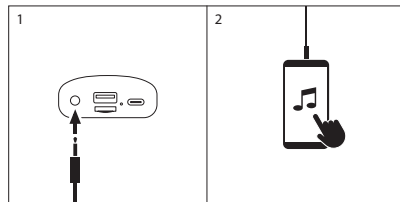

MŰSZAKI ADATLAP

Kompatibilis a Bluetooth 5.0 -val	Igen
TWS (dupla áramellátás két hangszóró csatlakoztatásához egyszerre kábelek nélkül)	Igen
Kimeneti csúcsteljesítmény	32W
RMS teljesítmény	16W
AUX audio bemenet	Igen
USB audio bemenet	Igen
TF audio bemenet	Igen
Hangerőszabályozó	Igen
Akkumulátor	Ion-Li 6000mAh
Az akkumulátor élettartama 8 óra*	7 óra*
Vízálló	IPX5

* fényel

11 óra 50% hangerővel

7 óra 70% hangerővel

4 óra 100% hangerővel

fény nélkül

30 óra 50% hangerővel

20 óra 70% hangerővel

7 óra 100% hangerővel

Az akkumulátor garanciája

Az akkumulátor fogyasztási cikk, és mint ilyen 12 hónapig garanciális.



Ha a jövőben bármikor el kell dobnia ezt a terméket, vegye figyelembe, hogy:

Az elektromos hulladékokat nem szabad a háztartási hulladékkal együtt megsemmisíteni.

Kérjük, hasznosítsa újra, ahol erre van kijelölt hely.

 Az újrahasznosítással kapcsolatban forduljon a helyi hatóságához vagy a kereskedőhöz.



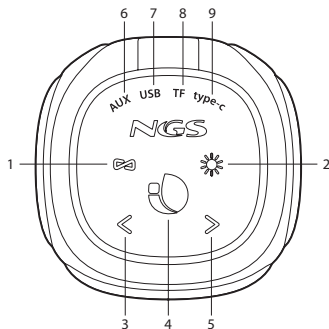

(Az elektromos és elektronikus berendezések hulladékairól szóló irányelv)

GUMB ZA UPRAVLJANJE

- 1 Gumb za način / TWS**
Kratek pritisk: TWS / Dolg pritisk: Spreminjanje načina
- 2 Gumb za osvetlitev**
Kratek pritisk za vklop luči / dolg pritisk za vklop/izklop luči
Pritisnite dvakrat, da razdružite napravo Bluetooth
- 3 Glasnost – / prejšnja pesem**
Kratek pritisk za pomik na naslednjo skladbo/radijsko postajo
Dolg pritisk za povečanje glasnosti.
- 4 Gumb za predvajanje / premor**
Kratek pritisk: predvajanje/ premor / dolg pritisk za vklop/izklop
V načinu FM: dvakrat pritisnite za iskanje programa
- 5 Glasnost + / naslednja pesem**
Kratek pritisk za pomik na naslednjo skladbo/radijsko postajo
Dolg pritisk za povečanje glasnosti
- 6 AUX vmesnik**
- 7 USB vmesnik**
- 8 Vmesnik kartice TF**
- 9 Vmesnik Type-C**
USB C priključek za polnjenje



NAČIN BLUETOOTH





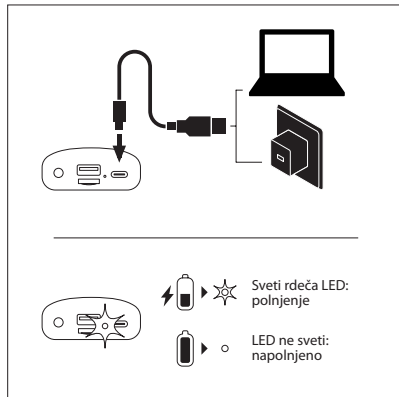









<p>1</p>  <p>Pritisnite in držite gumb 3 sekunde, da vklopite zvočnik</p>	<p>2</p>  <p>LED bo utripala, ker je zvočnik v načinu iskanja</p>
<p>3</p>  <p>V možnostih Bluetooth mobilne naprave poiščite »NGS Roller Beast«</p>	<p>4</p>  <p>Fiksna LED: priključena</p>









KAKO POLNITI?





UPORABNIŠKI PRIROČNIK





TWS







1			2	
1	  3s		  3s	
Pritisnite in držite 3 sekunde, da vklopite zvočnike				
2	  x2		  x2	
 ○  0.5s			 ○  0.5s	
Dvakrat pritisnite gumb * na obeh zvočnikih, da ju razdružite in postavite v način iskanja				

3	 x1		 x1	
Pritisnite gumb TWS, da ju združite				
4	 "Beep"		 "Beep"	
Na obeh zvočnikih boste slišali "pisk"				
5			 ○ 	
				
LED na prvem zvočniku bo ostala fiksna, na drugem bo utripala				

RADIJSKI NAČIN

<p>6</p>  <p>V možnostih Bluetooth v mobilni napravi poiščite »NGS Roller Beast«</p>	
---	---

<p>1</p> 	 <p>2</p> 
 x1 <p>Ponovno pritisnite gumb TWS, da zapustite način TWS</p>	

<p>1</p>   3s	<p>2</p>  2s	<p>3</p>  <p>iskanje kanalov</p>  x2
<p>4</p> <div style="display: flex; justify-content: space-around;"> <div data-bbox="793 600 880 751"> <p>kanal -</p>  </div> <div data-bbox="968 600 1055 751"> <p>kanal +</p>  </div> </div>		<p>Opomba: Za boljši radijski signal priključite kabel USB C</p>

NAČIN USB/TF

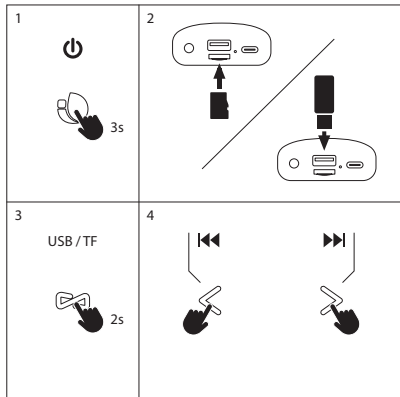

NAČIN AUX IN

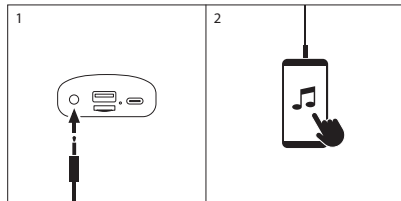

SPECIFIKACIJE

Združljivo z bluetooth 5.0 TWS (pridobite dvojno napajanje s povezavo 2 zvočnikov hkrati brez kablov)	Da
Izhodna moč	Da
RMS moč	32W
AUX avdio vhod	Da
Avdio vhod USB	Da
TF avdio vhod	Da
Nadzor glasnosti	Da
Baterija	Da
Življenjska doba baterije	Ion-Li 6000mAh
Vodoodporno	7 ur*
	IPX5
* z lučmi	
11 ur pri 50% glasnosti	
7 ur pri 70% glasnosti	
4 ure pri 100% glasnosti	
brez luči	
30 ur pri 50% glasnosti	
20 ur pri 70% glasnosti	
7 ure pri 100% glasnosti	

Garancija na baterijo

Baterija je potrošniški izdelek in je kot taka v garanciji 12 mesecev.



Če boste morali kadar koli v prihodnosti ta izdelek zavreči, upoštevajte naslednje:

Odpadnih električnih izdelkov ne smete odvreči med gospodinjske odpadke. Prosimo, reciklirajte, kjer obstajajo objekti.

Za nasvet glede recikliranja se obrnite na vaš lokalni organ ali prodajalca.



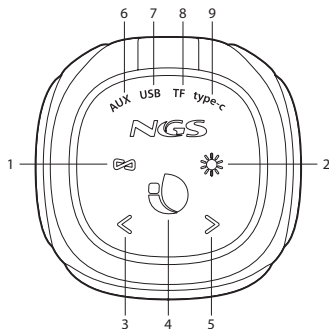

(Direktiva o odpadni električni in elektronski opremi)

KONTROLLKNAPPER

- 1 Modus-knapp / TWS**
Kort trykk: TWS / Langt trykk: Endre modus
- 2 Lys-knapp**
Klikk for å bytte lys / Langt trykk for å slå lyset av/på
Trykk to ganger for å koble fra Bluetooth-enheten
- 3 Volum – / Forrige sang**
Trykk og slipp for å gå til det forrige sporet/radiostasjonen
Trykk og hold nede for å redusere volumet
- 4 Play / Pause-knappen**
Kort trykk: spill / pause / Langt trykk for å slå av/på
FM -modus: Trykk to ganger for å søke etter programmet
- 5 Volum + / Neste sang**
Trykk og slipp for å gå til det neste sporet/radiostasjonen
Trykk og hold nede for å øke volumet
- 6 AUX-grensesnitt**
- 7 USB-grensesnitt**
- 8 TF -kortgrensesnitt**
- 9 Type-C-grensesnitt**
USB type-C ladeport



BLUETOOTH MODUS





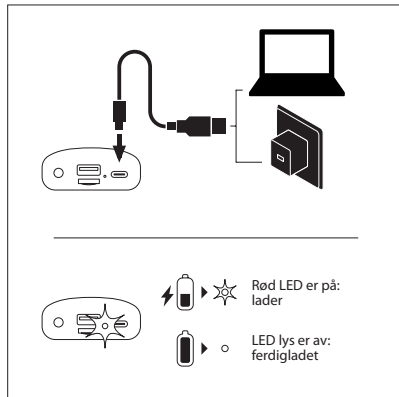











<p>1</p>  <p>Trykk og hold knappen inne i 3 sekunder for å slå på høyttaleren</p>	<p>2</p>  <p>LED-lampen vil blinke når høyttaleren er i søkemodus</p>
<p>3</p>  <p>Søk etter "NGS Roller Beast" i Bluetooth-innstillingene på mobilenheten</p>	<p>4</p>  <p>Fast LED: tilkoblet</p>











HVORDAN LADE?





BRUKERVEILEDNING



TWS





1		2	
1	  3s	  3s	
Trykk og hold inne i 3 sekunder for å slå på høyttalerne			
2	  x2	  x2	
  	  		
0.5s		0.5s	
Trykk to ganger på  -knappen på begge høyttalerne for å koble dem fra, og sette dem i søkemodus			



3	 x1	 x1
Trykk på TWS-knappen for å pare dem		
4	 "Beep"	 "Beep"
Du vil høre en pipelyd fra begge høyttalerne		
5		  
		
LED-lampen på den første høyttaleren forblir fast, og den andre vil blinke		

RADIO MODUS

<p>6</p>  <p>Søk i Bluetooth-innstillingene på mobilenheten etter "NGS Roller Beast"</p>	
---	---

<p>1</p>  <p>3s</p>	<p>2</p>  <p>2s</p>	<p>3</p> <p>kanalsøk</p>  <p>x2</p>
--	---	--

<p>1</p> 	 <p>2</p> 
 <p>x1</p> <p>Trykk på TWS-knappen igjen for å avslutte TWS-modus</p>	

<p>4</p> <p>kanal -</p> 	<p>kanal +</p>  <p>Merk: Koble til USB C-kabelen for et bedre radiosignal</p>
---	--

USB/TF MODUS

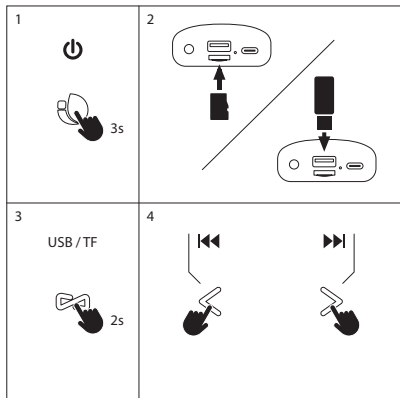

AUX IN MODUS

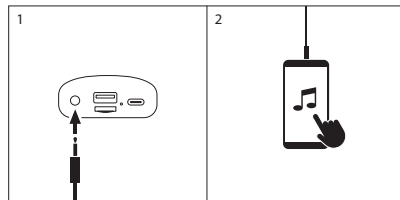

TEKNISKE SPESIFIKASJONER

Kompatibel med Bluetooth 5.0	Ja
TWS (få dobbelt strømtilkobling av to høyttalere samtidig uten kabler)	Ja
Toppeffekt	32W
RMS	16W
AUX-lydinngang	Ja
USB-lydinngang	Ja
TF-lydinngang	Ja
Volumkontroll	Ja
Batteri	Ion-Li 6000mAh
Batterilevetid	7 timer*
Vannrett til nivå	IPX5

* med lys

11 timer ved 50% volum

7 timer ved 70% volum

4 timer ved 100% volum

uten lys

30 timer ved 50% volum

20 timer ved 70% volum

7 timer ved 100% volum

Batterigaranti

Batteriet er et forbrukerprodukt, og som sådan er det garanti i 12 måneder.



Hvis du når som helst i fremtiden trenger å avhende dette produktet, vær oppmerksom på at: Avfall fra elektriske produkter skal ikke kastes sammen med husholdningsavfall.

Vennligst resirkulere der fasiliteter finnes.

Få råd om resirkulering av lokale myndigheter eller forhandler.



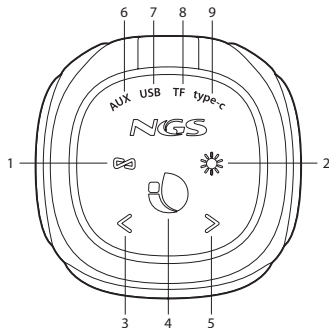

(Direktiv om Elektrisk og Elektronisk Utstyr)

OHJAUSPAINIKKEET

- 1 Toimintopainike / TWS**
Lyhyt painallus: TWS / Pitkä painallus: Asetuksen vaihto
- 2 Valopainike**
Klikkaus valon sytyttämiseen / Pitkä painallus valon sytyttämiseksi/
sammuttamiseksi
Painan kahdesti poistaaksesi Bluetooth-laitteeseen paritus
- 3 Äänenvoimakkuus – / Edellinen kappale**
Painan ja vapauta siirtyäksesi edelliseen kappaleeseen/radioasemaan
Paina ja pidä alhaalla pienentääksesi äänenvoimakkuutta
- 4 Toisto/taukopainike**
Lyhyt painallus: toisto/tauko / Pitkä painallus käynnistämiseksi/
sammuttamiseksi
FM-toiminto: Paina kahdesti hakeaksesi ohjelmaa
- 5 Äänenvoimakkuus + / Seuraava kappale**
Paina ja vapauta siirtyäksesi seuraavaan kappaleeseen/radioasemaan
Paina ja pidä alhaalla lisätäksesi äänenvoimakkuutta
- 6 AUX-liitäntä**
- 7 USB-liitäntä**
- 8 TF-korttiliitäntä**
- 9 C-liitäntä**
USB-C-latausportti



BLUETOOTH-TILA





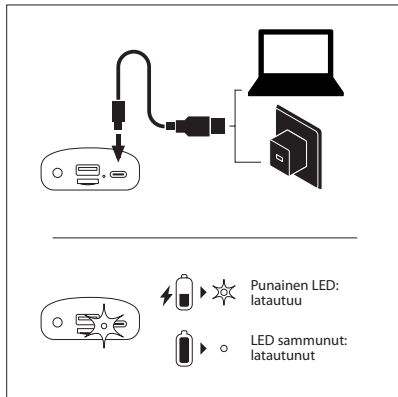



<p>1</p>  <p>Paina ja pidä alhaalla painiketta 3 sekunnin ajan kaiuttimen kytkemiseksi päälle</p>	<p>2</p>  <p>LED vilkkuu, koska kaiutin on hakuasetuksessa</p>
<p>3</p>  <p>Hae mobiililaitteen Bluetooth-vaihtoehdoista "NGS Roller Beast"</p>	<p>4</p>  <p>Tasainen LED: liitetty</p>









KUINKA LADATAAN?



KÄYTTÖOPAS

TWS

1		2	
1	 3s	 3s	
Paina ja pidä alhaalla 3 sekunnin ajan kaiuttimien kytkemiseksi päälle			
2	 x2	 x2	
 0.5s			
 0.5s			
Paina molempien kaiuttimien * -painiketta poistaaksesi niiden parituksen ja laita ne hakuasetukseen			

3	 x1	 x1
Paina TWS-painiketta niiden parittamiseksi		
4		
"Beep"		
Kuulet piippausäänen molemmista kaiuttimista		
5		
		
		
Ensimmäisen kaiuttimen LED palaa tasaisena ja toisen kaiuttimen valo vilkkuu		

RADIO-TILA

6



Hae mobiililaitteen Bluetooth-vaihtoehtoista "NGS Roller Beast"

1



2



3





kanavanhaku



1



2





x1

Paina TWS-painiketta uudelleen poistuaksesi TWS-asetuksesta

4

kanava -



kanava +



Huom:
Yhdistämällä USB C-kaapelin saat paremman radiosignaalin

USB/TF-TILA

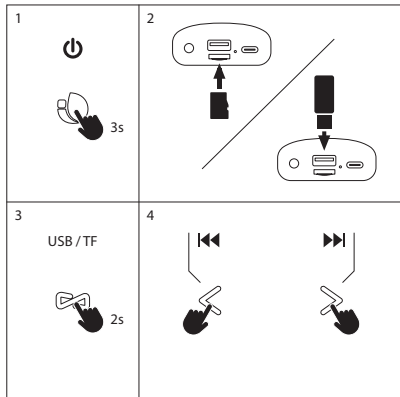

AUX IN-TILA

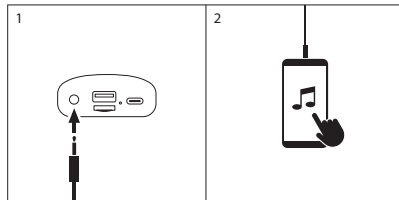

TEKNISET TIEDOT

Yhteensopiva Bluetooth 5.0:n kanssa	Kyllä
TWS (saat kaksinkertaisen virran kytkemällä 2 kaiutinta samanaikaisesti ilman kaapeleita)	Kyllä
Lähtöhuipputeho	32W
RMS	16W
AUX-audioliitäntä	Kyllä
USB-audioliitäntä	Kyllä
TF-audioliitäntä	Kyllä
Äänenvoimakkuuden säätö	Kyllä
Akku	Ion-Li 6000mAh
Akun kesto	7 tuntia*
Vedenkestävyystaso	IPX5

* valoilla

11 tuntia 50 %:n äänenvoimakkuudella

7 tuntia 70 %:n äänenvoimakkuudella

4 tuntia 100 %:n äänenvoimakkuudella

ilman valoja

30 tuntia 50 %:n äänenvoimakkuudella

20 tuntia 70 %:n äänenvoimakkuudella

7 tuntia 100 %:n äänenvoimakkuudella

Akun takuu

Akku on kulutustavara ja sellaisenaan sillä on 12 kuukauden takuu.



Jos joudut tulevaisuudessa hävittämään tämän tuotteen, huomaa, että:

Sähköjätettä ei tule hävittää talousjätteiden mukana. Kierrätä viemällä asianmukaisin paikkoihin.

Kysy neuvoja paikalliselta viranomaiselta tai jälleenmyyjältä.



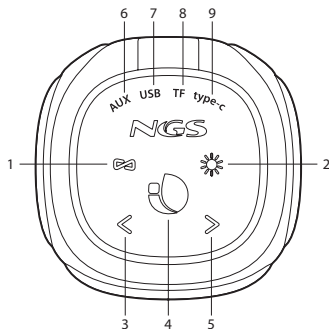

(Sähkö- ja elektroniikkaromudirektiivi)

KONTROLLKNAPPAR

- 1 Humörsknapp / TWS**
Kort tryckning: TWS / Lång tryckning: Ändra läge
- 2 Ljusknapp**
Klicka för att byta ljus / Lång tryckning för att slå på / av lampan
Tryck två gånger för att koppla bort Bluetooth-enheten
- 3 Volym - / Föregående låt**
Tryck och släpp för att flytta till föregående låt/radiostation
Tryck och håll ned för att minska volymen
- 4 Spela / pausa knappen**
Kort tryckning: spela / pausa / Lång tryckning för att slå på / av
/ FM-läge: Tryck två gånger för att söka efter programmet
- 5 Volym + / Nästa låt**
Tryck och släpp för att gå vidare till nästa låt/radiostation
Tryck och håll ned för att öka volymen
- 6 AUX-gränssnitt**
- 7 USB-gränssnitt**
- 8 TF-gränssnitt för kort**
- 9 Typ-C-gränssnitt**
USB typ-C laddningsport









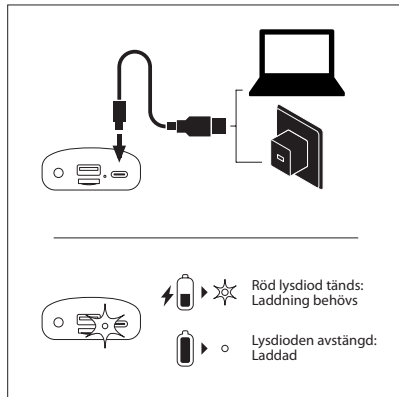

BLUETOOTH-LÄGE









<p>1</p>  <p>Håll knappen intryckt för 3 sekunder för att slå på högtalaren</p>	<p>2</p>  <p>Lysdioden blinkar eftersom högtalaren är i sökningsläge</p>
<p>3</p>  <p>Sök efter "NGS Roller Beast" i Bluetooth-alternativen på den mobila enheten</p>	<p>4</p>  <p>Fast lysdiod: ansluten</p>

HUR LADDAR MAN?











TWS



<p>1</p> 	<p>2</p> 
<p>1</p>  <p>Håll intryckt för 3 sekunder för att slå på högtalarna</p>	<p>1</p>  <p>Håll intryckt för 3 sekunder för att slå på högtalarna</p>
<p>2</p>   <p>Tryck två gånger på * -knappen på båda högtalarna för att koppla bort dem och placera dem i sökningsläge</p>	<p>2</p>   <p>Tryck två gånger på * -knappen på båda högtalarna för att koppla bort dem och placera dem i sökningsläge</p>



<p>3</p>  <p>Tryck på TWS-knappen för att para ihop dem</p>	<p>3</p>  <p>Tryck på TWS-knappen för att para ihop dem</p>
<p>4</p>  <p>"Beep"</p> <p>Du kommer att höra ett pipande ljud på båda högtalarna</p>	<p>4</p>  <p>"Beep"</p> <p>Du kommer att höra ett pipande ljud på båda högtalarna</p>
<p>5</p>   <p>Lysdioden på den första högtalaren förblir fast och den andra blinkar</p>	<p>5</p>   <p>Lysdioden på den första högtalaren förblir fast och den andra blinkar</p>

RADIO-LÄGE

<p>6</p>  <p>Sök i Bluetooth-alternativen på den mobila enheten efter "NGS Rulldjur"</p>	 
---	--

<p>1</p>   3s	<p>2</p>  2s	<p>3</p>  kanalsökning  x2
--	--	--

<p>1</p> 	<p>2</p> 
 x1	<p>Tryck på TWS-knappen igen för att avsluta TWS-läget</p>

<p>4</p> <p>kanal -</p> 	<p>kanal +</p>  <p>Obs: Anslut USB C-kabeln för en bättre radiosignal</p>
---	--

USB/TF-LÄGE

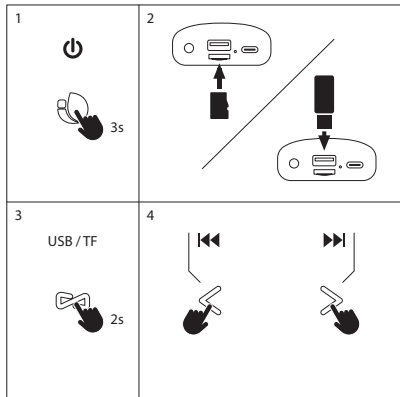

AUX IN-LÄGE

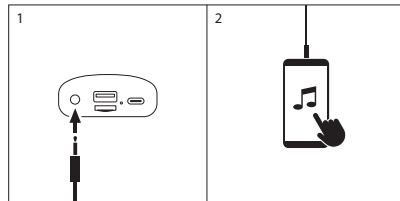

TEKNISKA SPECIFIKATIONER

Kompatibel med bluetooth 5.0	Ja
TWS (få dubbla kraftanslutningar av två högtalare samtidigt utan kablar)	Ja
Toppeffekt	32W
RMS	16W
AUX-ljudingång	Ja
USB-ljudingång	Ja
TF-ljudingång	Ja
Volymkontroll	Ja
Batteri	Ion-Li 6000mAh
Batteriets brukstid	7 timmar*
Vattentät på nivå	IPX5

* med ljus

11 timmar med 50 % volym

7 timmar med 70 % volym

4 timmar med 100 % volym

utan ljus

30 timmar med 50 % volym

20 timmar med 70 % volym

7 timmar med 100 % volym

Batterigaranti

Batteriet är en konsumentprodukt och har en garanti på 12 månader.



Om du vid något framtida tillfälle skulle vilja kassera produkten, vänligen notera att:

Elektriskt avfall bör ej kasseras tillsammans med hushållsavfall. Vänligen använd återvinningsstation för detta.



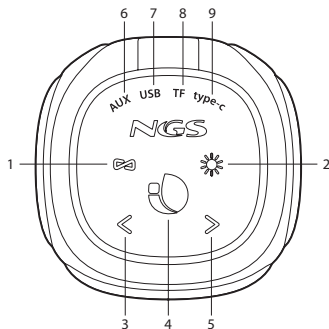

Du kan vända dig till ditt lokala ombud eller återförsäljare för att få råd om återvinning. (Råd gällande elektriskt avfall och elektronisk utrustning)

KONTROLKNAPPER

- 1 Mode -knap / TWS**
Kort tryk: TWS / langt tryk: Ændring af tilstand
- 2 Lys knap**
Klik for at skifte lys / Langt tryk for at tænde / slukke lyset
Tryk to gange for at ophæve parringen af Bluetooth-enheden
- 3 Lydstyrke - / Forrige sang**
Tryk og slip for at flytte til forrige nummer/radiostation
Tryk og hold nede for at reducere lydstyrken
- 4 Afspil / pause -knap**
Kort tryk: afspil / pause / Langt tryk for at tænde / slukke
/ FM -tilstand: Tryk to gange for at søge efter programmet
- 5 Lydstyrke + / Næste sang**
Tryk og slip for at flytte til næste nummer/radiostation
Tryk og hold nede for at øge lydstyrken
- 6 AUX -interface**
- 7 USB -interface**
- 8 TF -kort interface**
- 9 Type-C interface**
USB type-C opladningsport



BLUETOOTH-PROGRAM





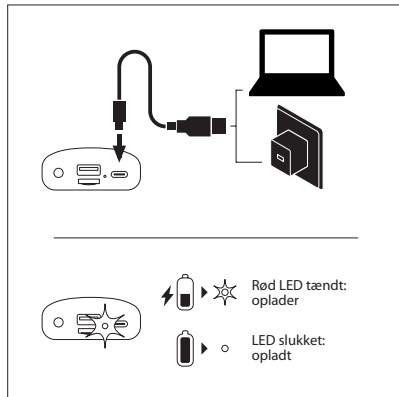









<p>1</p>  <p>Tryk og hold knappen nede i 3 sekunder for at tænde højttaleren</p>	<p>2</p>  <p>LED'en blinker, fordi højttaleren er i søgetilstand</p>
<p>3</p>  <p>Søg efter "NGS Roller Beast" i Bluetooth-indstillingerne på den mobile enhed</p>	<p>4</p>  <p>Konstant LED: tilsluttet</p>









HVORDAN LADER DU OP?





BRUGERVEJLEDNING







TWS





1 	2 
1   3s Tryk og hold nede i 3 sekunder for at tænde højttalerne	1   3s Tryk og hold nede i 3 sekunder for at tænde højttalerne
2   x2  ○  0.5s Tryk to gange på * -knappen på begge højttalere for at ophæve parringen og placere dem i søgetilstand	2   x2  ○  0.5s Tryk to gange på * -knappen på begge højttalere for at ophæve parringen og placere dem i søgetilstand



3  x1 Tryk på TWS-knappen for at parre dem	3  x1 Tryk på TWS-knappen for at parre dem
4  "Beep" Du vil høre en biplyd på begge højttalere	4  "Beep" Du vil høre en biplyd på begge højttalere
5   LED'en på den første højttaler forbliver konstant, og den anden blinker	5  ○   LED'en på den første højttaler forbliver konstant, og den anden blinker

RADIO-PROGRAM

<p>6</p>  <p>Søg i Bluetooth-indstillingerne på den mobile enhed efter "NGS Roller Beast"</p>	
--	---

<p>1</p>   3s	<p>2</p>   2s	<p>3</p>  <p>kanalsøgning</p>  x2
---	---	---

<p>1</p> 		<p>x1</p> 	<p>2</p> 
<p>Tryk på TWS-knappen igen for at afslutte TWS-tilstand</p>			

<p>4</p> <p>kanal -</p> 	<p>kanal +</p> 
<p>Bemærk: Tilslut USB C-kablet for et bedre radiosignal</p>	

USB/TF-PROGRAM

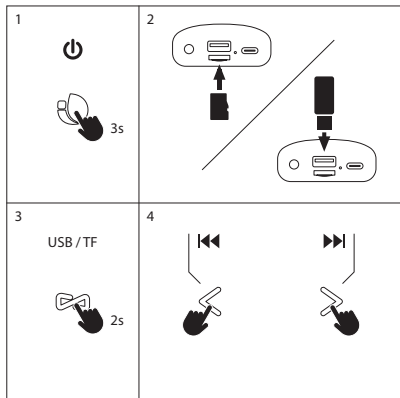

AUX IN-PROGRAM

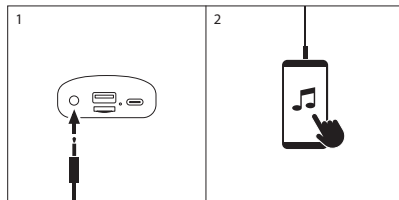

TEKNISKE SPECIFIKATIONER

Kompatibel med bluetooth 5.0	Ja
TWS (få dobbelt strømforbindelse mellem 2 højtalere på samme tid uden kabler)	Ja
Output spidseffekt	32W
RMS	16W
AUX lydindgang	Ja
USB -lydindgang	Ja
TF -lydindgang	Ja
Kontrol af volumen	Ja
Batteri	Ion-Li 6000mAh
Batterilevetid	7 timer*
Vandafvisende til niveau	IPX5

* med lys

11 timer ved 50% volumen

7 timer ved 70% volumen

4 timer ved 100% volumen

uden lys

30 timer ved 50% volumen

20 timer ved 70% volumen

7 timer ved 100% volumen

Batteriets garanti

Batteriet er et forbrugerprodukt, og som sådan er der en garanti på 12 måneder.



Hvis du på hvilket som helst tidspunkt i fremtiden skulle have brug for at bortskaffe dette produkt, skal du være opmærksom på at:

Bortskaffelse af elektriske produkter og batterier må ikke se med almindeligt husholdningsaffald.

Aflever venligst på genbrugsstationen, når det er muligt.

Tjek med din lokale kommune eller forhandler for gode råd om genbrug.



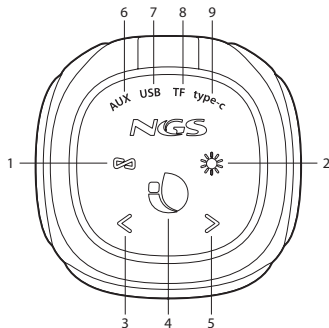

(Direktivet for bortskaffelse af affald med elektrisk og elektronisk udstyr).

VALDYMO MYGTUKAI

- 1 Režimo mygtukas / TWS**
Trumpas paspaudimas: TWS / Ilgas paspaudimas: Režimo keitimas
- 2 Mygtukas Šviesa**
Spustelėkite, jei norite perjungti šviesą / Ilgai paspauskite, kad įjungtumėte / išjungtumėte šviesą
Paspauskite du kartus, kad atsietumėte "Bluetooth" įrenginį
- 3 Garsas - / Ankstesnė daina**
Paspauskite ir atleiskite norėdami pereiti į ankstesnį takelį / radijo stotį
Paspauskite ir palaikykite, kad sumažintumėte garsumą
- 4 Mygtukas Leisti / pristabdyti**
Trumpas paspaudimas: groti / pristabdyti / Ilgai paspauskite, kad įjungtumėte/išjungtumėte
FM režimu: Paspauskite du kartus, kad ieškotumėte programos
- 5 Garsas + / Kita daina**
Paspauskite ir atleiskite norėdami pereiti į kitą takelį / radijo stotį
Paspauskite ir palaikykite, kad padidintumėte garsumą
- 6 AUX sąsaja**
- 7 USB sąsaja**
- 8 TF kortelės sąsaja**
- 9 C tipo sąsaja**
C tipo USB įkrovimo prievadas



“BLUETOOTH” REŽIMAS





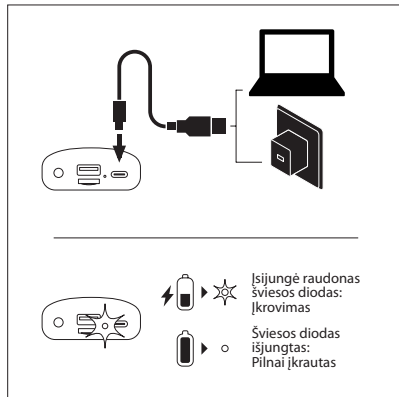









<p>1</p>  <p>Paspauskite ir palaikykite mygtuką 3 sekundes, kad įjungtumėte garsiakalbį</p>	<p>2</p>  <p>Šviesos diodas mirksės, kai garsiakalbis veikia paieškos režimu</p>
<p>3</p>  <p>Ieškokite “NGS Roller Beast” mobiliojo įrenginio “Bluetooth” parinktyse</p>	<p>4</p>  <p>Fiksuotas šviesos diodas: prijungtas</p>









KAIP ĮKRAUTI?





VARTOTOJO INSTRUKCIJA





TWS





1			2	
1	  3s		  3s	
Paspauskite ir palaikykite 3 sekundes, kad įjungtumėte garsiakalbius				
2	  x2		  x2	
 ○  0.5s		 ○  0.5s		
Du kartus paspauskite * mygtuką abiejuose garsiakalbiuose, kad juos atsietumėte ir įdėtumėte į paieškos režimą				



3	 x1	 x1
Paspauskite mygtuką TWS, kad juos susietumėte		
4	 "Beep"	 "Beep"
Abiejuose garsiakalbiuose išgirsite pypsėjimo garsą		
5	 	 ○  
LED ant pirmojo garsiakalbio liks fiksuotas, o kitas mirksės		

“RADIO” REŽIMAS

<p>6</p>  <p>NGS Roller Beast</p> <p>Mobilijame įrenginyje ieškokite “Bluetooth” parinkčių “NGS roller Beast”</p>	 
--	--

<p>1</p>   3s	<p>2</p>  2s	<p>3</p>  kanalo paieška  x2
--	--	--

<p>1</p> 		<p>2</p> 
 x1 Dar kartą paspauskite mygtuką TWS, kad išeitumėte iš TWS režimo		

<p>4</p> <p>kanalas –</p> 	<p>kanalas +</p> 
---	---

Pastaba: prijunkite USB C kabelį geresniam radijo signalui

“USB/TF” REŽIMAS

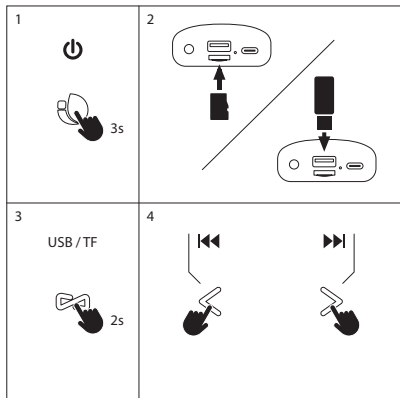

“AUX IN” REŽIMAS

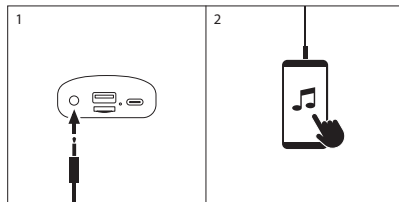

TECHNINĖS SPECIFIKACIJOS

Suderinamas su "Bluetooth" 5,0 TWS (gaukite dvigubą galingumą, sujungdami 2 garsiakalbius tuo pačiu metu be laidų)	taip
Išėjimo didžiausioji galia	32W
RMS	16W
AUX garso įvestis	taip
USB garso įvestis	taip
TF garso įvestis	taip
Garsumo valdymas	taip
Baterija	Ion-Li 6000mAh
Baterijos veikimas	7 valandos *
Atsparus vandeniui	IPX5

- * su šviesomis
- 11 valandos 50% garsumu
 - 7 valandos 70% garsumu
 - 4 valandos 100% garsumu
- be šviesų
- 30 valandos 50% garsumu
 - 20 valandos 70% garsumu
 - 7 valandos 100% garsumu

Baterijos garantija

Baterija yra plataus vartojimo gaminys, todėl jai suteikiama 12 mėnesių garantija.



Jei ateityje turėsite išmesti šį gaminį, atkreipkite dėmesį, kad:

Elektrinių gaminių atliekos neturėtų būti šalinamos kartu su buitinėmis atliekomis. Jei įmanoma, perdirbkite.

Kreipkitės į vietinę valdžios instituciją ar pardavėją dėl perdirbimo patarimų.

(Elektrinės ir elektroninės įrangos atliekų direktyva)

**DECLARATION OF CONFORMITY
DECLARACIÓN DE CONFORMIDAD**



WE, AUTHORIZED REPRESENTATIVE, **LURBE GRUP S.A.**, SAN SEBASTIÁN, SPAIN, DECLARE UNDER OUR SOLE RESPONSIBILITY THAT THE FOLLOWING PRODUCT:

LURBE GRUP S.A., SAN SEBASTIÁN, ESPAÑA, DECLARA BAJO SU EXCLUSIVA RESPONSABILIDAD LA CONFORMIDAD DEL PRODUCTO:

NGS: **BLUETOOTH SPEAKER NGS** / MODEL: **ROLLER BEAST**

NGS: **ALTAVOZ BLUETOOTH NGS** / MODELO: **ROLLER BEAST**

HAS BEEN TESTED AND FOUND IN CONFORMITY WITH THE FOLLOWING HARMONIZED EUROPEAN STANDARDS:

HA SIDO TESTADO EN CONFORMIDAD CON LAS SIGUIENTES NORMAS STANDARD EUROPEAS ARMONIZADAS:

ETSI EN 301 489-1 V 2.1.1 (2017-02)	IEC 62321-4:2013
ETSI EN 301 489-17 V 3.1.1 (2017-02)	IEC 62321-5:2013
ETSI EN 300 328 V 2.1.1 (2016-11)	IEC 62321-7-1:2015
ETSI EN 303 345 V 1.1.7 (2017-03)	IEC 62321-7-2:2017
EN 62479: 2010	IEC 62321-6:2015
EN 60065: 2014	

AND THEREFORE COMPLY WITH THE ESSENTIAL REQUIREMENTS AND PROVISIONS OF THE FOLLOWING DIRECTIVES OF THE EUROPEAN PARLIAMENT AND EUROPEAN COUNCIL:

Y, POR LO TANTO, CUMPLE CON LOS REQUERIMIENTOS Y PROVISIONES DE LAS SIGUIENTES DIRECTIVAS DEL PARLAMENTO EUROPEO:

RADIO EQUIPMENT DIRECTIVE 2014/53/EU
ROHS DIRECTIVE 2011/65/EU & (EU) 2015/863

DIRECTIVA DE EQUIPOS DE RADIO 2014/53/EU
DIRECTIVA ROHS 2011/65/EU & (EU) 2015/863

AUTHORIZED REPRESENTATIVE: **LURBE GRUP S.A**
REPRESENTANTE AUTORIZADO: **PORTUETXE 27**
20018 SAN SEBASTIÁN (GUIPÚZCOA)
SPAIN

SAN SEBASTIÁN, JULY 13TH, 2022
SAN SEBASTIÁN, 13 DE JULIO DE 2022

SIGNED
FIRMADO

RAÚL MARTÍN
PRODUCT MANAGER

**EN
ES**

**DÉCLARATION DE CONFORMITÉ
DECLARAÇÃO DE CONFORMIDADE**



LURBE GRUP S.A, SAN SEBASTIÁN, ESPAGNE, SOUS SA RESPONSABILITÉ EXCLUSIVE, CERTIFIE LA CONFORMITÉ DU PRODUIT :
LURBE GRUP S.A, SAN SEBASTIÁN, ESPAÑA, DECLARA SOB A SUA EXCLUSIVA RESPONSABILIDADE A CONFORMIDADE DO PRODUTO:

NGS : HAUT-PARLEUR BLUETOOTH NGS / MODÈLE : ROLLER BEAST
NGS: ALTO-FALANTE BLUETOOTH NGS / MODELO: ROLLER BEAST

A ÉTÉ TESTÉ CONFORMÉMENT AUX NORMES STANDARD EUROPÉENNES HARMONISÉES SUIVANTES :
FOI TESTADO EM CONFORMIDADE COM AS SEGUINTE NORMAS STANDARD EUROPEIAS HARMONIZADAS:

ETSI EN 301 489-1 V 2.1.1 (2017-02)	IEC 62321-4:2013
ETSI EN 301 489-17 V 3.1.1 (2017-02)	IEC 62321-5:2013
ETSI EN 300 328 V 2.1.1 (2016-11)	IEC 62321-7-1:2015
ETSI EN 303 345 V 1.1.7 (2017-03)	IEC 62321-7-2:2017
EN 62479: 2010	IEC 62321-6:2015
EN 60065: 2014	

ET RESPECTE DONC LES EXIGENCES ET LES DISPOSITIONS DES DIRECTIVES SUIVANTES DU PARLEMENT EUROPÉEN :
E, POR CONSEQUINTE, CUMPRE COM OS REQUISITOS E PROVISÕES DAS SEGUINTE DIRECTIVAS DO PARLAMENTO EUROPEU:

DIRECTIVE SUR LES ÉQUIPEMENTS RADIO 2014/53/EU
DIRECTIVE ROHS 2011/65/EU & (EU) 2015/863
DIRECTIVA RELATIVA AOS EQUIPAMENTOS DE RÁDIO 2014/53/EU
DIRECTIVA ROHS 2011/65/EU & (EU) 2015/863

REPRÉSENTANT AUTORISÉ : LURBE GRUP S.A
REPRESENTANTE AUTORIZADO: PORTUETXE 27
20018 SAN SEBASTIÁN (GUIPÚZCOA)
SPAIN

SAN SEBASTIÁN, LE 13 JUILLET 2022
SAN SEBASTIÁN, 13 DE JULHO DE 2022

SIGNÉ
ASSINADO

RAÚL MARTÍN
PRODUCT MANAGER

FR
PT



technical support: www.ngs.eu/support

www.ngs.eu