

# NETGEAR®

## User Manual

---

# Insight Managed WiFi 6 AX1800 Dual Band Access Point

## Models

WAX610, indoor model

WAX610Y, outdoor model

October 2020  
202-12099-02

**NETGEAR, Inc.**  
350 E. Plumeria Drive  
San Jose, CA 95134, USA

## **Support and Community**

Visit [netgear.com/support](https://netgear.com/support) to get your questions answered and access the latest downloads.

You can also check out our NETGEAR Community for helpful advice at [community.netgear.com](https://community.netgear.com).

## **Regulatory and Legal**

Si ce produit est vendu au Canada, vous pouvez accéder à ce document en français canadien à <https://www.netgear.com/support/download/>.

(If this product is sold in Canada, you can access this document in Canadian French at <https://www.netgear.com/support/download/>.)

For regulatory compliance information including the EU Declaration of Conformity, visit <https://www.netgear.com/about/regulatory/>.

See the regulatory compliance document before connecting the power supply.

For NETGEAR's Privacy Policy, visit <https://www.netgear.com/about/privacy-policy>.

By using this device, you are agreeing to NETGEAR's Terms and Conditions at <https://www.netgear.com/about/terms-and-conditions>. If you do not agree, return the device to your place of purchase within your return period.

Do not use model WAX610 outdoors. The PoE port of model WAX610 is intended for intra building connection only.

## **Trademarks**

© NETGEAR, Inc., NETGEAR, and the NETGEAR Logo are trademarks of NETGEAR, Inc. Any non-NETGEAR trademarks are used for reference purposes only.

## **Revision History**

Publication Part Number	Publish Date	Comments
202-12099-02	October 2020	We removed the following section: Enable or disable Secure Shell.
202-12099-01	August 2020	We added model WAX610Y, which is an outdoor model.
202-12098-01	July 2020	First publication.

# Contents

## Chapter 1 Introduction

- About NETGEAR Insight.....9
- Additional documentation.....9

## Chapter 2 Hardware Overview Indoor Model WAX610

- Unpack indoor model WAX610.....11
- Top panel with LEDs, indoor model WAX610.....11
- Hardware interfaces indoor model WAX610.....14
- Product label indoor model WAX610.....15
- Safety instructions and warnings for an indoor access point.....16

## Chapter 3 Hardware Overview Outdoor Model WAX610Y

- Unpack model outdoor model WAX610Y.....19
- Side panel with LEDs, outdoor model WAX610Y.....19
- Hardware interfaces outdoor model WAX610Y.....21
- Product label outdoor model WAX610Y.....22
- Safety instructions and warnings for an outdoor access point.....23

## Chapter 4 Install the Access Point in Your Network and Access It for Initial Configuration

- Position your access point for best performance.....26
- Set up and connect the access point to your network.....27
  - Set up and connect indoor model WAX610 to your network...27
  - Set up and connect outdoor model WAX610Y to your network.....28
- Connect to the access point for initial configuration.....30
  - Connect over WiFi using the NETGEAR Insight app.....31
  - Connect over the Internet using the NETGEAR Insight Cloud portal.....32
  - Connect over WiFi to the local browser UI for initial configuration.....33
  - Connect over the LAN to the local browser UI for initial configuration.....37
- Configure indoor model WAX610 offline using a directly connected computer.....42
- Log in to the access point after initial setup.....46

## **Chapter 5 Install the Access Point in an Insight Instant Mesh WiFi Network**

What are a root access point and an extender access point?.....	50
What is an Insight Instant Mesh WiFi network?.....	52
Requirements for placing an extender access point in a mesh WiFi network.....	53
Install the NETGEAR Insight app to manage an Insight Instant Mesh WiFi network.....	54
Connect the access point as an extender to a root access point..	54
Connect over the Internet using the NETGEAR Insight Cloud portal.....	58

## **Chapter 6 Manage the Basic WiFi Features**

Set up an open or secure WiFi network.....	60
View or change the settings of a WiFi network.....	67
Disable or enable a WiFi network or set up a WiFi activity schedule.....	68
Remove a WiFi network.....	70
Change the authentication and encryption for a WiFi network....	70
Hide or broadcast the SSID for a WiFi network.....	74
Enable or disable client isolation for a WiFi network.....	75
Enable or disable band steering with 802.11k RRM and 802.11v WiFi network management.....	76
Change the VLAN ID for a WiFi network.....	78
Enable or disable PMF for a WiFi network.....	79
Enable or disable URL tracking for a WiFi network.....	80
Change the format of the DHCP offer messages in a WiFi network.....	81
Select a MAC ACL for a WiFi network.....	82
Set bandwidth rate limits for a WiFi network.....	84

## **Chapter 7 Manage the Basic Radio Features**

Manage the basic WiFi settings for the radios.....	87
Turn a radio on or off.....	90
Change the WiFi mode for a radio.....	91
Change the channel width for a radio.....	93
Change the guard interval for a radio.....	95
Change the output power for a radio.....	96
Change the channel for a radio.....	97
Manage Quality of Service for a WiFi radio.....	98

## **Chapter 8 Set Up and Manage a Captive Portal**

Set up a click-through captive portal for a WiFi network.....	101
---	-----

Set up an external captive portal for a WiFi network.....	104
Register and configure Facebook Wi-Fi for the access point.....	107
Set up a Facebook Wi-Fi captive portal for a WiFi network.....	110
Unregister the access point from Facebook Wi-Fi.....	111

## **Chapter 9 Manage Access and Security**

Block specific URLs and keywords for Internet access.....	114
Manage user accounts.....	116
Add a user account.....	116
Change the time-out period for a user session.....	117
Change the settings for a user account.....	118
Remove a user account.....	119
Manage local MAC access control lists.....	120
Manually set up a MAC access control List.....	121
Import an existing MAC access control list.....	124
Manage neighbor AP detection.....	127
Enable neighbor access point detection and move access points to the Known AP List.....	128
Import an existing neighbor access point list in the Known AP List.....	130
Set up RADIUS servers.....	133

## **Chapter 10 Manage the Local Area Network and IP Settings**

Disable the DHCP client and specify a fixed IP address.....	137
Enable the DHCP client.....	138
Set the 802.1Q VLAN and management VLAN.....	140
Specify an existing domain name.....	141
Enable or disable Spanning Tree Protocol.....	143
Enable or disable the network integrity check function.....	144
Enable or disable IGMP snooping.....	145
Enable or disable Ethernet LLDP.....	146
Enable or disable UPnP.....	147

## **Chapter 11 Manage and Maintain the Access Point**

Change the management mode to NETGEAR Insight or Web-browser.....	150
Change the country or region of operation.....	152
Change the admin user account password.....	153
Change the system name.....	154
Specify a custom NTP server.....	155
Set the time zone.....	156
Manage the syslog settings.....	157
Manage the firmware of the access point.....	158
Check for new firmware and upgrade the access point.....	159

Manually download firmware and upgrade the access point.....	160
Revert to the backup firmware.....	162
Use an SFTP server to upgrade the access point.....	163
Manage the configuration file of the access point.....	164
Back up the access point configuration.....	164
Restore the access point configuration.....	166
Reboot the access point from the local browser UI.....	167
Schedule the access point to reboot.....	168
Return the access point to its factory default settings.....	169
Use the Reset button to reset indoor model WAX610.....	170
Use the Reset button to reset outdoor model WAX610Y.....	171
Use the local browser UI to reset the access point.....	172
Enable SNMP and manage the SNMP settings.....	173
Manage the LEDs.....	174

## **Chapter 12 Monitor the Access Point and the Network**

View the access point Internet, IP, and system settings.....	177
View the WiFi radio settings.....	180
View unknown and known neighbor access points.....	183
View client distribution, connected clients, and client trends....	185
View WiFi and Ethernet traffic, traffic and ARP statistics, and channel utilization.....	188
View or download tracked URLs.....	190
View, save, download, or clear the logs.....	192
View a WiFi bridge connection.....	194
View alarms and notifications.....	195

## **Chapter 13 Set up a WiFi Bridge**

WiFi base station, WiFi repeater, and WiFi bridge requirements.....	198
Set up a WiFi bridge between access points.....	199

## **Chapter 14 Manage the Advanced Radio Features**

Manage the advanced WiFi settings for the radios.....	203
Manage the maximum number of clients for a radio.....	206
Manage the broadcast and multicast settings for a radio.....	207
Manage sticky clients.....	209
Manage load balancing for the radios.....	210
Manage the ARP proxy.....	213
Manage the amount of broadcast traffic.....	214

## **Chapter 15 Diagnostics and Troubleshooting**

Perform a ping test.....	217
Check the Internet speed.....	218
Quick tips for WiFi troubleshooting.....	219

Troubleshoot with the LEDs.....	220
Power/Cloud LED remains off.....	221
Power/Cloud LED remains solid amber.....	222
Power/Cloud LED is blinking amber slowly, continuously.....	222
The access point functions as a PoE PD and the Power/Cloud LED remains solid amber.....	223
Power/Cloud LED does not light blue in the NETGEAR Insight management mode.....	223
Power/Cloud LED does not stop blinking amber, green, and blue.....	224
2.4G or 5G WLAN LED is off.....	225
The extender access point and root access point cannot connect.....	225
Troubleshoot WiFi connectivity.....	227
Troubleshoot Internet browsing.....	228
You cannot log in to the access point over a LAN connection....	228
Changes are not saved.....	229
You enter the wrong password and can no longer log in to the access point.....	229
Troubleshoot your network using the ping utility.....	230
Test the LAN path to your access point.....	231
Test the path from your computer to a remote device.....	231

**Appendix A Mount Indoor Model WAX610 to a Wall or Ceiling**

Mount indoor model WAX610 to a wall.....	234
Mount indoor model WAX610 to a solid ceiling.....	235
Mount indoor model WAX610 to a T-bar.....	237

**Appendix B Mount Outdoor Model WAX610Y to a Wall or Pole**

Mount outdoor model WAX610Y to a wall.....	241
Mount outdoor model WAX610Y to a pole.....	242

**Appendix C Factory Default Settings and Technical Specifications**

Factory default settings.....	246
Technical specifications indoor model WAX610.....	250
Technical specifications outdoor model WAX610Y.....	252

# 1

## Introduction

---

This manual is for the following NETGEAR Insight Managed WiFi 6 AX1800 Dual Band Access Point models:

- **WAX610.** NETGEAR Insight Managed WiFi 6 AX1800 Dual Band Access Point for indoor use.
- **WAX610Y.** NETGEAR Insight Managed WiFi 6 AX1800 Dual Band Access Point for outdoor use.

Models WAX610 and WAX610Y, in this manual referred to as the access point, support IEEE 802.11ax, four streams of WiFi 6, and dual-band concurrent operation at 2.4 GHz and 5 GHz with a combined throughput of 1800 Mbps (600 Mbps at 2.4 GHz and 1200 Mbps at 5 GHz).

The access point functions as a Power over Ethernet plus (PoE+) powered device (PD) in an existing network connected to a PoE+ switch. Model WAX610 supports an optional power adapter for connection to a regular switch. The PoE+ Ethernet port supports a high speed up to 2.5 Gbps.

This chapter contains the following sections:

- [About NETGEAR Insight](#)
- [Additional documentation](#)

**Note:** For more information about the topics that are covered in this manual, visit the support website at [netgear.com/support/](https://netgear.com/support/).

**Note:** Firmware updates with new features and bug fixes are made available from time to time at [netgear.com/support/download/](https://netgear.com/support/download/). You can check for and download new firmware manually. If the features or behavior of your product does not match what is described in this manual, you might need to update the firmware.

**Note:** In this manual, *WiFi network* means the same as SSID (service set identifier or WiFi network name) or VAP (virtual access point). That is, when we refer to a WiFi network we mean an individual SSID or VAP.



# About NETGEAR Insight

The access point supports the NETGEAR Insight app, which lets you set up and manage the access point from your iOS or Android mobile device and connects to the Insight cloud-based management platform. For Insight Premium or Insight Pro subscribers, the access point also supports the Insight Cloud portal, which is the website that provides access to the Insight cloud-based management platform.

This user manual describes the local browser user interface (UI). For more information about NETGEAR Insight, visit [insight.netgear.com](https://insight.netgear.com) and see the NETGEAR knowledge base at [netgear.com/support/product/insight.aspx](https://netgear.com/support/product/insight.aspx).

If you install the access point as a NETGEAR Insight managed device, the settings for features that you can manage through the Insight app and Insight Cloud portal are masked out in the local browser UI. However, using the local browser UI, you can still manage the settings for certain features that are not yet supported in Insight. For more information, visit the NETGEAR knowledge base at [netgear.com/support/product/insight.aspx](https://netgear.com/support/product/insight.aspx) and search for *What is Hybrid Management Mode*.

## Additional documentation

The following documents are available at [netgear.com/support/download/](https://netgear.com/support/download/):

- Installation guide
- Data sheet

For information about the NETGEAR Insight app and the Insight Cloud portal, visit [insight.netgear.com](https://insight.netgear.com) and see the NETGEAR knowledge base at [netgear.com/support/product/insight.aspx](https://netgear.com/support/product/insight.aspx).

# 2

## Hardware Overview Indoor Model WAX610

---

The NETGEAR Insight Managed WiFi 6 AX1800 Dual Band Access Point Model WAX610 is an *indoor* access point.

The chapter contains the following sections:

- [Unpack indoor model WAX610](#)
- [Top panel with LEDs, indoor model WAX610](#)
- [Hardware interfaces indoor model WAX610](#)
- [Product label indoor model WAX610](#)
- [Safety instructions and warnings for an indoor access point](#)

# Unpack indoor model WAX610

The package contains the following items:

- WAX610 access point
- Mounting bracket with screw holes for mounting to a solid ceiling or 15/16 in. (23.8 mm) T-bar
- Mounting bracket without screw holes for mounting to a 9/16 in. (14.3 mm) T-bar
- Two screws and anchors for ceiling mounting or wall-mounting
- Screw placement guide
- Installation guide

**Note:** Depending on the product ordered, the package might not include a power adapter. You power up the access point by connecting it to a PoE+ switch. If you ordered a package without a power adapter, you can still order a power adapter as an option.

For information about the mounting options, see [Mount Indoor Model WAX610 to a Wall or Ceiling](#) on page 233.

## Top panel with LEDs, indoor model WAX610

The LEDs that provide the status of the access point are located on the top panel of the access point.



Figure 1. Top panel with LEDs, indoor model WAX610

## Insight Managed WiFi 6 AX1800 Dual Band Access Point Models WAX610 and WAX610Y

Table 1. LED descriptions indoor model WAX610





















LED Icon	Color	Description
Power/Cloud LED 		<b>Solid amber initially and then blinking amber slowly.</b> The access point is starting or in the process of getting an IP address.
		<b>Solid green.</b> The access point started up and functions either as a standalone access point or as an Insight discovered access point that is not connected to the Insight cloud-based management platform.
		<b>Solid blue.</b> The access point functions in Insight mode and is connected to the Insight cloud-based management platform.
		<b>Blinking amber fast.</b> The access point is updating firmware or is being reset to factory default settings.
		<b>Blinking multicolor.</b> The access point is functioning in extender mode and the mesh setup is in progress.
		<b>Solid amber during operation.</b> The PoE power that the access point received is not at the 802.3at (PoE+) level.
		<b>Off.</b> No power is supplied to the access point.
LAN LED 		<b>Solid green.</b> A 2.5 Gbps Ethernet link is detected on the LAN port.
		<b>Blinking green.</b> 2.5 Gbps traffic activity is detected on the LAN port.
		<b>Solid amber.</b> An Ethernet link at a speed lower than 2.5 Gbps is detected on the LAN port.
		<b>Blinking amber.</b> Traffic activity at a speed lower than 2.5 Gbps is detected on the LAN port.
		<b>Off.</b> Either no powered-on Ethernet device is connected to the LAN port, or, if a powered-on Ethernet device is connected, no Ethernet link is detected.

Table 1. LED descriptions indoor model WAX610 (Continued)

LED Icon	Color	Description
2.4GHz 2.4G WLAN LED		<b>Solid green.</b> The 2.4 GHz WiFi radio is on but no clients are connected.
		<b>Solid blue.</b> One or more WLAN clients are connected to the 2.4 GHz WiFi radio.
		<b>Blinking blue.</b> Traffic is detected on the 2.4 GHz WiFi radio.
		<b>Off.</b> The 2.4 GHz WiFi radio is off.
5GHz 5G WLAN LED		<b>Solid green.</b> The 5 GHz WiFi radio is on but no clients are connected.
		<b>Solid blue.</b> One or more WLAN clients are connected to the 5 GHz WiFi radio.
		<b>Blinking blue.</b> Traffic is detected on the 5 GHz WiFi radio.
		<b>Off.</b> The 5 GHz WiFi radio is off.

**Note:** For information about troubleshooting with the LEDs, see [Troubleshoot with the LEDs](#) on page 220.

# Hardware interfaces indoor model WAX610

The bottom panel of the access point has a LAN/PoE+ port, **Reset** button, and DC power connector for an optional power adapter.

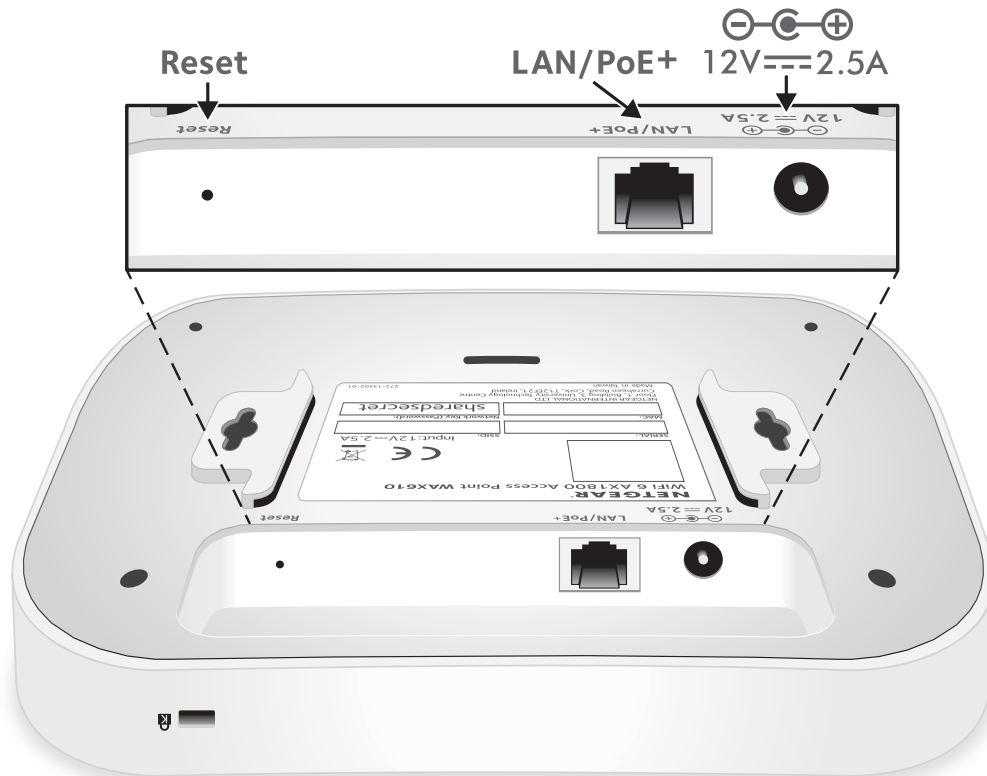

Figure 2. Hardware interfaces of indoor model WAX610

The bottom panel contains the following components:

- **Reset button.** You can use the **Reset** button to restart the access point or to reset the access point to its factory default settings. To restart the access point, press the **Reset** button for about two seconds. Pressing the **Reset** for 10 seconds or longer resets the access point to factory default settings.

**Note:** If you added the access point to a NETGEAR Insight network location, you must first use the Insight app or Insight Cloud portal to remove the access point from your Insight network location before the factory default settings function of the **Reset** button is available. For more information, see [Use the Reset button to reset indoor model WAX610](#) on page 170.

- **LAN/PoE+ port.** You can use the LAN/PoE+ Gigabit Ethernet RJ-45 LAN port to connect the access point to a PoE+ switch, or if you use an optional power adapter, to a non-PoE switch.  
The LAN/PoE+ port supports Ethernet speeds up to 2.5 Gbps when connected to 2.5 Gbps equipment. Your Internet connection, modem, and switch all need to support a speed of 2.5 Gbps. If *one* of these components supports only 1 Gbps (which is a common speed), the access point LAN/PoE+ connection functions at 1 Gbps.  
For more information about the LAN/PoE+ port connection, see [Set up and connect indoor model WAX610 to your network](#) on page 27.
- **DC power connector.** If you do not use a PoE+ switch to provide power to the access point, connect an optional power adapter to the DC power connector.

**Note:** The back panel provides a Kensington lock slot for an optional security cable.

## Product label indoor model WAX610

The product label of the access point shows the QR code, serial number, MAC address, default WiFi network name (SSID), and network key (password) of the access point.

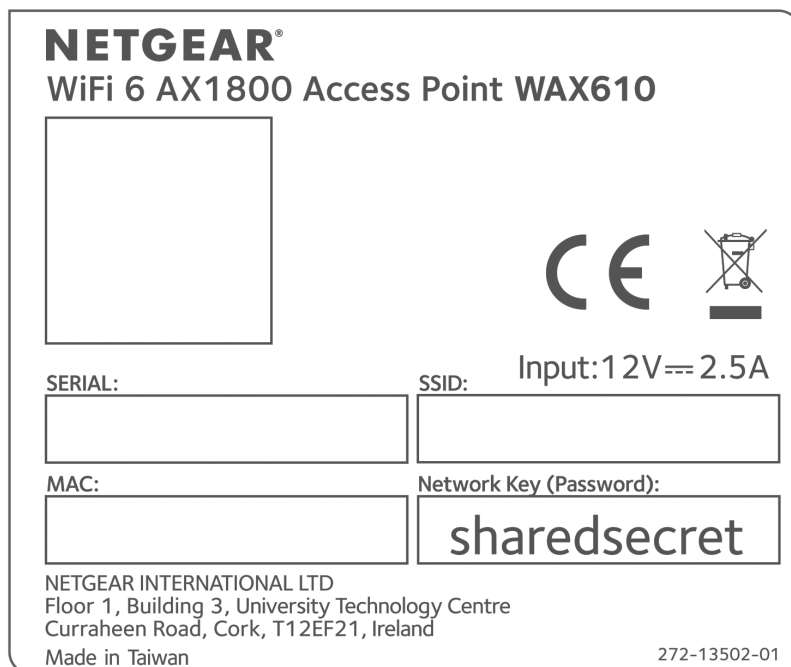

Figure 3. Product label indoor model WAX610

# Safety instructions and warnings for an indoor access point

Use the following safety guidelines to ensure your own personal safety and to help protect your system from potential damage.

To reduce the risk of bodily injury, electrical shock, fire, and damage to the equipment, observe the following precautions:

- This product is designed for indoor use only in a temperature-controlled and humidity-controlled environment. Note the following:
  - For more information about the environment in which this product must operate, see the environmental specifications in the appendix or the data sheet.
  - If you want to connect the product over an Ethernet cable to a device located outdoors, the outdoor device must be properly grounded and surge protected, and you must install an Ethernet surge protector inline between the indoor product and the outdoor device. Failure to do so can damage the product.
  - Before connecting the product to outdoor cables or wired outdoor devices, see <https://kb.netgear.com/000057103> for additional safety and warranty information.

Failure to follow these guidelines can result in damage to your NETGEAR product, which might not be covered by NETGEAR's warranty, to the extent permissible by applicable law.

- Do not service the product except as explained in your product documentation. Some devices should never be opened.
- If any of the following conditions occur, unplug the product from its power source, and then replace the part or contact your trained service provider:
  - Depending on your product, the power adapter, power adapter cable, power adapter plug, or PoE Ethernet cable is damaged.
  - An object fell into the product.
  - The product was exposed to water.
  - The product was dropped or damaged.
  - The product does not operate correctly when you follow the operating instructions.
- Keep the product away from radiators and heat sources. Also, do not block cooling vents.



- Do not spill food or liquids on your product components, and never operate the product in a wet environment. If the product gets wet, see the appropriate section in your troubleshooting guide, or contact your trained service provider.
- Do not push any objects into the openings of your product. Doing so can cause fire or electric shock by shorting out interior components.
- Use the product only with approved equipment.
- If applicable to your product, allow the product to cool before removing covers or touching internal components.
- Be sure that devices that are attached over Ethernet cables are electrically rated to operate with the power available in your location.
- Depending on your product, use only the supplied power adapter or an Ethernet cable that provides PoE.  
If your product uses a power adapter:
  - If you were not provided with a power adapter, contact your local NETGEAR reseller.
  - The power adapter must be rated for the product and for the voltage and current marked on the product electrical ratings label.
- To help prevent electric shock, plug any system and peripheral power cables into properly grounded power outlets.
- If applicable to your product, the peripheral power cables are equipped with three-prong plugs to help ensure proper grounding. Do not use adapter plugs or remove the grounding prong from a cable. If you must use an extension cable, use a three-wire cable with properly grounded plugs.
- Observe extension cable and power strip ratings. Make sure that the total ampere rating of all products plugged into the extension cable or power strip does not exceed 80 percent of the ampere ratings limit for the extension cable or power strip.
- To help protect your system from sudden, transient increases and decreases in electrical power, use a surge suppressor, line conditioner, or uninterruptible power supply (UPS).
- Position system cables, power adapter cables, and PoE Ethernet cables carefully. Route cables so that they cannot be stepped on or tripped over. Be sure that nothing rests on any cables.
- Do not modify power adapters, power adapter cables, or plugs. Consult a licensed electrician or your power company for site modifications.
- Always follow your local and national wiring rules.

# 3

## Hardware Overview Outdoor Model WAX610Y

---

The NETGEAR Insight Managed WiFi 6 AX1800 Dual Band Access Point Model WAX610Y is an *outdoor* access point.

**Terms of Use:** This device must be professionally installed. It is the installer's responsibility to follow local country regulations including operations within legal frequency channels, output power and DFS requirements. Vendor or Reseller or Distributor is not responsible for illegal wireless operations. Please see Device's Terms and Conditions for more details.

The chapter contains the following sections:

- [Unpack model outdoor model WAX610Y](#)
- [Side panel with LEDs, outdoor model WAX610Y](#)
- [Hardware interfaces outdoor model WAX610Y](#)
- [Product label outdoor model WAX610Y](#)
- [Safety instructions and warnings for an outdoor access point](#)

# Unpack model outdoor model WAX610Y

The package contains the following items:

- WAX610Y access point
- Pole mounting strap
- Wall-mount screws and anchors
- Screw placement guide
- Installation guide

**Note:** A power adapter is not supported for this model. You power up the access point by connecting it to a PoE+ switch.

For information about the mounting options, see [Mount Outdoor Model WAX610Y to a Wall or Pole](#) on page 240.

## Side panel with LEDs, outdoor model WAX610Y

The LEDs that provide the status of the access point are located on the right side panel of the access point.

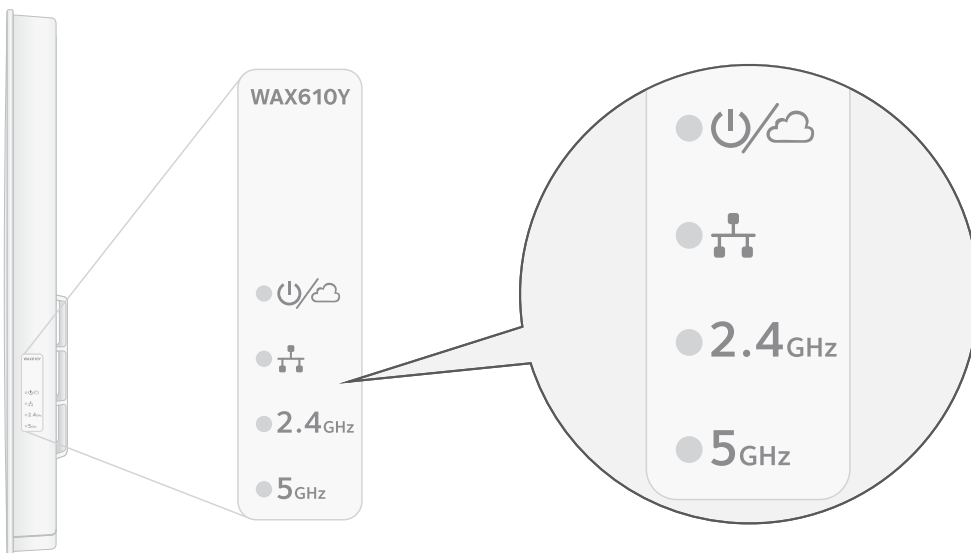

Figure 4. Side panel with LEDs, outdoor model WAX610Y

## Insight Managed WiFi 6 AX1800 Dual Band Access Point Models WAX610 and WAX610Y

Table 2. LED descriptions outdoor model WAX610Y





















LED Icon	Color	Description
Power/Cloud LED 		<b>Solid amber initially and then blinking amber slowly.</b> The access point is starting or in the process of getting an IP address.
		<b>Solid green.</b> The access point started up and functions either as a standalone access point or as an Insight discovered access point that is not connected to the Insight cloud-based management platform.
		<b>Solid blue.</b> The access point functions in Insight mode and is connected to the Insight cloud-based management platform.
		<b>Blinking amber fast.</b> The access point is updating firmware or is being reset to factory default settings.
		<b>Blinking multicolor.</b> The access point is functioning in extender mode and the mesh setup is in progress.
		<b>Solid amber during operation.</b> The PoE power that the access point received is not at the 802.3at (PoE+) level.
LAN LED 		<b>Solid green.</b> A 2.5 Gbps Ethernet link is detected on the LAN port.
		<b>Blinking green.</b> 2.5 Gbps traffic activity is detected on the LAN port.
		<b>Solid amber.</b> An Ethernet link at a speed lower than 2.5 Gbps is detected on the LAN port.
		<b>Blinking amber.</b> Traffic activity at a speed lower than 2.5 Gbps is detected on the LAN port.
	<b>Off.</b> Either no powered-on Ethernet device is connected to the LAN port, or, if a powered-on Ethernet device is connected, no Ethernet link is detected.	
2.4G WLAN LED 		<b>Solid green.</b> The 2.4 GHz WiFi radio is on but no clients are connected.
		<b>Solid blue.</b> One or more WLAN clients are connected to the 2.4 GHz WiFi radio.
		<b>Blinking blue.</b> Traffic is detected on the 2.4 GHz WiFi radio.
	<b>Off.</b> The 2.4 GHz WiFi radio is off.	

Table 2. LED descriptions outdoor model WAX610Y (Continued)

LED Icon	Color	Description
		<b>Solid green.</b> The 5 GHz WiFi radio is on but no clients are connected.
		<b>Solid blue.</b> One or more WLAN clients are connected to the 5 GHz WiFi radio.
		<b>Blinking blue.</b> Traffic is detected on the 5 GHz WiFi radio.
		<b>Off.</b> The 5 GHz WiFi radio is off.

**Note:** For information about troubleshooting with the LEDs, see [Troubleshoot with the LEDs](#) on page 220.

## Hardware interfaces outdoor model WAX610Y

Use the latch on the front of the access point to open the cover. Carefully pull the latch toward you and pull the cover downward so that it slides out of the enclosure. On the bottom panel of the access point, the LAN/PoE+ port and **Reset** button are now accessible.

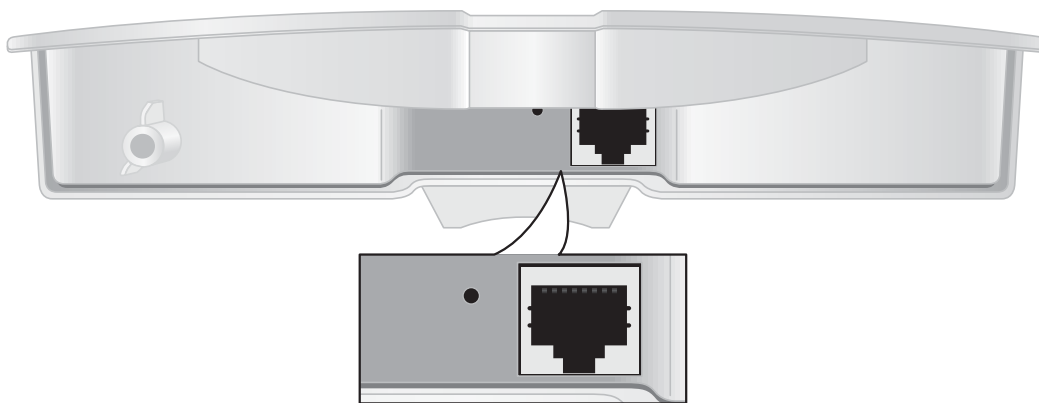

Figure 5. Hardware interfaces outdoor model WAX610Y

**Note:** The access point does not provide a power connector, nor requires a power adapter. You power up the access point only by connecting an Ethernet cable to a PoE+ switch.



# Safety instructions and warnings for an outdoor access point

Use the following safety guidelines to ensure your own personal safety and to help protect your system from potential damage.

To reduce the risk of bodily injury, electrical shock, fire, and damage to the equipment, observe the following precautions:

- This product is designed for outdoor use. Note the following:
  - For information about the environment in which this product must operate, see the environmental specifications in the appendix or the data sheet.
  - If you connect the product over an Ethernet cable to a device located indoors, you must install an Ethernet surge protector inline between the product and the indoor device. Failure to do so can damage the product.
  - Before connecting the product to indoor cables or wired indoor devices, see <https://kb.netgear.com/000057103> for additional safety and warranty information.

Failure to follow these guidelines can result in damage to your NETGEAR product, which might not be covered by NETGEAR's warranty, to the extent permissible by applicable law.

- Do not service the product except as explained in your product documentation. Some devices should never be opened.
- If any of the following conditions occur, unplug the product from its power source, and then replace the part or contact your trained service provider:
  - Depending on your product, the power adapter, power adapter cable, power adapter plug, or PoE Ethernet cable is damaged.
  - An object fell into the product.
  - The product was dropped or damaged.
  - The product does not operate correctly when you follow the operating instructions.
- Operate the product with its cover closed so that moisture and insects cannot get inside the product.
- Make sure that the product is not installed in an area that could be flooded or be subject to a heavy water spray, for example from a hosepipe.
- Keep the product away from heat sources. Do not install the product at a location where it is continuously exposed to direct sunlight. Also, do not block cooling vents.

- Do not paint the product.
- Do not push any objects into the openings of your product. Doing so can cause fire or electric shock by shorting out interior components.
- Use the product only with approved equipment.
- If applicable to your product, allow the product to cool before removing covers or touching internal components.
- Be sure that devices that are attached over Ethernet cables are electrically rated to operate with the power available in your location.
- Depending on your product, use only the supplied power adapter or, if you use PoE, an Ethernet cable on which an inline Ethernet surge protector is installed.  
If your product uses a power adapter:
  - If you were not provided with a power adapter, contact your local NETGEAR reseller.
  - The power adapter must be rated for the product and for the voltage and current marked on the product electrical ratings label.
- To help prevent electric shock, plug any system and peripheral power cables into properly grounded power outlets.
- If applicable to your product, the peripheral power cables are equipped with three-prong plugs to help ensure proper grounding. Do not use adapter plugs or remove the grounding prong from a cable. If you must use an extension cable, use a three-wire cable with properly grounded plugs.
- Observe extension cable and power strip ratings. Make sure that the total ampere rating of all products plugged into the extension cable or power strip does not exceed 80 percent of the ampere ratings limit for the extension cable or power strip.
- To help protect your system from sudden, transient increases and decreases in electrical power, use a surge suppressor, line conditioner, or uninterruptible power supply (UPS).
- Position system cables, power adapter cables, and PoE Ethernet cables carefully. Route cables so that they cannot be stepped on or tripped over. Be sure that nothing rests on any cables.
- Do not modify power adapters, power adapter cables, or plugs. Consult a licensed electrician or your power company for site modifications.
- Always follow your local and national wiring rules.



# 4

## Install the Access Point in Your Network and Access It for Initial Configuration

---

This chapter describes how you can install and access the access point in your network.

The chapter contains the following sections:

- [Position your access point for best performance](#)
- [Set up and connect the access point to your network](#)
- [Connect to the access point for initial configuration](#)
- [Configure indoor model WAX610 offline using a directly connected computer](#)
- [Log in to the access point after initial setup](#)

# Position your access point for best performance

Before you install and mount your access point as described in the installation guide, consider how you can position the access point for best performance.

The access point lets you access your network anywhere within the operating range of your WiFi network. However, the operating distance or range of your WiFi connection can vary significantly depending on the physical placement of your access point. For example, the thickness and number of walls the WiFi signal passes through can limit the range.

Additionally, other WiFi devices in and around your office, home, yard, or campus, might affect your access point's signal. WiFi devices can be other access point, routers, repeaters, WiFi range extenders, and any other devices that emit WiFi signals for network access.

Position your access point according to the following guidelines:

- Place your access point near the center of the area where your computers and other devices operate.  
A line of sight between the access point and your WiFi devices is not required for good performance.
- For model WAX610 only, if you use a power adapter, make sure that the access point is within reach of an AC power outlet.
- Place the access point in an elevated location, minimizing the number walls and ceilings between the access point and your other devices.
- For model WAX610 only, place the access point away from electrical devices such as these:
  - Ceiling fans
  - Home security systems
  - Microwaves
  - Computers
  - Bases of cordless phones
  - 2.4 GHz and 5.8 GHz cordless phones
- Place the access point away from large metal surfaces, large glass surfaces, insulated walls, and items such as these:
  - Solid metal doors

- Aluminum studs
- Fish tanks (indoor model WAX610 only)
- Mirrors (indoor model WAX610 only)
- Brick
- Concrete

If you are using adjacent access points, use different radio frequency channels to reduce interference.

## Set up and connect the access point to your network

The procedure that you use to set up and connect the access point to your network depends on the model.

### Set up and connect indoor model WAX610 to your network

This section applies to indoor model WAX610 only.

You can connect the access point to a Power over Ethernet plus (PoE+) switch in your network. The switch must be connected to a network router that is connected to the Internet. If you use a PoE+ connection, the access point does not require a power adapter.

**Note:** Depending on the product ordered, the package might not include a power adapter. You power up the access point by connecting it to a PoE+ switch. If you ordered a package without a power adapter but do not want to use a PoE+ connection, you can still order a power adapter as an option.

The access point LAN/PoE+ port supports Ethernet speeds up to 2.5 Gbps. The following figure shows a NETGEAR MS510TXPP switch, which supports speeds of 2.5 Gbps and higher and can supply PoE+. To allow for this speed, your Internet connection, modem, and switch all need to support a speed of 2.5 Gbps. If one of these components supports only 1 Gbps (which is a common speed), the LAN connection functions also at 1 Gbps.

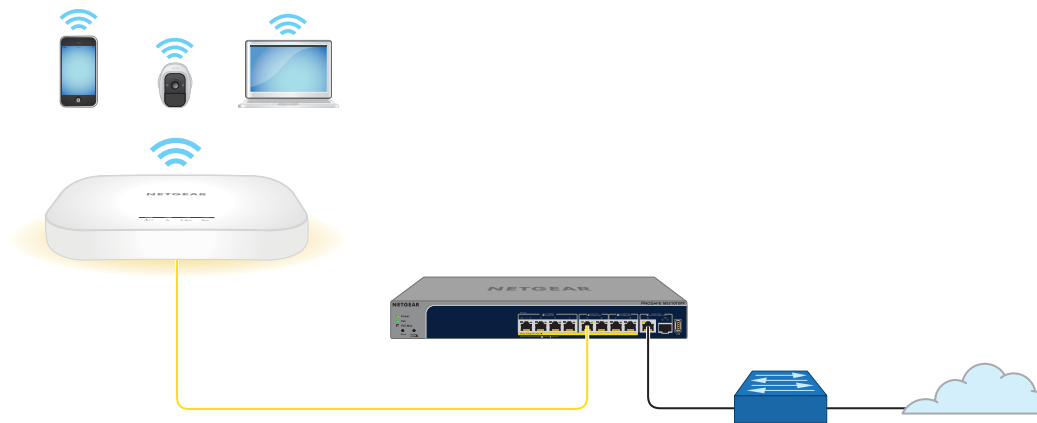

Figure 7. Set up model WAX610 with a PoE+ connection to your network

### To set up the access point with an Ethernet connection to your network:

1. Connect an Ethernet cable to the LAN/PoE+ port on the access point.
2. Connect the other end of the Ethernet cable to a port on a switch that is connected to your network and to the Internet.

If you use a PoE+ connection, the port must be a PoE+ port on a PoE+ switch. The access point requires 802.3at (PoE+) input. For optimal functioning, make sure that you use an 802.3at (PoE+) switch and not an 802.3af (PoE) switch.

While the access point is starting or in the process of getting an IP address from a DHCP server (or router functioning as a DHCP server) in your network, the Power/Cloud LED initially lights solid amber and then blinks amber slowly. After about two minutes, the Power/Cloud LED turns solid green or solid blue and the access point is ready for you to perform the initial configuration.

For information about accessing the access point for initial configuration, see [Connect to the access point for initial configuration](#) on page 30.

## Set up and connect outdoor model WAX610Y to your network

This section applies to outdoor model WAX610Y only.

**Note:** Before you mount the access point at a permanent location outdoors, we recommend that you configure the access point for your network environment and test your setup.

Connect the access point to a Power over Ethernet plus (PoE+) switch in your network. The switch must be connected to a network router that is connected to the Internet. If

you use a PoE+ switch that is located indoors, you must install a PoE+ Ethernet surge protector on the cable from the switch to the access point located outdoors.

**Note:** Model WAX610Y does not provide a power connector, nor requires a power adapter. You power up this model only by connecting an Ethernet cable to a PoE+ switch.

The access point LAN/PoE+ port supports Ethernet speeds up to 2.5 Gbps. The following figure shows a NETGEAR MS510TXPP switch, which supports speeds of 2.5 Gbps and higher and can supply PoE+. To allow for this speed, your Internet connection, modem, and switch all need to support a speed of 2.5 Gbps. If one of these components supports only 1 Gbps (which is a common speed), the LAN connection functions also at 1 Gbps.

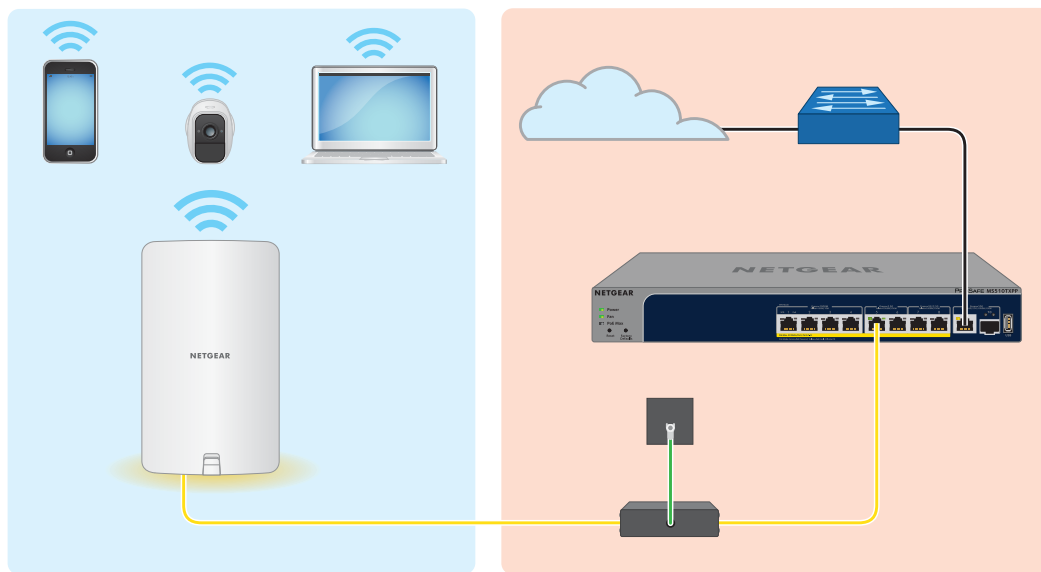

Figure 8. Set up model WAX610Y with a PoE+ connection to your network

### To set up the access point with an Ethernet connection to your network:

1. Use the latch on the front of the access point to open the cover.  
Carefully pull the latch toward you and pull the cover downward so that it slides out of the enclosure. The LAN/PoE+ port is now accessible.
2. Connect an Ethernet cable to the LAN/PoE+ port on the access point.
3. If you use a PoE+ switch that is located indoors, install a PoE+ Ethernet surge protector (not supplied) on the cable from the switch to the access point located outdoors. The previous figure shows such a setup.
4. Connect the other end of the Ethernet cable to a port on a PoE+ switch that is connected to your network and to the Internet.

The access point requires 802.3at (PoE+) input. For optimal functioning, make sure that you use an 802.3at (PoE+) switch and not an 802.3af (PoE) switch.

While the access point is starting or in the process of getting an IP address from a DHCP server (or router functioning as a DHCP server) in your network, the Power/Cloud LED initially lights solid amber and then blinks amber slowly. After about two minutes, the Power/Cloud LED turns solid green or solid blue and the access point is ready for you to perform the initial configuration.

For information about accessing the access point for initial configuration, see [Connect to the access point for initial configuration](#) on page 30.

## Connect to the access point for initial configuration

After you set up the access point, you can use several methods to connect to it for initial configuration.

You can use the NETGEAR Insight app on an iOS or Android mobile device, or use the Insight Cloud portal or the local browser UI.

The Insight app and the Insight Cloud portal provide ease of access and let you configure most features that are available on the access point. The local browser UI lets you configure all features.

For information about using the Insight app or the Insight Cloud portal, see one of the following sections:

- [Connect over WiFi using the NETGEAR Insight app](#) on page 31
- [Connect over the Internet using the NETGEAR Insight Cloud portal](#) on page 32

For information about using the local browser UI, see one of the following sections:

- [Connect over WiFi to the local browser UI for initial configuration](#) on page 33
- [Connect over the LAN to the local browser UI for initial configuration](#) on page 37

**Note:** If your network does not include a DHCP server (or a router that functions as a DHCP server) and you do not perform the initial configuration of the access point as described in one of these sections, you can connect only five clients to the access point and the access point can provide an IP address to only five clients. To prevent this situation, make sure that you perform the initial configuration of the access point.

## Connect over WiFi using the NETGEAR Insight app

You can install the NETGEAR Insight app on an iOS or Android mobile device and set up the access point (and perform many other tasks as well).

**IMPORTANT:** If you add the access point to a NETGEAR Insight network location and manage the access point through the Insight app or Insight Cloud portal, the admin password for the access point changes. That is, the Insight network password for that location replaces the admin password. To access the local browser UI, you must then enter the Insight network password and not the admin password. If you later decide to remove the access point from the Insight network location or change the management mode to Web-browser mode (see [Change the management mode to NETGEAR Insight or Web-browser](#) on page 150), you must continue to use the Insight network password to access the local browser UI until you manually change the admin password on the access point.

For more information about the Insight app, visit [insight.netgear.com](https://insight.netgear.com) and see the NETGEAR knowledge base at [netgear.com/support/product/insight.aspx](https://netgear.com/support/product/insight.aspx).

### To connect to the access point over WiFi using an iOS or Android mobile device:

1. On your mobile device, go to the app store, search for NETGEAR Insight, and download the Insight app.



2. Connect your mobile device to the WiFi network of the access point.  
The default SSID is on the access point label on the bottom of the access point and is shown in the format NETGEARxxxxxx-SETUP, where xxxxxx is the last six hexadecimal digits of the access point's MAC address. The default password is **sharedsecret**.
3. Launch the Insight app.
4. If you do not have a NETGEAR account, tap **Create NETGEAR Account** and follow the onscreen instructions.
5. Enter the email address and password for your account and tap **LOG IN**.  
After you log in to your account, the IP address of the access point displays in the device list.
6. Write down the access point IP address and save it for later use.

7. To use the Insight app to configure and manage the access point, tap the access point and follow the prompts to register the access point and add it to an Insight network location.

## Connect over the Internet using the NETGEAR Insight Cloud portal

The Insight Cloud portal is available for Insight Premium or Insight Pro subscribers. To use the NETGEAR Insight Cloud portal to configure and manage the access point, the access point must already be connected to the Internet.

**IMPORTANT:** If you add the access point to a NETGEAR Insight network location and manage the access point through the Insight app or Insight Cloud portal, the admin password for the access point changes. That is, after you add the access point to an Insight network location, the Insight network password for that location replaces the admin password. To access the local browser UI, you must then enter the Insight network password and not the admin password. If you later decide to remove the access point from the Insight network location or change the management mode to Web-browser mode (see [Change the management mode to NETGEAR Insight or Web-browser](#) on page 150), you must continue to use the Insight network password to access the local browser UI until you manually change the admin password on the access point.

For more information about the Insight Cloud portal and the configuration and management options that are available through the Insight Cloud portal, visit [insight.netgear.com](https://insight.netgear.com) and see the NETGEAR knowledge base at [netgear.com/support/product/insight.aspx](https://netgear.com/support/product/insight.aspx).

### **To connect to the access point over the Internet through the Insight Cloud portal:**

1. Visit [insight.netgear.com](https://insight.netgear.com).  
The NETGEAR Account Login page displays.
2. Enter your Insight email address and password.  
If you do have an Insight account, you can create one.
3. Click the **Login** button.  
You can now add the access point to an Insight network location so that you can configure and manage the access point.



## Connect over WiFi to the local browser UI for initial configuration

This section describes how to connect to the access point for the first time over WiFi using a WiFi-enabled computer or mobile device (without using the NETGEAR Insight app) and complete the initial configuration.

**Note:** The figures in this section show model WAX610. If you use model WAX610Y, the local browser UI shows model WAX610Y.

### To connect over WiFi to the local browser UI for initial configuration:

1. From your computer or mobile device, connect over WiFi to the access point's default WiFi network.

The default SSID is on the access point label on the bottom of the access point and is shown in the format NETGEARxxxxxx-SETUP, where xxxxxx is the last six hexadecimal digits of the access point's MAC address. The default password is **sharedsecret**.

2. On the computer or mobile device, launch a web browser and, in the address bar, enter **http://aplogin.net**.

**Note:** You can use **http://aplogin.net** only during initial setup of the access point.



**IMPORTANT:** If your browser does not display the Day Zero login page, see the following step.

3. If your browser displays a security message and does not let you proceed, do one of the following:
  - **Google Chrome.** If Google Chrome displays a *Your connection is not private* message, click the **ADVANCED** link. Then, click the **Proceed to x.x.x.x (unsafe)** link, in which x.x.x.x represents the IP address of the switch.
  - **Apple Safari.** If Apple Safari displays a *This connection is not private* message, click the **Show Details** button. Then, click the **visit this website** link. If a warning

pop-up window displays, click the **Visit Website** button. If another pop-up window displays to let you confirm changes to your certificate trust settings, enter your Mac user name and password and click the **Update Setting** button.

- **Mozilla Firefox.** If Mozilla Firefox displays a *Your connection is not secure* message, click the **ADVANCED** button. Then, click the **Add Exception** button. In the pop-up window that displays, click the **Confirm Security Exception** button.
- **Microsoft Internet Explore.** If Microsoft Internet Explorer displays a *There is a problem with this website's security certificate* message, click the **Continue to this website (not recommended)** link.
- **Microsoft Edge.** If Microsoft Edge displays a *There is a problem with this website's security certificate* message or a similar warning, select **Details > Go on to the webpage**.

4. Enter the access point user name and default password.

The user name is **admin**. The default password is **password**. The user name and password are case-sensitive.

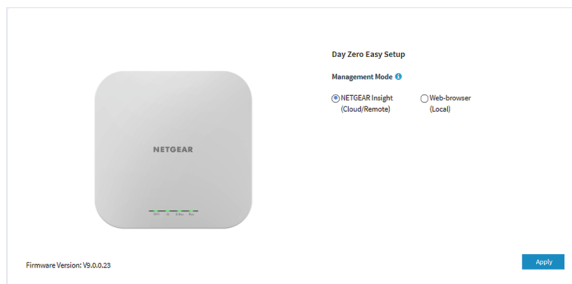

5. Select the **Web-browser** radio button.

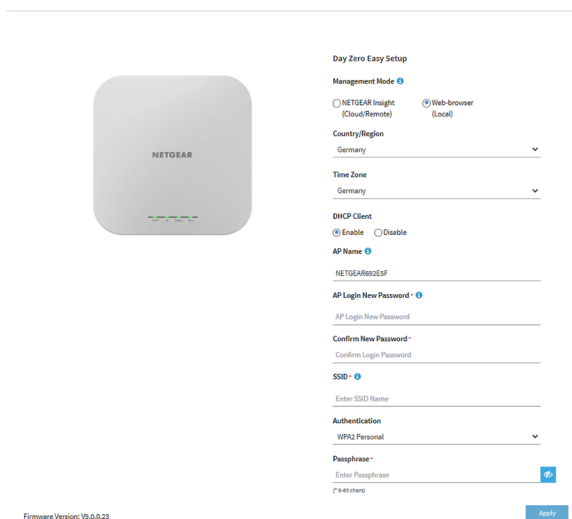

**Note:** After you save the basic settings that are shown on the page, the Day Zero Easy Setup page no longer displays when you log in. Instead, a login window displays. After you log in, the Dashboard page displays.

6. Enter the settings that are described in the following table.

Setting	Description
Country/Region	<p>From the menu, select the country and region in which the access point is operating.</p> <p><b>Note:</b> Make sure that the country is set to the location where the device is operating. You are responsible for complying with the local, regional, and national regulations that are set for channels, power levels, and frequency ranges.</p> <p><b>Note:</b> It might not be legal to operate the access point in a region other than the regions listed in the menu. If your country or region is not listed, check with your local government agency.</p>
Time Zone	<p>From the menu, select the time zone for the country and region in which the access point is operating.</p>
DHCP Client	<p>By default, the DHCP client of the access point allows the access point to receive an IP address from a DHCP server (or router that functions as a DHCP server) in your network. To set up the access point with a static (fixed) IP address, do the following:</p> <ol style="list-style-type: none"> <li>Select the <b>Disable</b> radio button. Additional fields display.</li> <li>Specify the IP address, IP subnet mask, IP address of the default gateway, and IP address of the DNS server.</li> </ol>
AP Name	<p>As an option, enter a new name for the access point. The name must contain alphanumeric characters, must contain at least one alphabetical character, cannot be longer than 15 characters, and can contain hyphens but cannot start or end with a hyphen.</p> <p>By default, the access point name is Netgearxxxxxx, in which xxxxxx represents the last six hexadecimal digits of the access point's MAC address.</p>
AP Login New Password	<p>Enter a new admin password. This is the password that you must use to log in to the access point's local browser UI. (It is <i>not</i> the password that you use for WiFi access.)</p> <p>The password must be 8 to 63 characters in length and must contain at least one uppercase letter, one lowercase letter, and one number. The following special characters are allowed: ! @ # \$ % ^ &amp; * ( )</p> <p>Save the password for future use.</p>
Confirm New Password	<p>Enter exactly the same password that you entered in the <b>AP Login New Password</b> field.</p>

(Continued)

Setting	Description
SSID	You cannot use the default SSID for regular operation. The default SSID is for setup only. Enter a new name with a maximum of 32 characters. You can use a combination of alphanumeric and special characters, except for quotation marks (") and a backslash (\).
Authentication	<p>From the menu, select one of the following authentication types for the WiFi network:</p> <ul style="list-style-type: none"> <li>• <b>Open.</b> Authentication is not required and data encryption is not supported. This setting does not provide any security and is not appropriate for most situations.</li> <li>• <b>WPA2 Personal.</b> This option allows only WiFi clients that support WPA2 to connect to the SSID. Select this option if all WiFi clients are capable of supporting WPA2. This option uses AES encryption.</li> <li>• <b>WPA2/WPA Personal.</b> This option allows both WPA and WPA2 WiFi clients to connect to the SSID. This option uses TKIP and AES encryption. Broadcast packets use TKIP. For unicast (that is, point-to-point) transmissions, WPA clients use TKIP and WPA2 clients use AES.</li> </ul> <p>After you complete the setup process, you can set up WPA3 Personal, WPA3/WPA2 Personal, or WPA2 Enterprise security with RADIUS servers. For more information, see <a href="#">Change the authentication and encryption for a WiFi network</a> on page 70.</p>
Passphrase	Unless you selected <b>Open</b> from the <b>Authentication Type</b> menu, enter a new passphrase (network key or WiFi password) for the WiFi network.

7. Click the **Apply** button.

Your settings are saved. A pop-up window displays the IP address and the new WiFi network and password (passphrase).

If you specified a static IP address, save the IP address information because you must enter the IP address when you log in again.

You are disconnected from the access point. If you changed the default country, the access point restarts.

8. Reconnect over WiFi to the access point's WiFi network using the new SSID and passphrase that you just defined on the Day Zero Easy Setup page.

9. Enter the access point IP address in the address bar of your browser.

If you changed the IP address, enter the IP address that you saved in [Step 7](#).

A login window displays.

10. If your browser does not display the login window but displays a security message and does not let you proceed, see the information in [Step 3](#).

11. Enter the access point user name and password.

The user name is **admin**. The password is the one that you just defined on the Day Zero Easy Setup page. The user name and password are case-sensitive.

The Dashboard page displays. You can now customize the access point settings for your network environment.

## Connect over the LAN to the local browser UI for initial configuration

The following procedure assumes that your network includes a DHCP server (or router that functions as a DHCP server) and that the access point and your computer are on the same LAN. By default, the access point functions as a DHCP client.

**Note:** The figures in this section show model WAX610. If you use model WAX610Y, the local browser UI shows model WAX610Y.

### To connect over the LAN to the local browser UI for initial configuration:

1. To determine the IP address that the DHCP server assigned to the access point, access the DHCP server or use an IP network scanner.  
If you use a Windows-based computer, launch File Explorer (or Windows Explorer), select **Network** from the Navigation pane, right-click the access point device icon, and select **Properties** to display the IP address.  
**Note:** You can also use the NETGEAR Insight app to discover the IP address that is assigned to the access point. For more information, see [Connect over WiFi using the NETGEAR Insight app](#) on page 31.
2. On the computer, launch a web browser and, in the address bar, enter the IP address that is assigned to the access point.



**IMPORTANT:** If your browser does not display the Day Zero login page, see the following step.

3. If your browser displays a security message and does not let you proceed, do one of the following:
  - **Google Chrome.** If Google Chrome displays a *Your connection is not private* message, click the **ADVANCED** link. Then, click the **Proceed to x.x.x.x (unsafe)** link, in which x.x.x.x represents the IP address of the switch.
  - **Apple Safari.** If Apple Safari displays a *This connection is not private* message, click the **Show Details** button. Then, click the **visit this website** link. If a warning pop-up window displays, click the **Visit Website** button. If another pop-up window displays to let you confirm changes to your certificate trust settings, enter your Mac user name and password and click the **Update Setting** button.
  - **Mozilla Firefox.** If Mozilla Firefox displays a *Your connection is not secure* message, click the **ADVANCED** button. Then, click the **Add Exception** button. In the pop-up window that displays, click the **Confirm Security Exception** button.
  - **Microsoft Internet Explore.** If Microsoft Internet Explorer displays a *There is a problem with this website's security certificate* message, click the **Continue to this website (not recommended)** link.
  - **Microsoft Edge.** If Microsoft Edge displays a *There is a problem with this website's security certificate* message or a similar warning, select **Details > Go on to the webpage**.
4. Enter the access point user name and default password.

The user name is **admin**. The default password is **password**. The user name and password are case-sensitive.

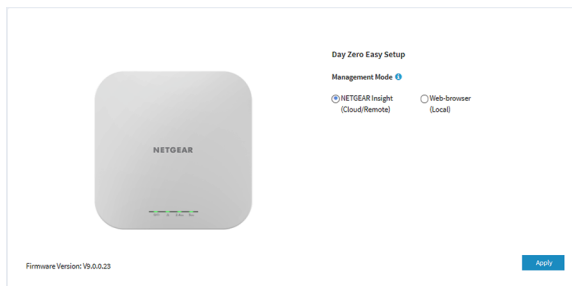

## 5. Select the **Web-browser** radio button.

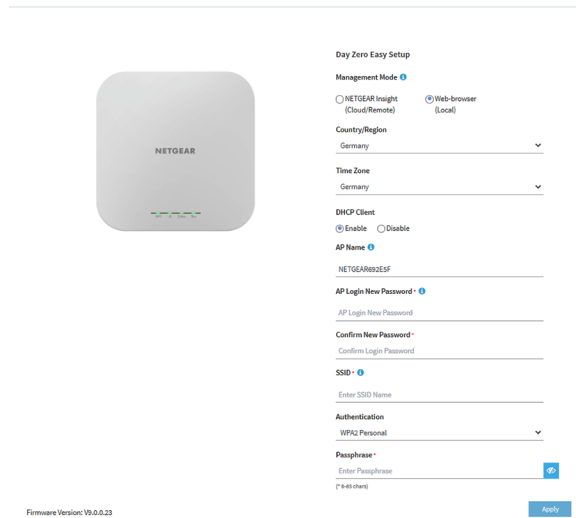

**Note:** After you save the basic settings that are shown on the page, the Day Zero Easy Setup page no longer displays when you log in. Instead, a login window displays. After you log in, the Dashboard page displays.

## 6. Enter the settings that are described in the following table.

Setting	Description
Country/Region	<p>From the menu, select the country and region in which the access point is operating.</p> <p><b>Note:</b> Make sure that the country is set to the location where the device is operating. You are responsible for complying with the local, regional, and national regulations that are set for channels, power levels, and frequency ranges.</p> <p><b>Note:</b> It might not be legal to operate the access point in a region other than the regions listed in the menu. If your country or region is not listed, check with your local government agency.</p>
Time Zone	<p>From the menu, select the time zone for the country and region in which the access point is operating.</p>
DHCP Client	<p>By default, the DHCP client of the access point allows the access point to receive an IP address from a DHCP server (or router that functions as a DHCP server) in your network. To set up the access point with a static (fixed) IP address, do the following:</p> <ol style="list-style-type: none"> <li>Select the <b>Disable</b> radio button. Additional fields display.</li> <li>Specify the IP address, IP subnet mask, IP address of the default gateway, and IP address of the DNS server.</li> </ol>

(Continued)

Setting	Description
AP Name	<p>As an option, enter a new name for the access point. The name must contain alphanumeric characters, must contain at least one alphabetical character, cannot be longer than 15 characters, and can contain hyphens but cannot start or end with a hyphen.</p> <p>By default, the access point name is Netgearxxxxxx, in which xxxxxx represents the last six hexadecimal digits of the access point's MAC address.</p>
AP Login New Password	<p>Enter a new admin password. This is the password that you must use to log in to the access point's local browser UI. (It is <i>not</i> the password that you use for WiFi access.)</p> <p>The password must be 8 to 63 characters in length and must contain at least one uppercase letter, one lowercase letter, and one number. The following special characters are allowed: ! @ # \$ % ^ &amp; * ( )</p> <p>Save the password for future use.</p>
Confirm New Password	<p>Enter exactly the same password that you entered in the <b>AP Login New Password</b> field.</p>
SSID	<p>You cannot use the default SSID for regular operation. The default SSID is for setup only. Enter a new name with a maximum of 32 characters. You can use a combination of alphanumeric and special characters, except for quotation marks (") and a backslash (\).</p>
Authentication	<p>From the menu, select one of the following authentication types for the WiFi network:</p> <ul style="list-style-type: none"> <li>• <b>Open.</b> Authentication is not required and data encryption is not supported. This setting does not provide any security and is not appropriate for most situations.</li> <li>• <b>WPA2 Personal.</b> This option allows only WiFi clients that support WPA2 to connect to the SSID. Select this option if all WiFi clients are capable of supporting WPA2. This option uses AES encryption.</li> <li>• <b>WPA2/WPA Personal.</b> This option allows both WPA and WPA2 WiFi clients to connect to the SSID. This option uses TKIP and AES encryption. Broadcast packets use TKIP. For unicast (that is, point-to-point) transmissions, WPA clients use TKIP and WPA2 clients use AES.</li> </ul> <p>After you complete the setup process, you can set up WPA3 Personal, WPA3/WPA2 Personal, or WPA2 Enterprise security with RADIUS servers. For more information, see <a href="#">Change the authentication and encryption for a WiFi network</a> on page 70.</p>
Passphrase	<p>Unless you selected <b>Open</b> from the <b>Authentication Type</b> menu, enter a new passphrase (network key or WiFi password) for the WiFi network.</p>

### 7. Click the **Apply** button.

Your settings are saved. A pop-up window displays the IP address and the new WiFi network and password (passphrase).



If you specified a static IP address, save the IP address information because you must enter the IP address when you log in again.

If you changed the default country, the access point restarts.

**Note:** Do not close the page!

After a short period, the Dashboard page displays automatically. If the Dashboard page does not display, for example, because you assigned a static IP address, see the next step.

You can now customize the access point settings for your network environment.

8. If the Dashboard does not display automatically, do the following:
  - a. Take one of the following actions:
    - If you assigned a static IP address to the access point, enter that IP address (see [Step 7](#)) in the address bar of the web browser.
    - If you did not assign a static IP address, reenter the IP address that is displayed in the address bar of the web browser. If that does not work, write down the IP address, close the web browser, launch the web browser again, and then reenter the IP address in the address bar of the web browser.
    - If you did not assign a static IP address and you closed the page so that you cannot see the IP address of the access point, use an IP scanner tool, use a network discovery tool, or access the DHCP server to discover the IP address of the access point in your network.

**Note:** You can also use the NETGEAR Insight app to discover the IP address that is assigned to the access point. For more information, see [Connect over WiFi using the NETGEAR Insight app](#) on page 31.

Then, launch a browser and enter the IP address in the address bar of the web browser.

A login window displays.

- b. If your browser does not display the login window but displays a security message and does not let you proceed, see the information in [Step 3](#).
- c. Enter the access point user name and password.

The user name is **admin**. The password is the one that you just defined on the Day Zero Easy Setup page. The user name and password are case-sensitive. The Dashboard page displays. You can now customize the access point settings for your network environment.

# Configure indoor model WAX610 offline using a directly connected computer

**Note:** This procedure does not apply to outdoor model WAX610Y because it requires a PoE+ connection to a PoE+ switch. (A directly connected computer cannot provide PoE+ to the access point.)

You can take the access point offline (that is, disconnect it from your network), connect a computer through an Ethernet cable to the LAN/PoE+ port of the access point, and connect to the access point over its default IP address so that you can configure it offline. After you complete the configuration, you can bring the access point online.

**Note:** Because the access point is not connected to a PoE+ switch, you can use this configuration method only if you have a power adapter for the access point.

## To connect to the access point using a computer that is connected to a LAN/PoE+ port of the access point:

1. Record the IP address and subnet mask of your computer so that you can reinstate these IP address settings later.
2. Temporarily change the IP address on your computer to 192.168.0.210 with 255.255.255.0 as the subnet mask.  
(You can actually use any IP address in the 192.168.0.2-192.168.0.254 range, with the exception of IP address 192.168.0.100, which is the default IP address of the access point.)

For more information about changing the IP address on your computer, see the help or documentation for your computer.

3. Use an Ethernet cable to connect your computer to a LAN/PoE+ port on the access point.
4. On the computer, launch a web browser and enter **192.168.0.100** in the address bar.



Username  
username

Password  
password

Login

**IMPORTANT:** If your browser does not display the Day Zero login page, see the following step.

5. If your browser displays a security message and does not let you proceed, do one of the following:
  - **Google Chrome.** If Google Chrome displays a *Your connection is not private* message, click the **ADVANCED** link. Then, click the **Proceed to 192.168.0.100 (unsafe)** link.
  - **Apple Safari.** If Apple Safari displays a *This connection is not private* message, click the **Show Details** button. Then, click the **visit this website** link. If a warning pop-up window displays, click the **Visit Website** button. If another pop-up window displays to let you confirm changes to your certificate trust settings, enter your Mac user name and password and click the **Update Setting** button.
  - **Mozilla Firefox.** If Mozilla Firefox displays a *Your connection is not secure* message, click the **ADVANCED** button. Then, click the **Add Exception** button. In the pop-up window that displays, click the **Confirm Security Exception** button.
  - **Microsoft Internet Explore.** If Microsoft Internet Explorer displays a *There is a problem with this website's security certificate* message, click the **Continue to this website (not recommended)** link.
  - **Microsoft Edge.** If Microsoft Edge displays a *There is a problem with this website's security certificate* message or a similar warning, select **Details > Go on to the webpage**.
6. Enter the access point user name and default password.

The user name is **admin**. The default password is **password**. The user name and password are case-sensitive.

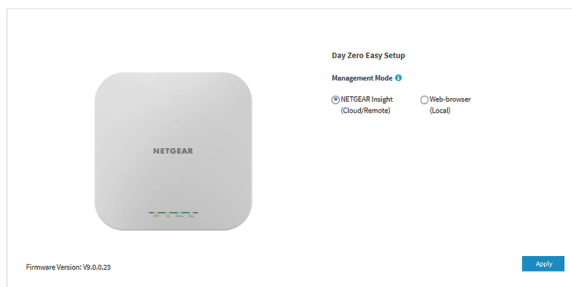

## 7. Select the **Web-browser** radio button.

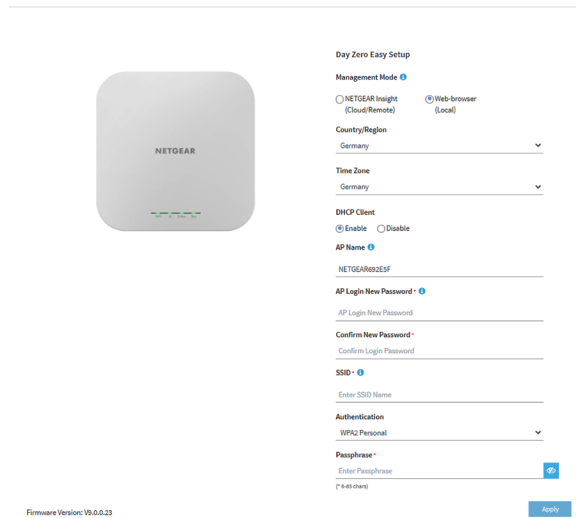

**Note:** After you save the basic settings that are shown on the page, the Day Zero Easy Setup page no longer displays when you log in. Instead, a login window displays. After you log in, the Dashboard page displays.

## 8. Enter the settings that are described in the following table.

Setting	Description
Country/Region	<p>From the menu, select the country and region in which the access point is operating.</p> <p><b>Note:</b> Make sure that the country is set to the location where the device is operating. You are responsible for complying with the local, regional, and national regulations that are set for channels, power levels, and frequency ranges.</p> <p><b>Note:</b> It might not be legal to operate the access point in a region other than the regions listed in the menu. If your country or region is not listed, check with your local government agency.</p>
Time Zone	<p>From the menu, select the time zone for the country and region in which the access point is operating.</p>
DHCP Client	<p>By default, the DHCP client of the access point allows the access point to receive an IP address from a DHCP server (or router that functions as a DHCP server) in your network. To set up the access point with a static (fixed) IP address, do the following:</p> <ol style="list-style-type: none"> <li>Select the <b>Disable</b> radio button. Additional fields display.</li> <li>Specify the IP address, IP subnet mask, IP address of the default gateway, and IP address of the DNS server.</li> </ol>

(Continued)

Setting	Description
AP Name	<p>As an option, enter a new name for the access point. The name must contain alphanumeric characters, must contain at least one alphabetical character, cannot be longer than 15 characters, and can contain hyphens but cannot start or end with a hyphen.</p> <p>By default, the access point name is Netgearxxxxxx, in which xxxxxx represents the last six hexadecimal digits of the access point's MAC address.</p>
AP Login New Password	<p>Enter a new admin password. This is the password that you must use to log in to the access point's local browser UI. (It is <i>not</i> the password that you use for WiFi access.)</p> <p>The password must be 8 to 63 characters in length and must contain at least one uppercase letter, one lowercase letter, and one number. The following special characters are allowed: ! @ # \$ % ^ &amp; * ( )</p> <p>Save the password for future use.</p>
Confirm New Password	<p>Enter exactly the same password that you entered in the <b>AP Login New Password</b> field.</p>
SSID	<p>You cannot use the default SSID for regular operation. The default SSID is for setup only. Enter a new name with a maximum of 32 characters. You can use a combination of alphanumeric and special characters, except for quotation marks (") and a backslash (\).</p>
Authentication	<p>From the menu, select one of the following authentication types for the WiFi network:</p> <ul style="list-style-type: none"> <li>• <b>Open.</b> Authentication is not required and data encryption is not supported. This setting does not provide any security and is not appropriate for most situations.</li> <li>• <b>WPA2 Personal.</b> This option allows only WiFi clients that support WPA2 to connect to the SSID. Select this option if all WiFi clients are capable of supporting WPA2. This option uses AES encryption.</li> <li>• <b>WPA2/WPA Personal.</b> This option allows both WPA and WPA2 WiFi clients to connect to the SSID. This option uses TKIP and AES encryption. Broadcast packets use TKIP. For unicast (that is, point-to-point) transmissions, WPA clients use TKIP and WPA2 clients use AES.</li> </ul> <p>After you complete the setup process, you can set up WPA3 Personal, WPA3/WPA2 Personal, or WPA2 Enterprise security with RADIUS servers. For more information, see <a href="#">Change the authentication and encryption for a WiFi network</a> on page 70.</p>
Passphrase	<p>Unless you selected <b>Open</b> from the <b>Authentication Type</b> menu, enter a new passphrase (network key or WiFi password) for the WiFi network.</p>

### 9. Click the **Apply** button.

Your settings are saved. A pop-up window displays the IP address and the new WiFi network and password (passphrase).

If you specified a static IP address, save the IP address information because you must enter the IP address when you log in again.

You are disconnected from the access point. If you changed the default country, the access point restarts.

10. After a few minutes, if the login window does not display automatically, enter **192.168.0.100** in the address bar of your browser.

If you changed the IP address, enter the IP address that you saved in [Step 9](#).

A login window displays.

11. If your browser does not display the login window but displays a security message and does not let you proceed, see the information in [Step 5](#).

12. Enter the access point user name and password.

The user name is **admin**. The password is the one that you just defined on the Day Zero Easy Setup page. The user name and password are case-sensitive.

The Dashboard page displays. You can now customize the access point settings for your network environment.

13. After you complete the setup process, or both the setup and customization process, you can change the computer back to its original IP address settings.

## Log in to the access point after initial setup

After initial setup, the access point is ready for use and you can change the settings and monitor the traffic.

When you enter the IP address that is assigned to the access point, we recommend that you enter **https** rather than **http**. However, if you enter **http**, the browser automatically redirects your request to **https**. If you did not yet install the access point's security certificate, your browser might display a security message. You can either ignore this message or install the security certificate. Consider the following examples:

- **Google Chrome.** If Google Chrome displays a *Your connection is not private* message, click the **ADVANCED** link. Then, click the **Proceed to x.x.x.x (unsafe)** link, in which x.x.x.x represents the IP address of the switch.
- **Apple Safari.** If Apple Safari displays a *This connection is not private* message, click the **Show Details** button. Then, click the **visit this website** link. If a warning pop-up window displays, click the **Visit Website** button. If another pop-up window displays to let you confirm changes to your certificate trust settings, enter your Mac user name and password and click the **Update Setting** button.

- **Mozilla Firefox.** If Mozilla Firefox displays a *Your connection is not secure* message, click the **ADVANCED** button. Then, click the **Add Exception** button. In the pop-up window that displays, click the **Confirm Security Exception** button.
- **Microsoft Internet Explore.** If Microsoft Internet Explorer displays a *There is a problem with this website's security certificate* message, click the **Continue to this website (not recommended)** link.
- **Microsoft Edge.** If Microsoft Edge displays a *There is a problem with this website's security certificate* message or a similar warning, select **Details > Go on to the webpage**.

### **To log in to the access point's local browser UI:**

1. Launch a web browser from a computer that is connected to the same network as the access point or directly to the access point through an Ethernet cable or WiFi connection.

2. Enter the IP address that is assigned to the access point.

A login window displays.

If your browser does not display the login window but displays a security message, see the information in the introduction to this task.

3. Enter the access point user name and password.

The user name is **admin**. The password is the one that you specified. The user name and password are case-sensitive.

If you previously added the access point to a NETGEAR Insight network location and managed the access point through the Insight app or Insight Cloud portal, enter the Insight network password for that location. For more information, see [Connect over WiFi using the NETGEAR Insight app](#) on page 31.

The Dashboard page displays.

The following figure shows the upper part of the Dashboard page for model WAX610. The Dashboard page for model WAX610Y is identical.

## Insight Managed WiFi 6 AX1800 Dual Band Access Point Models WAX610 and WAX610Y

The screenshot shows the NETGEAR Insight Managed WiFi 6 AX1800 Dual Band Access Point (WAX610) dashboard. The interface includes a navigation bar with 'Dashboard' and 'Management' tabs. The main content area is divided into several sections:

- Left Sidebar:** A vertical navigation menu with icons for 'Internet Connected', 'Access Point', and 'Devices'.
- Top Section:** A header for 'NETGEAR692E5F / United States' with a 'Check for Upgrade' button.
- Device Information Table:**

Ethernet MAC	44-A5-6E-69-2E-5F
Serial Number	6AC1002C00033
Uptime	00 Days 00 Hrs 24 Mins
Firmware	V9.0.0.23
Last Checked	-
- IP Address Section:** A header for '192.168.100.127 / Dynamic' with a table of network details:

Gateway	192.168.100.1
Gateway Status	Reachable
Traffic (wired)	4.7 MB
- Right Section:** A panel for the 2.4 GHz band with a '2.4 GHz' indicator and a table of settings:

Mode	11ax
Channel	Auto (6)
Channel Width	20/40 MHz
Clients	0 (200)
Traffic	0 Bytes
Channel Utilization	3%

The Dashboard page displays various panes that let you see the status of your access point at a glance. For more information about the Dashboard page and its various panes, see [Monitor the Access Point and the Network](#) on page 176.



# 5

## Install the Access Point in an Insight Instant Mesh WiFi Network

---

In addition to functioning as a regular standalone access point, the access point can function in an Insight Instant Mesh WiFi network as either a root access point or an extender access point.

This chapter describes how you can use the NETGEAR Insight app to connect the access point to a root access point and let it function as an extender access point in an Insight Instant Mesh WiFi network.

**IMPORTANT:** To set up the extender access point in a NETGEAR Insight Instant Mesh WiFi network with a connection to a root access point, you must use the NETGEAR Insight app. You cannot use the local browser UI to set up a mesh WiFi connection to a root access point.

For information about how you can manage and monitor the extender access point with the NETGEAR Insight app and Insight Cloud portal, visit [netgear.com/insight](https://netgear.com/insight) and [netgear.com/support/product/Insight.aspx](https://netgear.com/support/product/Insight.aspx). For knowledge base articles about NETGEAR Insight, visit [netgear.com/support](https://netgear.com/support).

The chapter contains the following sections:

- [What are a root access point and an extender access point?](#)
- [What is an Insight Instant Mesh WiFi network?](#)
- [Requirements for placing an extender access point in a mesh WiFi network](#)
- [Install the NETGEAR Insight app to manage an Insight Instant Mesh WiFi network](#)
- [Connect the access point as an extender to a root access point](#)
- [Connect over the Internet using the NETGEAR Insight Cloud portal](#)

# What are a root access point and an extender access point?

Both model WAX610 and WAX610Y can function in an Insight Instant Mesh WiFi network as a root access point, while model WAX610 can also function as an extender access point:

- **Root access point.** A mesh-capable access point that is set up with a wired connection to your network and functions as a gateway to another mesh-capable access point that functions as an extender. On the root access point, use the Ethernet port for the connection to your network. A root access point can service multiple extender access points simultaneously.
- **Extender access point.** A mesh-capable access point that functions as an extender access point with a WiFi backhaul connection to a root access point that provides Internet connectivity. The extender access point is not connected to your network over a wired connection but over a WiFi connection.

**Note:** Although model WAX610Y can function as an extender access point, you can power it through PoE only.

The following figure shows indoor model WAX610. If you use outdoor model WAX610Y as a root access point with a connection to an indoor PoE+ switch, the setup requires an Ethernet surge protector on the Ethernet cable between outdoor model WAX610Y and the PoE+ switch .

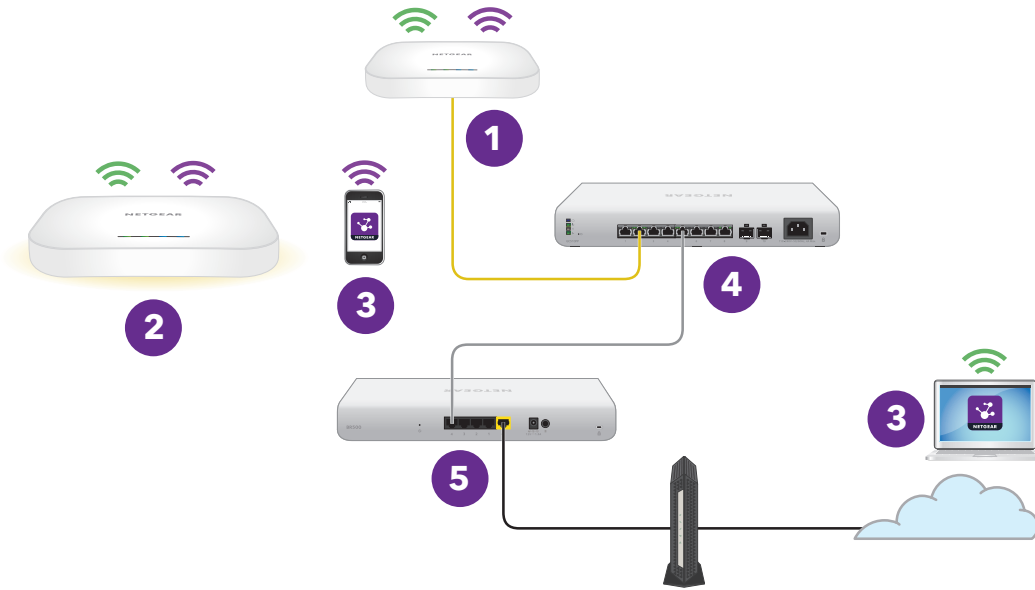

Figure 9. Mesh network with an extender access point and a wired root access point

Number or Icon and Description

- 1 A root access point that is connected over Ethernet to a network switch.

---

- 2 An extender access point that is connected over a 5 GHz backhaul WiFi connection to the root access point. If model WAX610 functions as an extender, it must be powered by a power adapter rather than by PoE. (A power adapter is an option that you can purchase.) Although model WAX610Y can function as an extender access point, you can power it through PoE only.

---

- 3 A mobile phone with the Insight app or either a computer or a tablet with access to the Insight Cloud portal. The Insight app or Insight Cloud portal let you configure and manage the extender access point in the Insight Instant Mesh WiFi network.

---

- 4 A network switch. If model WAX610Y functions as a root access point or model WAX610 functions as a root access point without a power adapter, the switch must provide PoE+ to the access point.

---

- 5 A network router that is connected to the Internet.

 Broadcast in the 2.4 GHz radio band.

 Broadcast in the 5 GHz radio band.

# What is an Insight Instant Mesh WiFi network?

A mesh WiFi network consists of at least one mesh-capable root access point and one or more extender access points that connect to the root access point over WiFi (see [What are a root access point and an extender access point?](#) on page 50). The root access point is connected over Ethernet to a router or Internet gateway and provides Internet access to its extender access points. The root access point and extender access points work together to cover a potentially large area with WiFi network, which is the mesh network.

A mesh network can be a good solution if you want to bring WiFi to the following environments:

- Nearby rooms where cabling is not available (in line of sight and in range of the current WiFi reception)
- Neighboring office buildings (in line of sight and in range of the current WiFi reception)
- Any environment in which you cannot run cables

In the mesh WiFi network, the extender access point connects to the root access point over a WiFi connection and broadcasts (extends) the WiFi network to the WiFi clients:

- **Backhaul connection.** The WiFi connection between the root access point and the extender access point is referred to as the backhaul connection.
- **Fronthaul connection.** The WiFi connection between the extender access point and its WiFi clients is referred to as the fronthaul connection.

In a NETGEAR Insight Instant Mesh WiFi network, you must use the Insight app to set up the mesh WiFi connection between the root access point and the extender access point. That is, you cannot do so through the local browser UI of either the root access point or the extender access point. In a network with multiple root access points, NETGEAR Insight automatically connects the extender access point to the root access point with the strongest WiFi signal.

Although the extender access point broadcasts the same WiFi network or networks as the root access point, you can also set up a WiFi network on the extender access point, which then can be broadcast by the root access point and other extender access points in the mesh network.

The access point can broadcast on the 5 GHz band (the preferred band for the backhaul connection) and the 2.4 GHz band. Depending on the WiFi capability of the WiFi client, any band can provide the fronthaul connection.

# Requirements for placing an extender access point in a mesh WiFi network

The following are the requirements for placing an extender access point in an Insight Instant Mesh WiFi network:

- The existing WiFi network must include at least one mesh-capable access point that runs the latest firmware version. On the root access point, use one Ethernet port for the connection to your network.
- The extender access point must be within range of the WiFi signal of a root access point so that it can sync with the root access point. For a reliable WiFi connection, place the extender access point less than 25 feet (7.5 m), in a line of sight with minimal obstacles from the closest root access point.
- You must use the NETGEAR Insight app to install the extender access point in the existing WiFi network.

The following NETGEAR access point models can function either as a root access point or as an extender access point:

- WAX610
- WAC610Y (Although this model can function as an extender access point, you can power it through PoE only.)
- WAC564
- WAC540

**Note:** In a mesh WiFi network with WAX610 or WAX610Y models and WAC564 or WAC540 models, the WAC564 and WAC540 models must run firmware version 9.0 or a later version.

In the near future, more NETGEAR models might be added to the previous list.

# Install the NETGEAR Insight app to manage an Insight Instant Mesh WiFi network

Before you can add the access point to an Insight Instant Mesh WiFi network, you must install the NETGEAR Insight app on an iOS or Android mobile device.

For more information about the Insight app, visit [netgear.com/insight](https://netgear.com/insight) and [netgear.com/support/product/Insight.aspx](https://netgear.com/support/product/Insight.aspx). For knowledge base articles about NETGEAR Insight, visit [netgear.com/support](https://netgear.com/support).

## To install the Insight app:

1. On your mobile device, go to the app store, search for NETGEAR Insight, and download the Insight app.



2. Launch the Insight app.
3. If you do not have a NETGEAR account, tap **Create NETGEAR Account** and follow the onscreen instructions.
4. Enter the email address and password for your account and tap **LOG IN**.

You can now set up the access point mesh WiFi connection (see [Connect the access point as an extender to a root access point](#) on page 54).

## Connect the access point as an extender to a root access point

Use the NETGEAR Insight app to connect the access point as an extender to a root access point. The root access point must be set up with a wired connection to a router or Internet gateway so that the root access point can provide Internet connectivity to the extender access point.

**Note:** Although model WAX610Y can function as an extender access point, you can power it through PoE only.

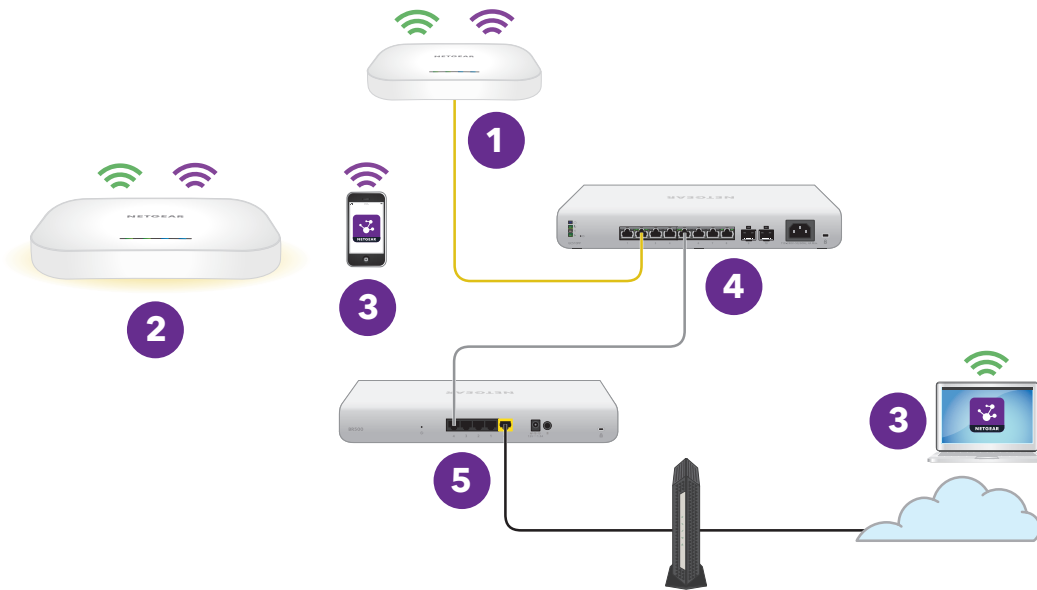



Figure 10. Connect the extender access point to a wired root access point

Number or Icon and Description	
<b>1</b>	A root access point that is connected over Ethernet to a network switch.
<b>2</b>	An extender access point that is connected over a 5 GHz backhaul WiFi connection to the root access point. If model WAX610 functions as an extender, it must be powered by a power adapter rather than by PoE. (A power adapter is an option that you can purchase.) Although model WAX610Y can function as an extender access point, you can power it through PoE only.
<b>3</b>	A mobile phone with the Insight app or either a computer or a tablet with access to the Insight Cloud portal. The Insight app or Insight Cloud portal let you configure and manage the extender access point in the Insight Instant Mesh WiFi network.
<b>4</b>	A network switch. If model WAX610Y functions as a root access point or model WAX610 functions as a root access point without a power adapter, the switch must provide PoE+ to the access point.
<b>5</b>	A network router that is connected to the Internet.
	Broadcast in the 2.4 GHz radio band.
	Broadcast in the 5 GHz radio band.

The extender access point can use any band to establish the backhaul connection to the root access point and the fronthaul connection to WiFi clients. However, after the backhaul connection is established, the extender access point automatically switches

to the 5 GHz band as the preferred band for its backhaul connection. Using the NETGEAR Insight app, you can change the preferred band for the backhaul connection.

**To use the NETGEAR Insight app to connect the extender access point to a root access point in an existing WiFi network:**

1. For a reliable WiFi connection, place the extender access point less than 25 feet (7.5 m), in a line of sight with minimal obstacles from the closest root access point.
2. Connect the extender access point to a power source.  
The Power/Cloud LED of the extender access point lights amber and then lights green.

**IMPORTANT:** To prevent a network loop, connect the extender access point to a PoE+ switch that is *not* connected to the same network as the root access point or to the Internet. You can also use an optional power adapter.

3. Connect your smartphone to the existing WiFi network that includes one or more root access points.
4. Launch the Insight app and sign in to your NETGEAR account.  
In most situations, the Insight app detects the extender access point automatically. This process might take a few minutes.
5. Do one of the following:
  - **Automatically detected.** If the Insight app detects the extender access point automatically, tap the extender access point and follow the onscreen instructions to add the extender access point to your Insight account and to an Insight network location.
  - **Not automatically detected.** If the Insight app does *not* detect the extender access point automatically, do the following:
    - a. Tap **+** in the upper-right corner.
    - b. Manually add the extender access point to the Insight app using one of the following options:
      - Scan the QR code.
      - Scan the serial number bar code.
      - Type in the serial number.
    - c. Follow the onscreen instructions to add the extender access point to your Insight account and to an Insight network location.

The extender access point attempts to detect and connect to the root access point that provides the strongest WiFi signal in the Insight Instant Mesh WiFi network.



**Note:** The initial connection and configuration process might take up to 10 minutes. The extender access point might restart during the configuration process.

6. Wait for the extender access point to go through the initial connection and configuration process and for the Power/Cloud LED to stop blinking amber, green, and blue and to light solid blue.

**Note:** The initial connection and configuration process might take up to 10 minutes. The extender access point might restart during the configuration process.

The Power/Cloud LED lights as follows during the initial connection and configuration process:

- **Blinking green.** The extender access point is attempting to detect a root access point.
- **Solid green.** The extender access point is making its first connection with the root access point that provides the strongest WiFi signal.
- **Blinking amber slowly.** The extender access point is contacting the network router or DHCP server to receive an IP address.  
If the Power/Cloud LED does not stop blinking amber, see [Power/Cloud LED is blinking amber slowly, continuously](#) on page 222.
- **Blinking amber, green, and blue.** The extender access point is being configured as a managed device in the Insight Instant Mesh WiFi network.  
If the Power/Cloud LED does not stop blinking amber, green, and blue, see [Power/Cloud LED does not stop blinking amber, green, and blue](#) on page 224.

When the configuration is complete, the Power/Cloud LED lights as follows:

- **Solid blue.** The configuration is complete and the extender access point is ready for operation. The extender access point functions in the Insight Instant Mesh WiFi network and is connected to the Insight cloud.

The extender access point is automatically configured to broadcast (extend) the root access point's WiFi network.

If you are experiencing difficulty connecting the extender access point with a root access point, see [The extender access point and root access point cannot connect](#) on page 225.

For information about accessing, managing, and monitoring the extender access point with the NETGEAR Insight app and Insight Cloud portal, visit [netgear.com/insight](https://netgear.com/insight) and [netgear.com/support/product/Insight.aspx](https://netgear.com/support/product/Insight.aspx). For knowledge base articles about NETGEAR Insight, visit [netgear.com/support](https://netgear.com/support).

# Connect over the Internet using the NETGEAR Insight Cloud portal

The NETGEAR Insight Cloud portal is available for Insight Premium and Insight Pro subscribers.

After you install the access point in an Insight Instant Mesh WiFi network, you can use the Insight Cloud portal to configure, manage, and monitor the access point.

For more information about the Insight Cloud portal and the configuration and management options that are available through the Insight Cloud portal, visit [netgear.com/insight](https://netgear.com/insight) and [netgear.com/support/product/Insight.aspx](https://netgear.com/support/product/Insight.aspx). For knowledge base articles about NETGEAR Insight, visit [netgear.com/support](https://netgear.com/support).

## **To connect to the access point over the Internet through the Insight Cloud portal:**

1. Visit [insight.netgear.com](https://insight.netgear.com).  
The NETGEAR Account Login page displays.
2. Enter your Insight email address and password.  
If you do not own an Insight account, you can create one.
3. Click the **Login** button.  
You can now configure, manage, and monitor the access point.

# 6

## Manage the Basic WiFi Features

---

This chapter describes how you can manage the basic WiFi settings of the access point. The access point can support eight WiFi networks, each with its own unique WiFi settings, including WiFi security.

**Tip:** If you want to change the settings of the access point's WiFi network, use a wired connection to avoid being disconnected when the new WiFi settings take effect.

The chapter includes the following sections:

- [Set up an open or secure WiFi network](#)
- [View or change the settings of a WiFi network](#)
- [Disable or enable a WiFi network or set up a WiFi activity schedule](#)
- [Remove a WiFi network](#)
- [Change the authentication and encryption for a WiFi network](#)
- [Hide or broadcast the SSID for a WiFi network](#)
- [Enable or disable client isolation for a WiFi network](#)
- [Enable or disable band steering with 802.11k RRM and 802.11v WiFi network management](#)
- [Change the VLAN ID for a WiFi network](#)
- [Enable or disable PMF for a WiFi network](#)
- [Enable or disable URL tracking for a WiFi network](#)
- [Change the format of the DHCP offer messages in a WiFi network](#)
- [Select a MAC ACL for a WiFi network](#)
- [Set bandwidth rate limits for a WiFi network](#)

# Set up an open or secure WiFi network

The access point provides one default SSID that is enabled by default and that broadcasts on the 2.4 GHz band and the 5 GHz band. This is the SSID that you were required to rename when you logged in to the access point for the first time. You can add more SSIDs: The access point can support a total of eight SSIDs.

The access point can simultaneously support the 2.4 GHz band for 802.11b/g/n/ax WiFi devices and the 5 GHz band for 802.11a/na/ac/ax WiFi devices. Each band supports two WiFi streams for a total of four WiFi streams.

SSID stands for service set identifier, which is the WiFi network name. When you create a new SSID, you are defining the settings for a new virtual access point (VAP). That means that the access point supports up to eight VAPs.

If you plan to use WPA2 Enterprise security for your WiFi network, first set up RADIUS servers (see [Set up RADIUS servers](#) on page 133).

## To set up a WiFi network:

1. Launch a web browser from a computer that is connected to the same network as the access point or directly to the access point through an Ethernet cable or WiFi connection.

2. Enter the IP address that is assigned to the access point.  
A login window displays.

If your browser does not display the login window but displays a security message and does not let you proceed, see [Log in to the access point after initial setup](#) on page 46.

3. Enter the access point user name and password.

The user name is **admin**. The password is the one that you specified. The user name and password are case-sensitive.

If you previously added the access point to a NETGEAR Insight network location and managed the access point through the Insight app or Insight Cloud portal, enter the Insight network password for that location. For more information, see [Connect over WiFi using the NETGEAR Insight app](#) on page 31.

The Dashboard page displays.

4. Select **Management > Configuration > Wireless > Basic**.

The page that displays lets you select and add an SSID.

- Click the + button to the left of Add SSID.

SSID2

The screenshot shows a configuration form for a wireless network. The fields are as follows:

- Wireless Network Name (SSID):** NETGEAR-2
- Broadcast SSID:**  Yes  No
- VLAN ID:** 1
- Authentication:** WPA2 Personal
- Passphrase:** [Masked]
- 802.11w (PMF):**  Disable  Mandatory  Optional
- Schedule:**  Always ON  Always OFF  Custom
- Band:**  2.4 GHz  5 GHz  Both
- Band Steering / 802.11 k/v:**  Enable  Disable

Buttons: Cancel, Apply

The previous figure shows SSID2 as an example.

- Specify the WiFi network name (SSID), select whether the SSID is broadcast, and specify the VLAN ID as described in the following table.

Setting	Description
Wireless Network Name (SSID)	The SSID is the WiFi network name of the VAP. Enter a name for the SSID with a maximum of 32 characters. You can use a combination of alphanumeric and special characters, except for quotation marks (") and a backslash (\). For a WiFi device to be able to connect to the VAP, the SSID on the WiFi device must match the SSID of the VAP.
Broadcast SSID	By default, the VAP broadcasts its SSID so that WiFi clients can detect the SSID in their scanned network lists. To turn off the SSID broadcast, select the <b>No</b> radio button. Turning off the SSID broadcast provides additional WiFi security, but users must know the SSID to be able to join the VAP.
VLAN ID	You can enter the VLAN ID that must be associated with the VAP. By default, the VLAN ID is 1. This VLAN ID is not the same as the 802.1Q VLAN ID that is used for the wired network (see <a href="#">Set the 802.1Q VLAN and management VLAN</a> on page 140).

7. Specify the WiFi security by selecting an option from the **Authentication** menu and, if applicable, by specifying a passphrase in the **Passphrase** field or selecting an option from the **Encryption** menu, as described in the following table.

Setting	Description
Open	<p>A legacy open WiFi network does not provide any security. Any WiFi device can join the network. We recommend that you do <i>not</i> use a legacy open WiFi network but configure WiFi security. However, a legacy open network might be appropriate for a WiFi hotspot. If you select <b>Open</b> from the <b>Authentication</b> menu, the <b>Enhanced Open</b> check box displays.</p> <ul style="list-style-type: none"> <li>• <b>Enhanced Open check box cleared.</b> The WiFi network is a legacy open network without any security. This is the default option for an open network. Clients are not authenticated, traffic is not encrypted, and 802.11w (PMF) is automatically disabled (see <a href="#">Step 9</a>).</li> <li>• <b>Enhanced Open check box selected.</b> The WiFi network can only accept clients that support the WiFi enhanced open feature, which is based on opportunistic wireless encryption (OWE). Select this option only if all the clients in the WiFi network support OWE. If you select this option, the encryption is CCM mode protocol (CCMP), and 802.11w (PMF) is automatically set to mandatory (see <a href="#">Step 9</a>).</li> </ul>
WPA2 Personal	<p>This option, which is the same as WPA2-PSK, is the default setting and uses AES encryption. This type of security enables only WiFi devices that support WPA2 to join the VAP. WPA2 provides a secure connection but some legacy WiFi devices do not detect WPA2 and support only WPA. If your network includes such older devices, select <b>WPA2/WPA Personal</b> authentication.</p> <p>In the <b>Passphrase</b> field, enter a phrase of 8 to 63 characters. To join the VAP, a user must enter this passphrase. To view the passphrase in clear text, click the eye icon.</p>
WPA2/WPA Personal	<p>This option, which is the same as WPA2-PSK/WPA-PSK, enables WiFi devices that support either WPA2 or WPA to join the VAP. This option uses AES and TKIP encryption. WPA-PSK (which uses TKIP) is less secure than WPA2-PSK (which uses AES) and limits the speed of WiFi devices to 54 Mbps.</p> <p>In the <b>Passphrase</b> field, enter a phrase of 8 to 63 characters. To join the VAP, a user must enter this passphrase. To view the passphrase in clear text, click the eye icon.</p>
WPA2 Enterprise	<p>This enterprise-level security uses RADIUS for centralized Authentication, Authorization, and Accounting (AAA) management. For WPA2 Enterprise security to function, you must set up RADIUS servers (see <a href="#">Set up RADIUS servers</a> on page 133).</p> <p>From the <b>Encryption</b> menu, select the data encryption mode:</p> <ul style="list-style-type: none"> <li>• <b>TKIP + AES.</b> This type of data encryption enables WiFi devices that support either WPA or WPA2 to join the access point's WiFi network. This is the default mode.</li> <li>• <b>AES.</b> This type of data encryption provides a secure connection but some older WiFi devices do not detect WPA2 and support only WPA. Therefore, if your network includes such older devices, select <b>TKIP + AES</b> encryption.</li> </ul>

(Continued)

Setting	Description
WPA3 Personal	<p>This option is the most secure personal authentication option. WPA3 uses SAE encryption and enables only WiFi devices that support WPA3 to join the VAP. If you select this option, 802.11w (PMF) is automatically set to mandatory (see <a href="#">Step 9</a>).</p> <p>WPA3 provides a secure connection but some legacy WiFi devices do not detect WPA3 and support only WPA2. If your network also includes WPA2 devices, select <b>WPA3/WPA2 Personal</b> authentication.</p> <p>In the <b>Passphrase</b> field, enter a phrase of 8 to 63 characters. To join the VAP, a user must enter this passphrase. To view the passphrase in clear text, click the eye icon.</p>
WPA3/WPA2 Personal	<p>This option, which is the same as WPA3/WPA2-PSK, enables WiFi devices that support either WPA3 or WPA2 to join the VAP. This option uses SAE and AES encryption.</p> <p>WPA2-PSK (which uses AES) is less secure than WPA3 (which uses SAE).</p> <p>In the <b>Passphrase</b> field, enter a phrase of 8 to 63 characters. To join the VAP, a user must enter this passphrase. To view the passphrase in clear text, click the eye icon.</p>

8. Optionally, disable the WiFi broadcast or set up a WiFi activity schedule by selecting one of the following radio buttons:

- **Always ON.** When you set up an SSID, you are creating a new virtual access point (VAP). By default, the new VAP is enabled and the **Always ON** radio button is selected.
- **Always OFF.** Select this radio button to set up the SSID but temporarily disable the VAP.
- **Custom.** Select this radio button to set up a broadcast schedule. An icon displays to the right of the radio button. Do the following:
  - a. Click the icon next to the radio button.  
A pop-up window displays.
  - b. Either select a predefined time from the **Preset** menu or select custom time blocks by clicking the time blocks.  
A blue color for a time block indicates that the VAP will be enabled (on). A gray color for a time block indicates that the VAP will be disabled (off).
  - c. Click the **Done** button.  
The pop-up window closes.

For each SSID, you can create a single custom schedule. In that schedule, for each day from 12:00 a.m. to 11:59 p.m., you specify the time or times that the VAP is disabled.

9. Optionally, enable 802.11w Protected Management Frames (PMF), select a single radio band only, enable band steering with 802.11k radio resource management (RRM) and 802.11v WiFi network management, or do all of this, as described in the following table.

Setting	Description
802.11w (PMF)	<p>Protected Management Frames (PMF), according to the 802.11w standard, is a security feature that protects unicast and multicast management frames from being intercepted and changed for malicious purposes. This feature is disabled by default, but you can enable it as either optional or mandatory.</p> <p>Select <b>Mandatory</b> to require devices to use PMF. Devices that do not support PMF cannot connect to the WiFi network. If you select WPA3 Personal authentication or WiFi enhanced open authentication, PMF becomes mandatory automatically.</p> <p>Select <b>Optional</b> to let the access point automatically activate PMF based on whether devices can support PMF.</p>
Band	<p>Select a radio button for a single band (<b>2.4 GHz</b> or <b>5 GHz</b>) or keep the default selection, which is the <b>Both</b> radio button, to enable the VAP to broadcast on both bands.</p>
Band Steering / 802.11 k/v	<p>By default, band steering with 802.11k RRM and 802.11v WiFi network management is disabled for the VAP.</p> <p>To enable band steering with 802.11k RRM and 802.11v WiFi network management, select the <b>Enable</b> radio button. Doing so allows the access point, under certain channel conditions, to steer WiFi devices that are dual-band capable to the 2.4 GHz or 5 GHz band of the VAP. Compared to the 2.4 GHz band, generally more channels and bandwidth are available in the 5 GHz band, causing less interference and allowing for a better user experience.</p> <p>802.11k RRM and 802.11v WiFi network management affect the network in the following ways:</p> <ul style="list-style-type: none"> <li>• <b>802.11k RRM.</b> This feature lets the access point and 802.11k-aware clients dynamically measure the available radio resources. In an 802.11k-enabled network, access points and clients can send neighbor reports, beacon reports, and link measurement reports to each other, allowing 802.11k-aware clients to automatically select the best access point for initial connection or for roaming.</li> <li>• <b>802.11v WiFi network management.</b> This feature lets the access point steer its WiFi clients to the 2.4 GHz or 5 GHz band, based on the access point's channel load.</li> </ul> <p>The access point sets the received signal strength indicator (RSSI) threshold automatically. (That is, you cannot configure the RSSI threshold manually.)</p>

10. Optionally, to configure client isolation, configure URL tracking, configure if a DHCP Offer message is unicast or broadcast, or do all of this, click the **> Advanced** tab.



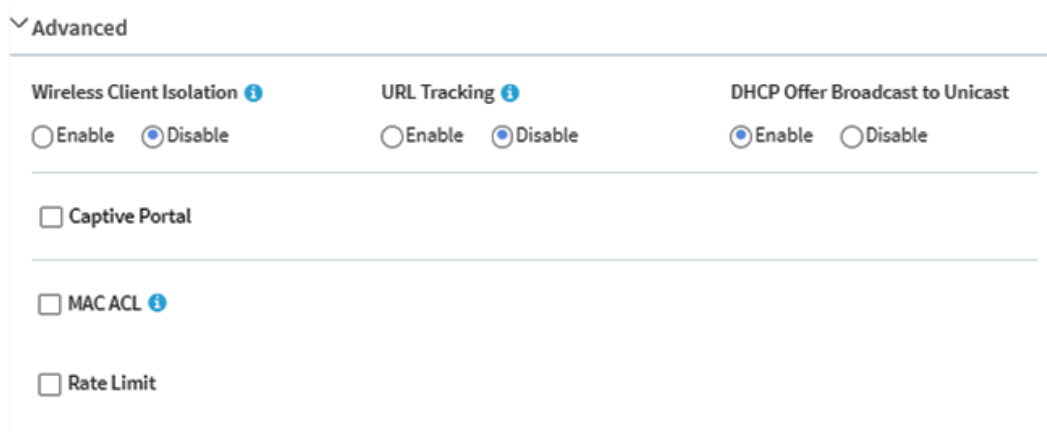

11. Configure the client isolation, URL tracking, and DHCP Offer message settings as described in the following table.

Setting	Description
Wireless Client Isolation	<p>By default, client isolation is disabled for the VAP, and the <b>Disable</b> radio button is selected. To block communication between WiFi clients that are associated with the same SSID or different SSIDs on the access point, select the <b>Enable</b> radio button.</p> <p>If the management VLAN and WiFi network VLAN are identical (by default, both are VLAN 1) and you enable client isolation, the <b>Allow Access to AP UI</b> check box displays. By default, this check box is selected, allowing an admin user to access the local browser UI over WiFi. If you clear the <b>Allow Access to AP UI</b>, an admin user cannot access the local browser UI over WiFi.</p> <p><b>Note:</b> If the management VLAN and WiFi network VLAN are identical (which they are by default), an admin user can always access the local browser UI over a wired network connection.</p>
URL Tracking	<p>By default, URL tracking is disabled, and the <b>Disable</b> radio button is selected. To enable URL tracking for all URLs that are requested by WiFi clients that are connected to the SSID, select the <b>Enable</b> radio button.</p> <p>For information about how to view the tracked URLs per SSID or per WiFi client, see <a href="#">View or download tracked URLs</a> on page 190.</p>
DHCP Offer Broadcast to Unicast	<p>When a device tries to associate with the WiFi network and negotiates an IP address, the access point converts the broadcast DHCP offer message that it receives from the DHCP server to a unicast message, and forwards it to the device. This is the default option (that is, the <b>Enable</b> radio button is selected). To disable this option so that the access point does not convert the broadcast DHCP offer messages to unicast messages, select the <b>Disable</b> radio button.</p>

12. To configure a captive portal, a MAC ACL, and bandwidth rate limits, see the information in the following sections:

- [Set Up and Manage a Captive Portal](#) on page 100
- [Manage local MAC access control lists](#) on page 120 and [Select a MAC ACL for a WiFi network](#) on page 82
- [Set bandwidth rate limits for a WiFi network](#) on page 84

Although you could also configure these features while you set up a WiFi network, these features are more complicated and therefore described separately.

13. Click the **Apply** button.

Your settings are saved.

14. Make sure that you can connect to the new WiFi network.

If you cannot connect to the new WiFi network, check the following:

- If your WiFi-enabled computer or mobile device is already connected to another WiFi network in your area, disconnect it from that WiFi network and connect it to the correct WiFi network. Some WiFi devices automatically connect to the first open network without WiFi security that they discover.
- If your WiFi-enabled computer or mobile device is trying to connect to your network with its old settings (before you changed the settings), update the WiFi network selection in your WiFi-enabled computer or mobile device to match the current settings for your network.
- Does your WiFi device display as a connected client? (See [View client distribution, connected clients, and client trends](#) on page 185.) If it does, it is connected to the network.
- Are you using the correct WiFi network name (SSID) and password?
- If the WiFi authentication and encryption is set to WPA3 Personal, make sure that the WiFi adapter device driver is updated to the latest version on your WiFi-enabled computer or mobile device.

# View or change the settings of a WiFi network

You can view or change the settings of the default WiFi network (SSID or VAP) or any custom WiFi network.

## To view or change the settings of a WiFi network:

1. Launch a web browser from a computer that is connected to the same network as the access point or directly to the access point through an Ethernet cable or WiFi connection.

2. Enter the IP address that is assigned to the access point.

A login window displays.

If your browser does not display the login window but displays a security message and does not let you proceed, see [Log in to the access point after initial setup](#) on page 46.

3. Enter the access point user name and password.

The user name is **admin**. The password is the one that you specified. The user name and password are case-sensitive.

If you previously added the access point to a NETGEAR Insight network location and managed the access point through the Insight app or Insight Cloud portal, enter the Insight network password for that location. For more information, see [Connect over WiFi using the NETGEAR Insight app](#) on page 31.

The Dashboard page displays.

4. Select **Management > Configuration > Wireless > Basic**.

The page that displays lets you select an SSID.

5. Click the ► button to the left of the SSID.

The settings for the selected SSID display.

6. Change the settings of the WiFi network as needed.

For detailed descriptions of the settings, see [Set up an open or secure WiFi network](#) on page 60.

7. If you made changes, click the **Apply** button.

Your settings are saved.

8. If you made changes, make sure that you can reconnect over WiFi to the network with its new settings.

If you cannot connect over WiFi, check the following:

- If your WiFi-enabled computer or mobile device is already connected to another WiFi network in your area, disconnect it from that WiFi network and connect it to the correct WiFi network. Some WiFi devices automatically connect to the first open network without WiFi security that they discover.
- If your WiFi-enabled computer or mobile device is trying to connect to your network with its old settings (before you changed the settings), update the WiFi network selection in your WiFi-enabled computer or mobile device to match the current settings for your network.
- Does your WiFi device display as a connected client? (See [View client distribution, connected clients, and client trends](#) on page 185.) If it does, it is connected to the network.
- Are you using the correct WiFi network name (SSID) and password?

## Disable or enable a WiFi network or set up a WiFi activity schedule

You can temporarily disable a WiFi network (SSID or VAP), you can reenabte the WiFi network, or you can set up a schedule that specifies when the WiFi network is active.

Scheduling a WiFi network a green feature that allows you to turn off the WiFi network during scheduled vacations, office shutdowns, on evenings, or on weekends.

For each WiFi network, you can create a single custom schedule. In that schedule, for each day from 12:00 a.m. to 11:59 p.m., you specify the time or times that the VAP is disabled.

### **To disable or enable a WiFi network or set up a WiFi activity schedule:**

1. Launch a web browser from a computer that is connected to the same network as the access point or directly to the access point through an Ethernet cable or WiFi connection.

2. Enter the IP address that is assigned to the access point.

A login window displays.

If your browser does not display the login window but displays a security message and does not let you proceed, see [Log in to the access point after initial setup](#) on page 46.

3. Enter the access point user name and password.

The user name is **admin**. The password is the one that you specified. The user name and password are case-sensitive.

If you previously added the access point to a NETGEAR Insight network location and managed the access point through the Insight app or Insight Cloud portal, enter the Insight network password for that location. For more information, see [Connect over WiFi using the NETGEAR Insight app](#) on page 31.

The Dashboard page displays.

4. Select **Management > Configuration > Wireless > Basic**.

The page that displays lets you select an SSID.

5. Click the ► button to the left of the SSID.

The settings for the selected SSID display.

6. Under Schedule, select one of the following radio buttons:

- **Always ON**. The WiFi network is enabled.
- **Always OFF**. The WiFi network is disabled.
- **Custom**. The WiFi network is enabled or disabled according to a schedule that you must set up.  
An icon displays to the right of the radio button.

7. If you selected **Custom** in the previous step, do the following:

- a. Click the icon next to the radio button.

A pop-up window displays.

- b. Either select a predefined time from the **Preset** menu or select custom time blocks by clicking the time blocks.

A blue color for a time block indicates that the WiFi network will be enabled (on).

A gray color for a time block indicates that the WiFi network will be disabled (off).

- c. Click the **Done** button.

The pop-up window closes.

8. Click the **Apply** button.

Your settings are saved.

# Remove a WiFi network

You can remove a custom WiFi network (SSID or VAP) that you no longer need. You cannot remove the default WiFi network.

## To remove a WiFi network:

1. Launch a web browser from a computer that is connected to the same network as the access point or directly to the access point through an Ethernet cable or WiFi connection.

2. Enter the IP address that is assigned to the access point.  
A login window displays.

If your browser does not display the login window but displays a security message and does not let you proceed, see [Log in to the access point after initial setup](#) on page 46.

3. Enter the access point user name and password.

The user name is **admin**. The password is the one that you specified. The user name and password are case-sensitive.

If you previously added the access point to a NETGEAR Insight network location and managed the access point through the Insight app or Insight Cloud portal, enter the Insight network password for that location. For more information, see [Connect over WiFi using the NETGEAR Insight app](#) on page 31.

The Dashboard page displays.

4. Select **Management > Configuration > Wireless > Basic**.

The page that displays lets you select an SSID.

5. Click the trash can icon to the right of the SSID.

A warning pop-up window displays.

6. Click the **Delete** button.

The pop-window closes and the WiFi network is removed.

# Change the authentication and encryption for a WiFi network

You can change the authentication and encryption of the default WiFi network (SSID or VAP) or any custom WiFi network.

Before you change the authentication and encryption, consider the types of clients that must be able to connect to the WiFi network. WPA3 provides a more secure connection than WPA2, but many WiFi devices might not yet detect WPA3 and support only WPA2. Similarly, WPA2 provides a more secure connection than WPA, but some legacy WiFi devices do not detect WPA2 and support only WPA.

If you plan to use WPA2 Enterprise security for your WiFi network, first set up RADIUS servers (see [Set up RADIUS servers](#) on page 133).

### To change the authentication and encryption for a WiFi network:

1. Launch a web browser from a computer that is connected to the same network as the access point or directly to the access point through an Ethernet cable or WiFi connection.
2. Enter the IP address that is assigned to the access point.  
A login window displays.  
If your browser does not display the login window but displays a security message and does not let you proceed, see [Log in to the access point after initial setup](#) on page 46.
3. Enter the access point user name and password.  
The user name is **admin**. The password is the one that you specified. The user name and password are case-sensitive.  
If you previously added the access point to a NETGEAR Insight network location and managed the access point through the Insight app or Insight Cloud portal, enter the Insight network password for that location. For more information, see [Connect over WiFi using the NETGEAR Insight app](#) on page 31.  
The Dashboard page displays.
4. Select **Management > Configuration > Wireless > Basic**.  
The page that displays lets you select and add an SSID.
5. Click the **+** button to the left of Add SSID.  
The settings for the selected SSID display.
6. Specify the WiFi security by selecting an option from the **Authentication** menu and, if applicable, by specifying a passphrase in the **Passphrase** field or selecting an option from the **Encryption** menu, as described in the following table.

Setting	Description
Open	<p>A legacy open WiFi network does not provide any security. Any WiFi device can join the network. We recommend that you do <i>not</i> use a legacy open WiFi network but configure WiFi security. However, a legacy open network might be appropriate for a WiFi hotspot. If you select <b>Open</b> from the <b>Authentication</b> menu, the <b>Enhanced Open</b> check box displays.</p> <ul style="list-style-type: none"> <li>• <b>Enhanced Open check box cleared.</b> The WiFi network is a legacy open network without any security. This is the default option for an open network. Clients are not authenticated, traffic is not encrypted, and 802.11w (PMF) is automatically disabled (see <a href="#">Enable or disable PMF for a WiFi network</a> on page 79).</li> <li>• <b>Enhanced Open check box selected.</b> The WiFi network can only accept clients that support the WiFi enhanced open feature, which is based on opportunistic wireless encryption (OWE). Select this option only if all the clients in the WiFi network support OWE. If you select this option, the encryption is CCM mode protocol (CCMP), and 802.11w (PMF) is automatically set to mandatory (see <a href="#">Enable or disable PMF for a WiFi network</a> on page 79).</li> </ul>
WPA2 Personal	<p>This option, which is the same as WPA2-PSK, is the default setting and uses AES encryption. This type of security enables only WiFi devices that support WPA2 to join the VAP. WPA2 provides a more secure connection than WPA but some legacy WiFi devices do not detect WPA2 and support only WPA. If your network includes such older devices, select <b>WPA2/WPA Personal</b> authentication.</p> <p>In the <b>Passphrase</b> field, enter a phrase of 8 to 63 characters. To join the VAP, a user must enter this passphrase. To view the passphrase in clear text, click the eye icon.</p>
WPA2/WPA Personal	<p>This option, which is the same as WPA2-PSK/WPA-PSK, enables WiFi devices that support either WPA2 or WPA to join the VAP. This option uses AES and TKIP encryption. WPA-PSK (which uses TKIP) is less secure than WPA2-PSK (which uses AES) and limits the speed of WiFi devices to 54 Mbps.</p> <p>In the <b>Passphrase</b> field, enter a phrase of 8 to 63 characters. To join the VAP, a user must enter this passphrase. To view the passphrase in clear text, click the eye icon.</p>
WPA2 Enterprise	<p>This enterprise-level security uses RADIUS for centralized Authentication, Authorization, and Accounting (AAA) management. For WPA2 Enterprise security to function, you must set up RADIUS servers (see <a href="#">Set up RADIUS servers</a> on page 133).</p> <p>From the <b>Encryption</b> menu, select the data encryption mode:</p> <ul style="list-style-type: none"> <li>• <b>TKIP + AES.</b> This type of data encryption enables WiFi devices that support either WPA or WPA2 to join the access point's WiFi network. This is the default mode.</li> <li>• <b>AES.</b> This type of data encryption provides a secure connection but some older WiFi devices do not detect WPA2 and support only WPA. Therefore, if your network includes such older devices, select <b>TKIP + AES</b> encryption.</li> </ul>



(Continued)

Setting	Description
WPA3 Personal	<p>This option is the most secure personal authentication option. WPA3 uses SAE encryption and enables only WiFi devices that support WPA3 to join the VAP. If you select this option, 802.11w (PMF) is automatically set to mandatory (see <a href="#">Enable or disable PMF for a WiFi network</a> on page 79).</p> <p>WPA3 provides a more secure connection than WPA2 but many WiFi devices might not yet detect WPA3 and support only WPA2. If your network also includes WPA2 devices, select <b>WPA3/WPA2 Personal</b> authentication.</p> <p>In the <b>Passphrase</b> field, enter a phrase of 8 to 63 characters. To join the VAP, a user must enter this passphrase. To view the passphrase in clear text, click the eye icon.</p>
WPA3/WPA2 Personal	<p>This option, which is the same as WPA3/WPA2-PSK, enables WiFi devices that support either WPA3 or WPA2 to join the VAP. This option uses SAE and AES encryption. WPA2-PSK (which uses AES) is less secure than WPA3 (which uses SAE).</p> <p>In the <b>Passphrase</b> field, enter a phrase of 8 to 63 characters. To join the VAP, a user must enter this passphrase. To view the passphrase in clear text, click the eye icon.</p>

7. Click the **Apply** button.

Your settings are saved.

8. Make sure that you can connect to the new WiFi network.

If you cannot connect to the new WiFi network, check the following:

- If your WiFi-enabled computer or mobile device is already connected to another WiFi network in your area, disconnect it from that WiFi network and connect it to the correct WiFi network. Some WiFi devices automatically connect to the first open network without WiFi security that they discover.
- If your WiFi-enabled computer or mobile device is trying to connect to your network with its old settings (before you changed the settings), update the WiFi network selection in your WiFi-enabled computer or mobile device to match the current settings for your network.
- Does your WiFi device display as a connected client? (See [View client distribution, connected clients, and client trends](#) on page 185.) If it does, it is connected to the network.
- Are you using the correct WiFi network name (SSID) and password?
- If you changed the WiFi authentication and encryption to WPA3 Personal, make sure that the WiFi adapter device driver is updated to the latest version on your WiFi-enabled computer or mobile device.

# Hide or broadcast the SSID for a WiFi network

By default, a WiFi network (SSID or VAP) broadcasts its network name (also referred to as the SSID) so that WiFi clients can detect the SSID in their scanned network lists. For additional security, you can turn off the SSID broadcast and hide the SSID so that users must know the SSID to be able to join the WiFi network.

**Note:** If you set up a wireless distribution system (WDS; see [Set up a WiFi Bridge](#) on page 197), you must keep the SSID broadcast enabled.

## To hide or broadcast the network name for a WiFi network:

1. Launch a web browser from a computer that is connected to the same network as the access point or directly to the access point through an Ethernet cable or WiFi connection.

2. Enter the IP address that is assigned to the access point.

A login window displays.

If your browser does not display the login window but displays a security message and does not let you proceed, see [Log in to the access point after initial setup](#) on page 46.

3. Enter the access point user name and password.

The user name is **admin**. The password is the one that you specified. The user name and password are case-sensitive.

If you previously added the access point to a NETGEAR Insight network location and managed the access point through the Insight app or Insight Cloud portal, enter the Insight network password for that location. For more information, see [Connect over WiFi using the NETGEAR Insight app](#) on page 31.

The Dashboard page displays.

4. Select **Management > Configuration > Wireless > Basic**.

The page that displays lets you select an SSID.

5. Click the ► button to the left of the SSID.

The settings for the selected SSID display.

6. Under Broadcast SSID, select one of the following radio buttons:

- **No.** The SSID is hidden for the WiFi network.
- **Yes.** The SSID is broadcast for the WiFi network.

7. Click the **Apply** button.  
Your settings are saved.

## Enable or disable client isolation for a WiFi network

By default, client isolation is disabled for a WiFi network (SSID or VAP), allowing communication between WiFi clients that are associated with the same or different WiFi networks on the access point. For additional security, you can enable client isolation so that clients that are associated with the same or different WiFi networks *cannot* communicate with each other, except for communication over the Internet, which remains possible.

### To enable or disable client isolation for a WiFi network:

1. Launch a web browser from a computer that is connected to the same network as the access point or directly to the access point through an Ethernet cable or WiFi connection.

2. Enter the IP address that is assigned to the access point.  
A login window displays.

If your browser does not display the login window but displays a security message and does not let you proceed, see [Log in to the access point after initial setup](#) on page 46.

3. Enter the access point user name and password.

The user name is **admin**. The password is the one that you specified. The user name and password are case-sensitive.

If you previously added the access point to a NETGEAR Insight network location and managed the access point through the Insight app or Insight Cloud portal, enter the Insight network password for that location. For more information, see [Connect over WiFi using the NETGEAR Insight app](#) on page 31.

The Dashboard page displays.

4. Select **Management > Configuration > Wireless > Basic**.

The page that displays lets you select an SSID.

5. Click the ► button to the left of the SSID.

The settings for the selected SSID display.

6. Click the > **Advanced** tab.

The page expands.

7. Under Client Isolation, select one of the following radio buttons:

- **Disable.** Client isolation is disabled for the WiFi network. This is the default setting.
- **Enable.** Client isolation is enabled for the WiFi network.  
If the management VLAN and WiFi network VLAN are identical (by default, both are VLAN 1) and you enable client isolation, the **Allow Access to AP UI** check box displays. By default, this check box is selected, allowing an admin user to access the local browser UI over WiFi. If you clear the **Allow Access to AP UI**, an admin user cannot access the local browser UI over WiFi.

**Note:** If the management VLAN and WiFi network VLAN are identical (which they are by default), an admin user can always access the local browser UI over a wired network connection.

8. Click the **Apply** button.

Your settings are saved.

## Enable or disable band steering with 802.11k RRM and 802.11v WiFi network management

Band steering lets the access point identify the WiFi devices that are dual-band capable and steer those devices to the 2.4 GHz or 5 GHz band of a WiFi network (SSID or VAP). Compared to the 2.4 GHz band, generally more channels and bandwidth are available in the 5 GHz band, causing less interference and allowing for a better user experience. Band steering includes 802.11k radio resource management (RRM) and 802.11v WiFi network management. By default, band steering is disabled.

802.11k RRM and 802.11v WiFi network management affect the network in the following ways:

- **802.11k RRM.** This feature lets the access point and 802.11k-aware clients dynamically measure the available radio resources. In an 802.11k-enabled network, access points and clients can send neighbor reports, beacon reports, and link measurement reports to each other, allowing 802.11k-aware clients to automatically select the best access point for initial connection or for roaming.
- **802.11v WiFi network management.** This feature lets the access point steer its WiFi clients to the 2.4 GHz or 5 GHz band, based on the access point's channel load.

In an environment with multiple access points, 802.11v WiFi network management helps WiFi clients that are roaming to select the best access point.

The access point sets the received signal strength indicator (RSSI) threshold automatically. (That is, you cannot configure the RSSI threshold manually.)

### **To enable or disable band steering with 802.11k RRM and 802.11v WiFi network management for a WiFi network:**

1. Launch a web browser from a computer that is connected to the same network as the access point or directly to the access point through an Ethernet cable or WiFi connection.

2. Enter the IP address that is assigned to the access point.

A login window displays.

If your browser does not display the login window but displays a security message and does not let you proceed, see [Log in to the access point after initial setup](#) on page 46.

3. Enter the access point user name and password.

The user name is **admin**. The password is the one that you specified. The user name and password are case-sensitive.

If you previously added the access point to a NETGEAR Insight network location and managed the access point through the Insight app or Insight Cloud portal, enter the Insight network password for that location. For more information, see [Connect over WiFi using the NETGEAR Insight app](#) on page 31.

The Dashboard page displays.

4. Select **Management > Configuration > Wireless > Basic**.

The page that displays lets you select an SSID.

5. Click the ► button to the left of the SSID.

The settings for the selected SSID display.

6. Under Band Steering / 802.11 k/v, select one of the following radio buttons:

- **Disable**. Band steering is disabled for the VAP. This is the default setting.
- **Enabled**. Under certain channel conditions, the access point steers WiFi devices that are dual-band capable to the 2.4 GHz or 5 GHz band of the VAP.

7. Click the **Apply** button.

Your settings are saved.

# Change the VLAN ID for a WiFi network

The VLAN ID for a WiFi network is not the same as the 802.1Q VLAN ID that is used for the wired network (see [Set the 802.1Q VLAN and management VLAN](#) on page 140).

**CAUTION:** Before you change the VLAN ID, be sure that the VLAN is configured on the network switch and the DHCP server and that the access point and its clients can get IP addresses over the new VLAN.

## To change the VLAN ID for a WiFi network:

1. Launch a web browser from a computer that is connected to the same network as the access point or directly to the access point through an Ethernet cable or WiFi connection.

2. Enter the IP address that is assigned to the access point.

A login window displays.

If your browser does not display the login window but displays a security message and does not let you proceed, see [Log in to the access point after initial setup](#) on page 46.

3. Enter the access point user name and password.

The user name is **admin**. The password is the one that you specified. The user name and password are case-sensitive.

If you previously added the access point to a NETGEAR Insight network location and managed the access point through the Insight app or Insight Cloud portal, enter the Insight network password for that location. For more information, see [Connect over WiFi using the NETGEAR Insight app](#) on page 31.

The Dashboard page displays.

4. Select **Management > Configuration > Wireless > Basic**.

The page that displays lets you select an SSID.

5. Click the ► button to the left of the SSID.

The settings for the selected SSID display.

6. In the **VLAN ID** field, enter a ID (that is, a number).

By default, the VLAN ID for a WiFi network is 1.

7. Click the **Apply** button.

Your settings are saved.

# Enable or disable PMF for a WiFi network

Protected Management Frames (PMF), according to the 802.11w standard, is a security feature that protects unicast and multicast management frames from being intercepted and changed for malicious purposes. This feature is disabled by default, but you can enable it as either optional or mandatory.

## To enable or disable PMF for a WiFi network:

1. Launch a web browser from a computer that is connected to the same network as the access point or directly to the access point through an Ethernet cable or WiFi connection.

2. Enter the IP address that is assigned to the access point.

A login window displays.

If your browser does not display the login window but displays a security message and does not let you proceed, see [Log in to the access point after initial setup](#) on page 46.

3. Enter the access point user name and password.

The user name is **admin**. The password is the one that you specified. The user name and password are case-sensitive.

If you previously added the access point to a NETGEAR Insight network location and managed the access point through the Insight app or Insight Cloud portal, enter the Insight network password for that location. For more information, see [Connect over WiFi using the NETGEAR Insight app](#) on page 31.

The Dashboard page displays.

4. Select **Management > Configuration > Wireless > Basic**.

The page that displays lets you select an SSID.

5. Click the ► button to the left of the SSID.

The settings for the selected SSID display.

6. Under 802.11w (PMF), select one of the following radio buttons:

- **Mandatory**. Requires devices to use PMF. Devices that do not support PMF cannot connect to the WiFi network. If you select WPA3 Personal authentication or WiFi enhanced open authentication, PMF becomes mandatory automatically.
- **Optional**. Lets the access point automatically activate PMF based on whether devices can support PMF.
- **Disable**. PMF is disabled for the WiFi network.

7. Click the **Apply** button.  
Your settings are saved.

## Enable or disable URL tracking for a WiFi network

You can enable the access point to track all URLs that are requested by WiFi clients that are connected to a WiFi network (SSID or VAP). This feature is disabled by default, but you can enable it.

For information about how to view the tracked URLs per SSID or per WiFi client, see [View or download tracked URLs](#) on page 190.

### To enable or disable URL tracking for a WiFi network:

1. Launch a web browser from a computer that is connected to the same network as the access point or directly to the access point through an Ethernet cable or WiFi connection.

2. Enter the IP address that is assigned to the access point.

A login window displays.

If your browser does not display the login window but displays a security message and does not let you proceed, see [Log in to the access point after initial setup](#) on page 46.

3. Enter the access point user name and password.

The user name is **admin**. The password is the one that you specified. The user name and password are case-sensitive.

If you previously added the access point to a NETGEAR Insight network location and managed the access point through the Insight app or Insight Cloud portal, enter the Insight network password for that location. For more information, see [Connect over WiFi using the NETGEAR Insight app](#) on page 31.

The Dashboard page displays.

4. Select **Management > Configuration > Wireless > Basic**.

The page that displays lets you select an SSID.

5. Click the **>** button to the left of the SSID.

The settings for the selected SSID display.

6. Click the **> Advanced** tab.

The page expands.



7. Under URL Tracking, select one of the following radio buttons:
  - **Enable.** URL Tracking is enabled for the WiFi network.
  - **Disable.** URL Tracking is disabled for the WiFi network.
8. Click the **Apply** button.  
Your settings are saved.

## Change the format of the DHCP offer messages in a WiFi network

When a device tries to associate with the WiFi network and negotiates an IP address, the access point converts the broadcast DHCP offer message that it receives from the DHCP server to a unicast message, and forwards it to the device. This is the default configuration. For the DHCP message exchange, unicast packets are more reliable and minimize the traffic in the network. However, if your situation requires that DHCP offer messages must be distributed as broadcast packets, you can change the format so that in a specific WiFi network, the access point does *not* convert the broadcast DHCP offer messages to unicast messages.

### To change the format of the DHCP offer messages in a WiFi network:

1. Launch a web browser from a computer that is connected to the same network as the access point or directly to the access point through an Ethernet cable or WiFi connection.
2. Enter the IP address that is assigned to the access point.  
A login window displays.  
  
If your browser does not display the login window but displays a security message and does not let you proceed, see [Log in to the access point after initial setup](#) on page 46.
3. Enter the access point user name and password.  
The user name is **admin**. The password is the one that you specified. The user name and password are case-sensitive.  
  
If you previously added the access point to a NETGEAR Insight network location and managed the access point through the Insight app or Insight Cloud portal, enter the Insight network password for that location. For more information, see [Connect over WiFi using the NETGEAR Insight app](#) on page 31.  
  
The Dashboard page displays.

4. Select **Management > Configuration > Wireless > Basic**.

The page that displays lets you select an SSID.

5. Click the ► button to the left of the SSID.

The settings for the selected SSID display.

6. Click the ► **Advanced** tab.

The page expands.

7. Under DHCP Offer Broadcast to Unicast, select one of the following radio buttons:

- **Enable**. The access point forwards DHCP offer messages as unicast packets in the WiFi network. This is the default selection.
- **Disable**. The access point forwards DHCP offer messages as broadcast packets in the WiFi network.

8. Click the **Apply** button.

Your settings are saved

## Select a MAC ACL for a WiFi network

After you set up one or more local MAC access control lists (ACLs, also referred to as access lists; see [Manage local MAC access control lists](#) on page 120), you can select an ACL for use with an SSID. Only WiFi devices for which the MAC address is on the MAC ACL can connect to the access point through this SSID. (These devices might be able to connect to the access point through another SSID if you did not set up MAC ACL security for that SSID.)

You can also set up a RADIUS server (see [Set up RADIUS servers](#) on page 133) and select the RADIUS MAC ACL. You must define the ACL on the RADIUS server, using the following format for client MAC addresses in the RADIUS server: If the client MAC address is 00:0a:95:9d:68:16, specify it as 000a959d6816 in the RADIUS server.

**Note:** A RADIUS MAC ACL cannot function if the WiFi security is WPA2 Enterprise. If you want to use a RADIUS MAC ACL, select a different type of WiFi security for the WiFi network (see [Change the authentication and encryption for a WiFi network](#) on page 70).

When selected, the MAC ACL blocks WiFi access to the SSID for WiFi devices that are not in the selected access list. The blockage applies only to the SSID for which you enable the MAC ACL. Only WiFi devices that are in the selected access list can connect to the SSID.

### To select a MAC ACL for a WiFi network:

1. Launch a web browser from a computer that is connected to the same network as the access point or directly to the access point through an Ethernet cable or WiFi connection.

2. Enter the IP address that is assigned to the access point.

A login window displays.

If your browser does not display the login window but displays a security message and does not let you proceed, see [Log in to the access point after initial setup](#) on page 46.

3. Enter the access point user name and password.

The user name is **admin**. The password is the one that you specified. The user name and password are case-sensitive.

If you previously added the access point to a NETGEAR Insight network location and managed the access point through the Insight app or Insight Cloud portal, enter the Insight network password for that location. For more information, see [Connect over WiFi using the NETGEAR Insight app](#) on page 31.

The Dashboard page displays.

4. Select **Management > Configuration > Wireless > Basic**.

The page that displays lets you select an SSID.

5. Click the ► button to the left of the SSID.

The settings for the selected SSID display.

6. Click the ► **Advanced** tab.

The page expands.

7. Select the **MAC ACL** check box.

8. Do one of the following:

- Select the **Local MAC ACL** radio button, and from the **Select Group** menu, select the MAC ACL that you defined earlier.  
To change the MAC ACL policy, MAC addresses in the ACL, or both, click the link next to the group. For more information, see [Manage local MAC access control lists](#) on page 120.
- Select the **Radius MAC ACL** radio button.  
This option functions only if you set up a RADIUS server (see [Set up RADIUS servers](#) on page 133).

9. Click the **Apply** button.

Your settings are saved.

## Set bandwidth rate limits for a WiFi network

You can set rate limits for the upload and download bandwidths for devices that are connected to a WiFi network. The minimum bandwidth rate is 64 Kbps, the maximum bandwidth rate is 1024 Mbps. You can set one rate for the upload bandwidth and another rate for the download bandwidth.

**Note:** Before you set bandwidth rate limits, check the Internet speed of the access point (see [Check the Internet speed](#) on page 218).

### To set bandwidth rate limits for devices that are connected to a WiFi network:

1. Launch a web browser from a computer that is connected to the same network as the access point or directly to the access point through an Ethernet cable or WiFi connection.

2. Enter the IP address that is assigned to the access point.

A login window displays.

If your browser does not display the login window but displays a security message and does not let you proceed, see [Log in to the access point after initial setup](#) on page 46.

3. Enter the access point user name and password.

The user name is **admin**. The password is the one that you specified. The user name and password are case-sensitive.

If you previously added the access point to a NETGEAR Insight network location and managed the access point through the Insight app or Insight Cloud portal, enter the Insight network password for that location. For more information, see [Connect over WiFi using the NETGEAR Insight app](#) on page 31.

The Dashboard page displays.

4. Select **Management > Configuration > Wireless > Basic**.

The page that displays lets you select an SSID.

5. Click the **>** button to the left of the SSID.

The settings for the selected SSID display.

6. Click the **> Advanced** tab.

The page expands.

7. Select the **Rate Limit** check box.
8. Specify the values:
  - **Upload.** For the upload bandwidth limitation, enter a value from 64 to 1024 and select **Kbps** or **Mbps** from the menu.
  - **Download.** For the download bandwidth limitation, enter a value from 64 to 1024 and select **Kbps** or **Mbps** from the menu.
9. Click the **Apply** button.  
Your settings are saved.

# 7

## Manage the Basic Radio Features

---

This chapter describes how you can manage the basic radio settings of the access point. For information about the advanced radio settings, see [Manage the Advanced Radio Features](#) on page 202.

**CAUTION:** If you change a radio feature on the 2.4 GHz radio, the change affects all WiFi networks that broadcast on the 2.4 GHz radio. Similarly, if you change a radio feature on the 5 GHz radio, the change affects all WiFi networks that broadcast on the 5 GHz radio. If the change is not specific to one radio, the change affects *all* WiFi networks on the access point.

**Tip:** If you want to change the settings of the access point's WiFi network, use a wired connection to avoid being disconnected when the new WiFi settings take effect.

The chapter includes the following sections:

- [Manage the basic WiFi settings for the radios](#)
- [Turn a radio on or off](#)
- [Change the WiFi mode for a radio](#)
- [Change the channel width for a radio](#)
- [Change the guard interval for a radio](#)
- [Change the output power for a radio](#)
- [Change the channel for a radio](#)
- [Manage Quality of Service for a WiFi radio](#)

# Manage the basic WiFi settings for the radios

The basic WiFi settings for the radios apply to all WiFi networks (VAPs or SSIDs). You can specify the radio settings for the 2.4 GHz and 5 GHz radios individually.

## To manage the basic WiFi settings for the radios:

1. Launch a web browser from a computer that is connected to the same network as the access point or directly to the access point through an Ethernet cable or WiFi connection.

2. Enter the IP address that is assigned to the access point.  
A login window displays.

If your browser does not display the login window but displays a security message and does not let you proceed, see [Log in to the access point after initial setup](#) on page 46.

3. Enter the access point user name and password.

The user name is **admin**. The password is the one that you specified. The user name and password are case-sensitive.

If you previously added the access point to a NETGEAR Insight network location and managed the access point through the Insight app or Insight Cloud portal, enter the Insight network password for that location. For more information, see [Connect over WiFi using the NETGEAR Insight app](#) on page 31.

The Dashboard page displays.

4. Select **Management > Configuration > Wireless > Basic > Wireless Settings**.

The screenshot shows the 'Wireless Settings' configuration page. It is divided into two sections: '2.4 GHz' and '5 GHz'. Each section has a 'Turn Radio ON' checkbox, which is checked in both. Below each section are three columns of settings: 'Wireless Mode', 'Channel Width', and 'Guard Interval'. For the 2.4 GHz section, the Wireless Mode is set to '11ax', Channel Width is 'Dynamic 20 / 40 MHz', and Guard Interval is 'Long-800 ns'. For the 5 GHz section, the Wireless Mode is set to '11ax', Channel Width is 'Dynamic 20 / 40 / 80 MHz', and Guard Interval is 'Long-800 ns'. Below these settings are 'Output Power' and 'Channel' dropdown menus, both set to '100%(Max)' and 'Auto' respectively. At the bottom of the page are 'Cancel' and 'Apply' buttons.

5. Configure the settings as described in the following table.

The descriptions in the table apply to both radios, but you can specify the radio settings for the 2.4 GHz and 5 GHz radios individually.

Setting	Description
Turn Radio On	By default, the <b>Turn Radio On</b> check box is selected and the radio broadcasts. Turning off a radio disables WiFi access for the band, which can be helpful during configuration, network tuning, or troubleshooting.
Wireless Mode	<p>Select one of the following wireless modes (WiFi modes) for the 2.4 GHz radio:</p> <ul style="list-style-type: none"> <li>• <b>11ax.</b> 802.11ax, 802.11ng, 802.11bg, and 802.11b WiFi clients can connect to the access point. This is the default setting.</li> <li>• <b>11ng.</b> 802.1ax, 802.11ng, 802.11bg, and 802.11b WiFi clients can connect to the access point. However, the speed of 802.11ax clients is limited to the maximum speed that is supported by 802.11ng (about 400 Mbps).</li> <li>• <b>11bg.</b> 802.11ax, 802.11ng, 802.11bg, and 802.11b WiFi clients can connect to the access point. However, the speed of 802.1ax and 802.11ng clients is limited to the maximum speed that is supported by 802.11bg (about 54 Mbps).</li> <li>• <b>11b.</b> 802.1ax, 802.11ng, 802.11bg, and 802.11b WiFi clients can connect to the access point. However, the speed of 802.11ax, 802.11n, and 802.11bg clients is limited to the maximum speed that is supported by 802.11b (about 11 Mbps).</li> </ul> <p>Select one of the following wireless modes (WiFi modes) for the 5 GHz radio:</p> <ul style="list-style-type: none"> <li>• <b>11ax.</b> 802.11ax, 802.11ac, 802.11na, and 802.11a WiFi clients can connect to the access point. This is the default setting.</li> <li>• <b>11ac.</b> 802.11ax, 802.11ac, 802.11na, and 802.11a WiFi clients can connect to the access point. However, the speed of 802.11ax clients is limited to the maximum speed that is supported by 802.11ac (about 867 Mbps).</li> <li>• <b>11na.</b> 802.11ax, 802.11ac, 802.11na, and 802.11a WiFi clients can connect to the access point. However, the speed of 802.11ax and 802.11ac clients is limited to the maximum speed that is supported by 802.11na (about 450 Mbps).</li> <li>• <b>11a.</b> 802.11ax, 802.11ac, 802.11na, and 802.11a WiFi clients can connect to the access point. However, the speed of 802.1ax, 802.11ac, 802.11na clients is limited to the maximum speed that is supported by 802.11a (up to about 54 Mbps).</li> </ul>



(Continued)

Setting	Description
Channel Width	<p>From the menu, select the channel width for the radio. Your selection from the <b>Wireless Mode</b> menu determines if you can set the channel width, and if so, which channel widths are available.</p> <p>Use the following guidelines:</p> <ul style="list-style-type: none"><li>• A wider channel improves the performance (no or minimal interference and better data rates).</li><li>• The 802.11n specification allows a 40 MHz-wide channel in addition to the legacy 20 MHz channel that is available with other modes.</li><li>• The 802.11ac specification allows an 80 MHz-wide channel in addition to the 20 MHz and 40 MHz channels that are available with other modes.</li><li>• The 40 MHz and 80 MHz channels enable higher data rates but leave fewer channels available for use.</li></ul>
Guard Interval	<p>From the menu, select the guard interval, which protects radio transmissions from interference. Your selection from the <b>Wireless Mode</b> menu determines if you can set the guard interval, and if so, which guard intervals are available.</p> <p>Use the following guidelines:</p> <ul style="list-style-type: none"><li>• A shorter guard interval supports more throughput in an environment in which WiFi devices operate at a shorter distance from the access point.</li><li>• A longer guard interval works well in an environment with multiple SSIDs and WiFi devices that operate at a longer distance from the access point.</li><li>• Some legacy devices can operate with a long -800ns guard interval only.</li></ul>

(Continued)

Setting	Description
Output Power	<p>From the menu, select the transmission power of the radio. You can select <b>100%(Max)</b>, <b>50%</b>, <b>25%</b>, <b>12.5%</b>, or <b>4%(Min)</b>. The default is 100%(Max).</p> <p><b>Note:</b> If two or more access points are operating in the same area and on the same channel, interference can occur. In this a situation, you might want to decrease the output power for the access point. Make sure that you comply with the regulatory requirements for total radio frequency (RF) output power in your country.</p>
Channel	<p>From the menu, select the WiFi channel for the radio. The available WiFi channels and frequencies depend on the country that you selected for the access point and on the radio. The default is Auto, which enables a radio to automatically select the most suitable channel.</p> <p><b>Note:</b> You do not need to change the WiFi channel unless you experience interference (which is indicated by lost connections).</p> <p><b>Note:</b> If you use multiple access points, reduce interference by selecting different channels for adjacent access points. We recommend a channel spacing of four channels between adjacent access points (for example, in the 2.4 GHz band, use channels 1 and 5, or 6 and 10).</p>

6. Click the **Apply** button.

A warning pop-up window displays.

7. Click the **OK** button.

The pop-up window closes and your settings are saved. The radio or radios restart and WiFi clients might need to reconnect.

## Turn a radio on or off

By default, both the 2.4 GHz and 5 GHz radios broadcast. Turning off a radio disables WiFi access for the associated band, which affects all WiFi networks (VAPs or SSIDs) in that band. Turning off a radio can be helpful during configuration, network tuning, or troubleshooting.

### To turn a radio on or off:

1. Launch a web browser from a computer that is connected to the same network as the access point or directly to the access point through an Ethernet cable or WiFi connection.

2. Enter the IP address that is assigned to the access point.

A login window displays.

If your browser does not display the login window but displays a security message and does not let you proceed, see [Log in to the access point after initial setup](#) on page 46.

3. Enter the access point user name and password.

The user name is **admin**. The password is the one that you specified. The user name and password are case-sensitive.

If you previously added the access point to a NETGEAR Insight network location and managed the access point through the Insight app or Insight Cloud portal, enter the Insight network password for that location. For more information, see [Connect over WiFi using the NETGEAR Insight app](#) on page 31.

The Dashboard page displays.

4. Select **Management > Configuration > Wireless > Basic > Wireless Settings**.

The Wireless Settings page displays.

5. Take one of the following actions:

- **Turn a radio on.** Select the **Turn Radio ON** check box for the radio.
- **Turn a radio off.** Clear the **Turn Radio ON** check box for the radio.

6. Click the **Apply** button.

A warning pop-up window displays.

7. Click the **OK** button.

The pop-up window closes and your settings are saved. The radio or radios restart and WiFi clients might need to reconnect.

## Change the WiFi mode for a radio

By default, all types of WiFi clients can access a WiFi network on the access point, that is, the WiFi modes on the access point support 802.11ax, 802.11ac, 802.11na, 802.11ng, 802.11bg, 802.11b, and 802.11a clients. You can change the WiFi modes to limit access to certain types of clients.

### To change the WiFi mode for a radio:

1. Launch a web browser from a computer that is connected to the same network as the access point or directly to the access point through an Ethernet cable or WiFi connection.

2. Enter the IP address that is assigned to the access point.

A login window displays.

If your browser does not display the login window but displays a security message and does not let you proceed, see [Log in to the access point after initial setup](#) on page 46.

3. Enter the access point user name and password.

The user name is **admin**. The password is the one that you specified. The user name and password are case-sensitive.

If you previously added the access point to a NETGEAR Insight network location and managed the access point through the Insight app or Insight Cloud portal, enter the Insight network password for that location. For more information, see [Connect over WiFi using the NETGEAR Insight app](#) on page 31.

The Dashboard page displays.

4. Select **Management > Configuration > Wireless > Basic > Wireless Settings**.

The Wireless Settings page displays.

5. Select the WiFi mode for the radio:

- **2.4 GHz radio.** Select one of the following WiFi modes for the 2.4 GHz radio:
  - **11ax.** 802.11ax, 802.11ng, 802.11bg, and 802.11b WiFi clients can connect to the access point. This is the default setting.
  - **11ng.** 802.1ax, 802.11ng, 802.11bg, and 802.11b WiFi clients can connect to the access point. However, the speed of 802.11ax clients is limited to the maximum speed that is supported by 802.11ng (about 400 Mbps).
  - **11bg.** 802.11ax, 802.11ng, 802.11bg, and 802.11b WiFi clients can connect to the access point. However, the speed of 802.1ax and 802.11ng clients is limited to the maximum speed that is supported by 802.11bg (about 54 Mbps).
  - **11b.** 802.1ax, 802.11ng, 802.11bg, and 802.11b WiFi clients can connect to the access point. However, the speed of 802.11ax, 802.11n, and 802.11bg clients is limited to the maximum speed that is supported by 802.11b (about 11 Mbps).
- **5 GHz radio.** Select one of the following WiFi modes for the 5 GHz radio:
  - **11ax.** 802.11ax, 802.11ac, 802.11na, and 802.11a WiFi clients can connect to the access point. This is the default setting.
  - **11ac.** 802.11ax, 802.11ac, 802.11na, and 802.11a WiFi clients can connect to the access point. However, the speed of 802.11ax clients is limited to the maximum speed that is supported by 802.11ac (about 867 Mbps).
  - **11na.** 802.11ax, 802.11ac, 802.11na, and 802.11a WiFi clients can connect to the access point. However, the speed of 802.11ax and 802.11ac clients is

limited to the maximum speed that is supported by 802.11na (about 450 Mbps).

- **11a.** 802.11ax, 802.11ac, 802.11na, and 802.11a WiFi clients can connect to the access point. However, the speed of 802.1ax, 802.11ac, 802.11na clients is limited to the maximum speed that is supported by 802.11a (up to about 54 Mbps).

6. Click the **Apply** button.

A warning pop-up window displays.

7. Click the **OK** button.

The pop-up window closes and your settings are saved. The radio or radios restart and WiFi clients might need to reconnect.

## Change the channel width for a radio

Use the following guidelines when you determine the channel width for a radio:

- A wider channel generally improves the performance (no or minimal interference and better data rates).
- A narrower channel generally results in lower throughput but might provide a more stable connection in a demanding situation, such as an environment with a long distance between the access point and WiFi clients and more than normal interference.
- The 802.11n specification allows a 40 MHz-wide channel in addition to the legacy 20 MHz channel that is available with other WiFi modes.
- The 802.11ac specification and the 802.11ax specification for the 5 GHz band allow an 80 MHz-wide channel in addition to the 20 MHz and 40 MHz channels that are available with other WiFi modes.
- The 40 MHz and 80 MHz channels enable higher data rates but leave fewer channels available for use.

**Note:** We recommend that leave the default option (Dynamic 20 / 40 MHz for the 2.4 GHz radio and Dynamic 20 / 40 / 80 MHz for the 5 GHz radio). The access point can automatically select the best channel width for its WiFi environment.

The WiFi mode (see [Change the WiFi mode for a radio](#) on page 91) determines if you can set the channel width, and if so, which channel widths are available.

### To change the channel width for a radio:

1. Launch a web browser from a computer that is connected to the same network as the access point or directly to the access point through an Ethernet cable or WiFi connection.

2. Enter the IP address that is assigned to the access point.

A login window displays.

If your browser does not display the login window but displays a security message and does not let you proceed, see [Log in to the access point after initial setup](#) on page 46.

3. Enter the access point user name and password.

The user name is **admin**. The password is the one that you specified. The user name and password are case-sensitive.

If you previously added the access point to a NETGEAR Insight network location and managed the access point through the Insight app or Insight Cloud portal, enter the Insight network password for that location. For more information, see [Connect over WiFi using the NETGEAR Insight app](#) on page 31.

The Dashboard page displays.

4. Select **Management > Configuration > Wireless > Basic > Wireless Settings**.

The Wireless Settings page displays.

5. From the **Channel Width** menu, select one of the following settings.

- **20 MHz.**
- **40 MHz.**
- **80 MHz.** This selection is available only for the 5 GHz radio.
- **Dynamic 20 / 40 MHz.** This selection is available only for the 2.4 GHz radio and is the default setting for that radio.
- **Dynamic 20 / 40 / 80 MHz.** This selection is available only for the 5 GHz radio and is the default setting for that radio.

6. Click the **Apply** button.

A warning pop-up window displays.

7. Click the **OK** button.

The pop-up window closes and your settings are saved. The radio or radios restart and WiFi clients might need to reconnect.

# Change the guard interval for a radio

From the menu, select the guard interval, which protects radio transmissions from interference. The WiFi mode (see [Change the WiFi mode for a radio](#) on page 91) determines if you can set the guard interval, and if so, which guard intervals are available. For the 11a, 11b, and 11bg WiFi modes, you cannot set the guard interval at all.

Use the following guidelines:

- A shorter guard interval supports more throughput in an environment in which WiFi devices operate at a shorter distance from the access point.
- A longer guard interval works well in an environment with multiple SSIDs and WiFi devices that operate at a longer distance from the access point.
- Some legacy devices can operate with a long -800ns guard interval only.

## To change the guard interval for a radio:

1. Launch a web browser from a computer that is connected to the same network as the access point or directly to the access point through an Ethernet cable or WiFi connection.

2. Enter the IP address that is assigned to the access point.

A login window displays.

If your browser does not display the login window but displays a security message and does not let you proceed, see [Log in to the access point after initial setup](#) on page 46.

3. Enter the access point user name and password.

The user name is **admin**. The password is the one that you specified. The user name and password are case-sensitive.

If you previously added the access point to a NETGEAR Insight network location and managed the access point through the Insight app or Insight Cloud portal, enter the Insight network password for that location. For more information, see [Connect over WiFi using the NETGEAR Insight app](#) on page 31.

The Dashboard page displays.

4. Select **Management > Configuration > Wireless > Basic > Wireless Settings**.

The Wireless Settings page displays.

5. From the **Guard Interval** menu, select one of the following settings:

- **Auto**. The guard interval is set automatically by the access point. This option is not available in the 11ax WiFi mode.

- **Long-800 ns.** This option is available in the 11ax, 11ac, 11na, and 11ng modes. In the 11ax WiFi mode, this option is the default setting.
  - **Double Long-1600 ns.** This option is available only in the 11ax WiFi mode.
  - **Quadruple Long-3200 ns.** This option is available only in the 11ax WiFi mode.
6. Click the **Apply** button.  
A warning pop-up window displays.
  7. Click the **OK** button.  
The pop-up window closes and your settings are saved. The radio or radios restart and WiFi clients might need to reconnect.

## Change the output power for a radio

By default, the output power of the access point is set at the maximum. If two or more access points are operating in the same area and on the same channel, interference can occur. In such a situation, you might want to decrease the output power for the access point. Make sure that you comply with the regulatory requirements for total radio frequency (RF) output power in your country.

### To change the output power for a radio:

1. Launch a web browser from a computer that is connected to the same network as the access point or directly to the access point through an Ethernet cable or WiFi connection.
2. Enter the IP address that is assigned to the access point.  
A login window displays.  
If your browser does not display the login window but displays a security message and does not let you proceed, see [Log in to the access point after initial setup](#) on page 46.
3. Enter the access point user name and password.  
The user name is **admin**. The password is the one that you specified. The user name and password are case-sensitive.  
If you previously added the access point to a NETGEAR Insight network location and managed the access point through the Insight app or Insight Cloud portal, enter the Insight network password for that location. For more information, see [Connect over WiFi using the NETGEAR Insight app](#) on page 31.  
The Dashboard page displays.



4. Select **Management > Configuration > Wireless > Basic > Wireless Settings**.  
The Wireless Settings page displays.
5. From the **Output Power** menu, select **100%(Max), 50%, 25%, 12.5%, or 4%(Min)**.  
The default is 100%(Max).
6. Click the **Apply** button.  
A warning pop-up window displays.
7. Click the **OK** button.  
The pop-up window closes and your settings are saved. The radio or radios restart and WiFi clients might need to reconnect.

## Change the channel for a radio

The available WiFi channels and frequencies depend on the country that you select for the access point and the radio. The default is Auto, which enables a radio to automatically select the most suitable channel.

**Note:** You do not need to change the WiFi channel unless you experience interference (which is indicated by lost connections).

**Note:** If you use multiple access points, reduce interference by selecting different channels for adjacent access points. We recommend a channel spacing of four channels between adjacent access points (for example, in the 2.4 GHz band, use channels 1 and 5, or 6 and 10).

### To change the channel for a radio:

1. Launch a web browser from a computer that is connected to the same network as the access point or directly to the access point through an Ethernet cable or WiFi connection.
2. Enter the IP address that is assigned to the access point.  
A login window displays.  
If your browser does not display the login window but displays a security message and does not let you proceed, see [Log in to the access point after initial setup](#) on page 46.
3. Enter the access point user name and password.  
The user name is **admin**. The password is the one that you specified. The user name and password are case-sensitive.

If you previously added the access point to a NETGEAR Insight network location and managed the access point through the Insight app or Insight Cloud portal, enter the Insight network password for that location. For more information, see [Connect over WiFi using the NETGEAR Insight app](#) on page 31.

The Dashboard page displays.

4. Select **Management > Configuration > Wireless > Basic > Wireless Settings**.

The Wireless Settings page displays.

5. From the **Channel** menu, select a channel.

The default is Auto. When you select a particular channel, the channel selection becomes static.

6. Click the **Apply** button.

A warning pop-up window displays.

7. Click the **OK** button.

The pop-up window closes and your settings are saved. The radio or radios restart and WiFi clients might need to reconnect.

## Manage Quality of Service for a WiFi radio

You can specify the Quality of Service (QoS) setting for the 2.4 GHz and 5 GHz radios separately. These settings are enabled by default for both radios. Disabling QoS for a radio might impact the throughput and speed of WiFi traffic on the access point.

### **To manage the QoS settings for a WiFi radio:**

1. Launch a web browser from a computer that is connected to the same network as the access point or directly to the access point through an Ethernet cable or WiFi connection.

2. Enter the IP address that is assigned to the access point.

A login window displays.

If your browser does not display the login window but displays a security message and does not let you proceed, see [Log in to the access point after initial setup](#) on page 46.

3. Enter the access point user name and password.

The user name is **admin**. The password is the one that you specified. The user name and password are case-sensitive.

If you previously added the access point to a NETGEAR Insight network location and managed the access point through the Insight app or Insight Cloud portal, enter the

Insight network password for that location. For more information, see [Connect over WiFi using the NETGEAR Insight app](#) on page 31.

The Dashboard page displays.

4. Select **Management > Configuration > Wireless > Basic > QoS Settings**.
5. Enable or disable the following features for a radio by selecting the applicable **Enable** or **Disable** radio buttons:
  - **Wi-Fi Multimedia (WMM)**. WiFi Multimedia (WMM) is a subset of the 802.11e standard. Time-dependent information such as video or audio is given higher priority than normal traffic. For WMM to function correctly, WiFi clients must also support WMM. By enabling WMM, you allow WMM to control upstream traffic flowing from WiFi devices to the access point and downstream traffic flowing from the access point to WiFi devices. WMM defines the following four queues in decreasing order of priority:
    - **Voice**. The highest priority queue with minimum delay, which makes it very suitable for applications such as VoIP and streaming media.
    - **Video**. The second highest priority queue with low delay. Video applications are routed to this queue.
    - **Best effort**. The medium priority queue with medium delay. Most standard IP applications use this queue.
    - **Background**. The low priority queue with high throughput. Applications such as FTP that are not time-sensitive but require high throughput can use this queue.
  - **WMM Powersave**. Enabling the WMM Powersave feature saves power for battery-powered devices and fine-tunes power consumption.
6. Click the **Apply** button.

A warning pop-up window displays.
7. Click the **OK** button.

The pop-up window closes and your settings are saved. The radio or radios restart and WiFi clients might need to reconnect.

# 8

## Set Up and Manage a Captive Portal

---

This chapter describes how you can set up and manage a captive portal on the access point.

A captive portal is a web page that users see when they attempt to connect to a WiFi network. A captive portal includes a splash page and usually requires some form of authentication for the user. The access point supports three types of captive portals:

- **Click-through captive portal.** A basic portal for which the splash page is stored on the access point. For each WiFi network, you can set up a unique click-through captive portal.
- **External captive portal.** A portal that is hosted by an external captive portal vendor. You can apply an external captive portal to multiple WiFi networks or you can apply a unique external captive portal to each WiFi network.
- **Facebook Wi-Fi captive portal.** A Facebook business page that serves as a portal. You can configure a single Facebook Wi-Fi captive portal on the access point but you can apply it to multiple WiFi networks.

The chapter includes the following sections:

- [Set up a click-through captive portal for a WiFi network](#)
- [Set up an external captive portal for a WiFi network](#)
- [Register and configure Facebook Wi-Fi for the access point](#)
- [Set up a Facebook Wi-Fi captive portal for a WiFi network](#)
- [Unregister the access point from Facebook Wi-Fi](#)

# Set up a click-through captive portal for a WiFi network

A click-through captive portal is a basic portal for which the splash page is stored on the access point, that is, it is not an external captive portal. Use a click-through captive portal to welcome or instruct WiFi users and limit their sessions. You can require users to agree to an end user license agreement (EULA) and redirect them a specific website. A click-through captive portal is specific to the WiFi network (SSID) on which you set it up.

## To set up a click-through captive portal for a WiFi network:

1. Launch a web browser from a computer that is connected to the same network as the access point or directly to the access point through an Ethernet cable or WiFi connection.

2. Enter the IP address that is assigned to the access point.  
A login window displays.

If your browser does not display the login window but displays a security message and does not let you proceed, see [Log in to the access point after initial setup](#) on page 46.

3. Enter the access point user name and password.

The user name is **admin**. The password is the one that you specified. The user name and password are case-sensitive.

If you previously added the access point to a NETGEAR Insight network location and managed the access point through the Insight app or Insight Cloud portal, enter the Insight network password for that location. For more information, see [Connect over WiFi using the NETGEAR Insight app](#) on page 31.

The Dashboard page displays.

4. Select **Management > Configuration > Wireless > Basic**.

The page that displays lets you select an SSID.

5. Click the ► button to the left of the SSID.

The settings for the selected SSID display.

6. Click the ► **Advanced** tab.

The page expands.

7. Select the **Captive Portal** check box.

The page adjusts. By default, the Click Through radio button is selected.

## Insight Managed WiFi 6 AX1800 Dual Band Access Point Models WAX610 and WAX610Y

Captive Portal

Click Through ⓘ     Facebook Wi-Fi ⓘ     External Captive Portal ⓘ

Session Timeout (in min)

Redirect URL

**Title**

**Message**

**JPEG/JPG Image (Max 500KB)**

No file

**EULA (Max 1KB)**

This usage agreement governs your use of the Internet services provided. The use of this hotspot is voluntarily given and may be rescinded without advanced notice. The user is not entitled to any compensation for damages, real or imagined, incurred while using the hotspot. The user agrees not to:

- 1) Transmit or participate in the transmission of materials in violation of local or national laws and regulations.
- 2) Send large quantities of unsolicited email (spam).
- 3) Restrict or hinder the free usage of this hotspot by other users.
- 4) Attack another user, website or service provider with a denial of service attack or otherwise.

8. Specify the click-through settings as described in the following table.

Setting	Description
Session Timeout (in min)	Enter the number of minutes from 1 to 1440 after which a WiFi session is terminated and a user must log in again. The default is 60 minutes.
Redirect URL	To redirect a user to a specific website after login, select the <b>Redirect URL</b> check box and enter the URL. If the <b>Redirect URL</b> check box is cleared, a user is directed to the default web page.
Title	Enter the title that is displayed on the captive portal login page. If you do not customize the title, the default title displays on the captive portal login page.
Message	Enter a message to the user. This message is displayed on the captive portal login page. If you do not customize the message, the default message displays on the captive portal login page.

(Continued)

Setting	Description
JPEG/JPG Image (Max 500 KB)	To customize the image that is displayed on the captive portal login page, click the <b>Browse</b> button and navigate to and select an image. If you do not customize the image, the default image displays on the captive portal login page.
EULA (Max 1 KB)	The field includes a default end user license agreement (EULA). You can enter or copy custom text into the field. To show the EULA on the captive portal login page, select the <b>EULA</b> check box.

- To preview the captive portal login page, click the **Preview** button.  
The following figure shows an example (that is, the figure does not show the default captive portal but a customized one).



- Click the **Apply** button.  
Your settings are saved. WiFi clients attempting to connect to the SSID are presented with the captive portal login page.

**Note:** An HTTPS session is blocked until after the captive portal authentication occurs.

# Set up an external captive portal for a WiFi network

An external captive portal is a portal that is hosted by an external captive portal vendor. That is, this type of portal is not stored on the access point. For an external captive portal, you generally must register your devices with and purchase licenses from the vendor.

You can apply an external captive portal to multiple WiFi networks or you can apply a unique external captive portal to each WiFi network

## To set up an external captive portal for a WiFi network:

1. Launch a web browser from a computer that is connected to the same network as the access point or directly to the access point through an Ethernet cable or WiFi connection.

2. Enter the IP address that is assigned to the access point.  
A login window displays.

If your browser does not display the login window but displays a security message and does not let you proceed, see [Log in to the access point after initial setup](#) on page 46.

3. Enter the access point user name and password.

The user name is **admin**. The password is the one that you specified. The user name and password are case-sensitive.

If you previously added the access point to a NETGEAR Insight network location and managed the access point through the Insight app or Insight Cloud portal, enter the Insight network password for that location. For more information, see [Connect over WiFi using the NETGEAR Insight app](#) on page 31.

The Dashboard page displays.

4. Select **Management > Configuration > Wireless > Basic**.

The page that displays lets you select an SSID.

5. Click the ► button to the left of the SSID.

The settings for the selected SSID display.

6. Click the ► **Advanced** tab.

The page expands.

7. Select the **Captive Portal** check box.

The page adjusts. By default, the Click-Through radio button is selected.



8. Click the **External Captive Portal** radio button.

Captive Portal

Click Through ⓘ  Facebook Wi-Fi ⓘ  External Captive Portal ⓘ

Splash Page URL ⓘ

Captive Portal Authentication Type

Web/HTTP ⓘ  Radius ⓘ

Web Authentication URL ⓘ

Key  ⓘ

Secret  ⓘ

FailSafe ⓘ  Enable  Disable

Allow HTTPS ⓘ  Enable  Disable

Walled Garden ⓘ

Select-all

```
Example:  
*.splashpage.com  
*.externalCP.com
```

9. Specify the external captive portal settings as described in the following table.

## Insight Managed WiFi 6 AX1800 Dual Band Access Point Models WAX610 and WAX610Y

Setting	Description
Splash Page URL	<p>Enter the URL that is provided by the vendor.</p> <p>This URL redirects a user to the splash page on the website that hosts the captive portal.</p>
Captive Portal Authentication Type	<p>The access point supports two types of external captive portal authentication. These types are mutually exclusive.</p> <hr/> <p><b>Web/HTTP.</b> Authentication for access to the splash page occurs on the access point using the HTTPS protocol. Specify the following settings:</p> <ul style="list-style-type: none"><li>• <b>Web Authentication URL.</b> Enter the web authentication URL that is provided by the vendor.</li><li>• <b>Key.</b> Enter the key credential that is provided by the vendor. This field is optional and depends on the authentication requirements of the vendor.</li><li>• <b>Secret.</b> Enter the secret credential that is provided by the vendor. This field is optional and depends on the authentication requirements of the vendor.</li></ul> <hr/> <p><b>Radius.</b> Authentication for access to the splash page occurs on an external RADIUS authentication server. The vendor might also require an accounting RADIUS server. Specify the following settings for <i>each</i> RADIUS server, as directed by the vendor:</p> <ul style="list-style-type: none"><li>• <b>IPv4 Address.</b> Enter the IP address of the server. The IP address is provided by the vendor.</li><li>• <b>Port.</b> Enter the port number that is used by the server. The IP port number is provided by the vendor. By default, an authentication server uses port number 1812; an accounting server uses port number 1813.</li><li>• <b>Password.</b> Enter the password (shared secret) for interaction with the server. The password is provided by the vendor.</li></ul>
FailSafe	<p>Select one of the following radio buttons:</p> <ul style="list-style-type: none"><li>• <b>Enable.</b> If authentication is not possible—for example, because captive portal servers do not respond—users are still allowed to access the Internet for a period of 30 minutes.</li><li>• <b>Disable.</b> This is the default setting. If authentication is not possible, users cannot reach the splash page and cannot access the Internet. Instead, they get a message <i>Oops. Something went wrong. Please try after some time.</i></li></ul>

(Continued)

Setting	Description
Allow HTTPS	<p>Select one of the following radio buttons:</p> <ul style="list-style-type: none"> <li>• <b>Enable.</b> Before authentication occurs, secure HTTP (HTTPS) traffic is allowed to pass through.</li> <li>• <b>Disable.</b> This is the default setting. HTTPS traffic is allowed only after authentication occurs.</li> </ul>
Walled Garden	<p>The walled garden specifies the external applications and sites that a user can access from the captive portal. Generally, the vendor provides information about the applications and sites. The vendor splash page, domain name, and authentication servers must also be included in the walled garden. Follow the directions of the vendor.</p> <p>You can do the following to configure the walled garden:</p> <ul style="list-style-type: none"> <li>• <b>Add a single URL.</b> In the right field, type the URL, press <b>Enter</b>, and click the <b>Move</b> button.</li> <li>• <b>Add multiple URLs.</b> In the right field, paste a list of URLs, and click the <b>Move</b> button.</li> <li>• <b>Remove one or more URLs.</b> Select the check boxes for URLs, and click the <b>Remove</b> button.</li> <li>• <b>Remove all URLs.</b> Select the <b>Select All</b> check box, and click the <b>Remove</b> button.</li> </ul>

10. Click the **Apply** button.

Your settings are saved. WiFi clients attempting to connect to the SSID are presented with the captive portal login page.

## Register and configure Facebook Wi-Fi for the access point

Before you can set up Facebook Wi-Fi on the access point so that you can provide customers WiFi access by letting them check in to an existing Facebook business page (see [Set up a Facebook Wi-Fi captive portal for a WiFi network](#) on page 110), you must register the access point with Facebook and configure the Facebook settings. By default, the capability to register is disabled.

**To register and configure Facebook Wi-Fi for the access point:**

1. Launch a web browser from a computer that is connected to the same network as the access point or directly to the access point through an Ethernet cable or WiFi connection.
2. Enter the IP address that is assigned to the access point.  
A login window displays.  
If your browser does not display the login window but displays a security message and does not let you proceed, see [Log in to the access point after initial setup](#) on page 46.
3. Enter the access point user name and password.  
The user name is **admin**. The password is the one that you specified. The user name and password are case-sensitive.  
If you previously added the access point to a NETGEAR Insight network location and managed the access point through the Insight app or Insight Cloud portal, enter the Insight network password for that location. For more information, see [Connect over WiFi using the NETGEAR Insight app](#) on page 31.  
The Dashboard page displays.
4. Select **Management > Configuration > Wireless > Basic > Facebook Wi-Fi**.  
The Facebook Wi-Fi page displays.
5. Select the Register with Facebook Wi-Fi **Yes** radio button.  
The capability to register is enabled. By default, this capability is disabled.
6. Click the **Apply** button.  
Your settings are saved and the **Add Page** button displays.
7. Click the **Add Page** button.  
A browser page launches and displays the Facebook Login page.

8. Log in to the Facebook account with which the Facebook business page is associated.

**Facebook Wi-Fi Configuration**

---

**Facebook Page**  
To use Facebook Wi-Fi you need to be the admin of a local business Page that has a valid location associated with it.

Select a Page ▾

**Bypass Mode**  
Your customers always have the option to skip checking in. They can do this by clicking on a link that lets them skip check-in, or by entering a Wi-Fi code that you provide to them.

Skip check-in link [?]  
 Require Wi-Fi code [?]

**Session Length**  
Select the length of time your customers will have Wi-Fi for after they check in.

Five hours ▾

**Terms of Service**  
 Optional: Add your own Terms of Service [?]

Visit Help Center Save Settings

9. From the **Select a Page** menu, select the Facebook business page.
10. Select one of the following bypass mode options:
  - To allow customers to skip check-in, select the **Skip check-in link** radio button. If you enable this option, users can either check in to the selected Facebook business page or skip the check-in.
  - To require users to enter a WiFi code before they can gain WiFi access, select the **Require Wi-Fi code** radio button and type a WiFi code in the field that displays. If you enable this option, users can either check in to the selected Facebook business page or skip the check-in by using the WiFi code.
11. From the **Session Length** menu, select the period after which users are automatically logged out.
12. To add terms of service to the Facebook check-in page, select the **Terms of Service** check box and type or copy the terms of service.
13. Click the **Save Settings** button.

The Facebook Wi-Fi settings are saved.

The name of the selected Facebook business page displays on the Facebook Wi-Fi configuration page, along with the **Change Page** button, which lets you replace the selected Facebook business page with another one.
14. To allow clients that are connected to the Facebook captive portal to establish a secure HTTP (HTTPS) session *before* the captive portal authentication occurs, select the Allow HTTPS **Enable** radio button.

By default, the Allow HTTPS **Disable** radio button is selected and clients that are connected to the Facebook captive portal cannot establish an HTTPS session until after the captive portal authentication occurs.

15. Click the **Apply** button.  
Your settings are saved.

## Set up a Facebook Wi-Fi captive portal for a WiFi network

You can provide customers WiFi access by letting them check in to a Facebook business page. Before you can do so, you must register the access point with Facebook Wi-Fi (see [Register and configure Facebook Wi-Fi for the access point](#) on page 107).

### **To set up a Facebook Wi-Fi captive portal for a WiFi network:**

1. Launch a web browser from a computer that is connected to the same network as the access point or directly to the access point through an Ethernet cable or WiFi connection.
2. Enter the IP address that is assigned to the access point.  
A login window displays.  
If your browser does not display the login window but displays a security message and does not let you proceed, see [Log in to the access point after initial setup](#) on page 46.
3. Enter the access point user name and password.  
The user name is **admin**. The password is the one that you specified. The user name and password are case-sensitive.  
If you previously added the access point to a NETGEAR Insight network location and managed the access point through the Insight app or Insight Cloud portal, enter the Insight network password for that location. For more information, see [Connect over WiFi using the NETGEAR Insight app](#) on page 31.  
The Dashboard page displays.
4. Select **Management > Configuration > Wireless > Basic**.  
The page that displays lets you select an SSID.
5. Click the **>** button to the left of the SSID.  
The settings for the selected SSID display.
6. Click the **> Advanced** tab.

The page expands.

7. Select the **Captive Portal** check box.

The page adjusts. By default, the Click Through radio button is selected.

8. Select the **Facebook Wi-Fi** radio button.

The page adjusts again because you do not need to specify any further settings on the page.

Customers receive WiFi access by checking in to a Facebook business page. To use this option, first register the access point with Facebook Wi-Fi and configure the Facebook settings (see [Register and configure Facebook Wi-Fi for the access point](#) on page 107).

9. Click the **Apply** button.

Your settings are saved. WiFi clients attempting to connect to the SSID are presented with the Facebook business page.

**Note:** When you set up a captive portal with Facebook Wi-Fi, you can configure the option to allow clients that are connected to the Facebook captive portal to establish a secure HTTP (HTTPS) session *before* the captive portal authentication occurs (see [Register and configure Facebook Wi-Fi for the access point](#) on page 107).

## Unregister the access point from Facebook Wi-Fi

If the access point is registered with Facebook Wi-Fi but you no longer want to use that option for a captive portal or you want to use another Facebook account, you can unregister the access point from Facebook Wi-Fi and remove the access point's entry.

### **To unregister the access point from Facebook Wi-Fi and remove the access point's entry:**

1. Launch a web browser from a computer that is connected to the same network as the access point or directly to the access point through an Ethernet cable or WiFi connection.
2. Enter the IP address that is assigned to the access point.

A login window displays.

If your browser does not display the login window but displays a security message and does not let you proceed, see [Log in to the access point after initial setup](#) on page 46.

3. Enter the access point user name and password.

The user name is **admin**. The password is the one that you specified. The user name and password are case-sensitive.

If you previously added the access point to a NETGEAR Insight network location and managed the access point through the Insight app or Insight Cloud portal, enter the Insight network password for that location. For more information, see [Connect over WiFi using the NETGEAR Insight app](#) on page 31.

The Dashboard page displays.

4. Select **Management > Configuration > Wireless > Basic > Facebook Wi-Fi**.

The Facebook Wi-Fi page displays.

5. Select the **No** radio button.

The capability to register is disabled. However, the access point's entry on the Facebook business page is not yet removed.

6. Click the **Apply** button.

Your settings are saved.

7. Go to the Facebook business page and log in to your account.

8. Select the check box for the access point's entry.

9. Click the **Delete** button.

The access point's entry is removed.



# 9

## Manage Access and Security

---

This chapter describes how you can manage access and security features and user accounts.

The chapter includes the following sections:

- [Block specific URLs and keywords for Internet access](#)
- [Manage user accounts](#)
- [Manage local MAC access control lists](#)
- [Manage neighbor AP detection](#)
- [Set up RADIUS servers](#)

**Note:** For information about essential WiFi security (network authentication and encryption), see [Set up an open or secure WiFi network](#) on page 60.

# Block specific URLs and keywords for Internet access

You can set up a blacklist by specifying URLs (web addresses) for which Internet access must be blocked. You can also specify keywords that cause the access point to reject URLs that contain those keywords.

## **To set up a blacklist with URLs and keywords for which Internet access must be blocked:**

1. Launch a web browser from a computer that is connected to the same network as the access point or directly to the access point through an Ethernet cable or WiFi connection.

2. Enter the IP address that is assigned to the access point.

A login window displays.

If your browser does not display the login window but displays a security message and does not let you proceed, see [Log in to the access point after initial setup](#) on page 46.

3. Enter the access point user name and password.

The user name is **admin**. The password is the one that you specified. The user name and password are case-sensitive.

If you previously added the access point to a NETGEAR Insight network location and managed the access point through the Insight app or Insight Cloud portal, enter the Insight network password for that location. For more information, see [Connect over WiFi using the NETGEAR Insight app](#) on page 31.

The Dashboard page displays.

4. Select **Management > Configuration > Security > URL Filtering**.

The URL Filtering page displays.

5. Select the **Enable** radio button.

6. Compose the blacklist in the following ways:

- Blocked URLs.** To add a URL to the blacklist, type or copy the URL in the upper field (to the left of the upper **Add** button) and click the upper **Add** button. You can also select one or more URLs from the Popular URL list by selecting the check boxes for the URLs and clicking the **<< Move** button.

To remove a URL from the blacklist, select the check box for the URL and click the upper left **Remove** button.

When you block a URL, the domain and all URLs in the domain are blocked. For example, if you add `www.google.com`, all web pages in the `www.google.com` domain are blocked, including, for example, `www.google.com/finance`.
- Blocked Keywords.** To add a keyword entry to the blacklist, enter the keyword in the lower field (to the left of the lower **Add** button) and click the lower **Add** button.

To remove a keyword entry from the blacklist, select the check box for the entry and click the lower **Remove** button.

All URLs that contain the keyword are blocked. For example, if you add `Jobs`, all URLs that contains `Jobs` (or `jobs`) are blocked.

7. Click the **Apply** button.  
Your settings are saved.

# Manage user accounts

User accounts provide either read/write or read-only access to the local browser UI of the access point. You cannot delete the admin user account or change its user name, but you can change its password. You can add accounts for other users, and you can change or delete these accounts.

The following sections describe how you can manage user accounts:

- [Add a user account](#)
- [Change the time-out period for a user session](#)
- [Change the settings for a user account](#)
- [Remove a user account](#)

For information about changing the password for the default admin user account, see [Change the admin user account password](#) on page 153.

## Add a user account

### To add a user account:

1. Launch a web browser from a computer that is connected to the same network as the access point or directly to the access point through an Ethernet cable or WiFi connection.

2. Enter the IP address that is assigned to the access point.

A login window displays.

If your browser does not display the login window but displays a security message and does not let you proceed, see [Log in to the access point after initial setup](#) on page 46.

3. Enter the access point user name and password.

The user name is **admin**. The password is the one that you specified. The user name and password are case-sensitive.

If you previously added the access point to a NETGEAR Insight network location and managed the access point through the Insight app or Insight Cloud portal, enter the Insight network password for that location. For more information, see [Connect over WiFi using the NETGEAR Insight app](#) on page 31.

The Dashboard page displays.

4. Select **Management > Configuration > System > Advanced > User Accounts**.

The screenshot shows a configuration form for a user account. At the top, there are three main sections: 'User Name' with a blue 'a' icon and a text input field containing 'admin'; 'Password' with a text input field containing masked characters; and 'Privilege' with a dropdown menu showing 'Read-Write'. Below these is a 'Session Timeout' section with 'Hours' set to '0' and 'Minutes' set to '45'. At the bottom, there are two buttons: 'Cancel' and 'Apply'.

5. Click the add user account icon.  
Additional fields and a menu display.
6. Specify the settings for the new user account:
  - **User Name.** Enter a user name.
  - **Password.** Enter a password between 8 and 64 characters in length. The password must contain at least one uppercase letter, one lowercase letter, and one number. The following special characters are allowed:  
! @ # \$ % ^ & \* ( )
  - **Privilege.** From the menu, select **Read-Write** or **Read-Only**.
  - **Session Timeout.** Use the **Hours** and **Minutes** fields to specify the period after which a session automatically expires and the user must log in again. By default, a session expires after 45 minutes.
7. Click the **Apply** button.  
Your settings are saved.

## Change the time-out period for a user session

When a user logs in to the local browser UI, the session times out automatically after 45 minutes. You can change the time-out period, which applies to all users, including the admin user.

### To change the time-out period for a user session:

1. Launch a web browser from a computer that is connected to the same network as the access point or directly to the access point through an Ethernet cable or WiFi connection.
2. Enter the IP address that is assigned to the access point.  
A login window displays.

If your browser does not display the login window but displays a security message and does not let you proceed, see [Log in to the access point after initial setup](#) on page 46.

3. Enter the access point user name and password.

The user name is **admin**. The password is the one that you specified. The user name and password are case-sensitive.

If you previously added the access point to a NETGEAR Insight network location and managed the access point through the Insight app or Insight Cloud portal, enter the Insight network password for that location. For more information, see [Connect over WiFi using the NETGEAR Insight app](#) on page 31.

The Dashboard page displays.

4. Select **Management > Configuration > System > Advanced > User Accounts**.

The screenshot shows a configuration form for a user account. It has three main sections: 'User Name' with a text input containing 'admin', 'Password' with a masked text input, and 'Privilege' with a dropdown menu set to 'Read-Write'. Below these is a 'Session Timeout' section with two input fields: 'Hours' set to 0 and 'Minutes' set to 45. At the bottom of the form are two buttons: 'Cancel' and 'Apply'.

5. Under Session Timeout, use the **Hours** and **Minutes** fields to specify the period after which a session automatically expires and the user must log in again.  
By default, a session expires after 45 minutes.
6. Click the **Apply** button.  
Your settings are saved. Your session is terminated and you must log in again.

## Change the settings for a user account

You cannot change the access privilege for the default admin user account.

### To change the user name, password, or access privilege for a user account:

1. Launch a web browser from a computer that is connected to the same network as the access point or directly to the access point through an Ethernet cable or WiFi connection.
2. Enter the IP address that is assigned to the access point.  
A login window displays.

If your browser does not display the login window but displays a security message and does not let you proceed, see [Log in to the access point after initial setup](#) on page 46.

3. Enter the access point user name and password.

The user name is **admin**. The password is the one that you specified. The user name and password are case-sensitive.

If you previously added the access point to a NETGEAR Insight network location and managed the access point through the Insight app or Insight Cloud portal, enter the Insight network password for that location. For more information, see [Connect over WiFi using the NETGEAR Insight app](#) on page 31.

The Dashboard page displays.

4. Select **Management > Configuration > System > Advanced > User Accounts**.

The existing user accounts display.

5. To the right of the user account, change the existing settings as needed:

- **User Name.** Enter another user name.
- **Password.** Enter another password between 8 and 64 characters in length. The password must contain at least one uppercase letter, one lowercase letter, and one number. The following special characters are allowed:  
! @ # \$ % ^ & \* ( )
- **Privilege.** From the menu, select **Read-Write** or **Read-Only**.

6. Click the **Apply** button.

Your settings are saved.

## Remove a user account

You can remove a user account that you no longer need. You cannot remove the default admin user account.

### To remove a user account:

1. Launch a web browser from a computer that is connected to the same network as the access point or directly to the access point through an Ethernet cable or WiFi connection.
2. Enter the IP address that is assigned to the access point.  
A login window displays.

If your browser does not display the login window but displays a security message and does not let you proceed, see [Log in to the access point after initial setup](#) on page 46.

3. Enter the access point user name and password.

The user name is **admin**. The password is the one that you specified. The user name and password are case-sensitive.

If you previously added the access point to a NETGEAR Insight network location and managed the access point through the Insight app or Insight Cloud portal, enter the Insight network password for that location. For more information, see [Connect over WiFi using the NETGEAR Insight app](#) on page 31.

The Dashboard page displays.

4. Select **Management > Configuration > System > Advanced > User Accounts**.

The existing user accounts display.

5. Click the **X** to the right of the user account.

A warning pop-up window displays.

6. Click the **Delete** button.

The pop-up windows closes and the user account is removed.

## Manage local MAC access control lists

The access point supports eight local access control lists (ACLs) that are based on MAC addresses. Each local MAC ACL can contain a total number of 256 MAC addresses.

If you set up an ACL with a policy that allows access and you apply that ACL to a WiFi network (that is, to an SSID), the ACL functions as follows:

- A WiFi device for which you place the MAC address in the ACL is allowed access to the WiFi network.
- All other WiFi devices are denied access to the WiFi network.

If you set up an ACL with a policy that denies access and you apply that ACL to a WiFi network (that is, to an SSID), the ACL functions as follows:

- A WiFi device for which you place the MAC address in the ACL is denied access to the WiFi network.
- All other WiFi devices are allowed access to the WiFi network.



An ACL takes effect only after you apply it to a WiFi network. For information about applying an ACL to a WiFi network, see [Select a MAC ACL for a WiFi network](#) on page 82. You can apply a MAC ACL to more than one WiFi network.

The following sections describe how you can manage MAC ACLs:

- [Manually set up a MAC access control List](#)
- [Import an existing MAC access control list](#)

## Manually set up a MAC access control List

You can compose up to eight access control lists (ACLs) that are each based on up to 256 MAC addresses. The access point includes MAC ACLs with the following default group names and settings, which you can change:

- **Management.** If enabled, allows access to trusted stations by default.
- **Guest.** If enabled, allows access to trusted stations by default.
- **Guest1.** If enabled, denies access to untrusted stations by default.
- **Custom.** If enabled, denies access to untrusted stations by default.
- **Custom 1.** If enabled, allows access to trusted stations by default.
- **Custom 2.** If enabled, allows access to trusted stations by default.
- **Custom 3.** If enabled, allows access to trusted stations by default.
- **Custom 4.** If enabled, allows access to trusted stations by default.

By default, these MAC ACLs are disabled and do not include any stations. You can manually add devices, import devices (see [Import an existing MAC access control list](#) on page 124), or do both.

You can use a MAC ACL to control which WiFi devices (stations) can access a WiFi network. You can apply one MAC ACL to more than one WiFi network.

### **To manually set up a MAC ACL:**

1. Launch a web browser from a computer that is connected to the same network as the access point or directly to the access point through an Ethernet cable or WiFi connection.
2. Enter the IP address that is assigned to the access point.  
A login window displays.

If your browser does not display the login window but displays a security message and does not let you proceed, see [Log in to the access point after initial setup](#) on page 46.

3. Enter the access point user name and password.

The user name is **admin**. The password is the one that you specified. The user name and password are case-sensitive.

If you previously added the access point to a NETGEAR Insight network location and managed the access point through the Insight app or Insight Cloud portal, enter the Insight network password for that location. For more information, see [Connect over WiFi using the NETGEAR Insight app](#) on page 31.

The Dashboard page displays.

4. Select **Management > Configuration > Security > MAC ACL**.
5. Click the group name for the MAC ACL that you want to set up.

Management

Group Name

Import MAC Address List  Replace  Merge

No MAC list file chosen

[Download Sample](#)

ACL Policy  Allow  Deny

Trusted Stations

Select-all	Search..
No Station Found	

Available Stations

Select-all	Search..	
<input type="checkbox"/>	50-6A-03-80-51-01	Connected
<input type="checkbox"/>	50-6A-03-80-51-02	Connected
<input type="checkbox"/>	50-6A-03-80-51-03	Connected

00-00-00-00-00-00

> Guest

> Guest1

> Custom

The previous figure shows some examples. Devices in the Available Stations table are automatically detected by the access point and are common to all MAC ACLs, which allows you to add a device to more than one MAC ACL. A neighboring station displays as Neighbor and a connected station displays as connected.

6. To change the group name, enter a new name in the **Group Name** field.  
The default group names for the eight MAC ACLs are Management, Guest, Guest1, Custom, Custom 1, Custom 2, Custom 3, and Custom 4.
7. Select the ACL Policy **Allow** or **Deny** radio button.

If you select the **Allow** radio button, a WiFi device for which you place the MAC address in the ACL is allowed access to the WiFi network, but all other WiFi devices are denied access to the WiFi network.

If you select the **Deny** radio button, a WiFi device for which you place the MAC address in the ACL is denied access to the WiFi network, but all other WiFi devices are allowed access to the WiFi network.

8. Compose the ACL in the following way:

- For an ACL for which you selected the **Allow** radio button in Step 7, do the following:
  - To manually add a device to the Trusted Stations table, enter the MAC address in the format 00-00-00-00-00-00 in the field below the Trusted Stations table, and click the **Add** button.  
The device is added to the Trusted Stations table.
  - To move a device from the Available Stations table to the Trusted Stations table, select the check box for the device and click the **<< Move** button.  
You can search the Available Stations table. You can also filter devices in the Available Stations table by clicking the **filter** icon.
  - To remove a device from the Trusted Stations table, select the check box for the device and click the **Remove** button.  
You can search the Trusted Stations table.  
When you remove a device from the Trusted Stations table, after the access point redetects the device, the device is once again placed in the Available Stations table.
  
- For an ACL for which you selected the **Deny** radio button in Step 7, do the following:
  - To manually add a device to the Untrusted Stations table, enter the MAC address in the format 00-00-00-00-00-00 in the field below the Untrusted Stations table, and click the **Add** button.  
The device is added to the Untrusted Stations table.
  - To move a device from the Available Stations table to the Untrusted Stations table, select the check box for the device and click the **<< Move** button.  
You can search the Available Stations table. You can also filter devices in the Available Stations table by clicking the **filter** icon.
  - To remove a device from the Untrusted Stations table, select the check box for the device and click the **Remove** button.  
You can search the Untrusted Stations table.  
When you remove a device from the Untrusted Stations table, after the access point redetects the device, the device is once again placed in the Available Stations table.

9. Click the **Apply** button.

Your settings are saved.

For more information about applying an ACL to a WiFi network, see [Select a MAC ACL for a WiFi network](#) on page 82.

WiFi devices in the Trusted Stations table can access the WiFi network to which you apply the ACL. WiFi devices in the Untrusted Stations table cannot access the WiFi network to which you apply the ACL.

## Import an existing MAC access control list

You can import an existing access control list (ACL) that is based on up to 256 MAC addresses. You can import the list into any MAC ACL, but the MAC addresses on the list are available only for the MAC ACL into which you import the list. That is, if you want to use the same list in another MAC ACL, you must also import the list into that MAC ACL.

The file with MAC addresses must be in the following format:

- Entries in the file must be MAC addresses only in hexadecimal format with each octet separated by a hyphen, for example 00-11-22-33-44-55.
- You must separate entries with a comma.
- The file must be in text format (that is, with a .txt or .cfg extension).

You can use a MAC ACL to control which WiFi devices can access a WiFi network. You can apply a MAC ACL to more than one WiFi network.

### To import an existing MAC ACL:

1. Launch a web browser from a computer that is connected to the same network as the access point or directly to the access point through an Ethernet cable or WiFi connection.

2. Enter the IP address that is assigned to the access point.

A login window displays.

If your browser does not display the login window but displays a security message and does not let you proceed, see [Log in to the access point after initial setup](#) on page 46.

3. Enter the access point user name and password.

The user name is **admin**. The password is the one that you specified. The user name and password are case-sensitive.

If you previously added the access point to a NETGEAR Insight network location and managed the access point through the Insight app or Insight Cloud portal, enter the Insight network password for that location. For more information, see [Connect over WiFi using the NETGEAR Insight app](#) on page 31.

The Dashboard page displays.

4. Select **Management > Configuration > Security > MAC ACL**.
5. Click the group name for the MAC ACL that you want to set up.

Management

Group Name Management

Import MAC Address List Replace Merge

Browse File No MAC list file chosen

[Download Sample](#)

ACL Policy Allow Deny

Trusted Stations

Select-all	Search..
No Station Found	

Available Stations Refresh

Select-all	Search..	
<input type="checkbox"/>	50-6A-03-80-51-01	Connected
<input type="checkbox"/>	50-6A-03-80-51-02	Connected
<input type="checkbox"/>	50-6A-03-80-51-03	Connected

00-00-00-00-00-00 Add Remove

Cancel Apply

> Guest

> Guest1

> Custom

The previous figure shows some examples. Devices in the Available Stations table are automatically detected by the access point and are common to all MAC ACLs, which allows you to add a device to more than one MAC ACL. A neighboring station displays as Neighbor and a connected station displays as connected.

6. To change the group name, enter a new name in the **Group Name** field.  
The default group names for the eight MAC ACLs are Management, Guest, Guest1, Custom, Custom 1, Custom 2, Custom 3, and Custom 4.
7. Select the ACL Policy **Allow** or **Deny** radio button.  
If you select the **Allow** radio button, a WiFi device for which you import the MAC address into the ACL is allowed access to the WiFi network, but all other WiFi devices are denied access to the WiFi network.

If you select the **Deny** radio button, a WiFi device for which you import the MAC address into the ACL is denied access to the WiFi network, but all other WiFi devices are allowed access to the WiFi network.

8. To download a sample of a MAC ACL in the format that is required for importing, click the **Download Sample** link.
9. Import and compose the ACL in the following way:
  - For an ACL for which you selected the **Allow** radio button in [Step 7](#), do the following:
    - a. Replace or merge the MAC addresses in the import list with the MAC addresses in the Trusted Stations table (if any are already in the table) by selecting one of the following radio buttons:
      - **Replace**. MAC addresses in the Trusted Stations table are replaced with the ones in the import list.
      - **Merge**. MAC addresses in the Trusted Stations table are merged with the ones in the import list.
    - b. Click the **Browse** button and navigate to and select the import file. The MAC addresses on the import list are placed in the Trusted Stations table.
    - c. To remove a MAC address from the Trusted Stations table, select the MAC address and click the **Remove** button. You can search the Trusted Stations table. When you remove a device from the Trusted Stations table, after the access point redetects the device, the device is once again placed in the Available Stations table.
  - For an ACL for which you selected the **Deny** radio button in [Step 7](#), do the following:
    - a. Replace or merge the MAC addresses in the import list with the MAC addresses in the Untrusted Stations table (if any are already in the table) by selecting one of the following radio buttons:
      - **Replace**. MAC addresses in the Untrusted Stations table are replaced with the ones in the import list.
      - **Merge**. MAC addresses in the Untrusted Stations table are merged with the ones in the import list.
    - b. Click the **Browse** button and navigate to and select the import file. The MAC addresses on the import list are placed in the Untrusted Stations table.

- c. To remove a MAC address from the Untrusted Stations table, select the MAC address and click the **Remove** button.  
You can search the Untrusted Stations table.  
When you remove a device from the Untrusted Stations table, after the access point redetects the device, the device is once again placed in the Available Stations table.

10. Click the **Apply** button.

Your settings are saved. For information about manually adding MAC addresses to those in the Trusted Stations table or Untrusted Stations table, see [Manually set up a MAC access control List](#) on page 121.

For more information about applying an ACL to a WiFi network, see [Select a MAC ACL for a WiFi network](#) on page 82.

WiFi devices in the Trusted Stations table can access the WiFi network to which you apply the ACL. WiFi devices in the Untrusted Stations table cannot access the WiFi network to which you apply the ACL.

## Manage neighbor AP detection

The access point can detect neighbor access points (APs) and you can classify them as known APs.

If you enable neighbor AP detection, the access point regularly scans the WiFi network, collects information about all access points on the channels, and maintains a list of access points it detects in the area. Initially all detected access points are displayed in the Unknown AP List. You can add access points that you are familiar with to the Known AP List. You can also import a list of known access points in the Known AP List.

**CAUTION:** Access points in the Unknown AP List require further investigation. They could be rogue access points, which use the SSID of a legitimate network. These types of access points can present a serious security threat.

The following sections describe how you can manage neighbor AP detection and add neighbor access points to the Known AP List:

- [Enable neighbor access point detection and move access points to the Known AP List](#)
- [Import an existing neighbor access point list in the Known AP List](#)

## Enable neighbor access point detection and move access points to the Known AP List

The access point can detect neighbor access points (APs) and lets you classify them as known APs. After you enable neighbor AP detection, the access point maintains a list of access points it detects in the area. Initially all detected access points are displayed in the Unknown AP List. You can manually move access points from the Unknown AP List to the Known AP List.

By default neighbor access point detection is disabled.

### **To enable neighbor access point detection and move detected access points to the Known AP List:**

1. Launch a web browser from a computer that is connected to the same network as the access point or directly to the access point through an Ethernet cable or WiFi connection.

2. Enter the IP address that is assigned to the access point.

A login window displays.

If your browser does not display the login window but displays a security message and does not let you proceed, see [Log in to the access point after initial setup](#) on page 46.

3. Enter the access point user name and password.

The user name is **admin**. The password is the one that you specified. The user name and password are case-sensitive.

If you previously added the access point to a NETGEAR Insight network location and managed the access point through the Insight app or Insight Cloud portal, enter the Insight network password for that location. For more information, see [Connect over WiFi using the NETGEAR Insight app](#) on page 31.

The Dashboard page displays.

4. Select **Management > Configuration > Security > Neighbor AP**.

The page that displays lets you select the radio band (2.4GHz or 5GHz).

5. Click the ► button to the left of the radio band.

The Neighbor AP page displays for the selected radio band.

6. Select the **Enable Neighbor AP** check box.

7. Click the **Apply** button.



Your settings are saved. Neighbor AP detection is now enabled.

▼ 2.4 GHz

Enable Neighbor AP

Detection Policy Mild

Known AP List | Unknown AP List

Import Known AP List  Replace  Merge  [Download Sample](#)  
No AP list file chosen

<input type="checkbox"/>	MAC Address	SSID	Channel	RSSI
--------------------------	-------------	------	---------	------

8. From the **Detection Policy** menu, select the scan method:
- **Mild.** The access point scans for neighbor access points every 15 minutes. This is the default setting.
  - **Moderate.** The access point scans for neighbor access points every 5 minutes.
  - **Aggressive.** The access point scans for neighbor access points every 1 minute.
- Detected neighbor access points display in the Unknown AP List.

9. To view detected neighbor access points and move them from the Unknown AP List to the Known AP List, do the following:
  - a. Click the **Unknown AP List** tab.

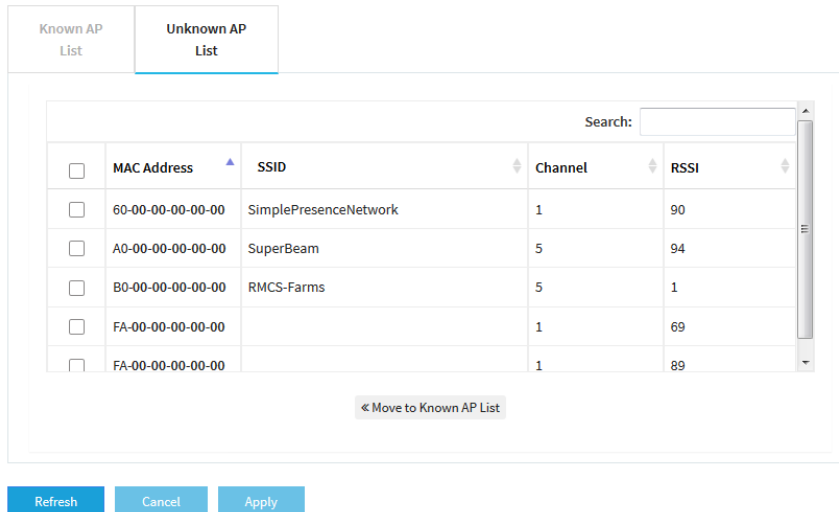

- b. If no access points display, click the **Refresh** button.
  - c. Select the check boxes for the access points that you are familiar with and that you trust.
  - d. Click the **<< Move to Known AP List** button.
  - e. Click the **Known AP List** tab.  
The selected access points display in the Known AP List.

**Note:** You can delete access points from the Known AP List. After being detected, these access points once more display in the Unknown AP List.

10. Click the **Apply** button.  
Your settings are saved.

## Import an existing neighbor access point list in the Known AP List

You can import a list with MAC addresses of known neighbor access points in the Known AP List.

The file with MAC addresses must be in the following format:

- Entries in the file must be MAC addresses only in hexadecimal format with each octet separated by a hyphen, for example 00-11-22-33-44-55.

- You must separate entries with a comma.
- The file must be in text format (that is, with a `.txt` or `.cfg` extension).

For information about enabling neighbor AP detection, see [Enable neighbor access point detection and move access points to the Known AP List](#) on page 128.

### **To import a list with MAC addresses of known neighbor access points in the Known AP List:**

1. Launch a web browser from a computer that is connected to the same network as the access point or directly to the access point through an Ethernet cable or WiFi connection.

2. Enter the IP address that is assigned to the access point.  
A login window displays.

If your browser does not display the login window but displays a security message and does not let you proceed, see [Log in to the access point after initial setup](#) on page 46.

3. Enter the access point user name and password.

The user name is **admin**. The password is the one that you specified. The user name and password are case-sensitive.

If you previously added the access point to a NETGEAR Insight network location and managed the access point through the Insight app or Insight Cloud portal, enter the Insight network password for that location. For more information, see [Connect over WiFi using the NETGEAR Insight app](#) on page 31.

The Dashboard page displays.

4. Select **Management > Configuration > Security > Neighbor AP**.

The page that displays lets you select the radio band (2.4GHz or 5GHz).

- Click the ► button to the left of the radio band.

▼ 2.4 GHz

Enable Neighbor AP

Detection Policy Mild

Known AP List | Unknown AP List

Import Known AP List ⓘ

Replace  Merge

Browse File No AP list file chosen

Download Sample

<input type="checkbox"/>	MAC Address	SSID	Channel	RSSI

Delete

Refresh Cancel Apply

- To download a sample of an AP list in the format that is required for importing in the Known AP List, click the **Download Sample** link.
- Import and compose the Known AP List in the following way:
  - Replace or merge the MAC addresses in the import list with the MAC addresses in the Known AP List by selecting one of the following radio buttons:
    - Replace.** MAC addresses in the Known AP List are replaced with the ones in the import list.
    - Merge.** MAC addresses in the Known AP List are merged with the ones in the import list.
  - Click the **Browse** button and navigate to and select the import file. The MAC addresses on the import list are placed in the Known AP List.
  - To remove a MAC address from the Known AP List, select the MAC address and click the **Delete** button.  
When you remove a device from the Known AP List, after the access point redetects the device, the device is once again placed in the Known AP List.

8. Click the **Apply** button.  
Your settings are saved.

## Set up RADIUS servers

If you use WPA2 Enterprise security or a RADIUS MAC ACL, you must set up RADIUS servers for authentication, accounting, or both authentication and accounting using RADIUS. You must set up primary IPv4 servers and you can set up secondary IPv4 servers. These RADIUS server settings apply either to all WiFi networks that use WPA2 Enterprise security (see [Set up an open or secure WiFi network](#) on page 60) or to all WiFi networks that use a RADIUS MAC ACL.

**Note:** WPA2 Enterprise security and a RADIUS MAC ACL are mutually exclusive. If you want to use a RADIUS MAC ACL for a WiFi network, select a different type of WiFi security (see [Set up an open or secure WiFi network](#) on page 60). If you want to use WPA2 Enterprise security for a WiFi network, use a local MAC ACL (see [Manage local MAC access control lists](#) on page 120).

If you use a RADIUS MAC ACL, you must define the ACL on the RADIUS server, using the format in the following example for client MAC addresses in the RADIUS server: If the client MAC address is 00:0a:95:9d:68:16, specify it as 000a959d6816 in the RADIUS server.

### To set up RADIUS servers:

1. Launch a web browser from a computer that is connected to the same network as the access point or directly to the access point through an Ethernet cable or WiFi connection.

2. Enter the IP address that is assigned to the access point.

A login window displays.

If your browser does not display the login window but displays a security message and does not let you proceed, see [Log in to the access point after initial setup](#) on page 46.





3. Enter the access point user name and password.

The user name is **admin**. The password is the one that you specified. The user name and password are case-sensitive.

If you previously added the access point to a NETGEAR Insight network location and managed the access point through the Insight app or Insight Cloud portal, enter the Insight network password for that location. For more information, see [Connect over WiFi using the NETGEAR Insight app](#) on page 31.

The Dashboard page displays.

4. Select **Management > Configuration > Security > RADIUS Settings**.

	IPv4 Address	Port	Password	
Primary Authentication Server	<input type="text"/>	1812	<input type="password"/>	
Secondary Authentication Server	<input type="text"/>	1812	<input type="password"/>	
Primary Accounting Server	<input type="text"/>	1813	<input type="password"/>	
Secondary Accounting Server	<input type="text"/>	1813	<input type="password"/>	

---

**Authentication Settings**

Reauthentication Time: 
 Update Global Key:

Port:

5. For each RADIUS server that you want to set up, configure the following settings:
  - **IPv4 Address.** Enter the IPv4 address of the RADIUS server. The access point must be able to reach this IP address.
  - **Port.** Enter the number of the UDP port on the access point that is used to access the RADIUS server. For authentication servers, the default port number is 1812. For accounting servers, the default port number is 1813.
  - **Password.** Enter the password (shared key) that is used between the access point and the RADIUS server during the authentication or accounting process. By default, the password is sharedsecret.
6. Configure the following authentication settings, which apply to all RADIUS server that you set up:
  - **Reauthentication time.** Enter the interval in seconds after which the supplicant (the WiFi client) must be reauthenticated with the RADIUS server. The default interval is 3600 seconds (1 hour). Enter **0** to disable reauthentication.

- **Update Global Key.** Select the check box to allow the global key update, and enter the interval in seconds. The check box is selected by default, and the default interval is 1800 seconds (30 minutes). Clear the check box to prevent the global key update.

7. Click the **Apply** button.  
Your settings are saved.

# 10

## Manage the Local Area Network and IP Settings

---

This chapter describes how you can manage the local area network (LAN) and IP settings of the access point.

The chapter includes the following sections:

- [Disable the DHCP client and specify a fixed IP address](#)
- [Enable the DHCP client](#)
- [Set the 802.1Q VLAN and management VLAN](#)
- [Specify an existing domain name](#)
- [Enable or disable Spanning Tree Protocol](#)
- [Enable or disable the network integrity check function](#)
- [Enable or disable IGMP snooping](#)
- [Enable or disable Ethernet LLDP](#)
- [Enable or disable UPnP](#)



# Disable the DHCP client and specify a fixed IP address

By default, the DHCP client of the access point is enabled and the access point receives an IP address from a DHCP server (or a router that functions as a DHCP server) in your network. If your network does not include a DHCP server or you prefer to specify a fixed (static) IP address, disable the DHCP client of the access point.

## To disable the DHCP client and specify a fixed IP address:

1. Launch a web browser from a computer that is connected to the same network as the access point or directly to the access point through an Ethernet cable or WiFi connection.

2. Enter the IP address that is assigned to the access point.

A login window displays.

If your browser does not display the login window but displays a security message and does not let you proceed, see [Log in to the access point after initial setup](#) on page 46.

3. Enter the access point user name and password.

The user name is **admin**. The password is the one that you specified. The user name and password are case-sensitive.

If you previously added the access point to a NETGEAR Insight network location and managed the access point through the Insight app or Insight Cloud portal, enter the Insight network password for that location. For more information, see [Connect over WiFi using the NETGEAR Insight app](#) on page 31.

The Dashboard page displays.

4. Select **Management > Configuration > IP > LAN**.

The page that displays lets you specify the LAN settings, but the fields are masked because the DHCP client is enabled.

- Select the **Disable** radio button.

The screenshot shows the DHCP Client configuration interface. At the top, there are two radio buttons: 'Enable' and 'Disable', with 'Disable' selected. Below this, there are three input fields: 'IP Address' with the value '192.168.100.127', 'Subnet Mask' with '255.255.255.0', and 'Gateway' with '192.168.100.1'. Underneath these are 'Primary DNS' (192.168.100.1) and 'Secondary DNS' (0.0.0.0). The next section is '802.1Q VLAN', containing 'Untagged VLAN' (checked, value 1) and 'Management VLAN' (value 1). At the bottom, there is a 'Fully Qualified Domain Name' section with an 'FQDN' input field. 'Cancel' and 'Apply' buttons are at the bottom left.

The fields are now unmasked.

- Specify the settings that are described in the following table.

Setting	Description
IP Address	IP address in the range that is used by your LAN (usually 255.255.255.0).
Subnet Mask	The subnet mask must be compatible with your LAN.
Gateway	IP address of the gateway on your LAN.
Primary DNS	IP address of the primary Domain Name System (DNS) server on your LAN.
Secondary DNS	IP address of the secondary DNS server on your LAN, or leave this field blank.

- Click the **Apply** button.

Your settings are saved. The access point restarts with the new IP settings.

## Enable the DHCP client

By default, the DHCP client of the access point is enabled and the access point receives an IP address from a DHCP server (or a router that functions as a DHCP server) in your network.

If you disabled the DHCP client, you can reen able it.

### To enable the DHCP client:

1. Launch a web browser from a computer that is connected to the same network as the access point or directly to the access point through an Ethernet cable or WiFi connection.
2. Enter the IP address that is assigned to the access point.

A login window displays.

If your browser does not display the login window but displays a security message and does not let you proceed, see [Log in to the access point after initial setup](#) on page 46.

3. Enter the access point user name and password.

The user name is **admin**. The password is the one that you specified. The user name and password are case-sensitive.

If you previously added the access point to a NETGEAR Insight network location and managed the access point through the Insight app or Insight Cloud portal, enter the Insight network password for that location. For more information, see [Connect over WiFi using the NETGEAR Insight app](#) on page 31.

The Dashboard page displays.

4. Select **Management > Configuration > IP > LAN**.

The screenshot shows the 'DHCP Client' configuration page. At the top, there are two radio buttons: 'Enable' (unselected) and 'Disable' (selected). Below this, there are three input fields: 'IP Address' (192.168.100.127), 'Subnet Mask' (255.255.255.0), and 'Gateway' (192.168.100.1). Underneath are 'Primary DNS' (192.168.100.1) and 'Secondary DNS' (0.0.0.0). The '802.1Q VLAN' section has 'Untagged VLAN' (1) with a checked checkbox and 'Management VLAN' (1). At the bottom, there is a 'Fully Qualified Domain Name' field with a help icon and an 'FQDN' input field. 'Cancel' and 'Apply' buttons are at the bottom left.

5. Select the **Enable** radio button.  
The fields are masked.

6. Click the **Apply** button.

Your settings are saved. The access point restarts with the new IP settings. It might take a while before the access point receives its IP address setting from the DHCP server.

# Set the 802.1Q VLAN and management VLAN

The 802.1Q VLAN protocol on the access point logically separates traffic on the same physical (wired) network. This protocol can work with tagged and untagged VLANs, as follows:

- **Untagged VLAN.** The access point sends untagged frames from its Ethernet interface. Incoming untagged frames are assigned to the untagged VLAN. By default, the untagged VLAN is VLAN 1. By default, the access point functions with an untagged VLAN.
- **Tagged VLAN.** The access point tags all frames that it sends from its Ethernet interface. Only the incoming frames that are tagged with known VLAN IDs are accepted.

The management VLAN is used for managing traffic such as Telnet, SNMP, HTTP, and HTTPS traffic sent to and from the access point. Frames that belong to the management VLAN and that are sent over the trunk do not receive an 802.1Q header. If a port is a member of a single VLAN, its traffic can be untagged.

## To set the 802.1Q VLAN and management VLAN:

1. Launch a web browser from a computer that is connected to the same network as the access point or directly to the access point through an Ethernet cable or WiFi connection.

2. Enter the IP address that is assigned to the access point.  
A login window displays.

If your browser does not display the login window but displays a security message and does not let you proceed, see [Log in to the access point after initial setup](#) on page 46.

3. Enter the access point user name and password.

The user name is **admin**. The password is the one that you specified. The user name and password are case-sensitive.

If you previously added the access point to a NETGEAR Insight network location and managed the access point through the Insight app or Insight Cloud portal, enter the Insight network password for that location. For more information, see [Connect over WiFi using the NETGEAR Insight app](#) on page 31.

The Dashboard page displays.

4. Select **Management > Configuration > IP > LAN**.

5. To change the 802.1Q VLAN, either clear or select the **Untagged VLAN** check box:

- **Untagged VLAN.** By default, the **Untagged VLAN** check box is selected. The access point sends untagged frames from its Ethernet interface. Incoming untagged frames are assigned to the untagged VLAN. By default, the untagged VLAN is VLAN 1 but you can enter another VLAN ID in the field if that VLAN ID is supported on your network.
- **Tagged VLAN.** Clear the **Untagged VLAN** check box only if the hubs and switches on your LAN support the 802.1Q VLAN protocol. The access point tags all frames that it sends from its Ethernet interface. Only the incoming frames that are tagged with known VLAN IDs are accepted. Similarly, change the ID for the untagged VLAN only if the hubs and switches on your LAN support the 802.1Q VLAN protocol and the new VLAN ID is supported on your network.

6. To change the VLAN ID for the management VLAN, enter another VLAN ID in the **Management VLAN** field.

By default, the management VLAN is VLAN 1. If you change the VLAN ID, be sure that the VLAN ID is supported on your network.

7. Click the **Apply** button.

Your settings are saved. The access point restarts with the new VLAN settings.

## Specify an existing domain name

You can specify an existing fully qualified domain name (FQDN) for the access point so that you can access the access point by using a domain name instead of an IP address.

The FQDN must be a domain name that is registered with a Domain Name System (DNS) provider.

The following are the requirements for the FQDN:

- The length can be from 1 to 64 characters.
- Alphanumeric characters are allowed (a-z and 1-9)
- A dot (.) and a hyphen (-) are allowed but the name cannot start with either.

An example is *myap01\_firstfloor\_myorganization.com*.

### To specify a FQDN:

1. Launch a web browser from a computer that is connected to the same network as the access point or directly to the access point through an Ethernet cable or WiFi connection.

2. Enter the IP address that is assigned to the access point.

A login window displays.

If your browser does not display the login window but displays a security message and does not let you proceed, see [Log in to the access point after initial setup](#) on page 46.

3. Enter the access point user name and password.

The user name is **admin**. The password is the one that you specified. The user name and password are case-sensitive.

If you previously added the access point to a NETGEAR Insight network location and managed the access point through the Insight app or Insight Cloud portal, enter the Insight network password for that location. For more information, see [Connect over WiFi using the NETGEAR Insight app](#) on page 31.

The Dashboard page displays.

4. Select **Management > Configuration > IP > LAN**.

The screenshot shows the DHCP Client configuration interface. At the top, there are radio buttons for 'Enable' (selected) and 'Disable'. Below this, there are three input fields: 'IP Address' with the value '192.168.100.127', 'Subnet Mask' with '255.255.255.0', and 'Gateway' with '192.168.100.1'. Underneath, there are two more input fields: 'Primary DNS' with '192.168.100.1' and 'Secondary DNS' with '0.0.0.0'. A horizontal line separates these from the '802.1Q VLAN' section, which has two sub-sections: 'Untagged VLAN' with a checked checkbox and a value of '1', and 'Management VLAN' with a value of '1'. Below that is the 'Fully Qualified Domain Name' section, which has a blue information icon and an 'FQDN' input field. At the bottom left, there are 'Cancel' and 'Apply' buttons.

5. In the **Fully Qualified Domain Name** field, specify the FQDN.
6. Click the **Apply** button.  
Your settings are saved. The access point attempts to resolve the FQDN to an IP address.

## Enable or disable Spanning Tree Protocol

For locations where multiple access points are active and redundant network paths might be present, Spanning Tree Protocol (STP) can prevent network loops. If your location might include redundant network paths, we recommend that you enable STP.

### To enable or disable Spanning Tree Protocol:

1. Launch a web browser from a computer that is connected to the same network as the access point or directly to the access point through an Ethernet cable or WiFi connection.
2. Enter the IP address that is assigned to the access point.  
A login window displays.  
If your browser does not display the login window but displays a security message and does not let you proceed, see [Log in to the access point after initial setup](#) on page 46.
3. Enter the access point user name and password.  
The user name is **admin**. The password is the one that you specified. The user name and password are case-sensitive.

If you previously added the access point to a NETGEAR Insight network location and managed the access point through the Insight app or Insight Cloud portal, enter the Insight network password for that location. For more information, see [Connect over WiFi using the NETGEAR Insight app](#) on page 31.

The Dashboard page displays.

4. Select **Management > Configuration > System > Advanced > General**.

The General page displays.

5. Select a Spanning Tree Protocol radio button:

- **Enable**. STP is enabled.
- **Disable**. STP is disabled. This is the default setting.

6. Click the **Apply** button.

Your settings are saved.

## Enable or disable the network integrity check function

The network integrity check function enables the access point to validate whether the upstream link is active before the access point allows WiFi associations. Make sure that the default gateway is configured correctly. By default, the network integrity check function is disabled.

### **To enable or disable the network integrity check function:**

1. Launch a web browser from a computer that is connected to the same network as the access point or directly to the access point through an Ethernet cable or WiFi connection.
2. Enter the IP address that is assigned to the access point.

A login window displays.

If your browser does not display the login window but displays a security message and does not let you proceed, see [Log in to the access point after initial setup](#) on page 46.

3. Enter the access point user name and password.

The user name is **admin**. The password is the one that you specified. The user name and password are case-sensitive.

If you previously added the access point to a NETGEAR Insight network location and managed the access point through the Insight app or Insight Cloud portal, enter the



Insight network password for that location. For more information, see [Connect over WiFi using the NETGEAR Insight app](#) on page 31.

The Dashboard page displays.

4. Select **Management > Configuration > System > Advanced > General**.

The General page displays.

5. Select a Network Integrity Check radio button:

- **Enable**. The network integrity check function is enabled.
- **Disable**. The network integrity check function is disabled. This is the default setting.

6. Click the **Apply** button.

Your settings are saved.

## Enable or disable IGMP snooping

IGMP snooping allows IP multicast packets to be transmitted only to the members of a corresponding multicast group. Enabling IGMP snooping prevents flooding of multicast traffic to all the ports in a broadcast domain. By default, IGMP snooping is disabled on the access point.

### To enable or disable IGMP snooping:

1. Launch a web browser from a computer that is connected to the same network as the access point or directly to the access point through an Ethernet cable or WiFi connection.

2. Enter the IP address that is assigned to the access point.

A login window displays.

If your browser does not display the login window but displays a security message and does not let you proceed, see [Log in to the access point after initial setup](#) on page 46.

3. Enter the access point user name and password.

The user name is **admin**. The password is the one that you specified. The user name and password are case-sensitive.

If you previously added the access point to a NETGEAR Insight network location and managed the access point through the Insight app or Insight Cloud portal, enter the Insight network password for that location. For more information, see [Connect over WiFi using the NETGEAR Insight app](#) on page 31.

The Dashboard page displays.

4. Select **Management > Configuration > System > Advanced > General**.

The General page displays.

5. Select an IGMP Snooping radio button:
  - **Enable**. IGMP snooping is enabled.
  - **Disable**. IGMP snooping is disabled. This is the default setting.
6. Click the **Apply** button.

Your settings are saved.

## Enable or disable Ethernet LLDP

Link Layer Discovery Protocol (LLDP), as specified in IEEE 802.1AB, can provide link-layer messages to adjacent network devices. For example, LLDP lets network devices such as switches and management devices discover the access point in a network.

LLDP can also detect if the access point receives power through PoE. By default, LLDP is enabled.

### **To enable or disable the LLDP:**

1. Launch a web browser from a computer that is connected to the same network as the access point or directly to the access point through an Ethernet cable or WiFi connection.
2. Enter the IP address that is assigned to the access point.

A login window displays.

If your browser does not display the login window but displays a security message and does not let you proceed, see [Log in to the access point after initial setup](#) on page 46.

3. Enter the access point user name and password.

The user name is **admin**. The password is the one that you specified. The user name and password are case-sensitive.

If you previously added the access point to a NETGEAR Insight network location and managed the access point through the Insight app or Insight Cloud portal, enter the Insight network password for that location. For more information, see [Connect over WiFi using the NETGEAR Insight app](#) on page 31.

The Dashboard page displays.

4. Select **Management > Configuration > System > Advanced > Ethernet LLDP**.  
The Ethernet LLDP page displays.

5. Select a radio button:

- **Enable**. LLDP is enabled. This is the default setting.
- **Disable**. LLDP is disabled.

**CAUTION:** If the access point receives power from a PoE switch and you disable LLDP, power to the access point might be turned off after you click the **Apply** button. In that case, restart the access point.

6. Click the **Apply** button.  
Your settings are saved.

## Enable or disable UPnP

Universal Plug and Play (UPnP) lets the access point be discovered by other devices in the network that support UPnP. UPnP is enabled by default.

### To enable or disable UPnP:

1. Launch a web browser from a computer that is connected to the same network as the access point or directly to the access point through an Ethernet cable or WiFi connection.
2. Enter the IP address that is assigned to the access point.

A login window displays.

If your browser does not display the login window but displays a security message and does not let you proceed, see [Log in to the access point after initial setup](#) on page 46.

3. Enter the access point user name and password.

The user name is **admin**. The password is the one that you specified. The user name and password are case-sensitive.

If you previously added the access point to a NETGEAR Insight network location and managed the access point through the Insight app or Insight Cloud portal, enter the Insight network password for that location. For more information, see [Connect over WiFi using the NETGEAR Insight app](#) on page 31.

The Dashboard page displays.

4. Select **Management > Configuration > System > Advanced > UPnP**.

The UPnP page displays.

5. Select a radio button:
  - **Enable**. UPnP is enabled. This is the default setting.
  - **Disable**. UPnP is disabled.
6. Click the **Apply** button.  
Your settings are saved.

# 11

## Manage and Maintain the Access Point

---

This chapter describes how you can manage and maintain the access point.

The chapter includes the following sections:

- [Change the management mode to NETGEAR Insight or Web-browser](#)
- [Change the country or region of operation](#)
- [Change the admin user account password](#)
- [Change the system name](#)
- [Specify a custom NTP server](#)
- [Set the time zone](#)
- [Manage the syslog settings](#)
- [Manage the firmware of the access point](#)
- [Manage the configuration file of the access point](#)
- [Reboot the access point from the local browser UI](#)
- [Schedule the access point to reboot](#)
- [Return the access point to its factory default settings](#)
- [Enable SNMP and manage the SNMP settings](#)
- [Manage the LEDs](#)

# Change the management mode to NETGEAR Insight or Web-browser

The access point can function in either of the following management modes:

- **NETGEAR Insight mode.** You can manage the access point remotely from a mobile device on which the NETGEAR Insight app is installed or, if you are an Insight Premium or Insight Pro subscriber, through the Insight Cloud portal. The NETGEAR Insight mode is the default setting. In this mode, you *can* connect to the access point over the local browser UI, but only a basic and limited local browser UI is available. For information about the Insight app and Insight Cloud portal, visit [insight.netgear.com](https://insight.netgear.com) and see the NETGEAR knowledge base at [netgear.com/support/product/insight.aspx](https://netgear.com/support/product/insight.aspx).

**IMPORTANT:** When you change the management mode from Web-browser mode to NETGEAR Insight mode, the configuration of the access point is reset (cleared) with the exception of the IP address, access point name, and password for the local browser UI. The access point restarts and broadcasts SSID Netgearxxxxxx, in which xxxxxx represents the last six hexadecimal digits of the access point's MAC address. The MAC address is listed on the product label. The default WiFi passphrase is **sharedsecret**.

- **Web-browser mode.** You can manage the access point locally from a WiFi or wired device through the local browser UI. In this mode, the access point functions as a standalone device and is not connected to the Insight cloud-based management platform.

**IMPORTANT:** If you first add the access point to a NETGEAR Insight network location and manage the access point through the Insight app or Insight Cloud portal and then you change the management mode to Web-browser mode, you must continue to use the Insight network password to access the local browser UI until you manually change the admin password on the access point.

## To change the management mode to NETGEAR Insight mode or Web-browser mode:

1. Launch a web browser from a computer that is connected to the same network as the access point or directly to the access point through an Ethernet cable or WiFi connection.
2. Enter the IP address that is assigned to the access point.  
A login window displays.

If your browser does not display the login window but displays a security message and does not let you proceed, see [Log in to the access point after initial setup](#) on page 46.

3. Enter the access point user name and password.

The user name is **admin**. The password is the one that you specified. The user name and password are case-sensitive.

If you previously added the access point to a NETGEAR Insight network location and managed the access point through the Insight app or Insight Cloud portal, enter the Insight network password for that location. For more information, see [Connect over WiFi using the NETGEAR Insight app](#) on page 31.

The Dashboard page displays.

4. Select **Management > Configuration > System > Basic > Management Mode**.

The Management Mode page displays.

5. Select one of the following radio buttons:

- **NETGEAR Insight**. The access point functions in NETGEAR Insight management mode.
- **Web-browser**. The access point functions in Web-browser management mode.

**WARNING:** When you change the management mode from Web-browser mode to NETGEAR Insight mode, the configuration of the access point is reset (cleared) with the exception of the IP address, access point name, and password for the local browser UI. The access point restarts and broadcasts SSID Netgearxxxxxx, in which xxxxxx represents the last six hexadecimal digits of the access point's MAC address. The MAC address is listed on the product label. The default WiFi passphrase is **sharedsecret**.

6. Click the **Apply** button.

A warning pop-up window displays.

7. Click the **OK** button.

The pop-up window closes and your settings are saved. The access point restarts in the new management mode.

# Change the country or region of operation

You can change the country or region in which the access point operates. Note the following:

- Make sure that the country is set to the location where the device is operating. You are responsible for complying with the local, regional, and national regulations that are set for channels, power levels, and frequency ranges.
- It might not be legal to operate the access point in a country or region other than those listed in the menu. If your country or region is not listed in the menu, you must check with your local government agency or check the NETGEAR website for information about which channels you can use.

## To change the country or region of operation:

1. Launch a web browser from a computer that is connected to the same network as the access point or directly to the access point through an Ethernet cable or WiFi connection.

2. Enter the IP address that is assigned to the access point.

A login window displays.

If your browser does not display the login window but displays a security message and does not let you proceed, see [Log in to the access point after initial setup](#) on page 46.

3. Enter the access point user name and password.

The user name is **admin**. The password is the one that you specified. The user name and password are case-sensitive.

If you previously added the access point to a NETGEAR Insight network location and managed the access point through the Insight app or Insight Cloud portal, enter the Insight network password for that location. For more information, see [Connect over WiFi using the NETGEAR Insight app](#) on page 31.

The Dashboard page displays.

4. Select **Management > Configuration > System > Basic**.

The General page displays the basic system settings.

5. Select a country or region from the **Country / Region** menu.

6. Click the **Apply** button.

A warning pop-up window displays.

7. Click the **OK** button.



The pop-up window closes and your settings are saved. The access point restarts with the default WiFi and radio settings that are specific to the selected country or region.

## Change the admin user account password

This admin user account password is the password that you use to log in to the local browser UI of the access point with the user name admin. (It is not the passphrase that you use for WiFi access.)

The password must be 8 to 63 characters in length and must contain at least one uppercase letter, one lowercase letter, and one number. The following special characters are allowed:

! @ # \$ % ^ & \* ( )

### To change the password for the user name admin:

1. Launch a web browser from a computer that is connected to the same network as the access point or directly to the access point through an Ethernet cable or WiFi connection.

2. Enter the IP address that is assigned to the access point.

A login window displays.

If your browser does not display the login window but displays a security message and does not let you proceed, see [Log in to the access point after initial setup](#) on page 46.

3. Enter the access point user name and password.

The user name is **admin**. The password is the one that you specified. The user name and password are case-sensitive.

If you previously added the access point to a NETGEAR Insight network location and managed the access point through the Insight app or Insight Cloud portal, enter the Insight network password for that location. For more information, see [Connect over WiFi using the NETGEAR Insight app](#) on page 31.

The Dashboard page displays.

4. Select **Management > Configuration > System > Advanced > User Accounts**.

The page that displays lets you change the user accounts.

5. Next to admin, in the **Password** field, enter the new password.

6. In the **Confirm Password** field, enter the same new password.

---

**Note:** You cannot change the user name. The name must remain admin.

7. Click the **Apply** button.

Your settings are saved. The next time that you log in to the access point, you must use the new password. If you forget the new password, you must reset the access point to factory default settings. Doing so restores the password to the default password.

## Change the system name

The system name (also referred to as access point name, or AP name) is a unique NetBIOS name for the access point. The default system name is located on the access point label. By default, the system name is Netgearxxxxxx, in which xxxxxx represents the last six hexadecimal digits of the access point's MAC address.

### To change the system name:

1. Launch a web browser from a computer that is connected to the same network as the access point or directly to the access point through an Ethernet cable or WiFi connection.

2. Enter the IP address that is assigned to the access point.

A login window displays.

If your browser does not display the login window but displays a security message and does not let you proceed, see [Log in to the access point after initial setup](#) on page 46.

3. Enter the access point user name and password.

The user name is **admin**. The password is the one that you specified. The user name and password are case-sensitive.

If you previously added the access point to a NETGEAR Insight network location and managed the access point through the Insight app or Insight Cloud portal, enter the Insight network password for that location. For more information, see [Connect over WiFi using the NETGEAR Insight app](#) on page 31.

The Dashboard page displays.

4. Select **Management > Configuration > System > Basic**.

The General page displays the basic system settings.

5. Enter a new name in the **System Name** field.

Use the following guidelines:

- The name must contain alphanumeric characters, can contain hyphens, and cannot be longer than 15 characters.

- The name cannot start or end with a hyphen.
  - The name must contain at least one alphabetical character.
6. Click the **Apply** button.  
Your settings are saved.

## Specify a custom NTP server

By default, the access point receives its time from a default NETGEAR Network Time Protocol (NTP) server, but you can also specify a custom NTP server.

### To specify a custom NTP server:

1. Launch a web browser from a computer that is connected to the same network as the access point or directly to the access point through an Ethernet cable or WiFi connection.
2. Enter the IP address that is assigned to the access point.  
A login window displays.

If your browser does not display the login window but displays a security message and does not let you proceed, see [Log in to the access point after initial setup](#) on page 46.

3. Enter the access point user name and password.

The user name is **admin**. The password is the one that you specified. The user name and password are case-sensitive.

If you previously added the access point to a NETGEAR Insight network location and managed the access point through the Insight app or Insight Cloud portal, enter the Insight network password for that location. For more information, see [Connect over WiFi using the NETGEAR Insight app](#) on page 31.

The Dashboard page displays.

4. Select **Management > Configuration > System > Basic > Time**.

The screenshot shows the 'Time' configuration page. It includes a 'Time Zone' dropdown menu set to 'USA-Pacific', a 'Current Time (24-hour)' field showing 'Wed Jun 3 16:01:10 PDT 2020', an 'NTP Client' section with 'Enable' selected, a 'Use Custom NTP Server' checkbox, and radio buttons for 'Hostname' (selected) and 'IP Address'. The 'Hostname' field contains 'time-b.netgear.com'. There are 'Cancel' and 'Apply' buttons at the bottom.

By default, the **Enable** radio button is selected and the access point receives its time from a default NETGEAR NTP server.

5. Select the **Use Custom NTP Server** check box.
6. Take one of the following actions:
  - Enter the host name of the NTP server.  
By default, the **Hostname** radio button is selected.
  - Select the **IP address** radio button and enter the IP address of the NTP server.
7. Click the **Apply** button.

Your settings are saved. When the access point connects over the Internet to the new NTP server, the date and time that display on the page are adjusted according to your settings.

For information about setting the time zone, see [Set the time zone](#) on page 156.

## Set the time zone

When the access point synchronizes its clock with a Network Time Protocol (NTP) server, the page shows the date and time. If the page does not show the correct date and time, you might need to set the time zone and adjust the daylight saving time setting.

### **To set the time zone and adjust the daylight saving time setting:**

1. Launch a web browser from a computer that is connected to the same network as the access point or directly to the access point through an Ethernet cable or WiFi connection.

2. Enter the IP address that is assigned to the access point.

A login window displays.

If your browser does not display the login window but displays a security message and does not let you proceed, see [Log in to the access point after initial setup](#) on page 46.

3. Enter the access point user name and password.

The user name is **admin**. The password is the one that you specified. The user name and password are case-sensitive.

If you previously added the access point to a NETGEAR Insight network location and managed the access point through the Insight app or Insight Cloud portal, enter the Insight network password for that location. For more information, see [Connect over WiFi using the NETGEAR Insight app](#) on page 31.

The Dashboard page displays.

4. Select **Management > Configuration > System > Basic > Time**.

The page that displays lets you change the time settings.

5. From the **Time Zone** menu, select the time zone for the area in which the access point operates.

6. Click the **Apply** button.

Your settings are saved. When the access point connects over the Internet to an NTP server, the date and time that display on the page are adjusted according to your settings.

For information about other time settings, see [Specify a custom NTP server](#) on page 155.

## Manage the syslog settings

If a syslog server is present on your network, you can configure the access point to send its system logs to the syslog server.

### To manage the syslog settings and enable the syslog function:

1. Launch a web browser from a computer that is connected to the same network as the access point or directly to the access point through an Ethernet cable or WiFi connection.

2. Enter the IP address that is assigned to the access point.

A login window displays.

If your browser does not display the login window but displays a security message and does not let you proceed, see [Log in to the access point after initial setup](#) on page 46.

3. Enter the access point user name and password.

The user name is **admin**. The password is the one that you specified. The user name and password are case-sensitive.

If you previously added the access point to a NETGEAR Insight network location and managed the access point through the Insight app or Insight Cloud portal, enter the Insight network password for that location. For more information, see [Connect over WiFi using the NETGEAR Insight app](#) on page 31.

The Dashboard page displays.

4. Select **Management > Configuration > System > Advanced > Syslog**.

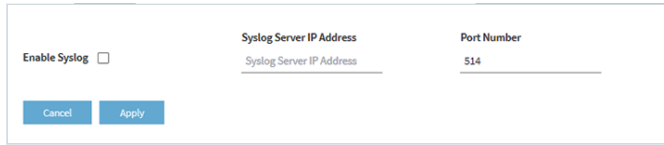

The screenshot shows a configuration window for Syslog. On the left, there is a checkbox labeled 'Enable Syslog'. To its right, there are two input fields. The first is labeled 'Syslog Server IP Address' and has a placeholder text 'Syslog Server IP Address'. The second is labeled 'Port Number' and contains the value '514'. At the bottom left of the form are two buttons: 'Cancel' and 'Apply'.

5. Specify the IP address and port number for the syslog server:
  - **Syslog Server IP Address.** Enter the IP address of the syslog server on your network.
  - **Port Number.** Enter the port number at which the syslog can be reached. By default, the port number is 514.
6. To enable the syslog server function, select the **Enable Syslog** check box.
7. Click the **Apply** button.  
Your settings are saved.

## Manage the firmware of the access point

The access point firmware is stored in flash memory.

You can check to see if new firmware is available and upgrade the access point to the new firmware. You can also visit the NETGEAR support website, download the firmware manually to a local computer, and update the access point to the new firmware. If someone (usually the network administrator) places new firmware on a secure FTP (SFTP) server in the network, you can load the firmware from the server and upgrade the firmware of the access point.

The following sections describe the firmware management methods:

- [Check for new firmware and upgrade the access point](#)
- [Manually download firmware and upgrade the access point](#)
- [Revert to the backup firmware](#)
- [Use an SFTP server to upgrade the access point](#)

## Check for new firmware and upgrade the access point

For you to check for new firmware, the access point must be connected to the Internet.

### To check for new firmware and upgrade your access point:

1. Launch a web browser from a computer that is connected to the same network as the access point or directly to the access point through an Ethernet cable or WiFi connection.

2. Enter the IP address that is assigned to the access point.  
A login window displays.

If your browser does not display the login window but displays a security message and does not let you proceed, see [Log in to the access point after initial setup](#) on page 46.

3. Enter the access point user name and password.

The user name is **admin**. The password is the one that you specified. The user name and password are case-sensitive.

If you previously added the access point to a NETGEAR Insight network location and managed the access point through the Insight app or Insight Cloud portal, enter the Insight network password for that location. For more information, see [Connect over WiFi using the NETGEAR Insight app](#) on page 31.

The Dashboard page displays.

4. Click the **Check for Upgrade** button.

The access point detects new firmware if any is available and displays the latest version available.

5. To read the release notes if any are available, click the **Release Notes** link.  
A web page displays the release notes.

6. To download and install the new firmware, click the **Upgrade Now** button, and follow the prompts and dialog boxes.

The access point locates the firmware, downloads it, and begins the upgrade.

**WARNING:** To avoid the risk of corrupting the firmware, do not interrupt the upgrade. For example, do not close the browser, click a link, or load a new page. Do not turn off the access point. Wait until the access point finishes restarting and the Power/Cloud LED remains solid green or solid blue.

The firmware upgrade process takes several minutes. When the upgrade is complete, your access point restarts.

7. Verify that the access point runs the new firmware version by logging back in to the access point.  
The firmware version is displayed on the Dashboard page.
8. Read the new firmware release notes to determine whether you must reconfigure the access point after upgrading.

## Manually download firmware and upgrade the access point

Downloading firmware to a local computer and upgrading the access point are two separate tasks that are combined in the following procedure. After you upgrade the access point to new firmware, the old firmware is saved as backup firmware so that you can revert to it (see [Revert to the backup firmware](#) on page 162).

**IMPORTANT:** When you install an older firmware version (or the backup firmware version), that is, you downgrade rather than upgrade the firmware, the configuration of the access point is reset (cleared) with the exception of the IP address, access point name, and password for the local browser UI. The access point restarts and broadcasts SSID Netgearxxxxxx, in which xxxxxx represents the last six hexadecimal digits of the access point's MAC address. The MAC address is listed on the product label. The default WiFi passphrase is **sharedsecret**.

### To download firmware manually and upgrade your access point:

1. Visit [netgear.com/support/download/](http://netgear.com/support/download/), locate the support page for your product, and download the new firmware.
2. Read the new firmware release notes to determine whether you must reconfigure the access point after upgrading.
3. Launch a web browser from a computer that is connected to the same network as the access point or directly to the access point through an Ethernet cable or WiFi connection.
4. Enter the IP address that is assigned to the access point.

A login window displays.

If your browser does not display the login window but displays a security message and does not let you proceed, see [Log in to the access point after initial setup](#) on page 46.

5. Enter the access point user name and password.

The user name is **admin**. The password is the one that you specified. The user name and password are case-sensitive.

If you previously added the access point to a NETGEAR Insight network location and managed the access point through the Insight app or Insight Cloud portal, enter the



Insight network password for that location. For more information, see [Connect over WiFi using the NETGEAR Insight app](#) on page 31.

The Dashboard page displays.

6. Select **Management > Maintenance > Upgrade > Firmware Upgrade**.

The Firmware Upgrade page displays.

7. Make sure that **Local** is selected from the **Upgrade Options** menu.

Local is the default selection.

8. Locate and select the firmware file on your computer by doing the following:

- a. Click the **Browse** button.

- b. Navigate to the firmware file.

The file name ends in `.tar`.

- c. Select the firmware file.

9. Click the **Upgrade** button.

**WARNING:** To avoid the risk of corrupting the firmware, do not interrupt the upgrade. For example, do not close the browser, click a link, or load a new page. Do not turn off the access point. Wait until the access point finishes restarting and the Power/Cloud LED remains solid green or solid blue.

The firmware upgrade process takes several minutes. When the upgrade is complete, the access point restarts.

10. Verify that the access point runs the new firmware version by logging back in to the access point.

The firmware version is displayed on the Dashboard page.

## Revert to the backup firmware

After you upgrade the access point to new firmware, the old firmware is saved as backup firmware so that you can revert to it.

**IMPORTANT:** When you revert to the backup firmware and the backup firmware is an earlier version than the firmware version that is running on the access point, the configuration of the access point is reset (cleared) with the exception of the IP address, access point name, and password for the local browser UI. The access point restarts and broadcasts SSID Netgearxxxxxx, in which xxxxxx represents the last six hexadecimal digits of the access point's MAC address. The MAC address is listed on the product label. The default WiFi passphrase is **sharedsecret**.

### To revert to the backup firmware on the access point:

1. Launch a web browser from a computer that is connected to the same network as the access point or directly to the access point through an Ethernet cable or WiFi connection.

2. Enter the IP address that is assigned to the access point.

A login window displays.

If your browser does not display the login window but displays a security message and does not let you proceed, see [Log in to the access point after initial setup](#) on page 46.

3. Enter the access point user name and password.

The user name is **admin**. The password is the one that you specified. The user name and password are case-sensitive.

If you previously added the access point to a NETGEAR Insight network location and managed the access point through the Insight app or Insight Cloud portal, enter the Insight network password for that location. For more information, see [Connect over WiFi using the NETGEAR Insight app](#) on page 31.

The Dashboard page displays.

4. Select **Management > Maintenance > Upgrade > Firmware Upgrade**.

The Firmware Upgrade page displays. The page shows both the current firmware version and the backup firmware version.

5. Click the **Boot up Backup Firmware** button.

A warning pop-up window displays.

**IMPORTANT:** When you revert to the backup firmware, the configuration of the access point is reset (cleared) with the exception of the IP address, access point name, and password for the local browser UI. The access point restarts and broadcasts SSID Netgearxxxxxx, in which xxxxxx represents the last six hexadecimal digits of the access point's MAC address. The MAC address is listed on the product label. The default WiFi passphrase is **sharedsecret**.

6. Click the **Swap** button.

The pop-up window closes, the firmware reversion process initiates, and the access point restarts.

**WARNING:** To avoid the risk of corrupting the firmware, do not interrupt the reversion. For example, do not close the browser, click a link, or load a new page. Do not turn off the access point. Wait until the access point finishes restarting and the Power/Cloud LED remains solid green or solid blue.

7. Verify that the access point runs the backup firmware version by logging back in to the access point.

The firmware version is displayed on the Dashboard page.

## Use an SFTP server to upgrade the access point

If someone (usually the network administrator) places new firmware on a secure FTP (SFTP) server in the network, you can load the firmware from the SFTP server and upgrade the firmware of the access point.

### **To upgrade the firmware of the access point from an SFTP server:**

1. Launch a web browser from a computer that is connected to the same network as the access point or directly to the access point through an Ethernet cable or WiFi connection.

2. Enter the IP address that is assigned to the access point.

A login window displays.

If your browser does not display the login window but displays a security message and does not let you proceed, see [Log in to the access point after initial setup](#) on page 46.

3. Enter the access point user name and password.

The user name is **admin**. The password is the one that you specified. The user name and password are case-sensitive.

If you previously added the access point to a NETGEAR Insight network location and managed the access point through the Insight app or Insight Cloud portal, enter the

Insight network password for that location. For more information, see [Connect over WiFi using the NETGEAR Insight app](#) on page 31.

The Dashboard page displays.

4. Select **Management > Maintenance > Upgrade > Firmware Upgrade**.

The Firmware Upgrade page displays.

5. From the **Upgrade Options** menu, select **SFTP**.

6. Specify the following server settings:

- **Firmware File.** The name of the access point firmware file on the SFTP server.
- **SFTP Server IP.** The IP address of the SFTP server on your network.
- **User Name.** The user name that is required to access the SFTP server.
- **Password.** The password that is required to access the SFTP server.

7. Click the **Upgrade** button.

**WARNING:** To avoid the risk of corrupting the firmware, do not interrupt the upgrade. For example, do not close the browser, click a link, or load a new page. Do not turn off the access point. Wait until the access point finishes restarting and the Power/Cloud LED remains solid green or solid blue.

The firmware upgrade process takes several minutes. When the upgrade is complete, the access point restarts.

8. Verify that the access point runs the new firmware version by logging back in to the access point.

The firmware version is displayed on the Dashboard page.

## Manage the configuration file of the access point

The configuration settings of the access point are stored within the access point in a configuration file. You can back up (save) this file to your computer or restore it.

### Back up the access point configuration

You can save a copy of the current configuration settings. If necessary, you can restore the configuration settings later.

**Note:** The backup file is saved in a binary format so that it is protected and cannot be opened by a regular application.

**To back up the access point's configuration settings:**

1. Launch a web browser from a computer that is connected to the same network as the access point or directly to the access point through an Ethernet cable or WiFi connection.

2. Enter the IP address that is assigned to the access point.

A login window displays.

If your browser does not display the login window but displays a security message and does not let you proceed, see [Log in to the access point after initial setup](#) on page 46.

3. Enter the access point user name and password.

The user name is **admin**. The password is the one that you specified. The user name and password are case-sensitive.

If you previously added the access point to a NETGEAR Insight network location and managed the access point through the Insight app or Insight Cloud portal, enter the Insight network password for that location. For more information, see [Connect over WiFi using the NETGEAR Insight app](#) on page 31.

The Dashboard page displays.

4. Select **Management > Maintenance > Upgrade > Backup and Restore > Backup Settings**.

The Backup Settings page displays.

5. Click the **Backup** button.

A pop-up window displays.

6. Enter a password to protect the backup file, and click the **Continue** button.

You can either use your existing password (the one that you use to log in to the access point) or enter a unique password.

The password must be 8 to 63 characters in length and must contain at least one uppercase letter, one lowercase letter, and one number. The following special characters are allowed:

! @ # \$ % ^ & \* ( )

**Tip:** We recommend that you save the password because you must enter it again if you restore the configuration from the backup file.

7. Choose a location to store the file on your computer.
-

The name of the backup file is

WAX6XX-NETGEARYYYYYY-dd-mm-yy\_hh-mm-ss-config.tar, in which 6XX represents the model number, YYYYYY represents the last six hexadecimal digits of the access point's MAC address (or the system name), dd is the date, mm is the month, yy is the year, hh is the hour (in 24-hour format), mm is the minutes, and ss is the seconds.

An example of a name of a backup file is

WAX6XX-NETGEAR1A2B3C-03-06-20\_16-45-35-config.tar.

8. Follow the directions of your browser to save the file.

## Restore the access point configuration

If you backed up the configuration file, you can restore the configuration from this file.

### To restore configuration settings that you backed up:

1. Launch a web browser from a computer that is connected to the same network as the access point or directly to the access point through an Ethernet cable or WiFi connection.

2. Enter the IP address that is assigned to the access point.

A login window displays.

If your browser does not display the login window but displays a security message and does not let you proceed, see [Log in to the access point after initial setup](#) on page 46.

3. Enter the access point user name and password.

The user name is **admin**. The password is the one that you specified. The user name and password are case-sensitive.

If you previously added the access point to a NETGEAR Insight network location and managed the access point through the Insight app or Insight Cloud portal, enter the Insight network password for that location. For more information, see [Connect over WiFi using the NETGEAR Insight app](#) on page 31.

The Dashboard page displays.

4. Select **Management > Maintenance > Upgrade > Backup and Restore > Restore Settings**.

The Restore Settings page displays.

5. Click the **Browse** button and navigate to and select the saved configuration file.

The name of the backup file is

WAX6XX-NETGEARYYYYYY-dd-mm-yy\_hh-mm-ss-config.tar, in which 6XX represents the model number, YYYYYY represents the last six hexadecimal digits of

the access point's MAC address (or the system name), dd is the date, mm is the month, yy is the year, hh is the hour (in 24-hour format), mm is the minutes, and ss is the seconds.

An example of a name of a backup file is

WAX6XX-NETGEAR1A2B3C-03-06-20\_16-45-35-config.tar.

6. Click the **Restore** button.

A pop-up window displays.

7. Enter the password that you specified when you saved the backup file, and click the **Continue** button.

8. Click the **Restore** button.

The pop-up window closes and the configuration is uploaded to the access point. When the restoration is complete, the access point reboots. This process takes about two minutes.

**WARNING:** To avoid the risk of corrupting the firmware, do not interrupt the restoration. For example, do not close the browser, click a link, or load a new page. Do not turn off the access point. Wait until the access point finishes restarting and the Power/Cloud LED turns solid green or solid blue.

## Reboot the access point from the local browser UI

If you cannot physically access the access point to reboot it (that is, disconnect the power and reconnect the power), you can use the local browser UI to reboot the access point.

### **To reboot the access point:**

1. Launch a web browser from a computer that is connected to the same network as the access point or directly to the access point through an Ethernet cable or WiFi connection.

2. Enter the IP address that is assigned to the access point.

A login window displays.

If your browser does not display the login window but displays a security message and does not let you proceed, see [Log in to the access point after initial setup](#) on page 46.

3. Enter the access point user name and password.

The user name is **admin**. The password is the one that you specified. The user name and password are case-sensitive.

If you previously added the access point to a NETGEAR Insight network location and managed the access point through the Insight app or Insight Cloud portal, enter the Insight network password for that location. For more information, see [Connect over WiFi using the NETGEAR Insight app](#) on page 31.

The Dashboard page displays.

4. Select **Management > Maintenance > Reset > Reboot AP**.

The Reboot AP page displays.

5. Click the **Reboot AP** button.

A warning pop-up window displays.

6. Click the **Reboot** button.

The pop-up window closes and the access point reboots, which takes about one minute.

## Schedule the access point to reboot

You can schedule the access point to reboot at a time that is more convenient for the network, for example, when you do not expect any (or only a few) WiFi clients to be connected to the access point. The schedule that you set up is a recurring schedule.

### To schedule the access point to reboot:

1. Launch a web browser from a computer that is connected to the same network as the access point or directly to the access point through an Ethernet cable or WiFi connection.

2. Enter the IP address that is assigned to the access point.

A login window displays.

If your browser does not display the login window but displays a security message and does not let you proceed, see [Log in to the access point after initial setup](#) on page 46.

3. Enter the access point user name and password.

The user name is **admin**. The password is the one that you specified. The user name and password are case-sensitive.

If you previously added the access point to a NETGEAR Insight network location and managed the access point through the Insight app or Insight Cloud portal, enter the



Insight network password for that location. For more information, see [Connect over WiFi using the NETGEAR Insight app](#) on page 31.

The Dashboard page displays.

4. Select **Management > Maintenance > Reset > Reboot AP**.

The Reboot AP page displays.

5. Click the **Enable Scheduled Reboot** button so that the button displays blue.

The scheduling controls display.

6. Select the check box for the day on which you want the access point to reboot.

You can select multiple days.

7. Using the **Start Time** menus, specify the hour and minutes for the time at which the access point must reboot.

Specify the hour in 24-hour format.

8. Click the **Apply** button.

Your settings are saved.

## Return the access point to its factory default settings

Under some circumstances (for example, if you lost track of the changes that you made to the access point settings or you move the access point to a different network), you might want to erase the configuration and reset the access point to factory default settings.

If you do not know the current IP address of the access point, first try to use an IP scanner application to detect the IP address before you reset the access point to factory default settings.

**Note:** You can also use the NETGEAR Insight app to discover the IP address that is assigned to the access point. For more information, see [Connect over WiFi using the NETGEAR Insight app](#) on page 31.

To reset the access point to factory default settings, you can use either the **Reset** button on the access point or the use the erase function in the local browser UI. However, if you cannot find the IP address or you lost the password to access the access point, you must use the **Reset** button.

After you reset the access point to factory default settings, the password for the admin user name is password, the LAN IP address is 192.168.0.100, the access point's DHCP client is enabled, the default SSID is shown in the format NETGEARxxxxxx-SETUP, and the default password for WiFi access is sharedsecret.

For an extensive list of factory default settings, see [Factory default settings](#) on page 246.

## Use the Reset button to reset indoor model WAX610

You can use the **Reset** button to return the access point to its factory default settings. However, if you added the access point to a NETGEAR Insight network location, you must first use the Insight app or Insight Cloud portal to remove the access point from the Insight network location before the factory default settings function of the **Reset** button is available.

**CAUTION:** This process erases all settings that you configured in the access point.

### To reset the access point to factory default settings:

1. On the bottom panel of the access point, locate the recessed **Reset** button.

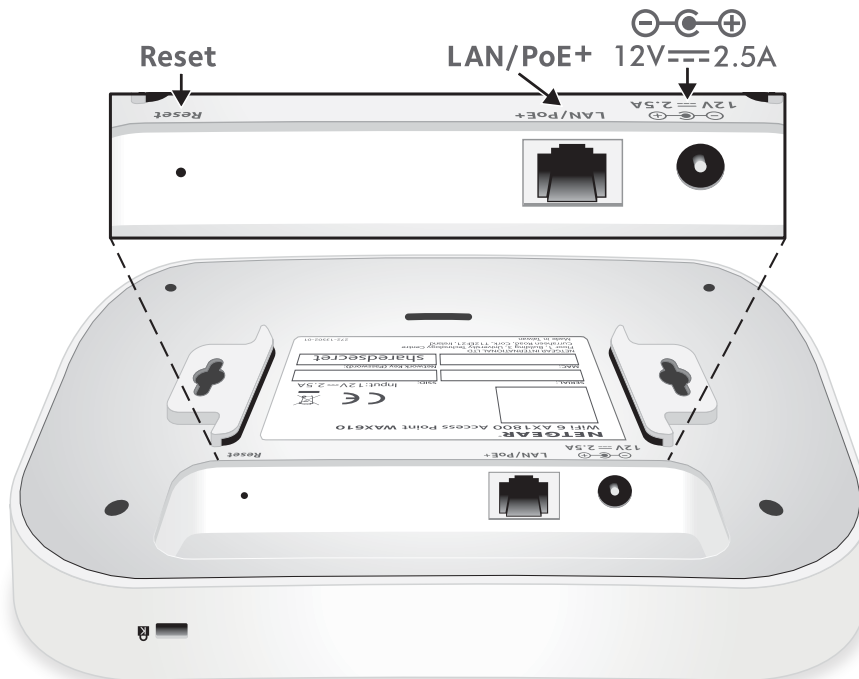

2. Using a straightened paper clip, press and hold the **Reset** button for at least 10 seconds.

**Note:** If you hold the **Reset** button for less than 10 seconds and then release it, the access point reboots rather than returns to its factory default settings.

3. Release the **Reset** button.

The configuration is reset to factory default settings. When the reset is complete, the access point reboots. This process takes about two minutes.

**WARNING:** To avoid the risk of corrupting the firmware, do not interrupt the reset. Do not turn off the access point. Wait until the access point finishes restarting and the Power/Cloud LED turns solid green or solid blue.

## Use the Reset button to reset outdoor model WAX610Y

You can use the **Reset** button to return the access point to its factory default settings. However, if you added the access point to a NETGEAR Insight network location, you must first use the Insight app or Insight Cloud portal to remove the access point from the Insight network location before the factory default settings function of the **Reset** button is available.

**CAUTION:** This process erases all settings that you configured in the access point.

### To reset the access point to factory default settings:

1. On the bottom panel of the access point, locate the recessed **Reset** button next to the LAN/PoE+ port.

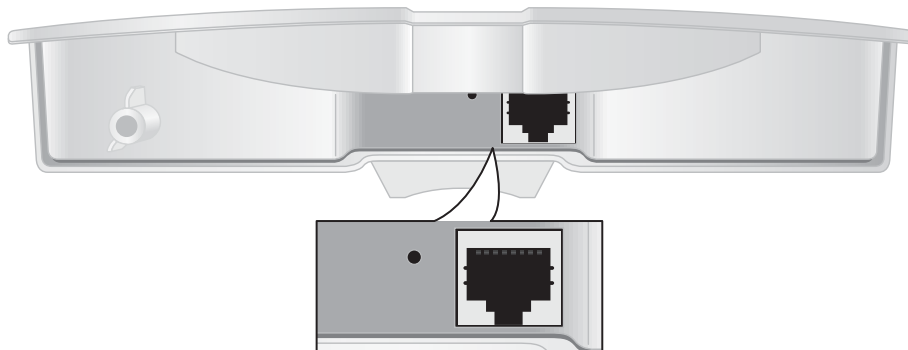

2. Using a straightened paper clip, press and hold the **Reset** button for at least 10 seconds.

**Note:** If you hold the **Reset** button for less than 10 seconds and then release it, the access point reboots rather than returns to its factory default settings.

3. Release the **Reset** button.

The configuration is reset to factory default settings. When the reset is complete, the access point reboots. This process takes about two minutes.

**WARNING:** To avoid the risk of corrupting the firmware, do not interrupt the reset. Do not turn off the access point. Wait until the access point finishes restarting and the Power/Cloud LED turns solid green or solid blue.

## Use the local browser UI to reset the access point

You can use the access point's local browser UI to return the access point to its factory default settings.

**CAUTION:** This process erases all settings that you configured in the access point.

### To erase the settings:

1. Launch a web browser from a computer that is connected to the same network as the access point or directly to the access point through an Ethernet cable or WiFi connection.

2. Enter the IP address that is assigned to the access point.

A login window displays.

If your browser does not display the login window but displays a security message and does not let you proceed, see [Log in to the access point after initial setup](#) on page 46.

3. Enter the access point user name and password.

The user name is **admin**. The password is the one that you specified. The user name and password are case-sensitive.

If you previously added the access point to a NETGEAR Insight network location and managed the access point through the Insight app or Insight Cloud portal, enter the Insight network password for that location. For more information, see [Connect over WiFi using the NETGEAR Insight app](#) on page 31.

The Dashboard page displays.

4. Select **Management > Maintenance > Reset > Restore Defaults**.

The Restore Defaults page displays.

5. Click the **Restore Defaults** button.

A warning pop-up window displays.

6. Click the **Restore** button.

The pop-up window closes and the configuration is reset to factory default settings. When the reset is complete, the access point reboots. This process takes about two minutes.

**WARNING:** To avoid the risk of corrupting the firmware, do not interrupt the reset. For example, do not close the browser, click a link, or load a new page. Do not turn off the access point. Wait until the access point finishes restarting and the Power/Cloud LED turns solid green or solid blue.

## Enable SNMP and manage the SNMP settings

You can access the access point over a Simple Network Management Protocol (SNMP) connection, which allows SNMP network management software such as HP OpenView to manage the access point by using the SNMPv1 or SNMPv2 protocol. By default, SNMP is disabled.

### **To enable SNMP and manage the SNMP settings:**

1. Launch a web browser from a computer that is connected to the same network as the access point or directly to the access point through an Ethernet cable or WiFi connection.

2. Enter the IP address that is assigned to the access point.  
A login window displays.

If your browser does not display the login window but displays a security message and does not let you proceed, see [Log in to the access point after initial setup](#) on page 46.

3. Enter the access point user name and password.

The user name is **admin**. The password is the one that you specified. The user name and password are case-sensitive.

If you previously added the access point to a NETGEAR Insight network location and managed the access point through the Insight app or Insight Cloud portal, enter the Insight network password for that location. For more information, see [Connect over WiFi using the NETGEAR Insight app](#) on page 31.

The Dashboard page displays.

4. Select **Management > Maintenance > Remote Management**.

The Remote Management page displays.

5. Select the SNMP **Enable** radio button.  
By default, SNMP is disabled.

Secure Shell (SSH)  
 Enable  Disable

SNMP  
 Enable  Disable

Read-Only Community Name	Read-Write Community Name	Trap Community Name
public	private	trap

IP Address (to receive traps) Trap Port ||  | 162 |

Cancel Apply

6. Specify the following settings:
  - **Read-Only Community Name.** The community string that allows the SNMP manager to read the access point's MIB objects. The default is public.
  - **Read-Write Community Name.** The community string that allows the SNMP manager to read and write the access point's MIB objects. The default is private.
  - **Trap Community Name.** The community name that is associated with the IP address that must receive traps. The default is trap.
  - **IP address (to receive traps).** The IP address of the SNMP manager that must receive traps.
  - **Trap Port.** The port number at which the SNMP manager must receive traps. The default is 162.
7. Click the **Apply** button.  
Your settings are saved.

## Manage the LEDs

By default, all LEDs are enabled and function as described in [Top panel with LEDs, indoor model WAX610](#) on page 11. You can manage whether the LEDs light at all. This function is useful if you want the access point to function in a dark environment.

### To enable or disable the LEDs:

1. Launch a web browser from a computer that is connected to the same network as the access point or directly to the access point through an Ethernet cable or WiFi connection.
2. Enter the IP address that is assigned to the access point.  
A login window displays.  
If your browser does not display the login window but displays a security message and does not let you proceed, see [Log in to the access point after initial setup](#) on page 46.
3. Enter the access point user name and password.  
The user name is **admin**. The password is the one that you specified. The user name and password are case-sensitive.  
If you previously added the access point to a NETGEAR Insight network location and managed the access point through the Insight app or Insight Cloud portal, enter the Insight network password for that location. For more information, see [Connect over WiFi using the NETGEAR Insight app](#) on page 31.  
The Dashboard page displays.
4. Select **Management > Configuration > System > Advanced > LED Control**.  
The LED Control page displays.
5. Select one of the following radio buttons:
  - **Enable All LEDs**. All LEDs are enabled. This is the default setting.
  - **Disable All LEDs**. All LEDs are disabled.
  - **Enable Power/Cloud LED**. All LEDs are disabled except for the Power/Cloud LED.
6. Click the **Apply** button.  
Your settings are saved.

# 12

## Monitor the Access Point and the Network

---

This chapter describes how you can monitor the access point and the network.

The chapter includes the following sections:

- [View the access point Internet, IP, and system settings](#)
- [View the WiFi radio settings](#)
- [View unknown and known neighbor access points](#)
- [View client distribution, connected clients, and client trends](#)
- [View WiFi and Ethernet traffic, traffic and ARP statistics, and channel utilization](#)
- [View or download tracked URLs](#)
- [View, save, download, or clear the logs](#)
- [View a WiFi bridge connection](#)
- [View alarms and notifications](#)



# View the access point Internet, IP, and system settings

## To view the access point, Internet, IP, and system settings:

1. Launch a web browser from a computer that is connected to the same network as the access point or directly to the access point through an Ethernet cable or WiFi connection.

2. Enter the IP address that is assigned to the access point.  
A login window displays.

If your browser does not display the login window but displays a security message and does not let you proceed, see [Log in to the access point after initial setup](#) on page 46.

3. Enter the access point user name and password.

The user name is **admin**. The password is the one that you specified. The user name and password are case-sensitive.

If you previously added the access point to a NETGEAR Insight network location and managed the access point through the Insight app or Insight Cloud portal, enter the Insight network password for that location. For more information, see [Connect over WiFi using the NETGEAR Insight app](#) on page 31.

The Dashboard page displays.

4. Locate the Connection Status Information pane, System Information pane, and IP Settings Information pane, which are shown, respectively, on the left, upper center, and lower center of the following Dashboard figure.

(If the page width on your device is narrow, these panes might be located elsewhere on the Dashboard.)

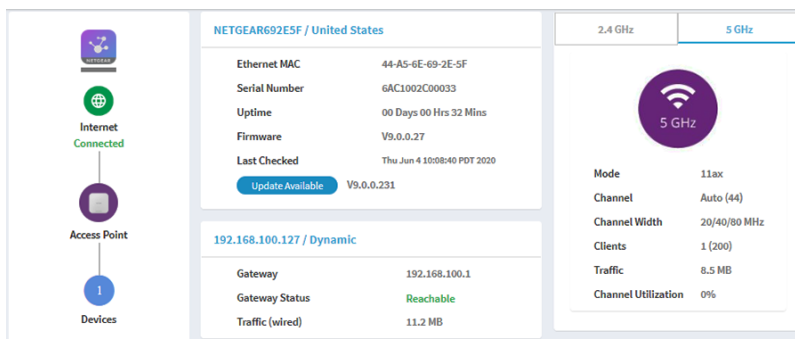

- **Connection Status Information pane.** This pane is in the top, left corner of the Dashboard (if the page width on your device is sufficient; otherwise, it might be elsewhere) and displays the following:
  - Status of the connection to the NETGEAR Insight cloud-based management platform, if any.
  - Status of the Internet connection.
  - Functioning mode of the access point, which is always Access Point.
  - Number of clients connected to the access point.
- **System Information pane.** This pane is in the center at the top of the Dashboard (if the page width on your device is sufficient; otherwise, it might be elsewhere) and displays the following:
  - System name of the access point and country or region of operation.
  - Ethernet MAC address.
  - The serial number.
  - Device uptime.
  - Firmware version.
  - The date and time that the access point itself or someone manually last checked if new firmware was available.

This pane also contains a button that you can click to check for firmware updates for the access point. If an update is available, the **Update Available** button displays. (For more information about firmware updates, see [Check for new firmware and upgrade the access point](#) on page 159).

- **IP Settings Information pane.** This pane is in the center of the Dashboard page (if the page width on your device is sufficient; otherwise, it might be elsewhere) and displays the following:
  - IP address of the access point and its DHCP status.
  - Gateway IP address.
  - Gateway status.
  - Wired traffic volume.

5. To view more detailed information, select **Management > Monitoring > System**.

## Insight Managed WiFi 6 AX1800 Dual Band Access Point Models WAX610 and WAX610Y

**System Information**

System Name	NETGEAR692E5F
System Mode	AP
LAN MAC Address	44-A5-6E-69-2E-5F
Wireless MAC Address for 2.4 GHz	44-A5-6E-69-2E-40
Wireless MAC Address for 5 GHz	44-A5-6E-69-2E-60
Power Source	PoE 802.3at
Ethernet LLDP	Enabled
Country / Region	United States
Current Firmware Version	V9.0.0.27
Backup Firmware Version	V9.0.0.24
Bootloader Version	U-Boot 2016.01-V9.0.0.12
Serial Number	6AC1002C00033
Current Time	Thu Jun 4 10:43:20 PDT 2020
Uptime	00 Days 00 Hrs 37 Mins

**AP Interface Status**

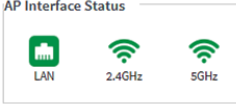

LAN 2.4GHz 5GHz

**IPv4 Settings**

IPv4 Address	192.168.100.127
Subnet Mask	255.255.255.0
Default Gateway	192.168.100.1
DHCP Client	Enabled

**Wireless Settings**

Parameters	2.4 GHz	5 GHz
Antenna	2x2	2x2
Wireless Mode	11ax	11ax
Channel / Frequency	Auto (6)/2.437 GHz	Auto (44)/5.22 GHz

The page shows four sections:

- **System Information section.** The following settings are displayed:
  - **System Name.** The access point NetBIOS name.
  - **System Mode.** The access point system mode (AP).
  - **LAN MAC Address.** The MAC address of the LAN Ethernet port of the access point.
  - **Wireless MAC Address for 2.4 GHz.** The MAC address of 2.4 GHz WiFi interface (radio) of the access point.
  - **Wireless MAC Address for 5 GHz.** The MAC address of 5 GHz WiFi interface (radio) of the access point.
  - **Power Source.** The type of power source (PoE 802.3at or Power Adapter).
  - **Ethernet LLDP.** The status of Ethernet LLDP feature (Enabled or Disabled).
  - **LLDP Neighbour.** The name of the LLDP neighbour, if any.
  - **Country / Region.** The country or region in which the access point operates or for which the access point is licensed.
  - **Current Firmware Version.** The version of the firmware that is running on the access point.
  - **Backup Firmware Version.** The version of the backup firmware on the access point.
  - **Bootloader Version.** The primary bootloader (U-Boot) version that is installed on the access point.
  - **Serial Number.** The serial number of the access point.

- **Current Time.** The current system time of the access point.
- **Uptime.** The time since the access point was last restarted.
- **AP Interface Status.** A green icon indicates that the interface is in use. A gray icon indicates that the interface is not in use.
- **IPv4 Settings section.** The following settings are displayed:
  - **IPv4 Address.** The IPv4 address of the access point.
  - **Subnet Mask.** The subnet mask of the access point.
  - **Default Gateway.** The default gateway for the access point.
  - **DHCP Client.** The status of DHCP client (Enabled or Disabled).
- **Wireless Settings section.** The following settings are displayed, with separate columns for the 2.4 GHz and 5 GHz radios:
  - **Antenna.** The type of antenna (by default, 2x2).
  - **Wireless Mode.** The operating WiFi mode of the radio.
  - **Channel / Frequency.** The channel and frequency that are used by the radio.

## View the WiFi radio settings

### To view the WiFi radio settings of the access point:

1. Launch a web browser from a computer that is connected to the same network as the access point or directly to the access point through an Ethernet cable or WiFi connection.

2. Enter the IP address that is assigned to the access point.

A login window displays.

If your browser does not display the login window but displays a security message and does not let you proceed, see [Log in to the access point after initial setup](#) on page 46.

3. Enter the access point user name and password.

The user name is **admin**. The password is the one that you specified. The user name and password are case-sensitive.

If you previously added the access point to a NETGEAR Insight network location and managed the access point through the Insight app or Insight Cloud portal, enter the

Insight network password for that location. For more information, see [Connect over WiFi using the NETGEAR Insight app](#) on page 31.

The Dashboard page displays.

4. Locate the Radio Information pane at the top, right corner of the Dashboard page (if the page width on your device is sufficient; otherwise, it might be elsewhere).

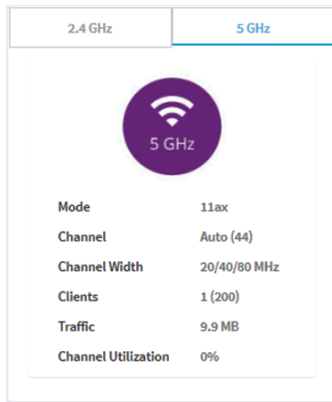

The following settings are displayed:

- Radio status (If the 2.4 GHz or 5 GHz icon is displayed as gray, the radio is turned off.)
  - Mode
  - Channel
  - Channel width
  - Number of connected clients and maximum number of supported clients
  - WiFi traffic volume
  - Channel utilization
5. To view information about the other radio, click either the **2.4 GHz** or **5 GHz** tab. The pane adjusts.

6. To view more detailed information, select **Management > Monitoring > System**.

The screenshot displays four sections of system information:

- System Information:**

System Name	NETGEAR692E5F
System Mode	AP
LAN MAC Address	44-A5-6E-69-2E-5F
Wireless MAC Address for 2.4 GHz	44-A5-6E-69-2E-40
Wireless MAC Address for 5 GHz	44-A5-6E-69-2E-60
Power Source	PoE 802.3at
Ethernet LLDP	Enabled
Country / Region	United States
Current Firmware Version	V9.0.0.27
Backup Firmware Version	V9.0.0.24
Bootloader Version	U-Boot 2016.01-V9.0.0.12
Serial Number	6AC1002C00033
Current Time	Thu Jun 4 10:43:20 PDT 2020
Uptime	00 Days 00 Hrs 37 Mins
- AP Interface Status:** Shows icons for LAN, 2.4GHz, and 5GHz.
- IPv4 Settings:**

IPv4 Address	192.168.100.127
Subnet Mask	255.255.255.0
Default Gateway	192.168.100.1
DHCP Client	Enabled
- Wireless Settings:**

Parameters	2.4 GHz	5 GHz
Antenna	2x2	2x2
Wireless Mode	11ax	11ax
Channel / Frequency	Auto (6)/2.437 GHz	Auto (44)/5.22 GHz

The page shows four sections:

- **System Information section.** The following settings are displayed:
  - **System Name.** The access point NetBIOS name.
  - **System Mode.** The access point system mode (AP).
  - **LAN MAC Address.** The MAC address of the LAN Ethernet port of the access point.
  - **Wireless MAC Address for 2.4 GHz.** The MAC address of 2.4 GHz WiFi interface (radio) of the access point.
  - **Wireless MAC Address for 5 GHz.** The MAC address of 5 GHz WiFi interface (radio) of the access point.
  - **Power Source.** The type of power source (PoE 802.3at or Power Adapter).
  - **Ethernet LLDP.** The status of Ethernet LLDP feature (Enabled or Disabled).
  - **LLDP Neighbour.** The name of the LLDP neighbour, if any.
  - **Country / Region.** The country or region in which the access point operates or for which the access point is licensed.
  - **Current Firmware Version.** The version of the firmware that is running on the access point.
  - **Backup Firmware Version.** The version of the backup firmware on the access point.
  - **Bootloader Version.** The primary bootloader (U-Boot) version that is installed on the access point.

- **Serial Number.** The serial number of the access point.
- **Current Time.** The current system time of the access point.
- **Uptime.** The time since the access point was last restarted.
- **AP Interface Status.** A green icon indicates that the interface is in use. A gray icon indicates that the interface is not in use.
- **IPv4 Settings section.** The following settings are displayed:
  - **IPv4 Address.** The IPv4 address of the access point.
  - **Subnet Mask.** The subnet mask of the access point.
  - **Default Gateway.** The default gateway for the access point.
  - **DHCP Client.** The status of DHCP client (Enabled or Disabled).
- **Wireless Settings section.** The following settings are displayed, with separate columns for the 2.4 GHz and 5 GHz radios:
  - **Antenna.** The type of antenna (by default, 2x2).
  - **Wireless Mode.** The operating WiFi mode of the radio.
  - **Channel / Frequency.** The channel and frequency that are used by the radio.

## View unknown and known neighbor access points

If you enabled neighbor access point (AP) detection (see [Manage neighbor AP detection](#) on page 127), you can view the unknown access points in the Unknown AP list and the known access points in the Known AP list.

### To view the detected neighbor access points:

1. Launch a web browser from a computer that is connected to the same network as the access point or directly to the access point through an Ethernet cable or WiFi connection.
2. Enter the IP address that is assigned to the access point.  
A login window displays.

If your browser does not display the login window but displays a security message and does not let you proceed, see [Log in to the access point after initial setup](#) on page 46.

3. Enter the access point user name and password.

The user name is **admin**. The password is the one that you specified. The user name and password are case-sensitive.

If you previously added the access point to a NETGEAR Insight network location and managed the access point through the Insight app or Insight Cloud portal, enter the Insight network password for that location. For more information, see [Connect over WiFi using the NETGEAR Insight app](#) on page 31.

The Dashboard page displays.

4. Select **Management > Monitoring > Neighbor AP**.

Unknown AP Known AP

2.4 GHz : 3 5 GHz : 2

Show 10 Entries Search:

MAC Address	SSID	Radio	Channel	RSSI	Timestamp
08-00-00-00-00-00	Netgear3A21CF	5 GHz	161	94	Fri Aug 4 17:30:05 PDT
60-00-00-00-00-00	SimplePresenceNetwork 5GHz	5 GHz	44	53	Fri Aug 4 17:30:05 PDT
B0-00-00-00-00-00	RMCS-Farms	2.4 GHz	5	2	Fri Aug 4 17:09:53 PDT
FA-00-00-00-00-00		2.4 GHz	1	79	Fri Aug 4 17:34:57 PDT
FA-00-00-00-00-00		2.4 GHz	1	87	Fri Aug 4 17:34:57 PDT

Previous 1 Next

Refresh

At the top of the page, for each radio band, the page displays the total number of unknown access points.

For information about moving unknown access points to the Known AP list, see [Enable neighbor access point detection and move access points to the Known AP List](#) on page 128.

5. To display the most recent unknown access points, click the **Refresh** button.
6. To view the Known AP list, click the **Known AP** tab.

Unknown AP Known AP

2.4 GHz : 2 5 GHz : 0

Show 10 Entries Search:

MAC Address	SSID	Radio	Channel	RSSI	Timestamp
08-00-00-00-00-00	Netgear3A21CF	2.4 GHz	5	94	Fri Aug 4 17:34:57 PDT
60-33-00-00-00-00	SimplePresenceNetwork	2.4 GHz	1	90	Fri Aug 4 17:34:57 PDT

Previous 1 Next

Refresh



At the top of the page, for each radio band, the page displays the total number of known access points.

7. To display the most recent known access points, click the **Refresh** button.

# View client distribution, connected clients, and client trends

## To view the clients that are connected to the access point over WiFi:

1. Launch a web browser from a computer that is connected to the same network as the access point or directly to the access point through an Ethernet cable or WiFi connection.

2. Enter the IP address that is assigned to the access point.

A login window displays.

If your browser does not display the login window but displays a security message and does not let you proceed, see [Log in to the access point after initial setup](#) on page 46.

3. Enter the access point user name and password.

The user name is **admin**. The password is the one that you specified. The user name and password are case-sensitive.

If you previously added the access point to a NETGEAR Insight network location and managed the access point through the Insight app or Insight Cloud portal, enter the Insight network password for that location. For more information, see [Connect over WiFi using the NETGEAR Insight app](#) on page 31.

The Dashboard page displays.

4. Locate the Client Distribution pane (shown on the left side in the following figure) and the Recent Clients pane (shown on the right side).

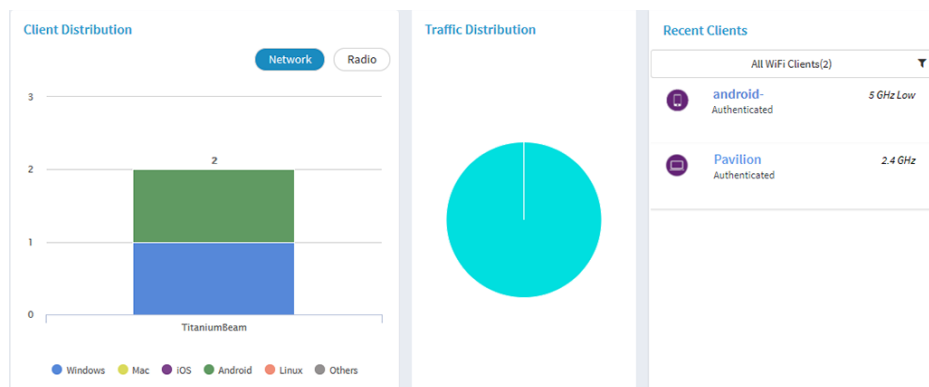

The Client Distribution pane shows the types of clients (Windows, Mac, iOS, Android, Linux, and other operating systems) and how these clients are distributed over the networks. (By default, the **Network** button is selected.)

The Recent Clients pane shows the top 5 recently connected clients list.

5. To see how the clients are distributed over the radios, click the **Radio** button in the Client Distribution pane.

The page adjusts and shows the types of clients for each radio.

6. To see recent clients for all networks or a single network, in the Connected Clients pane, click the icon in the menu under Recent Clients, and select **All WiFi Clients** or the clients for a specific WiFi network (SSID).

For your selection, the pane displays the total number of connected clients and the device names of the connected clients.

7. To view information about a connected client, click its device name.

The page displays the MAC address, device name, IP address, and SSID for the client. You can also view more information, including very detailed information (see [Step 11](#) and [Step 12](#)).

8. To view trends about clients, scroll down to the Hours Trend pane.

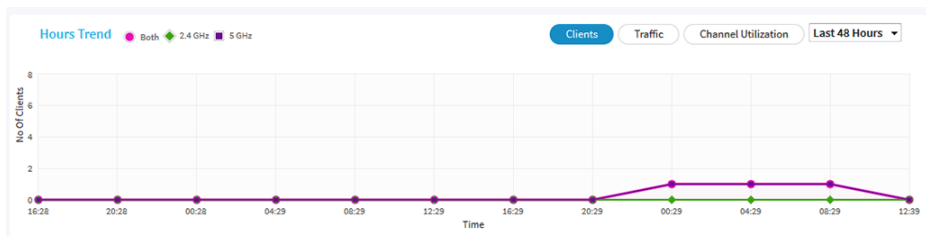

The Hours Trend pane shows a graph with the number of clients, the traffic in MB, or the channel utilization over a period that you can select. (The previous figure shows the trend for the last 48 hours.) By default, the client information is selected (that is, the **Client** button is selected) and the graph shows the total number of clients for both radios and the number of clients for each radio (2.4 GHz and 5 GHz).

You can also click the **Traffic** button or the **Channel Utilization** button. For more information, see [View WiFi and Ethernet traffic, traffic and ARP statistics, and channel utilization](#) on page 188.

9. To view more information, point to a node on one of the lines on the graph.
10. To change the period over which information is filtered and displayed, select the number of recent hours from the menu to the right of the buttons.

11. To view more information about currently connected WiFi, select **Management > Monitoring > Connected Clients**.

Wireless Clients

2.4 GHz Clients : 0 (200)

#	SSID	MAC Address	IP Address	Host Name	OS	Mode
No Available Clients						

5 GHz Clients : 1 (200)

Show 10 Entries Search:

#	SSID	MAC Address	IP Address	Host Name	OS	Mode
1	TitaniumBeam	C1-B1-D1-B1-F1-F1	192.168.100.198	android-	Generic Android	11AC

Previous 1 Next

Refresh

For each radio, the page displays the number of connected clients and the maximum number of supported clients.

For each radio and each WiFi client, the page displays the SSID, MAC address, IP address, host name, operating system (OS), and WiFi mode.

12. To view very detailed information about a WiFi client, click the information icon to the left of the client.

The Detailed Client Information page displays and shows the following information:

- **MAC Address.** The MAC address of the client.
- **IP Address.** The IP address associated with the client.
- **Host Name.** The host name of the client.
- **OS.** The operating system that runs on the client.
- **BSSID.** The BSSID that the client connects to.
- **SSID.** The SSID of the radio that the client connects to.
- **Channel.** The channel that the client connects to.
- **Channel Width.** The width of the channel that the client connects to.
- **Tx Rate.** The rate of traffic transmission of the client.
- **Rx Rate.** The rate of traffic reception of the client.
- **RSSI.** The RSSI threshold value of the client.
- **Tx Bytes.** The number of bytes that the client transmitted.
- **Rx Bytes.** The number of bytes that the client received.
- **State.** The QoS state of the connection.
- **Type.** The type of WiFi security that is used for the connection.

- **Device Type.** The type of device that the client is.
  - **Mode.** The WiFi mode of the connection.
  - **Status.** The security status of the connection.
  - **Idle Time.** The time that the client remained idle.
  - **Assoc Time Stamp.** The time that is associated with the information on the Detailed Client Information page.
13. If you opened the Detailed Client Information page, click the **Close** button.  
The Detailed Client Information page closes.
14. To display the most recent information, click the **Refresh** button.

## View WiFi and Ethernet traffic, traffic and ARP statistics, and channel utilization

### To view WiFi and Ethernet (wired LAN) traffic, traffic and ARP statistics, and channel utilization:

1. Launch a web browser from a computer that is connected to the same network as the access point or directly to the access point through an Ethernet cable or WiFi connection.
2. Enter the IP address that is assigned to the access point.  
A login window displays.  
  
If your browser does not display the login window but displays a security message and does not let you proceed, see [Log in to the access point after initial setup](#) on page 46.
3. Enter the access point user name and password.  
The user name is **admin**. The password is the one that you specified. The user name and password are case-sensitive.  
  
If you previously added the access point to a NETGEAR Insight network location and managed the access point through the Insight app or Insight Cloud portal, enter the Insight network password for that location. For more information, see [Connect over WiFi using the NETGEAR Insight app](#) on page 31.  
The Dashboard page displays.
4. Scroll down to the Hours Trend pane at the bottom of the Dashboard page.

By default, the **Clients** button is selected.

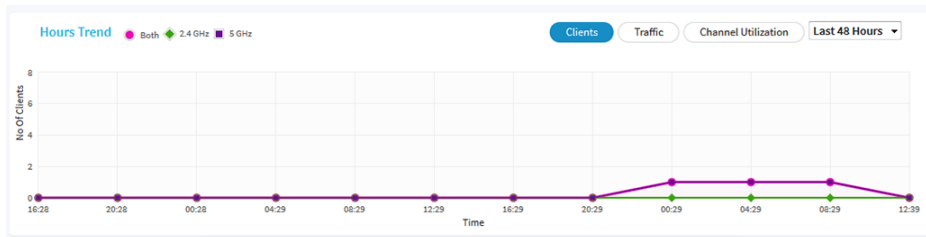

5. To view traffic information, do the following:
  - a. Click the **Traffic** button.  
The graph shows the information for Ethernet (wired LAN) traffic, total WiFi traffic, WiFi traffic for the 2.4 GHz radio, and WiFi traffic for the 5 GHz radio.
  - b. To view more information, point to a node on one of the lines on the graph.
6. To view channel utilization, do the following:
  - a. Click the **Channel Utilization** button.  
The graph shows the channel utilization for the 2.4 GHz radio.
  - b. To view the channel utilization for the 5 GHz radio, click the **5 GHz** button.
  - c. To view more information, point to a bar.
7. To change the period over which information is filtered and displayed, select the number of recent hours from the menu to the right of the buttons.

- To view traffic statistics, select **Management > Monitoring > Statistics**.

Wireless

Parameters	2.4 GHz		5 GHz	
	Received	Transmitted	Received	Transmitted
Unicast Packets	0	0	62477	96469
Broadcast Packets	0	0	12	694
Multicast Packets	0	0	102	7773
Total Packets	0	0	62591	104936
Total Bytes	0	0	9327887	133718139
Number of Clients	0		1	

ARP Statistics

ARP Packets Received	Proxied ARP's	ARP Packets Dropped
1378	13	1378

Ethernet

Parameter	Received	Transmitted
Total Packets	112677	70349
Total Bytes	132191664	12617424

[Refresh](#)

The page displays the network traffic statistics for both the WiFi and Ethernet interfaces of the access point since the access point started or rebooted. The page also displays the number of clients that are associated with each radio.

If the ARP proxy is enabled (see [Manage the ARP proxy](#) on page 213), the page also displays the ARP statistics, including the number of proxied and dropped packets.

- To display the most recent information, click the **Refresh** button.

## View or download tracked URLs

If you enabled URL tracking for a WiFi network (see [Enable or disable URL tracking for a WiFi network](#) on page 80), you can view the tracked URLs by URL, WiFi client, and SSID. You can also download a URL tracking report as a `.csv` file.

### To view or download tracked URLs:

- Launch a web browser from a computer that is connected to the same network as the access point or directly to the access point through an Ethernet cable or WiFi connection.
- Enter the IP address that is assigned to the access point.

A login window displays.

If your browser does not display the login window but displays a security message and does not let you proceed, see [Log in to the access point after initial setup](#) on page 46.

3. Enter the access point user name and password.

The user name is **admin**. The password is the one that you specified. The user name and password are case-sensitive.

If you previously added the access point to a NETGEAR Insight network location and managed the access point through the Insight app or Insight Cloud portal, enter the Insight network password for that location. For more information, see [Connect over WiFi using the NETGEAR Insight app](#) on page 31.

The Dashboard page displays.

4. Select **Management > Monitoring > URL Tracking**.

The screenshot shows a dashboard interface for URL Tracking. At the top, there is a 'List by' dropdown menu set to 'URL'. Below this is a table with four columns: 'URL', 'Clients', 'SSIDs', and 'Hit-Count'. The table lists ten different URLs, each with a corresponding client MAC address (all starting with C1-BD-D1-B0-F0-F1...), a SSID (all starting with TitaniumBeam...), and a hit count. Below the table, there are navigation links: 'Previous', '1', '2', '3', 'Next', and 'View All'. At the bottom of the dashboard, there are two buttons: 'Clear' and 'Download'.

URL	Clients	SSIDs	Hit-Count
api.twitter.com	C1-BD-D1-B0-F0-F1...	TitaniumBeam...	2
userlocation.googleapis.co	C1-BD-D1-B0-F0-F1...	TitaniumBeam...	1
graph.facebook.com	C1-BD-D1-B0-F0-F1...	TitaniumBeam...	2
edge-mqtt.facebook.com	C1-BD-D1-B0-F0-F1...	TitaniumBeam...	1
m.barclaycardus.com	C1-BD-D1-B0-F0-F1...	TitaniumBeam...	1
decide.mixpanel.com	C1-BD-D1-B0-F0-F1...	TitaniumBeam...	2
api.mixpanel.com	C1-BD-D1-B0-F0-F1...	TitaniumBeam...	2
app.alivecor.com	C1-BD-D1-B0-F0-F1...	TitaniumBeam...	2
youtubei.googleapis.com	C1-BD-D1-B0-F0-F1...	TitaniumBeam...	4
googleads.g.doubleclick.ne	C1-BD-D1-B0-F0-F1...	TitaniumBeam...	2

By default, the table shows the URLs that were accessed, each with the MAC address of the WiFi client that accessed the URL, the associated SSID, and the number of times that the WiFi client accessed the URL.

5. To view additional information, click the **...** link to the right of a MAC address or SSID.

6. To view URL tracking information by WiFi client, do the following:
  - a. From the menu, select **Client**.  
The table shows the MAC addresses of the WiFi clients, each with the client host name, and the first URL of the list of URLs that the client accessed.
  - b. To view all URLs that a WiFi client accessed, click the ... link to the right of the first URL.  
A pop-up window displays all URLs that the WiFi client accessed.
  - c. Click the **Close** button.  
The pop-up window closes.
7. To view URL tracking information by SSID, do the following:
  - a. From the menu, select **SSID**.  
The table shows the SSIDs and the first URL of the list of URLs that were accessed on the SSID.
  - b. To view all URLs that were accessed on the SSID, click the ... link to the right of the first URL.  
A pop-up window displays all URLs that the were accessed on the SSID.
  - c. Click the **Close** button.  
The pop-up window closes.
8. To download a URL tracking report as a .csv file, click the **Download** button, and follow the directions of your browser.
9. To clear all URL tracking information, do the following:
  - a. Click the **Clear** button.  
A warning pop-up window displays.
  - b. Click the **OK** button.  
The pop-up window closes and the information is cleared.

## View, save, download, or clear the logs

You can view and manage the activity logs of the access point. You can also download a detailed log file.

**Note:** If the access point functions in the NETGEAR Insight management mode, you can also view and manage the cloud activity logs, which show the connection of the access point to the Insight cloud-based management platform. If the access point functions in the NETGEAR Insight management mode, this is option is available from the Dashboard page by selecting **Management > Monitoring > Cloud Logs**.



### To view, save, download, or clear the logs:

1. Launch a web browser from a computer that is connected to the same network as the access point or directly to the access point through an Ethernet cable or WiFi connection.
2. Enter the IP address that is assigned to the access point.

A login window displays.

If your browser does not display the login window but displays a security message and does not let you proceed, see [Log in to the access point after initial setup](#) on page 46.

3. Enter the access point user name and password.

The user name is **admin**. The password is the one that you specified. The user name and password are case-sensitive.

If you previously added the access point to a NETGEAR Insight network location and managed the access point through the Insight app or Insight Cloud portal, enter the Insight network password for that location. For more information, see [Connect over WiFi using the NETGEAR Insight app](#) on page 31.

The Dashboard page displays.

4. Select **Management > Monitoring > Logs**.

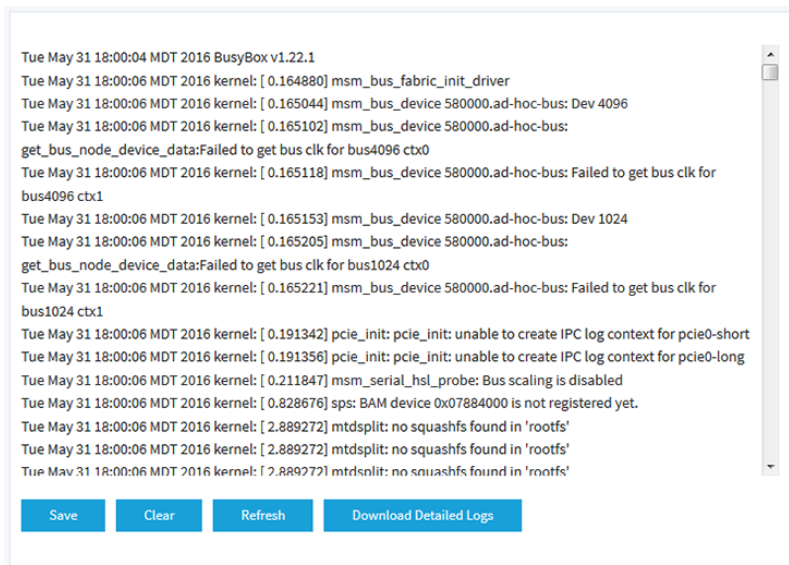

```
Tue May 31 18:00:04 MDT 2016 BusyBox v1.22.1
Tue May 31 18:00:06 MDT 2016 kernel: [ 0.164880] msm_bus_fabric_init_driver
Tue May 31 18:00:06 MDT 2016 kernel: [ 0.165044] msm_bus_device 580000.ad-hoc-bus: Dev 4096
Tue May 31 18:00:06 MDT 2016 kernel: [ 0.165102] msm_bus_device 580000.ad-hoc-bus:
get_bus_node_device_data:Failed to get bus clk for bus4096 ctx0
Tue May 31 18:00:06 MDT 2016 kernel: [ 0.165118] msm_bus_device 580000.ad-hoc-bus: Failed to get bus clk for
bus4096 ctx1
Tue May 31 18:00:06 MDT 2016 kernel: [ 0.165153] msm_bus_device 580000.ad-hoc-bus: Dev 1024
Tue May 31 18:00:06 MDT 2016 kernel: [ 0.165205] msm_bus_device 580000.ad-hoc-bus:
get_bus_node_device_data:Failed to get bus clk for bus1024 ctx0
Tue May 31 18:00:06 MDT 2016 kernel: [ 0.165221] msm_bus_device 580000.ad-hoc-bus: Failed to get bus clk for
bus1024 ctx1
Tue May 31 18:00:06 MDT 2016 kernel: [ 0.191342] pcie_init: pcie_init: unable to create IPC log context for pcie0-short
Tue May 31 18:00:06 MDT 2016 kernel: [ 0.191356] pcie_init: pcie_init: unable to create IPC log context for pcie0-long
Tue May 31 18:00:06 MDT 2016 kernel: [ 0.211847] msm_serial_hsl_probe: Bus scaling is disabled
Tue May 31 18:00:06 MDT 2016 kernel: [ 0.828676] sps: BAM device 0x07884000 is not registered yet.
Tue May 31 18:00:06 MDT 2016 kernel: [ 2.889272] mtdsplit: no squashfs found in 'rootfs'
Tue May 31 18:00:06 MDT 2016 kernel: [ 2.889272] mtdsplit: no squashfs found in 'rootfs'
Tue May 31 18:00:06 MDT 2016 kernel: [ 2.889272] mtdsplit: no squashfs found in 'rootfs'
```

The page shows the following information for each log entry:

- **Date and time.** The date and time that the entry was logged.
- **Action.** The action that occurred, such as whether a WLAN connection was made.
- **Source.** The name, IP address, or MAC address of a source device, application, or website, if applicable.

- **Target.** The name, IP address, or MAC address of a target device, application, or website, if applicable.
5. To save the logs, do the following:
    - a. Click the **Save** button.
    - b. Follow the directions of your browser to save the file to your computer.
  6. To download the detailed log entries, do the following:
    - a. Click the **Download Detailed Logs** button.  
Depending on the size of the file, downloading the detailed log entries might take several minutes.
    - b. Follow the directions of your browser to save the file to your computer.
  7. To refresh the log entries onscreen, click the **Refresh** button.  
  
**WARNING:** After you clear the log entries, you can no longer save or download them.
  8. To clear the log entries, click the **Clear** button.

## View a WiFi bridge connection

You can configure a wireless distribution system (WDS) that consists of point-to-point WiFi bridge connections between two access points (see [Set up a WiFi Bridge](#) on page 197). This is different from a NETGEAR Insight Instant Mesh WiFi network.

You can view whether a WiFi bridge is established and view the function (base station or repeater), MAC addresses, and IP addresses of the access points that form the WiFi bridge.

### To view a WiFi bridge connection:

1. Launch a web browser from a computer that is connected to the same network as the access point or directly to the access point through an Ethernet cable or WiFi connection.
  2. Enter the IP address that is assigned to the access point.  
A login window displays.  
  
If your browser does not display the login window but displays a security message and does not let you proceed, see [Log in to the access point after initial setup](#) on page 46.
  3. Enter the access point user name and password.
-

The user name is **admin**. The password is the one that you specified. The user name and password are case-sensitive.

If you previously added the access point to a NETGEAR Insight network location and managed the access point through the Insight app or Insight Cloud portal, enter the Insight network password for that location. For more information, see [Connect over WiFi using the NETGEAR Insight app](#) on page 31.

The Dashboard page displays.

4. Select **Management > Monitoring > Wireless Bridge**.

The page that displays lets you select a WDS profile (WDS 1, WDS 2, WDS 3, or WDS 4).

5. Click the ► button to the left of a WDS profile.

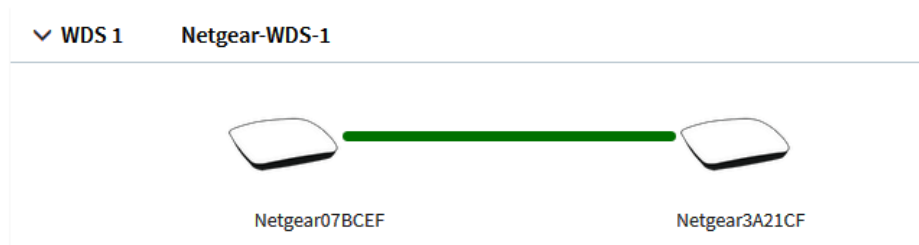

6. To view the function, MAC address, and IP address of an access point, point your cursor to the access point.

## View alarms and notifications

You can view the alarms and notifications from any access point page. The following procedure describes how you can view them from the Dashboard page.

### To view the alarms and notifications:

1. Launch a web browser from a computer that is connected to the same network as the access point or directly to the access point through an Ethernet cable or WiFi connection.
2. Enter the IP address that is assigned to the access point.  
A login window displays.

If your browser does not display the login window but displays a security message and does not let you proceed, see [Log in to the access point after initial setup](#) on page 46.

3. Enter the access point user name and password.

The user name is **admin**. The password is the one that you specified. The user name and password are case-sensitive.

If you previously added the access point to a NETGEAR Insight network location and managed the access point through the Insight app or Insight Cloud portal, enter the Insight network password for that location. For more information, see [Connect over WiFi using the NETGEAR Insight app](#) on page 31.

The Dashboard page displays.

4. Locate the alarm bell icon at the top-right of the page.  
The icon shows a number, indicating the total number of new alarms and notifications since the last time that you viewed alarms and notifications.
5. Click the alarm bell icon.

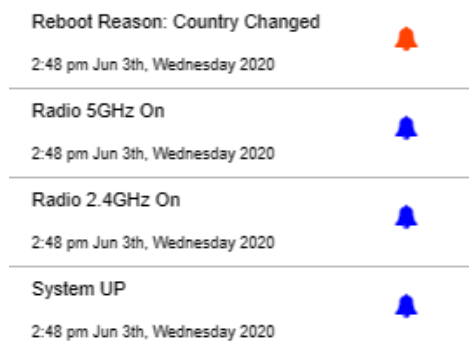

The pop-up window shows the alarms (indicated by a red bell) and notifications (indicated by a blue bell) with a description and time.

6. To view more alarms and notification, scroll down in the pop-up window.

# 13

## Set up a WiFi Bridge

---

This chapter describes how you can configure a wireless distribution system (WDS) that consists of point-to-point WiFi bridge connections between two access points. Each WiFi bridge connection requires a WDS profile for which the settings must match on the access points that make up the bridge.

A WDS is *not* the same as a NETGEAR Insight Instant Mesh WiFi network, which requires a root access point (see [Install the Access Point in an Insight Instant Mesh WiFi Network](#) on page 49).

The chapter includes the following sections:

- [WiFi base station, WiFi repeater, and WiFi bridge requirements](#)
- [Set up a WiFi bridge between access points](#)

# WiFi base station, WiFi repeater, and WiFi bridge requirements

If the access point is connected to the Internet over a wired connection, the access point can function as the WiFi base station for up to four other access points that function as WiFi repeaters. The access point itself can also function as a WiFi repeater if it is connected to another access point that functions as a WiFi base station.

A WiFi base station connects to the Internet, wired and WiFi clients can connect to the base station, and the base station sends its WiFi signal to one or more access points that function as WiFi repeaters. Wired and WiFi clients can also connect to a WiFi repeater, but the repeater connects to the Internet through the WiFi base station.

The following figure shows two access points in a WiFi repeating setup with a WiFi base station on the left side and a single WiFi repeater on the right side.

The following figure uses indoor models WAX610 as an example.

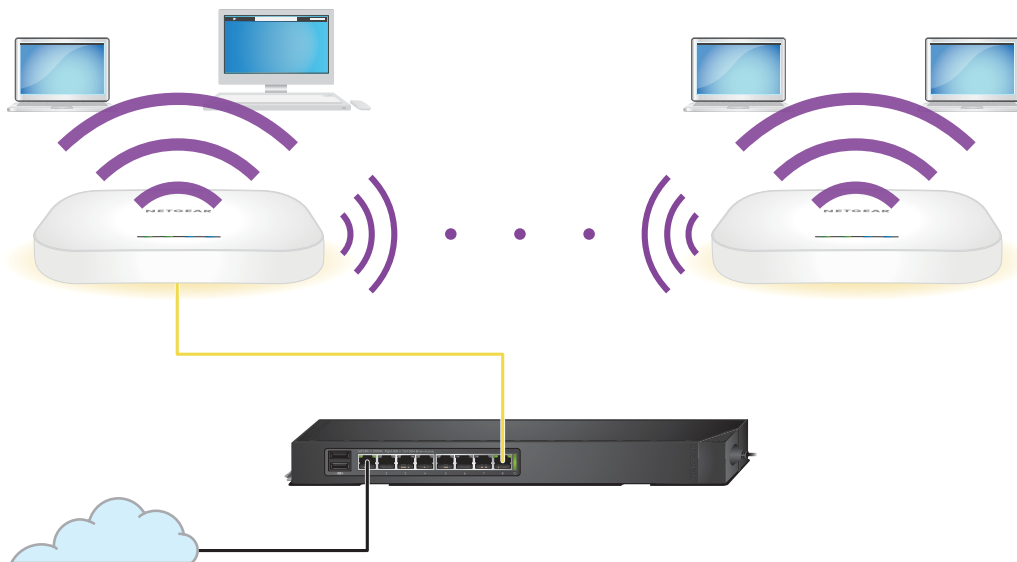

Figure 11. WiFi bridge configuration between two access points in the 5 GHz radio band

To use a WiFi bridge, you cannot use the auto channel feature for the access point and the SSID broadcast must be enabled.

For a WiFi bridge, you must set up one access point as a WiFi base station and another access point as a WiFi repeater:

- **WiFi base station.** The base station is connected over Ethernet to a network switch (usually with an Internet connection) and bridges traffic to and from the repeater.

The base station also handles local WiFi and wired traffic. To configure this mode, you must know the MAC address of the 2.4 GHz or 5 GHz radio on the repeater.

- **WiFi repeater.** The repeater sends all traffic from its local WiFi or wired devices to the WiFi base station. Similarly, the repeater receives all traffic for its local WiFi or wired computers from the base station. The repeater is connected to the network (and Internet) over the WiFi connection to the base station. To configure this mode, you must know the MAC address of the 2.4 GHz or 5 GHz radio on the base station.

By default, the access point functions in dual-band concurrent mode. If you enable the WiFi repeater in either radio band, the WiFi base station or WiFi repeater cannot be enabled in the other radio band. However, if you enable the WiFi base station in either radio band and use the other radio band for either client access or as a WiFi base station, dual-band concurrent mode is not affected.

Before you can set up a WiFi network with WDS, your configuration must meet the following conditions:

- Both access points must use the same WiFi channel and WiFi security settings.
- Both access points must be on the same LAN IP subnet. That is, all of the access point LAN IP addresses are in the same network.
- All LAN devices (wired and WiFi computers) are configured to operate in the same LAN network address range as the access points.

**Note:** If you are using the access point as the base station with a non-NETGEAR access point as a repeater, you might need to change more configuration settings. In particular, you might need to disable the DHCP server function on the non-NETGEAR access point that is the repeater.

**CAUTION:** Before you set up a WiFi bridge between two access points, enable STP on the access points (see [Enable or disable Spanning Tree Protocol](#) on page 143) and on the switches to which the access points are connected. If your switches do not support STP, after the WiFi bridge is established, disconnect one of the access points from its switch to prevent a network loop and connectivity problems. If you used a PoE+ switch for that access point, you now must use a power adapter.

## Set up a WiFi bridge between access points

The following procedure describes how you can configure the WiFi bridge settings on one access point and then do the same on another access point, allowing the WiFi bridge to be established.

## To set up a WiFi bridge between two access points:

1. Launch a web browser from a computer that is connected to the same network as the access point or directly to the access point through an Ethernet cable or WiFi connection.

2. Enter the IP address that is assigned to the access point.

A login window displays.

If your browser does not display the login window but displays a security message and does not let you proceed, see [Log in to the access point after initial setup](#) on page 46.

3. Enter the access point user name and password.

The user name is **admin**. The password is the one that you specified. The user name and password are case-sensitive.

If you previously added the access point to a NETGEAR Insight network location and managed the access point through the Insight app or Insight Cloud portal, enter the Insight network password for that location. For more information, see [Connect over WiFi using the NETGEAR Insight app](#) on page 31.

The Dashboard page displays.

4. Select **Management > Configuration > Wireless Bridge**.

The page that displays lets you select a WDS profile (WDS 1, WDS 2, WDS 3, or WDS 4).

5. Click the ► button to the left of a WDS profile.

The WDS profile page displays.

6. Select the Band **2.4 GHz** or **5 GHz** radio button.

Your selection determines the radio band on which the WDS is established. For countries that do not support dual-band operation, you cannot select the radio.

7. Select the VAP **Enable** radio button.

By default, a WDS profile is disabled.

The screenshot shows the configuration page for a WDS profile. It includes the following fields and options:

- Band:** Radio buttons for 2.4 GHz (selected) and 5 GHz.
- VAP:** Radio buttons for Enable (selected) and Disable.
- Wireless Network Name (SSID):** Text field containing "Netgear-WDS-1".
- Local MAC Address:** Text field containing "44-A5-6E-69-2E-49".
- Remote MAC Address:** Text field containing "00-00-00-00-00-00".
- Authentication:** A dropdown menu currently set to "Open".
- Buttons:** "Cancel" and "Apply" buttons at the bottom.



8. Configure the WDS profile settings as described in the following table.

Setting	Description
Wireless Network Name (SSID)	The WiFi network name on which the WDS is established. The default name is Netgear-WDS-x, in which x is the number of the WDS (1, 2, 3, or 4).
Local MAC Address	The MAC address of the local WDS radio interface, that is, the MAC address of the local radio on which the WDS is established. You cannot change this MAC address on this page. The MAC address is displayed for your information. Enter this MAC address on the remote access point of the WDS connection.
Remote MAC Address	The MAC address of the remote WDS radio interface, that is, the MAC address of the remote radio on which the WDS is established.
Network Authentication, Data Encryption, and Passphrase	By default, the selection from the menu is Open, in which case authentication and data encryption are not applicable. To secure the WDS connection, select <b>WPA2 Personal</b> and specify the following settings: <ul style="list-style-type: none"> <li>• <b>Encryption.</b> The data encryption is AES and you cannot change this setting.</li> <li>• <b>Passphrase.</b> The passphrase for the WDS connection. For you to enable the WDS connection, the passphrase on the remote access point must match the passphrase that you define in this field.</li> </ul>

9. Click the **Apply** button.  
Your settings are saved.

10. Configure the WiFi bridge settings on the access point at the other end of the WiFi bridge and restart that access point.

**Note:** If the device at the other end of the WiFi bridge is a NETGEAR access point, you might not need to restart it.

The WiFi bridge is established.

11. Verify connectivity across the LANs of both access points.

If the configuration is set up correctly, a computer on any WiFi or wired LAN segment of the access point that functions as the WiFi repeater can connect to the Internet or share files and printers with any other computer or server connected to the access point that functions as the WiFi base station.

# 14

## Manage the Advanced Radio Features

---

This chapter describes how you can manage the advanced radio features of the access point. For information about the basic radio features, see [Manage the Basic Radio Features](#) on page 86.

**CAUTION:** If you change a radio feature on the 2.4 GHz radio, the change affects all WiFi networks that broadcast on the 2.4 GHz radio. Similarly, if you change a radio feature on the 5 GHz radio, the change affects all WiFi networks that broadcast on the 5 GHz radio. If the change is not specific to one radio, the change affects *all* WiFi networks on the access point.

**Tip:** If you want to change the settings of the access point's WiFi network, use a wired connection to avoid being disconnected when the new WiFi settings take effect.

The chapter includes the following sections:

- [Manage the advanced WiFi settings for the radios](#)
- [Manage the maximum number of clients for a radio](#)
- [Manage the broadcast and multicast settings for a radio](#)
- [Manage sticky clients](#)
- [Manage load balancing for the radios](#)
- [Manage the ARP proxy](#)
- [Manage the amount of broadcast traffic](#)

# Manage the advanced WiFi settings for the radios

The advanced WiFi settings for the radios apply to all WiFi networks (VAPs or SSIDs). Although these settings work fine for most network environments and it is unlikely that you need to change them, you *can* change the radio settings, and you can do so for the 2.4 GHz and 5 GHz radios individually.

**CAUTION:** We recommend that you change these advanced WiFi settings only if you fully understand the consequences. Incorrect configuration might cause connectivity problems for devices trying to connect to the access point.

A radio must be turned on for you to change the settings. For more information about turning a radio on, see [Turn a radio on or off](#) on page 90.

## To manage the advanced WiFi settings for the radios:

1. Launch a web browser from a computer that is connected to the same network as the access point or directly to the access point through an Ethernet cable or WiFi connection.

2. Enter the IP address that is assigned to the access point.  
A login window displays.

If your browser does not display the login window but displays a security message and does not let you proceed, see [Log in to the access point after initial setup](#) on page 46.

3. Enter the access point user name and password.

The user name is **admin**. The password is the one that you specified. The user name and password are case-sensitive.

If you previously added the access point to a NETGEAR Insight network location and managed the access point through the Insight app or Insight Cloud portal, enter the Insight network password for that location. For more information, see [Connect over WiFi using the NETGEAR Insight app](#) on page 31.

The Dashboard page displays.

4. Select **Management > Configuration > Wireless > Advanced**.

The screenshot shows the 'Advanced' configuration page for the wireless network, divided into two sections: 2.4 GHz and 5 GHz. Each section contains several settings:

- 2.4 GHz Section:**
  - Max. Wireless Clients: 200
  - 802.11n 256 QAM:
  - MU-MIMO:  Enable,  Disable
  - RTS Threshold (256-2346): 2346,
  - DTIM Interval (1-255): 2
  - Beacon Interval (100-300): 100
  - Broadcast/Multicast Rate Limiting:
- 5 GHz Section:**
  - Max. Wireless Clients: 200
  - MU-MIMO:  Enable,  Disable
  - Broadcast/Multicast Rate Limiting:
  - RTS Threshold (256-2346): 2346,
  - 802.11h:  Enable,  Disable
  - DTIM Interval (1-255): 2
  - Beacon Interval (100-300): 100

At the bottom of the page, there are 'Cancel' and 'Apply' buttons.

5. Configure the settings as described in the following table.  
 The descriptions in the table apply to both radios. You can specify the radio settings for the 2.4 GHz and 5 GHz radios individually, but the check box for the 802.11n 256 QAM feature applies to the 2.4 GHz radio only (the feature is always enabled for the 5 GHz radio) and the 802.11h feature applies to the 5 GHz radio only.

## Insight Managed WiFi 6 AX1800 Dual Band Access Point Models WAX610 and WAX610Y

Setting	Description
Max. Wireless Clients	Enter the maximum number of WiFi clients that can simultaneously associate with the radio. The range is from 1 to 200. The default is 200 WiFi clients.
RTS Threshold (256-2346)	<p>Enter the Request to Send (RTS) threshold. The range is from 256 to 2346. The default is 2346.</p> <p>If the packet size is equal to or less than the RTS threshold, the radio uses the Carrier Sense Multiple Access with Collision Detection (CSMA/CD) mechanism and the data frame is transmitted immediately after the silence period. If the packet size is larger than the RTS threshold, the system uses the CSMA with Collision Avoidance (CSMA/CA) mechanism. In this situation, the transmitting device sends the RTS packet to the receiving device and waits for the receiving device to return a Clear to Send (CTS) packet before sending the actual packet data.</p>
Beacon Interval (100-300)	<p>Enter an interval between 100 ms and 300 ms for each beacon transmission, which allows the radio to synchronize the WiFi network. The default is 100 ms.</p> <p><b>Note:</b> If you set up more than four WiFi networks, the beacon interval is automatically changed to 300.</p>
802.11n 256 QAM	<p>When the WiFi mode is 802.11n, you can select the <b>802.11n 256 QAM</b> check box to enable the 2.4 GHz radio to function over 256-quadrature amplitude modulation (QAM), which can increase the 2.4 GHz radio throughput for 802.11n clients that are capable of supporting 256 QAM. By default, 256 QAM is disabled for the 2.4 GHz radio, that is, the check box is cleared.</p> <p>By default, 256-QAM is enabled for the 5 GHz radio and you cannot disable it (the page does not provide a check box for the 5 GHz radio).</p>
DTIM Interval (1-255)	Move the slider to specify the delivery traffic indication message (DTIM) interval or the data beacon rate, which indicates the beacon delivery traffic indication message period in multiples of beacon intervals. This value must be between 1 and 255. The default is 2.
Broadcast/Multicast Rate Limiting	Multicast and broadcast rate limiting is enabled by default to improve the overall network performance by limiting the number of packets that are transmitted across the network. By default, the setting is 50 (the maximum possible value), which specifies a maximum rate limit of 50 packets per second. To change the setting, move the slider. To disable multicast and broadcast rate limiting, clear the small check box.

(Continued)

Setting	Description
MU-MIMO	<p>By default, the MU-MIMO <b>Enable</b> radio button is selected and multiuser MIMO (MU-MIMO) is enabled. To disable MU-MIMO, select the MU-MIMO <b>Disable</b> radio button.</p> <p>MU-MIMO enables multiple users to receive data from the access point simultaneously using the same channel. With MU-MIMO, the access point can transmit to multiple clients simultaneously using the same channel. MU-MIMO is used in the downstream direction and requires both the access point and the WiFi clients to be capable of 802.11ac Wave 2 or 802.11ax.</p>
802.11h	<p>Select the 802.11h <b>Enable</b> radio button to enable 802.11h-capable WiFi clients to automatically switch to a new channel without disconnecting from the access point and without losing any data when the access point changes to another channel. By default, the 802.11h <b>Disable</b> radio button is selected and 802.11h is disabled.</p> <p>You can enable or disable 802.11h for the 5 GHz radio but not for the 2.4 GHz radio.</p>

6. Click the **Apply** button.

A warning pop-up window displays.

7. Click the **OK** button.

The pop-up window closes and your settings are saved. The radio or radios restart and WiFi clients might need to reconnect.

## Manage the maximum number of clients for a radio

The number of clients that are allowed to associate with a radio affects the reliability and throughput of the WiFi connection. A smaller number can increase the reliability and throughput and a large number can decrease the reliability and throughput.

By default, one radio allows up to 200 client associations. You can specify a lower number of clients. If the number of associated clients exceeds the maximum number that you specify, the radio rejects new client associations until the number drops below that maximum number.

### To manage the maximum number of clients for a radio:

1. Launch a web browser from a computer that is connected to the same network as the access point or directly to the access point through an Ethernet cable or WiFi connection.

2. Enter the IP address that is assigned to the access point.

A login window displays.

If your browser does not display the login window but displays a security message and does not let you proceed, see [Log in to the access point after initial setup](#) on page 46.

3. Enter the access point user name and password.

The user name is **admin**. The password is the one that you specified. The user name and password are case-sensitive.

If you previously added the access point to a NETGEAR Insight network location and managed the access point through the Insight app or Insight Cloud portal, enter the Insight network password for that location. For more information, see [Connect over WiFi using the NETGEAR Insight app](#) on page 31.

The Dashboard page displays.

4. Select **Management > Configuration > Wireless > Advanced**.

The Wireless Settings page displays.

5. In the **Max.Wireless Clients** field, enter the maximum number of WiFi clients that can simultaneously associate with the radio.

The range is from 1 to 200 for the radio. The default is 200 WiFi clients for the radio.

6. Click the **Apply** button.

A warning pop-up window displays.

7. Click the **OK** button.

The pop-up window closes and your settings are saved. The radio or radios restart and WiFi clients might need to reconnect.

## Manage the broadcast and multicast settings for a radio

Because multicast and broadcast traffic can adversely affect the throughput and latency of a WiFi network, you can change the multicast and broadcast rate limiting settings for a radio.

By default, multicast and broadcast rate limiting is enabled to improve the overall network performance by limiting the number of packets that are transmitted across the network. By default, the setting is 50 (the maximum possible value), which specifies a maximum rate limit of 50 packets per second. You can lower this number.

### To manage the broadcast and multicast settings for a radio:

1. Launch a web browser from a computer that is connected to the same network as the access point or directly to the access point through an Ethernet cable or WiFi connection.

2. Enter the IP address that is assigned to the access point.

A login window displays.

If your browser does not display the login window but displays a security message and does not let you proceed, see [Log in to the access point after initial setup](#) on page 46.

3. Enter the access point user name and password.

The user name is **admin**. The password is the one that you specified. The user name and password are case-sensitive.

If you previously added the access point to a NETGEAR Insight network location and managed the access point through the Insight app or Insight Cloud portal, enter the Insight network password for that location. For more information, see [Connect over WiFi using the NETGEAR Insight app](#) on page 31.

The Dashboard page displays.

4. Select **Management > Configuration > Wireless > Advanced > Wireless Settings**.

The Wireless Settings page displays.

5. To change the multicast and broadcast rate limiting settings for a radio, under Broadcast/Multicast Rate Limiting, take one of the following actions:

- To change the rate limiting setting, move the slider. By default, the setting is 50 (the maximum possible value), which specifies a maximum rate limit of 50 packets per second.
- To disable or enable multicast and broadcast rate limiting, clear or select the small check box.

6. Click the **Apply** button.

A warning pop-up window displays.

7. Click the **OK** button.

The pop-up window closes and your settings are saved. The radio or radios restart and WiFi clients might need to reconnect.



# Manage sticky clients

During roaming, sticky clients do not change to an access point with a better signal but remain associated with (that is, *stick to*) their initial access point, even though the quality of the connection to that access point is degraded. Such a situation causes delay for other clients that are associated with that access point.

**Note:** For a home WiFi network with a single access point, a sticky client is useful because no other access point is available to associate with during roaming. For a business or enterprise network with multiple access points, a sticky client can cause a drain on WiFi resources.

You can force sticky clients to disassociate from the radios of the access point.

If load balancing based on the RSSI of the client is enabled (see [Manage load balancing for the radios](#) on page 210), after a client is forced to disassociate, the client can join again in the following situations:

- The client can associate again if its RSSI is equal to or higher than the minimum required RSSI.
- If the client persistently tries to associate with the access point, the access point grants access to that client, even if its RSSI is below minimum required RSSI.

## To manage sticky clients:

1. Launch a web browser from a computer that is connected to the same network as the access point or directly to the access point through an Ethernet cable or WiFi connection.
2. Enter the IP address that is assigned to the access point.  
A login window displays.

If your browser does not display the login window but displays a security message and does not let you proceed, see [Log in to the access point after initial setup](#) on page 46.

3. Enter the access point user name and password.

The user name is **admin**. The password is the one that you specified. The user name and password are case-sensitive.

If you previously added the access point to a NETGEAR Insight network location and managed the access point through the Insight app or Insight Cloud portal, enter the Insight network password for that location. For more information, see [Connect over WiFi using the NETGEAR Insight app](#) on page 31.

The Dashboard page displays.

4. Select **Management > Configuration > Wireless > Advanced > Load Balancing**.  
The Load Balancing page displays.
5. Either select or clear the **Force Sticky Clients To Disassociate** check box.  
Selecting the check box forces sticky clients to disassociate from a radio. Clearing the check box allows sticky clients to remain associated with a radio.
6. Click the **Apply** button.  
Your settings are saved.

## Manage load balancing for the radios

You can configure the radio utilization thresholds to enable each radio to maintain the speed and performance of the WiFi network as clients associate with and disassociate from the WiFi network.

If you enable load balancing, client associations depend on the maximum number of clients per radio, the channel load per radio, and each client's Received Signal Strength Indicator (RSSI). New client associations are allowed if a radio's utilization remains within the defined load balancing settings. If a radio's utilization exceeds the defined load balancing settings, new client associations are temporary halted until the radio's utilization falls within the defined load balancing settings.

**Note:** The Dashboard page can show information about the client and traffic distribution per radio as well as the client, traffic, and channel utilization for each radio (see [View client distribution, connected clients, and client trends](#) on page 185 and [View WiFi and Ethernet traffic, traffic and ARP statistics, and channel utilization](#) on page 188).

By default, all of the following types of load balancing are enabled with their default settings:

- **Load balancing based on the maximum number of clients.** The access point allows client associations up to the specified maximum number of clients. After the maximum number is exceeded, new clients are rejected. Even though this is a global setting, it is implemented per radio.
- **Load balancing based on the channel load.** The access point allows client associations up to the defined maximum channel utilization. After the maximum channel utilization is exceeded, new clients are rejected. Even though this is a global setting, it is implemented per radio.

**Note:** If a client is rejected but persistently tries to associate with the access point, the access point grants access to that client.

- **Load balancing based on the RSSI of the client.** Clients with an RSSI that is equal to or higher than the defined minimum are allowed to associate with the access point. Clients with an RSSI below the defined minimum are rejected. Even though this is a global setting, it is implemented per radio.

**Note:** If a client is rejected but persistently tries to associate with the access point, the access point grants access to that client.

You can change the default settings for each type of load balancing, or completely disable one or more types of load balancing.

### To manage load balancing for the radios:

1. Launch a web browser from a computer that is connected to the same network as the access point or directly to the access point through an Ethernet cable or WiFi connection.

2. Enter the IP address that is assigned to the access point.  
A login window displays.

If your browser does not display the login window but displays a security message and does not let you proceed, see [Log in to the access point after initial setup](#) on page 46.

3. Enter the access point user name and password.

The user name is **admin**. The password is the one that you specified. The user name and password are case-sensitive.

If you previously added the access point to a NETGEAR Insight network location and managed the access point through the Insight app or Insight Cloud portal, enter the Insight network password for that location. For more information, see [Connect over WiFi using the NETGEAR Insight app](#) on page 31.

The Dashboard page displays.

4. Select **Management > Configuration > Wireless > Advanced > Load Balancing**.

The screenshot shows the 'Load Balancing Mode' configuration interface. At the top, there are radio buttons for 'Enable' (selected) and 'Disable'. Below this, three load balancing methods are listed, each with a checked checkbox and a corresponding slider for both 2.4 GHz and 5 GHz bands:

- Based On Maximum Number Of Clients:** Maximum Number Of Clients Allowed. Sliders range from 5 to 200. The 2.4 GHz slider is at 200, and the 5 GHz slider is at 200.
- Based On Channel Load:** Maximum Channel Load Allowed (%). Sliders range from 50 to 90. The 2.4 GHz slider is at 70, and the 5 GHz slider is at 70.
- Based On Client Receive Signal Strength:** Minimum Client RSSI Required. Sliders range from 1 to 50. The 2.4 GHz slider is at 23, and the 5 GHz slider is at 23.

At the bottom, there is an unchecked checkbox for 'Force Sticky Client To Disassociate' and two buttons: 'Cancel' and 'Apply'.

5. To globally enable load balancing for the radios, select the Load Balancing Mode **Enable** radio button.

The page adjusts and displays a slider for each type of load balancing and each radio.

By default, load balancing is disabled. When you enable load balancing, all three types of load balancing are enabled. You can individually disable one or more types of load balancing.

6. To individually enable or disable one or more types of load balancing, do the following:
  - To disable a particular type of load balancing, clear the small blue check box to the left of the *Based On* text.
  - To enable a particular type of load balancing, select the small blue check box to the left of the *Based On* text.
7. To change the load balancing settings, do the following:
  - **Based On Maximum Number Of Clients.** For each radio, move the associated slider to specify the maximum number of clients allowed, before the radio stops accepting new client associations. For each radio, the minimum number of clients is 5 and the maximum number is 200, and the default number is 200.
  - **Based On Channel Load.** For each radio, move the associated slider to specify the maximum percentage of channel load that is allowed on the radio, before it stops accepting new client associations. For each radio, the minimum percentage of channel load is 50, the maximum percentage is 90, and the default percentage is 70.
  - **Based on Channel Receive Signal Strength.** For each radio, move the associated slider to specify the minimum required RSSI value for an individual client, below

which the radio does not accept the client association. For each radio, the minimum RSSI value is 1, the maximum value is 50, and the default value is 23.

8. Click the **Apply** button.  
Your settings are saved.

## Manage the ARP proxy

By default, the ARP proxy is enabled on the access point, allowing it to inspect all ARP broadcast packets for its clients. In this way, the access point responds to ARP requests for its clients, preventing unnecessary broadcast traffic on the radios.

For information about the ARP statistics, including the number of proxied and dropped packets, see [View WiFi and Ethernet traffic, traffic and ARP statistics, and channel utilization](#) on page 188.

### To manage the ARP proxy:

1. Launch a web browser from a computer that is connected to the same network as the access point or directly to the access point through an Ethernet cable or WiFi connection.

2. Enter the IP address that is assigned to the access point.  
A login window displays.

If your browser does not display the login window but displays a security message and does not let you proceed, see [Log in to the access point after initial setup](#) on page 46.

3. Enter the access point user name and password.

The user name is **admin**. The password is the one that you specified. The user name and password are case-sensitive.

If you previously added the access point to a NETGEAR Insight network location and managed the access point through the Insight app or Insight Cloud portal, enter the Insight network password for that location. For more information, see [Connect over WiFi using the NETGEAR Insight app](#) on page 31.

The Dashboard page displays.

4. Select **Management > Configuration > Wireless > Advanced > ARP Proxy**.

The ARP Proxy page displays.

5. Select one of the following radio buttons

- **Enable**. The ARP proxy is enabled. This is the default setting.

- **Disable.** The ARP proxy is disabled. Broadcast traffic on the radios might increase.
6. Click the **Apply** button.  
Your settings are saved.

## Manage the amount of broadcast traffic

The access point supports broadcast enhancements that reduce the broadcast traffic on the radios, and therefore on all WiFi networks that you configure on the access point.

We recommend that you enable the broadcast enhancements only if you expect the access point to host less than 20 clients on the 5 GHz radio and less than 10 clients on the 2.4 GHz radio. By default, the broadcast enhancements are disabled.

Note the following limitations for the broadcast enhancements:

- If more than 20 clients are connected to a WiFi network, the broadcast enhancements do not work for that WiFi network.
- Broadcast enhancements do not work if the access point functions in a wireless distribution system (WDS) or in an Insight Instant Mesh WiFi network.

### To manage broadcast enhancements:

1. Launch a web browser from a computer that is connected to the same network as the access point or directly to the access point through an Ethernet cable or WiFi connection.

2. Enter the IP address that is assigned to the access point.  
A login window displays.

If your browser does not display the login window but displays a security message and does not let you proceed, see [Log in to the access point after initial setup](#) on page 46.

3. Enter the access point user name and password.

The user name is **admin**. The password is the one that you specified. The user name and password are case-sensitive.

If you previously added the access point to a NETGEAR Insight network location and managed the access point through the Insight app or Insight Cloud portal, enter the Insight network password for that location. For more information, see [Connect over WiFi using the NETGEAR Insight app](#) on page 31.

The Dashboard page displays.

4. Select **Management > Configuration > Wireless > Advanced > Broadcast Enhancements**.

The Broadcast Enhancements page displays.

5. Select one of the following radio buttons
  - **Enable**. The broadcast enhancements are enabled.
  - **Disable**. The broadcast enhancements are disabled. This is the default setting.
6. Click the **Apply** button.  
Your settings are saved.

# 15

## Diagnostics and Troubleshooting

---

This chapter describes how you can capture WiFi packets and troubleshoot the access point and network.

The chapter includes the following sections:

- [Perform a ping test](#)
- [Check the Internet speed](#)
- [Quick tips for WiFi troubleshooting](#)
- [Troubleshoot with the LEDs](#)
- [The extender access point and root access point cannot connect](#)
- [Troubleshoot WiFi connectivity](#)
- [Troubleshoot Internet browsing](#)
- [You cannot log in to the access point over a LAN connection](#)
- [Changes are not saved](#)
- [You enter the wrong password and can no longer log in to the access point](#)
- [Troubleshoot your network using the ping utility](#)



# Perform a ping test

You can ping the IP address of a device or network location from the access point and view the results of the ping test.

## To perform a ping test:

1. Launch a web browser from a computer that is connected to the same network as the access point or directly to the access point through an Ethernet cable or WiFi connection.

2. Enter the IP address that is assigned to the access point.  
A login window displays.

If your browser does not display the login window but displays a security message and does not let you proceed, see [Log in to the access point after initial setup](#) on page 46.

3. Enter the access point user name and password.

The user name is **admin**. The password is the one that you specified. The user name and password are case-sensitive.

If you previously added the access point to a NETGEAR Insight network location and managed the access point through the Insight app or Insight Cloud portal, enter the Insight network password for that location. For more information, see [Connect over WiFi using the NETGEAR Insight app](#) on page 31.

The Dashboard page displays.

4. Select **Management > Diagnostics > Ping Test**.

Ping Count	<input type="text" value="16"/>	Packet Size(in Bytes)	<input type="text" value="64"/>
Ping Interval(in sec)	<input type="text" value="1"/>	Ping Timeout(in sec)	<input type="text" value="60"/>
Remote Host ⓘ	<input type="text" value="8.8.8.8"/>		

**Ping Result**

5. Specify the settings that are described in the following table.

Setting	Description
Ping Count	The number of pings that the access point must send. The default number is 16.
Packet Size (in Bytes)	The size of each ping packet. The default size is 64 bytes.
Ping Interval (in sec)	The interval between pings. The default interval is 1 second.
Ping Timeout (in sec)	The period after which a ping times out. The default period is 60 seconds.
Remote Host	The IP address that the access point must ping.

6. To start the ping test, click the **Start** button.  
The results of the ping test display in the Ping Result field.
7. To stop the ping test before the ping count is reached or if the ping times out, click the **Stop** button.

## Check the Internet speed

You can check the Internet speed of the access point. The results might be helpful if you want to set bandwidth rate limits (see [Set bandwidth rate limits for a WiFi network](#) on page 84).

### To check the Internet speed:

1. Launch a web browser from a computer that is connected to the same network as the access point or directly to the access point through an Ethernet cable or WiFi connection.
2. Enter the IP address that is assigned to the access point.  
A login window displays.  
If your browser does not display the login window but displays a security message and does not let you proceed, see [Log in to the access point after initial setup](#) on page 46.
3. Enter the access point user name and password.  
The user name is **admin**. The password is the one that you specified. The user name and password are case-sensitive.  
If you previously added the access point to a NETGEAR Insight network location and managed the access point through the Insight app or Insight Cloud portal, enter the Insight network password for that location. For more information, see [Connect over WiFi using the NETGEAR Insight app](#) on page 31.  
The Dashboard page displays.

4. Select **Management > Diagnostics > Speed Check**.

The Internet Speed Check page displays.

5. To view the privacy policy, click the **Privacy Policy** link.

The Privacy Policy pop-up window displays.

6. To close the pop-up window, click the **X** in the upper right corner.

7. Click the **Test Speed** button.

After a short delay, the page displays the measured latency in ms, download speed in Mbps, and upload speed in Mbps.

8. To view the test history, click the **View History** link.

A table shows the results of previous tests.

## Quick tips for WiFi troubleshooting

If one or more WiFi networks do not function normally, consider to repower your access point:

1. Unplug the Ethernet cable from the access point to your network switch.
2. If you use a power adapter, disconnect it from the access point.
3. Plug in the Ethernet cable from the access point to your network switch. Wait two minutes.
4. If you use a power adapter, connect it to the access point. Wait two minutes.

If you cannot connect over WiFi to the access point, try the following:

- Make sure that the WiFi LED on the access point is not off.  
If the WiFi LED is off and you did not disable the LEDs (see [Manage the LEDs](#) on page 174), one or both WiFi radios are probably off too. For more information about the WiFi radios, see [Turn a radio on or off](#) on page 90.
- Make sure that the WiFi settings in your WiFi device and access point match exactly.  
For a device that is connected over WiFi, the WiFi network name (SSID) and WiFi security settings of the access point and WiFi device must match exactly.  
For information about accessing the access point for initial configuration over a WiFi connection, see [Connect to the access point for initial configuration](#) on page 30.
- Make sure that your WiFi device supports the authentication and encryption that you are using for your WiFi network. For more information, see [Change the authentication and encryption for a WiFi network](#) on page 70.

**Note:** If the access point's WiFi authentication and encryption is set to WPA3 Personal, make sure that the WiFi adapter device driver is updated to the latest version on your WiFi device.

- Make sure that your WiFi device is not too far from the access point or too close. To see if the signal strength improves, move your WiFi device near the access point but at least 6 feet (1.8 meters) away.
- Make sure that the WiFi signal is not blocked by objects between the access point and your WiFi device.
- Make sure that the access point's SSID broadcast is not disabled. If the access point's SSID broadcast is disabled, the WiFi network name is hidden and does not display in your WiFi device's scanning list. To connect to a hidden network, you must enter the network name and the WiFi password. For more information about the SSID broadcast, see [Hide or broadcast the SSID for a WiFi network](#) on page 74.
- Make sure that your WiFi device does not use a static IP address but is configured to receive an IP address automatically with DHCP. (For most devices, DHCP is the default setting.)

## Troubleshoot with the LEDs

For general information about the LEDs and LED icons, see [Top panel with LEDs, indoor model WAX610](#) on page 11.

When you connect the access point to a power source and you did not disable the LEDs (see [Manage the LEDs](#) on page 174), the LEDs light as described here:

1. The Power/Cloud LED lights solid amber initially and then blinks amber slowly. After about two minutes, the Power/Cloud LED turns either solid green or solid blue, indicating that the startup procedure is complete and the access point is ready:
  - **Solid green.** The access point functions either as a standalone access point, or as an Insight discovered access point that is *not* connected to the Insight cloud-based management platform.
  - **Solid blue.** The access point functions in Insight mode and is connected to the Insight cloud-based management platform.
2. When the startup procedure is complete, verify the following:
  - The LAN LED lights solid green or solid amber, depending on the speed of the Ethernet link.  
If the access point processes Ethernet traffic, the LAN LED blinks green or blue.

- The 2.4G WLAN LED and 5G WLAN LED light solid green.  
If clients are connected to a radio, the associated WLAN LED lights solid blue. If a radio processes traffic, the associated WLAN LED blinks blue.

You can use the LEDs for troubleshooting. For more information, see the following sections:

- [Power/Cloud LED remains off](#)
- [Power/Cloud LED remains solid amber](#)
- [Power/Cloud LED is blinking amber slowly, continuously](#)
- [The access point functions as a PoE PD and the Power/Cloud LED remains solid amber](#)
- [Power/Cloud LED does not light blue in the NETGEAR Insight management mode](#)
- [Power/Cloud LED does not stop blinking amber, green, and blue](#)
- [2.4G or 5G WLAN LED is off](#)

### Power/Cloud LED remains off

If you use a PoE+ connection and the Power/Cloud LED and other LEDs are off when the Ethernet cable is connected to a PoE+ switch, do the following:

- Make sure that the LEDs are not disabled (see [Manage the LEDs](#) on page 174).
- Make sure that the Ethernet cable between the access point and the PoE+ switch is correctly connected at both ends.
- Make sure that the other end of the Ethernet cable is plugged into a PoE+ port on a PoE+ switch that is receiving power.
- Make sure that the PoE power budget of the PoE+ switch is not oversubscribed so that the PoE+ switch is capable of delivering PoE+ power to the access point.

If you use an optional power adapter and the Power/Cloud LED and other LEDs remain off when the access point is turned on, do the following:

- Make sure that the LEDs are not disabled (see [Manage the LEDs](#) on page 174).
- Make sure that the power adapter is correctly connected to the access point, and that the power adapter is correctly connected to a functioning power outlet. If it is plugged into a power strip, make sure that the power strip is turned on. If it is plugged directly into the wall, verify that the outlet is not switched off.
- Make sure that you are using the NETGEAR power adapter for this product. That is, do not use the NETGEAR power adapter for another NETGEAR product or a third-party power adapter.

If the error persists, a hardware problem might exist. For recovery instructions or help with a hardware problem, contact technical support at [netgear.com/support](https://netgear.com/support).

## Power/Cloud LED remains solid amber

When you connect the access point to a power source, the Power/Cloud LED lights solid amber initially, then blinks amber slowly, and finally turns solid green or solid blue, indicating that the startup procedure is complete and the access point is ready.

If the Power/Cloud LED remains solid amber after five minutes, either a boot error occurred or the access point is malfunctioning.

Do the following:

1. Disconnect the access point from its power source, reconnect it, and wait several minutes to see if the startup procedure completes successfully.
2. If the startup procedure still does not complete successfully and the Power/Cloud LED remains solid amber after five minutes, use the **Reset** button to return the access point to its factory default settings.

For more information, see [Use the Reset button to reset indoor model WAX610](#) on page 170.

If the error persists, a hardware problem might exist. For recovery instructions or help with a hardware problem, contact technical support at [netgear.com/support](https://netgear.com/support).

## Power/Cloud LED is blinking amber slowly, continuously

When you connect the access point to a power source, the Power/Cloud LED lights solid amber temporarily and then turns solid green or solid blue, indicating that the startup procedure is complete and the access point is ready. During regular operation, the only time that the Power/Cloud LED blinks amber temporarily is when firmware is being upgraded. Also, in that situation, the Power/Cloud LED blinks amber quickly, not slowly.

If the Power/Cloud LED blinks amber slowly and continuously, the access point did not receive an IP address from a DHCP server.

Check to make sure that the DHCP client of the access point is enabled (see [Enable the DHCP client](#) on page 138), that your network includes a DHCP server (or a router that functions as a DHCP server), and that the DHCP server can reach the access point (both must be on the same network).

In the unlikely situation that your network does not include a DHCP server, you might need to configure a fixed (static) IP address on the access point (see [Disable the DHCP client and specify a fixed IP address](#) on page 137).

## The access point functions as a PoE PD and the Power/Cloud LED remains solid amber

When you connect the access point to a power source, the Power/Cloud LED lights solid amber initially, then blinks amber slowly, and finally turns solid green or solid blue, indicating that the startup procedure is complete and the access point is ready.

If the access point functions as a PoE PD and the Power/Cloud LED remains solid amber after five minutes, the access point might not be receiving power at the required 802.3at (PoE+) level. For example, this situation might occur if the access point is connected to a switch that provides only 802.3af (PoE) rather than 802.3at (PoE+).

Do the following:

1. Disconnect and reconnect the Ethernet cable at the LAN/PoE+ port on the access point and at an 802.3at (PoE+) port on the PoE+ switch.  
The access point restarts.
2. If the Power/Cloud LED remains solid amber after five minutes, check to see why the PoE+ switch cannot provide sufficient PoE power to the access point.  
Most likely, the PoE power budget of the PoE+ switch is oversubscribed and you might need to disconnect another PoE device from the PoE+ switch to make sufficient PoE power available for the access point.

If the error persists, see [Power/Cloud LED remains solid amber](#) on page 222.

## Power/Cloud LED does not light blue in the NETGEAR Insight management mode

If the access point functions in the Web-browser management mode, the Power/Cloud LED lights green. This is normal LED behavior.

However, if the access point functions in the NETGEAR Insight management mode and the Power/Cloud LED does not light blue but remains green, the access point is not connected to the Insight cloud-based management platform.

If the access point functions in the NETGEAR Insight management mode and the Power/Cloud LED does not light blue, do the following:

1. Verify that the management mode of the access point is NETGEAR Insight.  
For more information, see [Change the management mode to NETGEAR Insight or Web-browser](#) on page 150.
2. Make sure that the Ethernet cable connection between the access point and your network is good.

3. Make sure that the access point is connected to the Internet and that the Internet connection is good.
4. Make sure that the access point is running the latest firmware version.  
For more information, see [Manage the firmware of the access point](#) on page 158.
5. Disconnect and reconnect the Ethernet cable at the LAN/PoE+ port and wait five minutes to see if the Power/Cloud LED lights solid blue.  
If you use a power adapter with the access point, disconnect and reconnect the power adapter and wait five minutes to see if the Power/Cloud LED lights solid blue.
6. Use the **Reset** button to return the access point to its factory default settings.  
For more information, see [Use the Reset button to reset indoor model WAX610](#) on page 170.

If the error persists, a hardware problem might exist. For recovery instructions or help with a hardware problem, contact technical support at [netgear.com/support](http://netgear.com/support).

## Power/Cloud LED does not stop blinking amber, green, and blue

During the initial installation and configuration process in an Insight Instant Mesh WiFi network, the Power/Cloud LED blinks amber, green, and blue while the access point is being configured as an *extender* access point. For more information, see [Connect the access point as an extender to a root access point](#) on page 54.

If the Power/Cloud LED does not stop blinking amber, green, and blue, the extender access point cannot connect.

Check the following items or try the following troubleshooting steps:

- Make sure that at least one root access point is available for the extender access point to connect to.
- Make sure that all root access points run the latest firmware version.
- Make sure that the output power of each radio on each root access point is at its maximum level. By default, the output power for a radio is at its maximum level. For more information, see [Change the output power for a radio](#) on page 96.
- Make sure that the extender access point is not too far away from a root access point. For more information, see [The extender access point and root access point cannot connect](#) on page 225.
- Restart the extender access point.



- Remove the extender access point from your Insight network location and from your Insight account. Then, add the extender access point to your Insight account again and to your Insight network location.

## 2.4G or 5G WLAN LED is off

If the 2.4G WLAN LED or 5G WLAN LED is off, do the following:

- Check to see if a radio is disabled (see [Turn a radio on or off](#) on page 90). By default, both radios are enabled and the WLAN LEDs light as follows:
  - **Solid green.** The radio is operating without any clients.
  - **Solid blue.** The radio is operating with clients.
  - **Blinking blue.** The radio is operating with clients and is processing traffic.
- If you are using a PoE+ connection, make sure that the PoE+ switch is providing sufficient power to the access point. The access point requires power at the required 802.3at (PoE+) level. Insufficient PoE power can affect the radios.

If the error persists, a hardware problem might exist. For recovery instructions or help with a hardware problem, contact technical support at [netgear.com/support](http://netgear.com/support).

## The extender access point and root access point cannot connect

When you add the access point as an extender to an Insight network location that includes one or more root access points (see [Connect the access point as an extender to a root access point](#) on page 54), we recommend that you place the extender access point in the same room as a root access point during the initial sync. After a successful sync, move the extender access point to the location where you intend to use it.

For a reliable WiFi connection, place the extender access point less than 25 feet (7.5 m), in a line of sight with minimal obstacles from the closest root access point.

### **To sync the extender access point and the root access point after you already added the extender access point to an Insight network location:**

1. Place the extender access point in the same room as the root access point.  
Use this extender access point location only during the sync process.
2. Connect the extender access point to a power source.  
If you do not use a PoE connection to a PoE switch, connect a power adapter to the DC power connector.

The Power/Cloud LED on the extender access point lights solid amber.

3. Wait for the extender access point to go through the initial connection and configuration process and for the Power/Cloud LED to stop blinking amber, green, and blue and to light solid blue.

**Note:** The initial connection and configuration process might take up to 10 minutes. The extender access point might restart during the configuration process.

The Power/Cloud LED lights as follows during the initial connection and configuration process:

- **Blinking green.** The extender access point is attempting to detect a root access point.
- **Solid green.** The extender access point is making its first connection with the root access point that provides the strongest WiFi signal.
- **Blinking amber slowly.** The extender access point is contacting the network router or DHCP server to receive an IP address.  
If the Power/Cloud LED does not stop blinking amber, see [Power/Cloud LED is blinking amber slowly, continuously](#) on page 222
- **Blinking amber, green, and blue.** The extender access point is being configured as a managed device in the Insight Instant Mesh WiFi network.  
If the Power/Cloud LED does not stop blinking amber, green, and blue, see [Power/Cloud LED does not stop blinking amber, green, and blue](#) on page 224.

When the configuration is complete, the Power/Cloud LED lights as follows:

- **Solid blue.** The configuration is complete and the extender access point is ready for operation. The extender access point functions in the Insight Instant Mesh WiFi network and is connected to the Insight cloud.
4. Disconnect the extender access point and move it to the location where you intend to use it.
  5. At the new location, repeat [Step 2](#) and [Step 3](#).
  6. Wait for the extender access point to resync with the root access point.  
When the extender access point's Power/Cloud LED lights solid blue, the extender access point and root access point synced successfully.

If the extender access point and root access point did not sync, move the extender access point closer to the root access point and try again. The extender access point must be within the root access point's WiFi coverage area to establish a good or fair WiFi connection.

# Troubleshoot WiFi connectivity

If a WiFi device cannot connect to the access point or the WiFi connectivity is not normal, try to isolate the problem:

- Make sure that the WiFi settings in the WiFi device and access point match exactly. For a device that is connected over WiFi, the WiFi network name (SSID) and WiFi security settings of the access point and WiFi device must match exactly. Make sure that the WiFi device uses the correct passphrase for the WiFi network. For information about accessing the access point for initial configuration over a WiFi connection, see [Connect to the access point for initial configuration](#) on page 30.
- Does the WiFi device support the authentication and encryption that you configured for the WiFi network? For more information, see [Change the authentication and encryption for a WiFi network](#) on page 70.

**Note:** If the access point's WiFi authentication and encryption is set to WPA3 Personal, make sure that the WiFi adapter device driver is updated to the latest version on the WiFi device.

- Does the WiFi device find the WiFi network? If not, check the WLAN LEDs. If a WLAN LED is off, the associated WiFi radio is probably off, too. For more information about the WiFi radios, see [Turn a radio on or off](#) on page 90.
- If you disabled the access point's SSID broadcast for the WiFi network, the WiFi network is hidden and does not display in the WiFi device's network scanning list. (By default, SSID broadcast is enabled.) For more information about the SSID broadcast, see [Hide or broadcast the SSID for a WiFi network](#) on page 74.

**Tip:** If you want to change the settings of a WiFi network on the access point, use a wired LAN connection to avoid being disconnected when the new WiFi settings take effect.

If the WiFi device finds the WiFi network but the signal strength is weak, check these conditions:

- Is the WiFi device too far from the access point, or too close? Place the WiFi device near the access point, but at least 6 feet (1.8 meters) away, and see whether the signal strength improves.
- Are objects between the WiFi device and the access point blocking the WiFi signal?

# Troubleshoot Internet browsing

If a WiFi device is connected to the access point but unable to load any web pages from the Internet, it might be for one of the following reasons:

- The WiFi device might not recognize any DNS server addresses.  
If you manually entered a DNS address when you set up the access point (that is, the access point uses static IP address settings), restart the WiFi device and verify the DNS address.
- The WiFi device might not use the correct TCP/IP settings.  
If the WiFi device obtains its information by DHCP, reboot the WiFi device and verify the address of the switch or Internet modem to which the access point is connected. For information about TCP/IP problems, see [Troubleshoot your network using the ping utility](#) on page 230.

# You cannot log in to the access point over a LAN connection

If you are unable to log in to the access point from a computer on your LAN and use the access point's local browser UI, check the following:

- Make sure that the IP address of your computer is in the same subnet as the access point.  
If you disabled the access point's DHCP client and configured a fixed (static) IP address when you connected the access point to your network (see [Disable the DHCP client and specify a fixed IP address](#) on page 137), change the IP address and subnet mask on your computer to so that the IP addresses of your computer and the access point are in the same IP subnet.
- If your access point's IP address was changed (for example, the DHCP server in your network issued an IP address to the access point) and you do not know the current IP address, use an IP scanner application to detect the IP address.

**Note:** You can also use the NETGEAR Insight app to discover the IP address that is assigned to the access point. For more information, see [Connect over WiFi using the NETGEAR Insight app](#) on page 31.

If you still cannot find the IP address, reset the access point's configuration to factory defaults. This sets the access point's IP address to 192.168.0.100 and enables the DHCP client. For more information, see [Use the Reset button to reset indoor model WAX610](#) on page 170.

- Make sure that Java, JavaScript, or ActiveX is enabled in your browser. If you are using Internet Explorer, click the **Refresh** button to be sure that the Java applet is loaded.
- Try quitting the browser and launching it again.
- Make sure that you are using the correct login information. The user name is **admin** and the password is the one that you specified. The user name and password are case-sensitive.

If you previously added the access point to a NETGEAR Insight network location and managed the access point through the Insight app or Insight Cloud portal, enter the Insight network password for that location. For more information, see [Connect over WiFi using the NETGEAR Insight app](#) on page 31.

## Changes are not saved

If you are logged in to the access point's local browser UI and the access point does not save the changes that you make on a page, do the following:

- When entering configuration settings, always click the **Apply** button before moving to another page or tab or your changes are lost.
- Click the **Refresh** or **Reload** button in the web browser. It is possible that the changes occurred but that the old settings remain in the web browser's cache.

## You enter the wrong password and can no longer log in to the access point

If you enter the wrong admin password three or more times, access to the access point's local browser UI is blocked for a period. For example, if you enter the wrong password three times, access to the access point might be blocked for five minutes.

The blockage period depends on the number of failed login attempts. During the blockage period, any attempts to log in to the access point are ignored, even if you enter the correct password. You must wait until the blockage is lifted, and then you get *a single opportunity* to enter the correct password. If you enter the wrong password again, the blockage period is extended as described in the following table.

Table 3. Login blockage periods

Number of failed attempts	Blockage period in minutes
3	5
4	10
5	20
6	40
And so on	And so on

In addition, the following rules apply to the number of failed login attempts:

- If the number of failed login attempts is smaller than the number of allowed retry attempts, the counter for failed login attempts is reset after 30 minutes. For example, if you enter the wrong password twice but enter the correct password at the third login attempt, the two failed login attempts are erased from memory after 30 minutes.
- If the number of failed login attempts is larger than the number of allowed retry attempts, the counter for failed login attempts is reset after 24 hours. For example, if you enter the wrong password five times but enter the correct password at the sixth login attempt, the five failed login attempts are erased from memory after 24 hours.
- The last access attempt determines whether the counter for failed login attempts is increased.
- If you restart the access point, the counter for failed login attempts is reset.

## Troubleshoot your network using the ping utility

Most network devices and routers contain a ping utility that sends an echo request packet to the designated device. The device then responds with an echo reply. You can easily troubleshoot a network using the ping utility in your computer or workstation.

## Test the LAN path to your access point

You can ping the access point from your computer to verify that the LAN path to your access point is set up correctly.

### To ping the access point from a Windows-based computer:

1. From the Windows taskbar, click the **Start** button and find and select **Run**.
2. In the field provided, enter **ping** followed by the IP address of the access point, as in this example:

**ping 192.168.0.100**

3. Click the **OK** button.

A message such as the following one displays:

```
Pinging <IP address> with 32 bytes of data
```

If the path is working, you see this message:

```
Reply from < IP address >: bytes=32 time=NN ms TTL=xxx
```

If the path is not working, you see this message:

```
Request timed out
```

If the path is not functioning correctly, one of the following problems might be occurring:

- Wrong physical connections  
Check that the appropriate LEDs are on for your network devices. If your access point and computer are connected to a separate Ethernet switch, make sure that the link LEDs are lit for the switch ports that are connected to your computer and access point.
- Wrong network configuration  
Verify that the IP addresses for your computer and the access point are correct and that the addresses are in the same subnet.

## Test the path from your computer to a remote device

After you verify that the LAN path works correctly, test the path from your computer to a remote device.

### To test the path from your computer to a remote device:

1. From the Windows taskbar, click the **Start** button and find and select **Run**.
2. In the field provided, enter **ping -n 10 IP address**.  
*IP address* is the IP address of a remote device such as a remote DNS server.

If the path is functioning correctly, replies as described in [Test the LAN path to your access point](#) on page 231 display. If you do not receive replies, do the following:

- Check to see that your computer lists the IP address of the router to which the access point is connected as the default router. If the IP configuration of your computer is assigned by DHCP, this information is not visible in your computer's Network Control Panel.
- Check to see that the network address of your computer (the portion of the IP address specified by the netmask) is different from the network address of the remote device.



# A

## Mount Indoor Model WAX610 to a Wall or Ceiling

---

The access point package includes wall-mounting and ceiling-mounting components. You can mount the access point to a solid surface (a wall or a ceiling) or to a ceiling with a 9/16 in. (14.3 mm) or 15/16 in. (23.8 mm) T-bar, or you can install the access point freestanding on a flat surface.

We recommend that you use a flat Ethernet cable so that the cable fits in the narrow space between the access point and the surface on which it is mounted or placed.

This appendix includes the following sections:

- [Mount indoor model WAX610 to a wall](#)
- [Mount indoor model WAX610 to a solid ceiling](#)
- [Mount indoor model WAX610 to a T-bar](#)

# Mount indoor model WAX610 to a wall

## To mount the access point to a wall:

1. The bottom of the access point includes two holes that let you mount the access point on two screws inserted in a wall.

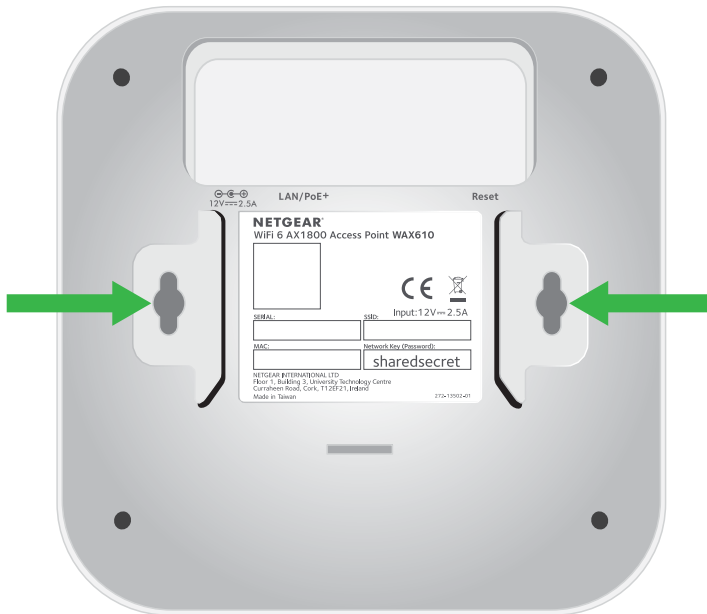

2. Mark the wall where you want to insert the provided anchors and screws, which must be 3.875 in. (98.5 mm) apart.
3. Insert the anchors and screws, but leave about 0.25 in. (6 mm) of each screw protruding from the wall so that you can insert the screws into the holes on the bottom of the access point.

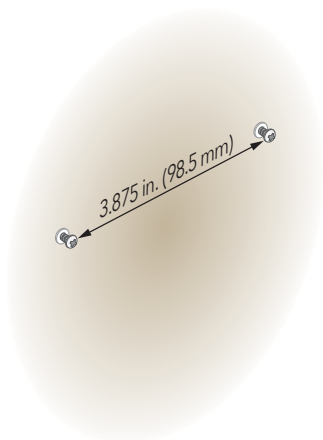

4. Line up the holes on the bottom of the access point with the screws in the wall and mount the access point to the wall.

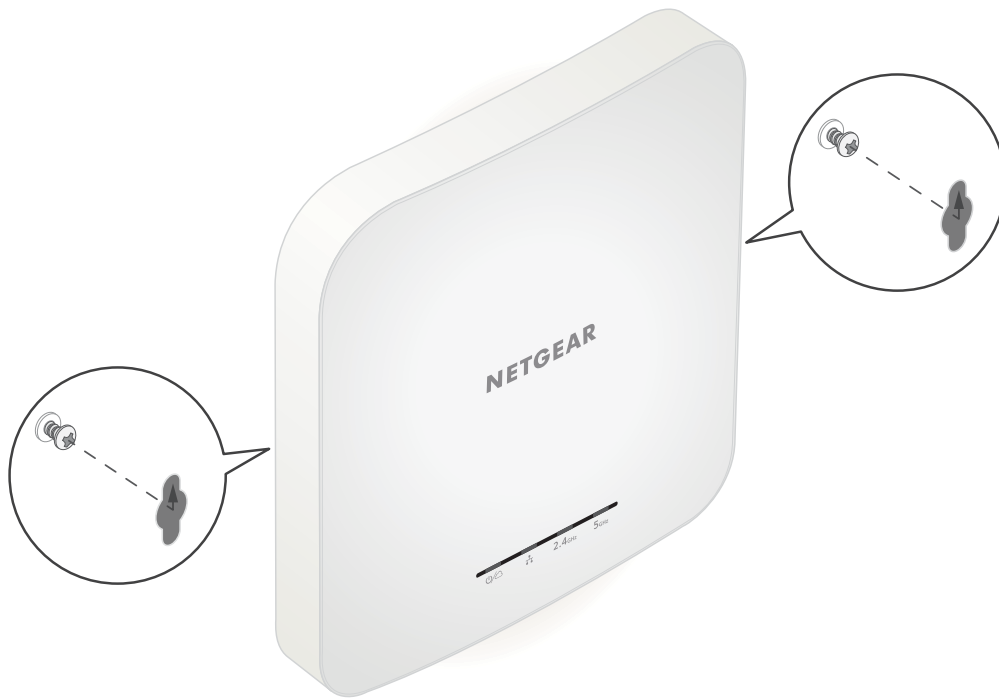

## Mount indoor model WAX610 to a solid ceiling

### To mount the access point to a solid ceiling:

1. Using the anchors and screws provided, attach the 15/16 in. (23.8 mm) bracket with the screw holes to the ceiling.  
The rectangular protruding part of the bracket must be facing the ceiling.

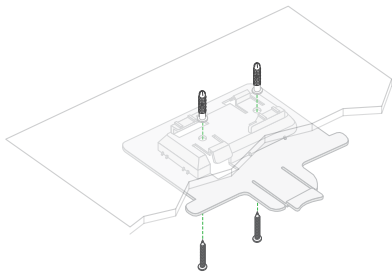

2. Hold the access point upside down with the front of the access point facing the bracket.

3. Line up the guides on the bottom of the access point with the bracket.

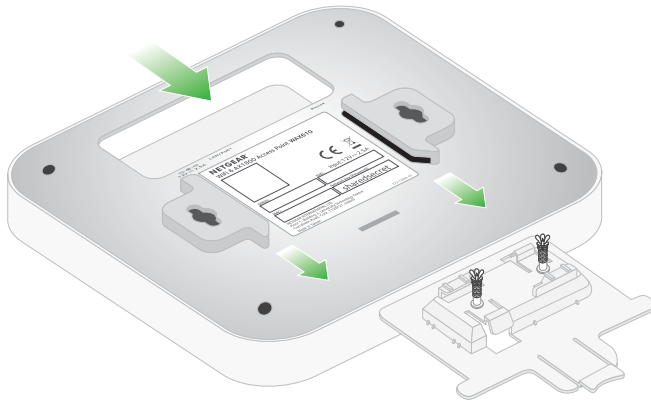

4. Slide the access point into the bracket until it locks in place.

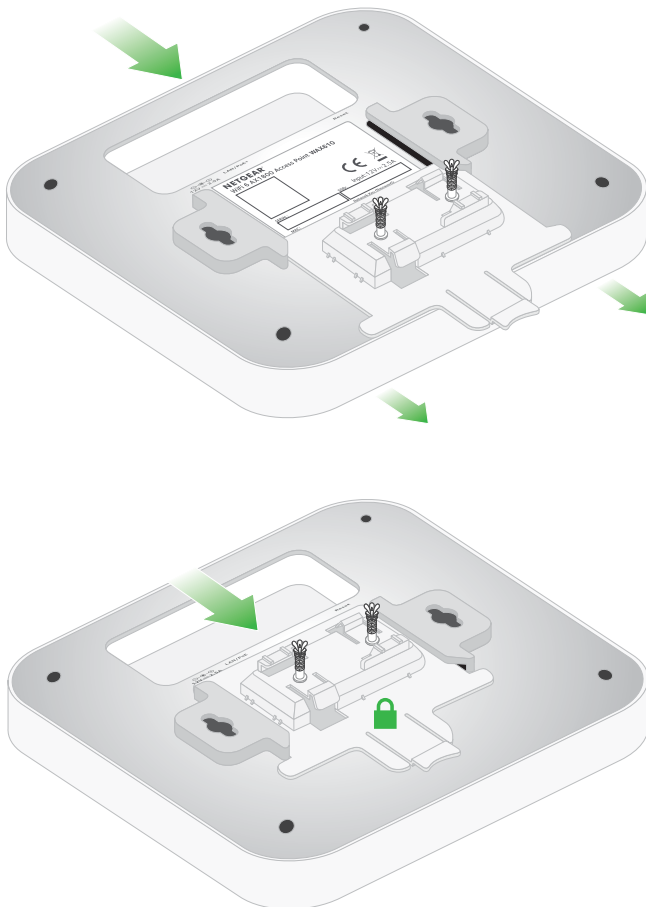

**Note:** To unlock the access point, push the locking tab toward the ceiling and slide the access point out of the bracket. The following figure shows a side view of the access point attached to the ceiling. The green arrow indicates the locking tab.

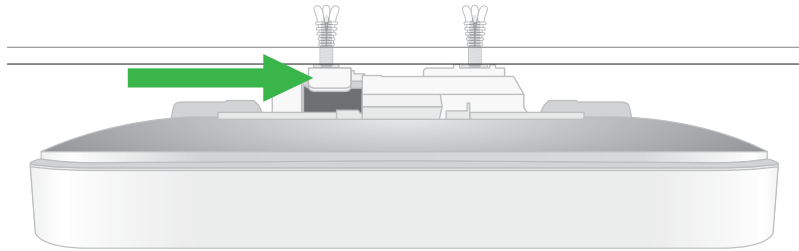

## Mount indoor model WAX610 to a T-bar

Depending on the size of the T-bar, use either the 9/16 in. (14.3 mm) or the 15/16 in. (23.8 mm) bracket.

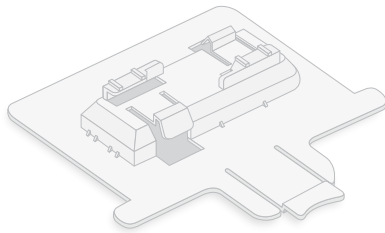

Figure 12. 9/16 in. (14.3 mm) bracket

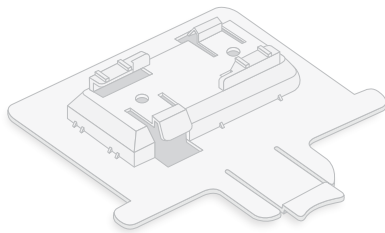
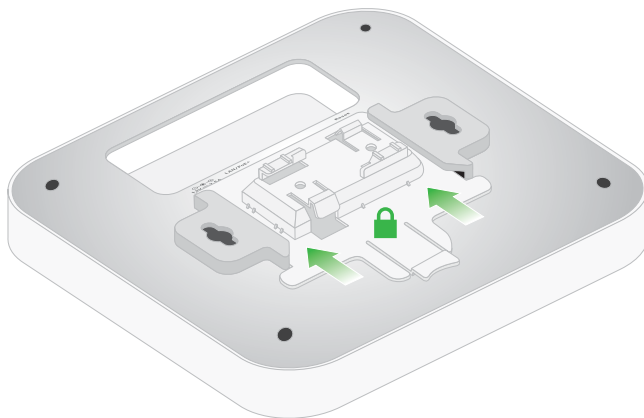
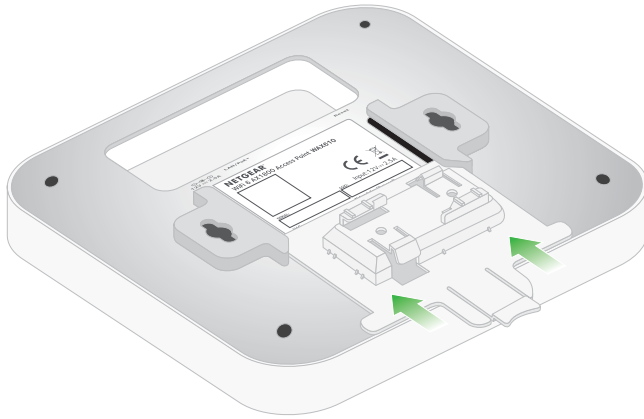

Figure 13. 15/16 in. (23.8 mm) bracket

**To mount the access point to a T-bar:**

1. Slide either the 9/16 in. (14.3 mm) or the 15/16 in. (23.8 mm) bracket between the guides on the bottom the access point until it locks in place.

The locking tab must be at the front of the access point.



2. Hold the access point upside down.

**Note:** If you can reach behind the T-bar, hold the T-bar with one hand and the access point with your other hand.

3. Align the rectangular protruding part of the bracket with the T-bar.
4. Hook the bracket onto one side of the T-bar.

5. Hook the bracket onto the other side of the T-bar until the bracket locks onto the T-bar.

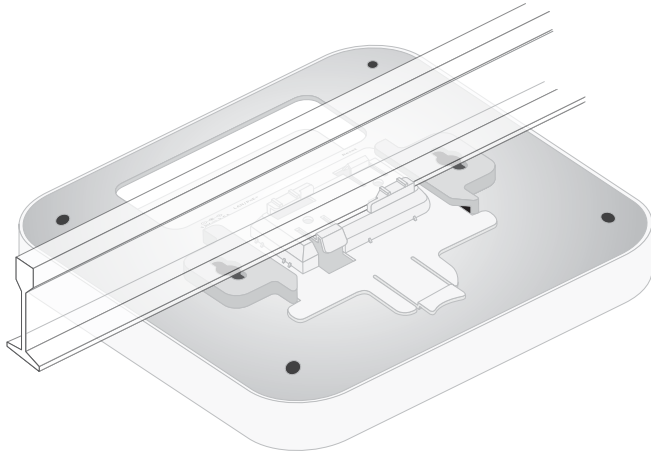

# B

## Mount Outdoor Model WAX610Y to a Wall or Pole

---

The access point package includes wall-mounting and pole-mounting components.

You can mount the access point to an outdoor wall. The package includes two screws, two washers, and a paper screw placement guide.

You can also mount the access point to a pole. The package includes a pole mounting strap.

**Note:** Before you mount the access point at a permanent location outdoors, we recommend that you configure the access point for your network environment and test your setup.

**WARNING:** After you mount the access point outdoors, make sure that you close the cover tightly so that moisture and insects cannot get inside the access point.

This appendix includes the following sections:

- [Mount outdoor model WAX610Y to a wall](#)
- [Mount outdoor model WAX610Y to a pole](#)



# Mount outdoor model WAX610Y to a wall

## To mount the access point to a wall:

1. Locate the two holes for wall mounting on the back of the access point.  
The arrows in the following figure show the holes.

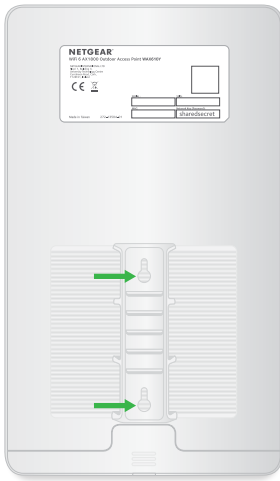

2. Using the screw placement guide, mark the location for the holes on the wall where you want to mount the access point.  
The holes must be 3.15 in. (80 mm) apart, center to center.

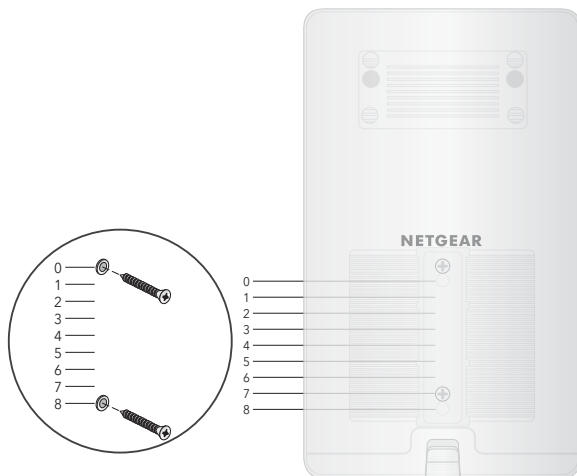

3. Drill holes into the wall for the two anchors in which you will insert the screws.  
The screws and anchors are in a plastic bag in the package.

4. Insert the anchors into the wall and tighten the screws with a No. 2 Phillips screwdriver. Leave about 0.25 in. (6 mm) of each screw protruding from the wall so that you can insert the screws into the holes on the back of the access point.
5. Line up the holes on the back of the access point with the screws in the wall and mount the access point to the wall.

## Mount outdoor model WAX610Y to a pole

### **To mount the access point to a pole:**

1. Locate the openings for the pole mounting strap on the back of the access point. The arrows in the following figure show the middle opening.

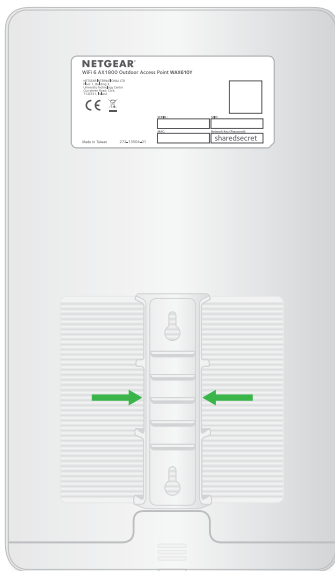

2. Using a screwdriver, open the supplied pole-mounting strap.

3. Insert the strap through one of the openings on the back of the access point.

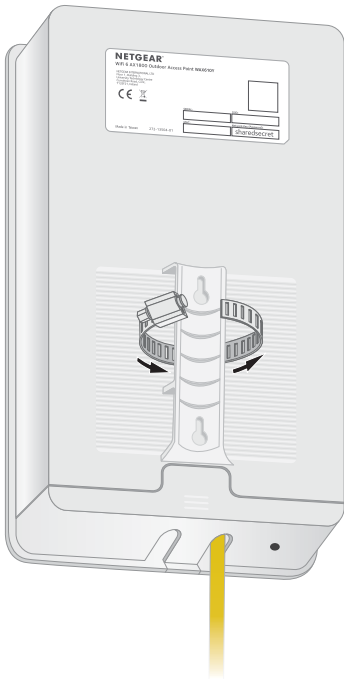

4. With the strap still open, wrap the strap with the attached access point around the pole.
5. Close the strap but do not tighten it.

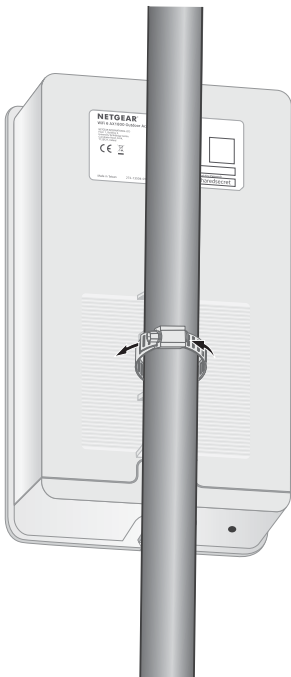

6. Move the strap with the access point attached to its permanent position.
7. Using the screwdriver, tighten the screw to secure the strap and access point to the pole.

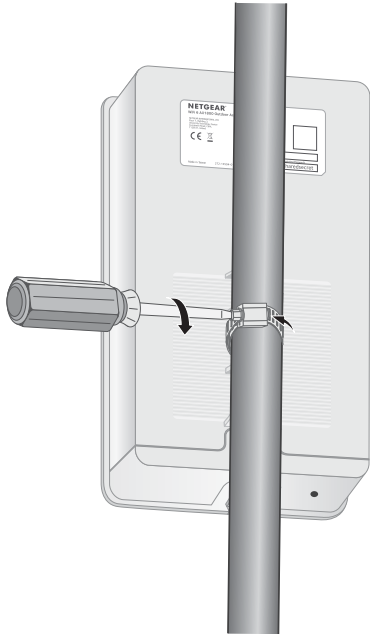

# C

## Factory Default Settings and Technical Specifications

---

This appendix includes the following sections:

- [Factory default settings](#)
- [Technical specifications indoor model WAX610](#)
- [Technical specifications outdoor model WAX610Y](#)

# Factory default settings

You can reset the access point to the factory default settings, which are shown in the following table.

For more information about resetting the access point to its factory settings, see [Return the access point to its factory default settings](#) on page 169.

Table 4. Factory default settings

Feature	Default Setting
<b>Management and login settings</b>	
Management mode	NETGEAR Insight (Cloud/Remote) <b>Note:</b> To access the local browser UI, you must select Web-browser (Local) as the management mode.
User login URL	192.168.0.100, if not connected to a network. <b>Note:</b> If connected to a network, the access point receives an IP address from a DHCP server or router in the network.
User name	<b>admin</b> , nonconfigurable
AP login password	<b>password</b> , case-sensitive, configurable <b>Note:</b> The first time that you log in to the local browser UI, you must change the AP login password. If you previously added the access point to a NETGEAR Insight network location and managed the access point through the Insight app or Insight Cloud portal, enter the Insight network password for that location. For more information, see <a href="#">Connect over WiFi using the NETGEAR Insight app</a> on page 31.
<b>WiFi network settings for initial setup and WiFi login</b>	
Initial SSID name	The SSID for initial setup is NETGEARxxxxxx-SETUP, where xxxxxx is the last six hexadecimal digits of the access point's MAC address. <b>Note:</b> The first time that you log in to the local browser UI, you must change the SSID. If you previously added the access point to a NETGEAR Insight network location and managed the access point through the Insight app or Insight Cloud portal, this requirement might not apply.
Initial WiFi security	WPA2 Personal (which is WPA2-PSK) WiFi password (network key): <b>sharedsecret</b> <b>Note:</b> The first time that you log in to the local browser UI, you must change the WiFi password. If you previously added the access point to a NETGEAR Insight network location and managed the access point through the Insight app or Insight Cloud portal, this requirement might not apply.
RF channels	Automatically selected (Auto) for both radios. <b>Note:</b> The available and supported channels depend on the country and region that you select for the access point.
<b>General system settings</b>	
Operating mode	AP mode

## Insight Managed WiFi 6 AX1800 Dual Band Access Point Models WAX610 and WAX610Y

Table 4. Factory default settings (Continued)

Feature	Default Setting
DHCP client	Enabled so that the access point receives an IP address from a DHCP server or router in the network.
NTP client	Enabled
Spanning Tree Protocol	Disabled
Network integrity check	Disabled
IGMP snooping	Disabled
802.1Q VLAN	Untagged VLAN with VLAN ID 1
Management VLAN	VLAN ID 1
Syslog	Disabled
Ethernet LLDP	Enabled
UPnP	Enabled
LEDs	All enabled
<b>WLAN settings for an individual WiFi network (SSID or VAP)</b>	
Broadcast SSID	Enabled
VLAN ID (for WiFi clients)	1
Network authentication	WPA2 Personal (which is WPA2-PSK) The nonconfigurable data encryption for WPA2 Personal is AES
802.11w (PMF)	Disabled
Broadcast schedule	Always on
Radio band	Both enabled
Band steering	Disabled Automatic band steering includes automatic 802.11k RRM and automatic 802.11v WiFi network management.
WiFi client isolation	Disabled
URL tracking	Disabled
DHCP offer broadcast to unicast	Enabled
Captive portal	None
MAC ACL	None assigned
Rate limit	None

Table 4. Factory default settings (Continued)

Feature	Default Setting
<b>Basic radio settings that apply to all WiFi networks (SSIDs or VAPs)</b>	
Radio broadcast	2.4 GHz radio: Enabled 5 GHz radio: Enabled
WiFi mode	2.4 GHz radio: 11ax mode, which also supports 11b, 11bg, and 11na 5 GHz radio: 11ax mode, which also support 11a, 11na, and 11ac
Channel width	2.4 GHz radio: Dynamic 20 / 40 MHz 5 GHz radio: Dynamic 20 / 40 / 80 MHz
Guard interval	2.4 GHz radio: Long-800 ns 5 GHz radio: Long-800 ns
Output power	2.4 GHz radio: Maximum (100%) 5 GHz radio: Maximum (100%)
Channel	2.4 GHz radio: Auto 5 GHz radio: Auto
Wi-Fi Multimedia (WMM)	2.4 GHz radio: Enabled 5 GHz radio: Enabled
WMM Powersave	2.4 GHz radio: Enabled 5 GHz radio: Enabled
<b>Advanced radio settings that apply to all WiFi networks (SSIDs or VAPs)</b>	
Number of WiFi clients	2.4 GHz radio: 200 default (also the maximum number) 5 GHz radio: 200 default (also the maximum number)
RTS threshold	2.4 GHz radio: Enabled at 2346 5 GHz radio: Enabled at 2346
Beacon interval	2.4 GHz radio: 100 millisecc. 5 GHz radio: 100 millisecc.
802.11n 256 QAM	2.4 GHz radio: Disabled 5 GHz radio: Nonconfigurable
MU-MIMO	2.4 GHz radio: Enabled 5 GHz radio: Enabled
DTIM interval	2.4 GHz radio: 2 sec. 5 GHz radio: 2 sec.
Broadcast and multicast rate limiting	2.4 GHz radio: Enabled with a limit of 50 pps 5 GHz radio: Enabled with a limit of 50 pps
802.11h	2.4 GHz radio: Not applicable 5 GHz radio: Disabled
Load balancing between radios	Disabled



Table 4. Factory default settings (Continued)

Feature	Default Setting
Force sticky clients to disassociate	Disabled
ARP proxy	Disabled
Broadcast enhancements	Disabled
Wireless bridge	None configured
<b>General security</b>	
URL filtering	Disabled
RADIUS servers	None configured
Neighbor AP detection	2.4 GHz radio: Disabled 5 GHz radio: Disabled
MAC ACLs	Eight default ACLs but none configured with MAC addresses
<b>Remote management</b>	
SNMP	Disabled

# Technical specifications indoor model WAX610

The following table shows the technical specifications for indoor model WAX610.

Table 5. Technical specifications indoor model WAX610

Feature	Description
WiFi modes	2.4 GHz radio: 802.11ax, 802.11ng, 801.11bg, and 802.11b 5 GHz radio: 802.11ax, 802.11ac, 802.11na, and 802.11a The access point supports 2.4 GHz and 5 GHz concurrent operation
Maximum theoretical throughput	About 1800 Mbps simultaneous throughput (600 Mbps in the 2.4 GHz band and 1200 Mbps in the 5 GHz band) <b>Note:</b> Throughput can vary. Network conditions and environmental factors, including volume of network traffic, building materials and construction, and network overhead, affect the data throughput rate.
Maximum number of supported clients	2.4 GHz radio: 200 5 GHz radio: 200 Even though each radio can support 200 clients, the access point can support a maximum of 250 clients with both radios enabled.
802.11 security	WPA3 Personal, WPA3/WPA2 Personal, WPA2 Personal, WPA2/WPA Personal, and WPA2 Enterprise
WiFi standards	IEEE 802.11ax (WiFi 6) WiFi Multimedia Prioritization (WMM) Wireless distribution system (WDS)
WiFi streams	Four streams: 2.4 GHz radio: two streams 5 GHz radio: two streams
Operating frequency ranges	2.412-2.472 GHz 5.180-5.240 GHz 5.260-5.230 GHz 5.500-5.700 GHz
Power over Ethernet	If you do not use a power adapter, the LAN/PoE+ port requires 802.3at (PoE+) power but might also function with 802.3af (PoE) power. We recommend that you use 802.3at (PoE+) power. <b>Note:</b> PoE might be considered a network environment 0 per IEC TR 62101, and thus the interconnected ITE circuits might be considered safety extra low voltage (SELV).
PoE consumption	15.5W
Power adapter	12 VDC, 2.5A The plug is localized to the country of sale. <b>Note:</b> The power adapter is not included but can be ordered as an option.

Table 5. Technical specifications indoor model WAX610 (Continued)

Feature	Description
Hardware interface	One RJ-45 LAN/PoE+ Ethernet port that supports 2.5 Gbps, 1 Gbps, 100 Mbps, and 10 Mbps. The port also supports Auto Uplink (Auto MDI-X). Without a power adapter, the LAN/PoE+ port requires 802.3at (PoE+) power but might also function with 802.3af (PoE) power. We recommend that you use 802.3at (PoE+) power.
Dimensions (W x D x H)	6.3 x 6.3 x 1.3 in. (160 x 160 x 33 mm)
Weight	0.9 lb (412 g)
Operating temperature	32° to 104°F (0° to 40°C)
Operating humidity	10 to 90% maximum relative humidity, noncondensing
Storage temperature	-4° to 158°F (-20° to 70°C)
Storage humidity	5 to 95% maximum relative humidity, noncondensing
EMI certification	FCC Part 15 Report (EMI) SubPart B CE EMC Report, EN 55032/24 Report EN 301 489-17 EMC Report
Regulatory compliance US	FCC Grant, FCC Authorization FCC Spectrum Report, Part 15, SubPart C (15.247) FCC Spectrum Report, Part 15, SubPart E (15.407) FCC Standard Absorption Rate Report (SAR or MPE), FCC Part 2 SpJ
Regulatory compliance Europe	EN 300 328, Radio Spectrum Report EN 301 893 Radio Spectrum Report EN 301 893 DFS Report EN RF Exposure (SAR or MPE), EN 62311(for Wi-Fi) , EN 62479 (for BT), EN 50385 (for AP router), EN 50566 (Body SAR)
Safety and energy compliance	IEC 60950-1 CB Certificate and Test Report, CB IEC60950 / EN60950 CE LVD Report, EN60950 Report EC 278/2009, External Power Supply

# Technical specifications outdoor model WAX610Y

The following table shows the technical specifications for outdoor model WAX610Y.

Table 6. Technical specifications outdoor model WAX610Y

Feature	Description
WiFi modes	2.4 GHz radio: 802.11ax, 802.11ng, 801.11bg, and 802.11b 5 GHz radio: 802.11ax, 802.11ac, 802.11na, and 802.11a The access point supports 2.4 GHz and 5 GHz concurrent operation
Maximum theoretical throughput	About 1800 Mbps simultaneous throughput (600 Mbps in the 2.4 GHz band and 1200 Mbps in the 5 GHz band) <b>Note:</b> Throughput can vary. Network conditions and environmental factors, including volume of network traffic, building materials and construction, and network overhead, affect the data throughput rate.
Maximum number of supported clients	2.4 GHz radio: 200 5 GHz radio: 200 Even though each radio can support 200 clients, the access point can support a maximum of 250 clients with both radios enabled.
802.11 security	WPA3 Personal, WPA3/WPA2 Personal (mixed), WPA2 Personal, WPA2/WPA Personal (mixed), and WPA2 Enterprise
WiFi standards	IEEE 802.11ax (WiFi 6) WiFi Multimedia Prioritization (WMM) Wireless distribution system (WDS)
WiFi streams	Four streams: 2.4 GHz radio: two streams 5 GHz radio: two streams
Operating frequency ranges	2.412-2.472 GHz 5.180-5.240 GHz 5.260-5.230 GHz 5.500-5.700 GHz
Power over Ethernet	If you do not use a power adapter, the LAN/PoE+ port requires 802.3at (PoE+) power but might also function with 802.3af (PoE) power. We recommend that you use 802.3at (PoE+) power. <b>Note:</b> PoE might be considered a network environment 0 per IEC TR 62101, and thus the interconnected ITE circuits might be considered safety extra low voltage (SELV).
PoE consumption	15.5W

Table 6. Technical specifications outdoor model WAX610Y (Continued)

Feature	Description
Hardware interface	One RJ-45 LAN/PoE+ Ethernet port that supports 2.5 Gbps, 1 Gbps, 100 Mbps, and 10 Mbps. The port also supports Auto Uplink (Auto MDI-X). Without a power adapter, the LAN/PoE+ port requires 802.3at (PoE+) power but might also function with 802.3af (PoE) power. We recommend that you use 802.3at (PoE+) power.
Dimensions (W x D x H)	12.00 x 7.13 x 1.81 in. (305 x 181 x 46 mm)
Weight	2.05 lb (930 g)
Operating temperature	14° to 122°F (-10° to 50°C)
Operating humidity	10 to 90% maximum relative humidity, noncondensing
Storage temperature	-4° to 158°F (-20° to 70°C)
Storage humidity	5 to 95% maximum relative humidity, noncondensing
EMI certification	FCC Part 15 Report (EMI) SubPart B CE EMC Report, EN 55032/24 Report EN 301 489-17 EMC Report
Regulatory compliance US	FCC Grant, FCC Authorization FCC Spectrum Report, Part 15, SubPart C (15.247) FCC Spectrum Report, Part 15, SubPart E (15.407) FCC Standard Absorption Rate Report (SAR or MPE), FCC Part 2 SpJ
Regulatory compliance Europe	EN 300 328, Radio Spectrum Report EN 301 893 Radio Spectrum Report EN 301 893 DFS Report EN RF Exposure (SAR or MPE), EN 62311(for Wi-Fi) , EN 62479 (for BT), EN 50385 (for AP router), EN 50566 (Body SAR)
Safety and energy compliance	IEC 60529 Edition 2.1 2001-02 - IP55 IEC 60950-1 CB Certificate and Test Report, CB IEC60950 / EN60950 CE LVD Report, EN60950 Report EC 278/2009, External Power Supply