



SPLIT-TYPE AIR CONDITIONERS **INDOOR UNIT**

MSZ-LN18VG2W MSZ-LN25VG2W MSZ-LN35VG2W MSZ-LN50VG2W MSZ-LN60VG2W
MSZ-LN18VG2V MSZ-LN25VG2V MSZ-LN35VG2V MSZ-LN50VG2V MSZ-LN60VG2V
MSZ-LN18VG2R MSZ-LN25VG2R MSZ-LN35VG2R MSZ-LN50VG2R MSZ-LN60VG2R
MSZ-LN18VG2B MSZ-LN25VG2B MSZ-LN35VG2B MSZ-LN50VG2B MSZ-LN60VG2B



OPERATING INSTRUCTIONS

English

SAFETY PRECAUTIONS

Meanings of symbols displayed on indoor unit and/or outdoor unit

	WARNING (Risk of fire)	This unit uses a flammable refrigerant. If refrigerant leaks and comes in contact with fire or heating part, it will create harmful gas and there is risk of fire.
	Read the OPERATING INSTRUCTIONS carefully before operation.	
	Service personnel are required to carefully read the OPERATING INSTRUCTIONS and INSTALLATION MANUAL before operation.	
	Further information is available in the OPERATING INSTRUCTIONS, INSTALLATION MANUAL, and the like.	

- Since rotating parts and parts which could cause an electric shock are used in this product, be sure to read these "Safety Precautions" before use.
- Since the cautionary items shown here are important for safety, be sure to observe them.
- After reading this manual, keep it together with the installation manual in a handy place for easy reference.

Marks and their meanings

WARNING : Incorrect handling could cause serious hazard, such as death, serious injury, etc. with a high probability.

CAUTION : Incorrect handling could cause serious hazard depending on the conditions.

Meanings of symbols used in this manual

- : Be sure not to do.
- : Be sure to follow the instruction.
- : Never insert your finger or stick, etc.
- : Never step onto the indoor/outdoor unit and do not put anything on them.
- : Danger of electric shock. Be careful.
- : Be sure to disconnect the power supply plug from the power outlet.
- : Be sure to shut off the power.
- : Risk of fire.
- : Never touch with wet hand.
- : Never splash water on the unit.

WARNING	
	<p>Do not connect the power cord to an intermediate point, use an extension cord, or connect multiple devices to a single AC outlet.</p> <ul style="list-style-type: none"> • This may cause overheating, fire, or electric shock. <p>Make sure the power plug is free of dirt and insert it securely into the outlet.</p> <ul style="list-style-type: none"> • A dirty plug may cause fire or electric shock. <p>Do not bundle, pull, damage, or modify the power cord, and do not apply heat or place heavy objects on it.</p> <ul style="list-style-type: none"> • This may cause fire or electric shock. <p>Do not turn the breaker OFF/ON or disconnect/connect the power plug during operation.</p> <ul style="list-style-type: none"> • This may create sparks, which can cause fire. • After the indoor unit is switched OFF with the remote controller, make sure to turn the breaker OFF or disconnect the power plug. <p>Do not expose your body directly to cool air for a prolonged length of time.</p> <ul style="list-style-type: none"> • This could be detrimental to your health. <p>The unit should not be installed, relocated, disassembled, altered, or repaired by the user.</p> <ul style="list-style-type: none"> • An improperly handled air conditioner may cause fire, electric shock, injury, or water leakage, etc. Consult your dealer. • If the power supply cord is damaged, it must be replaced by the manufacturer or its service agent in order to avoid a hazard. <p>When installing, relocating, or servicing the unit, make sure that no substance other than the specified refrigerant (R32) enters the refrigerant circuit.</p> <ul style="list-style-type: none"> • Any presence of foreign substance such as air can cause abnormal pressure rise and may result in explosion or injury. • The use of any refrigerant other than that specified for the system will cause mechanical failure, system malfunction, or unit breakdown. In the worst case, this could lead to a serious impediment to securing product safety. <p>This appliance is not intended for use by persons (including children) with reduced physical, sensory or mental capabilities, or lack of experience and knowledge, unless they have been given supervision or instruction concerning use of the appliance by a person responsible for their safety.</p> <p>Children should be supervised to ensure that they do not play with the appliance.</p>
	<p>Do not insert your finger, a stick, or other objects into the air inlet or outlet.</p> <ul style="list-style-type: none"> • This may cause injury, since the fan inside rotates at high speeds during operation.

	<p>In case of an abnormal condition (such as a burning smell), stop the air conditioner and disconnect the power plug or turn the breaker OFF.</p> <ul style="list-style-type: none"> • A continued operation in the abnormal state may cause a malfunction, fire, or electric shock. In this case, consult your dealer. <p>When the air conditioner does not cool or heat, there is a possibility of refrigerant leakage. If any refrigerant leakage is found, stop operations and ventilate the room well and consult your dealer immediately. If a repair involves recharging the unit with refrigerant, ask the service technician for details.</p> <ul style="list-style-type: none"> • The refrigerant used in the air conditioner is not harmful. Normally, it does not leak. However, if refrigerant leaks and comes in contact with fire or heating part of such a fan heater, kerosene heater, or cooking stove, it will create harmful gas and there is risk of fire. <p>The user should never attempt to wash the inside of the indoor unit. Should the inside of the unit require cleaning, contact your dealer.</p> <ul style="list-style-type: none"> • Unsuitable detergent may cause damage to plastic material inside the unit, which may result in water leakage. Should detergent come in contact with electrical parts or the motor, it will result in a malfunction, smoke, or fire. • The appliance shall be stored in a room without continuously operating ignition sources (for example: open flames, an operating gas appliance or an operating electric heater). • Be aware that refrigerants may not contain an odour. • Do not use means to accelerate the defrosting process or to clean the appliance, other than those recommended by the manufacturer. • Do not pierce or burn. <p>The indoor unit must be installed in rooms which exceed the floor space specified. Please consult your dealer.</p> <p>When the indoor unit is connected to the multi type outdoor unit of R32 refrigerant, please consult your dealer about the floor space specified.</p>
	<p>This appliance is intended to be used by expert or trained users in shops, in light industry and on farms, or for commercial use by lay persons.</p> <p>Do not touch the air purifying device from the top of the indoor unit during operation.</p>
CAUTION	
	<p>Do not touch the air inlet or the aluminum fins of the indoor/outdoor unit.</p> <ul style="list-style-type: none"> • This may cause injury. <p>Do not use insecticides or flammable sprays on the unit.</p> <ul style="list-style-type: none"> • This may cause a fire or deformation of the unit. <p>Do not expose pets or houseplants to direct airflow.</p> <ul style="list-style-type: none"> • This may cause injury to the pets or plants.

SAFETY PRECAUTIONS

EN

	Do not place other electric appliances or furniture under the indoor/outdoor unit.
	• Water may drip down from the unit, which may cause damage or malfunction.
	Do not leave the unit on a damaged installation stand.
	• The unit may fall and cause injury.
	Do not step on an unstable bench to operate or clean the unit.
	• This may cause injury if you fall down.
	Do not pull the power cord.
	• This may cause a portion of the core wire to break, which may cause overheating or fire.
	Do not charge or disassemble the batteries, and do not throw them into a fire.
	• This may cause the batteries to leak, or cause a fire or explosion.
	Do not operate the unit for more than 4 hours at high humidity (80% RH or more) and/or with windows or outside door left open.
	• This may cause the water condensation in the air conditioner, which may drip down, wetting or damaging the furniture. • The water condensation in the air conditioner may contribute to growth of fungi, such as mold.
	Do not use the unit for special purposes, such as storing food, raising animals, growing plants, or preserving precision devices or art objects.
	• This may cause deterioration of quality, or harm to animals and plants.
	Do not expose combustion appliances to direct airflow.
	• This may cause incomplete combustion.
	Never put batteries in your mouth for any reason to avoid accidental ingestion.
	• Battery ingestion may cause choking and/or poisoning.
	Before cleaning the unit, switch it OFF and disconnect the power plug or turn the breaker OFF.
	• This may cause injury, since the fan inside rotates at high speeds during operation.
	When the unit will be unused for a long time, disconnect the power plug or turn the breaker OFF.
	• The unit may accumulate dirt, which may cause overheating or fire.
	Replace all batteries of the remote controller with new ones of the same type.
	• Using an old battery together with a new one may cause overheating, leakage, or explosion.
	If the battery fluid comes in contact with your skin or clothes, wash them thoroughly with clean water.
	• If the battery fluid comes in contact with your eyes, wash them thoroughly with clean water and immediately seek medical attention.
	Ensure that the area is well-ventilated when the unit is operated together with a combustion appliance.
	• Inadequate ventilation may cause oxygen starvation.
	Turn the breaker OFF when you hear thunder and there is a possibility of a lightning strike.
	• The unit may be damaged if lightning strikes.
	After the air conditioner is used for several seasons, perform inspection and maintenance in addition to normal cleaning.
	• Dirt or dust in the unit may create an unpleasant odor, contribute to growth of fungi, such as mold, or clog the drain passage, and cause water to leak from the indoor unit. Consult your dealer for inspection and maintenance, which require specialized knowledge and skills.
	Do not operate switches with wet hands.
	• This may cause electric shock.
	Do not clean the air conditioner with water or place an object that contains water, such as a flower vase, on it.
	• This may cause fire or electric shock.
	Do not step on or place any object on the outdoor unit.
	• This may cause injury if you or the object falls down.

IMPORTANT

Dirty filters cause condensation in the air conditioner which will contribute to the growth of fungi such as mold. It is therefore recommended to clean air filters every 2 weeks.

Before starting the operation, ensure that the horizontal vanes are in the closed position. If operation starts when the horizontal vanes are in the open position, they may not return to the correct position.

For installation

WARNING	
	Consult your dealer for installing the air conditioner.
	• It should not be installed by the user since installation requires specialized knowledge and skills. An improperly installed air conditioner may cause water leakage, fire, or electric shock.
	Provide a dedicated power supply for the air conditioner.
	• A non-dedicated power supply may cause overheating or fire.
	Do not install the unit where flammable gas could leak.
	• If gas leaks and accumulates around the outdoor unit, it may cause an explosion.
	Earth the unit correctly.
	• Do not connect the earth wire to a gas pipe, water pipe, lightning rod, or a telephone earth wire. Improper earthing may cause electric shock.
	CAUTION
	Install an earth leakage breaker depending on the installation location of the air conditioner (such as highly humid areas).
	• If an earth leakage breaker is not installed, it may cause electric shock.
	Ensure that the drain water is properly drained.
	• If the drain passage is improper, water may drip down from the indoor/outdoor unit, wetting and damaging the furniture.
In case of an abnormal condition	
Immediately stop operating the air conditioner and consult your dealer.	

For Wi-Fi interface

WARNING	
(Improper handling may have serious consequences, including serious injury or death.)	
	This appliance can be used by children aged from 8 years and above and persons with reduced physical, sensory or mental capabilities or lack of experience and knowledge if they have been given supervision or instruction concerning use of the appliance in a safe way and understand the hazards involved.
	Children shall not play with the appliance. Cleaning and user maintenance shall not be made by children without supervision.
	Do not use the Wi-Fi interface nearby the medical electrical equipment or people who have a medical device such as a cardiac pacemaker or an implantable cardioverter-defibrillator.
	• It can cause an accident due to malfunctions of the medical equipment or device.
	Do not install the Wi-Fi interface nearby the automatic control devices such as automatic doors or fire alarms.
	• It can cause accidents due to malfunctions.
	Do not touch the Wi-Fi interface with wet hands.
	• It can cause damage to the device, electric shock, or fire.
	Do not splash water on the Wi-Fi interface or use it in a bathroom.
	• It can cause damage to the device, electric shock, or fire.
	When the Wi-Fi interface is dropped, or the holder or cable is damaged, disconnect the power supply plug or turn the breaker OFF.
	• It may cause fire or electric shock. In this case, consult your dealer.
	CAUTION
(Improper handling may have consequences, including injury or damage to building.)	
	Do not step on unstable stepstool to set up or clean the Wi-Fi interface.
	• It may cause injury if you fall down.
	Do not use the Wi-Fi interface nearby other wireless devices, micro-waves, cordless phones, or facsimiles.
	• It can cause malfunctions.

DISPOSAL



Fig. 1

To dispose of this product, consult your dealer.

Note:

This symbol mark is for EU countries only.
This symbol mark is according to the directive 2012/19/EU Article 14 Information for users and Annex IX, and/or to the directive 2006/66/EC Article 20 Information for end-users and Annex II.

Your MITSUBISHI ELECTRIC product is designed and manufactured with high quality materials and components which can be recycled and/or reused. This symbol means that electrical and electronic equipment, batteries and accumulators, at their end-of-life, should be disposed of separately from your household waste.

If a chemical symbol is printed beneath the symbol (Fig. 1), this chemical symbol means that the battery or accumulator contains a heavy metal at a certain concentration. This will be indicated as follows:
Hg: mercury (0.0005%), Cd: cadmium (0.002%), Pb: lead (0.004%)
In the European Union there are separate collection systems for used electrical and electronic products, batteries and accumulators.
Please, dispose of this equipment, batteries and accumulators correctly at your local community waste collection/recycling centre.
Please, help us to conserve the environment we live in!

NAME OF EACH PART

Indoor unit

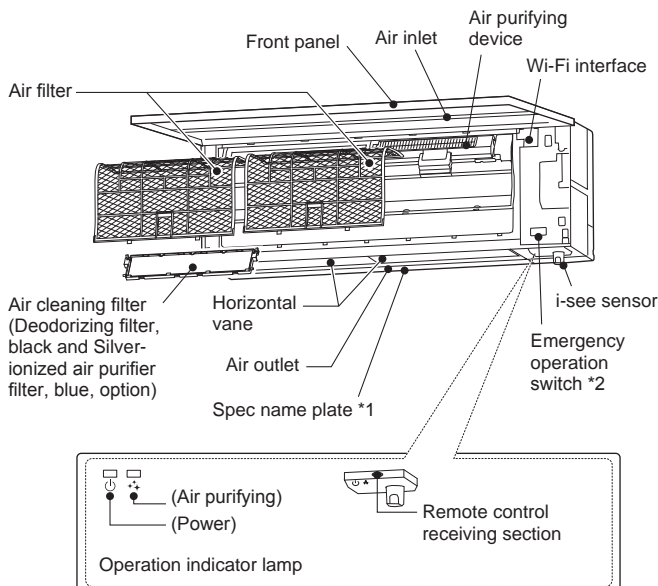

Outdoor unit

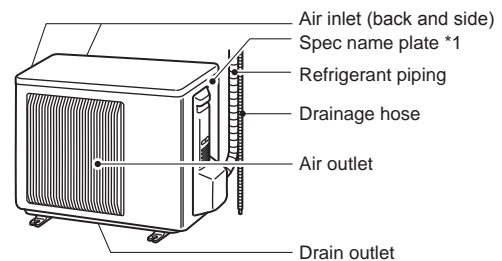

Outdoor units may be different in appearance.

*1 The manufacturing year and month are indicated on the spec name plate.

*2 When the remote controller cannot be used...

Emergency operation can be activated by pressing the emergency operation switch (E.O. SW) on the indoor unit.

Each time the E.O. SW is pressed, the operation changes in the following order:

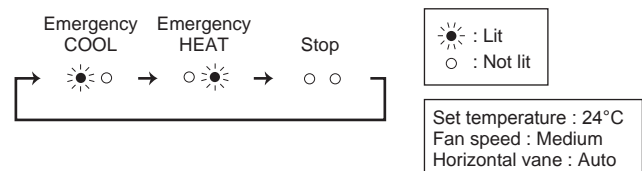

PREPARATION BEFORE OPERATION

Before operation: Insert the power supply plug into the power outlet and/or turn the breaker on.

Installing the remote controller batteries

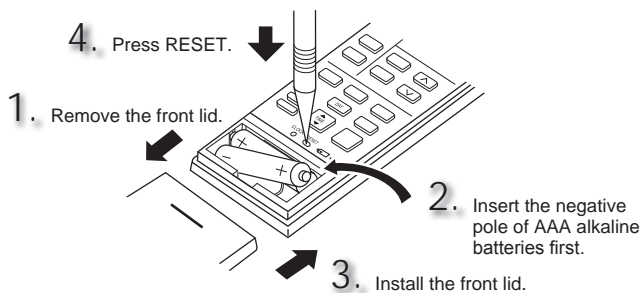

Setting current time

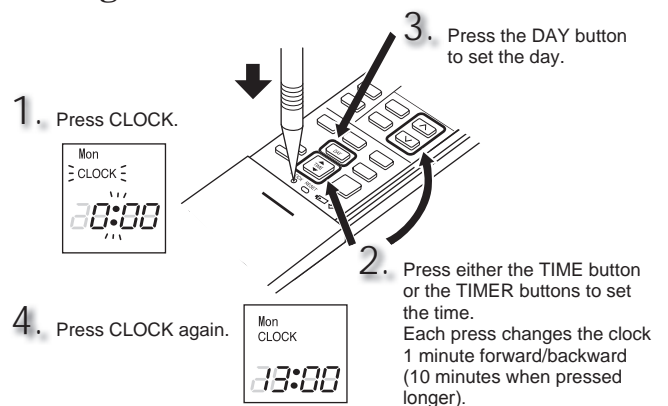

PREPARATION BEFORE OPERATION

Remote controller

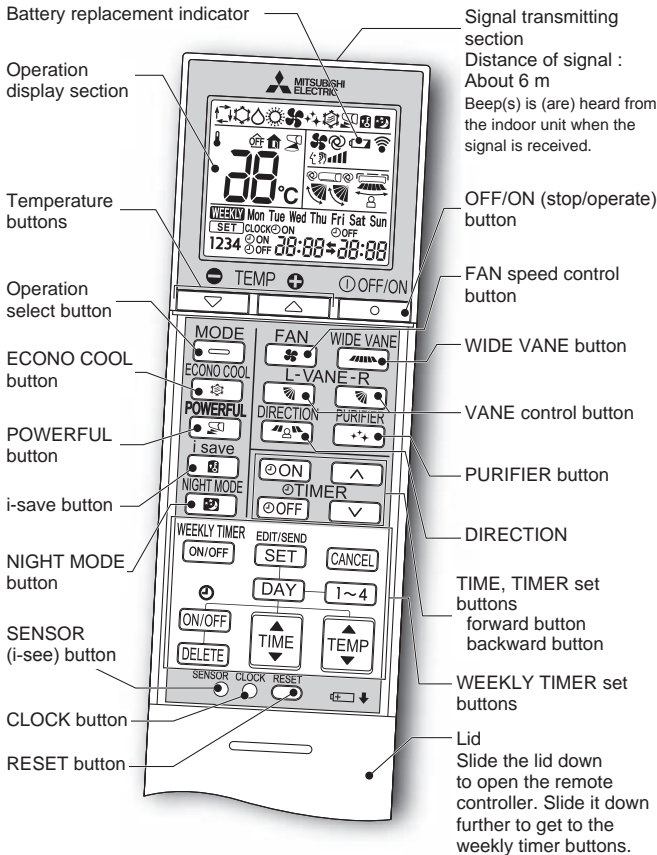

TIME, TIMER set button

Change the time forward/backward

ON (ON timer) : The unit turns ON at the set time.

OFF (OFF timer) : The unit turns OFF at the set time.

Press **▲** (forward) and **▼** (backward) to set the time of timer.

WEEKLY TIMER set buttons

Press **EDIT/SEND SET** to enter the weekly timer setting mode.

Press **DAY** and **1~4** to select setting day and number.

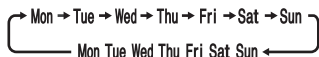

Press **ON/OFF**, **TIME**, and **TEMP** to set ON/OFF, time, and temperature.

Press **EDIT/SEND SET** to complete and transmit the weekly timer setting.

Press **WEEKLY TIMER ON/OFF** to turn the weekly timer ON. (**WEEKLY** lights.)

Press **WEEKLY TIMER ON/OFF** again to turn the weekly timer OFF. (**WEEKLY** goes out.)

SENSOR
In the i-see control mode, the room temperature is controlled based on the sensible temperature.

OFF/ON
OFF/ON (stop/operate) button

MODE
Operation select button



Temperature buttons

Each press raises or lowers the temperature by 1°C.

FAN
FAN speed control button

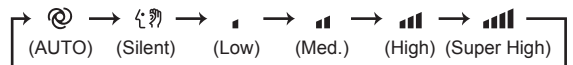

WIDE VANE
Left-right airflow control button

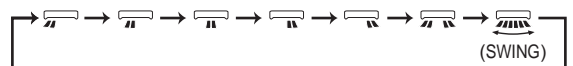

VANE
Up-down airflow control button

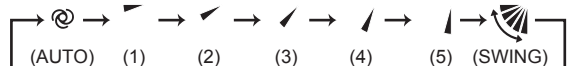

DIRECTION
DIRECTION button

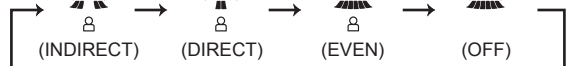

ECONO COOL
ECONO COOL button

The set temperature and the airflow direction are automatically changed by the microprocessor.

i save
i-save button

A simplified set back function enables to recall the preferred (preset) setting with a single push of the **i save** button. Press the button again and you can go back to the previous setting in an instance.

NIGHT MODE
NIGHT MODE button

NIGHT MODE operation changes the brightness of the operation indicator, disables the beep sound and limits the noise level of the outdoor unit.

PURIFIER
PURIFIER button

In the AIR PURIFYING operation, the indoor unit built-in device reduces airborne fungi, viruses, mold, and allergens.

POWERFUL
POWERFUL button

CLEANING

Instructions:

- Switch off the power supply or turn off the breaker before cleaning.
- Be careful not to touch the metal parts with your hands.
- Do not use benzene, thinner, polishing powder, or insecticide.
- Use only diluted mild detergents.
- Do not use a scrubbing brush, a hard sponge, or the like.
- Do not soak or rinse the horizontal vane.
- Do not use water hotter than 50°C.
- Do not expose parts to direct sunlight, heat, or fire to dry.
- Do not apply excessive force on the fan as it may cause cracks or breakage.

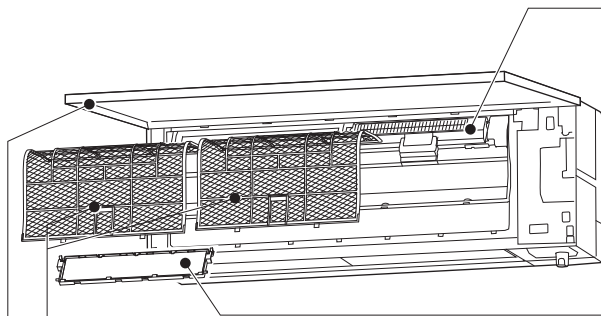

Air filter

- **Clean every 2 weeks**
- Remove dirt by a vacuum cleaner, or rinse with water.
- After washing with water, dry it well in shade.

Front panel

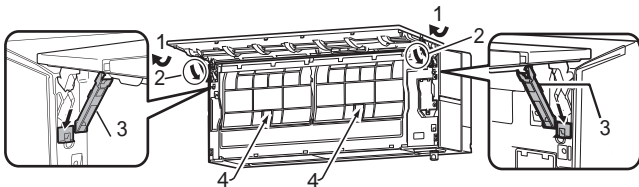

1. Open the front panel.
Note: You cannot remove the front panel.
2. Rotate the stoppers as indicated by the arrows until they click.
3. Lower the front panel slowly and it will be held open with the stoppers.
4. Pinch the tabs on the filters; slightly push them up and pull down toward you to remove the filters.
5. Close the front panel securely and press the positions indicated by the arrows.
6. Clean the front panel without detaching it from the unit.
 - Wipe with a soft dry cloth.
 - Use the dedicated SOFT DRY CLOTH. Parts Number **MAC-1001CL-E**
 - Do not soak the front panel in water.

Air purifying device

- Every 3 months:
- Remove dirt by a vacuum cleaner.
- When dirt cannot be removed by vacuum cleaning:**
- Soak the filter together with its frame in lukewarm water and rinse it.
 - After washing, dry it well in shade.

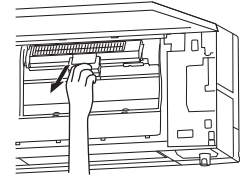

Air cleaning filter (Deodorizing filter, black)

- Every 3 months:
- Remove dirt by a vacuum cleaner, or soak the framed filter in lukewarm water (30 to 40°C) for about 15 minutes. Rinse well.
 - After washing, dry it well in shade.
 - Deodorizing feature recovers by cleaning the filter.
- When dirt or smell cannot be removed by cleaning:**
- Replace it with a new air cleaning filter.
 - Parts Number **MAC-3010FT-E**

and (Silver-ionized air purifier filter, blue, option)

- Every 3 months:
- Remove dirt by a vacuum cleaner.
- When dirt cannot be removed by vacuum cleaning:**
- Soak the filter and its frame in lukewarm water before rinsing it.
 - After washing, dry it well in shade. Install all tabs of the air filter.

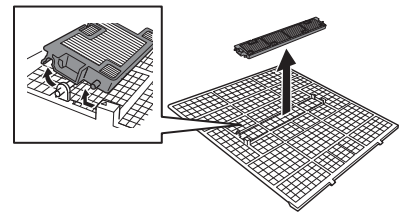

- Every year:
- Replace it with a new air cleaning filter for best performance.
 - Parts Number **MAC-2390FT-E**

! Important

- **The surface of the indoor unit is easily scratched, so never rub or hit the unit with something hard. Also, when installing or removing the front panel, handle it with care to prevent scratches on it.**
- **Do not use abrasive cleaner to prevent scratches on the surface of the indoor unit.**
- **It is very easy to get fingerprints on the surface of the indoor unit. When fingerprints are noticeable, gently wipe them off with a soft dry cloth.**
- **When using a commercially available chemical impregnated cloth, follow its instructions.**
- **Do not leave the front panel open for a prolonged time.**

! Important

- **Clean the filters regularly for best performance and to reduce power consumption.**
- **Dirty filters cause condensation in the air conditioner which will contribute to the growth of fungi such as mold. It is therefore recommended to clean air filters every 2 weeks.**
- **Do not touch the i-see sensor.**
- **The air purifying device does not function for safety for a couple minutes after the operation starts or the front panel is opened/closed.**
- **Do not disassemble the air purifying device.**
- **Do not touch any parts other than the frame of the air purifying device.**

This information is based on **REGULATION (EU) No 528/2012**

MODEL NAME	Treated Article (Parts name)	Active Substances (CAS No.)	Property	Instruction for Use (Safe handling information)
MAC-2390FT-E	FILTER	Silver zinc zeolite (130328-20-0)	Antibacterial	<ul style="list-style-type: none"> • Use this product in line with the instruction manual indications and for the intended purpose only. • Do not put into mouth. Keep away from children.

Wi-Fi INTERFACE SETTING UP

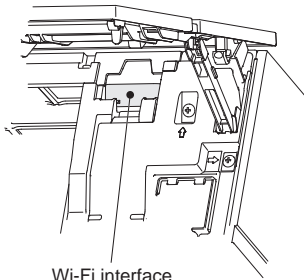

Wi-Fi interface

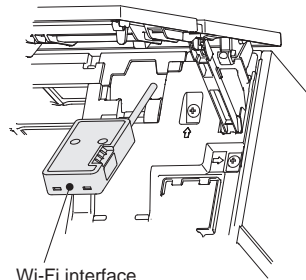

Wi-Fi interface

This Wi-Fi interface, communicates the status information and controls the commands from the MELCloud by connecting to the indoor unit.

Note:

- Set up a connection between the Wi-Fi interface and the Router. Refer to the SETUP MANUAL and SETUP QUICK REFERENCE GUIDE provided with the unit.
- For SETUP MANUAL, please go to the website below.
<http://www.melcloud.com/Support>
- For MELCloud User Manual, please go to the website below.
<http://www.melcloud.com/Support>

SPECIFICATIONS

Model	Indoor		MSZ-LN18VG2		MSZ-LN25VG2		MSZ-LN35VG2		MSZ-LN50VG2				MSZ-LN60VG2	
	Outdoor		-		MUZ-LN25VG(HZ)2		MUZ-LN35VG(HZ)2		MUZ-LN50VG2		MUZ-LN50VGHZ		MUZ-LN60VG	
Function			Cooling	Heating	Cooling	Heating	Cooling	Heating	Cooling	Heating	Cooling	Heating	Cooling	Heating
Power supply			~ /N, 230 V, 50 Hz											
Capacity		kW	-	-	2.5	3.2	3.5	4.0	5.0	6.0	5.0	6.0	6.1	6.8
Input		kW	-	-	0.485	0.60	0.82	0.82	1.38	1.48	1.38	1.48	1.79	1.81
Weight	Indoor	kg	14.5 (W) 15.5 (V, R, B)						15 (W) 16 (V, R, B)					
	Outdoor	kg	-		25VG2:33 25VGHZ2/35VG2:34 35VGHZ2:36				40		55		55	
Refrigerant filling capacity (R32)		kg	-		25VG2:0.80 25VGHZ2:0.85		0.85		1.25		1.45			
IP code	Indoor		IP 20											
	Outdoor		-		IP 24									
Permissible excessive operating pressure	LP ps	MPa	-											
	HP ps	MPa	2.77											
Noise level	Indoor (Super High/ High/Med./ Low./Silent)	dB(A)	42/36/29/ 23/19	45/38/29/ 24/19	42/36/29/ 23/19	45/38/29/ 24/19	43/36/29/ 24/19	45/38/29/ 24/19	46/39/35/ 31/27	47/39/34/ 29/25	46/39/35/ 31/27	47/39/34/ 29/25	49/45/41/ 37/29	49/45/41/ 37/29
			Outdoor	dB(A)	-	-	46	49	49	50	51	54	51	54

EN

Indoor specification for multi connection REGULATION (EU) 2016/2281

Model	Indoor			MSZ-LN18VG2 (W/V/R/B)	MSZ-LN25VG2 (W/V/R/B)	MSZ-LN35VG2 (W/V/R/B)
	Capacity	Cooling	Sensible	kW	1.74	2.42
Latent			kW	0.06	0.08	0.35
Heating		kW	2.00	2.90	4.00	
Input		kW	0.029	0.029	0.029	
Noise level (Sound power level)	Super High/High/Med./Low/ Silent	dB(A)	58-52-45-39-35	58-52-45-39-35	58-51-44-39-34	

Guaranteed operating range

		Indoor	Outdoor	
			MUZ-LN25/35/50VG2 MUZ-LN60VG	MUZ-LN25/35VGHZ2 MUZ-LN50VGHZ
Cooling	Upper limit	32°C DB 23°C WB	46°C DB —	46°C DB —
	Lower limit	21°C DB 15°C WB	-10°C DB —	-10°C DB —
Heating	Upper limit	27°C DB —	24°C DB 18°C WB	24°C DB 18°C WB
	Lower limit	20°C DB —	-15°C DB -16°C WB	-25°C DB -26°C WB

DB: Dry Bulb
WB: Wet Bulb

Note:

- Rating condition
Cooling — Indoor: 27°C DB, 19°C WB
Outdoor: 35°C DB
Heating — Indoor: 20°C DB
Outdoor: 7°C DB, 6°C WB
- LN18 have no specifications for single combination. These indoor models are only for multi system air conditioner. As for the specifications of multi system, please confirm your dealer and/or refer to the catalogue.

Wi-Fi interface

Model	MAC-567IFB-E
Input Voltage	DC12.7 V (from indoor unit)
Power consumption	MAX. 2 W
Size H×W×D (mm)	79×44×18.5
Weight (g)	60 (including cable)
Transmitter power level (MAX.)	17.5 dBm @IEEE 802.11b
RF channel	1ch ~ 13ch (2412~2472 MHz)
Radio protocol	IEEE 802.11b/g/n (20)
Encryption	AES
Authentication	WPA2-PSK
Software Ver	XX.00

For Declaration of Conformity, please go to the website below.
<http://www.melcloud.com/Support>

WHEN YOU THINK THAT TROUBLE HAS OCCURRED

In the following cases, stop using the air conditioner and consult your dealer.

- When water leaks or drips from the indoor unit.
- When the operation indicator lamp blinks.
- When the breaker trips frequently.
- The remote control signal is not received in a room where an electronic ON/OFF type fluorescent lamp (inverter-type fluorescent lamp, etc.) is used.
- Operation of the air conditioner interferes with radio or TV reception. An amplifier may be required for the affected device.
- When an abnormal sound is heard.
- When any refrigerant leakage is found.

Wi-Fi interface setting information

Indoor unit model name	
Indoor unit serial number	
Outdoor unit model name	
Outdoor unit serial number	
Wi-Fi interface MAC address (MAC)	
Wi-Fi interface serial number (ID)	
Wi-Fi interface PIN (PIN)	
Wi-Fi interface SSID (SSID)	
Wi-Fi interface KEY (KEY)	
System commissioning date	
Wi-Fi interface installation date	

MEMO

.....

.....

.....

.....

.....

.....

.....

.....

.....

.....

.....

.....

.....

.....

.....

.....

.....

.....

.....

.....

.....

Installer contact details

Name	
Telephone number	

Name of Importer:

Mitsubishi Electric Europe B.V.
Capronilaan 46, 1119 NS, Schiphol Rijk, The Netherlands

French Branch
25, Boulevard des Bouvets, 92741 Nanterre Cedex, France

German Branch
Mitsubishi-Electric-Platz 1, 40882 Ratingen, Germany

Belgian Branch
Autobaan 2, 8210 Loppem, Belgium

Irish Branch
Westgate Business Park, Ballymount, Dublin 24, Ireland

Italian Branch
Centro Direzionale Colleoni, Palazzo Sirio-Ingresso 1
Viale Colleoni 7, 20864 Agrate Brianza (MB), Italy

Norwegian Branch
Gneisveien 2D, 1914 Ytre Enebakk, Norway

Portuguese Branch
Avda. do Forte, 10, 2799-514, Carnaxide, Lisbon, Portugal

Spanish Branch
Carretera de Rubi 76-80 - Apdo. 420 08173 Sant Cugat del Valles (Barcelona), Spain

Scandinavian Branch
Hammarbacken 14, P.O. Box 750 SE-19127, Sollentuna, Sweden

UK Branch
Travellers Lane, Hatfield, Herts., AL10 8XB, England, U.K.

Polish Branch
Krakowska 50, PL-32-083 Balice, Poland

MITSUBISHI ELECTRIC TURKEY ELEKTRİK ÜRÜNLERİ A.Ş
Şerifali Mah. Kale Sok. No:41 34775 Ümraniye, İstanbul/Turkey

EC DECLARATION OF CONFORMITY
EG-KONFORMITÄTSEKHLÄRUNG
DÉCLARATION DE CONFORMITÉ CE
EG-CONFORMITEITSVERKLARING
DECLARACIÓN DE CONFORMIDAD CE
DICHIARAZIONE DI CONFORMITÀ CE
ΔΗΛΩΣΗ ΠΙΣΤΟΤΗΤΑΣ ΕΚ
DECLARAÇÃO DE CONFORMIDADE CE
EU-OVERENSSTEMMELSESERKLÆRING

EG-DEKLARATION OM ÖVERENSSTÄMMELSE
EC UYGUNLUK BEYANI
ЕС ДЕКЛАРАЦИЯ ЗА СЪОТВЕТСТВИЕ
DEKLARACJA ZGODNOŚCI WE
CE-ERKLÆRING OM SAMSVAR
EY-VAATIMUSTENMUKAISUUSVAKUUTUS
ES PROHLÁŠENÍ O SHODĚ
VYHLÁSENIE O ZHODE ES
EK MEGFELELŐSÉGI NYILATKOZAT

IZJAVA O SKLADNOSTI ES
DECLARAȚIE DE CONFORMITATE CE
EU VASTAVUSDEKLARATSIOON
EK ATBILSTĪBAS DEKLARĀCIJA
EB ATITIKTIES DEKLARĀCIJA
EC IZJAVA O SUKLADNOSTI
EZ IZJAVA O USAGLAŠENOSTI
ДЕКЛАРАЦИЯ СООТВЕТСТВИЯ НОРМАМ ЕС
ДЕКЛАРАЦІЯ ВІДПОВІДНОСТІ НОРМАМ ЄС

MITSUBISHI ELECTRIC CONSUMER PRODUCTS (THAILAND) CO., LTD
AMATA NAKORN INDUSTRIAL ESTATE 700/406 MOO 7, TAMBON DON HUA ROH, AMPHUR MUANG, CHONBURI 20000, THAILAND

hereby declares under its sole responsibility that the air conditioners and heat pumps described below for use in residential, commercial and light-industrial environments:
erklärt hiermit auf seine alleinige Verantwortung, dass die Klimaanlage und die Wärmepumpen für das häusliche, kommerzielle und leicht-industrielle Umfeld wie unten beschrieben:
déclare par la présente et sous sa propre responsabilité que les climatiseurs et les pompes à chaleur décrits ci-dessous, destinés à un usage dans des environnements résidentiels, commerciaux et d'industrie légère :
verklaart hierbij onder eigen verantwoordelijkheid dat de voor residentiële, commerciële en licht-industriële omgevingen bestemde airconditioners en warmtepompen zoals onderstaand beschreven:
por la presente declara bajo su única responsabilidad que los acondicionadores de aire y bombas de calor descritas a continuación para su uso en entornos residenciales, comerciales y de industria ligera:
conferma con la presente, sotto la sua esclusiva responsabilità, che i condizionatori d'aria e le pompe di calore descritti di seguito e destinati all'utilizzo in ambienti residenziali, commerciali e semi-industriali:
με το παρόν πιστοποιεί με αποκλειστική της ευθύνη ότι οι τα κλιματιστικά και οι αντλίες θέρμανσης που περιγράφονται παρακάτω για χρήση σε οικιακό, επαγγελματικό και ελαφριάς βιομηχανίας περιβάλλοντα:
através da presente declara sob sua única responsabilidade que os aparelhos de ar condicionado e bombas de calor abaixo descritos para uso residencial, comercial e de indústria ligeira:
erklærer hermed under eneansvar, at de herunder beskriver airconditionanlæg og varmepumper til brug i privat boligbyggeri, erhvervsområder og inden for let industri:
intyggar härmed att luftkonditioneringarna och varmepumparna som beskrivs nedan för användning i bostäder, kommersiella miljöer och lätta industriella miljöer:
ev, ticaret ve hafif sanayi ortamlarında kullanılmı amaçlı üretilen ve aṣağıda açıklanan klima ve ısıtma pompalarıyla ilgili aṣağıdaki hususları yalnızca kendi sorumluluğunda beyan eder:
декларира на своя собствена отговорност, че климатичите и термopомпите, описани по-долу, за употреба в жилищни, търговски и леки промишлени условия:
niniejszym oświadcza na swoją wyłączną odpowiedzialność, że klimatyzatory i pompy ciepła opisane poniżej, są przeznaczone do zastosowań w środowisku mieszkalnym, handlowym i lekkim przemysłowym:
erklærer et fullstendig ansvar for undernevnte klima- og varmepumper ved bruk i bolig, og samt kommersielle og lettindustrielle miljøer:
vakuuttaa täten yksinomaista vastuutaan, että jäljempänä kuvutut asuinrakennuksiin, pientaloisuuskäyttöön ja kaupalliseen käyttöön tarkoitettui ilmastointilaitteet ja lämpöpumpat:
tímto na vlastní odpovědnost prohlašuje, že níže popsané klimatizační jednotky a tepelná čerpadla pro použití v obytných prostředích, komerčních prostředích a prostředích lehkého průmyslu:
tytmo na svoju výlučnú zodpovednosť vyhlasuje, že nasledovné klimatizačné jednotky a tepelné čerpadlá určené na používanie v obytných a obchodných priestoroch a v prostredí ľahkého priemyslu:
alulírott kizárólagos felelősségére nyilatkozik, hogy az alábbi lakossági, kereskedelmi és kisipari környezetben való használatra szánt klímaberendezések és hőszivattyúk:
izjavlja pod izključno lastno odgovornostjo, da so spodaj navedene klimatske naprave in toplotne črpalke, namenjene uporabi v stanovanjskih, komercialnih in lahkoindustrijskih okoljih:
declară, prin prezenta, pe proprie răspundere, faptul că aparatele de climatizare și pompele de căldură descrise mai jos și destinate utilizării în medii rezidențiale, comerciale și din industria ușoară:
kinnitab käesolevaga oma ainuvastutuse, et allpool toodud kliimaseadmed ja soojuspumbad on mõeldud kasutamiseks elu-, äri- ja kergtööstuskeskkondades:
ar šo, vienpersoniski uzņemoties atbildību, paziņo, ka tālāk aprakstītie gaisa kondicionētāji un siltumsūkņi ir paredzēti lietošanai dzīvojamajās, komercdarbības un vieglās rūpniecības telpās.
šuo vien tik savo atsakomybe pareiški, kad toliau apibūdinti oro kondicionierai ir šilumos siurbiai skirti naudoti gyvenamosiose, komercinėse ir lengvosios pramonės aplinkose:
izjavlja pod izključno odgovornostjo, da su klimatizacijski uređaji i toplinske dizalice opisane u nastavku namijenjeni za upotrebu u stambenim, komercijalnim okruženjima i okruženjima sa lakom industrijom:
настоящим заявляю и беру на себя исключительную ответственность за то, что кондиционеры и тепловые насосы, описанные ниже и предназначенные для эксплуатации в жилых помещениях, торговых залах и на предприятиях легкой промышленности:
цим заявляю, беручи на себе повну відповідальність за це, що кондиціонери й теплові насоси, описані нижче й призначені для використання в житлових приміщеннях, торговельних залах і на підприємствах легкої промисловості:

MITSUBISHI ELECTRIC, MSZ-LN18VG2W/-, MSZ-LN18VG2V/-, MSZ-LN18VG2R/-, MSZ-LN18VG2B/-, MSZ-LN25VG2W/MUZ-LN25VG2, MSZ-LN25VG2W/MUZ-LN25VGHZ2, MSZ-LN25VG2V/MUZ-LN25VG2, MSZ-LN25VG2V/MUZ-LN25VGHZ2 MSZ-LN25VG2R/MUZ-LN25VG2, MSZ-LN25VG2R/MUZ-LN25VGHZ2, MSZ-LN25VG2B/MUZ-LN25VG2, MSZ-LN25VG2B/MUZ-LN25VGHZ2 MSZ-LN35VG2W/MUZ-LN35VG2, MSZ-LN35VG2W/MUZ-LN35VGHZ2, MSZ-LN35VG2V/MUZ-LN35VG2, MSZ-LN35VG2V/MUZ-LN35VGHZ2 MSZ-LN35VG2R/MUZ-LN35VG2, MSZ-LN35VG2R/MUZ-LN35VGHZ2, MSZ-LN35VG2B/MUZ-LN35VG2, MSZ-LN35VG2B/MUZ-LN35VGHZ2 MSZ-LN50VG2W/MUZ-LN50VG2, MSZ-LN50VG2W/MUZ-LN50VGHZ, MSZ-LN50VG2V/MUZ-LN50VG2, MSZ-LN50VG2V/MUZ-LN50VGHZ MSZ-LN50VG2R/MUZ-LN50VG2, MSZ-LN50VG2R/MUZ-LN50VGHZ, MSZ-LN50VG2B/MUZ-LN50VG2, MSZ-LN50VG2B/MUZ-LN50VGHZ MSZ-LN60VG2W/MUZ-LN60VG, MSZ-LN60VG2V/MUZ-LN60VG, MSZ-LN60VG2R/MUZ-LN60VG, MSZ-LN60VG2B/MUZ-LN60VG

Note: Its serial number is on the nameplate of the product.
Hinweis: Die Seriennummer befindet sich auf dem Kennschild des Produkts.
Remarque : Le numéro de série de l'appareil se trouve sur la plaque du produit.
Opmerking: het serienummer staat op het naamplaatje van het product.
Nota: El número de serie se encuentra en la placa que contiene el nombre del producto.
Nota: il numero di serie si trova sulla targhetta del prodotto.
Σημείωση: Ο σειριακός του αριθμός βρίσκεται στην πινακίδα ονόματος του προϊόντος.
Nota: o número de série encontra-se na placa que contém o nome do produto.
Bemærk: Seriennummeret står på produktets fabriksskilt.
Obs: Serienumret finns på produktens namnplåt.
Not: Seri numarasi ürünün isim plakasında yer alır.
Забелешка: Серийният му номер е на табелката на продукта.
Uwaga: Numer serjnyj znajduje się na tabliczce znamionowej produktu.
Merk: Seriennummeret befinder seg på navneplaten til produktet.

Huomautus: Sarjanumero on merkitty laitteen arvokilpeen.
Poznámka: Příslušné sériové číslo se nachází na štítku produktu.
Poznámka: Výrobné číslo sa nachádza na typovom štítku výrobku.
Megjegyzés: A sorozatszám a termék adattábláján található.
Opomba: serijska številka je zapisana na tipski ploščici enote.
Notă: Numărul de serie este specificat pe plăcuța indicatoare a produsului.
Márkus. Seerianumber asub toote andmesildil.
Piezīme. Sērijas numurs ir norādīts uz ierīces datu plāksnītes.
Pastaba. Serijos numeris nurodytas gaminio vardinį duomenų lentelėje.
Napomena: serijski broj nalazi se na natpisnoj pločici proizvoda.
Napomena: Serijski broj nalazi se na nazivnoj pločici proizvoda.
Примечание: серийный номер указан на паспортной табличке изделия.
Примітка. Серійний номер вказано на паспортній таблиці виробу.

Directives	Direttive	Direktifier	Směrnice	Direktiivid	Директивы
Richtlijnen	Όδηγες	Директиви	Smernice	Direktivas	Директиви
Directives	Directivas	Dyrektywy	Irányelvek	Direktivos	
Richtlijnen	Direktiver	Direktiver	Direktive	Direktive	
Directivas	Direktiv	Direktiv	Directive	Direktive	

2014/53/EU: Radio Equipment Directive
2006/42/EC: Machinery Directive
2011/65/EU: RoHS

Issued: 2 May, 2019 Akira HIDAKA
THAILAND Manager, Quality Assurance Department

MITSUBISHI ELECTRIC CORPORATION

HEAD OFFICE: TOKYO BUILDING, 2-7-3, MARUNOUCHI, CHIYODA-KU, TOKYO 100-8310, JAPAN

JG79Y449L02