

MARVEL STUDIOS

IRON MAN

76165

BOOKLET AVAILABLE IN ENGLISH ON
LIVRET DISPONIBLE EN FRANÇAIS SUR
FOLLETO DISPONIBLE EN ESPAÑOL EN

LEGO.COM/SERVICE/BUILDINGINSTRUCTIONS

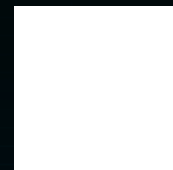



SOME HEROES ARE BORN. OTHERS ARE BUILT.

Iron Man is indisputably one of the most portrayed and beloved Super Heroes in the Marvel Cinematic Universe and comic books. The model you're about to build is our humble tribute to the heroics, suits and many faces of Iron Man.

GENIUS. BILLIONAIRE. PLAYBOY. PHILANTHROPIST.

Tony Stark is a shameless, self-promoting, fast-talking weapons and tech mogul. After being kidnapped by terrorists, he forges his first iron suit, blasts his way out of his desert prison, redefines his life purpose and rebuilds his identity as a Super Hero. Albeit still a deeply flawed character, his brilliant mind is his only superpower. As he struggles with inner demons and external threats, he puts a human face on super-heroism, evolving into a responsible strategist and powerful Avenger who (spoiler alert) pays the ultimate price to save the world.

THE SUITS THAT MAKE IRON MAN

The suit makes the man, but man, Tony Stark can make the suit, too. As a visionary and later slightly paranoid inventor, he spends years perfecting new ones.

From **Mark 1**, the scrap iron suit of a fledgling Super Hero in Marvel Studios' *Iron Man* (2008), to the final **Mark 85**, which allows Stark to form a new Infinity Gauntlet, hold the Infinity Stones and defeat Thanos in Marvel Studios' *Avengers: Endgame* (2019), each suit represents its own facet of this complex character. How do you portray all these iconic features in one mask, with LEGO® bricks?

It seemed an impossible task. Senior LEGO Designer Mark John Stafford rose to the challenge. The result: an amalgamation of some of the most memorable expressions and moments of Iron Man's history.



MARK 1
Marvel Studios'
Iron Man
(2008)

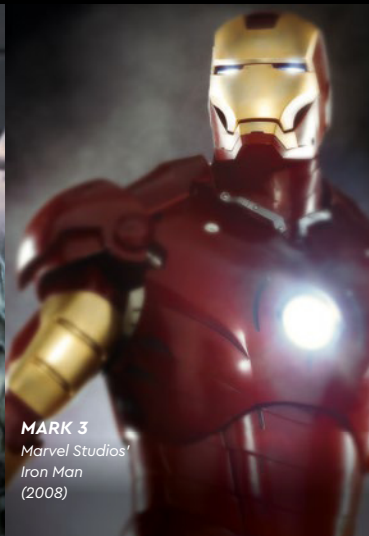

MARK 3
Marvel Studios'
Iron Man
(2008)



MARK 7
Marvel Studios'
Iron Man
(2012)

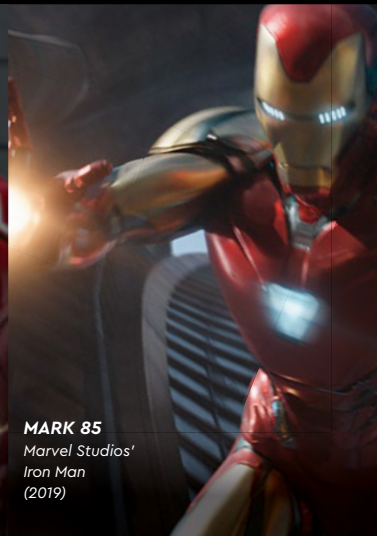

MARK 85
Marvel Studios'
Iron Man
(2019)



MARK 42
Marvel Studios' *Iron Man 3* (2013)



THE CREATION OF THE LEGO® HELMET

FIRST, RESEARCHING THE SUITS

Marvel Studios' *Iron Man* (2008) gives us **Mark 3**, the first signature hot rod red/gold suit which Stark's AI assistant Jarvis sarcastically remarks will "help him keep a low profile". But who can forget Stark plummeting to Earth in his **Mark 7** in Marvel Studios' *The Avengers* (2012) – the first suit to automatically deploy and assemble? Or the **Mark 50** nanotechnology that spawns those cool new weapons in Marvel Studios' *Avengers: Infinity War* (2018)? And, of course, there's that fateful **Mark 85** from Marvel Studios' *Avengers: Endgame* (2019).

LEGO® DESIGNER, MARK J. STAFFORD EXPLAINS:

"We wanted to capture the essence of the movie masks, with respect for the comic book heritage, and get the shapes as accurate as possible for this scale.

It's a challenge to build curves and slopes out of bricks, especially the forehead, nasal bridge and ears. The cheekbones are classic comic book. In a few of the books, his mask had a nose, but I think we've achieved the smooth, powerful welding-helmet look that is so representative of who Iron Man is."



...IF WE CAN'T PROTECT THE EARTH, YOU CAN
BE DAMN WELL SURE WE'LL AVENGE IT"

- TONY STARK

Marvel Studios' *The Avengers* (2012)



DES HÉROS NAISSENT. D'AUTRES SE CONSTRUISENT.

Iron Man est sans conteste l'un des superhéros les plus représentés et les plus aimés des films et des bandes dessinées de Marvel. Le modèle que vous êtes sur le point de construire est notre humble hommage à l'héroïsme, aux armures et aux multiples visages d'Iron Man.

GÉNIE. MILLIARDAIRE. PLAYBOY. PHILANTHROPE.

Tony Stark est un magnat de la technologie et un fabricant d'armes sans vergogne à la langue bien pendue, qui aime se mettre en avant. Après avoir été enlevé par des terroristes, il forge sa première armure de fer, fait exploser sa prison pour s'en échapper, redéfinit sa mission de vie et reconstruit son identité pour devenir un superhéros. Ce personnage profondément imparfait possède néanmoins un esprit brillant qui constitue son unique superpouvoir. Dans sa lutte contre ses démons intérieurs et les menaces extérieures, il donne un visage humain à l'héroïsme et devient un stratège responsable et un Avenger puissant qui (divulgâcheur) fait le sacrifice ultime pour sauver le monde.

LES ARMURES QUI DÉFINISSENT IRON MAN

Les armures créées par Tony Stark au fil du temps reflètent son évolution. Durant des années, cet inventeur visionnaire devenu légèrement paranoïaque crée de nouvelles armures de plus en plus perfectionnées.

De **Mark 1**, l'armure en ferraille du jeune superhéros du film *Iron Man* (2008) de Marvel Studios, jusqu'à **Mark 85**, la dernière armure de Stark qui lui permet de former un nouveau Gant de l'infini, de posséder les Gemmes de l'infini et de vaincre Thanos dans *Avengers: Phase finale* (2019) de Marvel Studios, chaque armure présente une facette de ce personnage complexe. Comment dépeindre toutes ces caractéristiques emblématiques dans un seul masque en briques LEGO® ?

Cela semblait une tâche impossible. Mark John Stafford, concepteur principal LEGO, a relevé le défi. Le résultat mêle les expressions et les moments les plus mémorables de l'histoire d'Iron Man.



MARK 1
Iron Man
de Marvel Studios
(2008)

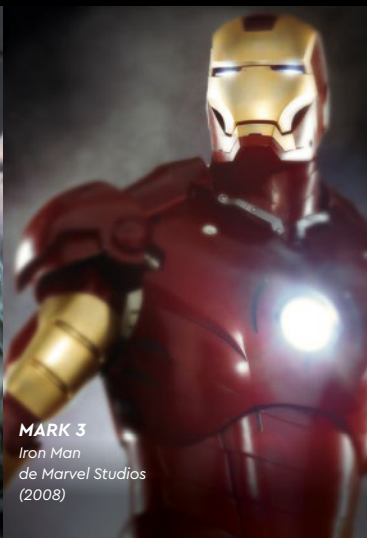

MARK 3
Iron Man
de Marvel Studios
(2008)



MARK 7
Iron Man
de Marvel Studios
(2012)



MARK 85
Iron Man
de Marvel Studios
(2019)



MARK 42

Iron Man 3 de Marvel Studios (2013)



LA CRÉATION DU CASQUE LEGO®

TOUT D'ABORD, LA RECHERCHE DES ARMURES

C'est dans *Iron Man* (2008) de Marvel Studios que **Mark 3** fait son apparition. Jarvis, l'assistant virtuel de Stark, affirme de manière sarcastique que cette première armure emblématique rouge et or « l'aidera à faire profil bas ». Mais qui peut oublier *Les Avengers* (2012) de Marvel Studios et la chute de Stark qui plonge vers le sol en revêtant **Mark 7**, la première armure à se déployer et s'assembler automatiquement ? Il y a aussi la nanotechnologie de l'armure **Mark 50** qui engendre de nouvelles armes incroyables dans *Avengers : La Guerre de l'infini* (2018) de Marvel Studios. Et, bien sûr, il y a l'armure funeste **Mark 85** dans *Avengers : Phase finale* (2019) de Marvel Studios.

LE CONCEPTEUR LEGO® MARK J. STAFFORD EXPLIQUE :

« Nous voulions capturer l'essence des masques des films en respectant l'héritage des bandes dessinées et faire en sorte que les formes soient les plus précises

possible compte tenu de l'échelle. C'est un défi de construire des courbes et des pentes avec des briques, et en particulier le front, le pont nasal et les oreilles. Les pommettes sont fidèles aux bandes dessinées classiques. Dans certains livres, son masque avait un nez, mais je pense que nous avons réussi à obtenir le côté lisse et puissant du casque de soudage typique d'Iron Man. »



... SI ON NE PEUT PAS PROTÉGER LA TERRE,
JE PEUX VOUS ASSURER QU'ON LA VENGERA.»

- TONY STARK

Les Avengers de Marvel Studios (2012)



HAY HÉROES QUE NACEN. OTROS SE CONSTRUYEN

Iron Man es, indiscutiblemente, uno de los superhéroes más representados y admirados del mundo de los cómics y del Universo Cinematográfico de Marvel. El modelo que estás a punto de construir es nuestro humilde tributo a las heroicas hazañas, los trajes y los muchos rostros de Iron Man.

GENIO. MULTIMILLONARIO. CONQUISTADOR. FILÁNTROPO

Tony Stark es un magnate de las armas y la tecnología caracterizado por su descaro y su egocentrismo. Luego de ser secuestrado por terroristas, forja su primer traje de hierro, abandona su prisión en el desierto, redefine su propósito en la vida y adquiere una nueva identidad como superhéroe. Conocemos entonces a un personaje profundamente imperfecto cuyo único superpoder es una mente brillante. Una constante batalla contra sus propios demonios e inverosímiles amenazas externas cubre al superhéroe de humanidad y lo convierte en un estratega responsable y un poderoso Vengador que (¡alerta de *spoiler!*) acaba pagando el más alto precio por salvar al mundo.

LOS TRAJES DE IRON MAN

Si el traje hace al hombre, Tony Stark también puede hacer al traje. Inventor visionario y, con el tiempo, un poco paranoico, dedica años a perfeccionar sus armaduras.

Desde la **Mark 1**, el primitivo traje de un incipiente superhéroe en Marvel Studios *Iron Man* (2008), hasta la **Mark 85**, que permite a Stark usar un nuevo Guante del Infinito, hacer suyas las Gemas del Infinito y derrotar a Thanos en Marvel Studios *Avengers: Endgame* (2019), cada traje representa una faceta diferente del complejo personaje. ¿Cómo capturar tantos rasgos emblemáticos en una sola máscara usando bricks LEGO®?

Parecía un objetivo inalcanzable, pero John Stafford, diseñador sénior de LEGO, aceptó el desafío. El resultado es la suma de algunas de las expresiones y etapas más memorables de la historia de Iron Man.



MARK 1
Marvel Studios
Iron Man
(2008)

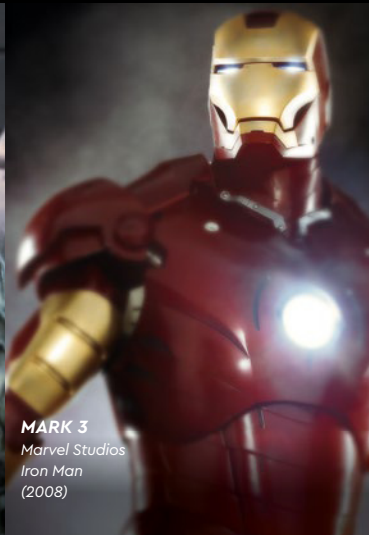

MARK 3
Marvel Studios
Iron Man
(2008)



MARK 7
Marvel Studios
Iron Man
(2012)

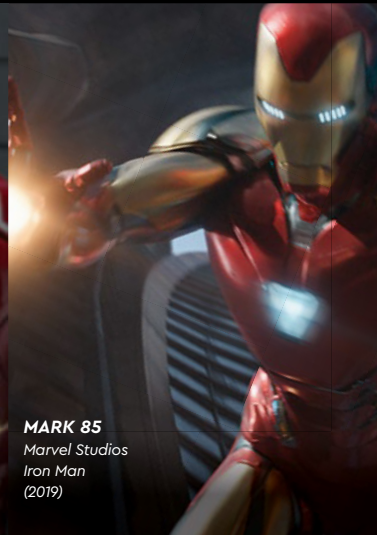

MARK 85
Marvel Studios
Iron Man
(2019)



MARK 42
Marvel Studios *Iron Man 3* (2013)



LA CREACIÓN DEL CASCO LEGO®

INVESTIGAR LOS TRAJES, EL PRIMER PASO

Marvel Studios *Iron Man* (2008) nos presenta la **Mark 3**, el primer traje clásico en rojo y dorado del superhéroe, que, según asegura sarcásticamente la IA de Stark, Jarvis, "le ayudará a pasar desapercibido". ¿Pero quién puede olvidar a Stark precipitándose al vacío en la **Mark 7**, el primer traje que se despliega y ensambla automáticamente, en Marvel Studios *The Avengers: Los Vengadores* (2012)? ¿O la nanotecnología de la **Mark 50**, que engendraba aquellas armas tan increíbles en Marvel Studios *Avengers: Infinity War* (2018)? ¿Por no hablar, por supuesto, de la fatídica **Mark 85** de Marvel Studios *Avengers: Endgame* (2019)?

EN PALABRAS DE MARK J. STAFFORD, DISEÑADOR DE LEGO®

"Queríamos capturar la esencia de las máscaras de las películas respetando el legado del cómic y lograr la máxima precisión en las formas a esta escala. Construir

curvas y pendientes con bricks siempre es un desafío; en este caso, especialmente, a la hora de reproducir la frente, el puente nasal y las orejas.

Los pómulos son un clásico del cómic. En varios de los libros, el casco tenía nariz, pero creo que hemos logrado el aspecto moderno y poderoso, cercano al de una máscara de soldadura, que simboliza con tanta fuerza lo que representa Iron Man".



... Y SI NO PROTEGEMOS A LA TIERRA, TE PROMETO QUE LA VENGAREMOS".

- TONY STARK

Marvel Studios *The Avengers: Los Vengadores* (2012)

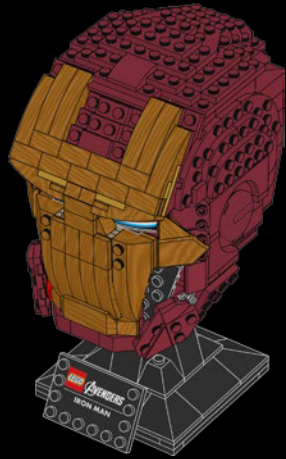
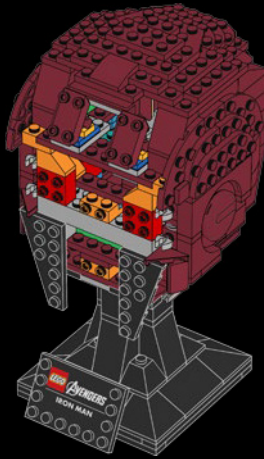
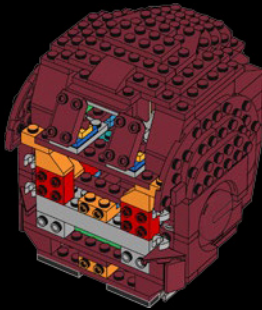
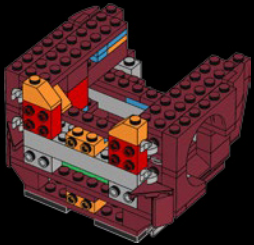

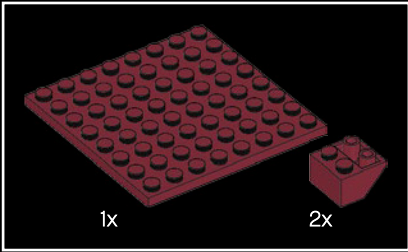
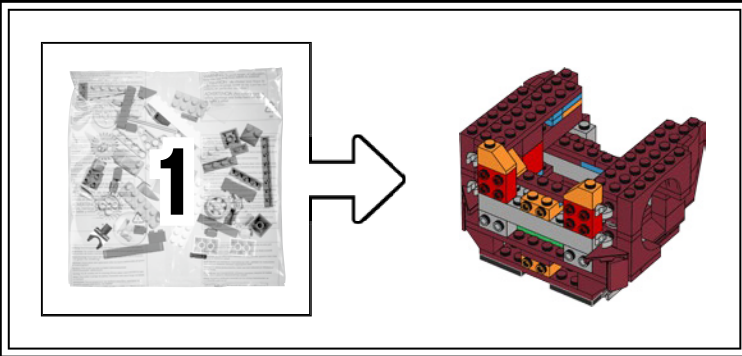

1

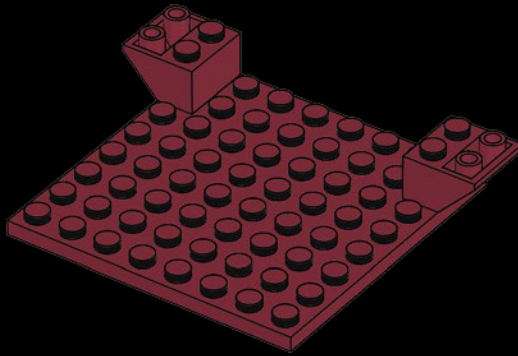

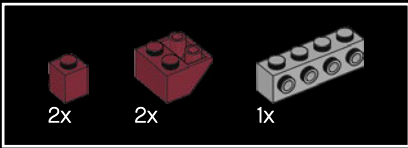

2

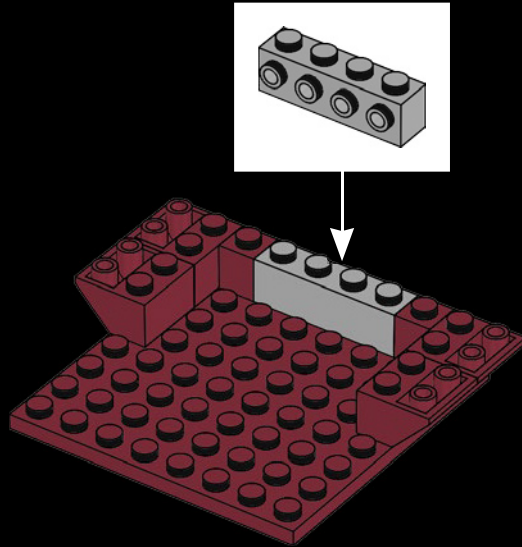

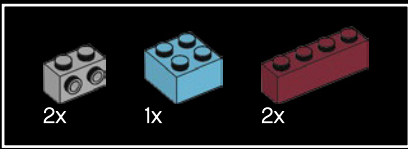

3

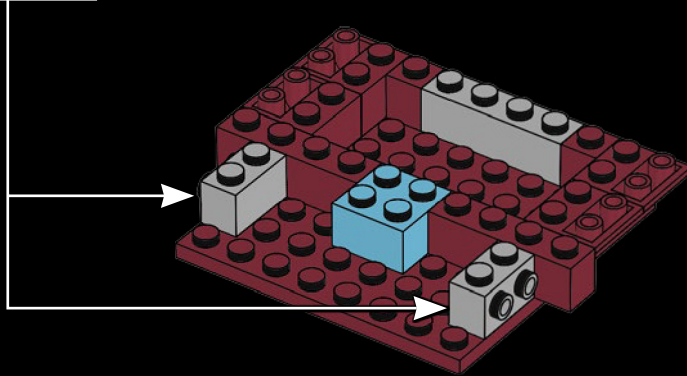
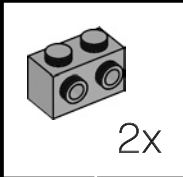

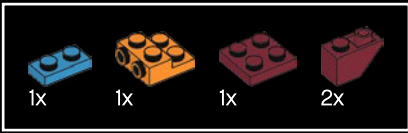

4

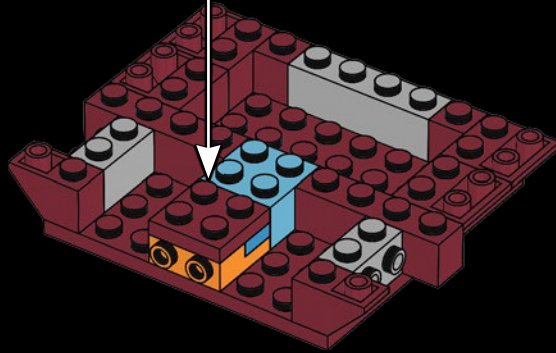
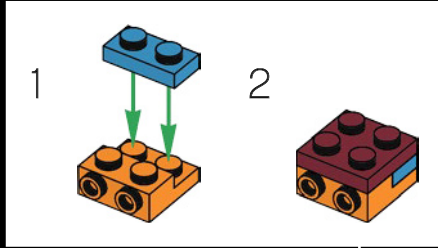

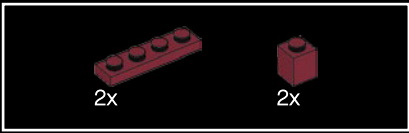

5

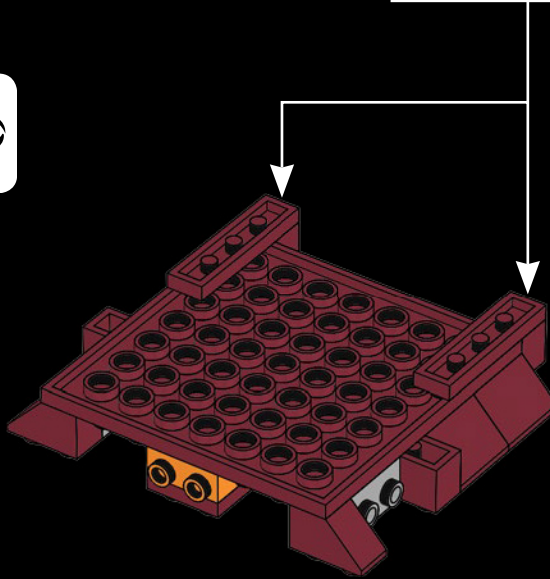
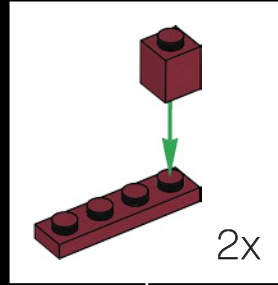



6

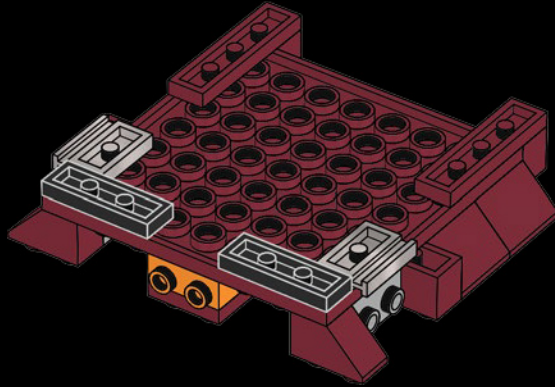



7

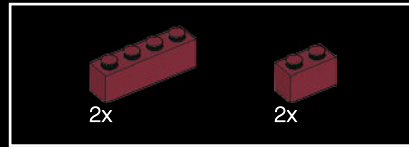
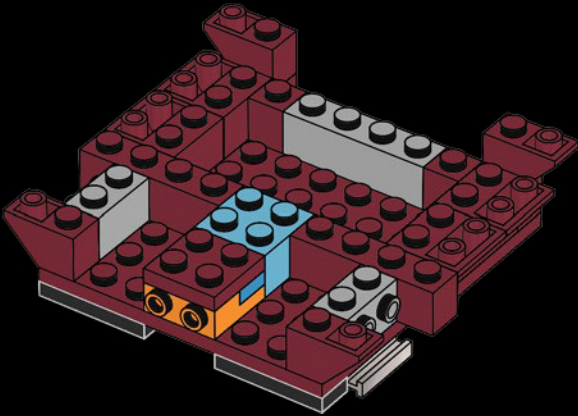

8

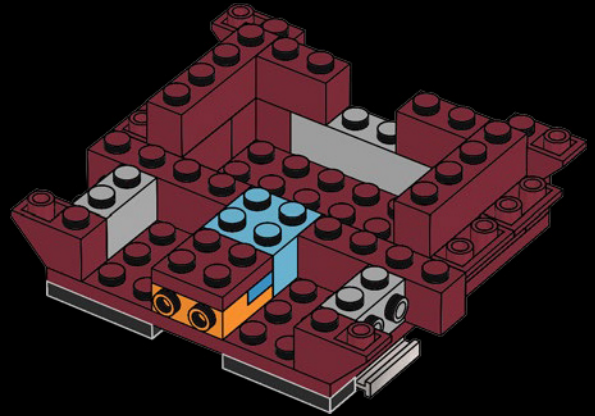

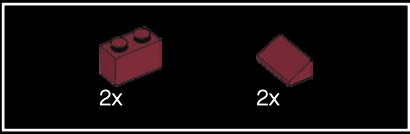

9

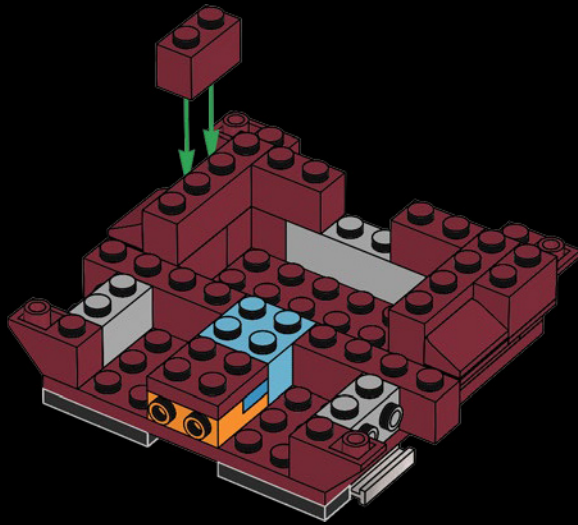

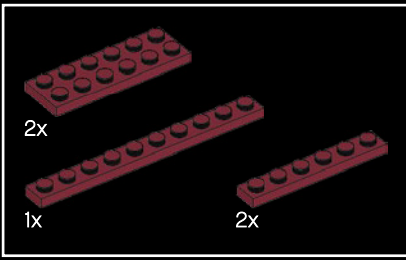

10

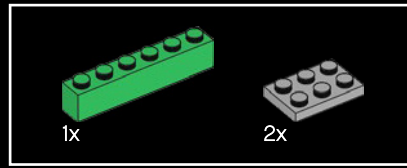
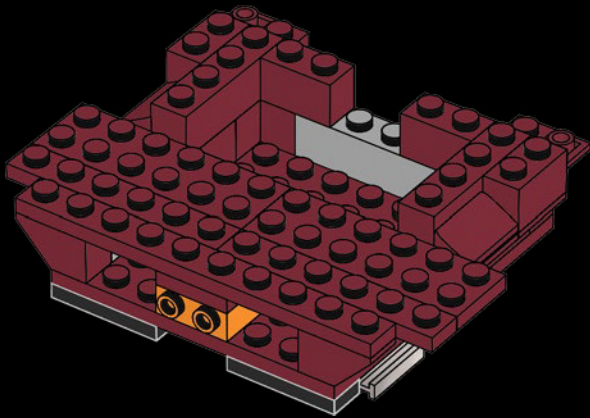

11

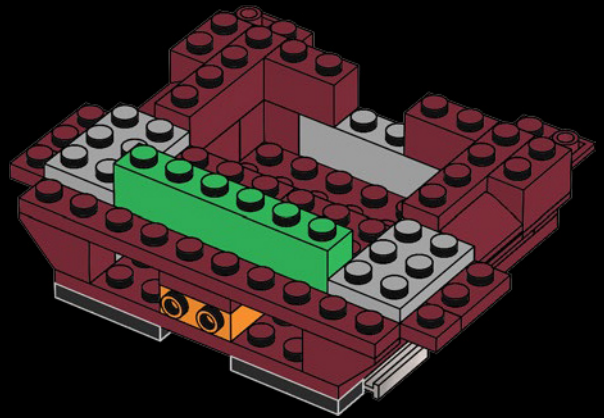



12

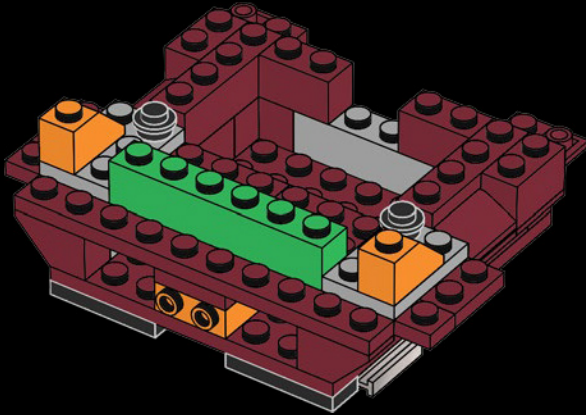



13

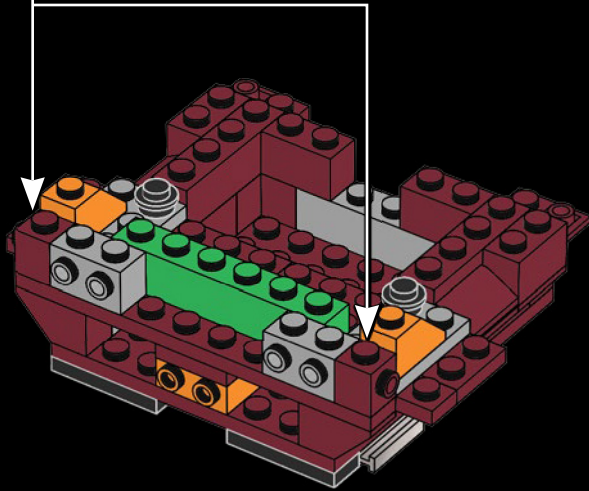
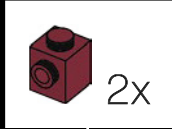

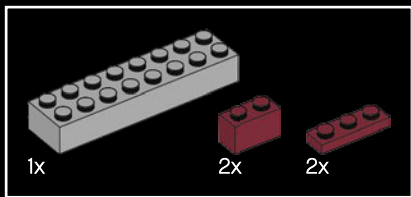

14

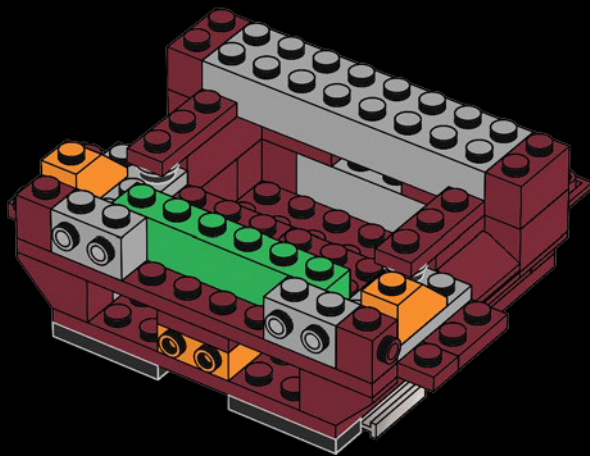

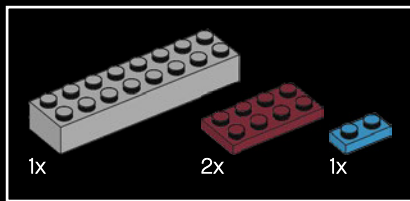

15

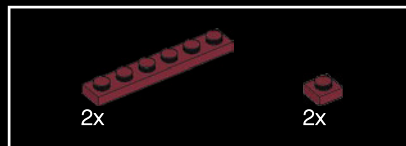
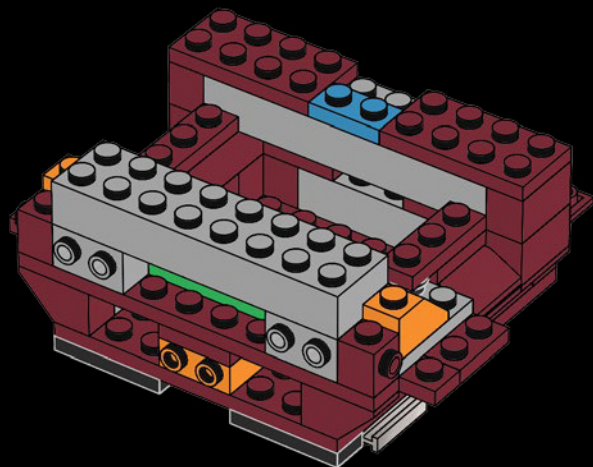

16

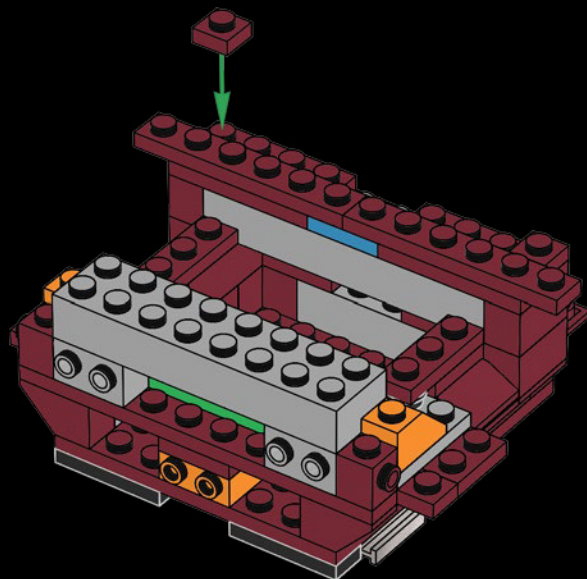



17

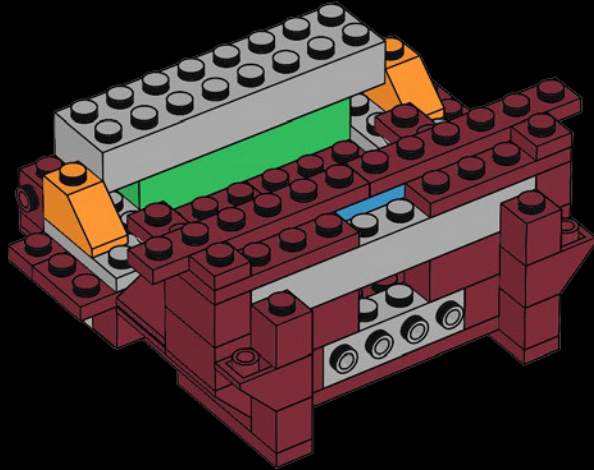

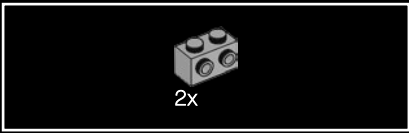

18

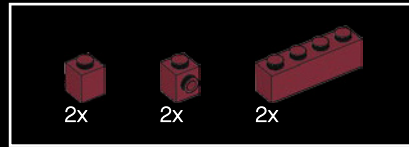
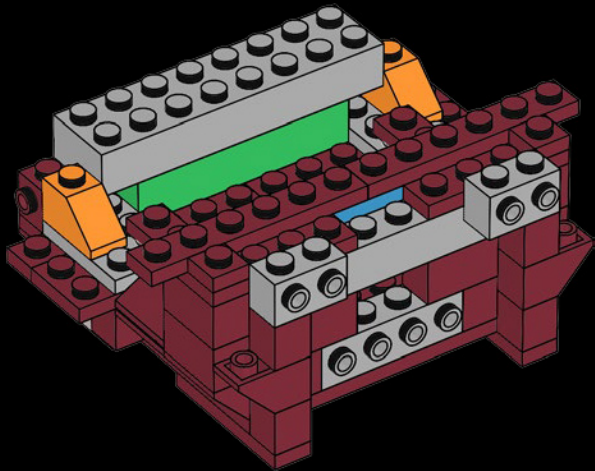

19

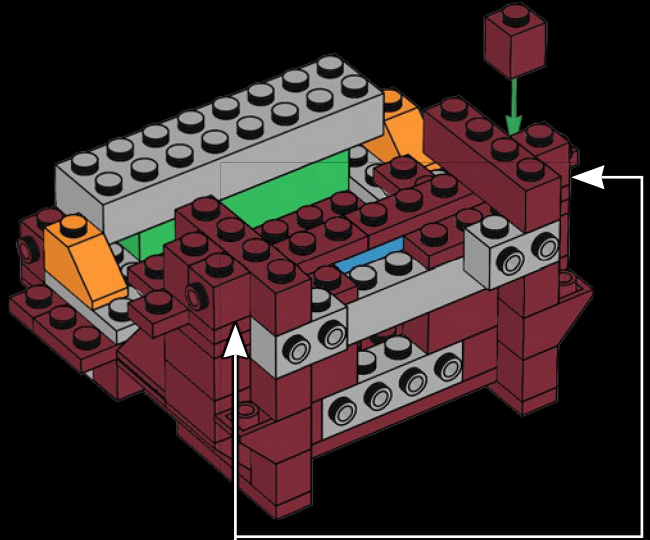

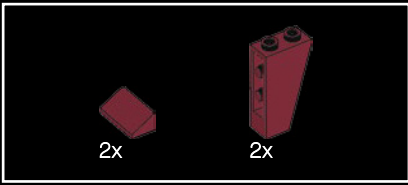

20

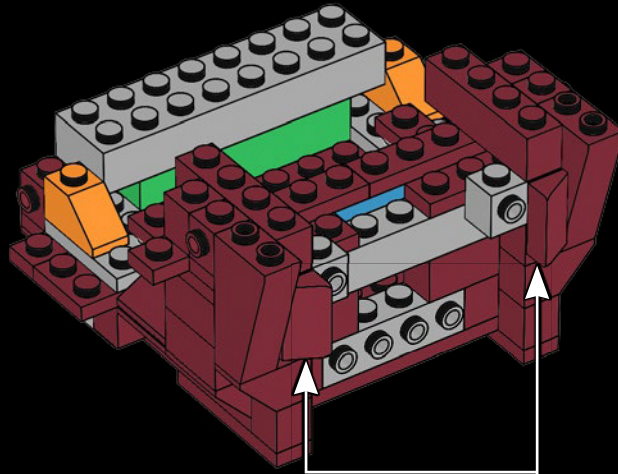

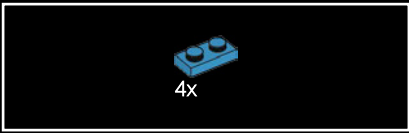

21

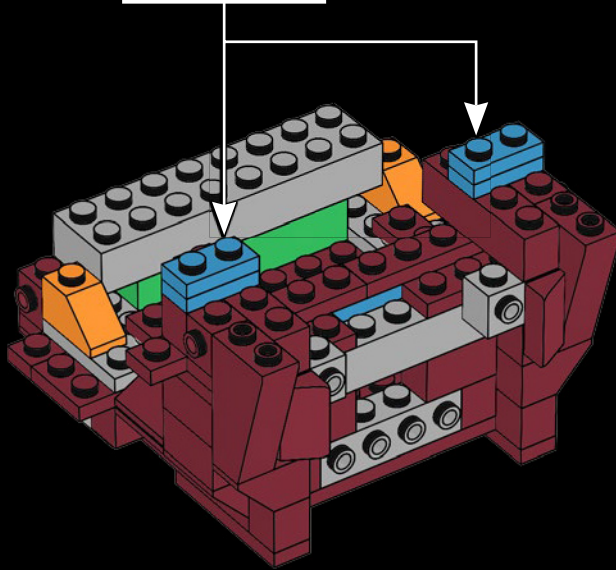
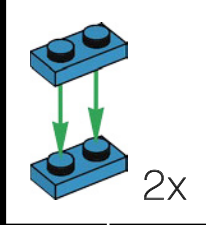

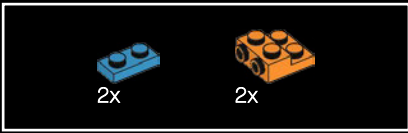

22

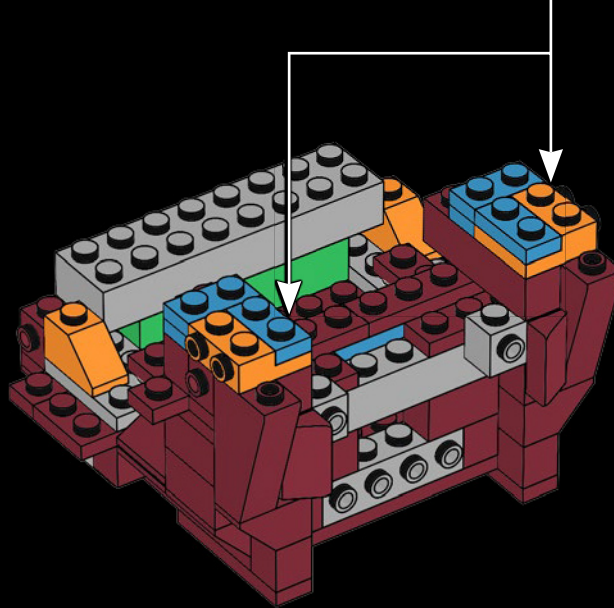
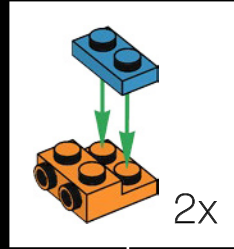

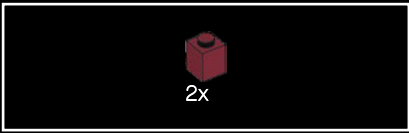

23

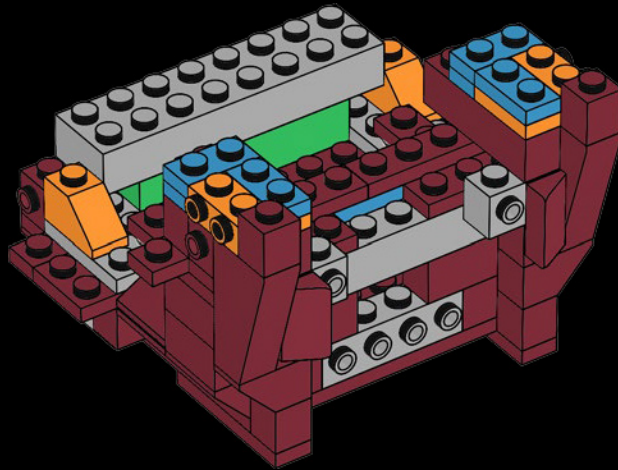

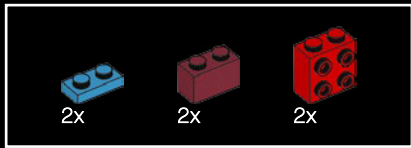

24

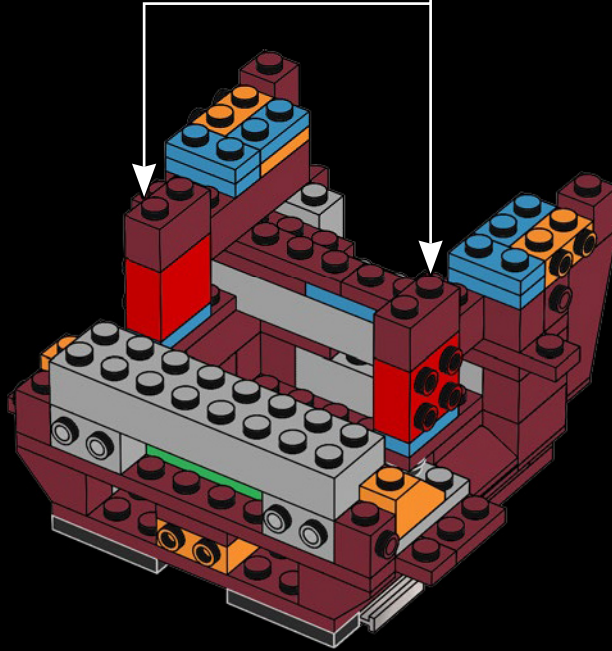
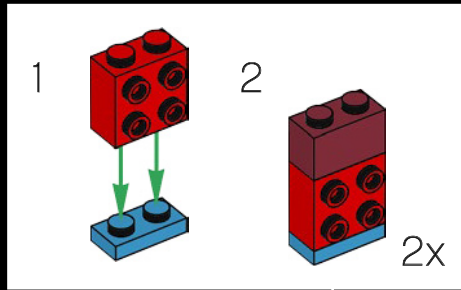

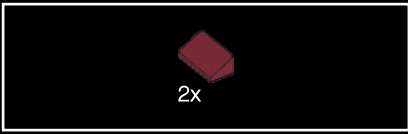

25

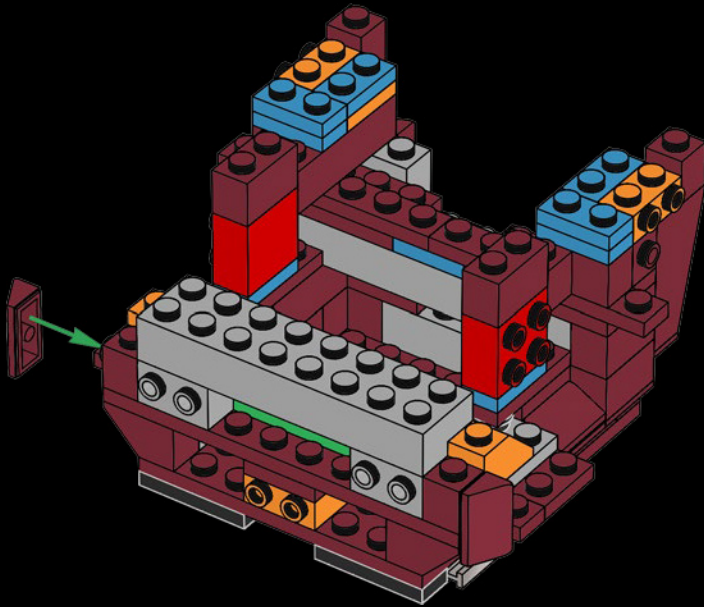



26

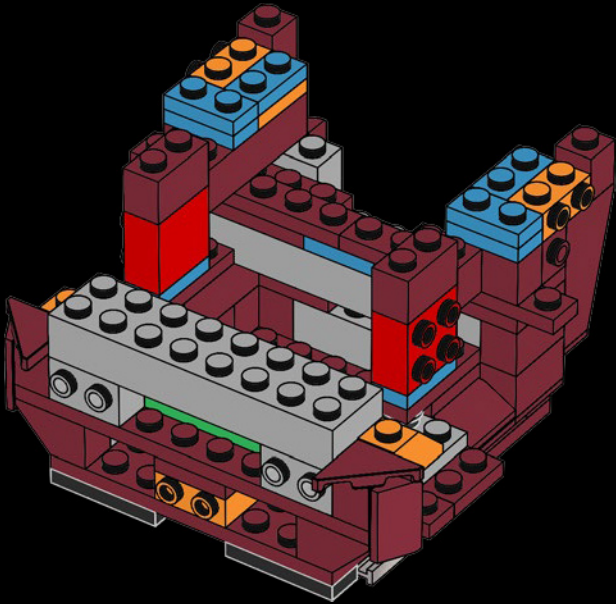



27

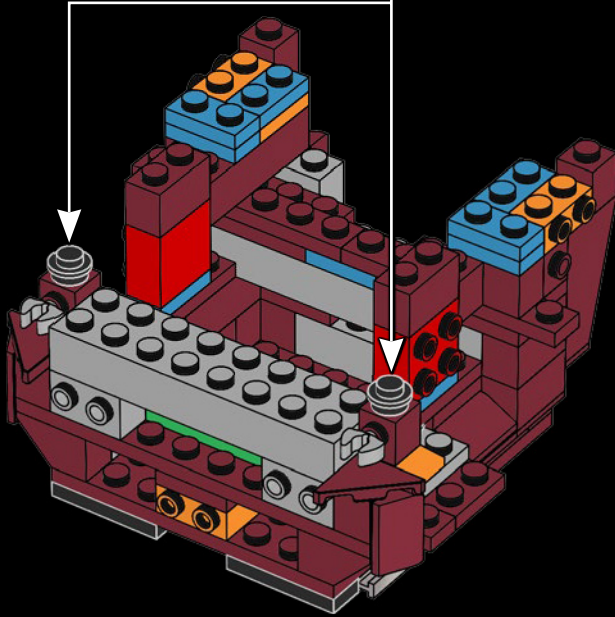
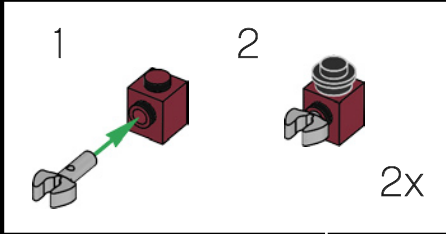

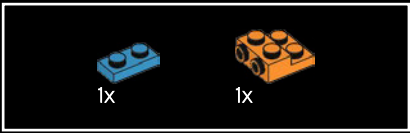

28

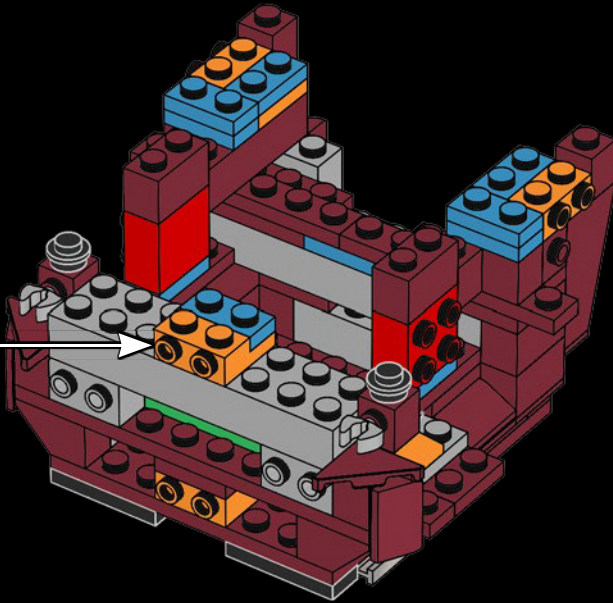
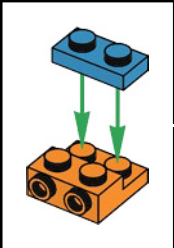

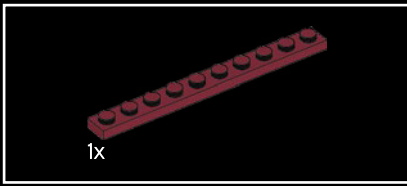

29

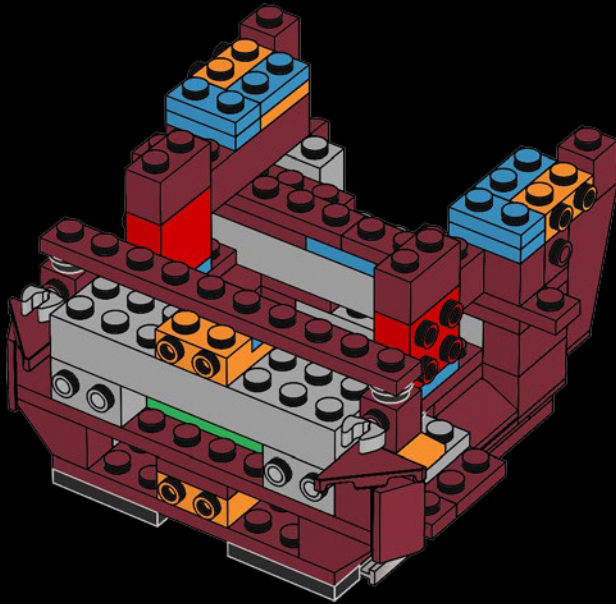

30

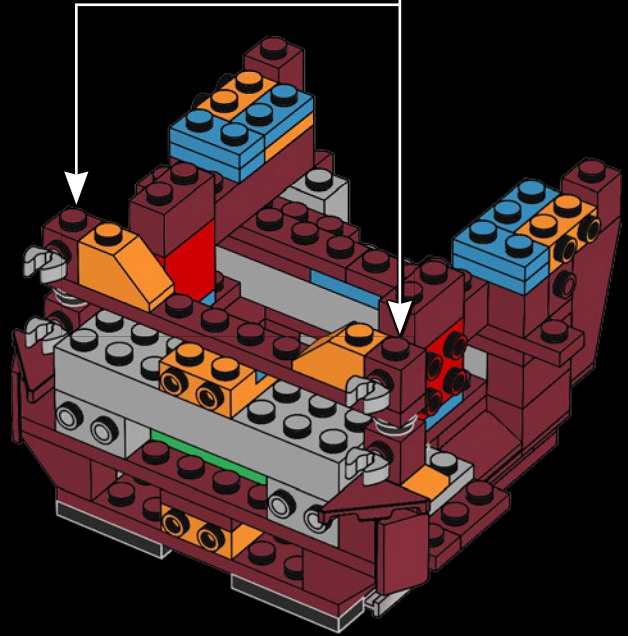
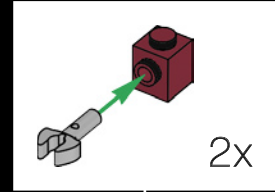

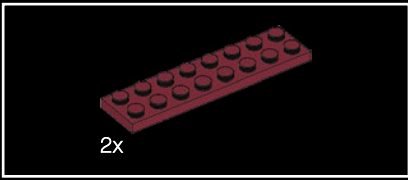

31

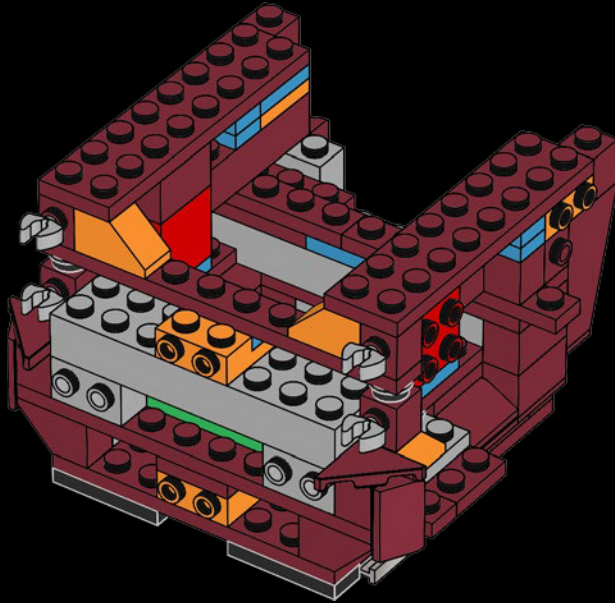

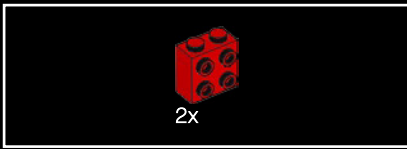

32

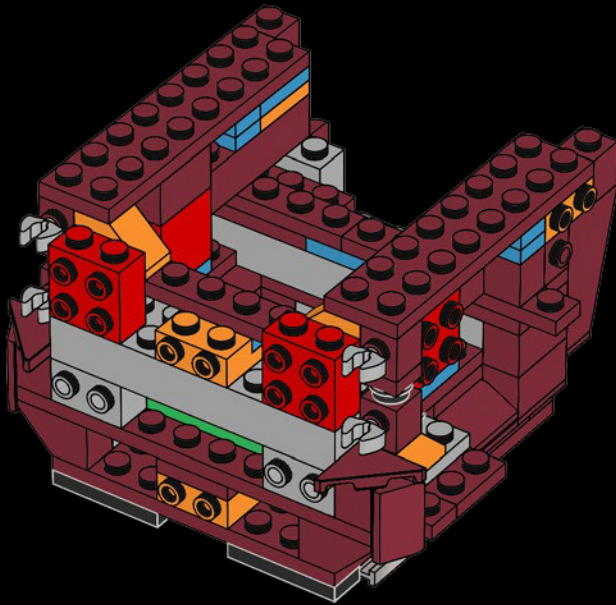

33

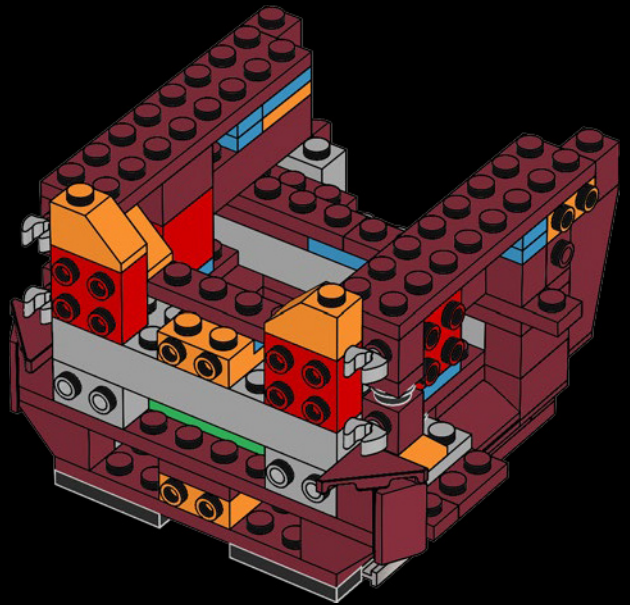

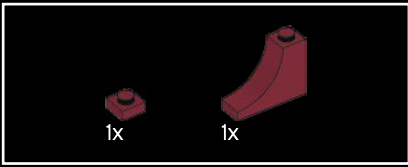

34

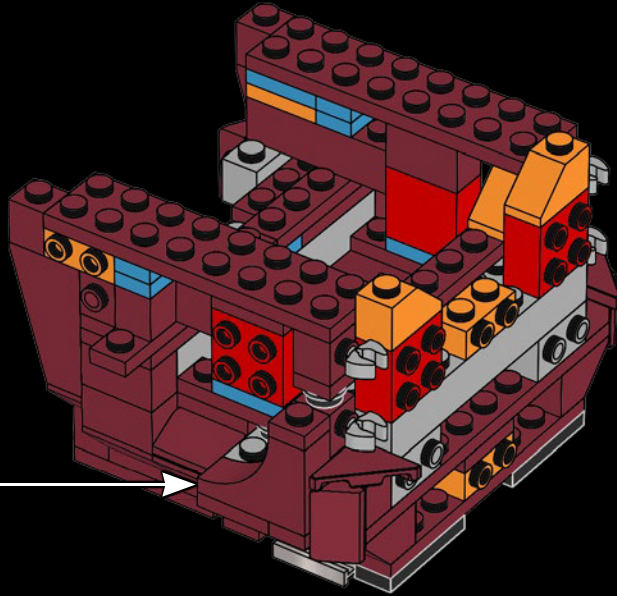
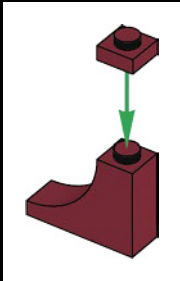

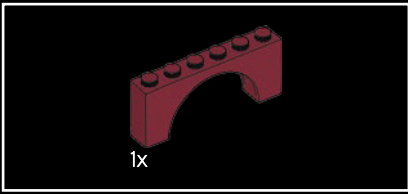

35

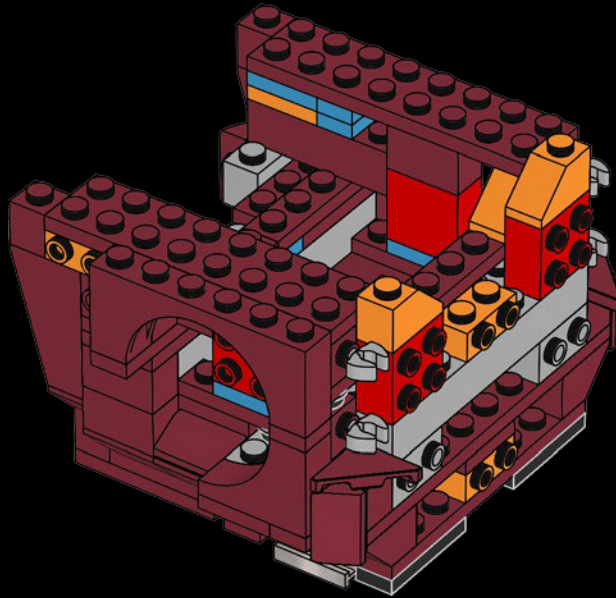

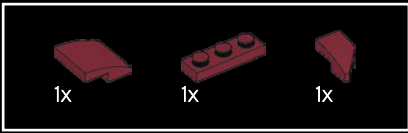

36

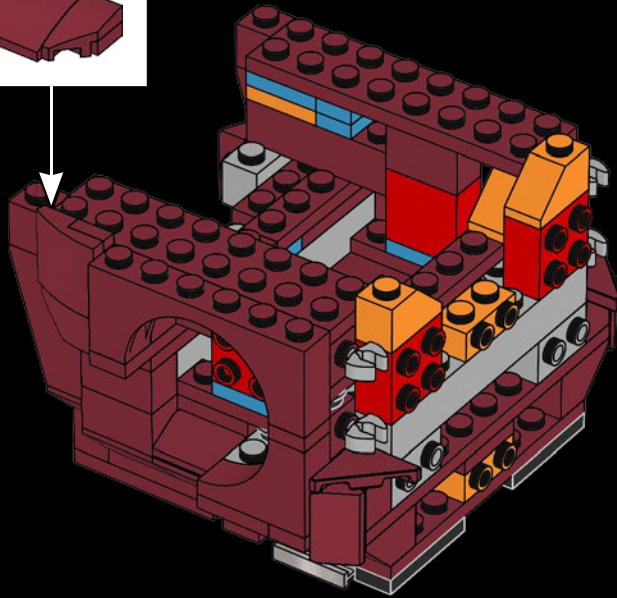
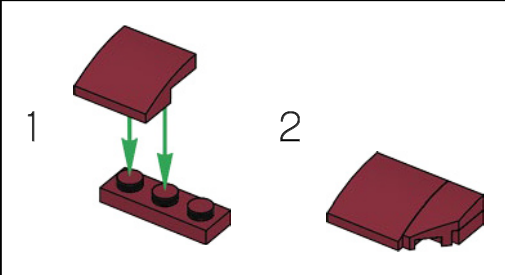

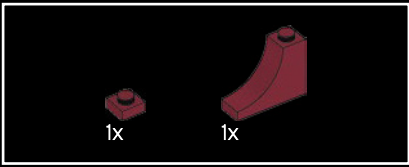

37

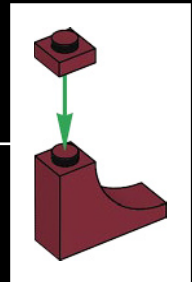
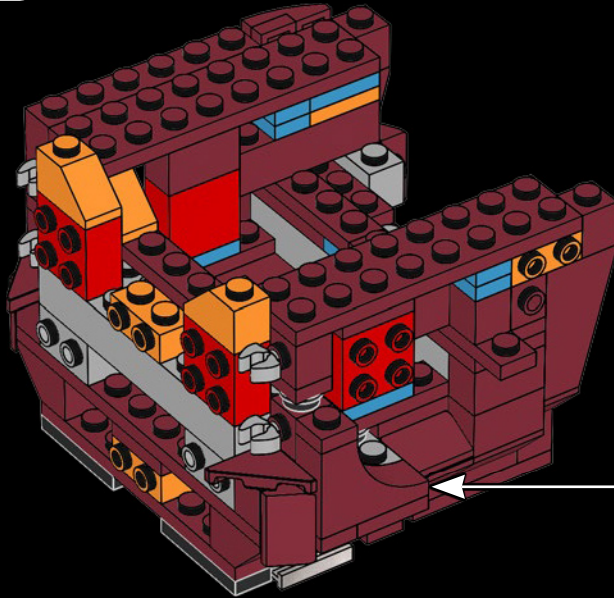

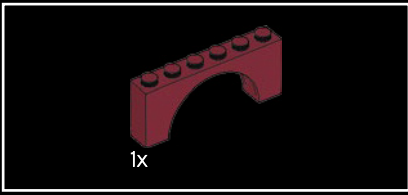

38

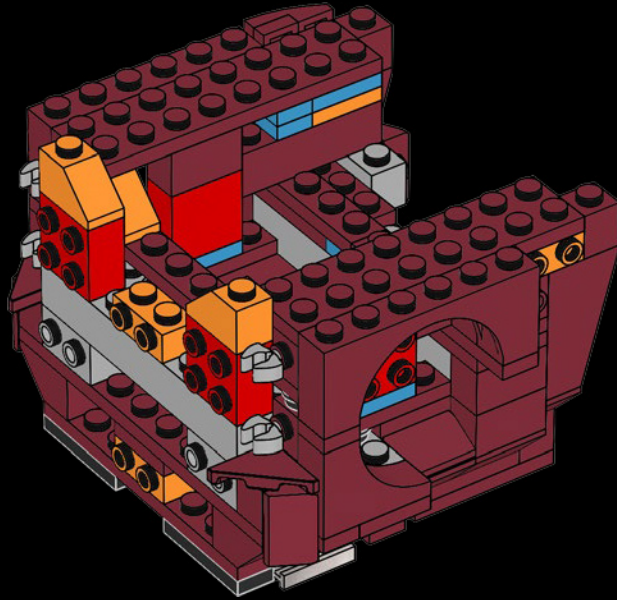



39

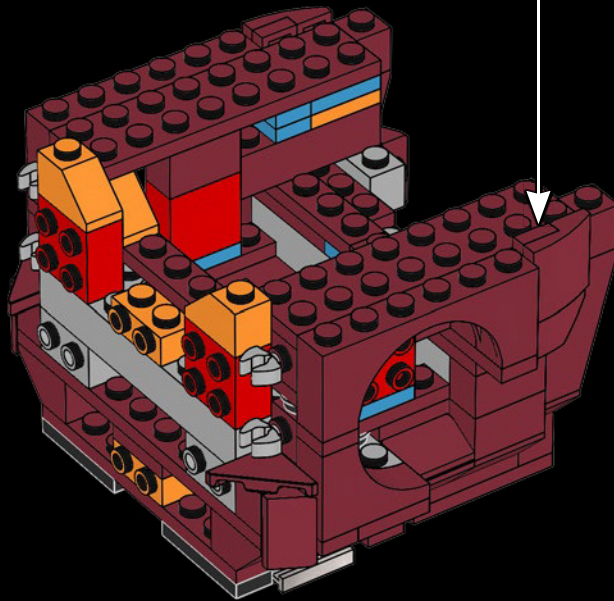
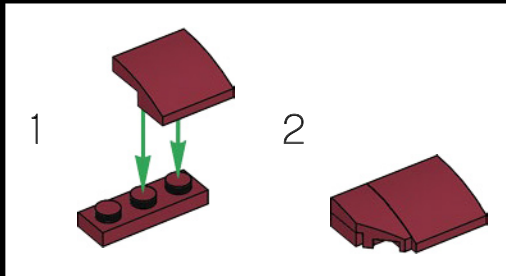

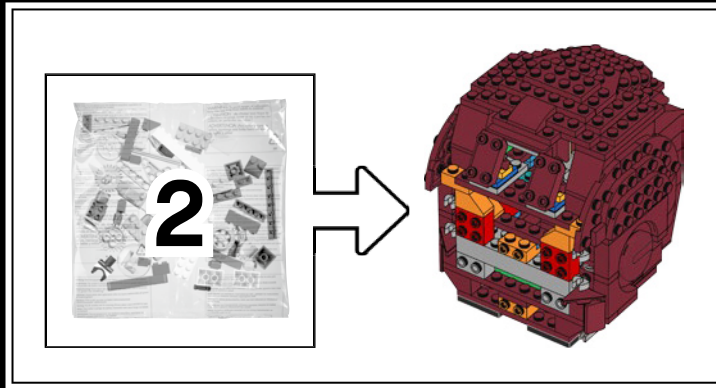

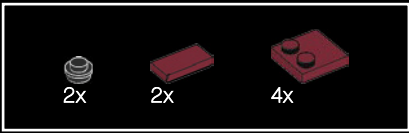

40

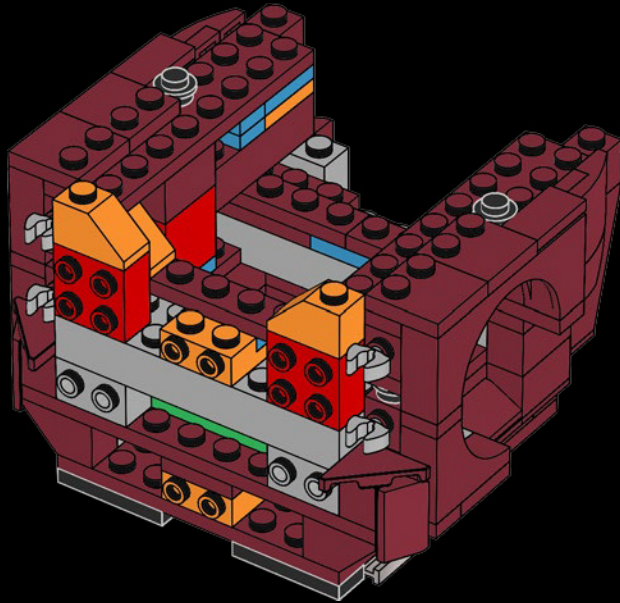

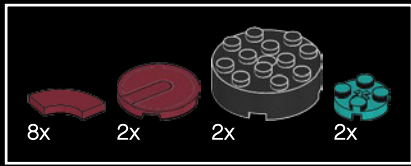

41

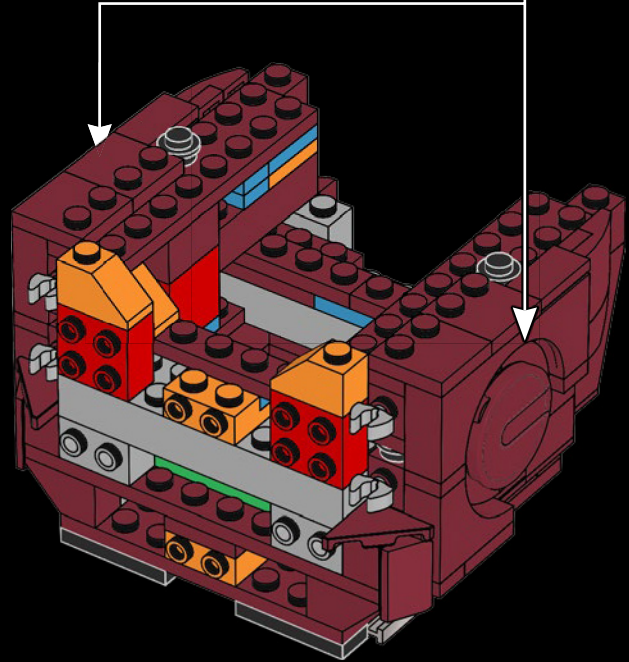
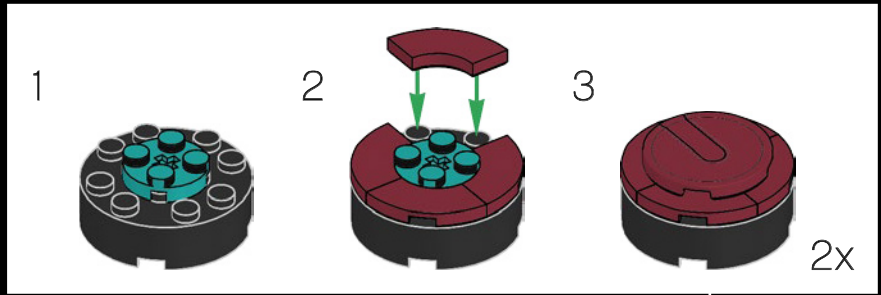

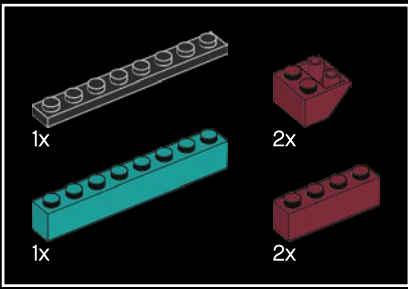

42

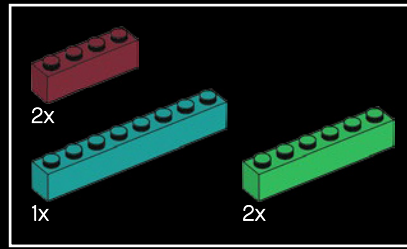
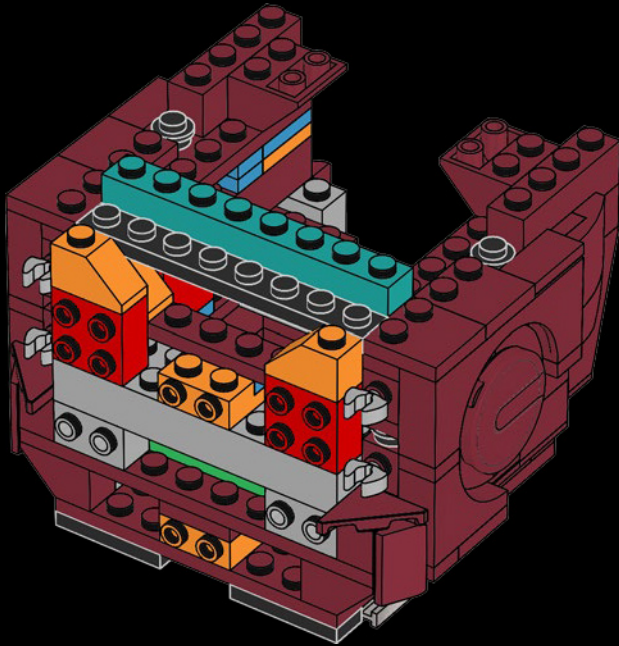

43

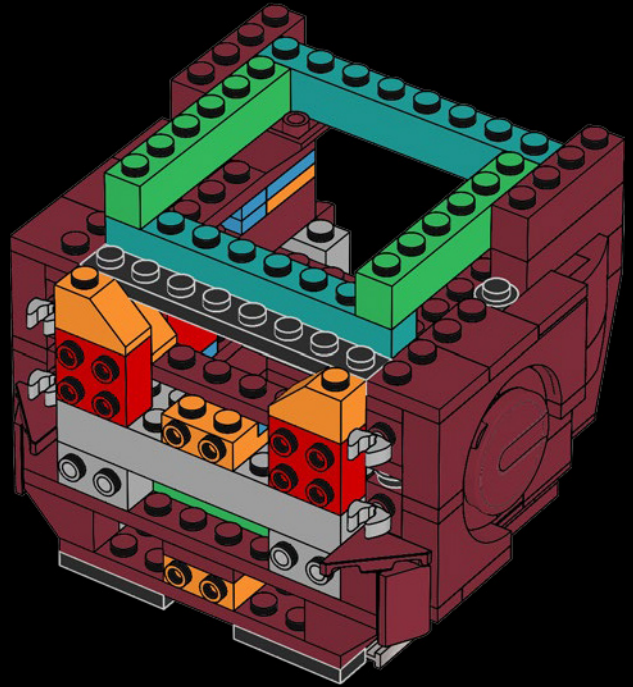

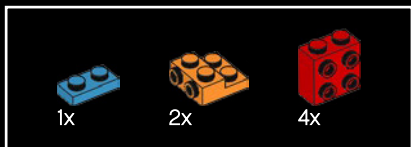

44

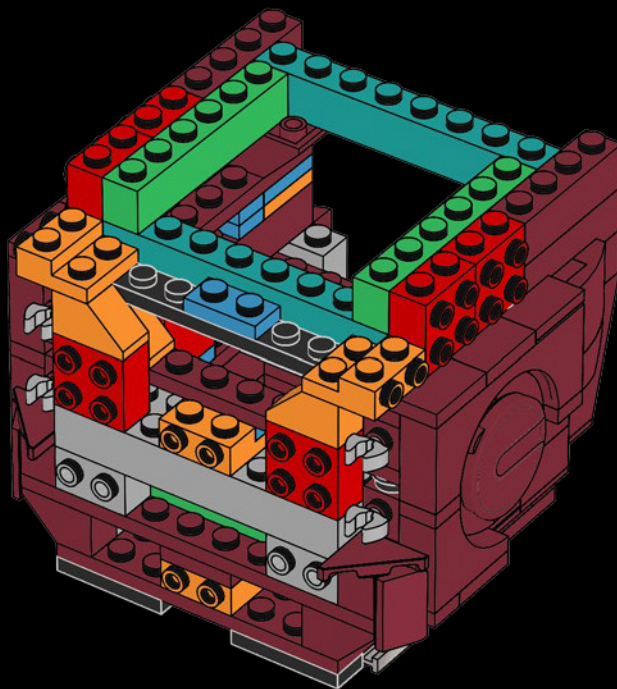

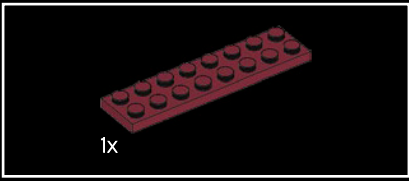

45

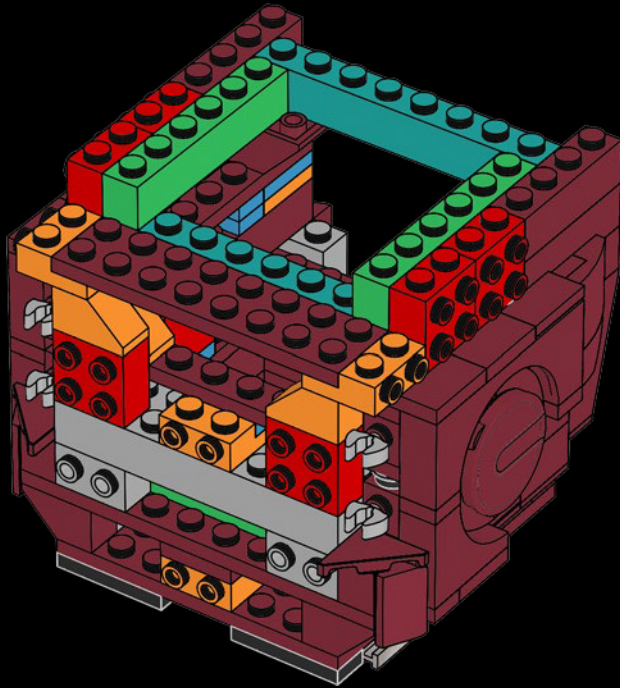

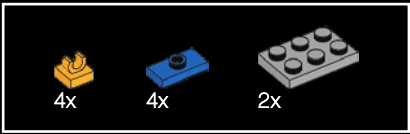

46

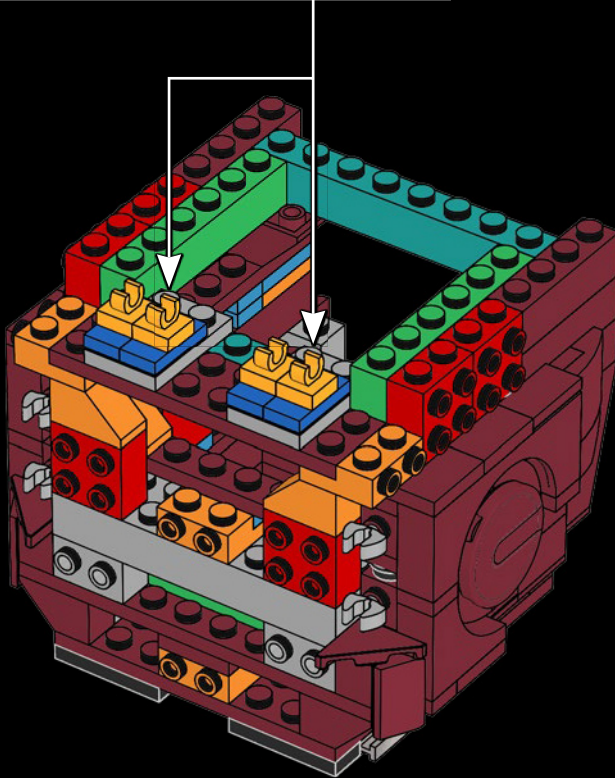
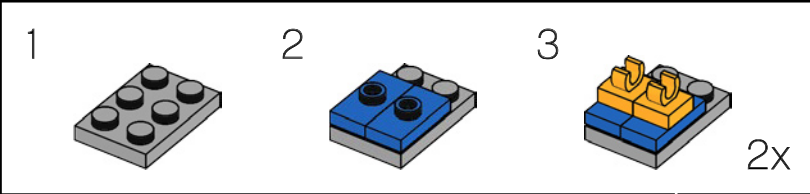

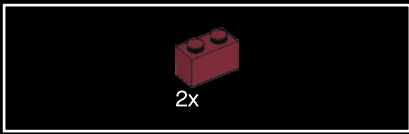

47

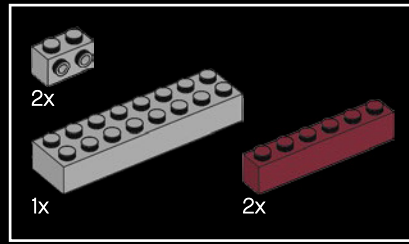
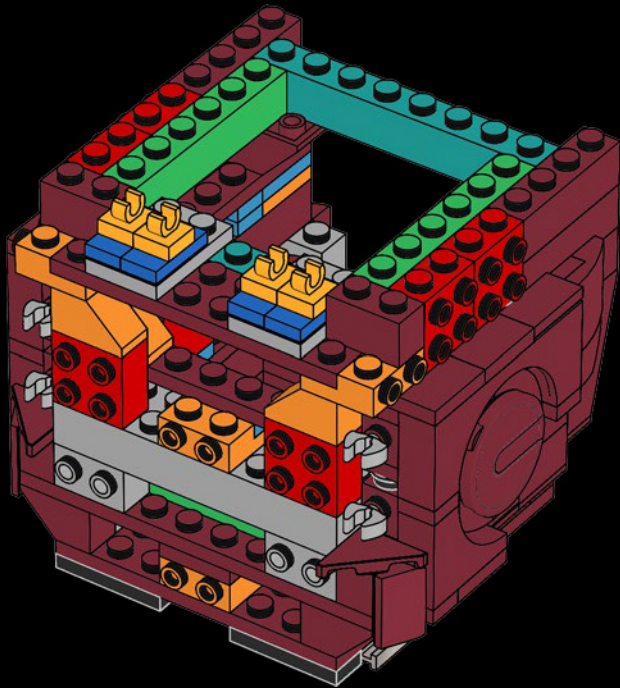

48

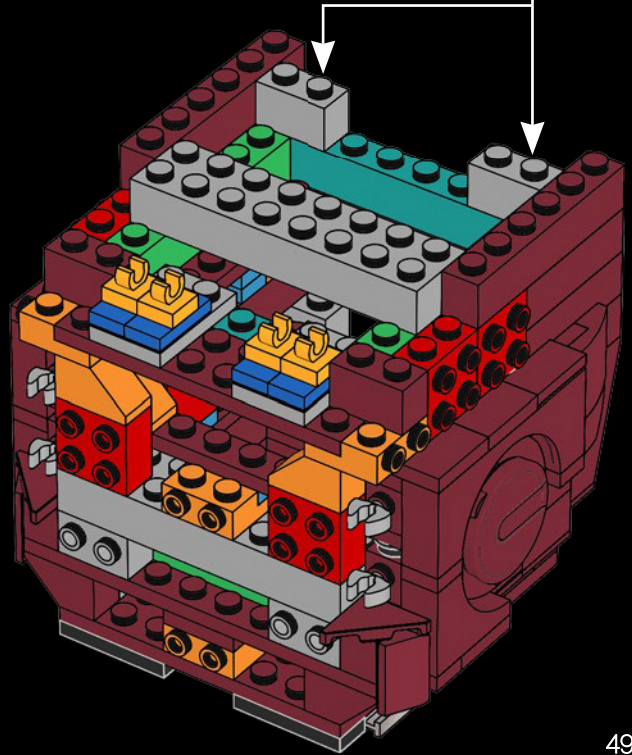
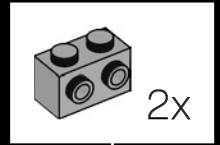

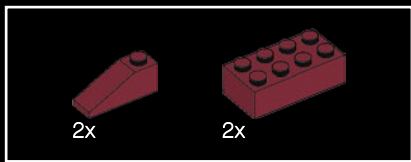

49

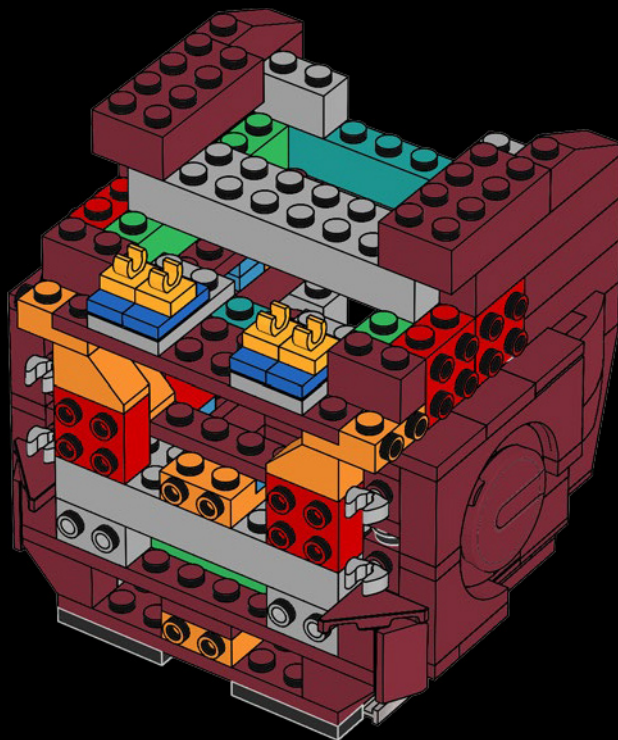

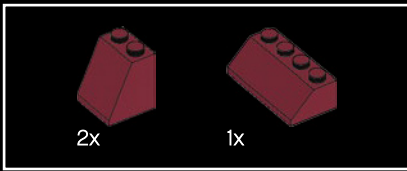

50

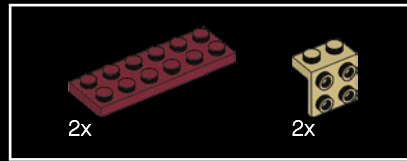
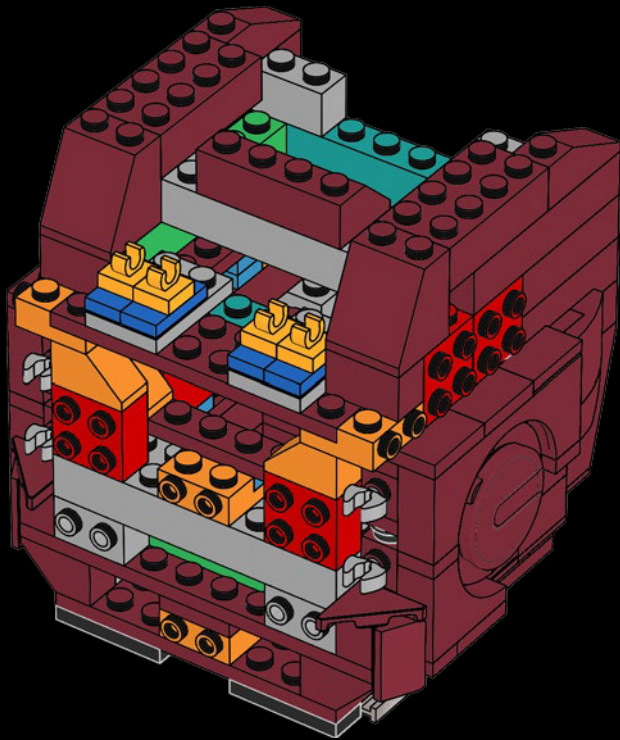

51

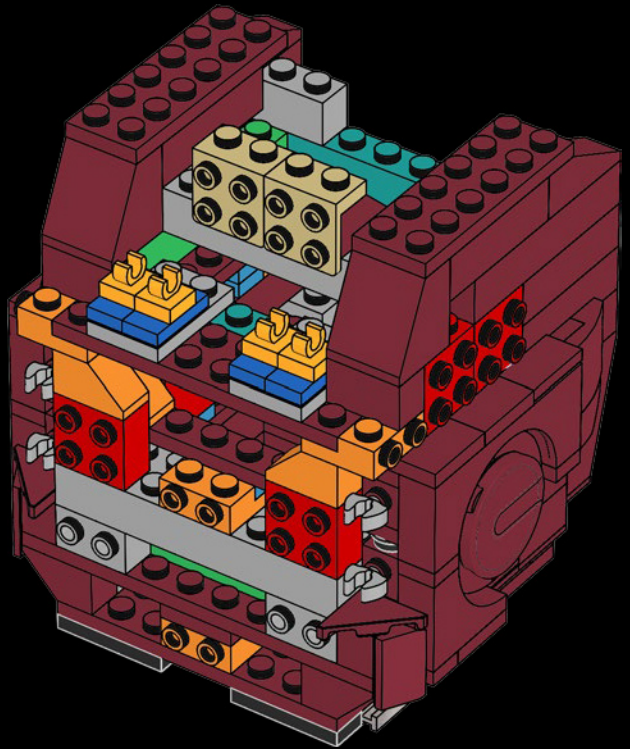

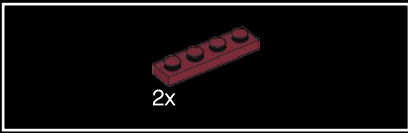

52

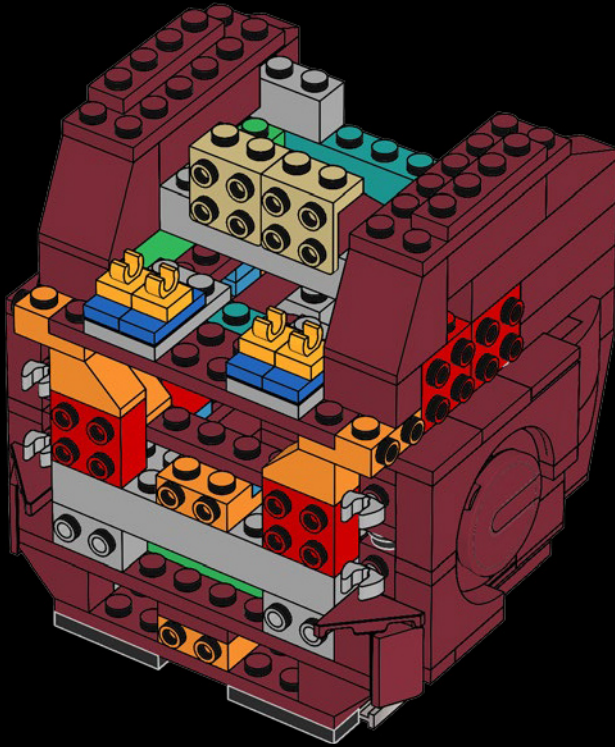

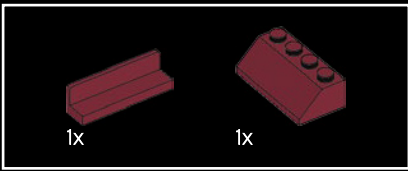

53

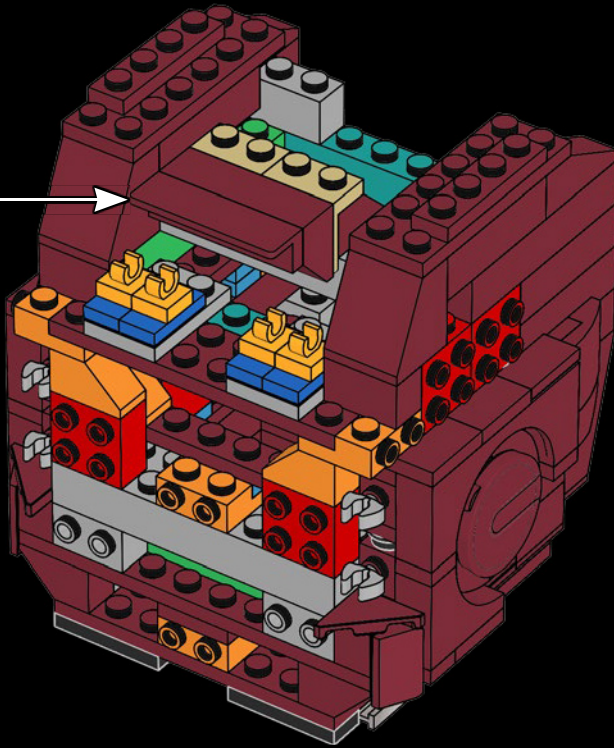
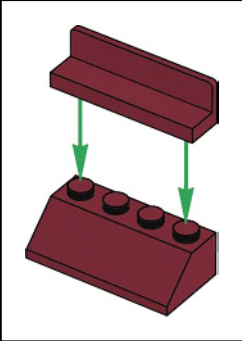



54

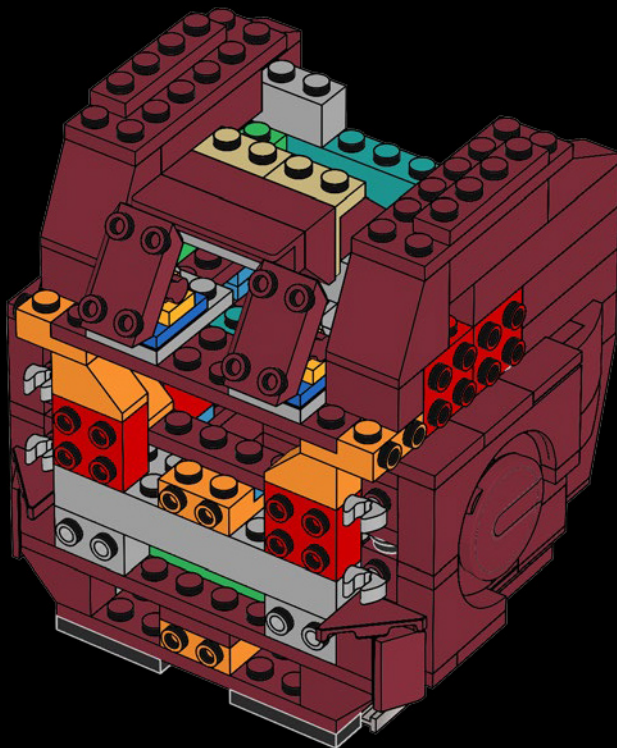

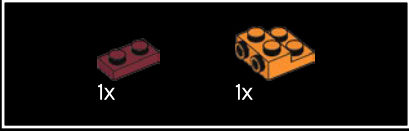
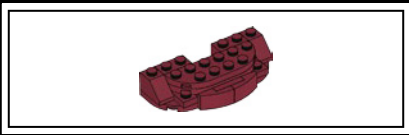

55

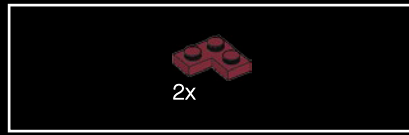
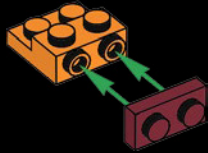

56

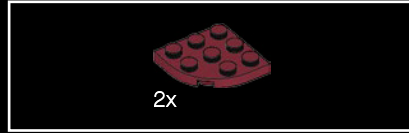
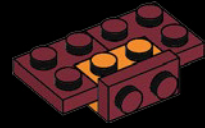

57

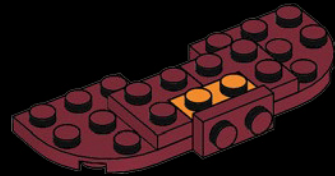

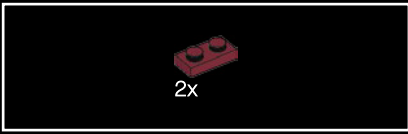

58

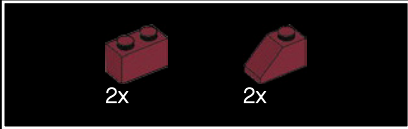
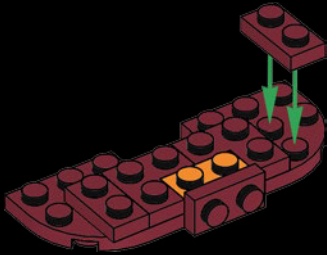

59

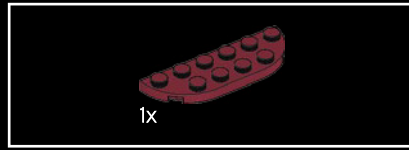
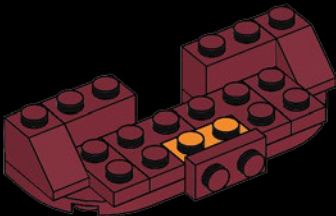

60

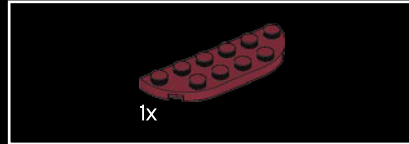
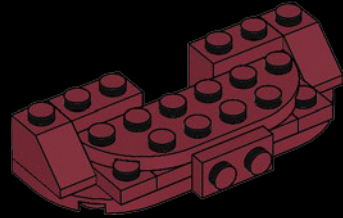

61

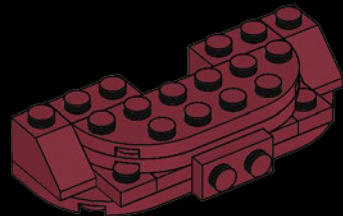

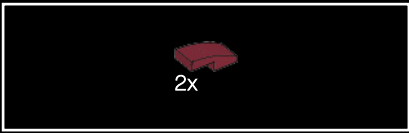

62

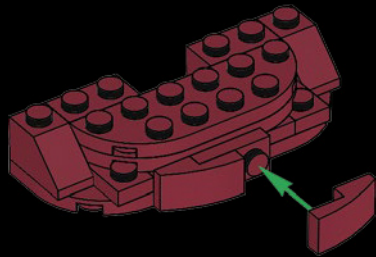

63

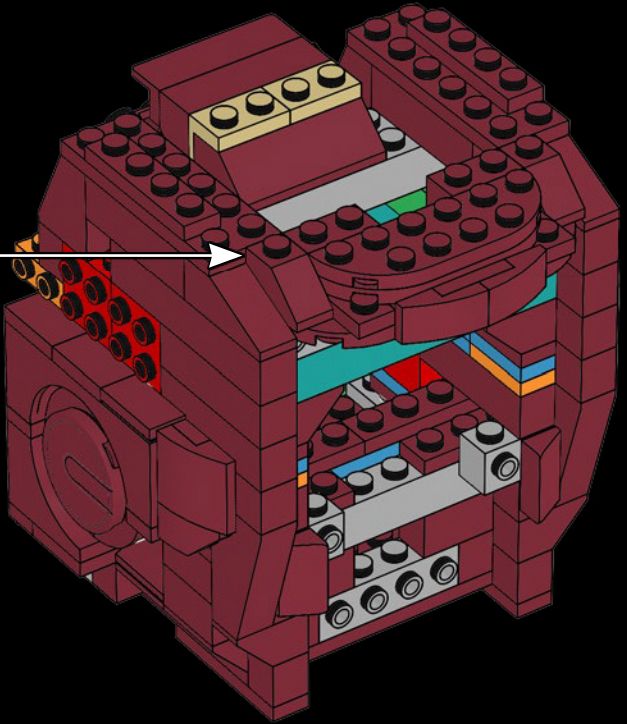

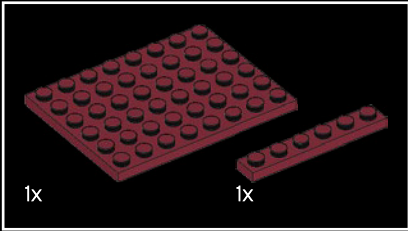
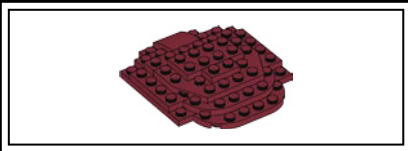

64

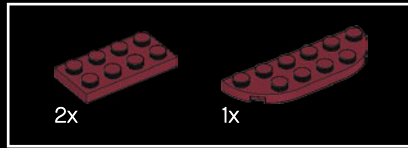
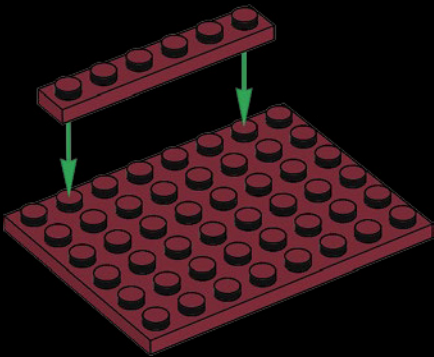

65

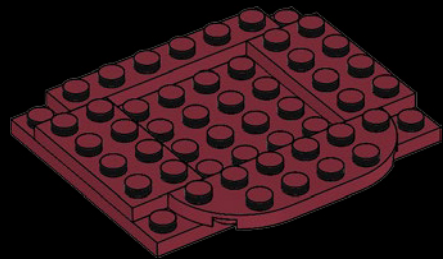

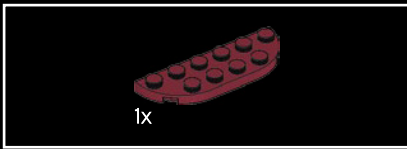

66

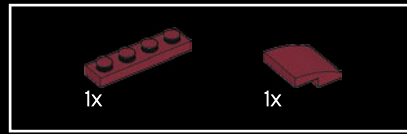
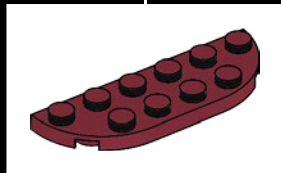
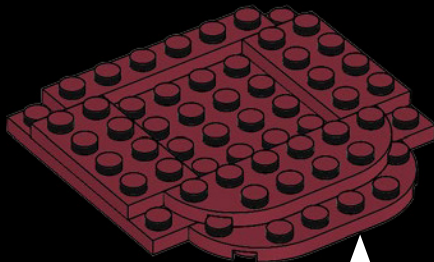

67

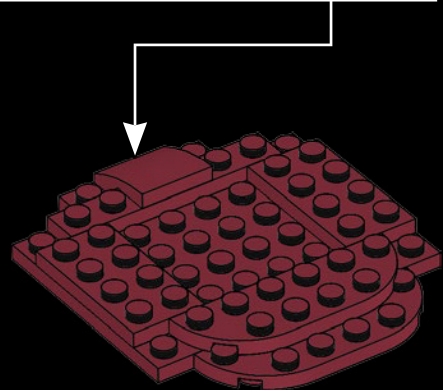
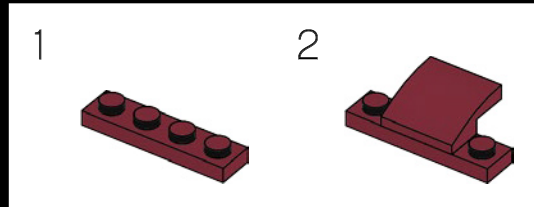

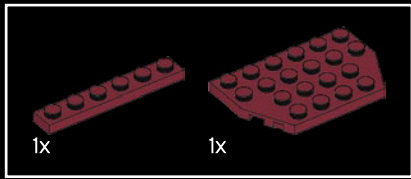

68

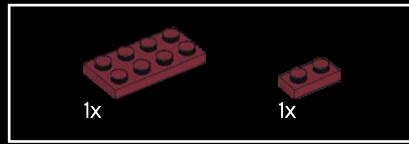
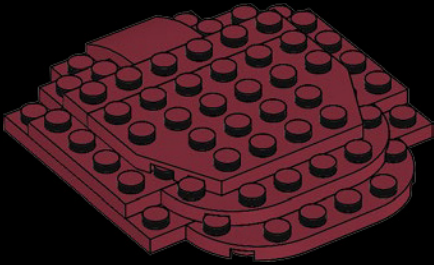

69

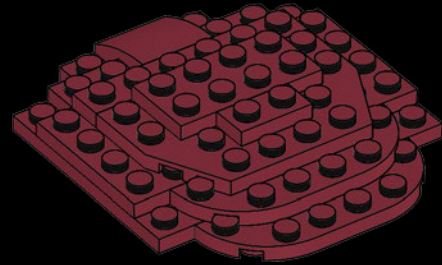

70

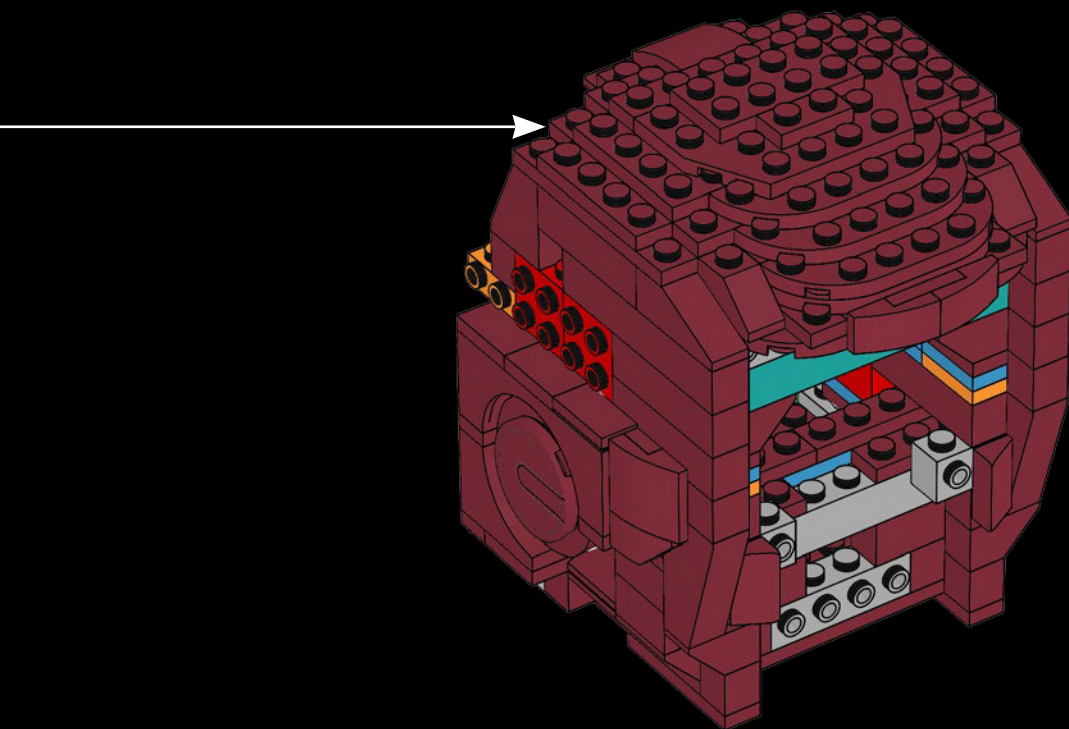

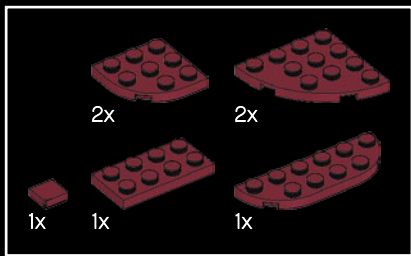

71

1



2

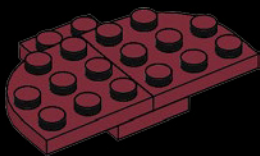

3

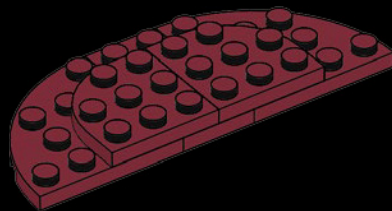

4

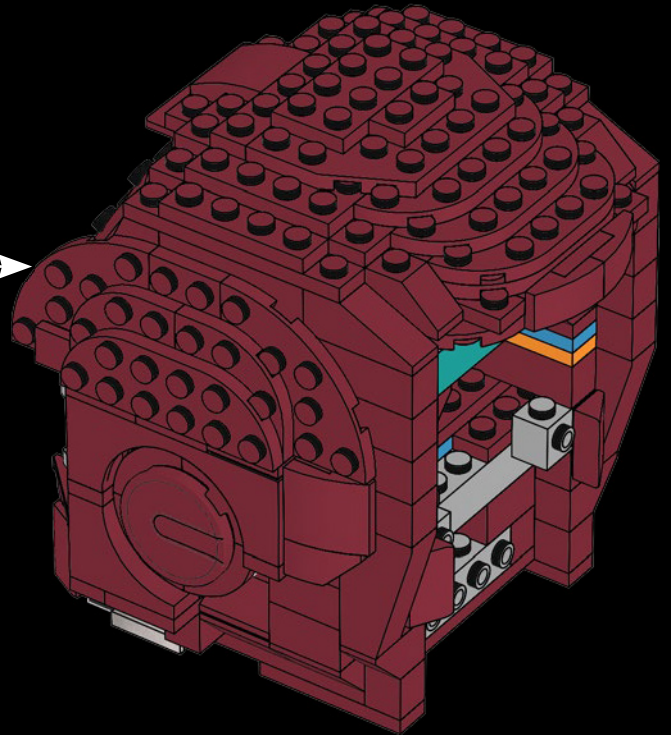
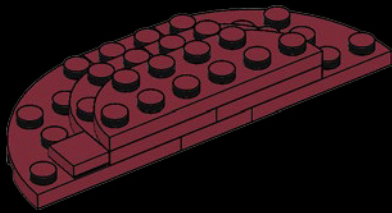

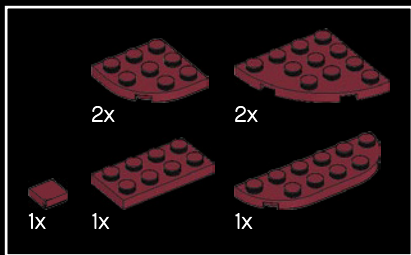

72

1



2

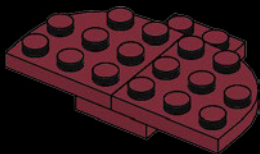

3

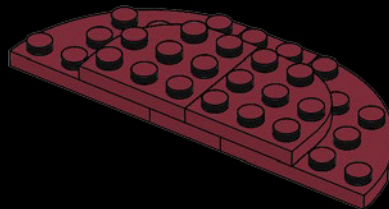

4

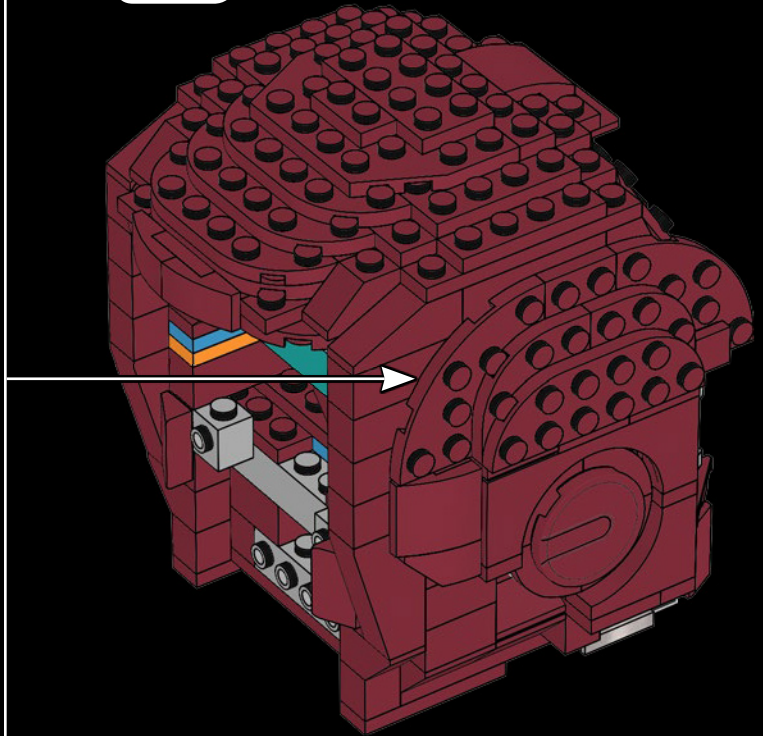
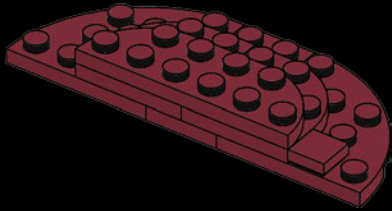

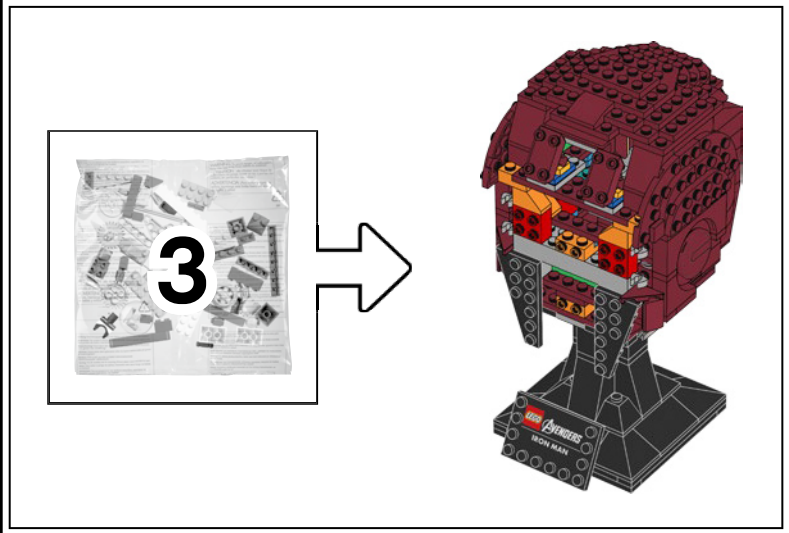

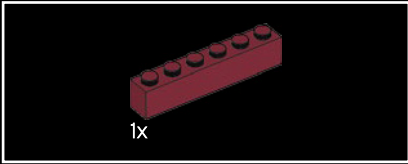
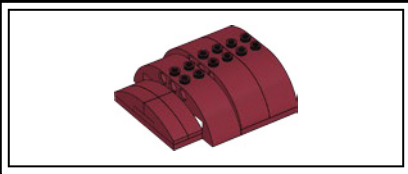

73

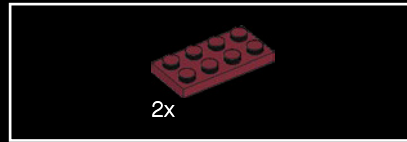
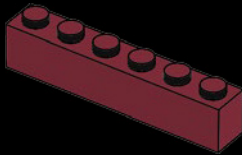

74

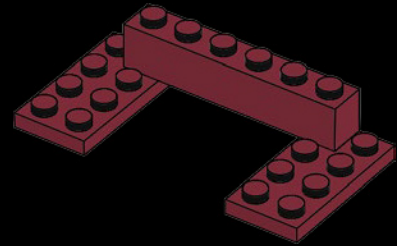

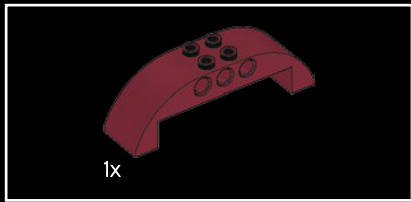

75

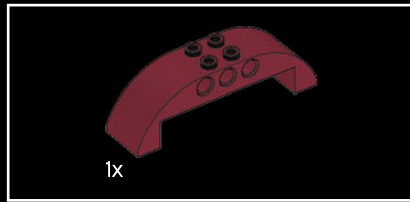
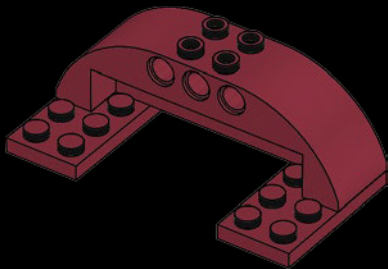

76

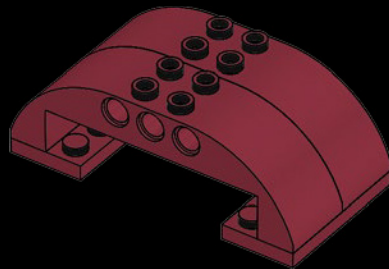

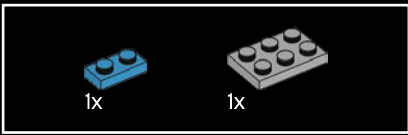

77

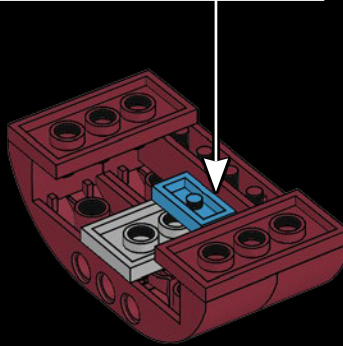
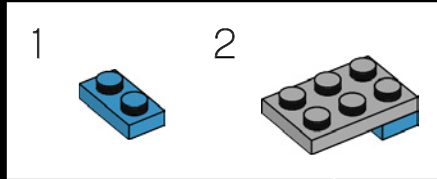

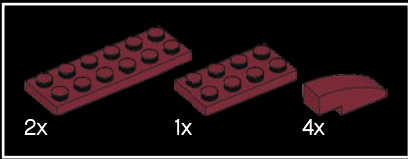

78

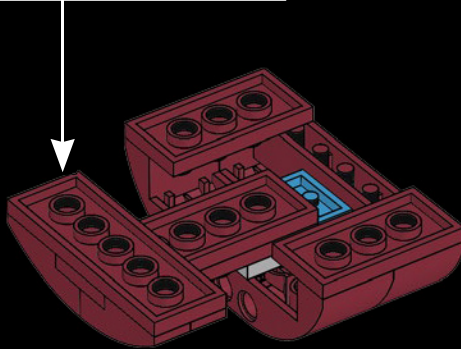
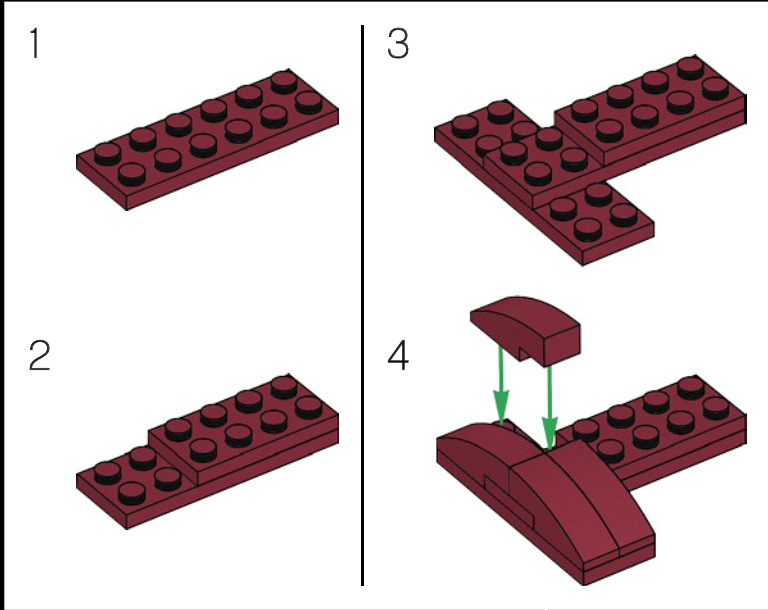

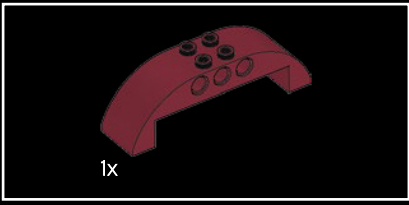

79

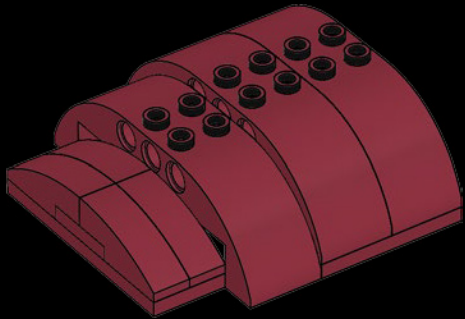

80

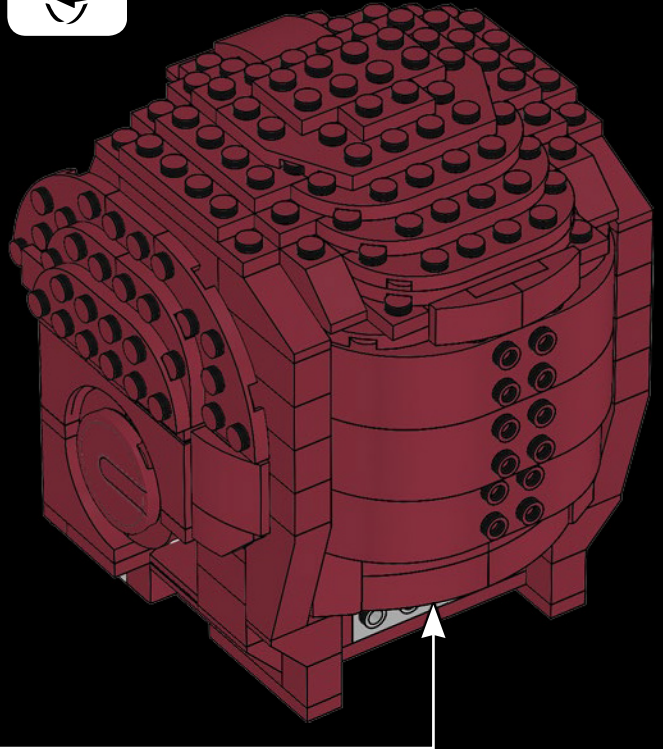

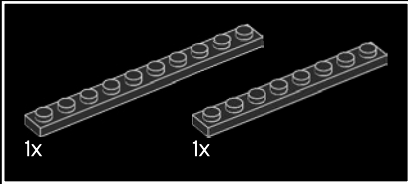
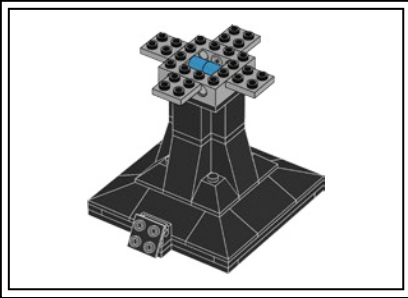

81

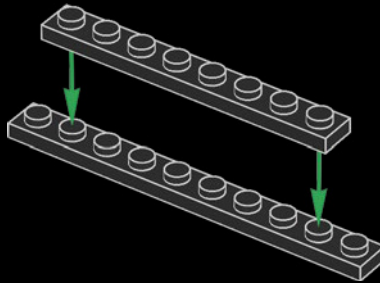

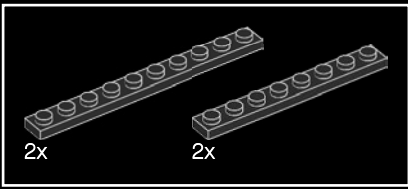

82

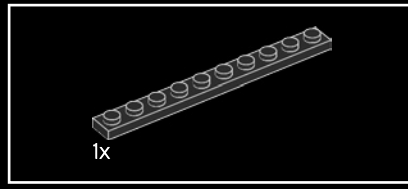
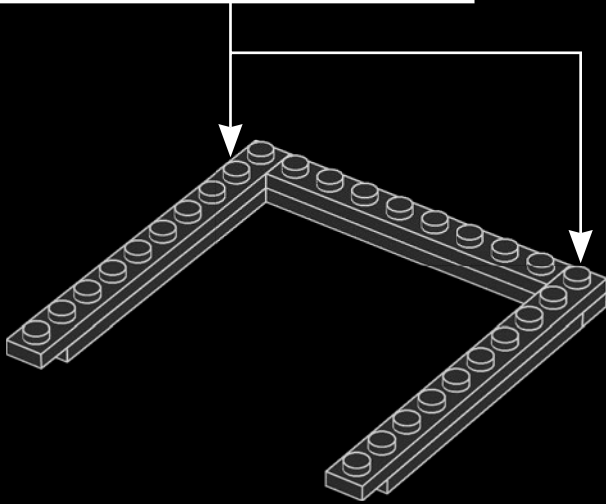
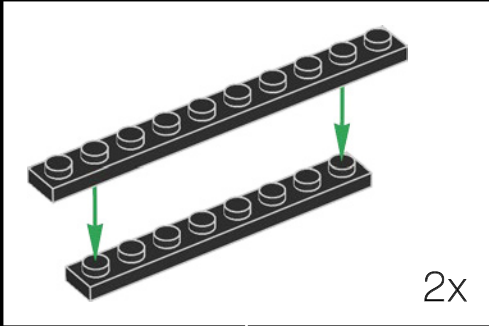

83

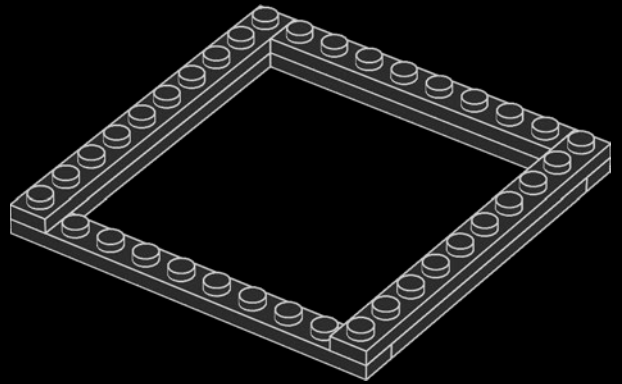

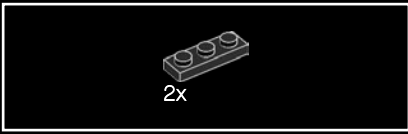

84

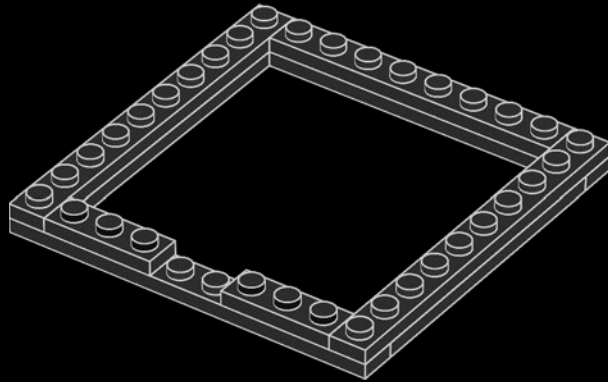

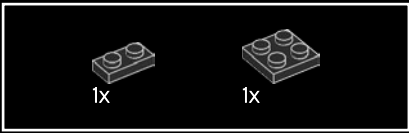

85

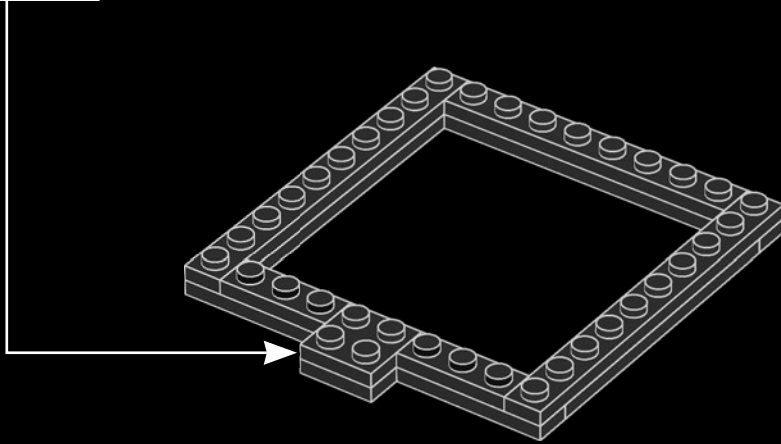
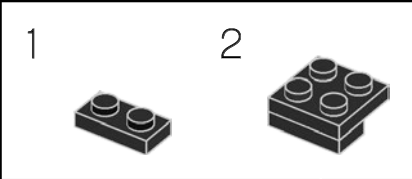

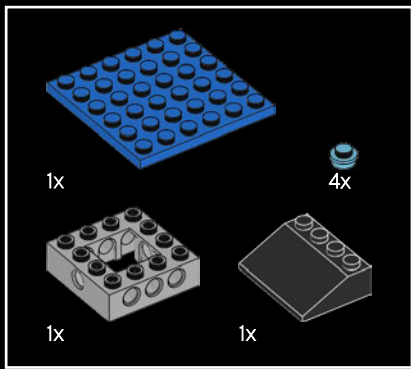

86

1

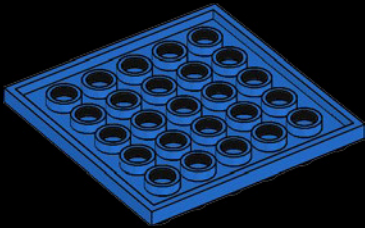

2

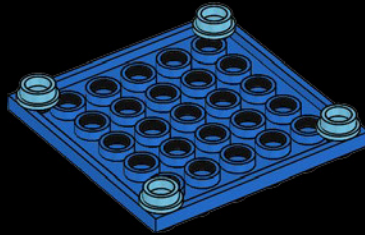

3

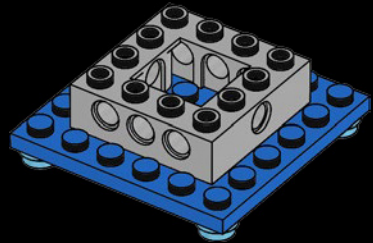

4

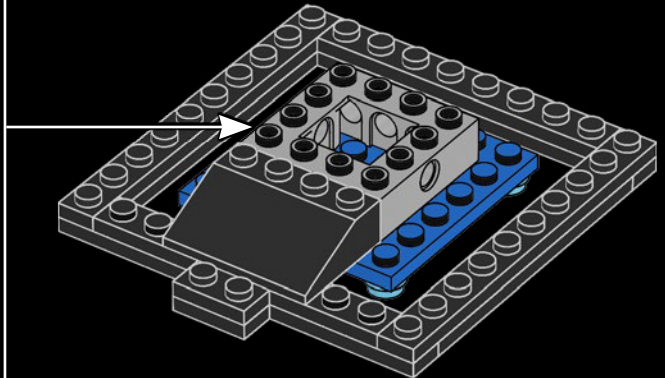
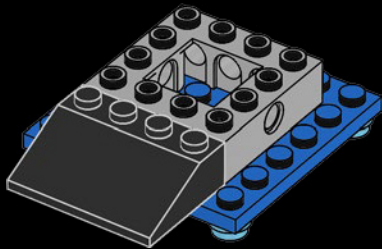

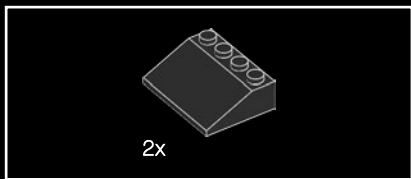

87

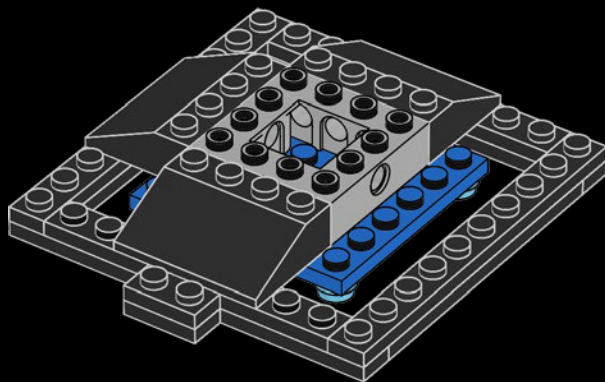

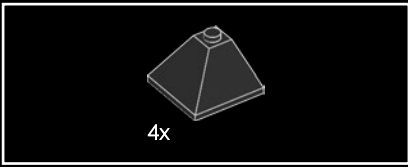

88

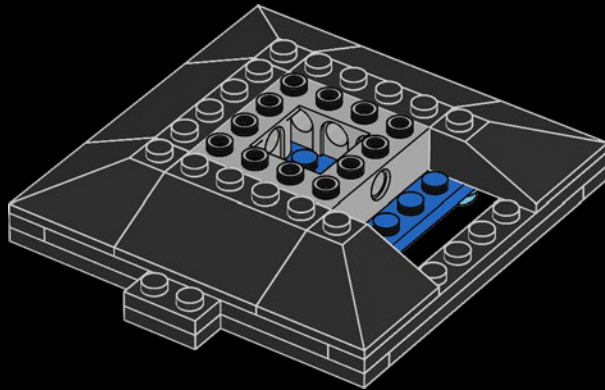

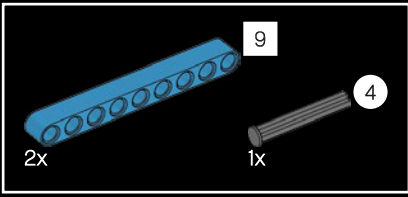

89

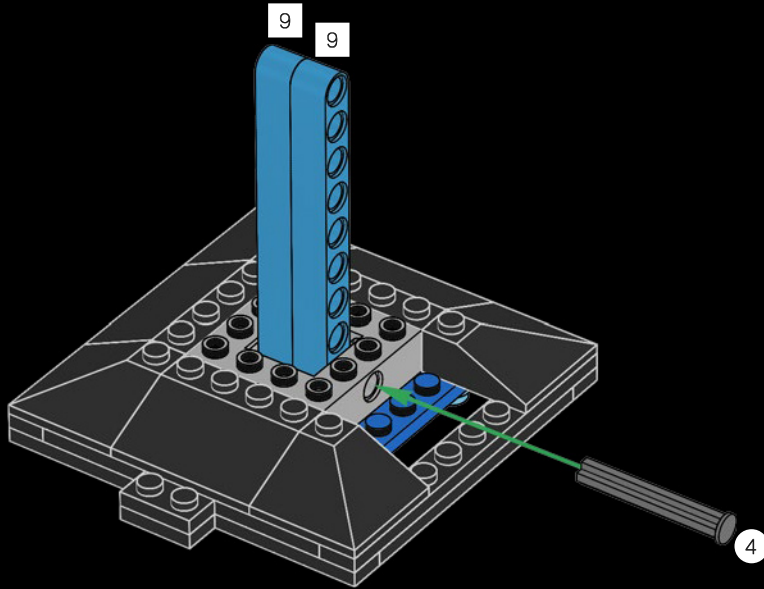

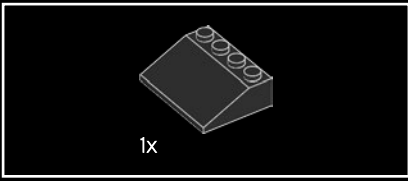

90

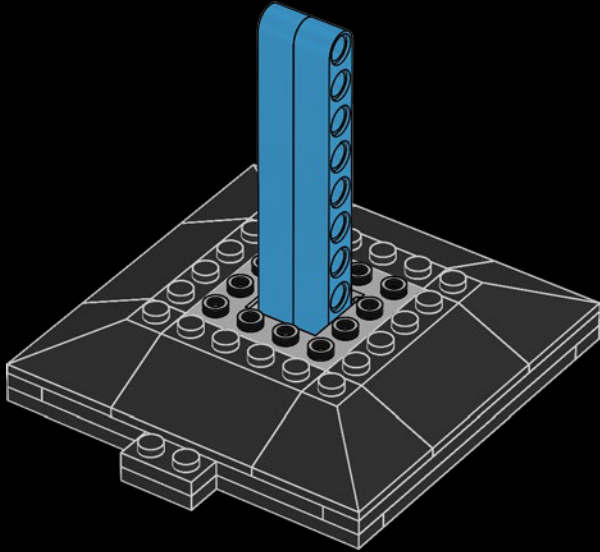

91

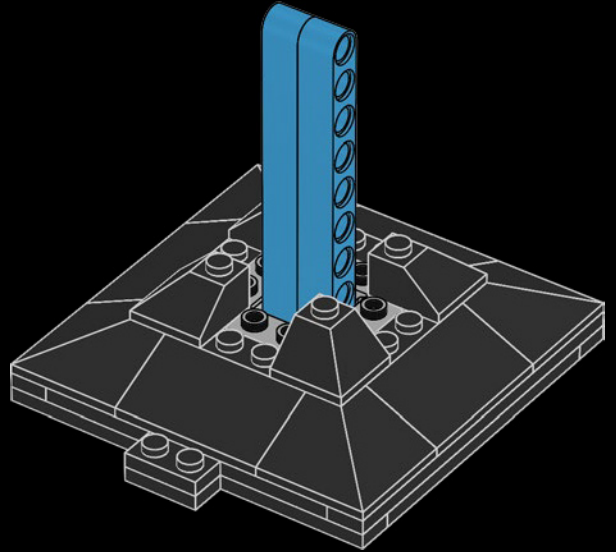

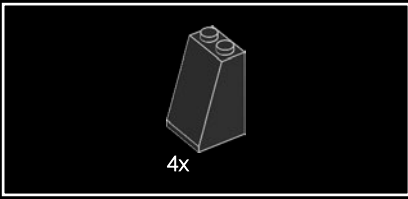

92

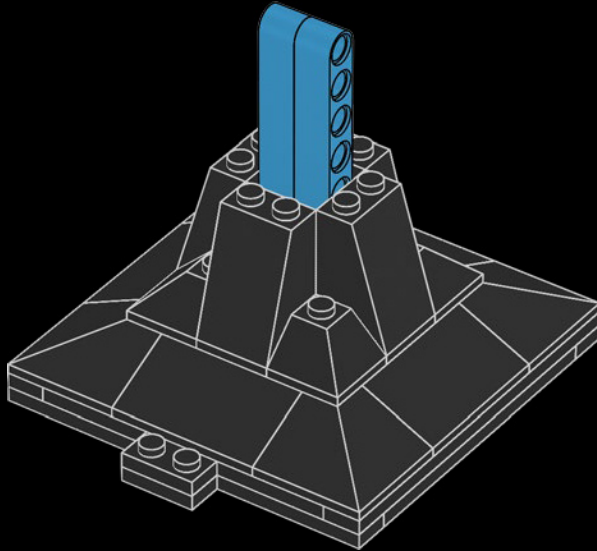

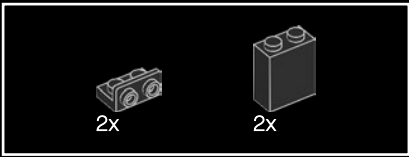

93

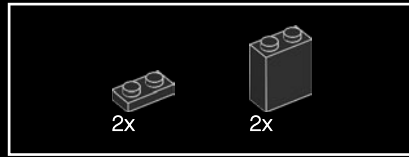
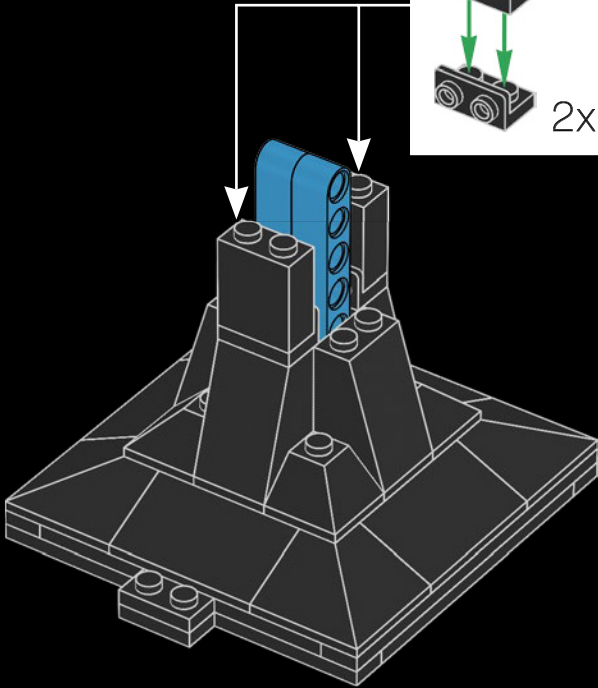
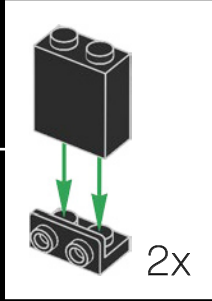

94

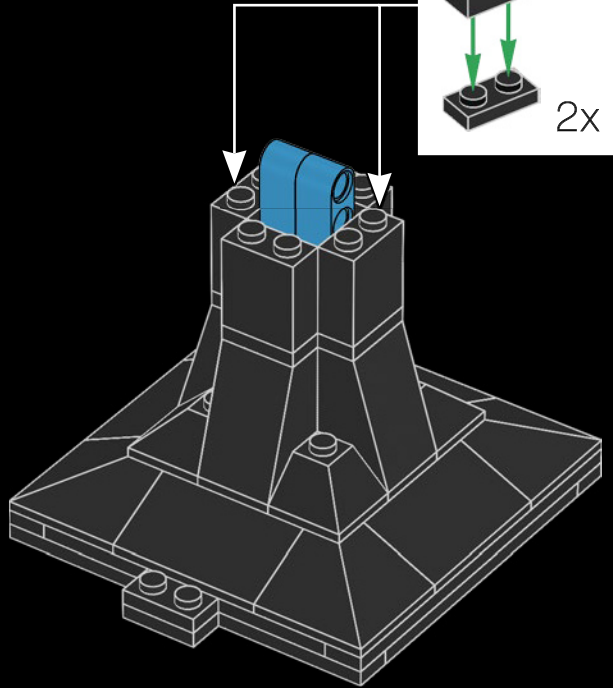
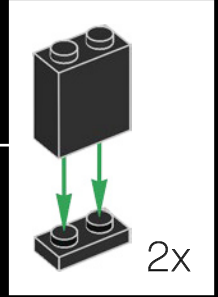

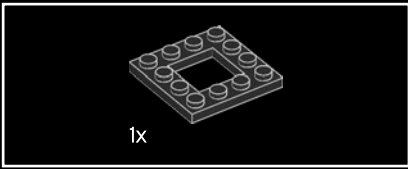

95

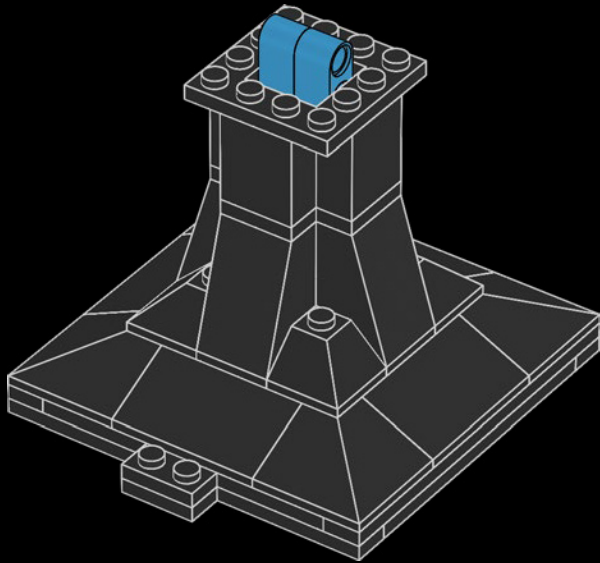

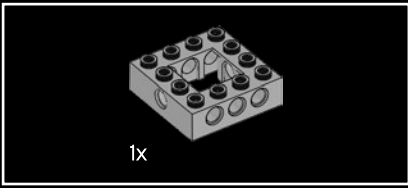

96

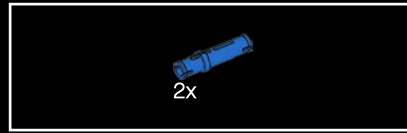
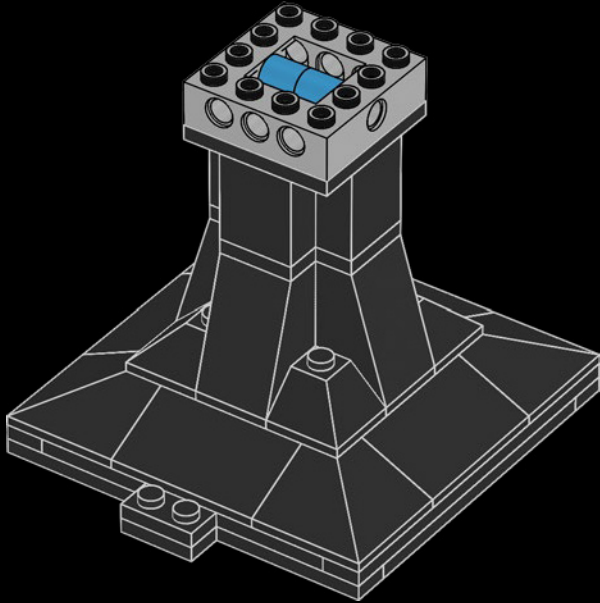

97

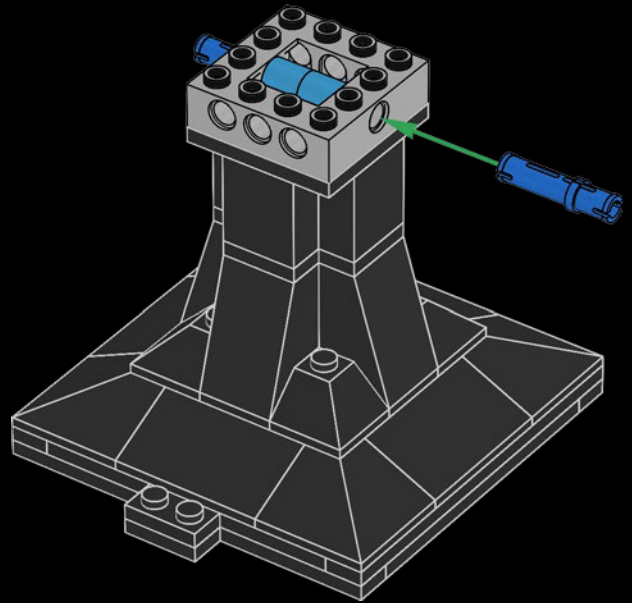



98

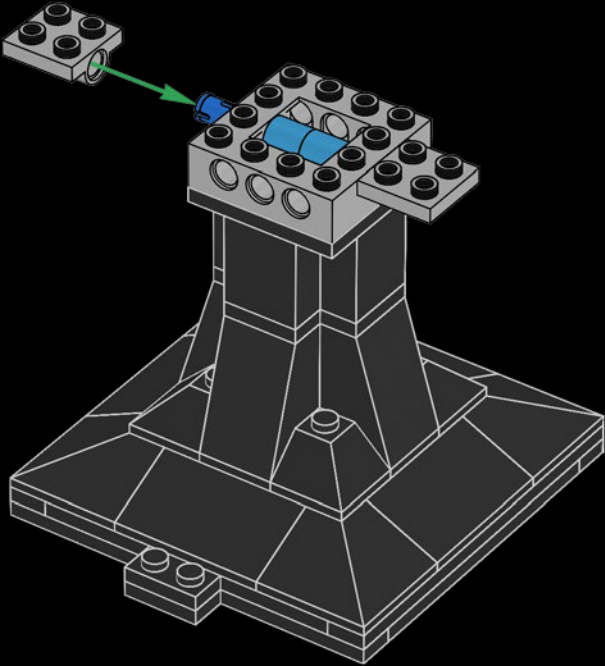

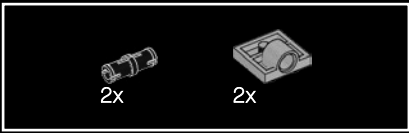

99

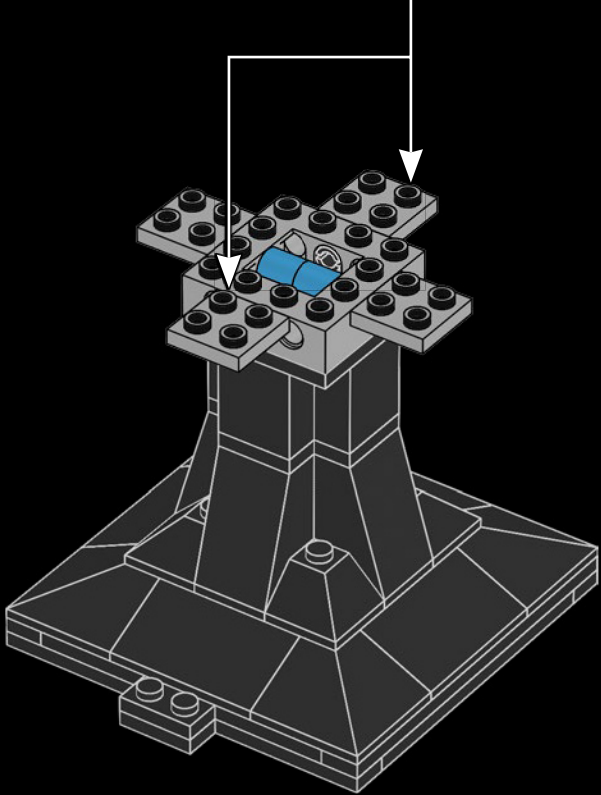
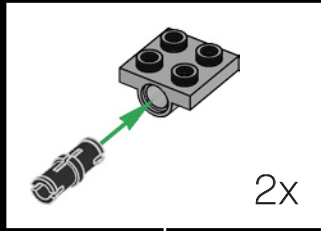



100

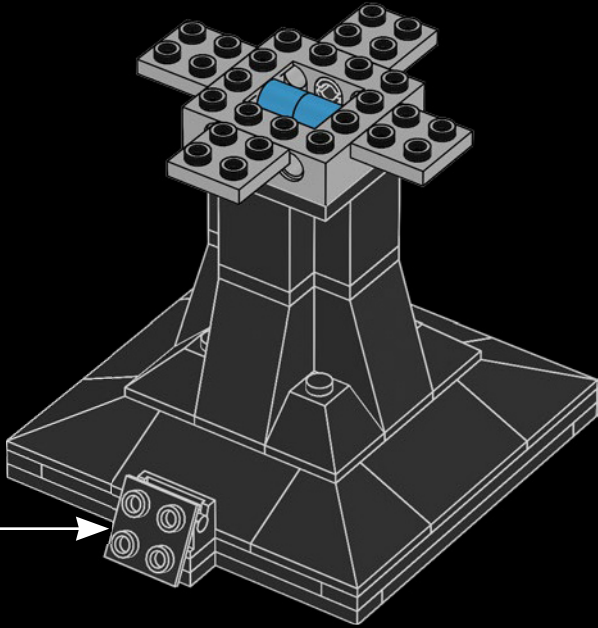
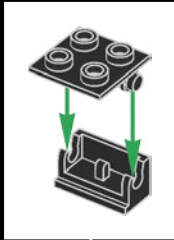

101

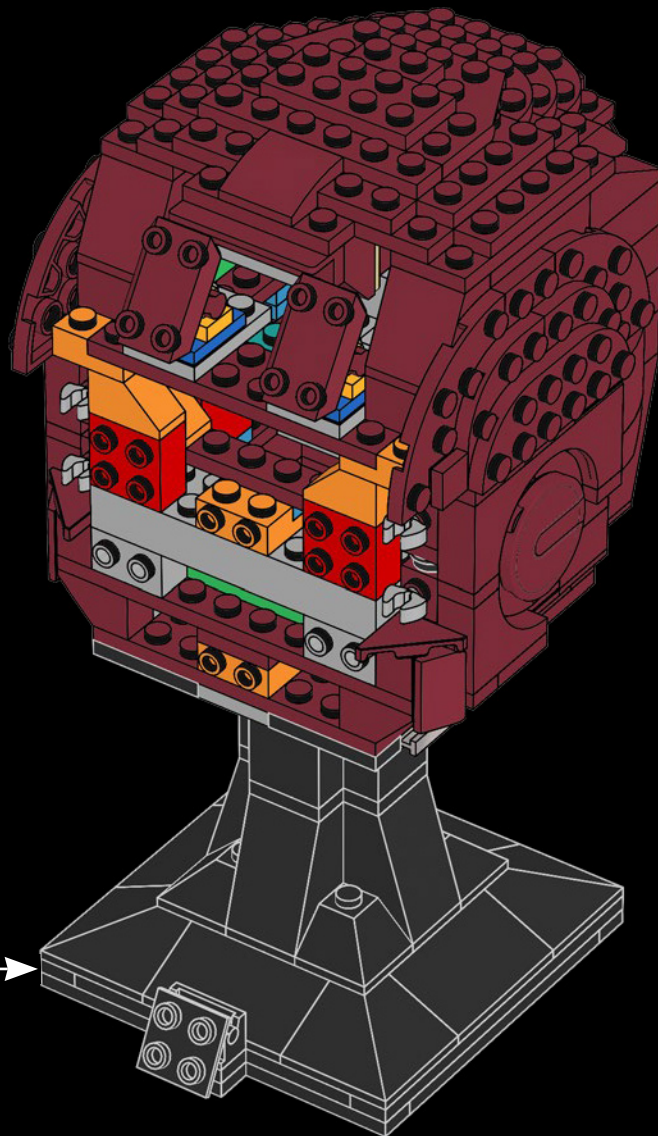

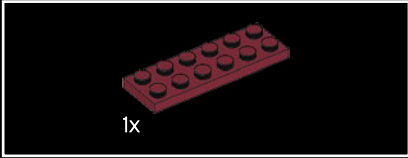

1x

102

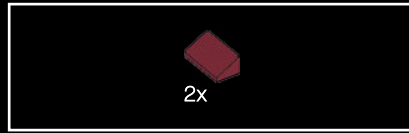

2x

103

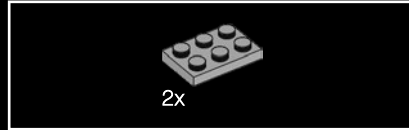
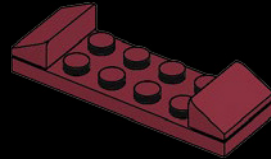

2x

104

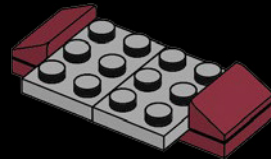

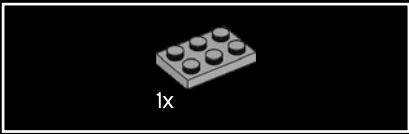

105

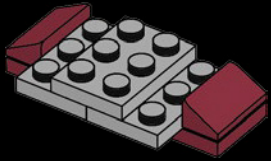

106

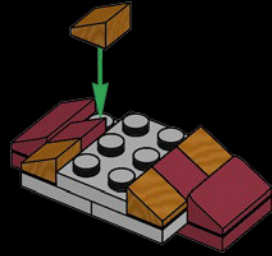



107

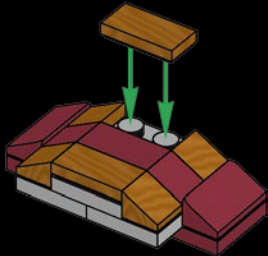

108

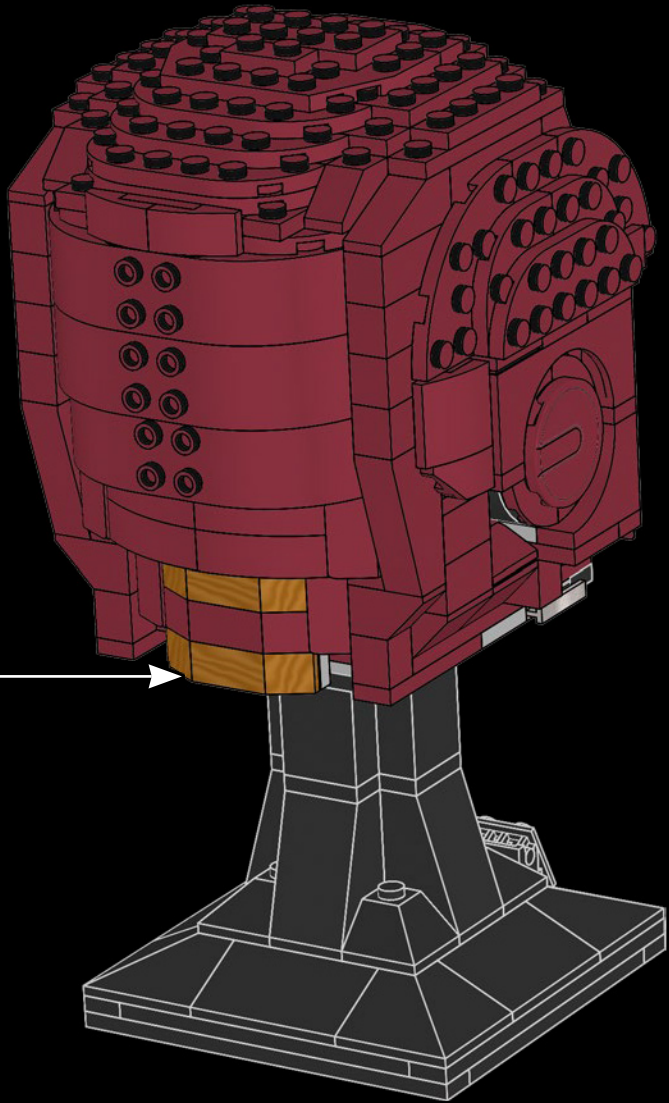

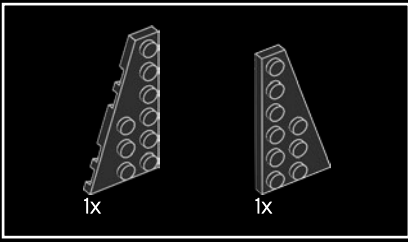

109

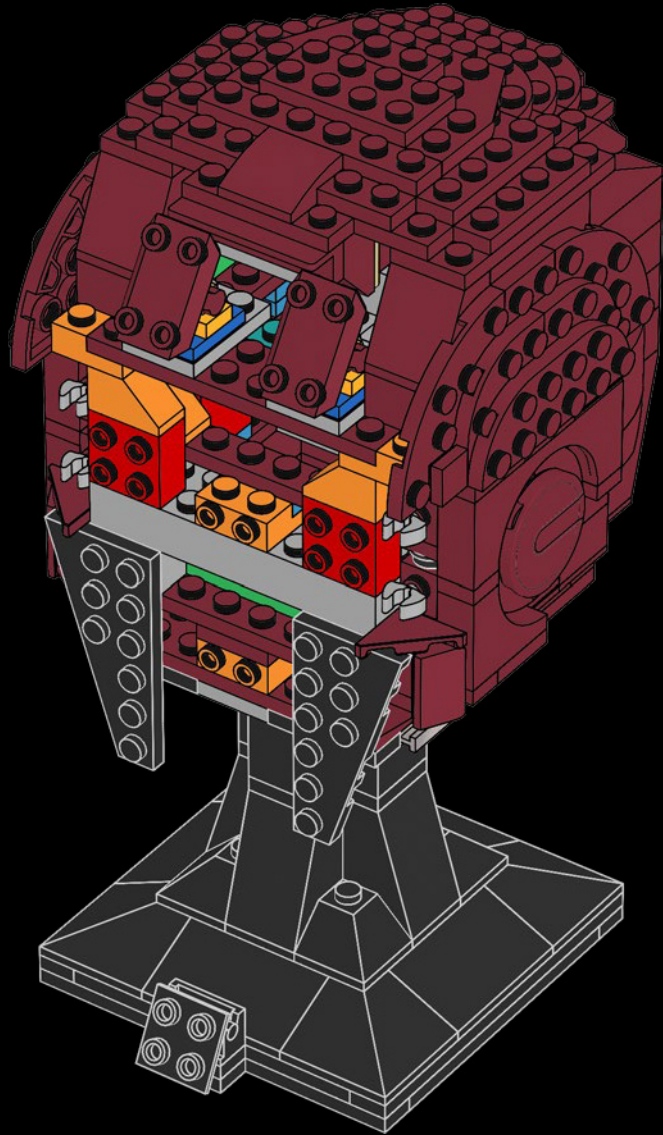

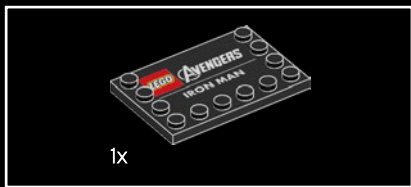

110

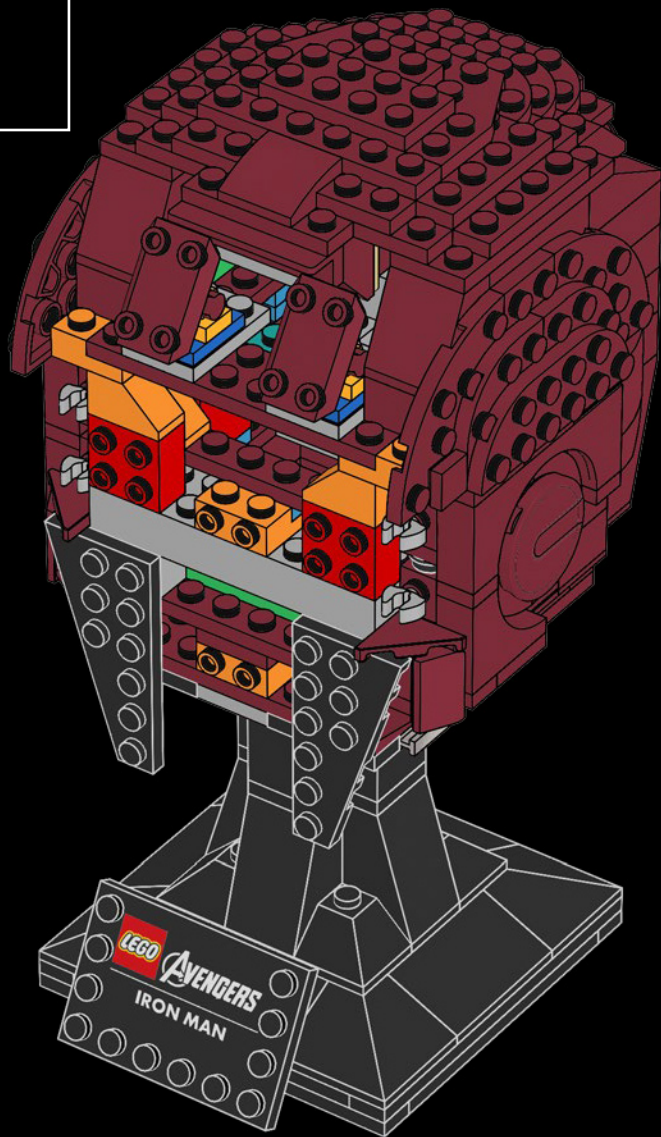

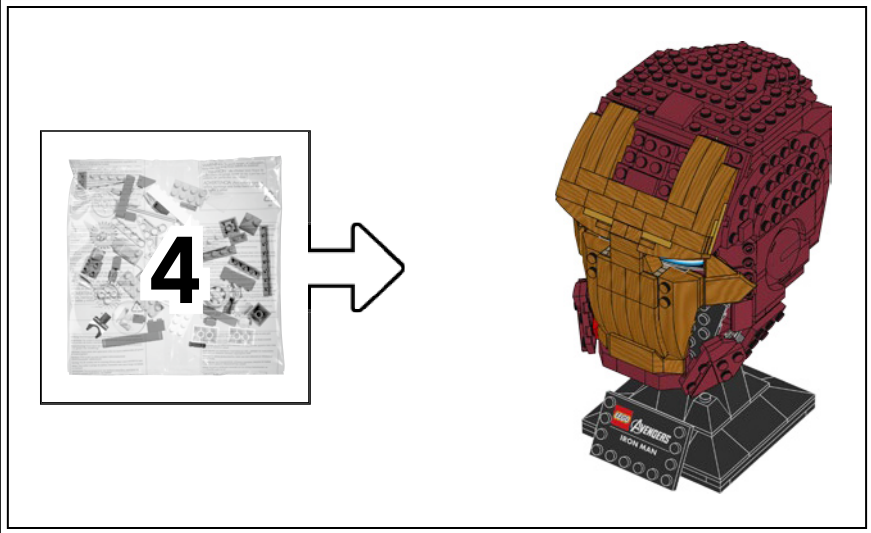

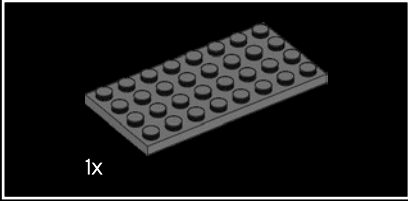
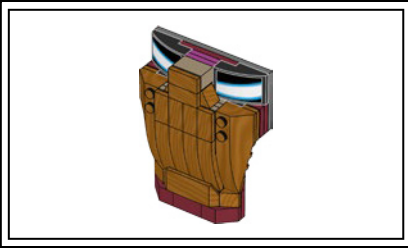

1x

111

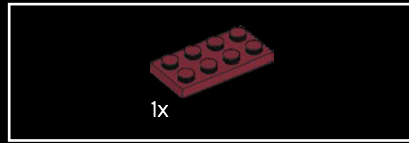
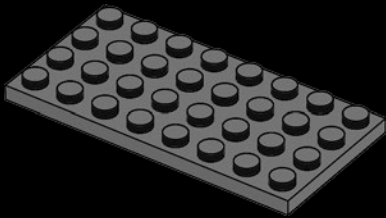

1x

112

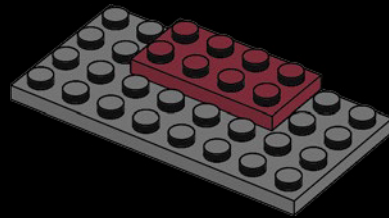



113

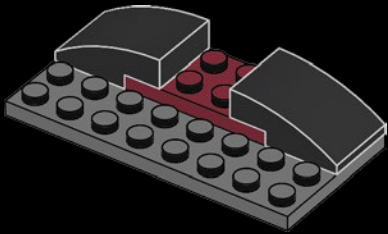

114

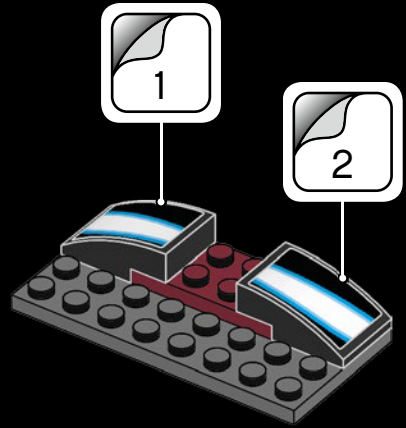



115

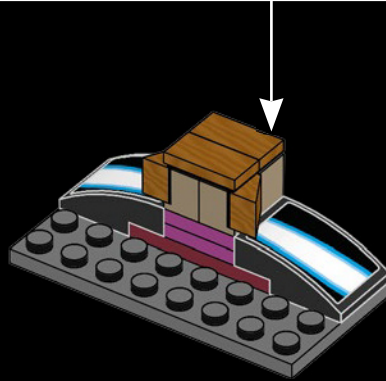
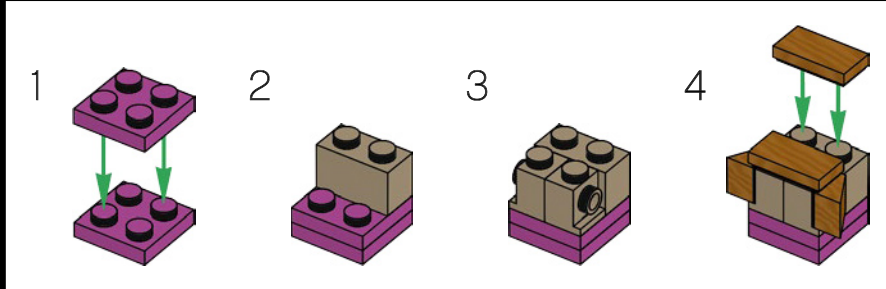

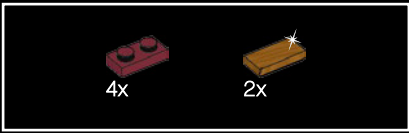

116

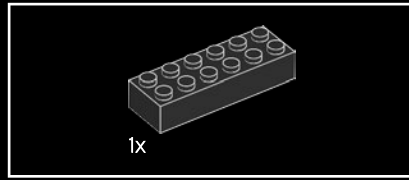
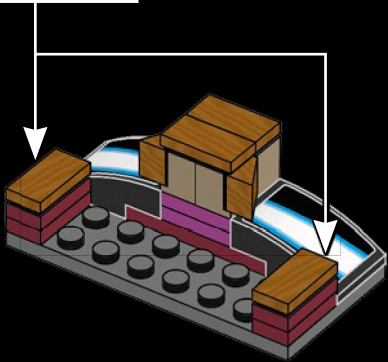
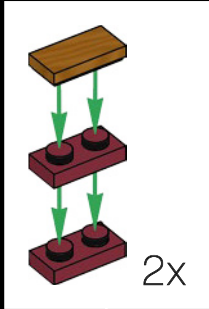

117

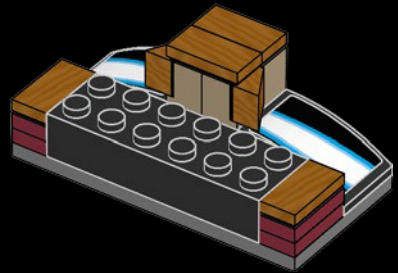

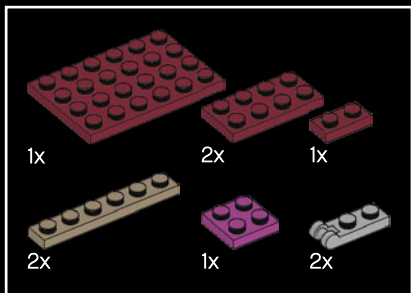

118

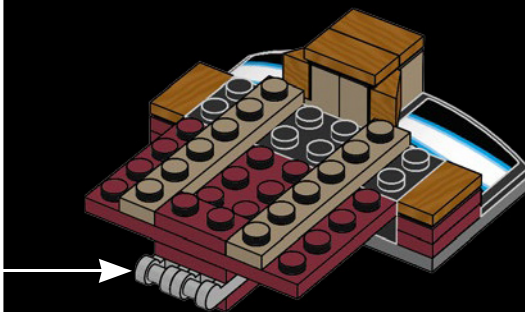
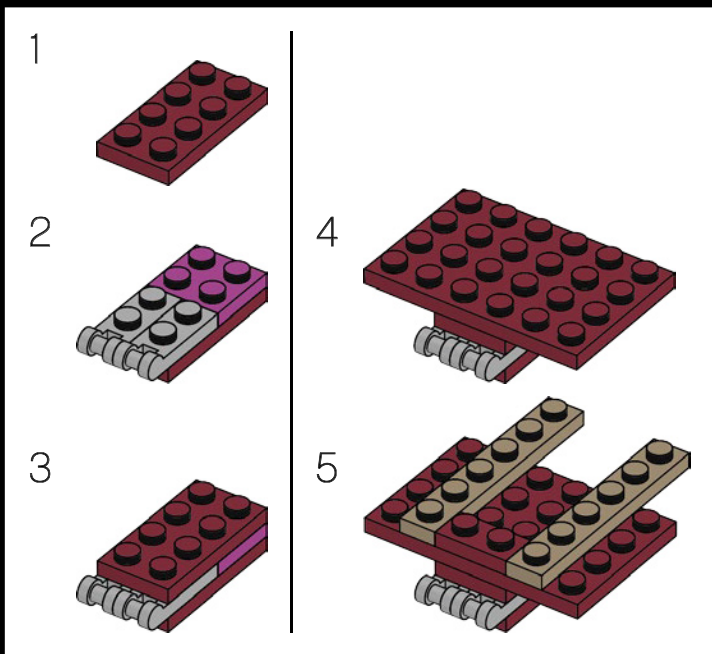

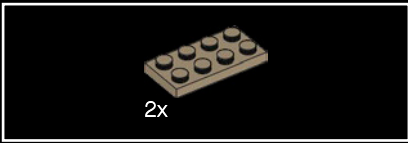

119

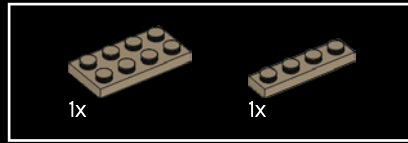
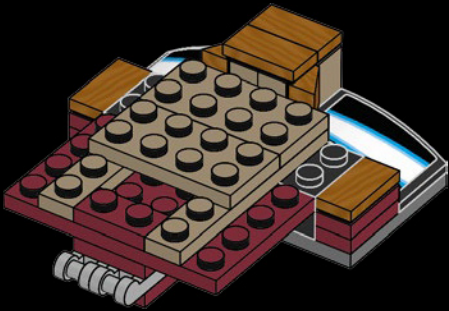

120

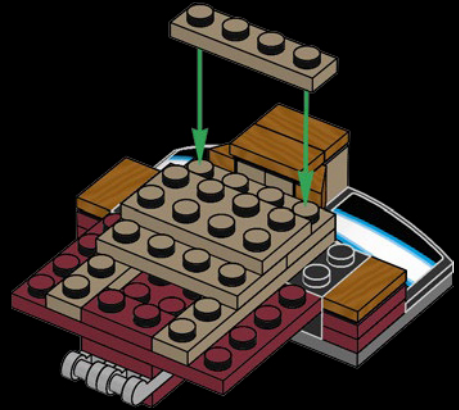

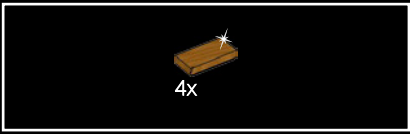

121

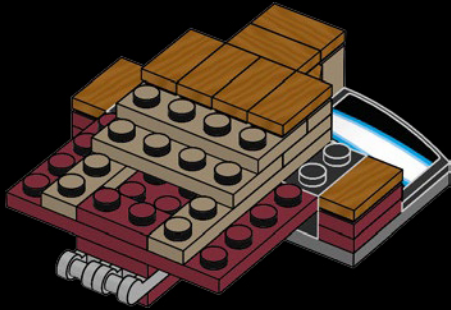

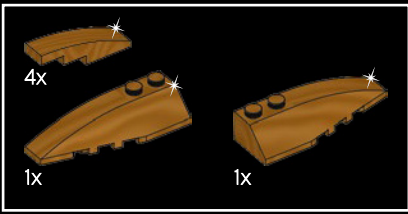

122

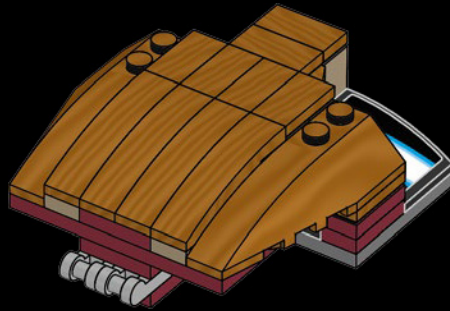

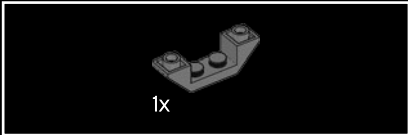

123

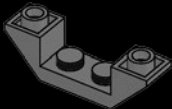

124

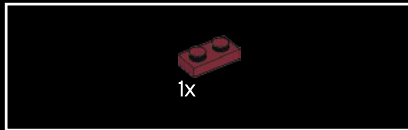
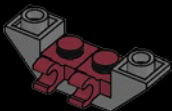

125

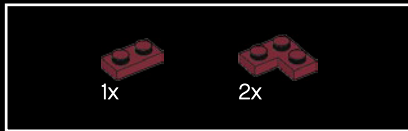
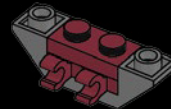

126

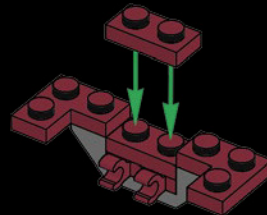



127

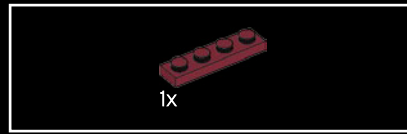
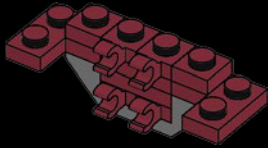

128

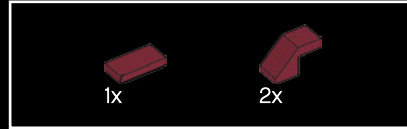
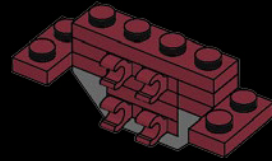

129

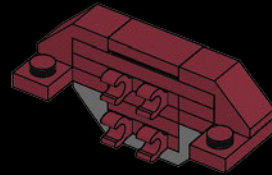

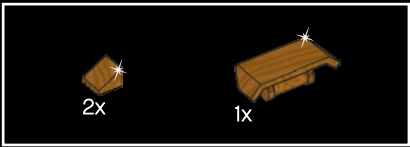

130

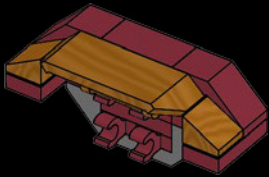

131

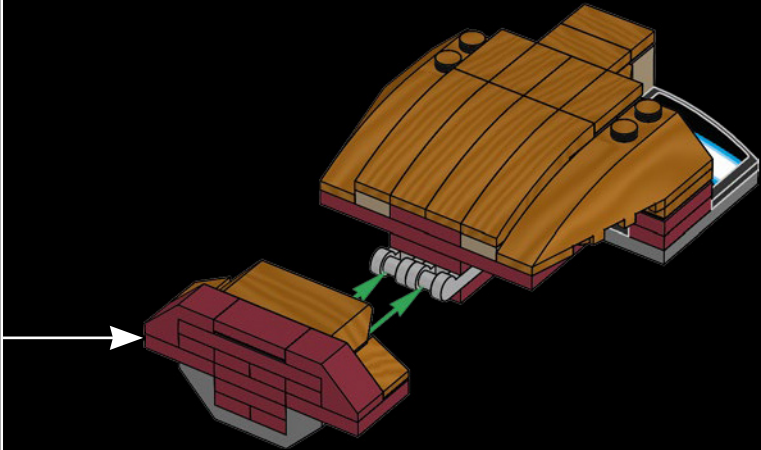

132

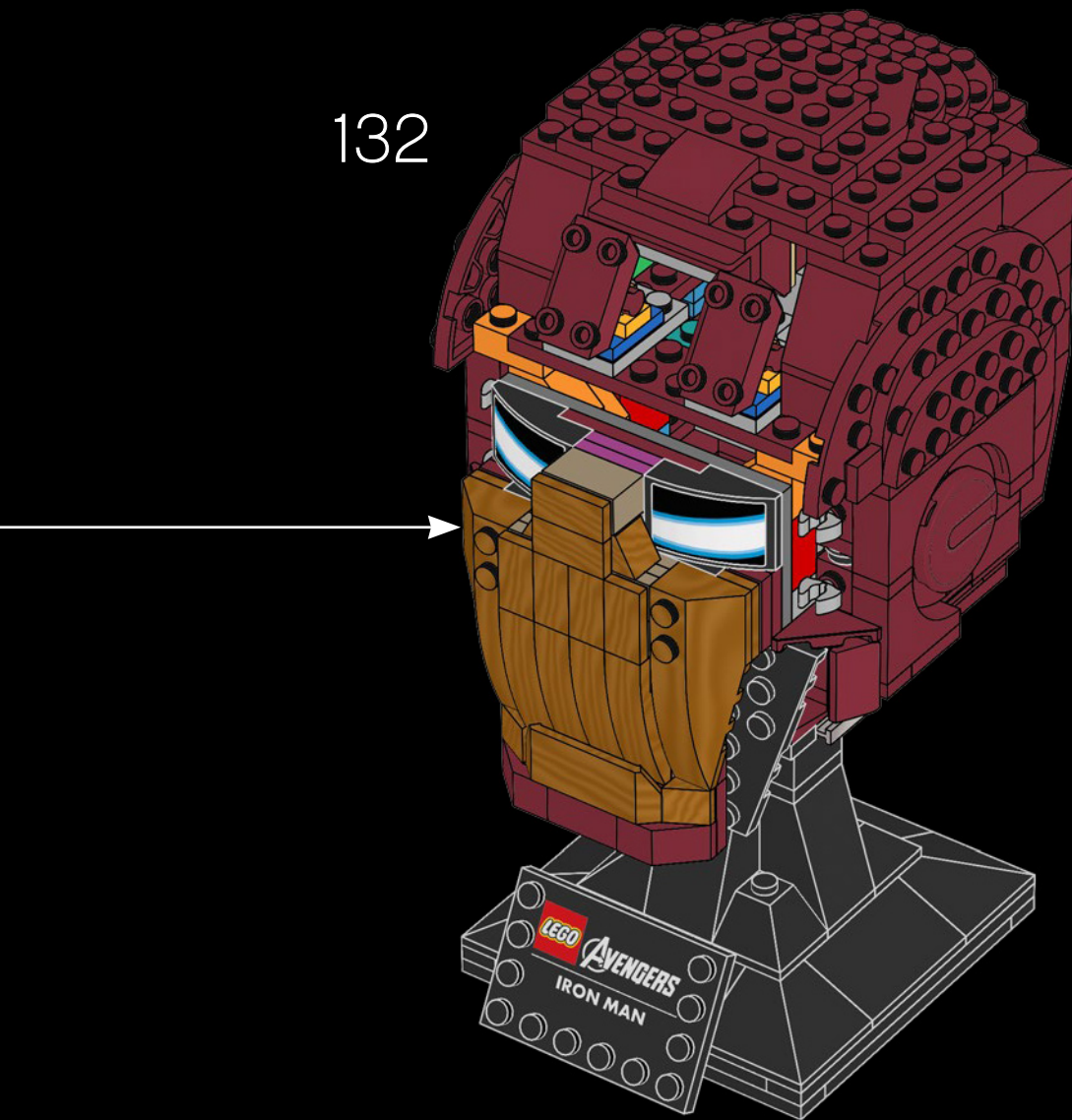



133

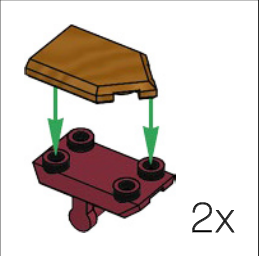
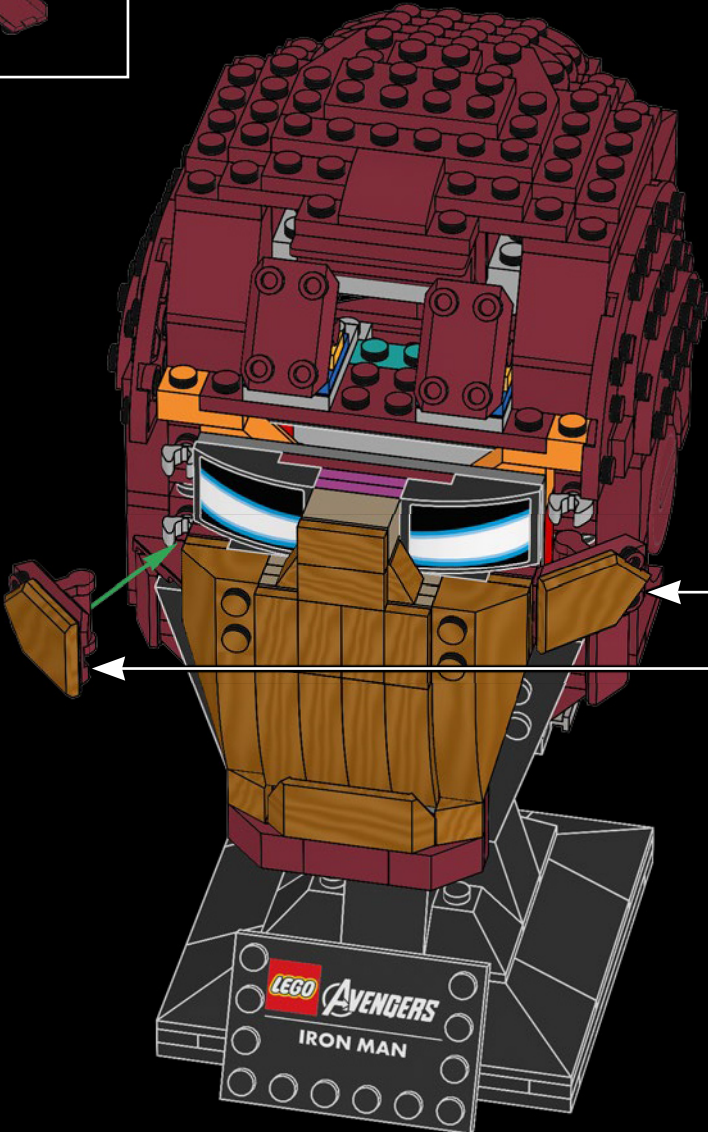



134

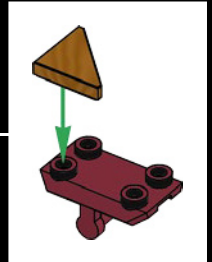
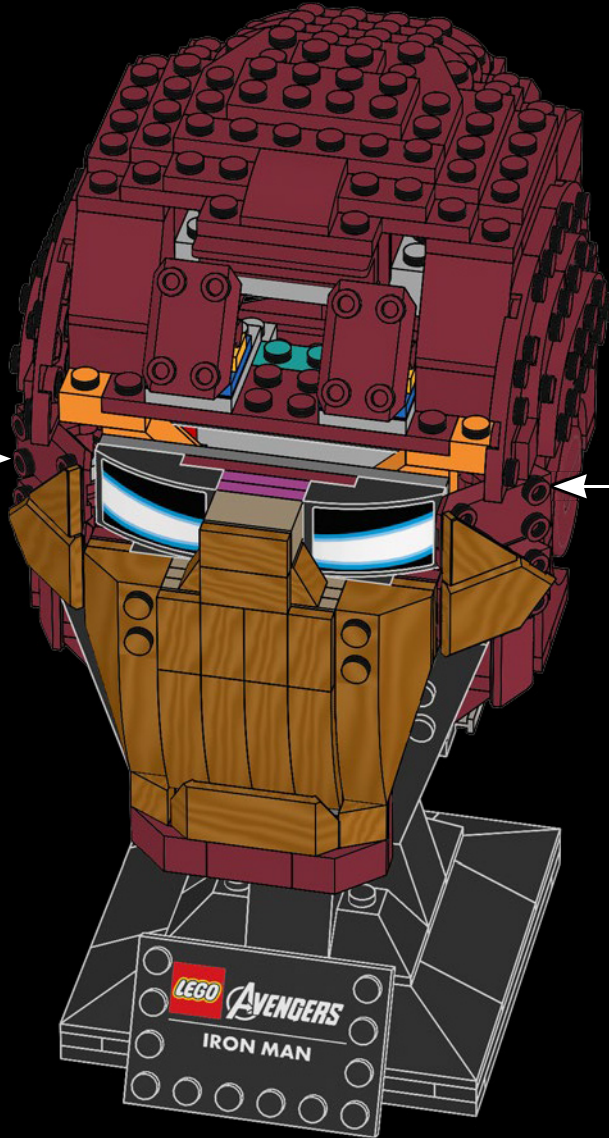
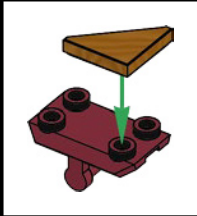

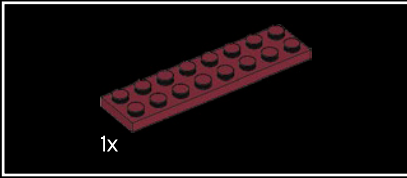
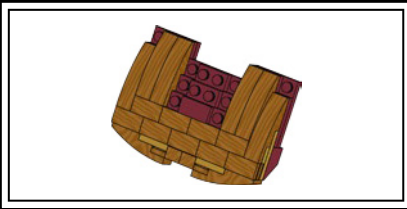

135

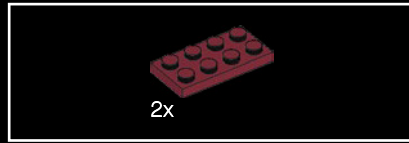
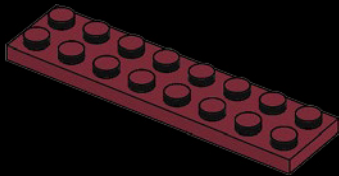

136

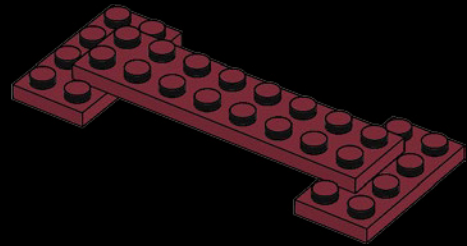

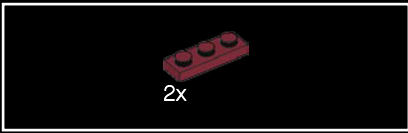

137

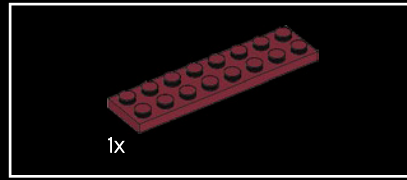
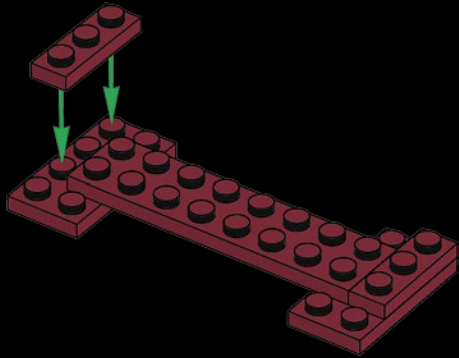

138

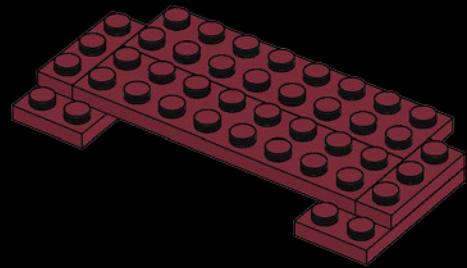

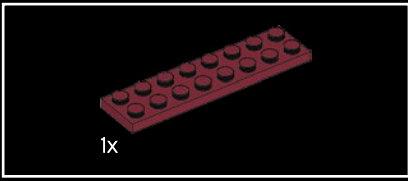

139

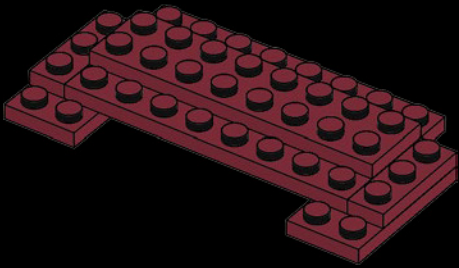

140

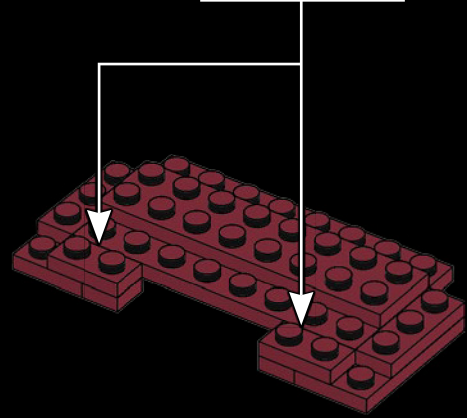
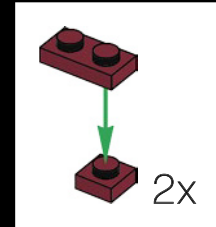

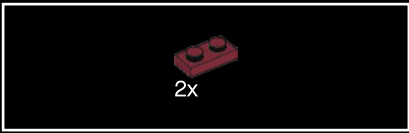

141

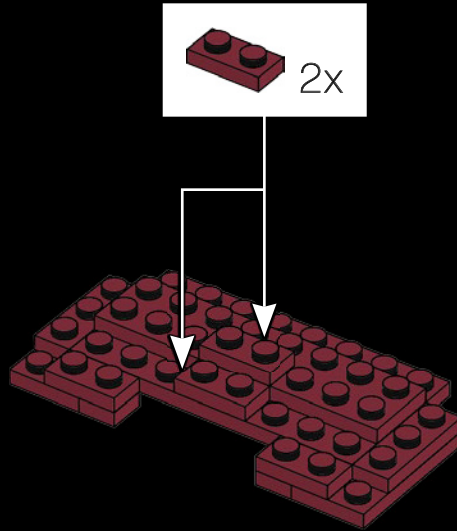

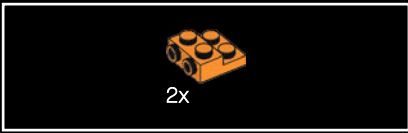

142

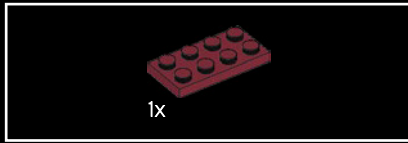
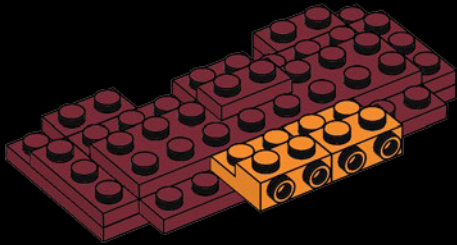

143

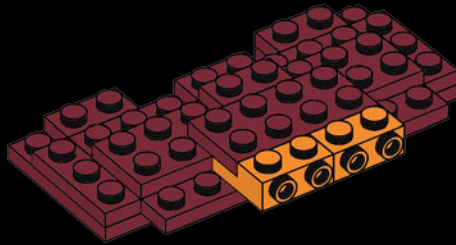

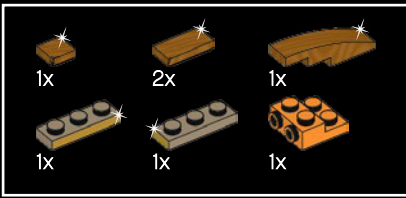

144

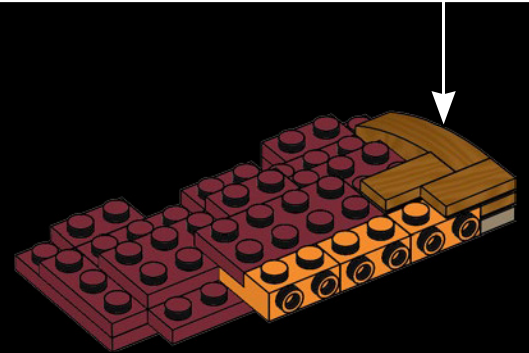
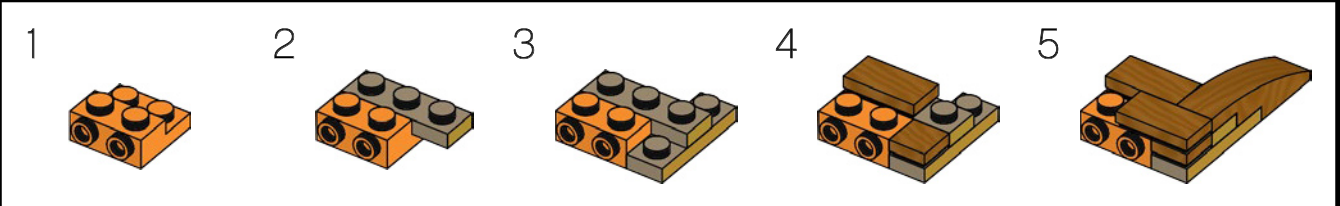

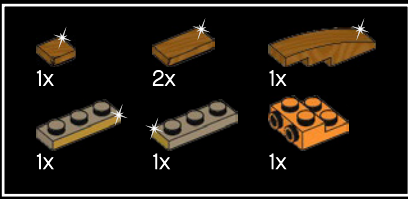

145

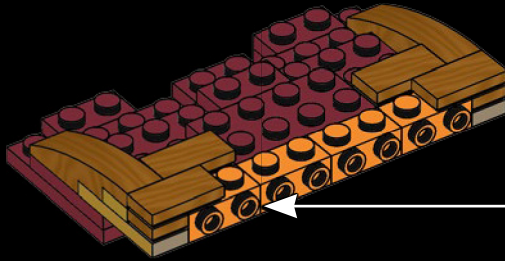
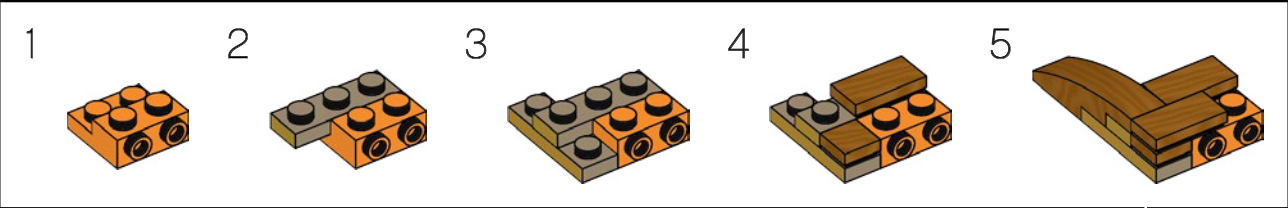



146

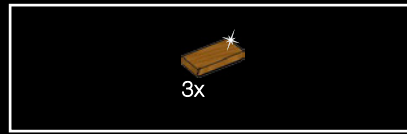
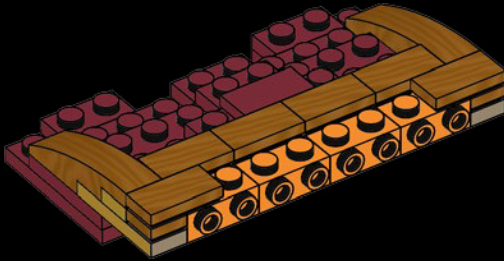

147

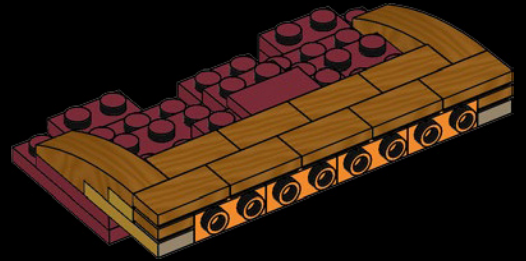

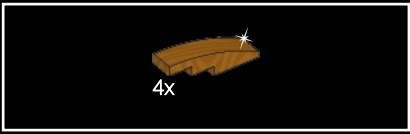

148

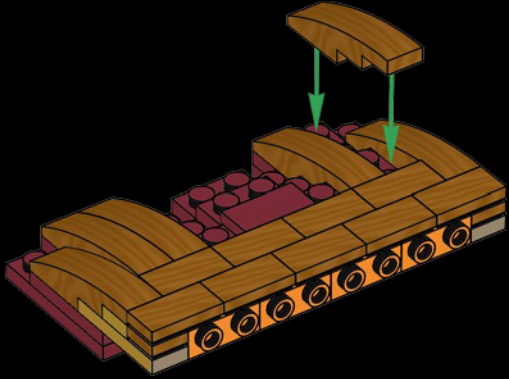

149

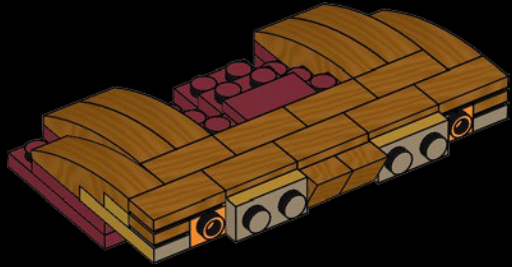



150

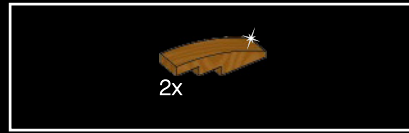
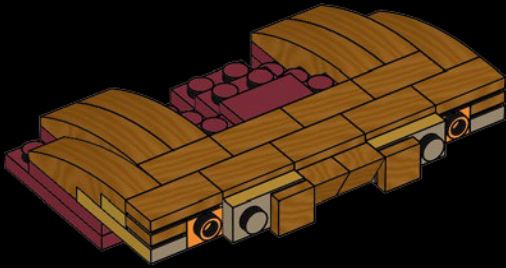

151

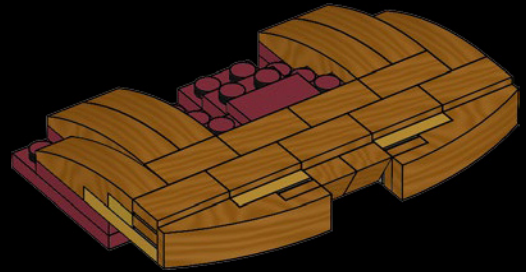

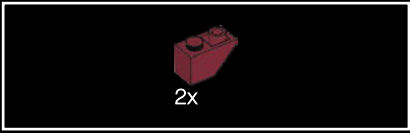

152

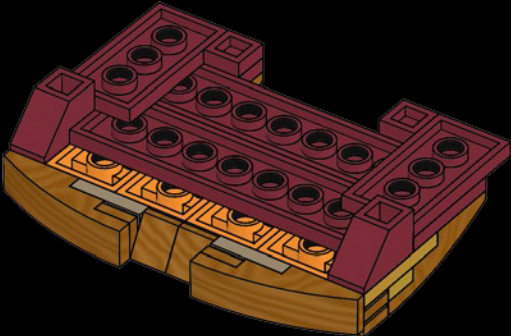

153

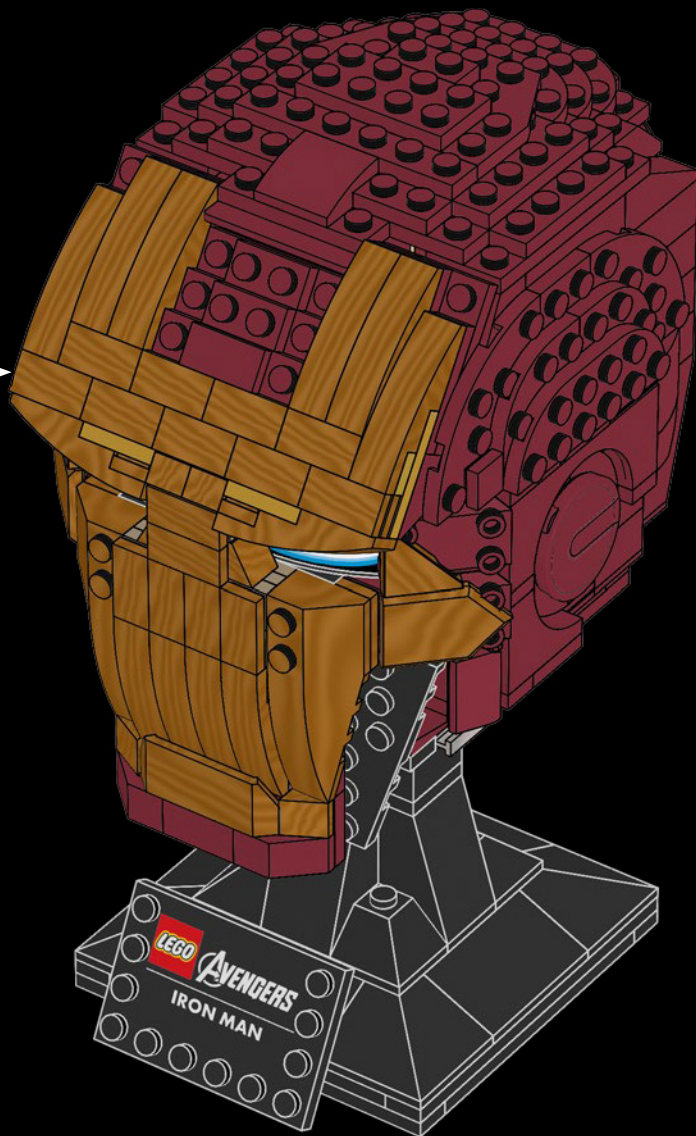



154

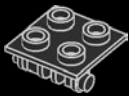

155

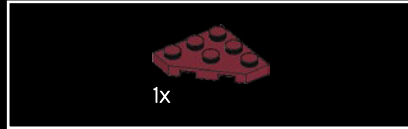

156



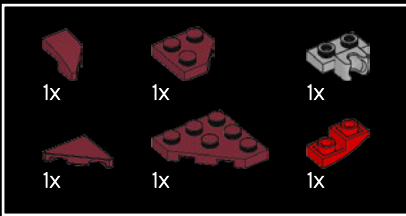

157

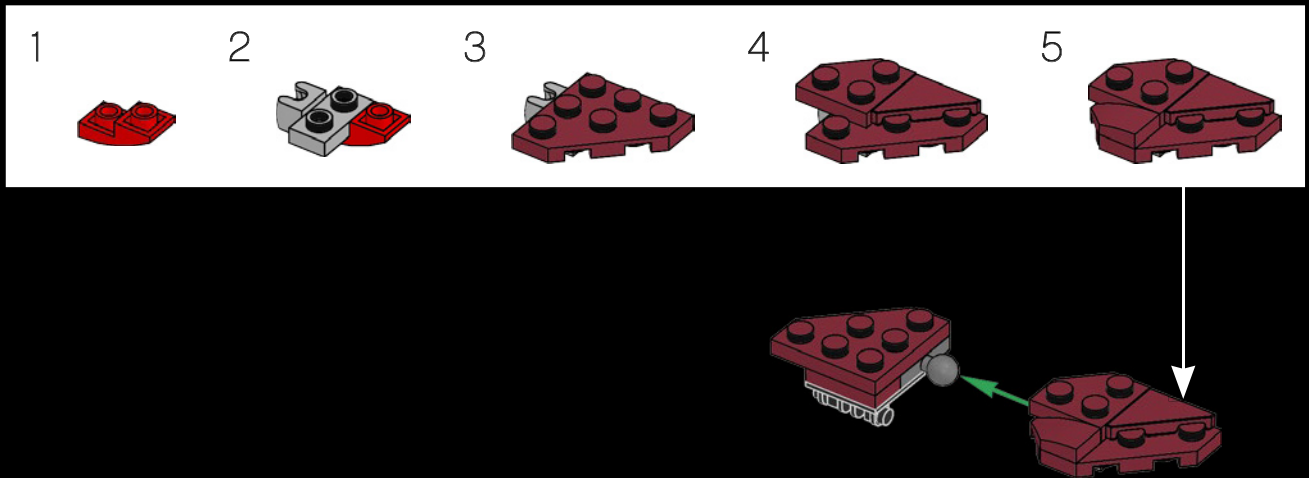



1x

158

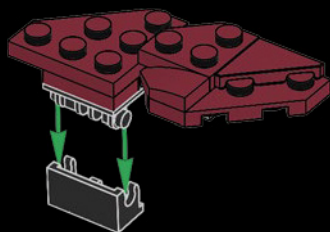

159

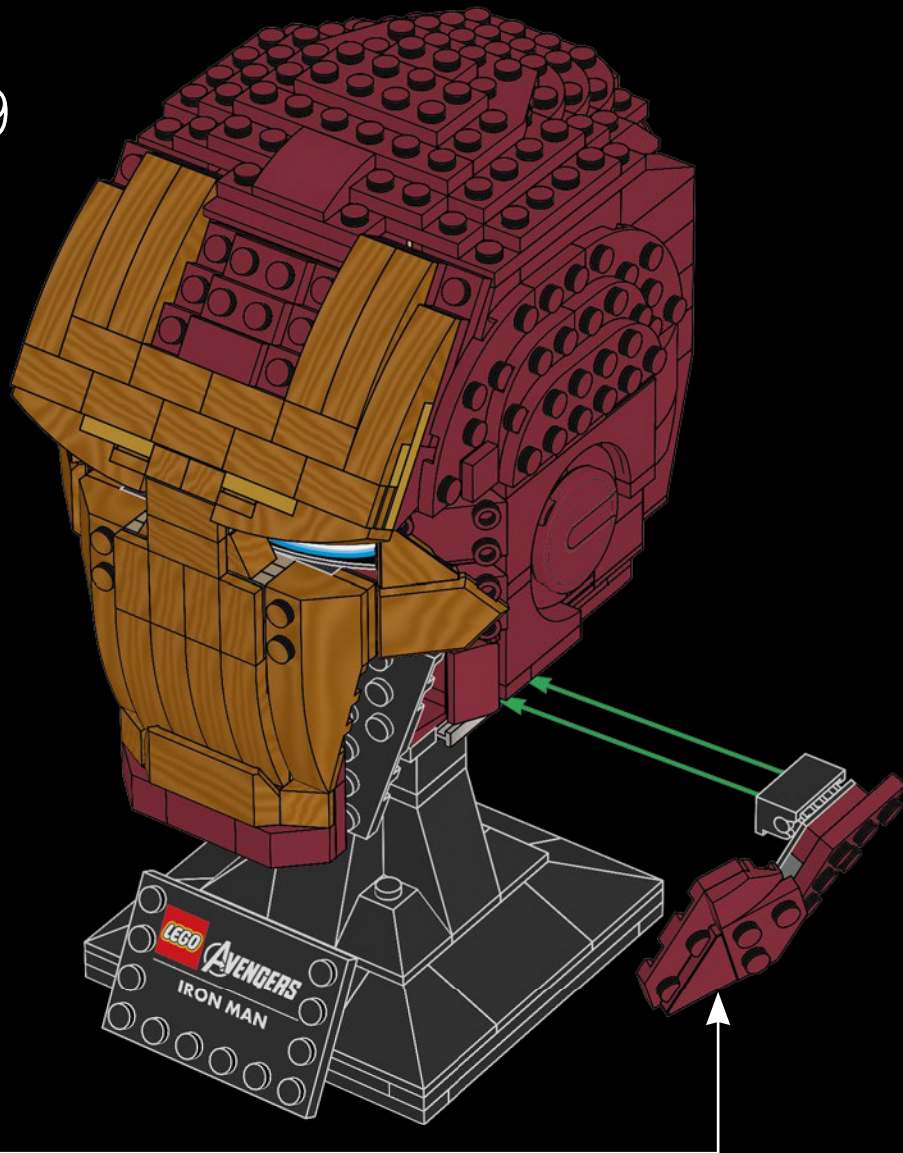

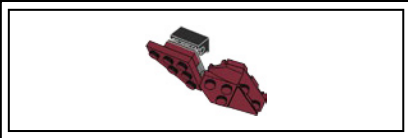

160

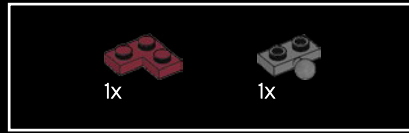
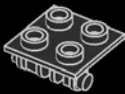

1x

1x

161

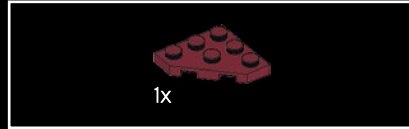

1x

162



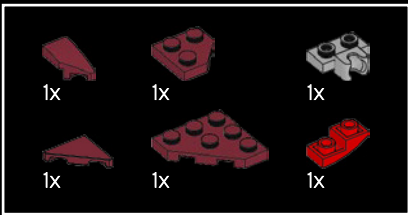

163

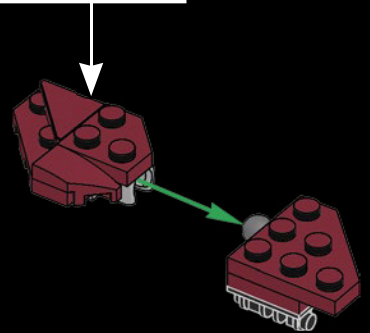
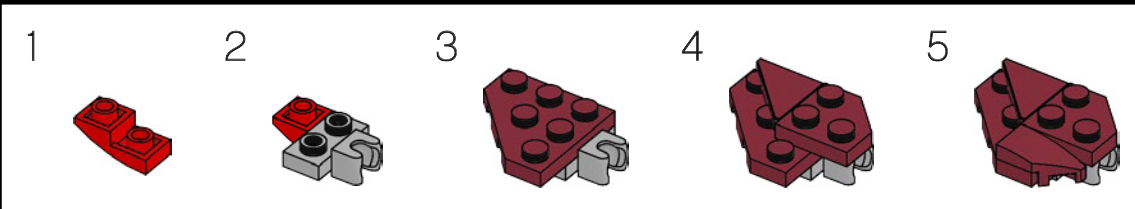

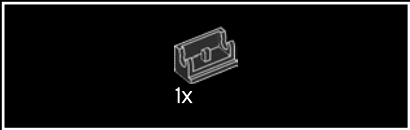

164

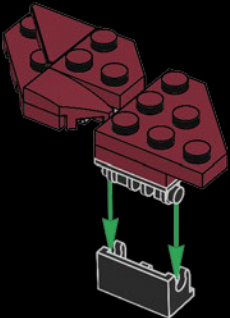

165

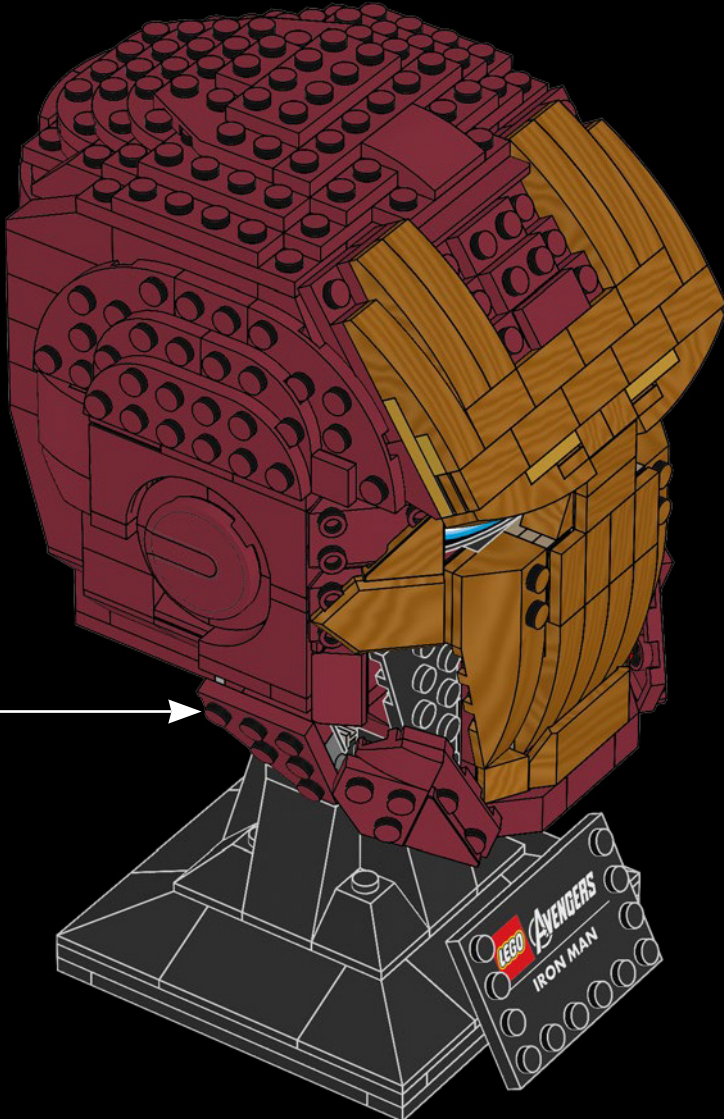



FEEDBACK AND WIN



FEEDBACK AND WIN

Your feedback will help shape the future development of this product series.

Please visit:

FEEDBACK UND GEWINNEN

Dein Feedback trägt zur Weiterentwicklung dieser Produktreihe bei.

Geh auf:

COMMENTEZ ET GAGNEZ

Vos commentaires nous aideront à concevoir les futurs produits de cette gamme.

Rendez-vous sur :

COMENTA Y GANA

Tu opinión nos ayudará a dar forma al desarrollo de esta serie de productos en el futuro.

Visita:

反馈有奖

您的反馈将有助于我们在今后改进本系列产品。

请访问：

[LEGO.com/productfeedback](https://www.lego.com/productfeedback)

By completing, you will automatically enter a drawing to win a LEGO® set.

Terms & Conditions apply.

Durch Ausfüllen nimmst du automatisch an der Verlosung eines LEGO® Preises teil.

Es gelten die Teilnahmebedingungen.

En envoyant vos commentaires, vous serez automatiquement inscrit(e) à un tirage au sort qui vous permettra de remporter un prix LEGO®.

Offre soumise à conditions.

Al contestar, participarás automáticamente en el sorteo y podrás ganar un set LEGO®.

Sujeto a Términos y Condiciones.

完成我们的反馈调查，即可自动进入抽奖环节，赢取乐高®套装。

适用《条款和条件》。



2x
6273590



1x
4521914



2x
6311491



2x
6311490



2x
6311492



1x
4626904



3x
4267874



2x
6015424



2x
6186398



8x
6135130



6x
4121967



11x
6289113



2x
6117975



2x
6117975

130



6x
614126



2x
4121715



4x
4618852



3x
393726



3x
302326



2x
6020193



1x
4283047



1x
4283047



1x
4283046



1x
302226



4x
4189064



4x
6007896



4x
6007896



4x
6007896

4x
6007896



3x
4124096



4x
362326



2x
6147790



2x
4558957



4x
367526



4x
329726



1x
6058118



1x
4181144



1x
4181144



4x
346026



1x
6311477



4x
447726



1x
6311477



4x
447726

4x
447726



2x
6219658



2x
4550169



2x
4531415



8x
4539114



6x
6212007



10x
4541376



4x
6253170



2x
6219657



8x
6083977



2x
6210310



6x
4590811



5x
4539090



15x
4539097



12x
4539102

12x
4539102



2x
6267498



2x
6173168



2x
4541526



2x
6267413



4x
6288635



4x
6214309



1x
4585479



3x
6107758



2x
4625281



6x
4585751



6x
6052917



8x
6172632



6x
6220561



6x
6220561

6x
6220561



2x
6311479



6x
4539076



2x
4650862



2x
6286506



4x
4541546



10x
6052777



6x
4539061



1x
6092665



1x
6092665



2x
4541380



6x
6287664



6x
6287664



4x
4539064



4x
4539064

4x
4539064

16x
4539071

2x
6117418

6x
6175589

2x
6267406

6x
4539062

3x
4541528

4x
4613267

7x
4618986

1x
6097447

1x
6020122

3x
6219652

6x
6152321

2x
6037995

1x
6028115

1x
6249819

4x
6092582

2x
4514553

1x
4199519

2x
6210400

2x
6289133

4x
6278156

2x
6043656

8x
6015344

4x
6045988

2x
4515369

8x
4211396

1x
4211636

2x
4211640

3x
6037399

3x
4111844

3x
6109930

4x
6294578

2x
6039479

1x
6083620

1x
6185675

1x
4211061

2x
6132264

4x
6102986

1x
4653970

13x
4653988

2x
6211954

4

9

10x
6191668

4x
6264167

19x
6265247

2x
6294551

2x
6316567

1x
6294519

12x
6294504

1x
6310388

1x
6310387

Customer Service
Kundenservice
Service Consommateurs
Servicio Al Consumidor

LEGO.com/service or dial

🇧🇪 🇩🇪 🇪🇸 🇫🇷 🇮🇹 🇯🇵 🇰🇷 🇸🇪 🇸🇯 🇺🇸 🇨🇦
: 00800 5346 5555
: 1-800-422-5346



LEGO and the LEGO logo are trademarks of the/sont des marques de commerce du/son marcas registradas de LEGO Group. ©2020 The LEGO Group.



6328959