

INSTRUCTION MANUAL

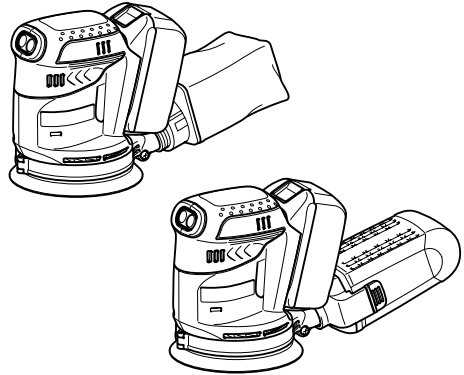

Cordless Random Orbit Sander

DBO140
DBO180



012886

IMPORTANT: Read Before Using.

ENGLISH (Original instructions)

SPECIFICATIONS

Model		DBO140	DBO180
Paper size		125 mm	
Orbits per minute(min^{-1})	Low speed	7,000	
	Middle speed	9,500	
	High speed	11,000	
Dimensions		175 mm x 123 mm x 153 mm	
Net weight		1.6 kg	1.7 kg
Rated voltage		D.C. 14.4V	D.C. 18V

- Due to our continuing program of research and development, the specifications herein are subject to change without notice.
- Specifications and battery cartridge may differ from country to country.
- Weight, with battery cartridge, according to EPTA-Procedure 01/2003

END004-4

Symbols

The following show the symbols used for the equipment. Be sure that you understand their meaning before use.



- Read instruction manual.



- Only for EU countries

Do not dispose of electric equipment or battery pack together with household waste material!

In observance of European Directive 2002/96/EC on waste electric and electronic equipment, 2006/66/EC on batteries and accumulators and waste batteries and accumulators and their implementation in accordance with national laws, electric equipment and battery pack that have reached the end of their life must be collected separately and returned to an environmentally compatible recycling facility.

ENE052-1

Intended use

The tool is intended for the sanding of large surface of wood, plastic and metal materials as well as painted surfaces.

ENG905-1

Noise

The typical A-weighted noise level determined according to EN60745:

Model DBO140

Sound pressure level (L_{pA}) : 78 dB (A)

Uncertainty (K) : 3 dB (A)

The noise level under working may exceed 80 dB (A).

Model DBO180

Sound pressure level (L_{pA}) : 77 dB (A)

Uncertainty (K) : 3 dB (A)

The noise level under working may exceed 80 dB (A).

Wear ear protection

ENG900-1

Vibration

The vibration total value (tri-axial vector sum) determined according to EN60745:

Model DBO140

Work mode : sanding metal plate

Vibration emission (a_h) : 2.5 m/s^2 or less

Uncertainty (K) : 1.5 m/s^2

Model DBO180

Work mode : sanding metal plate

Vibration emission (a_h) : 2.5 m/s^2 or less

Uncertainty (K) : 1.5 m/s^2

ENG901-1

- The declared vibration emission value has been measured in accordance with the standard test method and may be used for comparing one tool with another.
- The declared vibration emission value may also be used in a preliminary assessment of exposure.

WARNING:

- The vibration emission during actual use of the power tool can differ from the declared emission value depending on the ways in which the tool is used.
- Be sure to identify safety measures to protect the operator that are based on an estimation of exposure in the actual conditions of use (taking

account of all parts of the operating cycle such as the times when the tool is switched off and when it is running idle in addition to the trigger time).

ENH101-15

For European countries only

EC Declaration of Conformity

We Makita Corporation as the responsible manufacturer declare that the following Makita machine(s):

Designation of Machine:

Cordless Random Orbit Sander

Model No./ Type: DBO140, DBO180

are of series production and

Conforms to the following European Directives:

2006/42/EC

And are manufactured in accordance with the following standards or standardised documents:

EN60745

The technical documentation is kept by our authorised representative in Europe who is:

Makita International Europe Ltd.

Michigan Drive, Tongwell,

Milton Keynes, Bucks MK15 8JD, England

14.9.2011



000230

Tomoyasu Kato

Director

Makita Corporation

3-11-8, Sumiyoshi-cho,

Anjo, Aichi, 446-8502, JAPAN

GEA006-2

General Power Tool Safety Warnings

⚠ WARNING Read all safety warnings and all instructions. Failure to follow the warnings and instructions may result in electric shock, fire and/or serious injury.

Save all warnings and instructions for future reference.

The term "power tool" in the warnings refers to your mains-operated (corded) power tool or battery-operated (cordless) power tool.

Work area safety

1. **Keep work area clean and well lit.** Cluttered or dark areas invite accidents.

2. **Do not operate power tools in explosive atmospheres, such as in the presence of flammable liquids, gases or dust.** Power tools create sparks which may ignite the dust or fumes.
3. **Keep children and bystanders away while operating a power tool.** Distractions can cause you to lose control.

Electrical safety

4. **Power tool plugs must match the outlet. Never modify the plug in any way. Do not use any adapter plugs with earthed (grounded) power tools.** Unmodified plugs and matching outlets will reduce risk of electric shock.
5. **Avoid body contact with earthed or grounded surfaces such as pipes, radiators, ranges and refrigerators.** There is an increased risk of electric shock if your body is earthed or grounded.
6. **Do not expose power tools to rain or wet conditions.** Water entering a power tool will increase the risk of electric shock.
7. **Do not abuse the cord. Never use the cord for carrying, pulling or unplugging the power tool. Keep cord away from heat, oil, sharp edges or moving parts.** Damaged or entangled cords increase the risk of electric shock.
8. **When operating a power tool outdoors, use an extension cord suitable for outdoor use.** Use of a cord suitable for outdoor use reduces the risk of electric shock.
9. **If operating a power tool in a damp location is unavoidable, use a ground fault circuit interrupter (GFCI) protected supply.** Use of an GFCI reduces the risk of electric shock.

Personal safety

10. **Stay alert, watch what you are doing and use common sense when operating a power tool. Do not use a power tool while you are tired or under the influence of drugs, alcohol or medication.** A moment of inattention while operating power tools may result in serious personal injury.
11. **Use personal protective equipment. Always wear eye protection.** Protective equipment such as dust mask, non-skid safety shoes, hard hat, or hearing protection used for appropriate conditions will reduce personal injuries.
12. **Prevent unintentional starting. Ensure the switch is in the off-position before connecting to power source and/or battery pack, picking up or carrying the tool.** Carrying power tools with your finger on the switch or energising power tools that have the switch on invites accidents.
13. **Remove any adjusting key or wrench before turning the power tool on.** A wrench or a key left attached to a rotating part of the power tool may result in personal injury.

14. **Do not overreach. Keep proper footing and balance at all times.** This enables better control of the power tool in unexpected situations.
15. **Dress properly. Do not wear loose clothing or jewellery. Keep your hair, clothing, and gloves away from moving parts.** Loose clothes, jewellery or long hair can be caught in moving parts.
16. **If devices are provided for the connection of dust extraction and collection facilities, ensure these are connected and properly used.** Use of dust collection can reduce dust-related hazards.

Power tool use and care

17. **Do not force the power tool. Use the correct power tool for your application.** The correct power tool will do the job better and safer at the rate for which it was designed.
18. **Do not use the power tool if the switch does not turn it on and off.** Any power tool that cannot be controlled with the switch is dangerous and must be repaired.
19. **Disconnect the plug from the power source and/or the battery pack from the power tool before making any adjustments, changing accessories, or storing power tools.** Such preventive safety measures reduce the risk of starting the power tool accidentally.
20. **Store idle power tools out of the reach of children and do not allow persons unfamiliar with the power tool or these instructions to operate the power tool.** Power tools are dangerous in the hands of untrained users.
21. **Maintain power tools. Check for misalignment or binding of moving parts, breakage of parts and any other condition that may affect the power tool's operation. If damaged, have the power tool repaired before use.** Many accidents are caused by poorly maintained power tools.
22. **Keep cutting tools sharp and clean.** Properly maintained cutting tools with sharp cutting edges are less likely to bind and are easier to control.
23. **Use the power tool, accessories and tool bits etc. in accordance with these instructions, taking into account the working conditions and the work to be performed.** Use of the power tool for operations different from those intended could result in a hazardous situation.

Battery tool use and care

24. **Recharge only with the charger specified by the manufacturer.** A charger that is suitable for one type of battery pack may create a risk of fire when used with another battery pack.
25. **Use power tools only with specifically designated battery packs.** Use of any other battery packs may create a risk of injury and fire.

26. **When battery pack is not in use, keep it away from other metal objects, like paper clips, coins, keys, nails, screws or other small metal objects, that can make a connection from one terminal to another.** Shorting the battery terminals together may cause burns or a fire.
27. **Under abusive conditions, liquid may be ejected from the battery; avoid contact. If contact accidentally occurs, flush with water. If liquid contacts eyes, additionally seek medical help.** Liquid ejected from the battery may cause irritation or burns.

Service

28. **Have your power tool serviced by a qualified repair person using only identical replacement parts.** This will ensure that the safety of the power tool is maintained.
29. **Follow instruction for lubricating and changing accessories.**
30. **Keep handles dry, clean and free from oil and grease.**

GEB021-4

SANDER SAFETY WARNINGS

1. **Always use safety glasses or goggles.** Ordinary eye or sun glasses are NOT safety glasses.
2. **Hold the tool firmly.**
3. **Do not leave the tool running. Operate the tool only when hand-held.**
4. **This tool has not been waterproofed, so do not use water on the workpiece surface.**
5. **Ventilate your work area adequately when you perform sanding operations.**
6. **Some material contains chemicals which may be toxic. Take caution to prevent dust inhalation and skin contact. Follow material supplier safety data.**
7. **Use of this tool to sand some products, paints and wood could expose user to dust containing hazardous substances. Use appropriate respiratory protection.**
8. **Be sure that there are no cracks or breakage on the pad before use. Cracks or breakage may cause a personal injury.**

SAVE THESE INSTRUCTIONS.

WARNING:

DO NOT let comfort or familiarity with product (gained from repeated use) replace strict adherence to safety rules for the subject product. **MISUSE** or failure to follow the safety rules stated in this instruction manual may cause serious personal injury.

IMPORTANT SAFETY INSTRUCTIONS

FOR BATTERY CARTRIDGE

1. Before using battery cartridge, read all instructions and cautionary markings on (1) battery charger, (2) battery, and (3) product using battery.
2. Do not disassemble battery cartridge.
3. If operating time has become excessively shorter, stop operating immediately. It may result in a risk of overheating, possible burns and even an explosion.
4. If electrolyte gets into your eyes, rinse them out with clear water and seek medical attention right away. It may result in loss of your eyesight.
5. Do not short the battery cartridge:
 - (1) Do not touch the terminals with any conductive material.
 - (2) Avoid storing battery cartridge in a container with other metal objects such as nails, coins, etc.
 - (3) Do not expose battery cartridge to water or rain.

A battery short can cause a large current flow, overheating, possible burns and even a breakdown.

6. Do not store the tool and battery cartridge in locations where the temperature may reach or exceed 50 ° C (122 ° F).
7. Do not incinerate the battery cartridge even if it is severely damaged or is completely worn out. The battery cartridge can explode in a fire.
8. Be careful not to drop or strike battery.
9. Do not use a damaged battery.

SAVE THESE INSTRUCTIONS.

Tips for maintaining maximum battery life

1. Charge the battery cartridge before completely discharged.
Always stop tool operation and charge the battery cartridge when you notice less tool power.
2. Never recharge a fully charged battery cartridge. Overcharging shortens the battery service life.
3. Charge the battery cartridge with room temperature at 10 ° C - 40 ° C (50 ° F - 104 ° F). Let a hot battery cartridge cool down before charging it.
4. Charge the battery cartridge once in every six months if you do not use it for a long period of time.

FUNCTIONAL DESCRIPTION

⚠CAUTION:

- Always be sure that the tool is switched off and the battery cartridge is removed before adjusting or checking function on the tool.

Installing or removing battery cartridge

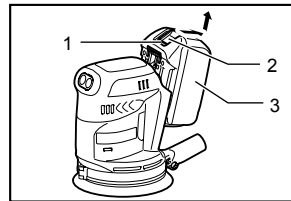

012687

1. Red indicator
2. Button
3. Battery cartridge

⚠CAUTION:

- Always switch off the tool before installing or removing of the battery cartridge.
- **Hold the tool and the battery cartridge firmly when installing or removing battery cartridge.** Failure to hold the tool and the battery cartridge firmly may cause them to slip off your hands and result in damage to the tool and battery cartridge and a personal injury.

To remove the battery cartridge, slide it from the tool while sliding the button on the front of the cartridge.

To install the battery cartridge, align the tongue on the battery cartridge with the groove in the housing and slip it into place. Insert it all the way until it locks in place with a little click. If you can see the red indicator on the upper side of the button, it is not locked completely.

⚠CAUTION:

- Always install the battery cartridge fully until the red indicator cannot be seen. If not, it may accidentally fall out of the tool, causing injury to you or someone around you.
- Do not install the battery cartridge forcibly. If the cartridge does not slide in easily, it is not being inserted correctly.

Battery protection system (Lithium-ion battery with star marking)

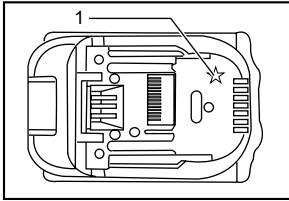

1. Star marking

012128

Lithium-ion batteries with a star marking are equipped with a protection system. This system automatically cuts off power to the tool to extend battery life.

The tool will automatically stop during operation if the tool and/or battery are placed under one of the following conditions:

- **Overloaded:**
The tool is operated in a manner that causes it to draw an abnormally high current. In this situation, stop the application that caused the tool to become overloaded. Then press the start/speed adjusting button again to restart.
If the tool does not start, the battery is overheated. In this situation, let the battery cool before pressing the start/speed adjusting button.
- **Low battery voltage:**
The remaining battery capacity is too low and the tool will not operate. In this situation, remove and recharge the battery.

Switch action and speed adjusting button

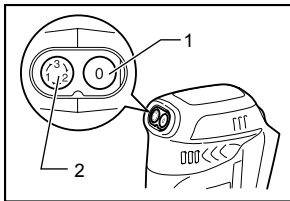

1. Stop button
2. Start/speed adjusting button

012878

To start the tool, press the start/speed adjusting button. The tool starts with high speed mode. Each time you press the start/speed adjusting button, the speed mode changes in an order of hi speed, middle speed, and low speed.

To stop the tool, press the stop button.

Refer to the table for the relationship between the speed mode and the kind of work.

Speed mode	Number of rotations	Usage
High	11,000	Regular sanding
Middle	9,500	Finish sanding
Low	7,000	Polishing

012897

NOTE:

- The table shows standard applications. They may differ under certain conditions.

ASSEMBLY

⚠ CAUTION:

- Always be sure that the tool is switched off and the battery cartridge is removed before carrying out any work on the tool.

Installing abrasive disc

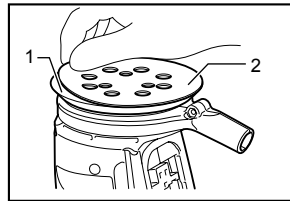

1. Pad
2. Abrasive disc

012875

To install the abrasive disc, first remove all dirt or foreign matter from the pad. Then attach the abrasive disc to the pad. Be careful to align the holes in the abrasive disc with those in the pad.

Installing dust bag (optional accessory)

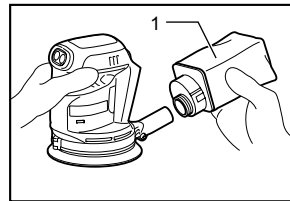

1. Dust bag

012876

Install the dust bag on the tool with its mouth directing downwards.

Emptying dust bag

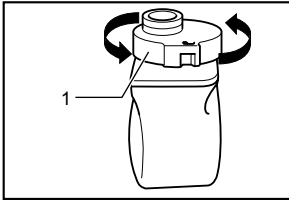

1. Dust nozzle

003323

When the dust bag is about half full, switch off the tool, and remove the dust bag from the tool. Then remove the dust nozzle from the dust bag after unlocking the dust nozzle by turning it slightly counterclockwise. Empty the dust bag by tapping it lightly.

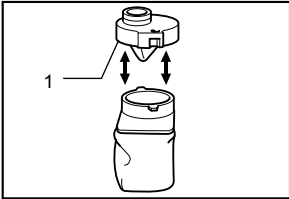

1. Dust nozzle

003326

After emptying the dust bag, install the dust nozzle on the dust bag. Turn the dust nozzle slightly clockwise to lock it in place. Then install the dust bag on the tool as described in "Installing dust bag".

Installing paper filter bag (Optional accessory)

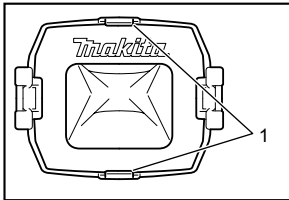

1. Holding tab

009094

Make sure that the logo on the cardboard lip and the logo on the dust box are on the same side, then install the paper filter bag by fitting the cardboard lip in the groove of each holding tab.

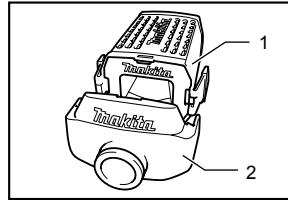

1. Dust box
2. Dust nozzle

009095

Make sure that the logo on the cardboard lip and the logo on the dust nozzle are on the same side, then install the dust nozzle on the dust box.

Removing dust box and paper filter bag

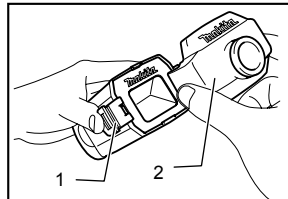

1. Latch
2. Dust nozzle

009092

Remove the dust nozzle by pushing the two latches.

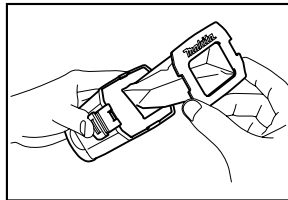

009093

Remove the paper filter bag first by pinching the logo side of its cardboard lip, then by pulling the cardboard lip downwards to move it out of the holding tab of the dust box.

Removing and reinstalling the skirt

⚠ CAUTION:

Do not use the tool without the skirt. Otherwise dust is scattered all over.

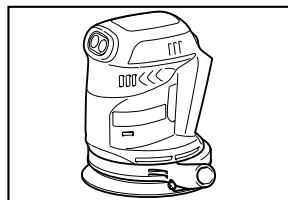

012881

You can choose one of 12 directions of the skirt in accordance with your purpose.

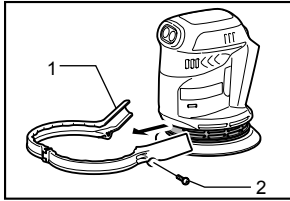

1. Skirt
2. Screw

012885

To remove the skirt, remove the screw and remove the skirt with slightly opening it for both sides.

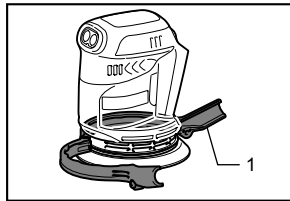

1. Skirt

012945

To reinstall the skirt, install it with slightly opening it for both sides. And fasten the screw.

⚠CAUTION:

Do not set the skirt other than the designated angle. Otherwise the tool may be damaged.

OPERATION

⚠WARNING:

Never switch on the tool when it is in contact with the workpiece, it may cause an injury to operator.

Sanding operation

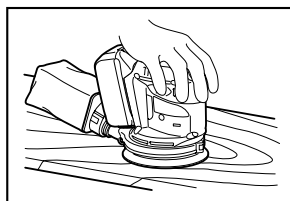

012879

⚠CAUTION:

- Never run the tool without the abrasive disc. You may seriously damage the pad.
- Never force the tool. Excessive pressure may decrease the sanding efficiency, damage the abrasive disc or shorten tool life.

- Using the tool with the pad edge contacting the workpiece may damage the pad.

Hold the tool firmly. Turn the tool on and wait until it attains full speed. Then gently place the tool on the workpiece surface. Keep the pad flush with the workpiece and apply slight pressure on the tool.

⚠CAUTION:

The sanding pad rotates clockwise during the loaded operation, but it may rotate counterclockwise during the no-load operation.

Polishing operation (optional)

⚠CAUTION:

- Use only a Makita genuine sponge pad, felt pad or wool pad (optional accessories).
- Always operate the tool at low speed to prevent work surfaces from heating abnormally.
- Never force the tool. Excessive pressure may decrease the polishing efficiency and cause motor overload, resulting in tool malfunction.

1. Applying wax

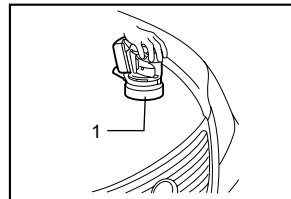

1. Sponge pad

012882

Use an optional sponge pad. Apply wax to the sponge pad or work surface. Run the tool at low speed to smooth out wax.

NOTE:

- First, wax a not conspicuous portion of the work surface to make sure that the tool will not scratch the surface or result in uneven waxing.
- The tool starts with high speed mode. Be careful when you start the tool. The wax may be spattered. It is recommended that you spread wax with the tool stopped before starting up the tool. Change the speed mode to low immediately after you start the tool.
- Always run the tool at low speed. Running it at high speed may cause the wax to spatter.

2. Removing wax

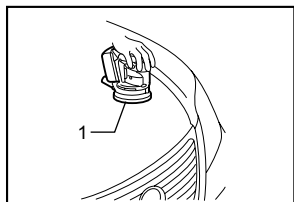

1. Felt pad

012883

Use an optional felt pad. Run the tool at low speed to remove wax.

3. Polishing

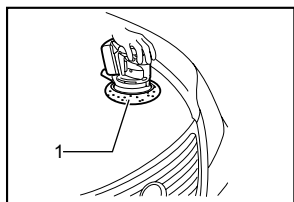

1. Wool pad

012884

Use an optional wool pad. Run the tool at low speed and apply the wool pad gently to the work surface.

- Hook-and-loop type abrasive discs (with pre-punched holes)
- Hook-and-loop type sponge pad
- Hook-and-loop type felt pad
- Hook-and-loop type wool pad
- Makita genuine battery and charger
- Dust box
- Paper filter bag
- Dust bag

NOTE:

- Some items in the list may be included in the tool package as standard accessories. They may differ from country to country.

MAINTENANCE

⚠CAUTION:

- Always be sure that the tool is switched off and the battery cartridge is removed before attempting to perform inspection or maintenance.
- Never use gasoline, benzine, thinner, alcohol or the like. Discoloration, deformation or cracks may result.

To maintain product SAFETY and RELIABILITY, repairs, carbon brush inspection and replacement, any other maintenance or adjustment should be performed by Makita Authorized Service Centers, always using Makita replacement parts.

OPTIONAL ACCESSORIES

⚠CAUTION:

- These accessories or attachments are recommended for use with your Makita tool specified in this manual. The use of any other accessories or attachments might present a risk of injury to persons. Only use accessory or attachment for its stated purpose.

If you need any assistance for more details regarding these accessories, ask your local Makita Service Center.

Makita Corporation
Anjo, Aichi, Japan

885259-224

www.makita.com