

User Guide

Quality, Design and Innovation

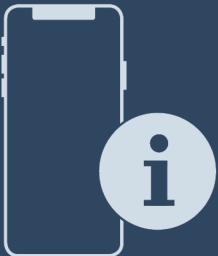

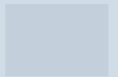















home.liebherr.com/fridge-manuals



LIEBHERR

Contents

1	The appliance at a glance	2
1.2	Delivered contents.....	3
1.3	Appliance and equipment overview.....	3
1.4	Range of appliance use.....	3
1.5	Conformity.....	4
1.6	EPREL Database.....	4
2	General safety instructions	4
3	Start-up	5
3.1	Turning on the appliance.....	5
3.2	Insert the equipment.....	5
4	Food management	5
4.1	Storing food.....	5
4.2	Storage times.....	6
5	Energy saving	7
6	Use	7
6.1	Controls and displays.....	7
6.1.1	Status display.....	7
6.1.2	Navigation.....	7
6.1.3	Operating structure.....	8
6.1.4	Display symbols.....	8
6.2	Operating logic.....	8
6.2.1	Activating/deactivating settings.....	8
6.2.2	Selecting function value.....	8
6.2.3	Activating/deactivating settings.....	9
6.2.4	Selecting the setting value.....	9
6.2.5	Calling up the customer menu.....	9
6.3	Functions.....	9
	Temperature.....	9
	SuperCool.....	10
	SuperFrost.....	10
	PowerCool.....	10
6.3.5	Activating/deactivating settings.....	10
	HolidayMode.....	10
	E-Saver.....	11
6.4	Settings.....	11
	Setting up the WLAN connection*.....	11
	Entry lock.....	11
	Display brightness.....	12
	Door alarm.....	12
	Temperature unit.....	12
	Info.....	12
	SabbathMode.....	12
6.4.8	Choosing the setting.....	13
	D-Value.....	13

	Reminder.....	13
	Reset.....	13
	Turn off appliance.....	13
6.5	Warnings.....	13
6.5.1	Message.....	13
6.5.2	DemoMode.....	13
7	Equipment	14
7.1	Door racks.....	14
7.2	Shelves.....	14
7.3	Split shelf.....	14
7.4	Variable bottle shelf.....	14
7.5	Drawers.....	15
7.6	Fruit & Vegetable-Safe cover.....	16
7.7	Humidity control.....	16
7.8	EasyTwist-Ice*.....	16
7.9	VarioSpace.....	17
7.10	Accessories.....	17
8	Maintenance	17
8.1	FreshAir carbon filter.....	17
8.2	Defrosting the appliance.....	18
8.3	Cleaning the appliance.....	18
9	Customer support	20
9.1	Technical specifications.....	20
9.2	Operating noises.....	20
9.3	Technical faults.....	20
9.4	Customer service.....	21
9.5	Rating plate.....	22
10	Decommissioning	22
11	Disposing of the appliance	22

The manufacturer is constantly working to improve all models. Therefore please understand that we reserve the right to make design, equipment and technical modifications.

To get to know all the benefits of your new appliance, please read the information contained in these instructions carefully.

The instructions apply to several models, so there may be differences. Sections which only apply to certain appliances are indicated with an asterisk (*).

Instructions requiring the user to take action are marked with ►, the results of an action are marked with a ▷.

These operating instructions apply to:

CBN (sf)(pc)(bb) (e)(d)(c)	52..57..(i)
----------------------------	-------------

Note

If your appliance has an N in its appliance designation, it is a NoFrost appliance.

1 The appliance at a glance

- Natural coolant
- Energy-optimized refrigerant circuit
- Energy-efficient insulation
- Low energy consumption
- User-friendly electronic controls
- Active function indicators
- Temperature can be controlled in the appliance independent of ambient conditions according to its climate rating - Temperature can be displayed as °C or °F
- The appliance defrosts automatically - no need to spend time defrosting
- Large refrigeration capacity

- Safety glass storage shelves
- Large freezing capacity
- Shelves can be removed to make space for large items.
- Freezer over-temperature alarm
- Quick-freeze feature for fresh food (SuperFrost)
- Frozen food temperature indicator
- Power outage /FrostControl display
- All freezer drawers suitable for quick-freeze
- Bright LED interior light
- Door ajar alarm
- Handle grips on all extra-large drawers for easy transport
- Integrated transport grips on appliance housing
- Transport castors at back
- Easy to clean
- This appliance has a SabbathMode function, so you can use it on religious holidays. Further information can be found on the Star-K website www.star-k.org.

- (2) Control elements
- (3) Fan with FreshAir activated charcoal filter
- (4) Stainless steel rear panel
- (5) Split shelf
- (6) Shelf
- (7) Variable bottle shelf
- (8) Lid for Fruit & Vegetable-Safe
- (9) Fruit & Vegetable-Safe
- (11) Drain hole
- (12) Freezer drawer
- (13) Serial tag
- (14) EasyTwist-Ice*
- (15) Can rack
- (16) Bottle shelf
- (17) Bottle rack
- (18) Adjustable feet (front)

Note

- The shelves, drawers, and baskets are arranged for optimal energy efficiency in the factory configuration. However, changes to the arrangement within the given insertion options – for example the arrangement of shelves in the fridge compartment – have no effect on energy consumption.

1.2 Delivered contents

Check all parts for damage during transport. If you have any complaints, please contact the dealer or Customer Service (see 9.4 Customer service).

Delivery contains the following parts:

- Standalone appliance
- Equipment (depending on your model)
- Installation parts (depending on your model)
- "Quick Start Guide"
- "Installation Guide"
- Service brochure

1.3 Appliance and equipment overview

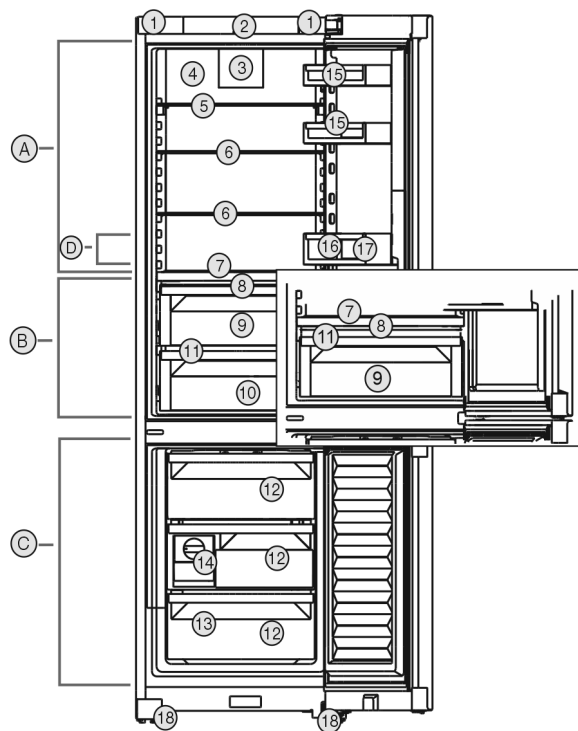

Fig. 1 Illustration example

Temperature range

- (A) Fridge compartment
- (B) BioFresh
- (C) Freezing compartment
- (D) Coldest zone

Features

- (1) Transport handles
- (10) Meat & Dairy-Safe*

1.4 Range of appliance use

Normal use

The appliance is only suitable for cooling food for residential or other similar environments. This includes the following types of uses

- in staff kitchens, bed and breakfasts,
- by guests in country homes, hotels, motels and other types of accommodations,
- for catering and similar wholesale services.

The appliance is not suitable as a built-in unit; All other types of uses are not permitted.

Foreseeable misuse

The following uses are specifically prohibited:

- Storage and cooling of medication, blood plasma, laboratory preparations or similar substances and products in accordance with the Medical Device Directive 2007/47/EC
- Use in areas at risk of explosion
- Use on moving surfaces such as ships, rail transport or airplanes
- Storage of live animals

Incorrect appliance use can cause damage to the stored products or cause them to spoil.

Climate ratings

The appliance is set to operate within specific ambient temperature limits according to its climate rating. The climate rating for your appliance is printed on the rating plate

Note

- To guarantee trouble-free operation, comply with the indicated ambient temperatures.

Climate rating	for ambient temperatures from
SN	10 °C to 32 °C
N	16 °C to 32 °C
ST	16 °C to 38 °C

General safety instructions

Climate rating	for ambient temperatures from
T	16 °C to 43 °C

1.5 Conformity

The refrigerant circuit has been tested for leaks. The appliance complies with the applicable safety regulations and with the directives 2014/35/EU, 2014/30/EU, 2009/125/EC, 2011/65/EU, 2010/30/EU and 2014/53/EU.

The full text of the EU Declaration of Conformity is available on the following website: www.Liebherr.com

The BioFresh compartment meets the requirements of a cold storage compartment as set out in DIN EN 62552:2020.

1.6 EPREL Database

Details about energy labeling and ecodesign requirements will be available on the European product database (EPREL) from March 1, 2021. You can access the product database at the following link: <https://eprel.ec.europa.eu/> You will be asked to enter the model ID. You can find the model ID on the type plate.

2 General safety instructions

Dangers for the user:

- This appliance can be operated by children as well as by persons with reduced physical, sensory or mental capabilities or lack of experience and knowledge if they are supervised or have been instructed in the safe use of the appliance and understand the associated risks. Children must not play with the appliance. Cleaning and user maintenance must not be performed by children unless they are supervised. Children between the ages of 3 and 8 may load and unload the appliance. Children under the age of 3 must be kept away from the appliance if they are not constantly supervised.
- When disconnecting the appliance from the outlet, always take hold of the plug. Do not pull on the cable.
- Disconnect the power plug or switch off the power if a fault occurs.
- Do not damage the mains power line. Do not operate the appliance from a defective mains power line.
- Repairs and operations on the appliance may only be carried out by the customer service department or other specifically trained specialist engineers.
- The appliance should only be assembled, connected and disposed of in accordance with the instructions.
- Please keep the instructions and pass them on to any future owner.

Risk of fire:

- The refrigerant contained within the appliance (specifications on the rating plate) is environ-

mentally friendly, but flammable. Leaking refrigerant can ignite.

- Do not damage the pipes of the refrigerant circuit.
- Do not handle ignition sources inside the appliance.
- Do not use electrical devices inside the appliance (e.g. steam cleaners, heaters, ice cream makers, etc.).
- If refrigerant leaks: Remove naked flames or ignition sources located near the area of the leak. Air the room well. Contact the customer service department.
- Do not store explosive materials or spray cans with flammable propellants, such as e.g. butane, propane, pentane, etc. in the appliance. You can recognize such spray cans by the printed contents or a flame symbol. Any leaking gasses can be ignited by electrical components.
- Keep burning candles, lamps and other objects with open flames away from the appliance so that they do not set it on fire.
- Alcoholic beverages or other containers holding alcohol must always be tightly sealed for storage purposes. Any leaking alcohol can be ignited by electrical components

Tipover hazard:

- Do not stand or climb on the base, drawers, doors, etc. This applies in particular to children.

Risk of food poisoning:

- Do not consume food that has passed its best before date.

Danger of frostbite, feelings of numbness and pain:

- Avoid continued skin contact with cold surfaces or chilled/frozen food or adopt protective measures.

Risk of injury and damage:

- Hot steam may lead to injuries. Do not use any electrical heating or steam cleaning equipment, naked flames or defrosting sprays for defrosting
- Do not remove ice with sharp objects

Risk of crushing:

- Do not hold onto the hinge when opening and closing the door. Fingers may get caught.

Symbols on the device:



The symbol can be on the compressor. It refers to the oil in the compressor and refers to the following danger: Can be lethal if swallowed or inhaled. This notice only applies for recycling. There is no danger during normal operation.



The symbol is located on the compressor and indicates the danger of inflammable materials. Do not remove the label.



This label or a similar one can be located on the rear of the appliance. It refers to the foamed-in panels in the door and/or the housing. This notice only applies for recycling. Do not remove the label.

Follow the specific instructions in the other sections:

	DANGER	indicates a hazardous situation, which if not avoided, will result in death or serious injury.
	WARNING	indicates a hazardous situation, which if not avoided, could result in death or serious injury.
	CAUTION	indicates a hazardous situation, which if not avoided, will result in minor or moderate injury.
	NOTICE	indicates a hazardous situation, which if not avoided, could result in damage to property.
	Note	indicates useful advice and tips

3 Start-up

3.1 Turning on the appliance

Make sure that the following requirements are met:

- Appliance is set up and connected according to installation instructions.
- All adhesive strips, adhesive and protective films, as well as transport safety devices in and on the appliance are removed.
- All advertising material has been removed from the drawers.
- ▶ Switch on the appliance using the control panel next to the display.

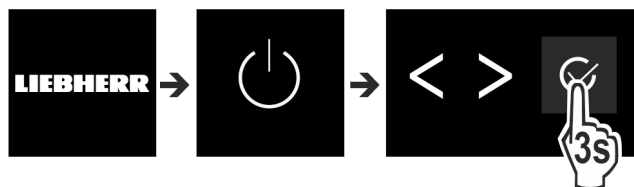

Fig. 2

- ▶ The status screen appears.
- ▶ If the DemoMode is displayed after switching on the appliance, the DemoMode can be deactivated within the next 5 minutes.

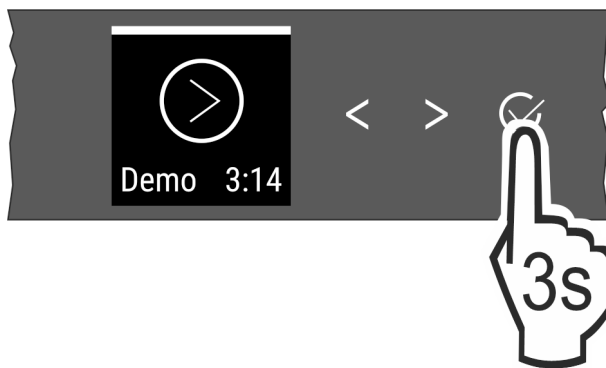

Fig. 3

- ▶ Press the confirmation button next to the display for 3 seconds.
- ▷ DemoMode is deactivated.

Note

The manufacturer recommends:

- ▶ Putting away groceries: Wait approx. 6 hours until the set temperature has been reached.
- ▶ Store **frozen produce** at -18 °C or colder.

3.2 Insert the equipment

- ▶ Insert the supplied equipment to help you make the most of the appliance.
- ▶ Purchase the SmartDevice Box and insert it (see <https://smartdevice.liebherr.com/install>).*
- ▶ Install the SmartDevice app (see <https://apps.home.liebherr.com/>).

Note

You can purchase accessories from the [Liebherr household appliance store](http://home.liebherr.com) (home.liebherr.com).

4 Food management

4.1 Storing food



WARNING

Danger of fire

- ▶ Do not use electrical appliances inside the food storage compartments of the appliance, unless they are of the type recommended by the manufacturer.

Note

Insufficient ventilation results in an increase in energy consumption and reduction of the refrigerating performance

- ▶ Always keep the air slots unobstructed.

When storing food, remember these basic rules:

- Do not obstruct the air vents on the back wall.
- Food is well sealed.
- Food that easily absorbs or emits odor or taste, are in sealed containers or are covered.
- Raw meat or fish is in clean, sealed containers so that other food cannot be touched or drip on them.
- Liquids are in sealed containers.
- Food is stored spaced apart to ensure good air circulation.

Note

Failure to follow these guidelines can lead to food perishing.

Food management

4.1.1 Fridge

The natural air circulation means the temperature varies in different sections.

Arranging the food:

- ▶ In the top section and in the door: butter and cheese, preserves, and tubes.
- ▶ The coldest zone *Fig. 1 (D)* is for: easily perishable food such as prepared meals.

4.1.2 BioFresh

BioFresh allows some fresh food to be stored longer compared to conventional cooling.

Food with a "use by" date must still be consumed by the date indicated on the package

If the temperature drops below 0 °C, food can start to freeze.

Note

Store cold-sensitive fruit and vegetables in the cooling section, such as cucumber, eggplant, zucchini, and tropical fruit.

Fruit & Vegetable-Safe

This provides a fresh storage climate with the lid closed. A moist climate is suitable for storing unsealed food with a high moisture content (e.g. salad, vegetables, fruit).

The humidity depends on the moisture content of the stored items and how frequently the door is opened. You can regulate the moisture.

Arranging the food:

- ▶ Place unsealed fruit and vegetables.
- ▶ Excessive moisture: Regulate the air humidity (see 7.7 Humidity control).

Meat & Dairy-Safe

The DrySafe provides a relatively dry storage environment. A dry climate is suitable for dry or sealed food (e.g. dairy products, meat, fish, sausage).

Arranging the food:

- ▶ Place dry or sealed food.

4.1.3 Freezer

This provides a dry, frosty storage climate at -18 °C. A frosty climate is suitable for storing frozen food and goods for several months, preparing ice cubes, or freezing fresh food.

Freezing food

You can freeze as many kilograms of fresh food within 24 hours as indicated on the nameplate (see 9.5 Rating plate) under "freezing capacity ... kg/24h".

To ensure that the food freezes quickly to the core, keep to the following quantities per pack:

- Fruit, vegetables up to 1 kg
- Meat up to 2.5 kg

Before freezing, please note the following:

- SuperFrost is activated (see 6.3 Functions) when the amount of food to freeze exceeds approx. 2 kg.
- With a small volume of frozen goods: SuperFrost is activated approx. 6 hours prior.
- With the maximum volume of frozen goods: SuperFrost is activated approx. 24 hours prior.

Arranging the food:



CAUTION

There is a risk of injury from pieces of broken glass! Bottles and cans containing drinks can split or crack when frozen. This applies in particular to carbonated drinks.

- ▶ The *BottleTimer* function must be used when freezing bottles and cans with drinks.

With a small volume of frozen goods:

- ▶ Place sealed food in the top drawers.
- With the maximum volume of frozen goods:
- ▶ Remove the top drawers and place sealed food on the top shelves.

With the maximum capacity of frozen goods:

- ▶ Once SuperFrost activates automatically, place food into the drawer.

Defrosting food

- in the fridge compartment
- in the microwave
- in the oven/fan oven
- at room temperature



WARNING

Danger of food poisoning!

- ▶ Do not re-freeze defrosted food.

- ▶ Remove only the food you need for now.
- ▶ Use defrosted food as quickly as possible

4.2 Storage times

The storage times given are guidelines

Food with a "use by" date must still be consumed by the date indicated on the package

4.2.1 Fridge

The best-before date stated on the packaging applies.

4.2.2 BioFresh

Note

You can check the guideline settings in the BioFresh app <https://home.liebherr.com/de/deu/service/apps/landingpage/apps-emea.html>.

Guideline storage times for the Meat & Dairy-Safe		
Butter	at 1 °C	up to 90 days
Hard cheese	at 1 °C	up to 110 days
Milk	at 1 °C	up to 12 days
Sausage, cold cuts	at 1 °C	up to 8 days
Poultry	at 1 °C	up to 6 days
Pork	at 1 °C	up to 6 days
Beef	at 1 °C	up to 6 days
Game	at 1 °C	up to 6 days

Note

- ▶ Note that higher-protein foods spoil more quickly. So, shellfish and crustaceans perish faster than fish, and fish perishes faster than meat.

Guideline storage times for the Fruit & Vegetable-Safe	
Vegetables, lettuce	

Guideline storage times for the Fruit & Vegetable-Safe		
Artichokes	at 1 °C	up to 14 days
Celery	at 1 °C	up to 28 days
Cauliflower	at 1 °C	up to 21 days
Broccoli	at 1 °C	up to 13 days
Endives	at 1 °C	up to 27 days
Mâche	at 1 °C	up to 19 days
Peas	at 1 °C	up to 14 days
Kale	at 1 °C	up to 14 days
Carrots	at 1 °C	up to 80 days
Garlic	at 1 °C	up to 160 days
Cabbage turnip	at 1 °C	up to 14 days
Iceberg lettuce	at 1 °C	up to 13 days
Herbs	at 1 °C	up to 13 days
Leeks	at 1 °C	up to 29 days
Mushrooms	at 1 °C	up to 7 days
Radishes	at 1 °C	up to 10 days
Brussels sprouts	at 1 °C	up to 20 days
Asparagus	at 1 °C	up to 18 days
Spinach	at 1 °C	up to 13 days
Savoy cabbage	at 1 °C	up to 20 days
Fruit		
Apricots	at 1 °C	up to 13 days
Apples	at 1 °C	up to 80 days
Pears	at 1 °C	up to 55 days
Blackberries	at 1 °C	up to 3 days
Dates	at 1 °C	up to 180 days
Strawberries	at 1 °C	up to 7 days
Figs	at 1 °C	up to 7 days
Blueberries	at 1 °C	up to 9 days
Raspberries	at 1 °C	up to 3 days
Red currants	at 1 °C	up to 7 days
Cherries, sweet	at 1 °C	up to 14 days
Kiwi	at 1 °C	up to 80 days
Peaches	at 1 °C	up to 13 days
Plums	at 1 °C	up to 20 days
Cranberries	at 1 °C	up to 60 days
Rhubarb	at 1 °C	up to 13 days
Gooseberries	at 1 °C	up to 13 days
Grapes	at 1 °C	up to 29 days

4.2.3 Freezer

Guidelines for storage periods for various foods		
Ice cream	at -18 °C	2 to 6 months
Sausage, ham	at -18 °C	2 to 3 months
Bread, bakery products	at -18 °C	2 to 6 months

Guidelines for storage periods for various foods		
Game, pork	at -18 °C	6 to 9 months
Fish, fatty	at -18 °C	2 to 6 months
Fish, lean	at -18 °C	6 to 8 months
Cheese	at -18 °C	2 to 6 months
Poultry, beef	at -18 °C	6 to 12 months
Vegetables, fruit	at -18 °C	6 to 12 months

5 Energy saving

- Always ensure good ventilation. Do not obstruct ventilation openings or grilles.
- Never block air slits in the fan.
- Do not install the appliance in direct sunlight or next to a stove, heater or similar heat source.
- Energy consumption depends on installation conditions such as the ambient temperature (see 1.4 Range of appliance use) . A warmer ambient temperature can increase the energy consumption.
- Avoid opening the appliance door for any longer then necessary
- The lower the temperature is set the higher the energy consumption.
- Sort your food items: home.liebherr.com/food.
- All food stored in the appliance should be well wrapped and covered. This prevents frost buildup.
- Only take food out for as long as necessary so that it does not get too warm.
- Insertion of warm foods: first let the food cool down to room temperature.
- Defrost frozen food in the fridge
- For longer periods of absence, use HolidayMode (see HolidayMode) .

6 Use

6.1 Controls and displays

The display provides a quick overview of the temperature setting and the status of functions and settings. You can control the functions and settings either by deactivating/activating them or by selecting a value.

6.1.1 Status display

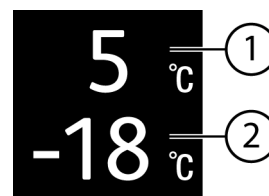

Fig. 4

(1) Fridge compartment temperature display

(2) Freezer compartment temperature display

6.1.2 Navigation

Navigate in the menu to access the individual functions. An audible signal sounds after confirming a function or setting. If no selection is made after 10 seconds the display switches to the Status screen.

The appliance is operated with the buttons next to the display.



Fig. 5

(1) Left/right navigation arrow

(2) Confirm

Left/right navigation arrow Fig. 5 (1):

- Navigating in the menu. After the last menu page, it goes back to the first one.

Confirm Fig. 5 (2):

- Activating/deactivating a function.
- Opening a submenu.
- Confirming a selection. After confirmation the display switches back to the menu.

Back to the Status display: in the fastest possible manner:

- Close and open the door.
- or wait 10 seconds. The display changes to the Status display.

6.1.3 Operating structure

The controls are explained by a template. The display changes depending on the function or settings.

Menu without submenu

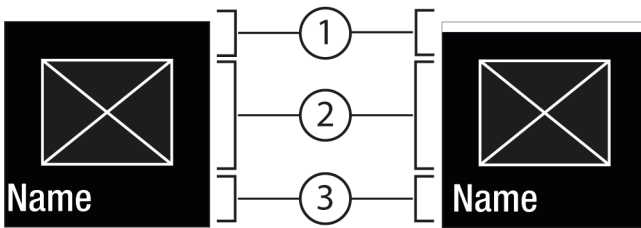

Fig. 6

(1) Status deactivated / status activated white bar in the top area

(2) Symbol or selected value

(3) Menu: Function name or menu: Setting name

Menu with submenu

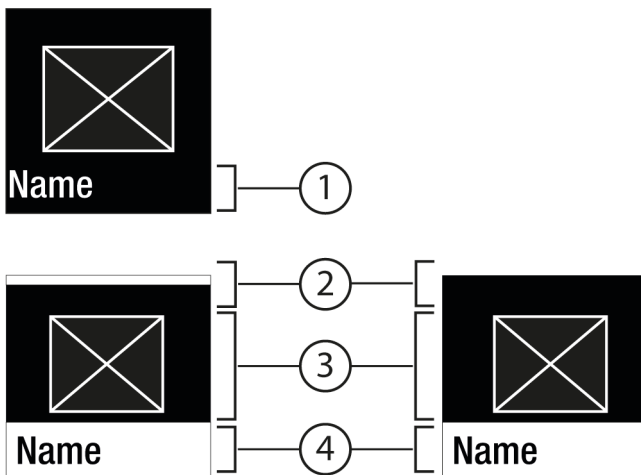

Fig. 7

(1) Menu: Function name or menu: Setting name

(2) Status

(3) Symbol or selected value

(4) Submenu: Function name or submenu: Setting name

(2) Off / On

You can navigate as follows:

- Navigate with the left/right navigation arrow Fig. 5 (1).
- Press Confirm Fig. 5 (2) to go to the submenu Fig. 7 (4).
 - Navigate with the left/right navigation arrow Fig. 5 (1).
 - Set new level: Press Confirm Fig. 5 (2) to select a deselected value Fig. 6 (1).
 - Back to menu: Press Confirm Fig. 5 (2) to select the selected value Fig. 6 (2).

6.1.4 Display symbols

The display symbols provide information about the current appliance status.

Symbol	Appliance status
	Standby The appliance or temperature zone is turned off.
	Flashing number Appliance is working. Temperature flashes until the set temperature is reached.
	Flashing symbol Appliance is working. Setting is made.
	Bar grows steadily The function is being activated.

6.2 Operating logic

6.2.1 Activating/deactivating settings

You can activate/deactivate the following functions:



Symbol	Function
	SuperCool*
	PowerCool*
	SuperFrost*
	HolidayMode
	E-Saver

* When a function is on, the appliance works harder. This means the appliance could make louder noises and consume more energy.

- ▶ Press the navigation arrows Fig. 5 (1) until appears.
- ▶ Press Confirm Fig. 5 (2).
- ▷ You hear the confirmation tone.
- ▷ Status appears in the menu.
- ▷ Function is on/off.

6.2.2 Selecting function value

With the following functions you can set a value in the submenu:

Symbol	Function
	Cool: Setting the temperature Turn on/off the temperature zone
	Freeze: Setting the temperature Turn on/off the temperature zone

- ▶ Press the navigation arrows *Fig. 5 (1)* repeatedly until the function is displayed.
- ▶ Press Confirm *Fig. 5 (2)*.
- ▶ Select the setting value with the navigation arrows *Fig. 5 (1)*.

Setting the temperature







- ▶ Press *Fig. 5 (2)* confirm.
- ▷ You hear the confirmation tone.
- ▷ Status: on *Fig. 6 (1)* appears briefly in the submenu *Fig. 7 (4)*.
- ▷ Display switches back to the menu.

Switching the temperature zone on/off

- ▶ Press Confirm for 3 seconds.
- ▷ You hear the confirmation tone.
- ▷ Display returns to the status screen.

6.2.3 Activating/deactivating settings

You can activate/deactivate the following settings:

Symbol	Setting
	WiFi ¹
	Entry lock ²
	SabbathMode ²
	Reminders ¹
	Reset ²
	Switch off ²

- ▶ Press the navigation arrows *Fig. 5 (1)* repeatedly until the settings  are displayed.
- ▶ Press Confirm *Fig. 5 (2)*.
- ▶ Press the navigation arrows *Fig. 5 (1)* repeatedly until the desired setting is displayed.

¹ Activate setting (short press)



- ▶ Press Confirm *Fig. 5 (2)*.
- ▷ You hear the confirmation tone.
- ▷ Status appears in the menu.
- ▷ Setting is activated / deactivated.

² Activate setting (long press)

- ▶ Press Confirm *Fig. 5 (2)* for 3 seconds.
- ▷ You hear the confirmation tone.
- ▷ Status appears in the menu.
- ▷ Display changes.

6.2.4 Selecting the setting value



With the following settings you can set a value in the submenu:



Symbol	Settings
	Brightness
	Door alarm
	Temp. unit

- ▶ Press the navigation arrows *Fig. 5 (1)* repeatedly until the settings  are displayed.
- ▶ Press Confirm *Fig. 5 (2)*.
- ▶ Press the navigation arrows *Fig. 5 (1)* repeatedly until the desired setting is displayed.
- ▶ Press Confirm *Fig. 5 (2)*.
- ▶ Select the setting value with the navigation arrows *Fig. 5 (1)*.
- ▶ Press Confirm *Fig. 5 (2)*.
- ▷ You hear the confirmation tone.
- ▷ Status appears briefly in the submenu.
- ▷ Display switches back to the menu.

6.2.5 Calling up the customer menu

The customer menu provides the following settings:

Symbol	Function
	D-Value ¹
	Software

- ▶ Press the navigation arrows *Fig. 5 (1)* so often until the settings  are displayed.
- ▶ Press Confirm *Fig. 5 (2)*.
- ▶ Press the navigation arrows *Fig. 5 (1)* so often until the appliance information  appears in the display.
- ▶ Press Confirm *Fig. 5 (2)*.
- ▶ Call up the customer menu: Enter the code 151.
- ▶ Press the navigation arrows *Fig. 5 (1)* in the customer menu so often until the desired setting is displayed.

¹ Select the setting value

- ▶ Press Confirm *Fig. 5 (2)*.
- ▷ You hear the confirmation tone.
- ▷ Status appears briefly in the display.
- ▷ The display switches back to the menu.

² Activate setting

- ▶ Press Confirm *Fig. 5 (2)* for 3 seconds.
- ▷ You hear the confirmation tone.
- ▷ Status appears in the display.
- ▷ The symbol flashes as long as the appliance is working.

6.3 Functions

Temperature

The temperature depends on the following factors:

- the number of times the door is opened
- The duration the door is opened
- the room temperature of the installation location
- the type, temperature and amount of food

Temperature zone	Recommended setting
5 °C Fridge	5 °C
-18 °C Freezing compartment	-18 °C
0 °C BioFresh	

Setting the temperature

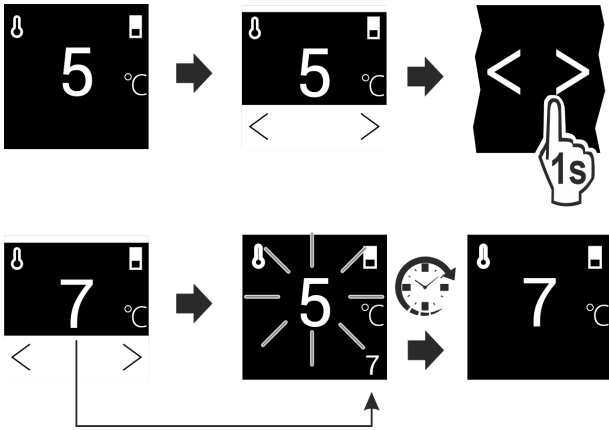

Fig. 8

- ▶ Set the value. (see 6.2 Operating logic) .
- ▷ The set temperature is shown on the bottom right of the display.

Switching off the temperature zone

The fridge section can be switched off separately.

When the freezer is switched off, all temperature zones are switched off.

- ▶ Set the value. (see 6.2 Operating logic) .

▷  appears.

Setting the temperature in the BioFresh

You can set the temperature using the **BioFresh B-Value** in the customer menu.

SuperCool

Select this function for the maximum cooling setting, to reach lower cooling temperatures.

This function is relevant to the fridge section *Fig. 1 (A)*

Use:

- Cool large amounts of food quickly.

Activating/deactivating settings

- ▶ Using the fridge section: activate the function when you add the goods.
- ▶ Activating/deactivating (see 6.2 Operating logic) .

-or-

- ▶ Activating/deactivating in the Liebherr SmartDevice-App.*

The function automatically turns off. The appliance goes back to normal mode. The temperature adjusts itself to the set level.

SuperFrost

Select this function for the maximum freezing setting, to reach lower freezing temperatures.

This function is relevant to the freezer section *Fig. 1 (C)*.

Use:

- To freeze more than 2 kg fresh food a day.
- Freezing fresh food quickly to the core.
- Increasing the cold reserves in the stored goods before defrosting the appliance.

Activating/deactivating settings

With a small volume of frozen goods:

- ▶ Activate 6 hours before use.
- With the maximum volume of frozen goods:
- ▶ Activate 24 hours before use.
- ▶ Activating/deactivating (see 6.2 Operating logic) .

-or-

- ▶ Activate/deactivate in the [Liebherr SmartDevice-App](#).*

The function automatically turns off. The appliance goes back to normal mode. The temperature adjusts itself to the set level.

PowerCool

This function provides the perfect blanket temperature to cool your food.

This function is relevant to the fridge section *Fig. 1 (A)*.

Use:

- For higher room temperatures (from approx. 35 °C)
- At high air moisture e.g. on summer days
- When storing moist goods, to avoid condensation building up inside

Activating/deactivating settings

- ▶ Activating/deactivating (see 6.2 Operating logic) .

Note

The fan can keep running even if the function has been deactivated. This ensures optimum temperature distribution in the appliance.

- ▷ Function activated: Energy consumption of the appliance is slightly increased.

This option offers an assortment of special functions and settings that are useful if you are having a party.

The following functions are activated:

- *SuperCool*
- *SuperFrost*

You can set any functions you like. Your changes are lost when the option is switched off.

6.3.5 Activating/deactivating settings

- ▶ Activating/deactivating (see 6.2 Operating logic) .
- ▷ On: All functions are activated at the same time.
- ▷ Deactivated: Previously set temperatures are restored.

The function is automatically switched off after 24 hours.

HolidayMode

This function minimizes the energy consumption during an extended absence. The temperature of the refrigerator

compartment is set to 15 °C and this is displayed on the status screen when the temperature has been reached.

The set freezer temperature remains unchanged.

This function is relevant to the fridge section *Fig. 1 (A)*.

Use:

- Save energy if you plan to be away for a while.
- Avoid coming home to bad smells and mold.

Activating/deactivating settings

- ▶ Empty everything from the fridge section.
- ▶ Activating/deactivating (see 6.2 Operating logic) .
- ▷ On: Fridge temperature is raised.
- ▷ Off: The previously set temperature is restored.



E-Saver

This function reduces energy consumption. If you activate this function, the cooling temperature increases.

Temperature zone	Recommended setting (see Temperature)	Temperature when E-Saver activated
5 °C Fridge compartment	5 °C	7 °C
-18 °C Freezing compartment	-18 °C	-16 °C

Use:

- Save energy.

Activating/deactivating settings

- ▶ Activating/deactivating (see 6.2 Operating logic) .
- ▷ Activated: Higher temperatures are set in all temperature zones.
- ▷ Deactivated: Previously set temperatures are restored.

6.4 Settings



Setting up the WLAN connection*

This setting connects the appliance to the internet. The connection is managed in the SmartDevice Box. You can use the SmartDevice-App to add your appliance to a SmartHome-System. Use the SmartDevice-App or other compatible partner networks to enjoy advanced options and settings.

Note

The SmartDevice Box is available from the [Liebherr Residential Appliances Store \(https://home.liebherr.com/shop/de/deu/smartdevicebox.html\)](https://home.liebherr.com/shop/de/deu/smartdevicebox.html).

More information about the availability, prerequisites and individual options can be found on the Internet at <https://smartdevice.liebherr.com/install>.

Use:

- Manage the appliance with the SmartDevice-App or a compatible partner network.
- Enjoy advanced functions and settings.
- Check the appliance status on the SmartDevice-App.

□ Install the SmartDevice app (see <https://apps.home.liebherr.com/>).

Setting up the WLAN connection

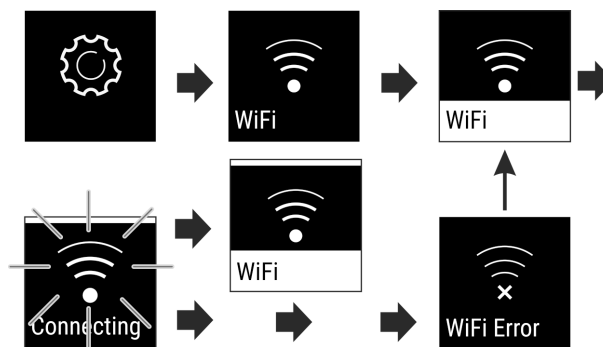

Fig. 9

- ▶ Activate (see 6.2 Operating logic) .
- ▷ The connection is set up: Status: on *Fig. 6 (1)* and WiFi connecting appears. The symbol flashes.
- ▷ The connection is set up: Status: on *Fig. 6 (1)* appears.
- ▷ The connection failed: Status and Connect appears. The symbol appears permanently.

Disconnecting

- ▶ Deactivate the setting (see 6.2 Operating logic) .

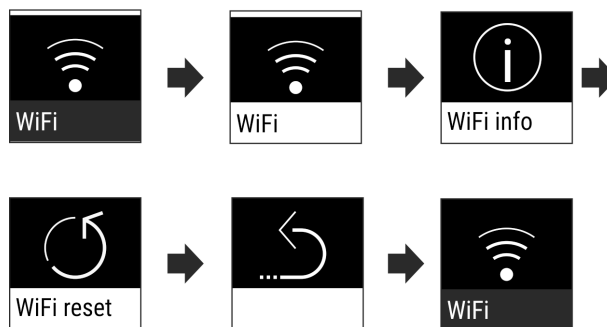

Fig. 10

- ▷ There is no connection: The symbol is displayed constantly.

Restoring the connection

- ▶ Restore settings (see 6.2 Operating logic) .

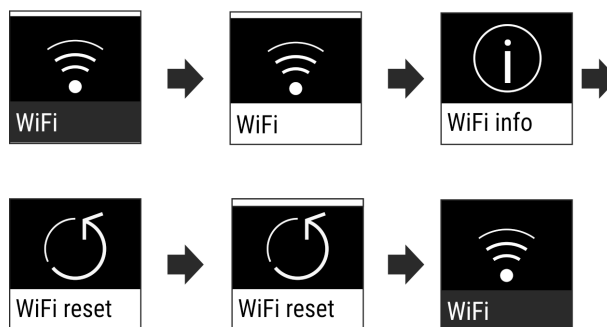

Fig. 11

- ▷ Connection and other settings are restored to factory settings.



Entry lock

This setting avoids accidental operation of the appliance, e.g. by children.

Use:

- Avoid unintentional changing of settings and functions.
- Avoid unintentional switching off of the appliance.
- Avoid unintentional temperature adjustments.

Activating/deactivating settings

- ▶ Activating/deactivating (see 6.2 Operating logic) .



Display brightness

With this setting, you can choose a brightness level for the display.

You can set the following brightness levels:

- 40%
- 60%
- 80%
- 100%

Choosing the setting

- ▶ Set the level (see 6.2 Operating logic) .



Door alarm

Set the time before the door alarm (see Close door) sounds.

Options are as follows:

- 1 min
- 2 min
- 3 min
- Off

Choosing the setting

- ▶ Set the level (see 6.5 Warnings) .



Temperature unit

This setting allows you to change between Celsius and Fahrenheit as the temperature unit.

Selecting the setting value

- ▶ Set the value (see 6.2 Operating logic) .



Info

This setting allows the appliance information to be read out as well as access to the customer menu.

It provides the following information:

- Model name
- Index
- Serial number
- Service number

View appliance data

- ▶ Press the navigation arrows *Fig. 5 (1)* repeatedly until the settings  are displayed.
- ▶ Press Confirm *Fig. 5 (2)*.
- ▶ Press the navigation arrows *Fig. 5 (1)* repeatedly until the information display appears.
- ▶ Read the appliance data.



SabbathMode

This setting meets the religious requirements on the Sabbath and Jewish festivals. Turn on SabbathMode to switch off certain controls. This means you can use the appliance without anyone changing any settings.

You can find a list of Star-K-certified appliances at www.star-k.org/appliances.



WARNING

Danger of food poisoning!

If there is a power outage when SabbathMode is on, this message is not saved. When the power is restored, the appliance continues in SabbathMode. Afterwards, the temperature display does not show a message about the power outage.

If there was a power outage during SabbathMode:

- ▶ Check the quality of the food. Do not consume spoiled food!

What happens on the appliance when in SabbathMode:

- The Status display permanently shows SabbathMode.
- The display is locked for all functions apart from turning off SabbathMode.
- Any functions/settings that are already on, remain active.
- The display stays bright when the door is closed.
- Reminders are disabled. The set timer interval is also stopped. The function is no longer executed in SabbathMode.
- Reminders and warnings are not displayed. No acoustic signals are emitted and the display does not show warnings / settings such as temperature alarm or door alarm.
- The internal light is off.
- The defrost cycle only works for the specified time without taking account of fridge use.
- After a power cut the appliance automatically returns to SabbathMode.

Activating/deactivating SabbathMode

- ▶ To activate this function, click the arrows next to the display until you see the Settings  menu item and then confirm. The menu shows the available settings.
- ▶ Click the arrows next to the display until you see the SabbathMode (Menora) symbol. Confirm the symbol.
 - ▷ A white bar appears in the top part of the display.
 - ▷ SabbathMode has been activated.

To deactivate this function, press the confirmation button next to the display for 3 seconds.

SabbathMode has been deactivated.

In the delivery condition of the appliance, the value is set to **B5**. The status indicator on the display shows the appropriate target temperature in the BioFresh.

You can change this value slightly if a higher or lower ambient temperature makes it necessary. When setting the value, note:

Value	Description
B1	Lowest temperature
B1-B4	The temperature can drop to below 0 °C, so food can freeze easily.
B5	Default temperature
B9	Highest temperature

BioFresh B-Value

6.4.8 Choosing the setting

- ▶ Make your settings in the Customer menu (see 6.2 Operating logic).

D1 D-Value

The *D-Value* is preset for your appliance and may not be changed.

Reminder

Reminders are displayed acoustically by a beep and visually by a symbol in the display. The signal gets louder until the alert stops.

Replace the FreshAir active carbon filter

This message appears when the air filter needs replacing.

- ▶ Replace the air filter every six months.
- ▶ Confirm the message with OK.
- ▷ The service interval resets.
- ▷ The air filter guarantees the air quality in the fridge.

Activate setting

- ▶ Activating/deactivating (see 6.2 Operating logic).

Reset

This function resets all settings to the factory settings. All settings that you have made thus far will be reset to their original values.

Activate the setting

- ▶ Activating (see 6.2 Operating logic).

Turn off appliance

This setting turns off the whole appliance.

Switch off whole appliance

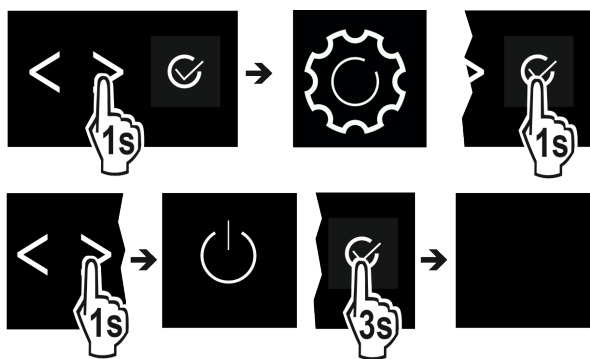

Fig. 12

- ▶ Activating/deactivating (see 6.2 Operating logic).
- ▷ Off: Display turns black.

6.5 Warnings

Warnings are issued with an acoustic signal and visually with a symbol on the display. The signal gets louder until the alert stops.

6.5.1 Message

Close door

This message appears if the door is open too long.

You can set the time before this message appears.

- ▶ Stop alarm: Confirm the message.

-or-

- ▶ Close the door.

Power failure.

This message appears if the freezer temperature rises after a power outage. When the power outage is over, the appliance will continue to operate at the last temperature setting.

- ▶ Stop alarm: Confirm the message.
- ▷ Temperature alarm appears (see Temperature alarm).

Temperature alarm

This message appears if the freezer temperature does not match the set temperature.

Temperature differences may be caused by:

- Hot fresh food was placed in the appliance.
- When sorting and removing food from the appliance, too much warm ambient air got in.
- There has been a prolonged power outage.
- The appliance is faulty.

When the cause is eliminated, the appliance will continue to operate at the last temperature setting.

- ▶ Confirm the display.
- ▷ Warmest temperature is displayed.
- ▶ Confirm the display again.
- ▷ The status display is displayed.
- ▷ Current temperature is displayed.

Error

This message appears when there is a fault with the appliance. An appliance component has an error.

- ▶ Open the door.
- ▶ Take note of the error code.
- ▶ Confirm the message.
- ▷ The acoustic warning ceases
- ▷ The display changes to the Status screen.
- ▶ Close the door.
- ▶ Contact Customer Service (see 9.4 Customer service).

6.5.2 DemoMode

If "D" appears in the display, demo mode is on. This feature is designed for retailers. The cooling features are disabled.

Switching off DemoMode

When you see a time counting down:

- ▶ Confirm within the countdown.
- ▷ DemoMode is off.

If there is no countdown:

- ▶ Disconnect the power plug.
- ▶ Reconnect the power plug.
- ▷ DemoMode is off.

Equipment

7 Equipment

7.1 Door racks

7.1.1 Moving/removing door racks

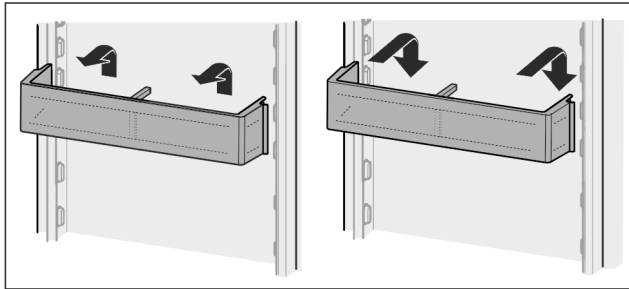

Fig. 13

- ▶ Slide racks up.
- ▶ Pull to the front.
- ▶ Re-insert in reverse order.

7.1.2 To dismantle door racks

The door racks can be disassembled for cleaning.

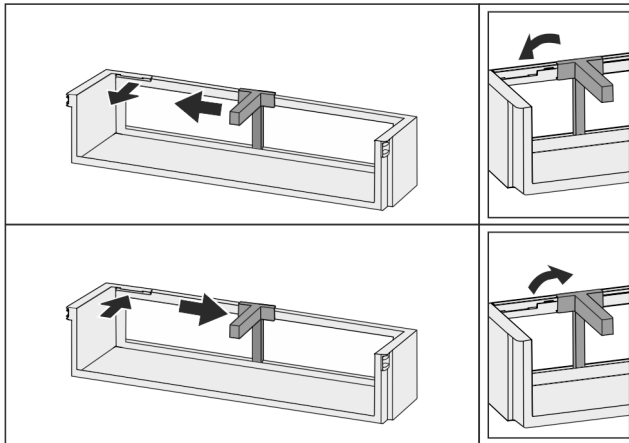

Fig. 14

- ▶ Disassemble the door racks.

7.2 Shelves

7.2.1 Moving/removing shelves

Extension stops secure the shelves against being accidentally pulled out

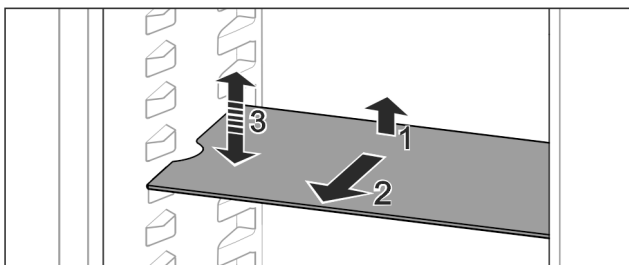

Fig. 15

- ▶ Lift the shelf and pull to the front.
- ▷ Side recess to shelf position.
- ▶ Reposition the shelf: Lift up or lower to the desired height and insert.

-or-

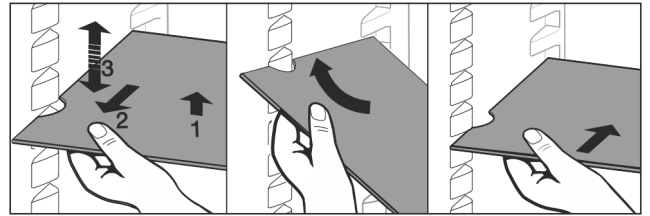

Fig. 16

- ▶ Take out the shelf completely: Pull out to the front.
- ▶ Easier removal: Set the shelf at an angle.
- ▶ Reinsert the shelf: Push it in to its stop limit.
- ▷ Pull-out stoppers are pointing down.
- ▷ Pull-out stoppers are behind the front shelf.

7.3 Split shelf

7.3.1 Using the split shelf

Extension stops secure the shelves against being accidentally pulled out

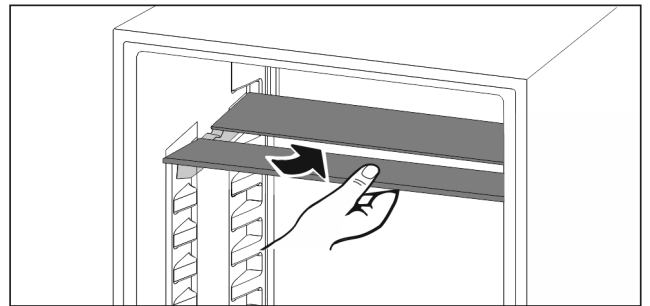

Fig. 17

- ▶ Push the split shelf underneath as in the illustration

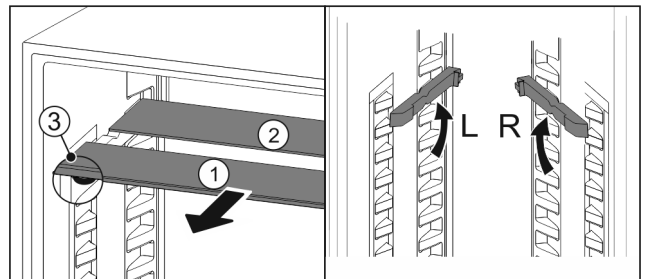

Fig. 18

Adjusting heights:

- ▶ Pull the glass panels out Fig. 18 (1) from the front, one at a time.
- ▶ Pull the support rails out of their retainers and snap into place at the height you want them.
- ▶ Slide in the glass panels one at a time.
- ▷ Flat pull-out stoppers at the front, right behind the support rail.
- ▷ Taller pull-out stoppers at the back.

Using both shelves:

- ▶ Hold the bottom glass panel with one hand and pull it to the front.
- ▷ The glass panel Fig. 18 (1) with the trim strip is at the front.
- ▷ The stops Fig. 18 (3) point downward.

7.4 Variable bottle shelf

7.4.1 Using the bottle shelf

Use the variable bottle shelf or the glass panel placed on the fridge floor.

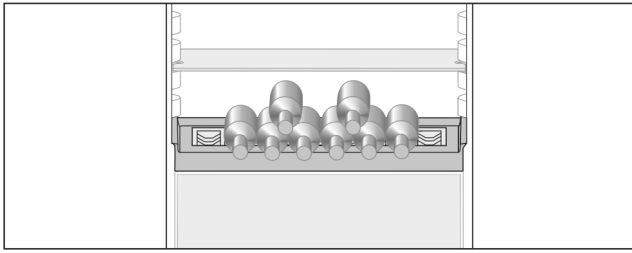

Fig. 19

- ▶ Remove the glass shelf and store separately.
- ▶ Place the bottles with the base pointing backwards facing the rear wall

Note

If the bottles protrude over the front of the bottle shelf:

- ▶ Move the bottom door rack higher up.

7.4.2 Removing the bottle shelf

You can remove the bottle shelf for cleaning.

- ▶ Remove the glass panel above the bottle shelf.

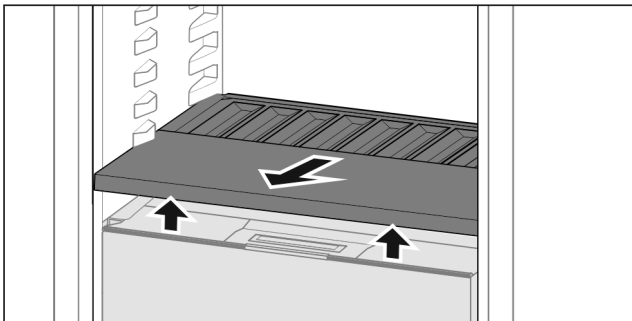

Fig. 20

- ▶ Lift the bottle shelf at the front and pull out.

Note

Liebherr recommends the following:

Do not place any goods on the drawer cover below.

7.4.3 Inserting the bottle shelf

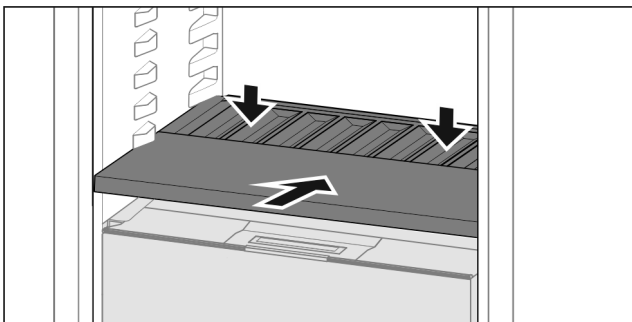

Fig. 21

- ▶ Slide in the bottle shelf until it engages and push down.

7.5 Drawers

You can remove the drawers for cleaning.

The shelves below can be used for storage until the drawers are replaced.

How the drawers are removed and inserted differs depending on the pull-out system. Your appliance can include a variety of pull-out systems.

Note

Insufficient ventilation results in an increase in energy consumption and reduction of the refrigerating performance.

- ▶ Leave the bottom drawer in appliance!
- ▶ Never obstruct the vents on the interior rear wall!

7.5.1 Remove the drawer

Drawer on glide rails

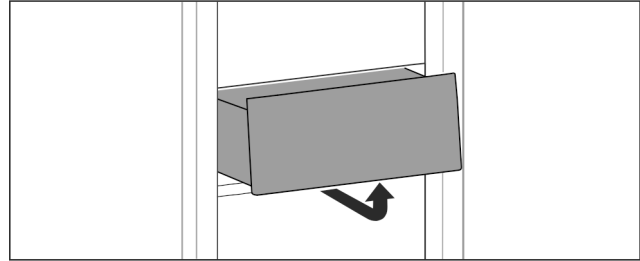

Fig. 22

- ▶ Remove the drawer as shown in the diagram.

Drawer on telescopic rails

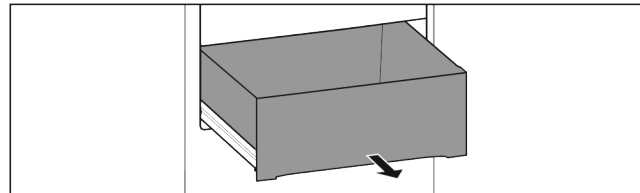

Fig. 23

Make sure that the following requirements are fulfilled:

- Drawer is completely pulled out (see Fig. 1367) .

Partial pull-out fridge compartment:

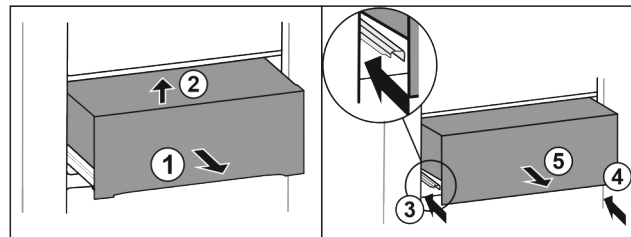

Fig. 24

- ▶ Pull out the drawer halfway Fig. 24 (1).
- ▶ Lift at the front Fig. 24 (2).
- ▶ Slide in left rail Fig. 24 (3).
- ▶ Slide in right rail Fig. 24 (4).
- ▶ Remove the drawer to the front Fig. 24 (5).

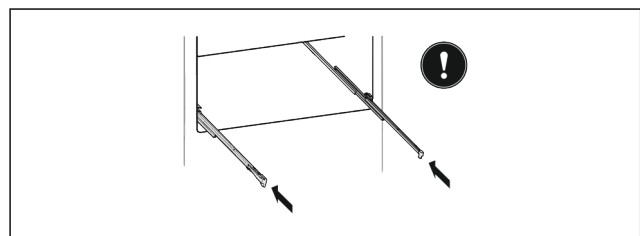

Fig. 25

If the rails are not yet fully pushed in after removing the drawer:

- ▶ Push the rails in completely.

Equipment

7.5.2 Inserting the drawer

Drawer on glide rails

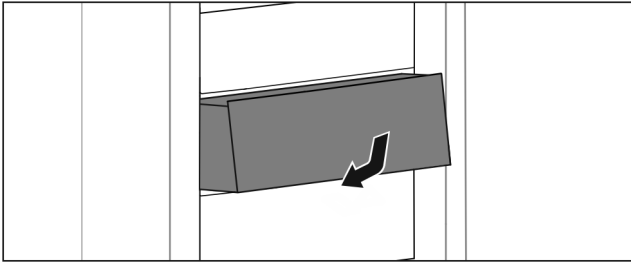

Fig. 26

- ▶ Insert the drawer as shown in the diagram.

Drawer on telescopic rails

Partial pull-out fridge compartment:

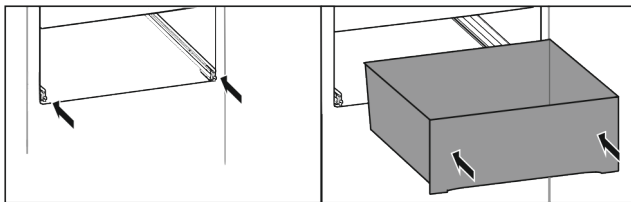

Fig. 27

- ▶ Slide the rails in.
- ▶ Place the drawer on the rails.
- ▶ Push all the way back.

7.6 Fruit & Vegetable-Safe cover

The compartment lid can be removed for cleaning.

7.6.1 Removing the compartment lid

Make sure that the following requirements are fulfilled

- Bottle shelf is removed (see 7.4 Variable bottle shelf).

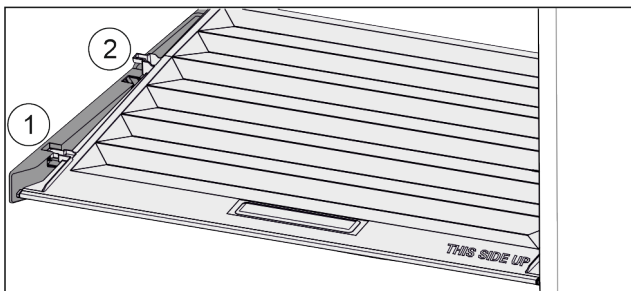

Fig. 28

If the drawers are removed:

- ▶ Pull the lid up at the front in the retaining parts to the opening Fig. 28 (1).
- ▶ Lift from the back and pull it up and out Fig. 28 (2).

7.6.2 Inserting the compartment lid

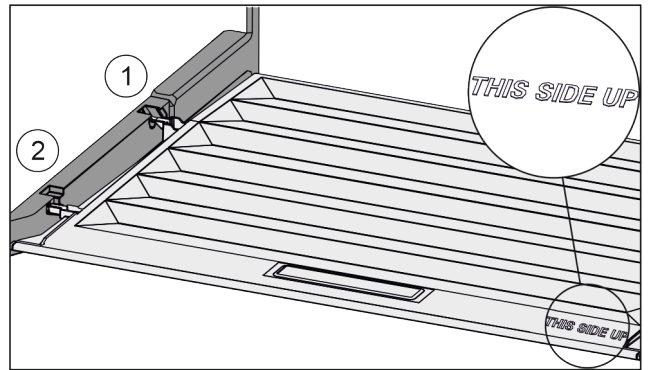

Fig. 29

If the text THIS SIDE UP is on top:

- ▶ Insert the lip of the cover over the opening of the rear bracket Fig. 29 (1) and click into place Fig. 29 (2).
- ▶ Position the cover where you want it (see 7.7 Humidity control).

7.7 Humidity control

You can regulate the moisture in the drawer yourself by adjusting the compartment cover.

The compartment cover is on the drawer itself and can be covered with shelves or additional drawers.

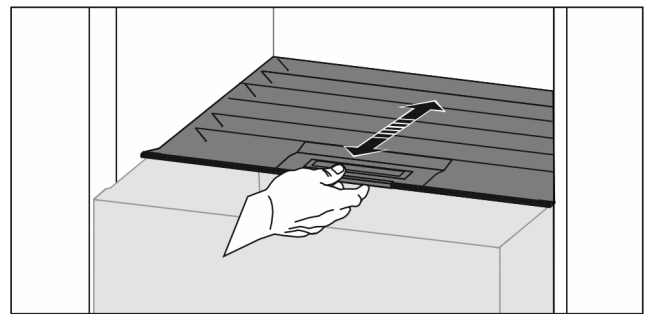

Fig. 30

Low air humidity

- ▶ Open the drawer.
- ▶ Pull the drawer cover to the front.
- ▷ If the drawer is closed: Gap between lid and compartment.
- ▷ Moisture levels lower in the Safe.

High air moisture:

- ▶ Open the drawer.
 - ▶ Slide the compartment cover to the back.
 - ▷ If the drawer is closed: The cover seals the compartment.
 - ▷ Moisture levels rise in the Safe.
- If there is too much moisture in the compartment:
- ▶ Choose a "low moisture setting".

-or-

- ▶ Remove the moisture with a cloth.

Note

With the "low humidity" setting, the Fruit & Vegetable-Safe can also be used as a Meat & Dairy-Safe.

- ▶ Choose a "low moisture" setting.

7.8 EasyTwist-Ice*

The EasyTwist-Ice produces ice cubes when the water tank is inserted.

The EasyTwist-Ice is used exclusively for the production of ice cubes in standard household quantities.

Note

Do not change the position of the EasyTwist-Ice.

Make sure that the following conditions are met:

- The EasyTwist-Ice has been cleaned (see 8.3.5 Cleaning the EasyTwist-Ice*)
- The water tank has been cleaned.
- The EasyTwist-Ice drawer is fully inserted.

7.8.1 Filling the water tank



WARNING

Contaminated water!

Poisoning.

- ▶ Fill with potable water only.

NOTICE

Sugary liquids!

Damage to the IceMaker.

- ▶ Fill with cold drinking water only.

Note

Using filtered, decarbonized water ensures the best-tasting drinking water for your ice cubes.

This water quality can be achieved using a table water filter of the kind available in trade retail outlets.

- ▶ Always fill the water tank only with filtered, decarbonized drinking water.

The water for the EasyTwist-Ice is supplied from a water tank.

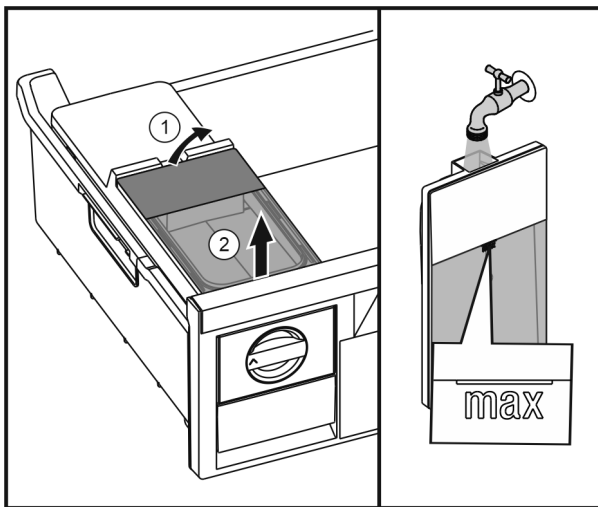

Fig. 31

- ▶ Lift up the water tank at the rear Fig. 31 (1) and take it out upwards Fig. 31 (2).
- ▶ Fill with drinking water up to the mark.
- ▶ Insert the water tank by reversing the steps described above.

7.8.2 Producing ice cubes

The production capacity depends on the freezer temperature. The lower the temperature, the more ice cubes that can be produced in a certain period.

Maximum capacity of the ice cube drawer – 40 cubes (2x ice cube production).

Time required for ice cube production – at least 5 hours.

Releasing the ice cubes

- ▶ Turn the knob to the right to its stop limit.
- ▶ If necessary, repeat several times and turn the knob a little more.

7.9 VarioSpace

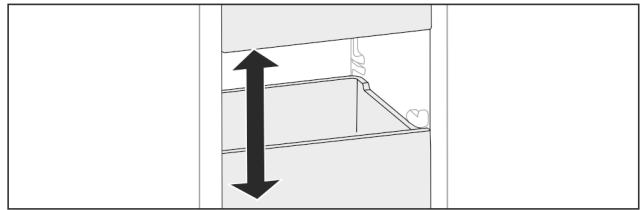

Fig. 32

You can remove drawers and glass panels from your appliance. This provides more room for large food items such as poultry, joints of meat, large game and bulky baked goods. You can then freeze these items whole for later preparation.

- ▶ Note the load limits on the drawers and glass panels (see 9.1 Technical specifications).

7.10 Accessories

7.10.1 Bottle rack

Using the bottle rack

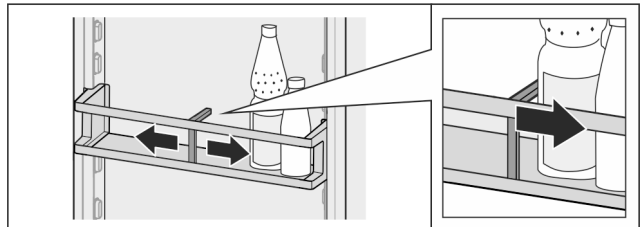

Fig. 33

- ▶ Slide the bottle rack at the edges.
- ▷ Stops bottles from tipping over.

Removing the bottle rack

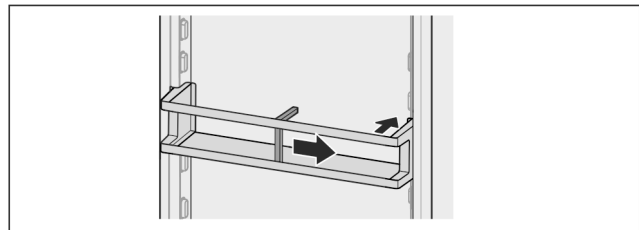

Fig. 34

- ▶ Slide the bottle rack all the way to the right edge.
- ▶ Remove to the back.

8 Maintenance

8.1 FreshAir carbon filter

The FreshAir carbon filter is located in the compartment above the fan.

It guarantees the best air quality.

- Change the carbon filter every 6 months. With an active *Reminder*, a change prompt appears in the display.
- You can dispose of the carbon filter with the regular household waste.

Note

The FreshAir carbon filter is available for purchase from the [Liebherr home appliance store](http://home.liebherr.com) (home.liebherr.com).

Maintenance

8.1.1 Removing the FreshAir carbon filter

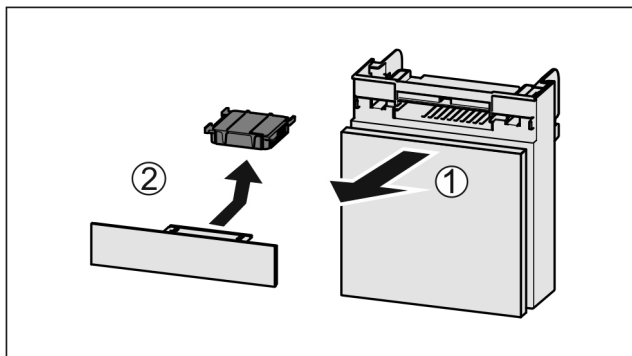

Fig. 35

- ▶ Pull out the compartment Fig. 35 (1).
- ▶ Remove the carbon filter Fig. 35 (2).

8.1.2 Inserting the FreshAir carbon filter

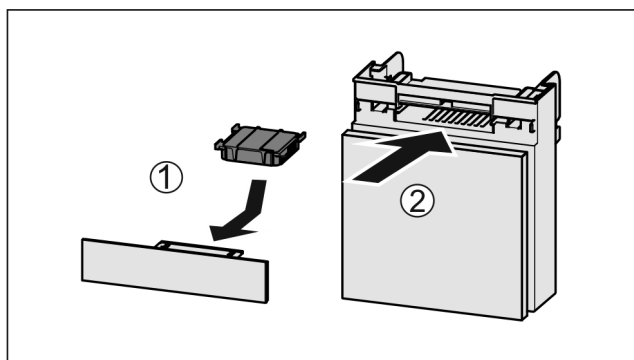

Fig. 36

- ▶ Insert the carbon filter as shown in the diagram Fig. 36 (1).
- ▷ The carbon filter clicks into place.
If the carbon filter is pointing downwards:
 - ▶ Push the compartment in Fig. 36 (2).
 - ▷ The carbon filter is now ready for use.

8.2 Defrosting the appliance

8.2.1 Defrosting the refrigerator compartment

Defrosting is performed automatically. The water from the thawing process runs out via the drain opening and is evaporated.

- ▶ Clean the drain opening regularly (see 8.3 Cleaning the appliance).

8.2.2 Defrosting the freezer compartment with NoFrost

Defrosting is performed automatically by the NoFrost system. The moisture condenses on the evaporator and is periodically defrosted and evaporated.

The appliance does not have to be defrosted.

8.3 Cleaning the appliance

8.3.1 Preparation



WARNING

Danger of electric shock.

- ▶ Unplug refrigerator or disconnect power.



WARNING

Danger of fire

- ▶ Do not damage the refrigerant circuit.

- ▶ Empty appliance.
- ▶ Pull out the power plug.

8.3.2 Cleaning the housing

NOTICE

Improper cleaning!

Damage to the appliance.

- ▶ Only use soft cleaning cloths and ph-neutral all-purpose cleaners.



WARNING

Risk of injury or damage due to hot steam.

Hot steam can cause scalding/burns and damage to surfaces.

- ▶ Do not use steam cleaners.
- ▶ Wipe the housing down with soft, clean cloth. If very dirty, use lukewarm water with a neutral cleaner. Glass surfaces can also be cleaned with glass cleaner.

8.3.3 Cleaning the interior

NOTICE

Improper cleaning!

Damage to the appliance.

- ▶ Only use soft cleaning cloths and ph-neutral all-purpose cleaners.
- ▶ Plastic surfaces: clean by hand with a soft clean cloth, lukewarm water and a little detergent.
- ▶ Metal surfaces: clean by hand with a soft clean cloth, lukewarm water and a little detergent.
- ▶ Drain outlet Fig. 1 (11): Remove any deposits with a thin item such as a cotton bud.

8.3.4 Cleaning the equipment

NOTICE

Improper cleaning!

Damage to the appliance.

- ▶ Only use soft cleaning cloths and ph-neutral all-purpose cleaners.

Clean with a soft, clean cloth, lukewarm water and a little washing up liquid:

- Door racks
- Shelf
- Split shelf
- Fruit & Vegetable-Safe cover
- Drawer
- Variable bottle shelf

Clean with a damp cloth:

- Retracting rails
Please note: the grease in the tracks is there for lubrication purposes and must not be removed!

Clean in the dishwasher up to 60 °C:

- Bottle rack
- Holder for the split shelf
- ▶ Disassemble the equipment: see the relevant section.
- ▶ Clean the equipment.

8.3.5 Cleaning the EasyTwist-Ice*

Cleaning must be conducted in the following situations:

- Operating for the first time
- Non-use for longer than 48 hours
- When the appliance requires cleaning

When operating for the first time, longer periods of disuse and when the appliance requires cleaning

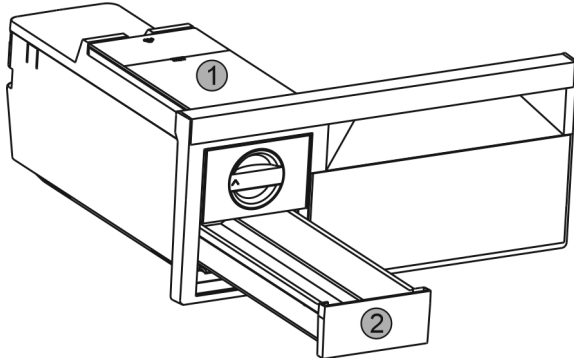

Fig. 37

- ▶ Take out the water tank Fig. 37 (1) and ice cube drawer Fig. 37 (2).
- ▶ Take out the freezer drawer with EasyTwist-Ice.

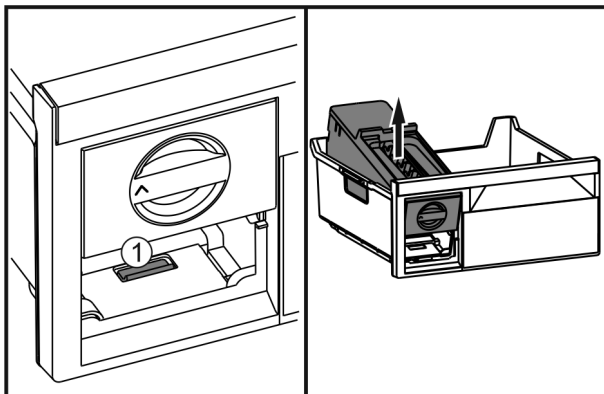

Fig. 38

- ▶ Press the lug Fig. 38 (1), lift up the EasyTwist-Ice at the back and take it out of the freezer drawer.

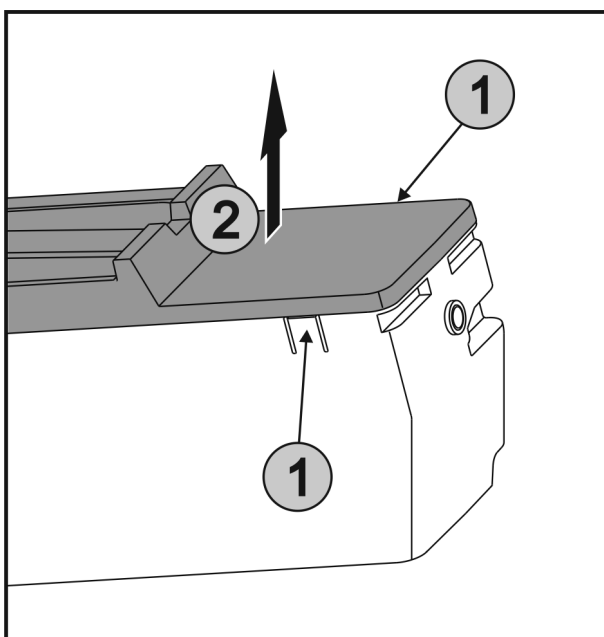

Fig. 39

- ▶ Press the lugs Fig. 39 (1) on both sides of the EasyTwist-Ice simultaneously and take off the cover Fig. 39 (2) upwards.

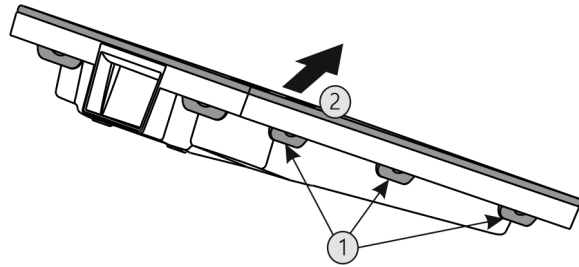

Fig. 40

- ▶ Press all lugs Fig. 40 (1) one after another and remove the cover Fig. 40 (2).
- ▶ Clean the ice cube drawer, water tank and EasyTwist-Ice with water and a little detergent.
- ▶ Assemble the EasyTwist-Ice.

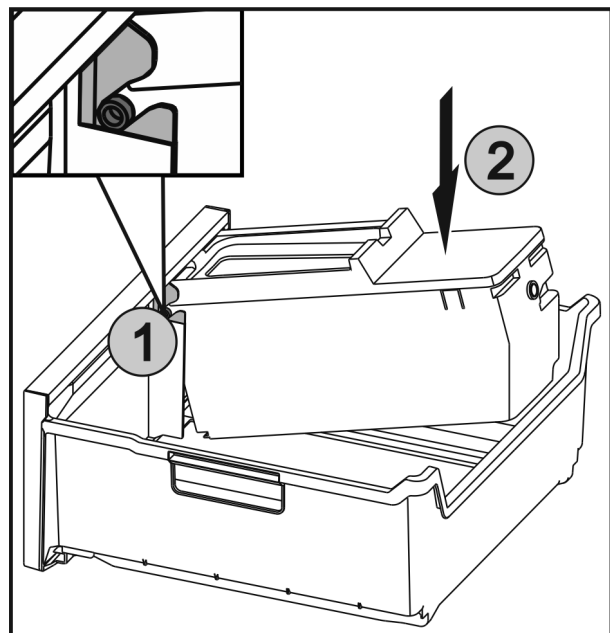

Fig. 41

- ▶ Insert the axles Fig. 41 (1) on the EasyTwist-Ice in the guides and push the rear side Fig. 41 (2) until the lug engages.
- ▶ Push in the EasyTwist-Ice drawer.



WARNING

Contaminated water!
Poisoning.

- ▶ Fill with potable water only.

- ▶ Fill the water tank and insert it. (see 7.8.1 Filling the water tank)

With unfiltered water:

- ▶ Dispose of ice cubes that were produced within 24 hours of the first ice cube production.

With filtered water:

- ▶ Dispose of ice cubes that were produced within 48 hours of the first ice cube production.

8.3.6 After cleaning

- ▶ Wipe dry the appliance and items of equipment
- ▶ Connect and switch on the appliance.
- ▶ Activate SuperFrost (see 6.3 Functions) .
When the temperature is sufficiently cold
- ▶ Place the food inside.
- ▶ Repeat cleaning regularly.

9 Customer support

9.1 Technical specifications

Temperature zone	
Cool:	3 °C to 9 °C
BioFresh	0 °C to 3 °C
Freezing	-26 °C to -15 °C

Maximum freezing capacity / 24 hrs	
Freezer	See nameplate, "Freezing capacity ... / 24h"

Max. equipment capacity			
Equipment	Appliance width 55 cm (see Installation Guide, Appliance Dimensions)	Appliance width 60 cm (see Installation Guide, Appliance Dimensions)	Appliance width 70 cm (see Installation Guide, Appliance Dimensions)
Drawer Freezer	12 kg	12 kg	
Glass panel, freezer	35 kg	35 kg	55 kg

Lighting	
Energy efficiency class ¹	Light source
This product contains an energy efficiency class G light source	LED

¹ The appliance may contain light sources with different energy efficiency classes. The lowest class is given here.

For appliances with a WiFi connection:*

Frequency specification*	
Frequency band	2.4 GHz
Maximum radiated power	<100 mW
Purpose of the wireless equipment	Integration in the local WiFi network for data communication

9.2 Operating noises

The appliance makes noises while in operation.

- At **less cooling output** the appliance saves energy but takes longer to cool items. The volume is **lower**.
- At a **higher cooling output** the food cools more quickly. The volume is **higher**.

Defect	Cause	Remedy
The appliance does not work.	→ The appliance is not switched on.	▶ Switch on the appliance.
	→ The power plug is not properly inserted in the wall socket.	▶ Check the power plug.
	→ The powerfuse in the wall socket is not OK.	▶ Check the fuse.
	→ Power failure.	▶ Keep the appliance closed.

Examples:

- Activated functions (see 6.3 Functions)
- Running fan
- Freshly sorted food
- High ambient temperature
- Door opened for long periods

Noise	Possible cause	Type of noise
Bubbling splashing and	Coolant is flowing into the cooling circuit.	Normal noise
Spitting hissing and	Coolant is spraying into the cooling circuit.	Normal noise
Humming	The appliance cools. The volume depends on the cooling output.	Normal noise
Whirring murmuring and	The fan is running.	Normal operating noise
Clicking	Components are being switched on/off	Normal switching noise
Rattling humming or	Valves are active.	Normal switching noise

Noise	Possible cause	Type of noise	How to resolve
Vibration	Unsuitable setup.	Error noise	Adjust the feet to make sure the appliance is horizontal.
Clattering	Equipment, Objects inside the appliance	Error noise	Secure equipment parts. Leave a gap between items.

9.3 Technical faults

Your appliance is designed and manufactured for reliable operation and a long service life. If a malfunction nonetheless occurs during operation, please check whether the malfunction is due to an operating error. In this case, you will have to be charged for the costs incurred, even during the warranty period. You may be able to rectify the following faults yourself.

9.3.1 Appliance function

Defect	Cause	Remedy
		<ul style="list-style-type: none"> ▶ Protect your food: Lay freezer packs on top of the food or use another freezer if the power is off for a prolonged period. ▶ Do not re-freeze defrosted food.
	→ The appliance connector is not correctly inserted in the appliance.	▶ Check the appliance connector.
The temperature is not cold enough	→ This means that the door of the appliance is not closed properly	▶ Close the appliance door
	→ Insufficient ventilation	▶ Clear and clean the ventilation grille.
	→ The ambient temperature is too high	▶ Solution: (see 1.4 Range of appliance use) .
	→ The appliance was opened too frequently or for too long	▶ Wait to see whether the required temperature resets itself by itself. If not, contact Customer Service (see 9.4 Customer service) .
	→ Too much fresh food was placed inside without SuperFrost.	▶ Solution: (see SuperFrost)
	→ The temperature is incorrectly set	▶ Set to a colder temperature and check after 24 hours.
	→ The appliance is too near to a heat source (stove, heater etc).	▶ Change location of appliance or the heat source.
The status display does not turn on.	→ The status display is switched off.	▶ Switch on the status display .
	→ The door is open.	▶ Close the door.
	→ The appliance is switched off.	▶ Switch on the appliance.
	→ The LED is defective.	▶ Contact Customer Service (see 8 Maintenance) .
The door seal is defective or should be replaced for other reasons.	→ The door seal is interchangeable. You can replace it without the use of any special tools.	▶ Contact Customer Service (see 9.4 Customer service) .
The appliance is iced up or condensation is building.	→ The door seal may have slipped out of its groove.	▶ Check the door seal is well placed in the groove.
The outside surfaces of the appliance are hot*.	→ The heat of the refrigerant circuit is used to prevent condensate from forming	▶ This is normal.

9.3.2 Equipment

Defect	Cause	Remedy
The interior light does not turn on.	→ The appliance is not switched on.	▶ Switch on the appliance.
	→ The door was open for longer than 15 min.	▶ The interior light automatically switches itself off if the door stays open for approx. 15 min.
	→ The LED interior light is faulty or the cover is damaged:	<div style="border: 1px solid red; padding: 5px;">  <p>WARNING Risk of injury from electrical shock. Live parts are under the cover.</p> <p>▶ The LED interior light should only be replaced or repaired by the Customer Service department or by engineers trained to do so.</p> </div>

9.4 Customer service

First check if you can fix the error yourself (see 9 Customer support) . If this is not the case, please contact customer service.

Please refer to the enclosed “Liebherr Service” brochure for the address.

Decommissioning



WARNING

Unprofessional repair!
Injuries.

- ▶ Repairs and work on the appliance and the power supply cable not described in the Manual (see 8 Maintenance) should only be carried out by a qualified service provider.
- ▶ A damaged power cable may only be replaced by the manufacturer, the manufacturer's Customer Service or a similarly qualified person.
- ▶ For appliances with an IEC connector, the change can be made by the customer.

9.4.1 Contact Customer Service

Make sure to have the following appliance information to hand:

- Appliance name (model and index)
- Service no. (service)
- Serial no. (S no.)
- ▶ Showing appliance info on the display (see Info) .
- or-
- ▶ Referring to appliance info on the nameplate (see 9.5 Rating plate) .
- ▶ Take note of the appliance information.
- ▶ Inform Customer Service: Tell us the problem and the appliance details.
- ▷ This will help us give you fast and accurate support.
- ▶ Further instructions from customer service will follow.

9.5 Rating plate

The nameplate is located behind the drawers on the inside of the appliance.

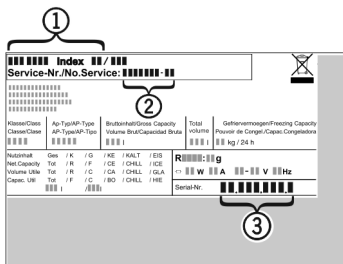

Fig. 42

- (1) Appliance name
 - (2) Service no.
 - (3) Serial no.
- ▶ Information from the nameplate.

10 Decommissioning

- ▶ Empty appliance.
- ▶ Switch off the appliance (see 6.4 Settings) .
- ▶ Pull out the power plug.
- ▶ Remove the appliance connector if necessary: Pull it out and, at the same time, move it from the left to the right.
- ▶ Clean the appliance (see 8.3 Cleaning the appliance) .
- ▶ Leave the door open to prevent bad smells

11 Disposing of the appliance



WARNING

Risk of child entrapment!

Before you throw away your old refrigerator or freezer:

- ▶ Take off the doors.
- ▶ Leave the shelves in place so that children may not easily climb inside.

The device still contains valuable materials and must be collected separately from unsorted municipal waste so it can be recycled. Disused devices must be disposed of in a proper and professional manner according to the locally applicable regulations and laws.



WARNING

Leaking refrigerant and oil!

Fire. The refrigerant contained within the appliance is environmentally friendly, but flammable. The oil contained within the appliance is flammable. Escaping refrigerant and oil can ignite if they are of high enough concentration and are exposed to an external heat source.

- ▶ Do not damage the pipelines of the coolant circuit and the compressor.

Do not damage the refrigerant circuit of the old appliance during transport. This ensures that the refrigerant (see type plate for details (see 9.5 Rating plate)) and the oil cannot leak out uncontrollably.

For Germany:

The appliance can be disposed of free of charge in Class 1 collection containers at your local recycling center. When purchasing a new fridge/freezer and if your sales area is > 400 m², the retailer will also take back the old appliance free of charge.

Decommission the appliance:

- ▶ Disconnect the power plug.
- ▶ Remove the connection cable from the appliance.



home.liebherr.com/fridge-manuals

EN Combined fridge-freezer with BioFresh

Issue date: 20211213
Part number index: 7080438-00

Liebherr-Hausgeräte Marica EOOD
Bezirk Plovdiv
4202 Radinovo
Bulgarien