



# OWNER'S MANUAL

# WASHING MACHINE

---



Before beginning installation, read these instructions carefully. This will simplify installation and ensure that the product is installed correctly and safely. Leave these instructions near the product after installation for future reference.

**ENGLISH**

LSWD100E



**Barcode**

MFL71814905  
Rev.XX\_MMDDYY

[www.lg.com](http://www.lg.com)

Copyright © 2010-2018 LG Electronics Inc. All Rights Reserved.

# TABLE OF CONTENTS

This manual may contain images or content that may be different from the model you purchased.  
This manual is subject to revision by the manufacturer.

## SAFETY INSTRUCTIONS

READ ALL INSTRUCTIONS BEFORE USE..... 4  
WARNING..... 4  
CARING FOR THE ENVIRONMENT ..... 9

## INSTALLATION

Parts and Specifications ..... 12  
Installation Place Requirements ..... 15  
Unpacking the Appliance ..... 16  
Levelling the Appliance ..... 17  
Connecting the Water Supply Hose ..... 19  
Installing the Drain Hose ..... 20

## OPERATION

Operation Overview..... 21  
Control Panel ..... 23  
Preparing the Wash Load ..... 24  
Adding Detergents and Softeners ..... 24  
Programme Table ..... 29  
Drying Programme ..... 35  
Extra Options and Functions ..... 39  
Settings..... 42

## SMART FUNCTIONS

LG ThinQ Application ..... 46  
Smart Diagnosis ..... 49

## MAINTENANCE

Cleaning After Every Wash..... 51  
Cleaning the Appliance Periodically & Performing an Emergency Water Evacuation..... 52

## TROUBLESHOOTING

Before Calling for Service.....55

## SAFETY INSTRUCTIONS

### READ ALL INSTRUCTIONS BEFORE USE

The following safety guidelines are intended to prevent unforeseen risks or damage from unsafe or incorrect operation of the appliance. The guidelines are separated into 'WARNING' and 'CAUTION' as described below.

### Safety Messages



This symbol is displayed to indicate matters and operations that can cause risk. Read the part with this symbol carefully and follow the instructions in order to avoid risk.



#### **WARNING**

This indicates that the failure to follow the instructions can cause serious injury or death.



#### **CAUTION**

This indicates that the failure to follow the instructions can cause the minor injury or damage to the product.

### WARNING

---

#### **WARNING**

To reduce the risk of explosion, fire, death, electric shock, injury or scalding to persons when using this product, follow basic precautions, including the following:

---

### Technical Safety

- This appliance can be used by children aged from 8 years and above and persons with reduced physical, sensory or mental capabilities or lack of experience and knowledge if they have been given supervision or instruction concerning use of the appliance in a safe way and understand the hazards involved. Children shall not play with the

appliance. Cleaning and user maintenance shall not be made by children without supervision.

- Children of less than 3 years should be kept away unless continuously supervised.
- If the power cord is damaged, it must be replaced by the manufacturer, its service agent or similarly qualified persons in order to avoid a hazard.
- Ventilation openings must not be obstructed by a carpet.
- This appliance is intended to be used in household only.
- Use a new hose or hose-set supplied with the appliance. Reusing old hoses can cause a water leak and subsequent property damage.
- The water pressure must be between 50 kPa and 800 kPa.

## Maximum Capacity

The maximum capacity in some cycles for dry clothes to be used is

**Wash (12 kg)/Dry (7 kg).**

The recommended maximum capacity for each washing programme may differ. To get good wash results, please refer to **Programme Table** in **OPERATION** chapter for further details.

## Technical Safety for Using the Dryer

- Do not dry unwashed items in the appliance.
- Items that have been soiled with substances such as cooking oil, vegetable oil, acetone, alcohol, petroleum, kerosene, spot removers, turpentine, waxes and wax removers should be washed in hot water with an extra amount of detergent before being dried in the appliance.
- Never stop the appliance before the end of the drying cycle unless all items are quickly removed and spread out so that the heat is dissipated.
- Items such as foam rubber (latex foam), shower caps, waterproof textiles, rubber backed articles and clothes or pillows fitted with foam rubber pads should not be dried in the appliance.

- Fabric softeners, or similar products, should be used as specified by the fabric softener instructions.
- Remove all objects from pockets such as lighters and matches.
- The appliance is not to be used if industrial chemicals have been used for cleaning.

### **Installation**

- Never attempt to operate the appliance if it is damaged, malfunctioning, partially disassembled, or has missing or broken parts, including a damaged cord or plug.
- This appliance should only be transported by two or more people holding the appliance securely.
- Do not install the appliance in a damp and dusty place. Do not install or store the appliance in any outdoor area, or any area that is subject to weathering conditions such as direct sunlight, wind, rain, or temperatures below freezing.
- Make sure the power plug is completely pushed into the power outlet.
- Do not plug the appliance into multiple outlet sockets, power boards, or an extension power cable.
- Do not modify the power plug provided with the appliance. If it does not fit the power outlet, have a proper outlet installed by a qualified electrician.
- This appliance is equipped with a power cord having an equipment-earthing / grounding conductor (earthing pin) and a grounding power plug. The power plug must be plugged into an appropriate outlet socket that is installed and earthed / grounded in accordance with all local codes and ordinances.
- Improper connection of the equipment-grounding conductor can result in risk of electric shock. Check with a qualified electrician or service personnel if you are in doubt as to whether the appliance is properly grounded.
- This appliance must not be installed behind a lockable door, a sliding door or a door with a hinge on the opposite side to that of the

appliance, in such a way that a full opening of the appliance door is restricted.

- LG Mini Washer must be installed underneath a matching LG front loading washing machine manufactured after 2009.

## Operation

- Do not apply any sharp objects to the control panel in order to operate the appliance.
- Do not attempt to separate any panels or disassemble the appliance.
- Do not repair or replace any part of the appliance. All repairs and servicing must be performed by qualified service personnel unless specifically recommended in this Owner's Manual. Use only authorized factory parts.
- Do not push down the door excessively, when the appliance door is open.
- Do not put animals, such as pets into the appliance.
- Do not wash rugs, mats, shoes or pet blankets, stuffed toys, or any other items other than clothes or sheets, in this machine.
- Keep the area underneath and around the appliance free of combustible materials such as lint, paper, rags, chemicals, etc.
- Do not leave the appliance door open. Children may hang on the door or crawl inside the appliance, causing damage or injury.
- Do not put in, wash or dry articles that have been cleaned in, washed in, soaked in, or spotted with combustible or explosive substances (such as waxes, wax removers, oil, paint, gasoline, degreasers, drycleaning solvents, kerosene, petrol, spot removers, turpentine, vegetable oil, cooking oil, acetone, alcohol, etc.). Improper use can cause fire or explosion.
- Do not use liquid chlorine bleach.
- Do not operate the appliance without Auto Liquid Dispense Box in place.
- Do not use or store flammable or combustible substances (ether, benzene, alcohol, chemical, LPG, combustible spray, gasoline,

thinner, petroleum, insecticide, air freshener, cosmetics, etc.) near the appliance.

- Never reach into the appliance while it is operating. Wait until the drum has completely stopped.
- Do not touch the door during a high temperature programme.
- In case of a water leak from the appliance or flood, disconnect the power plug and contact the LG Electronics customer information centre.
- Turn off water taps to relieve pressure on hoses and valves and to minimize leakage if a break or rupture should occur. Check the condition of the fill hoses; they should be replaced after 5 years.
- If there is a gas leakage (isobutane, propane, natural gas, etc.) within the home, do not touch the appliance or power plug and ventilate the area immediately.
- If the drain hose or inlet hose is frozen during winter, use it only after thawing.
- Keep all washing detergents, softener and bleach away from children.
- Do not touch the power plug or the appliance controls with wet hands.
- Do not bend the power cable excessively or place a heavy object on it.
- Avoid touching any water that is drained from the appliance during the wash.
- Make sure that drainage is working properly. If water is not drained properly, your floor may get flooded.
- When the air temperature is high and the water temperature is low, condensation may occur and thus wet the floor.
- Wipe off dirt or dust on the contacts of the power plug.

### **Maintenance**

- Disconnect the appliance from the power supply before cleaning the appliance. Setting the controls to the OFF or stand by position does not disconnect this appliance from the power supply.



- Securely plug the power plug in the outlet socket after completely removing any moisture and dust.
- Do not spray water inside or outside the appliance to clean it.
- Never unplug the appliance by pulling on the power cable. Always grip the power plug firmly and pull straight out from the outlet socket.
- Only qualified service personnel from LG Electronics service centre should disassemble, repair, or modify the appliance. Contact an LG Electronics customer information centre if you move and install the appliance in a different location.

## Disposal

- Before discarding an old appliance, unplug it. Cut off the cable directly behind the appliance to prevent misuse.
- Dispose of all packaging materials (such as plastic bags and styrofoam) away from children. The packaging materials can cause suffocation.
- Remove the door before disposing of or discarding this appliance to avoid the danger of children or small animals getting trapped inside.

## CARING FOR THE ENVIRONMENT

### Environmental and Economical Tips

#### Energy and water consumption

- Water consumption and energy usage can be affected by the weight of the load. To make the best use of your appliance, load the maximum amount of dry clothes for the particular programme.
- The most efficient programmes in terms of energy consumption are generally those that perform at lower temperatures and longer duration.
- Noise and remaining moisture content are influenced by the spinning speed: the higher the spinning speed in the spinning phase, the higher the noise and the lower the remaining moisture content.

- Evenly loading laundry up to the capacity indicated by the manufacturer for the respective programmes will contribute to energy and water savings.
- For washing smaller amounts of clothes, the automatic load recognition system will help reduce the amount of water and energy usage.
- Use the Speed programme for small, lightly soiled loads.
- Cold water laundry detergents can be as effective at lower temperatures (about 20 °C). Using 20 °C settings will use less energy than 30 °C or higher temperatures.

### Detergent

- Detergent should be chosen according to type, colour, soiling of the fabric and the washing temperature. And it should be used according to the instruction of the detergent manufacturer. Use only detergents that are suitable for front loading washing machines.
- Use less detergent on smaller loads.
  - Partial load: 1/2 of the normal amount.
  - Minimum load: 1/3 of full load.

### Selecting Extra Options and Functions

- Select the water temperature suitable for the type of load you are washing. Follow the garment fabric care labels for best results.
- The Pre Wash option is recommended for washing a heavily soiled load.

### When Using a Dry Programme

- To save energy, choose the highest possible spin speed for the wash programme when drying in a tumble dryer.
- For most drying, make sure all clothes are similar in material and thickness.
- When you select drying only, spinning runs automatically for energy efficiency.

## Disposal of Your Old Appliance



- This crossed-out wheeled bin symbol indicates that waste electrical and electronic products (WEEE) should be disposed of separately from the municipal waste stream.
- Old electrical products can contain hazardous substances so correct disposal of your old appliance will help prevent potential negative consequences for the environment and human health. Your old appliance may contain reusable parts that could be used to repair other products, and other valuable materials that can be recycled to conserve limited resources.
- You can take your appliance either to the shop where you purchased the product, or contact your local government waste office for details of your nearest authorised WEEE collection point. For the most up to date information for your country, please see [www.lg.com/global/recycling](http://www.lg.com/global/recycling).

### **This washing machine contains fluorinated greenhouse gases**

R134a(GWP: 1430): 0.300 kg / 0.429 t CO<sub>2</sub>-eq. Hermetically sealed.

# INSTALLATION

## Parts and Specifications

### NOTE

- Appearance and specifications may change without notice to improve the quality of the appliance.

### Front View

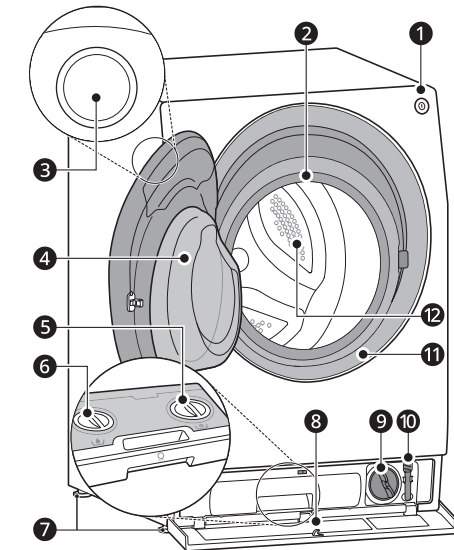

- ❶ Power Button
- ❷ Drum Light
- ❸ Control Panel
- ❹ Door
- ❺ Liquid Softener Dispenser Cap
- ❻ Liquid Detergent Dispenser Cap
- ❼ Leveling Feet
- ❽ Lower Cover
- ❾ Drain Pump Filter
- ❿ Drain Hose
- ⓫ Door Seal
- ⓬ Drum

### Rear View

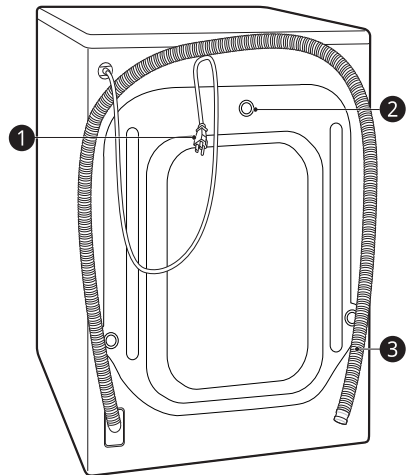

- ❶ Power Plug
- ❷ Transit Bolts
- ❸ Drain Hose

## Accessories

\*1 The included accessories vary depending on the model you purchased.

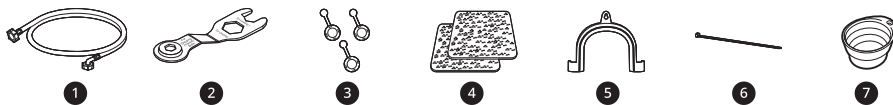

❶	Cold Supply Hose	❺	Elbow Bracket for Securing Drain Hose
❷	Spanner	❻	Tie Strap*1
❸	Caps for Covering Transit Bolt Holes	❼	Measuring Cup
❹	Anti-slip Sheets*1		

## Specifications

Model	LSWD100E
Power Supply	220-240 V~, 50 Hz
Product Weight	94.5 kg

### Dimension(mm)

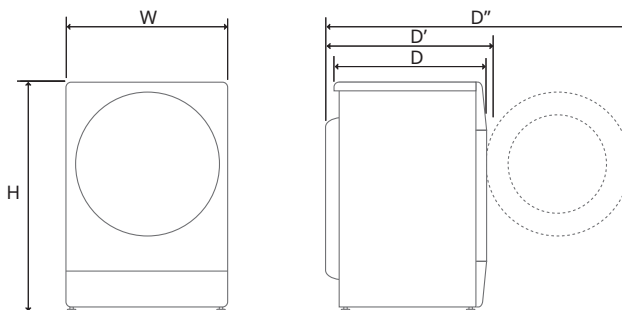

W	600	D	675	H	850
D'	640	D''	1100		

## Information on LED Lighting

This product contains the light source of energy efficiency class G.

- The LED lighting automatically turns on and off in any of the following cases:
  - when opening and closing the door,

## 14 INSTALLATION

---

- when pressing **Power** and **Start/Pause** Button.
- The LED lighting is not dimmable.
- The LED lighting does not contain mercury.
- Please see [www.lg.com/global/recycling](http://www.lg.com/global/recycling).

---

### NOTE

- This feature varies depending on the model purchased.
- 

#### If the LED lighting is not working

Close the door and re-open, or press **Power** Button. If the LED lighting does not turn on, please contact the LG Electronics customer information centre. Do not attempt removal of the LED lighting.

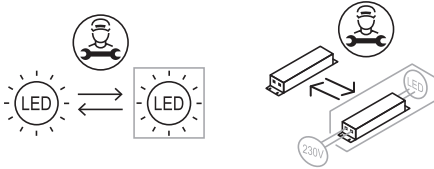

# Installation Place Requirements

Before installing the appliance, check the following information to make sure that the appliance should be installed in a correct place.

## Installation Location

- This appliance must be installed on firm flooring to minimize vibration during the spin cycle. Concrete flooring is best, being far less prone to vibration during the spin cycle than wooden floorboards or a carpeted surface.
- Do not place the washing machine on a small platform or on a wooden crate.
- If it is impossible to avoid positioning the appliance next to a gas cooker or coal burning stove, an insulation (850 X 600 mm) covered with aluminum foil on the side facing the cooker or stove must be inserted between the two appliances.
- Ensure that when the appliance is installed, it is easily accessible for an engineer in the event of a breakdown.
- When installing the appliance, adjust all four feet using the transit bolt spanner provided to ensure the appliance is stable.

## Floor Installation

To ensure sufficient clearance for water inlet hoses, drain hose and airflow, allow minimum clearances of at least 50 mm at the sides and 100 mm behind the appliance. Be sure to allow for wall, door, or floor moldings that may increase the required clearances.

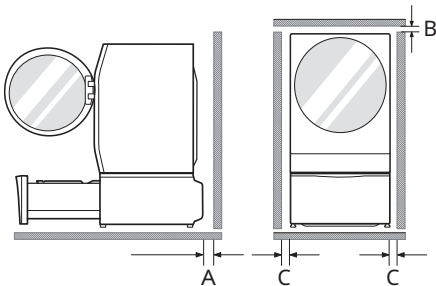

<b>A</b>	100 mm
----------	--------

<b>B</b>	5 mm
<b>C</b>	50 mm

## ⚠ WARNING

- This appliance must only be used for domestic household purposes and should not be used in mobile applications.

## NOTE

- Never try to level any uneven floor by putting pieces of wood, cardboard or similar materials under the appliance.

## Wooden Floors (Suspended Floors)

When installing the appliance on wooden floors, use rubber cups to reduce excessive vibration and unbalance. Timber or suspended type flooring may contribute to excessive vibration and unbalance, errors and malfunction.

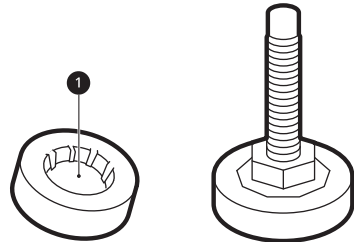

- To reduce vibration, we recommend placing at least 15 mm thickness of rubber cups **1** under each adjusting foot of the appliance, secured to at least two floor beams with screws.
- If possible, install the appliance in one of the corners of the room, where the floor is more stable.
- Fit the rubber cups to reduce vibration.

### **⚠ CAUTION**

- If the appliance is installed on the unstable floor (e.g. wooden floor), the warranty does not cover any damages and cost occurred due to the installation on the unstable floor.

### **NOTE**

- You can purchase rubber cups (part No. **4620ER4002B**) from the LG service centre.

## Ventilation

- Make sure that air circulation around the appliance should not be impeded by carpets, rugs, etc.

## Ambient Temperature

- Do not install the appliance in rooms where freezing temperatures may occur. Frozen hoses may burst under pressure. The reliability of the electronic control unit may be impaired at temperatures below freezing point.
- If the appliance is delivered in winter and temperatures are below freezing, place the appliance at room temperature for a few hours before putting it into operation.

## Electrical Connection

- Do not use an extension cord or double adapter.
- Always unplug the appliance and turn off the water supply after use.
- Connect the appliance to an earthed socket in accordance with current wiring regulations.
- The appliance must be positioned so that the plug is easily accessible.
- Power outlet must be within 1 meter of either side of the appliance.

### **⚠ WARNING**

- Repairs to the appliance must only be carried out by qualified personnel. Repairs carried out by inexperienced persons may cause injury or serious malfunctioning. Contact your local authorised LG repairer.
- The power plug must be plugged into an appropriate outlet socket that is installed and grounded/earthed in accordance with all local codes and ordinances.

## Unpacking the Appliance

### Lifting the Appliance Off the Foam Base

\* This feature may vary depending on the model purchased.

After removing the carton and shipping material, lift the appliance off the foam base.

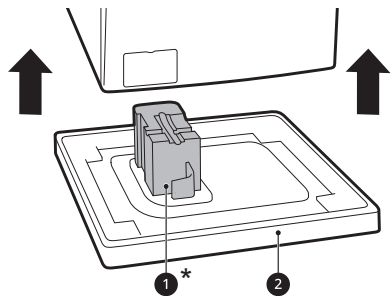

- Make sure the tub support **1\*** comes off with the base and is not stuck to the bottom of the appliance.
- If you must lay the appliance down to remove the carton base **2**, always protect the side of the appliance and lay it carefully on its side. Do not lay the appliance on its front or back.

## Removing the Transit Bolt Assemblies

To prevent the appliance from severe vibration and breakage, remove transit bolts and retainers.



- Starting with the bottom two transit bolts ❶, use the spanner (included) to fully loosen all transit bolts by turning them counterclockwise.

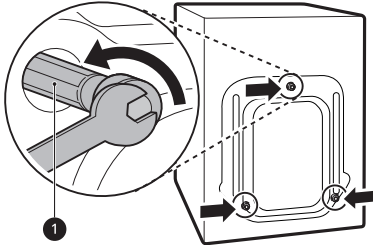

- If the appliance rocks when pushing the top plate of the appliance diagonally, adjust the feet again.
- Check whether the appliance is perfectly level after installation.

**NOTE**

- Timber or suspended type flooring may contribute to excessive vibration and unbalance. Reinforcement or bracing of the timber floor may need to be considered to stop or reduce excessive noise and vibration.

- Remove the bolt assemblies by wiggling them slightly while pulling them out.

- Install the hole caps.
  - Locate the hole caps ❷ included in the accessory pack or attached on the back.

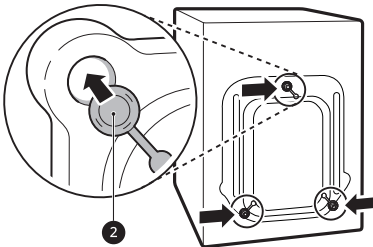

**Adjusting and Levelling the Feet**

When installing the appliance, the appliance should be aligned and perfectly level. If the appliance is not aligned and level properly, the appliance may be damaged or may not operate properly.

- Turn the levelling feet as required if the floor is uneven.
  - Do not insert pieces of wood etc. under the feet.
  - Make sure that all four feet are stable and resting on the floor.

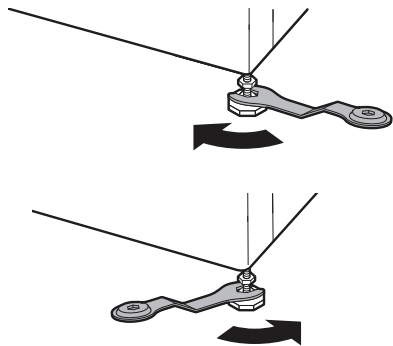

**NOTE**

- Save the transit bolts and retainers for future use.
- Transport this appliance for the prevention of breakage as below:
  - The transit bolts are reinstalled.
  - The power cord is secured to the back of the appliance.

**Levelling the Appliance**

**Checking the Level**

When pushing down the edges of the top plate diagonally, the appliance should not move up and down at all (check both directions).

## 18 INSTALLATION

### NOTE

- Do not install the washing machine on a plinth, stand or elevated surface unless it is manufactured by LG Electronics for use with this model.

- Check if the appliance is perfectly level using a spirit level ❶.

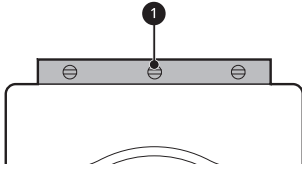

- Secure the levelling feet with the lock nuts ❷ by turning anti-clockwise against the bottom of the appliance.

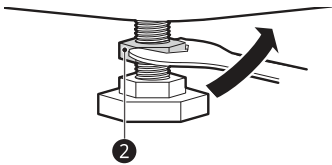

- Check if all lock nuts at the bottom of the appliance are secured properly.

### NOTE

- Proper placement and levelling of the appliance will ensure long, regular, and reliable operation.
- The appliance must be 100% horizontal and stand firmly in position on a hard flat floor.
- It must not 'Seesaw' across corners under the load.
- Do not let the feet of the appliance get wet. Failure to do so may cause vibration or noise.

If you install the appliance on a slippery surface, it may move because of excessive vibration. Incorrect levelling may cause malfunction through noise and vibration. If this occurs, install the anti-slip sheets under the levelling feet and adjust the level.

- Clean the floor to attach the anti-slip sheets.
  - Use a dry rag to remove and clean foreign objects and moisture. If moisture remains, the anti-slip sheets may slip.

- Adjust the level after placing the appliance in the installation area.

- Place the adhesive side ❶ of the anti-slip sheets on the floor.

- The most effective way is to install the anti-slip sheets under the front feet. If it is difficult to place the sheets under the front feet of the appliance, attach them under the rear feet.

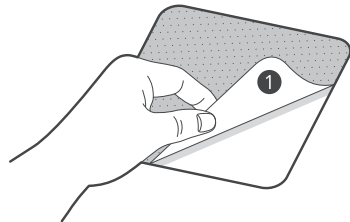

- Put the appliance on the anti-slip sheets.
  - Do not attach the adhesive side ❶ of anti-slip sheets to the feet of the appliance.

### NOTE

- Additional anti-slip sheets are available at LG Electronics service centre.

## Using Anti-Slip Sheets

This feature may vary depending on the model purchased.

## Connecting the Water Supply Hose

### Note for Connection

- Water pressure must be between **50 kPa** and **800 kPa** (0.5–8.0 kgf/cm<sup>2</sup>). If the water pressure is more than **800 kPa**, a decompression device should be installed.
- Periodically check the condition of the water supply hose and replace the water supply hose if necessary.

### NOTE

- Do not overtighten the water supply hose or use mechanical devices to tighten onto the inlet valves.
- No further backflow protection required for connection to the water inlet.

## Checking the Rubber Seal

Two rubber seals ❶ are supplied with the water supply hose. They are used to prevent water leaks. Connection to taps is sufficiently tight.

- Do not use mechanical devices such as multi grips to tighten the water supply hose. Ensure that the curved end of the water supply hose is connected to the appliance.

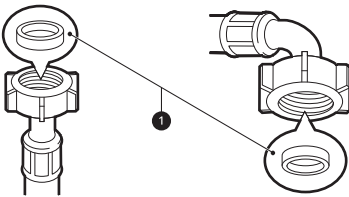

## Connecting the Hose to the Water Tap

### Connecting Screw-Type Hose to Tap with Thread

Screw the supply hose connector onto the water supply tap. Hand tighten only with the aid of a soft

cloth. Do not overtighten the supply hose with any mechanical device.

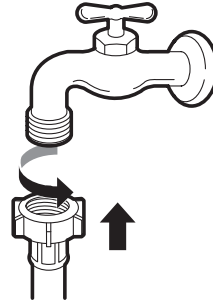

### NOTE

- After connecting the water inlet hose to the water tap, turn on the water tap to flush out foreign substances (dirt, sand, sawdust, and etc.) in the water lines. Let the water drain into a bucket, and check the water temperature.

## Connecting the Hose to the Appliance

Screw the supply hose to the water inlet valve on the back of the appliance.

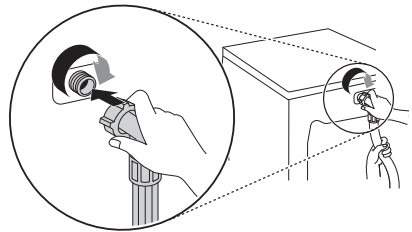

- Do not connect the hose to the hot water supply for models with one water inlet. Connect to the cold water supply only.

### NOTE

- After completing connection, if water leaks from the hose, repeat the same steps. Use the most conventional type of tap for the water supply. In case that the tap is square or too big, remove the guide plate before inserting the tap into the adaptor.

### NOTE

- Make sure that the hose should not be kinked or trapped.

- When installing the drain hose to a sink, secure it tightly with string.

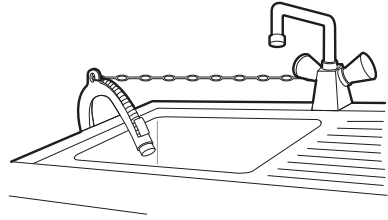

## Installing the Drain Hose

### Installing the Drain Hose with the Elbow Bracket

The drain hose should not be placed higher than **100 cm** above the floor. Water in the appliance may not drain or may drain slowly.

- Securing the drain hose correctly will protect the floor from damage due to water leakage.

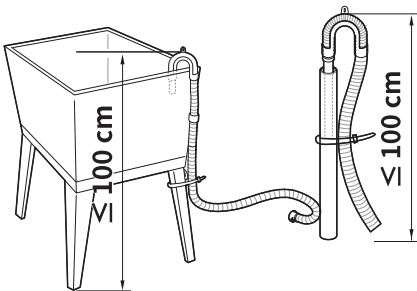
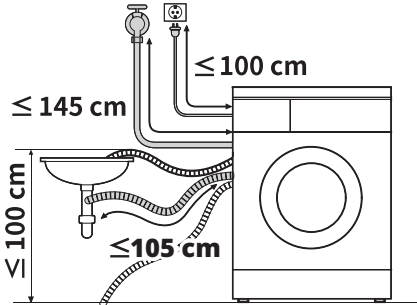

- If the drain hose is too long, do not force it back into the appliance. This will cause abnormal noise.

# OPERATION

## Operation Overview

### Using the Appliance

Before the first wash, select the **Cotton** wash programme and add a half amount of the detergent. Start the appliance without clothes. This will remove possible residues and water from the drum that may have been left during manufacturing.

- 1 Sort clothes by fabric type, soil level, colour and load size as needed.
- 2 Open the door and load items into the appliance.

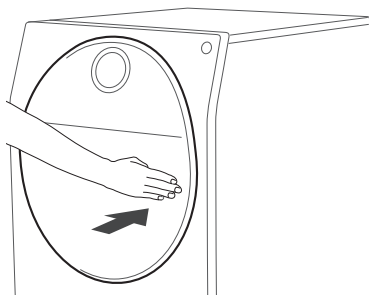

### ⚠ CAUTION

- Before closing the door, ensure that all clothes and items are inside the tub and not overhanging on the rubber door seal where they will become caught when the door is closed.

Failing to do so will cause damage to the door seal and the clothes.

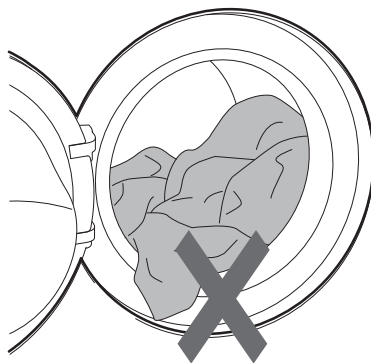

- 3 Close the door.

### ⚠ CAUTION

- Remove items from the flexible door seal gasket to prevent clothing and door seal damage.

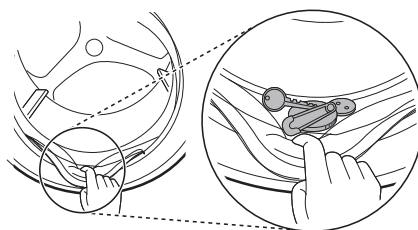

- 4 Add cleaning products or detergent and softener.
  - Add the proper amount of detergent to the detergent dispenser. If desired, add fabric

## 22 OPERATION

softener to the appropriate areas of the dispenser.

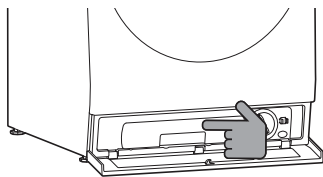

- 5** Press the **Power** button to turn on the appliance.



- 6** Choose the desired cycle.
- Press the cycle button repeatedly until the desired cycle is selected.
  - Now select a wash temperature and spin speed. Pay attention to the fabric care label of your clothes.

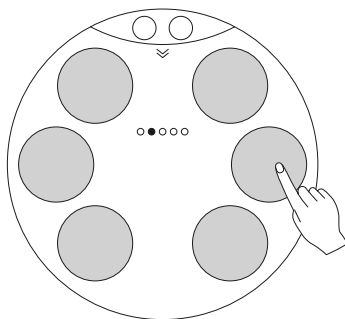

- 7** Begin cycle.
- Press the **Start/Pause** button to begin the cycle. The appliance will agitate briefly without water to measure the weight of the load. If the **Start/Pause** button is not

pressed within a certain time, the appliance will shut off and all settings will be lost.

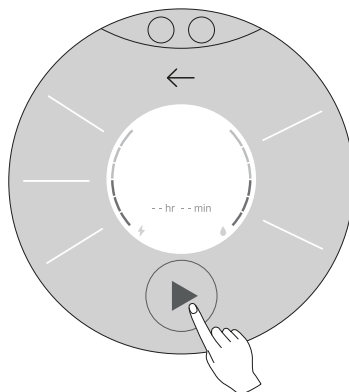

### NOTE

- In the following case, the door will not open even if you pause the washing programme or turn the washing machine off.
  - When the washing machine starts a washing programme and has water inside the drum, the door will not open in order to prevent a flood until the washing machine drains the water completely.

- 8** End of cycle.
- When the cycle is finished, a melody will sound. Immediately remove your clothing from the appliance to reduce wrinkling.
  - Check around the door seal when removing the load for small items that may be caught in the seal.

# Control Panel

The actual control panel may differ from model to model.

## Control Panel Features

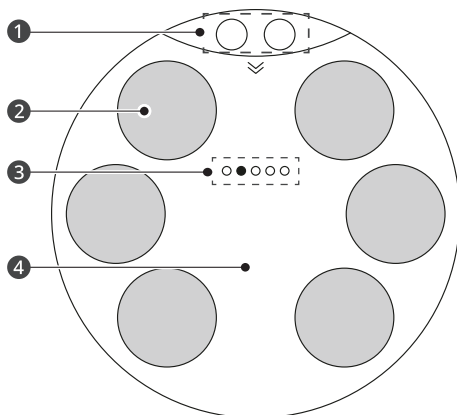

### 1 Quick Setting

- **Child Lock, Remote Start, Internal Lighting, Auto Detergent, Auto Softener,** Selection of **Main Washer** and **Mini Washer,** and **More Settings** are displayed. Touch a function to turn it on or off.

### 2 Programmes

- You may select a desired programme. For more information, see the **Washing Programmes** section.
- Download new and specialized programmes that are not included in the appliance's standard programmes in the **Download Cycles** category.

### 3 Programme Category

- The dots indicate the current category screen. Swipe the display left or right to show **Wash Cycles, Dry Cycles, Download Cycles,** and **AI Suggestion Cycles.**
- If you run the same programme more than three times, it will be registered under **AI Suggestion Cycles.**
- Programme categories may differ on some models.

### 4 Time and Status Display

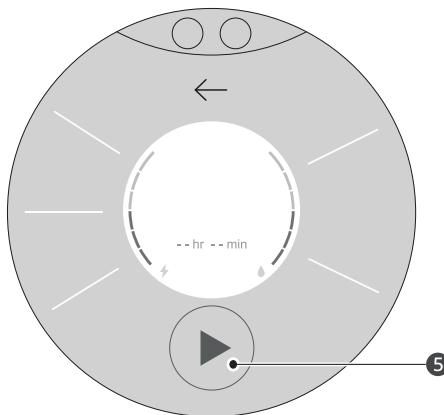

- The display shows the settings, estimated time remaining, options, and status messages for your washer. When the washer is turned on, the default settings in the display will illuminate.

### 5 Start/Pause Button

- Press this button to start the selected programme.
- If the washer is running, use this button to pause the programme without losing the current settings.

## NOTE

- If the **Start/Pause** button is not pressed to start the selected programme, after a delay the washer automatically turns off and all programme settings are lost.

## Preparing the Wash Load

Sort the wash load for best washing results, and then prepare the clothes according to the symbols on their care labels.

### Sorting the Clothes

- For best washing results, sort your clothes according to the care label stating fabric type and washing temperature. Adjust the spin speed or spin intensity in accordance with the fabric type.
- Soil level (Heavy, Normal, Light): Separate clothes according to soil level. If possible, do not wash heavily soiled items with lightly soiled ones.
- Colour (White, Lights, Darks): Wash dark or dyed clothes separately from whites or light colours. Mixing dyed clothes with light clothes can result in dye transfer or discolouration of lighter clothes.
- Lint (Lint producers, Collectors): Wash separately lint producing fabrics from lint collecting fabrics. Lint producers can result in pilling and linting on the lint collectors.

### Checking the Clothes Care Label

The symbols tell you about the fabric content of your garment and how it should be washed.

#### Symbols on the Care Labels

Symbol	Wash / Fabric type
	<ul style="list-style-type: none"> <li>• Normal Wash</li> <li>• Cotton, Mixed Fabrics</li> </ul>
	<ul style="list-style-type: none"> <li>• Easy Care</li> <li>• Synthetic, Mixed Fabrics</li> </ul>
	<ul style="list-style-type: none"> <li>• Special Delicate Wash</li> <li>• Delicates</li> </ul>
	<ul style="list-style-type: none"> <li>• Hand Wash Only</li> <li>• Wool, Silk</li> </ul>
	<ul style="list-style-type: none"> <li>• Do not wash</li> </ul>

### NOTE

- The dashes under the symbol give you information about the type of fabric and the maximum allowance of mechanical stress.

### Checking the Clothes before Loading

- Combine large and small items in a load. Load large items first.
- Large items should not be more than half of the total wash load. Do not wash single items. This may cause an unbalanced load. Add one or two similar items.
- Check all pockets to make sure that they are empty. Items such as nails, hair clips, matches, pens, coins and keys can damage both your appliance and clothes.

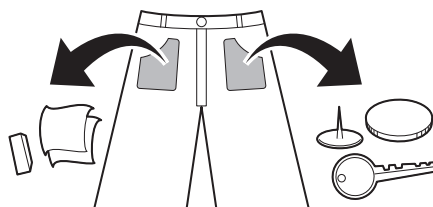

- Wash delicates (stockings, underwired bras) in a wash net.
- Close zippers, hooks and strings to make sure that these items do not snag on other clothes.
- Pre-treat dirt and stains by brushing a small amount of detergent dissolved water onto stains to help lift dirt.

## Adding Detergents and Softeners

### Detergent Dosage

- Detergent should be used according to the instruction of the detergent manufacturer and selected according to type, colour, soiling of the fabric and the washing temperature. Use only



detergents that are suitable for front loading washing machines.

- If too many suds occur, reduce the detergent amount.
- If too much detergent is used, too many suds can occur and this will result in poor washing results or cause heavy load to the motor.
- If you wish to use liquid detergent, follow the guidelines provided by the detergent manufacturer.
- You can pour liquid detergent directly into the main detergent drawer if you are starting the wash cycle immediately.
- If you select the **Prewash** option after adding the detergent directly into the drum, the detergent may be washed away, reducing the washing performance. For best results, use the **Prewash** option with the **Auto Detergent** function. The measuring cup cannot be used for dispensing pre-wash detergent.
- Detergent usage may need to be adjusted for water temperature, water hardness, size and soil level of the load. For best results, avoid overdosing the detergent. Failing to do so will cause oversudsing.
- Refer to the label of the clothes, before adding the detergent and choosing the water temperature.
- Use only suitable detergents for the respective type of clothing:
  - Liquid detergent is often designed for special applications, e.g. for coloured fabric, wool, delicate or dark clothes.
  - Powdered detergent is suitable for all types of fabric.
  - For better washing results of white and pale garments, use powdered detergent with bleach.
  - Detergent is flushed from the dispenser at the beginning of the wash cycle.

- Part load: 1/2 of the normal amount.
- Minimum load: 1/3 of full load.

## Using the Automatic Dispenser

When the **Auto Detergent** and **Auto Softener** functions are turned on, detergent and softener are automatically dispensed based on the load size during the programme.

- 1 Press the **O** mark to open the lower cover as shown below.

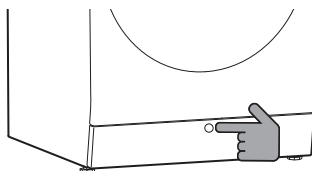

- 2 Press **Push** on the automatic dispenser tray as shown below. Use the handle to pull the tray out.

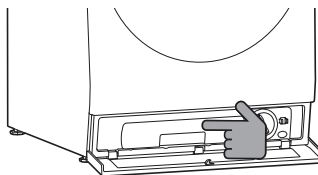

- 3 Turn the caps on the automatic dispenser tray to the left to open the two reservoirs.

- 4 Pour the detergent and softener into their respective reservoirs.
  - The automatic dispenser tray has two reservoirs. Put the liquid detergent **1** into the left reservoir and the fabric softener **2** into the right reservoir.
  - Fill to the **Max** line.

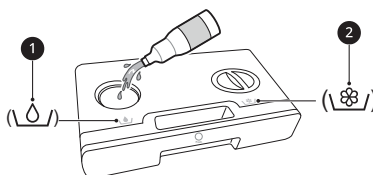

## NOTE

- Do not let the detergent harden. Doing so may lead to blockages, poor rinse performance or odour.
- Full load: According to manufacturer's recommendation.

- 5** After filling, insert and turn the caps to the right until tightly closed.

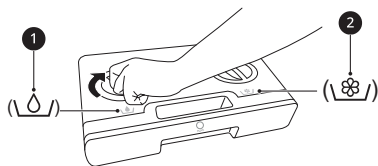

- 6** Insert the automatic dispenser tray until it clicks.

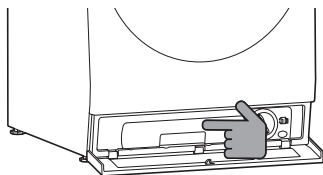

- 7** Close the lower cover.

- 8** Touch the icon at the top of the display to open the Settings screen and select the **Auto Detergent** and **Auto Softener** functions.

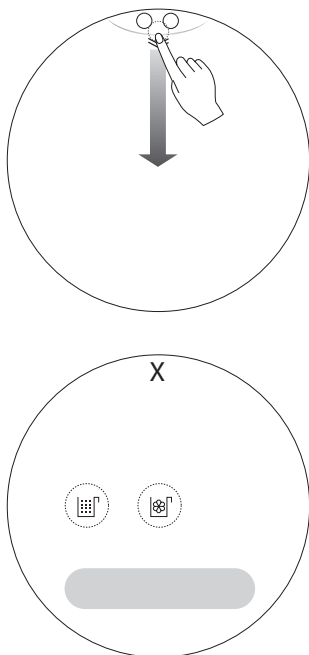

### ⚠ WARNING

- Do not mix chlorine bleach with ammonia or acids such as vinegar or rust/scale remover. Mixing chemicals like these can produce a lethal gas, resulting in severe injury or death.

### ⚠ CAUTION

- Do not place or store cleaning products, such as detergent, bleach, or liquid fabric softener, on top of your washing machine. These products can damage the washing machine's finish and controls.
- Remove the automatic dispenser tray only when refilling or replacing detergent or softener.
- Use only liquid HE detergents in the automatic dispenser tray.
- Do not pour any powdered cleaning products into the automatic dispenser reservoirs.
- Do not put liquid bleach into the automatic dispenser tray or the manual dispenser.
- The automatic dispenser function may not work properly with some concentrated gel detergents. Use the manual dispenser to dispense gel detergents.
- Do not mix detergent with fabric softener.
- Use care when removing and inserting the automatic dispenser tray, as detergent or fabric softener may spill. Wipe up any spills before proceeding.
- To use the automatic dispenser function, **Auto Detergent** and/or **Auto Softener** must be turned on in the Settings screen.
- Detergent or fabric softener left in the automatic dispenser reservoirs for an extended period may harden and fail to dispense properly.
- The ventilation holes (3) help in dispensing the detergent and fabric softener. Do not hold the

automatic dispenser tray upside down, as cleaning products may leak.

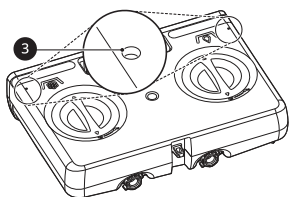

- Do not block the ventilation holes in the automatic dispenser tray.

## NOTE

- Before using the appliance, make sure there is detergent in the automatic dispenser reservoir.
- A full detergent reservoir will last for about 18 standard programmes, with half a load of laundry in the drum.
- The default settings are configured to automatically dispense 70 ml of detergent and 30 ml of softener for 4-6 kg of normally soiled laundry. For more details, see the **Settings** section of this manual.
- To set the automatic dispenser amounts for 4-6 kg, see the manufacturer's recommendations on the detergent or fabric softener.
- When you select **AI Wash**, **Auto Detergent** is automatically turned on.
- When Refill Alarm is displayed, refill detergent or softener.
- Remove any residual detergent on the outside of the automatic dispenser tray before inserting it.
- To change detergents, follow the steps above or turn off the **Auto Detergent** function and use the included manual dispenser.
- Do not use force when pulling out the automatic dispenser tray.
- To use the **Auto Detergent** function with the **Wool** programme or other programmes where a neutral detergent is recommended, touch **Cancel** when prompted.

## Dispensing Detergent Manually

To manually dispense powdered detergent or neutral detergent, disable the **Auto Detergent** function and use the provided measuring cup. To dispense oxygen-based bleach, leave the **Auto Detergent** function on. Do not put the measuring cup into the drum with liquid bleach.

- 1 Turn off the **Auto Detergent** function, if necessary.
- 2 Measure the proper amount of detergent and pour it into the measuring cup.



- 3 Place manual dispenser on top of clothing in drum.

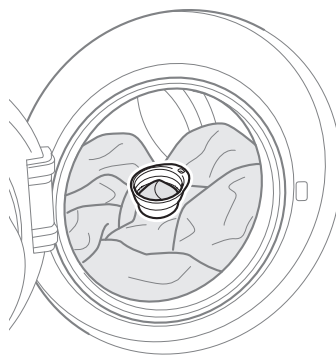

## NOTE

- Measure the detergent by reading the measuring markings inside the measuring cup.
- Wash the measuring cup after every wash.
- To add fabric softener, turn on the **Auto Softener** function.
- Do not put the measuring cup into the drum with the **Auto Detergent** function turned on.
  - If too much detergent is used, too many suds can occur and this will result in poor washing results or cause heavy load to the motor.

---

### NOTE

- When you use the **Delay End** function, the automatic dispenser function is recommended.
- 

## Adding Detergent Tablets

Detergent tablets can also be used when washing.

- 1 Open the door and put detergent tablets into the drum before loading the clothes.
- 2 Load the clothes into the drum and close the door.

---

### NOTE

- Do not put tablets into the dispenser.
- 

## Adding Water Softener

A water softener, such as anti-limescale can be used to cut down on the use of detergent in areas with high water hardness level.

- First add detergent, and then the water softener. Dispense according to the amount specified on the packaging.

# Programme Table

## Washing Programme

### Wash Cycles

<b>Cotton</b>	<b>40 °C (Cold to 95 °C)</b>	<b>Max. Load: Rating</b>
Description	Washes normally soiled clothes by combining various drum motions.	

<b>Speed 14</b>	<b>20 °C (20 °C to 40 °C)</b>	<b>Max. Load: 2 kg</b>
Description	Washes small loads of lightly soiled clothes for approximately 14 minutes.	

<b>Mix</b>	<b>40 °C (Cold to 40 °C)</b>	<b>Max. Load: 6 kg</b>
Description	Washes mixed fabrics simultaneously. <ul style="list-style-type: none"> <li>• Use for various kind of fabrics except special garments (silk/delicate, sports wear, dark clothes, wool, duvet/curtains).</li> </ul>	

<b>AI Wash</b>	<b>40 °C</b>	<b>Max. Load: Rating</b>
Description	Adjusts wash and rinse patterns automatically after detecting the amount of clothes and soil level.	

<b>Easy Care</b>	<b>40 °C (Cold to 60 °C)</b>	<b>Max. Load: 5 kg</b>
Description	Washes clothes that do not need ironing after washing. <ul style="list-style-type: none"> <li>• Use for Polyamide, acrylic, polyester.</li> </ul>	

<b>Wash+Dry (7 kg)</b>	<b>40 °C (Cold to 95 °C)</b>	<b>Max. Load: 7 kg</b>
Description	Washes and dries clothes in the same programme.	

<b>Allergy Care</b>	<b>60 °C (60 °C to 95 °C)</b>	<b>Max. Load: 6 kg</b>
Description	Helps minimise substances that cause an allergic reaction. <ul style="list-style-type: none"> <li>• Use for cotton, underwear, pillow covers, bed sheets, baby wear.</li> </ul>	

<b>Outdoor</b>	<b>30 °C (Cold to 40 °C)</b>	<b>Max. Load: 2 kg</b>
Description	Washes special garments like sports and outdoor wear. <ul style="list-style-type: none"> <li>• Use for water-repellent fabric laminate used on clothing.</li> </ul>	

## 30 OPERATION

<b>Wool</b>	<b>30 °C (Cold to 40 °C)</b>	<b>Max. Load: 3 kg</b>
Description	Washes hand-washable and machine-washable delicate clothes such as washable wool, lingerie, dresses etc. • Use detergent for machine washable woolens.	

<b>Stain Care</b>	<b>40 °C or 60 °C (30 °C to 60 °C)</b>	<b>Max. Load: 3 kg</b>
Description	Washes heavily soiled clothes by combining special drum motions.	

<b>Delicate</b>	<b>30 °C (Cold to 40 °C)</b>	<b>Max. Load: 3 kg</b>
Description	Washes machine-washable lingerie, sheer and lacy clothes.	

<b>Direct Wear (1 kg)</b>	<b>20 °C (20 °C to 40 °C)</b>	<b>Max. Load: 1 kg</b>
Description	Washes and dries 1-3 shirts, slightly soiled, within 80 minutes.	

## Download Cycles

<b>Tub Clean</b>	-	-
Description	This function helps clean the inside of your appliance's tub.	

<b>Rinse+Spin</b>	-	<b>Max. Load: Rating</b>
Description	Rinses and spins clothes. Use fabric softener if needed.	

<b>Eco 40-60</b>	<b>40 °C (40 °C to 60 °C)</b>	<b>Max. Load: Rating</b>
Description	Washes normally soiled cotton clothes declared to be washable at 40 °C or 60 °C.	

<b>TurboWash 49</b>	<b>40 °C (Cold to 40 °C)</b>	<b>Max. Load: 6 kg</b>
Description	Washes small loads of lightly soiled clothes in a short time.	

## NOTE

- The test results depend on water pressure, water hardness, water inlet temperature, room temperature, type and amount of load, degree of soiling utilized detergent, fluctuations in the main electricity supply and chosen additional options.
- Select the appropriate water temperature for chosen wash programme. Always follow garment manufacturer's care label or instructions when washing to avoid damage to clothes.
- Select the proper wash temperature and spin speed for the desired programmes.
- Actual water temperature may differ from the declared cycle temperature.

- Neutral detergent is recommended.

## Extra Options

### NOTE

- **Delay End** can be selected for every programme in this table except for the **Tub Clean** programme.
- **Crease Care** can be selected for every programme in this table except for the **Wash+Dry (7 kg)**, **Direct Wear** and **Tub Clean** programmes.

Programme	Turbo Wash	Prewash	Medic Rinse
Cotton	●	●	●
Speed 14			
Mix	●	●	●
AI Wash			
Easy Care	●	●	●
Wash+Dry (7 kg)	●	●	●
Allergy Care			●
Outdoor <sup>*2</sup>	●		
Wool <sup>*2</sup>			
Stain Care	●	●	●
Delicate <sup>*2</sup>	●		
Direct Wear (1 kg)	● <sup>*1</sup>		
Tub Clean			
Rinse+Spin			●
Eco 40-60	●	●	●
TurboWash 49	● <sup>*1</sup>		

\*1 This option is automatically included in the programme and cannot be deselected.

\*2 This programme recommends using a neutral detergent or an exclusive detergent.

## Selectable Maximum Spin Speed

Programme	Spin Speed(rpm)	
	Default	Available
Cotton	1600	All
Speed 14	400	
Mix	1000	All
AI Wash	1200	All
Easy Care	1200	
Wash+Dry (7 kg)	1200	
Allergy Care	1600	All
Outdoor	800	
Wool	800	
Stain Care	1000	All
Delicate	800	
Direct Wear (1 kg)	1200	
Tub Clean	-	-
Rinse+Spin	1600	All
Eco 40-60	1600	All
TurboWash 49	1000	All

### NOTE

- Actual maximum spin speed may vary depending on the load conditions. The values above are rounded to the nearest hundred.

## Consumption Data

### Unit Description

**kg:** Laundry load

**h:mm:** Programme duration

**kWh:** Energy consumption

**°C:** Maximum temperature inside the treated textile



**Litres:** Water consumption

**rpm:** Maximum spin speed

**%:** Remaining moisture at the end of spinning phase. The higher is the spin speed, the higher is the noise and the lower is the remaining moisture.

## Common Programmes

Programme	kg	h:mm	kWh	°C	Litres	rpm	%
<b>Cotton 20 °C</b>	12	2:10	0.221	28	142.0	1550	49.50
<b>Cotton 60 °C</b>	12	2:15	1.652	50	157.0	1550	50.70
<b>Eco 40-60 (Full)*<sup>1</sup></b>	12	4:00	1.070	34	95.0	1550	44.50
<b>Eco 40-60 (Half)*<sup>1</sup></b>	6	3:00	0.545	28	50.0	1550	44.00
<b>Eco 40-60 (Quarter)*<sup>1</sup></b>	3	2:59	0.330	25	43.0	1550	45.50
<b>Mix</b>	6	1:26	0.710	38	83.0	1150	56.80
<b>Speed 14</b>	2	0:14	0.015	24	34.0	380	114.10
<b>Cotton 40 °C + Heavy Soil</b>	12	2:47	0.994	36	181.0	1550	50.20
<b>Eco 40-60 + Eco(dry) (Full)*<sup>2</sup></b>	7	10:10	2.365	30	80.0	1200	-
<b>Eco 40-60 + Eco(dry) (Half)*<sup>2</sup></b>	3.5	6:50	1.185	26	50.0	1200	-

\*1 It is able to clean normally soiled cotton laundry declared to be washable at 40 °C or 60 °C, together in the same cycle, and that this programme is used to assess the compliance with the EU ecodesign legislation (EU 2019/2023).

\*2 It is able to clean normally soiled cotton laundry declared to be washable at 40 °C or 60 °C, together in the same cycle, and to dry it in such a way that it can be immediately stored in a cupboard, and that this programme is used to assess the compliance with the EU ecodesign legislation (EU 2019/2023).

## NOTE

- The test results depend on water pressure, water hardness, water inlet temperature, room temperature, type and amount of load, degree of soiling utilized detergent, fluctuations in the main electricity supply and chosen additional options.
- The values for the common programs, with the exception of the **Eco 40-60** and **Eco 40-60 + Eco(dry)** cycles, are indicative only.
- Regulation EU 2019/2023, valid from 1st March 2021, is related to the Energy Efficiency classes by Regulation EU 2019/2014.

### NOTE

- Scan the QR code on the energy label supplied with the appliance, which provides a web link to the information related to the performance of the appliance in the EU EPREL database. Keep the energy label for reference together with the owner's manual and all other documents supplied with the appliance.
  - The model name can be found on the rating label of the appliance, open the door which is just around the opening to the drum.
  - To find the same information in EPREL, visit <https://eprel.ec.europa.eu> and search using the model name. (Valid from 1st March 2021)
-

# Drying Programme

## General Tips for Drying

Use the automatic programmes to dry most loads. Electronic sensors measure the temperature of the exhaust to increase or decrease drying temperatures for faster reaction time and tighter temperature control.

- Cold water tap must be left on during drying cycles.
- This appliance's automatic process from washing to drying can be selected easily.
- For most drying, make sure all clothes are similar in material and thickness.
- Do not overload the appliance by stuffing too many articles into the drum. Items must be able to tumble freely.
- If you open the door and remove the load before the appliance has finished its programme, remember to press the **Start/Pause** button.
- After the drying is finished, **End of Cycle** appears on the display. If the clothes are not unloaded from the drum in a period of time, **Cooling** appears on the display and the appliance tumbles the clothes periodically for about 4 hours to reduce creases. To stop this function, press any button and unload the clothes from the drum.

## Woolen Articles

Do not tumble dry woolen articles. Pull them to their original shape and dry them flat.

## Woven and Loopknit Materials

Some woven and loopknit materials may shrink, by varying amounts, depending on their quality. Always stretch these materials out immediately after drying.

## Permanent Press and Synthetics

Do not overload your appliance. Take out permanent press articles as soon as the appliance stops to reduce wrinkles.

## Baby Clothes and Night Gowns

Always check the manufacturer's instructions.

## Blankets and Duvets

Check fabric care labels on blankets and duvets before using the drying programme. Some blankets and duvets may shrink by the heated air.

## Rubber and Plastics

Do not dry any items made from or containing rubber or plastics, such as:

- Aprons, bibs, chair covers
- Curtains and table cloths
- Bathmats

## Fiber Glass

Do not dry fiber glass articles in the appliance. Glass particles left in the appliance may be picked up by your clothes and cause skin irritation.

## NOTE

- When you turn off the drying cycle of the appliance, the drying fan motor can be operated to save itself for 60 seconds.
- Be careful when removing your clothing from the appliance, as the clothing or appliance may be hot.
- The estimated drying time varies from the actual drying time during the Automatic cycle. The type of fabric, size of the load, and the dryness selected affect drying time.
- When you select drying only, spinning runs automatically for energy efficiency.

## Using Dry Programmes

### Washing and Drying in One Continuous Sequence

- 1 Prepare the clothes and load the drum.
  - For consistent dry load, all articles in the load should be similar in material and thickness.
  - Do not overload the drum. Clothes must have room to tumble freely.
- 2 Press the **Power** button.
- 3 Select a **Wash+Dry (7 kg)** programme.
- 4 Select an extra option except for **Crease Care** option.
- 5 Add detergent.
- 6 Touch the **Dry ①** button to open the modifier's screen and change the default dry setting.
- 7 Press the **Start/Pause** button.

Programme	Dry Options	Wash Temp	Spin Speed	Maximum Load
<b>Wash+Dry (7 kg)</b>	Default: <b>Normal</b> Available: All	Default: 40 °C Available: All	Default: 1200 Available: 1000 to 1600	7 kg

### Separate Drying

- 1 Prepare the laundry and load the drum.
  - For consistent dry load, all articles in the load should be similar in material and thickness.
  - Do not overload the drum. Clothes must have room to tumble freely.
- 2 Press the **Power** button.
  - Do not select the wash programme.
- 3 Select a dry programme.
- 4 Touch the **Dry ①** button to open the modifier's screen and change the default dry setting.
- 5 Press the **Start/Pause** button.

Programme	Dry Options		Maximum Load
	Default	Available	
Cotton	Normal	All	7 kg
Outdoor	Normal	Cooling, Normal, Iron	2 kg
Time Dry	Time Dry (30 minutes)	Cooling, Time Dry (30/60/90/120 minutes)	3 kg
Easy Care	Normal	Cooling, Normal, Iron	3.5 kg
Delicate	Normal	Cooling, Normal	1.5 kg
Steam Refresh	No Dry	-	3 kg

## NOTE

- **Delay End** can be selected for every programme in this table except for the **Steam Refresh** programmes.

## Adding Dry Options

Touch the **Dry 1** button to open the modifier's screen and change the default dry setting.

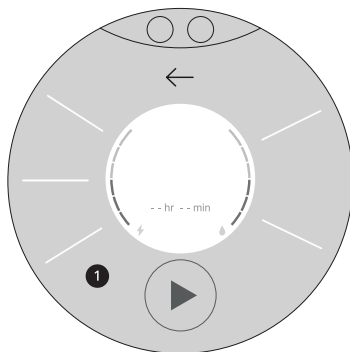

### Cooling

Use this setting for clothes which are sensitive to hot temperature or to cool down clothes after drying, if they are too hot to handle.

### Normal

Use the Normal Dry setting to dry normal fabrics.

### Iron

Use Iron Dry to leave clothes slightly damp for easier ironing.

### Eco

Use this special setting to optimise energy consumption while drying.

### **Speed**

Use Speed Dry to dry clothes more quickly.

### **Time Dry (30/60/90/120 minutes)**

Select the drying time according to the load size.

---

### **NOTE**

- For effective drying performance, remove half of the clothes prior to starting the dry programme.
  - All dry programmes begin with a spin programme to get water out of clothes for several minutes.
-

## Extra Options and Functions

You can use the extra options and functions to customize the programmes.

### Customising a Washing Programme

Each programme has default settings that are selected automatically. You may also customise these settings using these buttons.

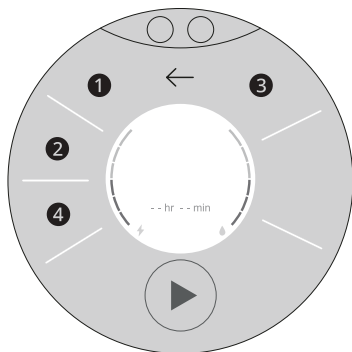

#### NOTE

- Selectable options will differ depending on the selected programme.

#### 1 Soil

Press the **Soil** button repeatedly until the desired soil level is selected.

- **Heavy**: for normal and heavily soiled clothes
- **Normal**: for normal soiled clothes
- **Light**: for lightly soiled clothes

#### 2 Rinse

The number of rinses can be selected by pressing the **Rinse** button. This function is recommended for people with detergent allergies.

- **Rinse+**: Add rinse once.
- **Rinse++**: Add rinse twice.
- **Rinse & Hold**: The rinse cycle is paused until the **Start/Pause** button is pressed again when rinse is finished.

- **Rinse+ & Hold**: Add rinse once then after the rinse cycle, and then the rinse cycle is paused until the **Start/Pause** button is pressed again.

#### 3 Temp.

This button selects the wash temperature for the selected programme.

Press the **Temp.** button until the desired setting is lit.

- Select the water temperature suitable for the type of load you are washing. Follow the garment fabric care labels for best results.

#### 4 Spin

The spin intensity level can be selected by pressing this button repeatedly.

Press the **Spin** button to select spin speed.

### Follow the next steps to customise a washing programme:

- 1 Prepare the clothes and load the drum.
- 2 Press the **Power** button.
- 3 Add detergent.
- 4 Select a washing programme.
- 5 Customise the washing programme (**Soil**, **Rinse**, **Temp.**, and **Spin**) as necessary.
- 6 Change the options and press the **OK** button.
- 7 Press the **Start/Pause** button.

## Using Special Options

You can customize the programmes by using the following special options:

#### Turbo Wash

Adding this option reduces the programme time but the similar washing results will be provided.

## 40 OPERATION

### Prewash

This option is recommended when washing a heavily soiled load.

### NOTE

- If you select this option after putting the detergent directly in drum, the detergent may be washed away, causing less washing performance. When selecting this option, be sure to set to the **Auto Detergent**.

### Medic Rinse

Adding this option allows the final rinse to be heated to 40 °C.

### Crease Care

Adding this option reduces wrinkles by steaming after spin.

### NOTE

- Selecting this option will tumble the clothes briefly every few minutes for up to 30 minutes after the selected programme finishes. While this option is running, **End** appears on the display.

## Follow the next steps to use a special option.

- 1 Press the **Power** button.
- 2 Select a washing programme.

- 3 Press the **Add Option** ① on the display as necessary.

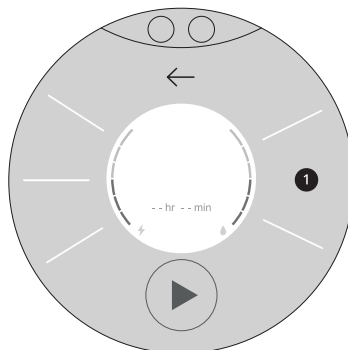

- 4 Select the options (**Turbo Wash**, **Prewash**, **Medic Rinse** or **Crease Care**) and press the **OK** button.

- 5 Press the **Start/Pause** button.

## Selecting a Time for the Programme to Finish

You can set this function so that the appliance starts automatically and finishes after a specified time interval.

- 1 Press the **Power** button.
- 2 Select a washing programme.
- 3 Press the **Delay End** button.
- 4 Select a time for the programme to finish the washing clothes.
- 5 Press the **OK** button.
- 6 Press the ► button.

### NOTE

- Except for LED of the **Power** button, LCD display will be turned off within 20 minutes. When LCD



display turns off, LED at **Power** button will start to blink. This feature may vary depending on the model purchased.

- The delay time is the time to the end of the programme, not the start. The actual running time may vary due to water temperature, clothes and other factors.
  - To cancel the function, the **Power** button should be pressed.
  - Avoid using liquid detergent for this function.
- 

## Adding or Removing Clothes After the Programme Has Started

You can use this option in order to add or remove clothes after the washing programme has started.

- 1** Press the **Power** button.
- 2** Select a washing programme.
- 3** Press the ► button to start.
- 4** Press the ► button to add or remove clothes.
- 5** Press the **Add Item** button.
- 6** Open the door after it unlocks itself and add or remove necessary clothing items.
- 7** Close the door and press the ► button.

---

### NOTE

- For safety reasons, the door remains locked when the water level or temperature inside of the drum is high. It is not possible to add clothes at this time.
-

## Settings

### Locking/Unlocking the Control Panel

Use this option to disable the controls. This function can prevent children from changing cycles or operating the appliance.

#### NOTE

- Once this function is set, all buttons are locked except the **Power** button, the Settings drop down button, and the button to switch between the **Main Washer** and **Mini Washer**.
- Turning off the power will not reset this function. You must deactivate this function before you can access any other functions.

### Locking/Unlocking the Control Panel

- 1 Turn on the power.
- 2 Touch **Child Lock** in the Settings screen to activate/deactivate this function.

## Remote Start

Use a smart phone to control your appliance remotely. You can also monitor your cycle operation so you know how much time is left in the cycle.

#### NOTE

- You must first connect to a gateway and register your appliance in order to use the **Remote Start** function. (Refer to Smart Functions)

#### To Use Remote Start

- 1 Turn on the power.
- 2 Put the laundry in drum.

- 3 Press **Remote Start** icon or **More Settings** button on the settings window, turn on **Remote Start** option.

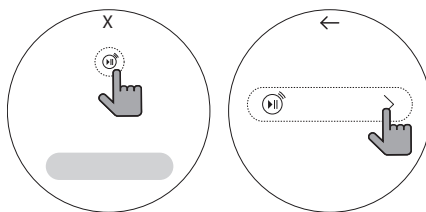

- 4 Start a cycle from the **LG ThinQ** application on your smart phone.

#### NOTE

- If you do not start your appliance, it will wait to start a cycle until you turn off your appliance from the application or disable the **Remote Start** function.
- When **Remote Start** is turned on, the door is automatically locked.

#### To Disable Remote Start

When the **Remote Start** is unactivated, turn off **Remote Start** option.

#### NOTE

- If the door is open, **Remote Start** is disabled.

## Turning On/Off the Automatic Dispenser Function

- 1 Press the **Power** button to turn on the washer.
- 2 Swipe the display down to see the **Settings** screen.
- 3 Touch **Auto Detergent** or **Auto Softener** in the **Settings** screen to activate/deactivate the automatic dispenser function.

## Various Settings

Swipe down the display to open the Settings screen. Touch **More Settings** to reveal the entire Settings menu.

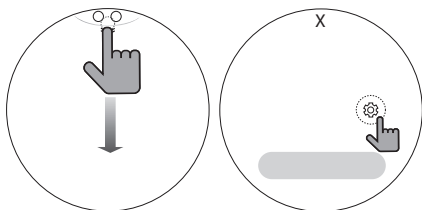

### Wi-Fi Settings

Set up the Wi-Fi connection. When **Wi-Fi** is turned on, the **Wi-Fi** icon appears in the display.

### Remote Start

Use a smartphone to control your washer remotely.

- For more information, see **SMART FUNCTIONS** in this manual.

### Auto Dispense

For more information, see **Changing Default Dispense Amounts** in this manual.

### Internal Lighting

Use this option to turn button **Internal Lighting** on or off.

### Washer Pairing

For more information, see **Washer Pairing** in this manual.

### Sound

Use this option to turn button **Sound** on or off.

### Screen

Use this option to select **Child Lock** function for each washing machine and to adjust brightness.

- Set brightness from 20% to 100%.

### Time

Change the current time.

### Summer Time

Set the time for Daylight Savings Time.

### Language

Change the display language.

### Others

Touch **Others** to reveal the entire Settings menu.

### Smart Diagnosis

Use this to help troubleshoot errors or malfunctions.

- See the **Smart Diagnosis** section for more details.

### Initial Guide

Select this item to view operating instructions in the display window.

### Programme Update

Check to see if a newer version of the software is available.

### Factory Data Reset

For more information, see **Factory Data Reset** in this manual.

### Open Source Licenses

To obtain the source code under GPL, LGPL, MPL, and other open source licenses, that is contained in this product, please touch **Open Source Licenses**.

## Changing Default Dispense Amounts

Use this button to set up and control the automatic dispenser function.

- When the **Refill Alarm** is displayed, refill detergent or softener.
- The default settings are configured to dispense **70 ml** of detergent and **30 ml** of softener for **4 - 6 kg** of normally soiled laundry.
- The default amounts can be increased or decreased in **3 ml** increments, within a range of **9 ml** to **180 ml**. The amount dispensed may vary slightly depending on the model.

- 1 Press the **Power** button to turn on the washer.
- 2 Swipe the display down to see the **Settings** screen and select **More Settings**. Select **Auto Dispense** from the Settings menu.
- 3 Turn on **Auto Detergent**.

- Change the default dispense amount as desired and press **OK**.

## Washer Pairing

\* This feature may vary depending on the model purchased.

Select this to (un)pair the **Main Washer** and the **Mini Washer**.

- This option is available when the **Main Washer** is used with the **Mini Washer**.

- Press the **Power** button.
- Swipe the display down to see the Settings screen and select **More Settings**. Select **Washer Pairing** from the Settings menu.

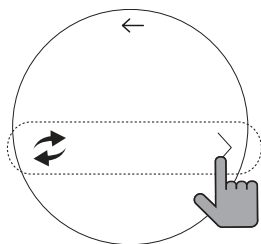

- Press the **Pair** button.
  - When pairing is done, a popup window will appear in the display.

**If pairing fails, follow these steps:**

- Make sure the **Mini Washer** is plugged in.
- Reset the **Mini Washer**:  
Press the **Power** button on the **Mini Washer**. Press and hold **Light Soil** and **Rinse+Spin** at the same time for **7 seconds**.

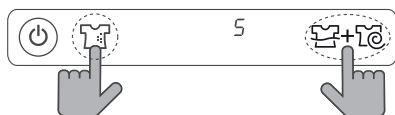

- If pairing fails several times, reset both the **Main Washer** and **Mini Washer**.  
See the **Factory Data Reset** section for instructions on resetting the **Main Washer**.

- When **0** appears on the display, repeat Step 2.
- When the reset is complete, a number that is **1** or above is displayed. Try pairing again by referring to **Washer Pairing**.

### Switching Between Main and Mini Washer

When the **Main Washer** and **Mini Washer** are paired, this function allows you to switch the controls between the two washers. Swipe down to open the Settings screen to select **Main Washer** or **Mini Washer**.

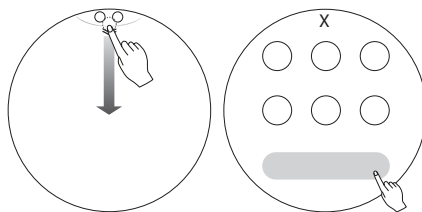

### NOTE

- This feature is available only when the **Mini Washer** is connected.
- The cycles in **Main Washer** and **Mini Washer** are available at the same time. When both washers are running, the following display appears.

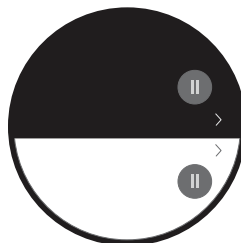

## Factory Data Reset

Select this to delete all the stored data and reset to the default settings.

- Press the **Power** button.

- 2 Swipe down on the display to open the Settings screen and select **More Settings**. Select **Factory Data Reset** from the Settings menu.

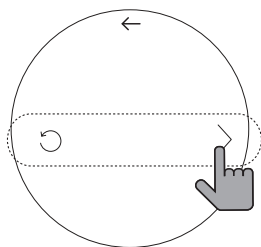

- 3 Press **Reset**.

- 4 Press the **Yes** button.

## NOTE

- When a factory data reset is performed on the **Main Washer**, all data is deleted, including the **Wi-Fi** settings.
- The pairing can be delayed or fail due to communication problems between the **Main Washer** and **Mini Washer** or a **Wi-Fi** issue.

# SMART FUNCTIONS

## LG ThinQ Application

The **LG ThinQ** application allows you to communicate with the appliance using a smartphone.

### LG ThinQ Application Features

Communicate with the appliance from a smartphone using the convenient smart features.

#### Remote Start

It allows you to control the appliance remotely from the **LG ThinQ** application.

#### Download Cycle

You can download new and special cycles that are not included in the basic cycles on the appliance.

A variety of specialty cycles specific to the appliance can be downloaded to the successfully registered appliances.

Once cycle download is completed in the appliance, the appliance keeps the downloaded cycle until a new cycle is downloaded.

### NOTE

- Only one downloaded cycle can be stored on the appliance at a time.

#### Tub Clean Coach

This function shows how many cycles remain before it is time to run the **Tub Clean** function.

#### Energy Monitoring

This function checks the energy consumption of the recently used cycles and monthly average.

#### Smart Diagnosis

This function provides useful information for diagnosing and solving issues with the appliance based on the pattern of use.

#### Settings

Allows you to set various options on the appliance and in the application.

#### Push Alert

When the cycle is complete or the appliance has problems, you have the option of receiving push

notifications on a smartphone. The notifications are triggered even if the **LG ThinQ** application is off.

### NOTE

- If you change your wireless router, Internet service provider, or password, delete the registered appliance from the **LG ThinQ** application and register it again.
- The application is subject to change for appliance improvement purposes without notice to users.
- Functions may vary by model.

## Installing the LG ThinQ Application

Search for the **LG ThinQ** application from the Google Play Store or Apple App Store on a smartphone. Follow instructions to download and install the application.

## Activating Network Connection

- 1 Run the **LG ThinQ** application.
- 2 Select and touch the **Front Load Washer** in the application.
- 3 Press the **Power** button.
- 4 Swipe down on the display to open the Settings screen and select **More Settings**. Select **Wi-Fi Settings** from the Settings menu.
- 5 Turn on Wi-Fi at Wi-Fi settings.
  - You can see the Wi-Fi icon at display when Wi-Fi is connected.

## Using the Appliance Remotely

### Remote Start

Use a smartphone to control your appliance remotely. You can also monitor your cycle operation so you know how much time is left in the cycle.

#### Using Remote Start

- 1 Put the laundry in the drum.
- 2 Press the **Power** button.
- 3 Swipe down from the top of the display to open the Settings screen and touch **More Settings**. Touch **Remote Start** in the Settings menu.

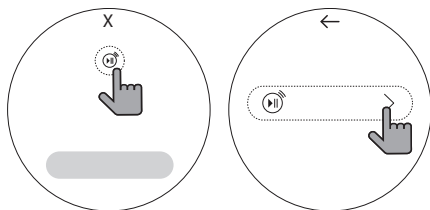

- 4 Start a cycle from the **LG ThinQ** application on your smartphone.

### NOTE

- Once this function is enabled, you can only start a cycle from the **LG ThinQ** smartphone application. If the cycle is not started, the appliance will wait to start the cycle until it is turned off remotely from the application or this function is disabled.
- If the door has been opened, you cannot start a cycle remotely.

#### Disabling Remote Start Manually

To disable **Remote Start**, turn it off in the Settings screen.

### Download Cycle

You can download new and specialized cycles that are not included in the standard cycles on the appliance.

Appliances that have been successfully connected can download a variety of specialty cycles specific to the appliance.

Once cycle download is completed in the appliance, the product keeps the downloaded cycle until a new cycle is downloaded.

#### Downloading Cycles Using an Application

- 1 Press the **Power** button.
- 2 Using the **LG ThinQ** app, check which cycles are currently downloaded.
  - Press ⊕ in the application to check which cycle has been downloaded on the washer.
- 3 Select **Downloaded** button.

#### Downloading Cycles Directly

- 1 Press the **Power** button.
- 2 Swipe left on the display to get to the **Download Cycles** screen and press **Edit**.
  - You may need to delete one of the existing cycles to make room for a new downloaded cycle.
- 3 Press the add icon ⊕ to select a cycle to download.

#### Deleting a Downloaded Cycle

- 1 Press the **Power** button.
- 2 Swipe left on the display to get to the **Download Cycles** screen and press **Edit**.
  - You may need to delete one of the existing cycles to make room for a new downloaded cycle.
- 3 Press the ⊗ button on the cycle you want to delete.
- 4 Press the **OK** button.

## Deactivating Network Connection

On your smartphone, disconnect to your home Wi-Fi network.

- 1 Run the **LG ThinQ** application.
- 2 Select and touch the **Front Load Washer** in the application.
- 3 Select and touch the **Delete Product** on the settings menu to disconnect it.

## Deactivating Network Connection

- 1 Press the **Power** button.
- 2 Swipe down on the display to open the Settings screen and select **More Settings**. Select **Wi-Fi Settings** from the Settings menu.
- 3 Turn off Wi-Fi at Wi-Fi settings to deactivate Network Connection.

## Wireless LAN Module Specifications

Model	LCW-009
Frequency Range	2412 MHz to 2472 MHz
Output Power (Max.)	IEEE 802.11b: 17.64 dBm
	IEEE 802.11g: 16.81 dBm
	IEEE 802.11n (HT20): 15.68 dBm
	IEEE 802.11n (HT40): 16.00 dBm

Wireless function S/W version: V 1.0

For consideration of the user, this device should be installed and operated with a minimum distance of 20 cm between the device and the body.

## ZigBee Module Specifications

Model	LZM-001
Frequency Range	2405 MHz - 2480 MHz
Output Power (Max.)	8.04 dBm

## Declaration of Conformity



Hereby, LG Electronics declares that the radio equipment type Washing Machine is in compliance with Directive 2014/53/EU. The full text of the EU declaration of conformity is available at the following internet address:

<http://www.lg.com/global/support/cedoc/cedoc#>  
 LG Electronics European Shared Service Centre B.V.  
 Krijgsman 1, 1186 DM Amstelveen, The Netherlands

## Standby Power Consumption

Standby power consumption	<b>0.5 W</b>
Network standby power consumption	<b>2.0 W</b>
The period of time after which the power management function, or a similar function, switches the equipment automatically into standby and/or off mode and/or the condition providing networked standby	<b>20 minutes</b>



**NOTE**

- The activation of the network connection may increase the power consumption of the appliance.



**Open Source Software Notice Information**

To obtain the source code under GPL, LGPL, MPL, and other open source licenses, that is contained in this product, please visit <http://opensource.lge.com>.

In addition to the source code, all referred license terms, warranty disclaimers and copyright notices are available for download.

LG Electronics will also provide open source code to you on CD-ROM for a charge covering the cost of performing such distribution (such as the cost of media, shipping, and handling) upon email request to [opensource@lge.com](mailto:opensource@lge.com). This offer is valid for a period of three years after our last shipment of this product. This offer is valid to anyone in receipt of this information.

**Smart Diagnosis**

This feature is only available on models with the  or  logo.

Use this feature to help you diagnose and solve problems with your appliance.

**NOTE**

- For reasons not attributable to LGE's negligence, the service may not operate due to external factors such as, but not limited to, Wi-Fi unavailability, Wi-Fi disconnection, local app store policy, or app unavailability.
- The feature may be subject to change without prior notice and may have a different form depending on where you are located.

**Using LG ThinQ to Diagnose Issues**

If you experience a problem with your Wi-Fi equipped appliance, it can transmit troubleshooting data to a smartphone using the **LG ThinQ** application.

- Launch the **LG ThinQ** application and select the **Smart Diagnosis** feature in the menu. Follow the instructions provided in the **LG ThinQ** application.

**Using Audible Diagnosis to Diagnose Issues**

Follow the instructions below to use the audible diagnosis method.

- Launch the **LG ThinQ** application and select the **Smart Diagnosis™** feature in the menu. Follow the instructions for audible diagnosis provided in the **LG ThinQ** application.

- 1 Press the **Power** button to turn on the appliance.
- 2 Swipe the display down to see the Settings screen and select **More Settings**. Select **Smart Diagnosis** from the Settings menu and press the **Start/Pause** button.
- 3 Hold the mouthpiece of your phone over the **Power** button. Hold the phone no more than one inch from (but not touching) the washer.
  - Keep the smartphone in place until the data transfer has finished. Time remaining for data transfer is displayed.

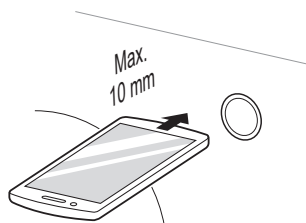

---

### NOTE

- Do not touch any other buttons or icons on the display screen.
- 

- 4** After the data transfer is complete, the diagnosis will be displayed in the application.

---

### NOTE

- For best results, do not move the smartphone while the tones are being transmitted.
-

# MAINTENANCE

## ⚠ WARNING

- Unplug the appliance before cleaning to avoid the risk of electric shock. Failure to follow this warning may result in serious injury, fire, electric shock, or death.
- Never use harsh chemicals, abrasive cleaners, or solvents to clean the appliance. They may damage the finish.

## Cleaning After Every Wash

### What to Clean

Always remove items from the washing machine as soon as the cycle is complete. Leaving damp items in the washing machine can cause wrinkling, colour transfer, and odour.

- After the wash cycle is finished, wipe the door and door seal to remove any moisture.
- Leave the door slightly open to dry the drum.
- Wipe the appliance with a dry cloth to remove any moisture.

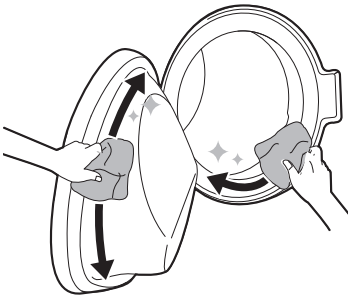

## ⚠ WARNING

- Leave the door open to dry inside of the appliance only if the children are supervised at home.

## Cleaning the Exterior

Proper care of your appliance can extend the service life.

### Exterior

- Immediately wipe off any spills.
- Wipe with a damp cloth and then again with a dry cloth ensuring there is no moisture in cabinet joints or crevices.
- Do not press on the surface or the display with sharp objects.

### Door

- Wash with a damp cloth on the outside and inside and then dry with a soft cloth.

## ⚠ WARNING

- Do not attempt to separate any panels or disassemble the appliance. Do not apply any sharp objects to the control panel in order to operate the appliance.

## Cleaning the Appliance Periodically & Performing an Emergency Water Evacuation

### Cleaning the Drum

This is a special function to help clean the inside of the appliance by soaking, washing, rinsing and spinning.

Run this function **once a month** (or more often if needed) to reduce build-up of detergent and softener and other residue.

- If there is a bad smell or mildew inside the appliance, run this function **once a week for 3 weeks** in addition to the regularly prompted intervals.

### NOTE

- The **Tub Clean** message will be displayed to alert to the recommendation of operating this function.

- 1 Remove any clothing or items from the appliance and close the door.
- 2 Open the door and place anti limescale powder directly into the drum.
- 3 Close the door and press the **Power** button.
- 4 Touch the **Tub Clean** from the **Download Cycles** and press the **Start/Pause** button to begin the programme.
- 5 Press the **Start/Pause** button to start.
- 6 Leave the door open to dry the inside of the appliance completely.
  - When the inside of the appliance is not dried completely, it may cause a bad smell or mildew.

### ⚠ WARNING

- Leave the door open to dry inside of the appliance only if the children are supervised at home.

### Cleaning the Water Inlet Filter

The water inlet filter collects lime or any sediment that may be in water that is supplied to the appliance. Clean the inlet filter every six months or so, or more often if the water is very hard or contains traces of limescale.

- Turn off the water supply taps to the appliance if the appliance is to be left for a certain period of time (e.g. holiday), especially if there is no floor drain (gully) in the immediate vicinity.
- !E error message will be displayed on the control panel when the water is not entering the detergent drawer.

- 1 Turn off the power and the water tap and then unscrew the water inlet hose.

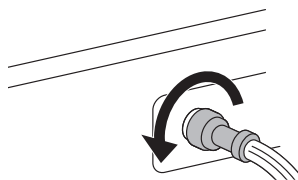

- 2 Remove the water inlet filter with small pliers and then clean the filter using a medium bristle tooth brush.

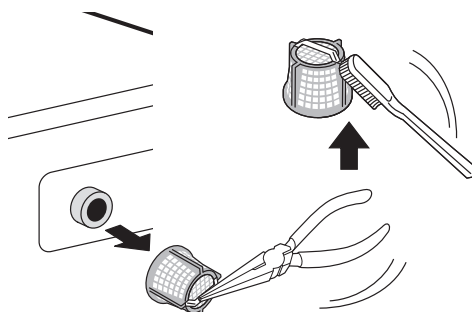

## Cleaning the Drain Pump Filter and Performing an Emergency Water Evacuation

The drain filter collects threads and small objects that may have been accidentally left in the clothes. Make sure that the filter is clean every six months to ensure smooth running of your appliance.

Allow the water to cool before cleaning the drain pump filter. Open the door in an emergency or perform an emergency water evacuation.

1 Unplug the appliance.

2 Press the **O** mark to open the lower cover.

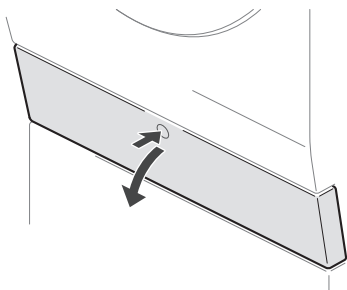

3 Remove the drain plug from the drain tube first **1**, and then drain the water. Then slowly unscrew the drain pump filter **2** to drain the remaining water and then proceed to remove any debris or objects from the filter.

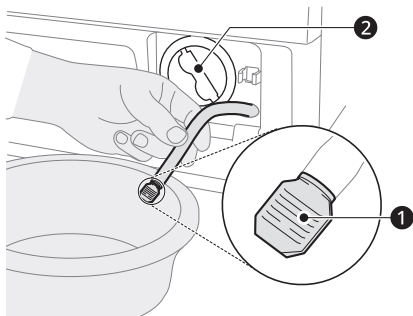

4 After cleaning the drain pump filter, carefully reinsert the filter and screw the drain cap back in clockwise carefully to avoid cross threading and leakage. Reinsert the plug back into the drain tube and place the tube into its holder.

5 Close the lower cover.

### ⚠ CAUTION

- Be careful when draining, as the water may be hot.
- Run the drum cleaning programme once a month (or more often, as needed) to remove excess detergent and other debris.

## Cleaning the Automatic Dispenser Tray

Remove and clean the automatic dispenser tray **every time** you refill the detergent/softener or change to a new type of detergent/softener.

Remove and clean the detergent dispenser drawer **once or twice a month**. Leaving detergent in the detergent dispenser drawer for an extended period or using the washer for a long time may cause the build-up of residue in the detergent dispenser drawer.

### ⚠ WARNING

- Do not spray water inside the washer. Doing so may cause fire or electric shock.

1 Turn off the washer, and unplug the power cord.

2 Press the circle to open the lower cover.

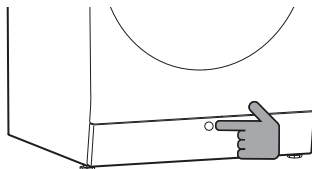

## 54 MAINTENANCE

---

- 3** Push in on the top of the automatic dispenser tray to slide it out and use the handle to remove the tray.

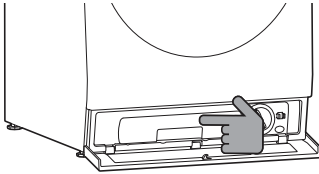

- 4** Turn the liquid detergent dispenser cap **1** and liquid softener dispenser cap **2** counterclockwise to remove them.

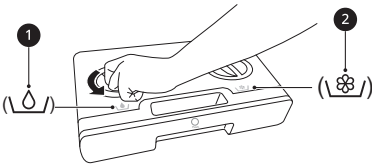

- 5** Turn the check valves **3** on the back of the tray counterclockwise to remove them.

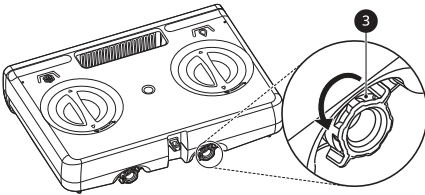

- 6** Clean the automatic dispenser tray and check valves with warm water.

- 7** Wipe off any moisture with a dry towel or cloth after cleaning.

- 8** Assemble the liquid detergent dispenser cap, liquid softener dispenser cap and check valves on the automatic dispenser tray and turn them clockwise until tight.

- 9** Insert the automatic dispenser tray until it clicks and close the lower cover.

# TROUBLESHOOTING

Operation of your appliance can lead to errors and malfunctions. The following tables contain possible causes and notes for resolving an error message or malfunction. It is recommended to read the tables carefully below in order to save your time and money that may cost for calling to LG Electronics service centre.

## Before Calling for Service

Your appliance is equipped with an automatic error-monitoring system to detect and diagnose problems at an early stage. If the appliance does not function properly or does not function at all, check the following tables before calling to LG Electronics service centre.

## Error Messages

Symptoms	Possible Cause & Solution
[IE] INLET ERROR	<b>Water supply faucets are not fully open.</b> <ul style="list-style-type: none"> <li>• Make sure that the water faucets are fully open.</li> </ul>
	<b>Water inlet hoses are kinked, pinched, or crushed.</b> <ul style="list-style-type: none"> <li>• Make sure that the hoses are not kinked, pinched or crushed behind or under the washer. Be careful when moving the washer during cleaning or maintenance.</li> </ul>
	<b>Water inlet filters are clogged.</b> <ul style="list-style-type: none"> <li>• Clean the inlet filters. See <b>MAINTENANCE</b>.</li> </ul>
	<b>Water supply pressure to faucet or house is too low.</b> <ul style="list-style-type: none"> <li>• Check another faucet in the house to make sure that household water pressure is adequate and flow is not restricted.</li> <li>• Disconnect the water inlet hoses from the washer and run a few gallons of water through the hoses to flush out any dirt.</li> <li>• If flow is too low, contact a plumber to have the water supply lines repaired.</li> </ul>
	<b>Water supply connected with leak-limiting hoses.</b> <ul style="list-style-type: none"> <li>• The use of hoses designed to limit leaks is not recommended. Leak limiting hoses can trip falsely and prevent the washer from filling.</li> </ul>

Symptoms	Possible Cause & Solution
[UE] UNBALANCE ERROR	<b>The automatic attempt to rebalance the load was not successful.</b> <ul style="list-style-type: none"> <li>The programme has been paused to allow the load to be manually adjusted. Manually redistribute the load.</li> </ul>
	<b>The load is too small.</b> <ul style="list-style-type: none"> <li>Add additional items to allow the washer to balance the load.</li> </ul>
	<b>Heavy articles are mixed with lighter items.</b> <ul style="list-style-type: none"> <li>Always try to wash articles of somewhat similar weight to allow the washer to evenly distribute the weight of the load for spinning.</li> </ul>
	<b>The load is out of balance.</b> <ul style="list-style-type: none"> <li>Manually redistribute the load if articles have become tangled, preventing the automatic rebalancing from working properly.</li> </ul>
[dE], [dE1], [dE2], [dE4] DOOR OPEN ERROR	<b>The door is not secured.</b> <ul style="list-style-type: none"> <li>Close and secure the door. If the message keeps appearing, unplug the power cord and call for service.</li> </ul>
[OE] WATER OUTLET ERROR	<b>Drain hose is kinked, pinched, or clogged.</b> <ul style="list-style-type: none"> <li>Make sure that the drain hose is free of clogs or kinks and is not pinched behind or under the washer.</li> </ul>
	<b>The end of the drain hose is more than 2.4 m above the bottom of the washer.</b> <ul style="list-style-type: none"> <li>Move the end of the drain hose so that it is lower than <b>2.4 m</b>.</li> </ul>
[tE] TEMPERATURE SENSOR ERROR	<b>Control error.</b> <ul style="list-style-type: none"> <li>Unplug the washer and wait 60 minutes. Reconnect power and try again.</li> <li>If the error code is still displayed, call for service</li> </ul>
[FE] OVERFLOW ERROR	<b>Water level is too high due to a faulty water valve.</b> <ul style="list-style-type: none"> <li>Close the water faucets, unplug the washer, and call for service.</li> </ul>
[PE] PRESSURE SENSOR ERROR	<b>The water level sensor is not working correctly.</b> <ul style="list-style-type: none"> <li>Close the water faucets, unplug the washer, and call for service.</li> </ul>
[LE], [LE1] MOTOR LOCKED ERROR	<b>A motor error has occurred.</b> <ul style="list-style-type: none"> <li>Allow the washer to stand for 30 minutes and then restart the programme.</li> <li>If the error code is still displayed, call for service.</li> </ul>
[LE2] COMPRESSOR ERROR	<b>Overload in compressor.</b> <ul style="list-style-type: none"> <li>Allow the washer to stand for 30 minutes and then restart the programme.</li> <li>If the error code is still displayed, call for service.</li> </ul>
[FF] FROZEN ERROR	<b>Inlet hose, drain hose or drain pump is frozen.</b> <ul style="list-style-type: none"> <li>See <b>Care in Cold Climates</b>.</li> </ul>



Symptoms	Possible Cause & Solution
<b>Child lock is activated.</b> <b>CHILD LOCK FUNCTION</b>	<b>The Child Lock function is on to prevent anyone from changing programmes or operating the washer.</b> <ul style="list-style-type: none"> <li>Turn off the <b>Child Lock</b> function in the control panel. See <b>Locking/Unlocking the Control Panel</b> under <b>Settings</b>.</li> </ul>
<b>Tub Clean</b> <b>TUB CLEAN ALARM</b>	<b>It is time to run the Tub Clean programme.</b> <ul style="list-style-type: none"> <li>This is not an error code. It indicates that the <b>Tub Clean</b> programme is running or needs to be run to clean the washer drum.</li> </ul>
[VS] <b>VIBRATION SENSOR ERROR</b>	<b>Vibration sensor malfunctions.</b> <ul style="list-style-type: none"> <li>Call for service.</li> </ul>
[dHE] <b>DRY ERROR</b>	<b>Dryer function not working (on washer/dryer combination models).</b> <ul style="list-style-type: none"> <li>Call for service.</li> </ul>

## Noises You Might Hear

Symptoms	Possible Cause & Solution
<b>Rattling and clanking noise</b>	<b>Foreign objects, such as keys, coins, or safety pins may be in the drum.</b> <ul style="list-style-type: none"> <li>Stop the appliance, check the drum for foreign objects. If the noise continues after the appliance is restarted, call for service.</li> </ul>
<b>Thumping sound</b>	<b>Heavy clothes may produce a thumping sound. This is usually normal.</b> <ul style="list-style-type: none"> <li>If the sound continues, the appliance is probably out of balance. Stop and redistribute the clothes.</li> </ul>
	<b>The clothes may be out of balance.</b> <ul style="list-style-type: none"> <li>Pause the programme and redistribute the clothes after the door unlocks.</li> </ul>
<b>Vibrating noise</b>	<b>Package materials are not removed.</b> <ul style="list-style-type: none"> <li>Remove package materials.</li> </ul>
	<b>The clothes may be unevenly distributed in the drum.</b> <ul style="list-style-type: none"> <li>Pause the programme and redistribute the clothes after the door unlocks.</li> </ul>
	<b>Not all levelling feet are resting firmly and evenly on the floor.</b> <ul style="list-style-type: none"> <li>See the <b>Levelling the Appliance</b> instruction to adjust the levelling of the appliance.</li> </ul>
	<b>Floor not rigid enough.</b> <ul style="list-style-type: none"> <li>Check if the floor is solid and does not flex. See the <b>Installation Place Requirements</b> to select the proper location.</li> </ul>

## Operation

Symptoms	Possible Cause & Solution
<b>Water is leaking.</b>	<b>House drain pipes are clogged.</b> <ul style="list-style-type: none"> <li>• Unclog waste pipes. Contact plumber if necessary.</li> </ul>
	<b>Leakage is caused by improper installation of drain hose or clogged drain hose.</b> <ul style="list-style-type: none"> <li>• Clean and straighten the drain hose. Check and clean the drain filter regularly.</li> </ul>
	<b>Drain pump filter cap is not fitted correctly.</b> <ul style="list-style-type: none"> <li>• Refit the drain pump filter.</li> </ul>
<b>A shortage alert appears even after you filled the dispensers for the detergent and softener.</b>	<b>Are all the feet resting firmly on the ground?</b> <ul style="list-style-type: none"> <li>• Make sure that all four feet are stable.</li> </ul>
	<b>Did you supplement the detergent and softener before you got the shortage notification?</b> <ul style="list-style-type: none"> <li>• When a washing programme is ended, the washing machine detects whether it is necessary to refill the detergent. Therefore, no alarm appears until the next refill alarm does.</li> </ul>
<b>Appliance does not operate.</b>	<b>Control panel has powered off due to inactivity.</b> <ul style="list-style-type: none"> <li>• This is normal. Press the <b>Power</b> button to turn the appliance on.</li> </ul>
	<b>Appliance is unplugged.</b> <ul style="list-style-type: none"> <li>• Make sure that the cord is plugged securely into a working outlet.</li> </ul>
	<b>Water supply is turned off.</b> <ul style="list-style-type: none"> <li>• Turn the water supply tap completely.</li> </ul>
	<b>Controls are not set properly.</b> <ul style="list-style-type: none"> <li>• Make sure that the programme is correctly set. Close the door and press the <b>Start/Pause</b> button.</li> </ul>
	<b>Door is open.</b> <ul style="list-style-type: none"> <li>• Close the door and make sure that nothing is caught under the door preventing it from closing completely.</li> </ul>
	<b>Circuit breaker/fuse is tripped/blown.</b> <ul style="list-style-type: none"> <li>• Check house circuit breakers/fuses. Replace fuses or reset breaker. The appliance should be on a dedicated branch circuit. The appliance will resume the programme where it stopped once power is restored.</li> </ul>

Symptoms	Possible Cause & Solution
<b>Appliance does not operate.</b>	<b>Control needs to be reset.</b> <ul style="list-style-type: none"> <li>Press the <b>Power</b> button, then reselect the desired programme and press the <b>Start/Pause</b> button.</li> </ul>
	<b>Start/Pause was not pressed after a programme was set.</b> <ul style="list-style-type: none"> <li>Press the <b>Power</b> button, then reselect the desired programme and press the <b>Start/Pause</b> button. The appliance is turned off if the <b>Start/Pause</b> button is not pressed within a certain time.</li> </ul>
	<b>Extremely low water pressure.</b> <ul style="list-style-type: none"> <li>Check another tap in the house to make sure that household water pressure is adequate.</li> </ul>
	<b>Appliance is heating the water or making steam.</b> <ul style="list-style-type: none"> <li>The drum may stop operating temporarily during certain cycles, while water is safely heated to a set temperature.</li> </ul>
<b>Buttons may not function properly.</b>	<b>The Child Lock option is activated.</b> <ul style="list-style-type: none"> <li>Deactivate the <b>Child Lock</b> option if necessary.</li> </ul>
<b>Door does not open.</b>	<b>The door cannot be opened for safety reasons once the appliance starts.</b> <ul style="list-style-type: none"> <li>This is normal. You can safely open the door after  turns off.</li> </ul>
<b>Appliance is not filling properly.</b>	<b>Inlet filter clogged.</b> <ul style="list-style-type: none"> <li>Make sure the inlet filters on the fill valves are not clogged.</li> </ul>
	<b>Inlet hoses may be kinked.</b> <ul style="list-style-type: none"> <li>Check that inlet hoses are not kinked or clogged.</li> </ul>
	<b>Insufficient water supply.</b> <ul style="list-style-type: none"> <li>Make sure that both hot and cold water taps are turned on all the way.</li> </ul>
	<b>Hot and cold supply hoses are reversed.</b> <ul style="list-style-type: none"> <li>Check supply hose connections.</li> </ul>
<b>Appliance does not drain water.</b>	<b>Kinked drain hose.</b> <ul style="list-style-type: none"> <li>Ensure that the drain hose is not kinked.</li> </ul>
	<b>Drain located higher than 1.2 m above the floor.</b> <ul style="list-style-type: none"> <li>Make sure that the drain hose is no higher than 1.2 m above the bottom of the appliance.</li> </ul>
<b>Detergent is not dispensed completely or not dispensed at all.</b>	<b>Too much detergent is used.</b> <ul style="list-style-type: none"> <li>Follow the guidelines provided by the detergent manufacturer.</li> </ul>
	<b>Drain Pump Filter may be blocked.</b> <ul style="list-style-type: none"> <li>Clean the Drain filter.</li> </ul>

Symptoms	Possible Cause & Solution
Cycle time is longer than usual.	<b>The load is too small.</b> <ul style="list-style-type: none"> <li>• Add more items to allow the appliance to balance the loads.</li> </ul>
	<b>Heavy articles are mixed with lighter items.</b> <ul style="list-style-type: none"> <li>• Always try to wash articles with similar weight in order to allow the appliance to evenly distribute the weight of the load for spinning.</li> </ul>
	<b>The load is out of balance.</b> <ul style="list-style-type: none"> <li>• Manually redistribute the load if articles have become tangled.</li> </ul>
Cycle end is delayed	<b>Unbalance is detected or suds removing programme is on.</b> <ul style="list-style-type: none"> <li>• This is normal. The time remaining shown on the display is only an estimated duration. Actual time may vary.</li> </ul>

## Performance

Symptoms	Possible Cause & Solution
Poor stain removal	<b>Previously set stains.</b> <ul style="list-style-type: none"> <li>• Articles that have been previously washed may have stains which have been set. These stains may be difficult to remove and may require hand washing or pre-treating to aid in stain removal.</li> </ul>
Staining	<b>Bleach or softener is dispensed too soon.</b> <ul style="list-style-type: none"> <li>• Dispenser compartment is overfilled. It makes bleach or softer dispensed rapidly. Always measure bleach or softener to prevent overfilling.</li> <li>• Close the detergent dispenser slowly.</li> </ul>
	<b>Bleach or softener was added directly to the clothes in the drum.</b> <ul style="list-style-type: none"> <li>• Always use the detergent dispenser to ensure that bleach or softener is properly dispensed at the right time in the programme.</li> </ul>
	<b>Clothes were not properly sorted.</b> <ul style="list-style-type: none"> <li>• Always wash dark colours separately from light colours and whites to prevent discoloration.</li> <li>• Never wash heavily soiled items with lightly soiled items.</li> </ul>

Symptoms	Possible Cause & Solution
<b>Wrinkling</b>	<b>Appliance is not unloaded promptly.</b> <ul style="list-style-type: none"> <li>Always remove items from the appliance as soon as the programme is complete.</li> </ul>
	<b>Appliance is overloaded.</b> <ul style="list-style-type: none"> <li>The appliance can be fully loaded, but the drum should not be tightly packed with items. The door of the appliance should be closed easily.</li> </ul>
	<b>Hot and cold water supply hoses are reversed.</b> <ul style="list-style-type: none"> <li>Hot water rinse can set wrinkles in garments. Check the supply hose connections.</li> </ul>
	<b>Spin speed may be too high.</b> <ul style="list-style-type: none"> <li>Set the spin speed to suit the garment type.</li> </ul>

## Odour

Symptoms	Possible Cause & Solution
<b>Musty or mildewy odour in appliance</b>	<b>Inside of drum is not cleaned properly.</b> <ul style="list-style-type: none"> <li>Run the <b>Tub Clean</b> function regularly.</li> </ul>
	<b>Odours can occur if the drain hose is not properly installed, causing siphoning (water flowing back inside of the appliance).</b> <ul style="list-style-type: none"> <li>When installing the drain hose, make sure that it does not get kinked or blocked.</li> </ul>
	<b>If the detergent dispenser is not cleaned regularly, odours can occur from mold or foreign substances.</b> <ul style="list-style-type: none"> <li>Remove and clean the detergent dispenser, especially the top and bottom of the dispenser's opening.</li> </ul>

## Drying

Symptoms	Possible Cause & Solution
<b>Dry problem</b>	<b>Check water supply tap.</b> <ul style="list-style-type: none"> <li>Do not overload. Check that the washing machine is draining properly to extract adequate water from the load. When load of laundry is too small to tumble properly. Add a few towels.</li> <li>Turn off water supply tap.</li> </ul>
<b>Drying time is too long.</b>	<b>The ambient temperature is low.</b> <ul style="list-style-type: none"> <li>Make sure the temperature is allowable range.</li> </ul>

Symptoms	Possible Cause & Solution
<b>Drying performance is too low or bad.</b>	<b>Water is not properly supplied. The water is used for auto-cleaning of lint-filter on drum during the drying.</b> <ul style="list-style-type: none"> <li>• Make sure the water supply tap is open.</li> </ul>
	<b>Water does not properly drain.</b> <ul style="list-style-type: none"> <li>• Make sure the drain filter is not clogged.</li> </ul>
	<b>The appliance is overloaded.</b> <ul style="list-style-type: none"> <li>• Check the load capacity for the selected programme. If necessary, add a time dry programme.</li> </ul>
	<b>The spin speed is too low.</b> <ul style="list-style-type: none"> <li>• Select the highest spin speed allowed for the wash programme.</li> </ul>
<b>A warm air comes out from the rear side of the appliance.</b>	<b>This appliance makes a warm air to dry the clothes.</b> <ul style="list-style-type: none"> <li>• This warm air dries the clothes and comes out from the rear side of the appliance.</li> </ul>

## Customer Care and Service

Contact an LG Electronics customer information centre.

- To find an LG Electronics authorised service personnel, visit our website at [www.lg.com](http://www.lg.com) and follow the instructions found there.
- Self-repair is not recommended as it could further damage the device and void the guarantee.
- Spare parts referenced in Regulation 2019/2023 are available for a minimum duration of 10 years.

