



# Operation Guide

**ECOSYS MA6000ifx    ECOSYS MA5500ifx**  
**ECOSYS MA4500ifx    ECOSYS MA4500ix**



# Preface

Thank you for purchasing this machine.

This Operation Guide is intended to help you operate the machine correctly, perform routine maintenance, and take simple troubleshooting measures as needed so that the machine can always be used in the optimum condition.

Please read this Operation Guide before using the machine.

**To maintain quality, we recommend using genuine Kyocera toner containers, which must pass numerous quality inspections.**

The use of non-genuine toner containers may cause failure.

We will not be liable for any damages caused by the use of third party supplies in this machine.

A label is affixed to our replacement genuine toner containers, as shown below.

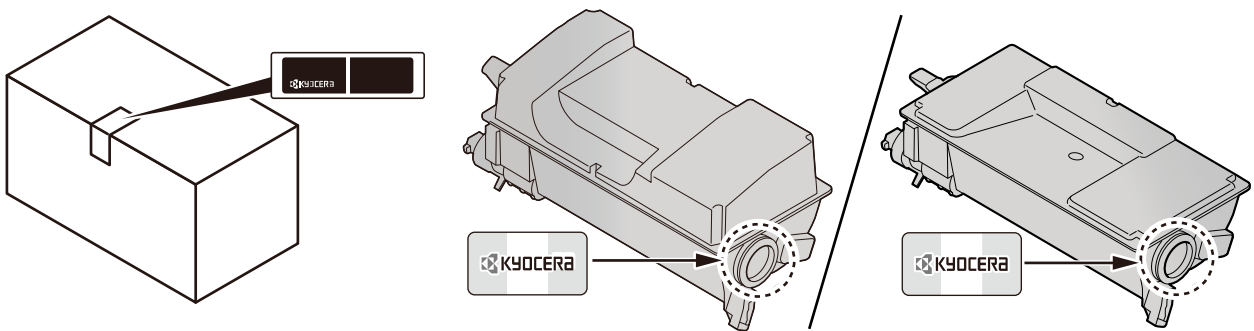

## Checking the Equipment's Serial Number

The equipment's serial number is printed in the location shown in the figure.

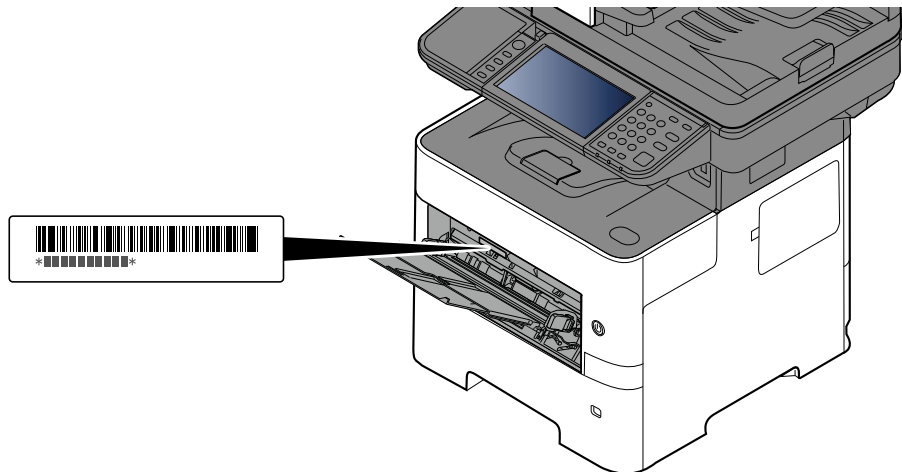

You'll need the equipment's serial number when contacting your Service Representative. Please check the number before contacting your Service Representative.

# Contents

<b>Preface</b> .....	<b>i</b>
<b>Contents</b> .....	<b>ii</b>
<b>Machine Features</b> .....	<b>x</b>
Optimize your office workflow .....	x
Save energy and cost .....	xi
Create attractive documents .....	xii
Strengthen security .....	xiii
<b>Color and Image Quality Functions</b> .....	<b>xvii</b>
Basic Color Modes .....	xvii
Adjusting Image Quality and Color .....	xviii
<b>Guides Provided with the Machine</b> .....	<b>xix</b>
<b>About the Operation Guide (this Guide)</b> .....	<b>xx</b>
Structure of the guide .....	xx
Conventions Used in This Guide .....	xxi
<b>Menu Map</b> .....	<b>xxiv</b>

## **1 Legal and Safety Information ..... 1-1**

<b>Notice</b> .....	<b>1-2</b>
Safety Conventions in This Guide .....	1-2
Environment .....	1-3
Precautions for Use .....	1-4
Laser Safety (Europe) .....	1-5
SAFETY OF LASER BEAM (USA) .....	1-6
Safety Instructions Regarding the Disconnection of Power .....	1-7
Compliance and Conformity .....	1-7
Radio Tag Technology .....	1-9
Other precautions (for users in California, the United States) .....	1-9
Legal Restriction on Copying/Scanning .....	1-9
EN ISO 7779 .....	1-9
EK1-ITB 2000 .....	1-9
Wireless Connection (Mexico only) .....	1-9
Security Precautions when Using Wireless LAN (If equipped) .....	1-9
Limited Use of This Product (If equipped) .....	1-10
Legal Information .....	1-11
Energy Saving Control Function .....	1-13
Automatic 2-Sided Print Function .....	1-13
Resource Saving - Paper .....	1-13
Environmental benefits of "Power Management" .....	1-13
Energy Star (ENERGY STAR®) Program .....	1-13
Warranty (the United States and Canada) .....	1-14

## **2 Installing and Setting up the Machine ..... 2-1**

<b>Part Names</b> .....	<b>2-2</b>
Machine Exterior .....	2-2
Connectors/Interior .....	2-4
With Optional Equipments Attached .....	2-7
<b>Connecting the Machine and Other Devices</b> .....	<b>2-8</b>
<b>Connecting Cables</b> .....	<b>2-9</b>
Connecting LAN Cable .....	2-9
Connecting USB Cable .....	2-10
Connecting the Power Cable .....	2-10
<b>Power On/Off</b> .....	<b>2-11</b>
Power On .....	2-11
Power Off .....	2-11
<b>Using the Operation Panel</b> .....	<b>2-12</b>
Operation Panel Keys .....	2-12

Adjusting the Operation Panel Angle .....	2-13
<b>Touch Panel .....</b>	<b>2-14</b>
Using the Touch Panel .....	2-14
Home Screen .....	2-17
Assigning Functions to Function Keys .....	2-22
Display for Device Information .....	2-23
Display Setting Screen .....	2-24
Display of Keys That Cannot Be Set .....	2-26
Original Preview .....	2-27
Entering Numbers .....	2-29
Help Screen .....	2-31
Accessibility Functions (Magnifying the View) .....	2-32
<b>Login/Logout .....</b>	<b>2-33</b>
Login .....	2-33
Simple Login .....	2-34
Logout .....	2-34
<b>Default Settings of the Machine .....</b>	<b>2-35</b>
Setting Date and Time .....	2-35
<b>Network Setup .....</b>	<b>2-36</b>
Configuring the Wired Network .....	2-36
Configuring the Wireless Network .....	2-38
Setting Wi-Fi Direct .....	2-44
<b>Energy Saver function .....</b>	<b>2-46</b>
Low Power Mode .....	2-46
Sleep .....	2-46
Sleep Rules (models for Europe) .....	2-47
Sleep Level (Energy Saver and Quick Recovery) (models except for Europe) ....	2-47
Energy Saver Recovery Level .....	2-48
Weekly Timer Settings .....	2-48
Power Off Timer (models for Europe) .....	2-48
<b>Quick Setup Wizard .....</b>	<b>2-49</b>
Configuring Settings Quick Setup Wizard .....	2-51
<b>Installing Software .....</b>	<b>2-52</b>
Published Software (Windows) .....	2-52
Installing Software in Windows .....	2-53
Uninstalling the Software .....	2-59
Installing Software in Mac Computer .....	2-60
Setting TWAIN Driver .....	2-64
Setting WIA Driver .....	2-66
<b>Checking the Counter .....</b>	<b>2-67</b>
<b>Additional Preparations for the Administrator .....</b>	<b>2-68</b>
Administrator Privileges Overview .....	2-68
Log in as Machine Administrator or Administrator .....	2-68
Strengthening the Security .....	2-69
<b>Command Center RX .....</b>	<b>2-71</b>
Accessing Command Center RX .....	2-72
Changing Security Settings .....	2-73
Changing Device Information .....	2-74
E-mail Settings .....	2-75
Registering Destinations .....	2-78
Creating a New Custom Box .....	2-79
Printing a document stored in a Custom Box .....	2-80
<b>Transferring Data from Our Other Products .....</b>	<b>2-81</b>
Migrating the Address Book .....	2-81

### **3 Preparation before Use ..... 3-1**

<b>Loading Paper .....</b>	<b>3-2</b>
Precaution for Loading Paper .....	3-3
Loading in the Cassettes .....	3-4

Loading Statement in the Cassettes (ECOSYS MA6000ifx/ECOSYS MA5500ifx for inch models) .....	3-8
Loading Paper in the Multi Purpose Tray .....	3-11
Specifying Paper Size and Media Type .....	3-15
<b>Paper Stopper .....</b>	<b>3-16</b>
<b>Preparation for Sending a Document to a Shared Folder in a PC .....</b>	<b>3-17</b>
Making a note of the computer name and full computer name .....	3-17
Making a note of the user name and domain name .....	3-18
Creating a Shared Folder, Making a Note of a Shared Folder .....	3-19
Configuring Windows Firewall .....	3-23
Scan to Folder Setup Tool for SMB .....	3-28
<b>Registering Destinations in the Address Book .....</b>	<b>3-33</b>
Adding a Destination (Address Book) .....	3-33
Adding a Destination on One Touch Key (One Touch Key) .....	3-41

## **4      Printing from PC .....**      **4-1**

<b>Printer Driver Print Settings Screen .....</b>	<b>4-2</b>
Printer Driver Help .....	4-3
Changing the Default Printer Driver Settings (Windows 10) .....	4-3
<b>Printing from PC .....</b>	<b>4-4</b>
<b>Printing on Standard Sized Paper .....</b>	<b>4-5</b>
Printing on Non-standard Sized Paper .....	4-7
Printing with Universal Print .....	4-10
Banner printing .....	4-13
Canceling Printing from a Computer .....	4-17
<b>Printing from the Handheld Device .....</b>	<b>4-18</b>
Printing by AirPrint .....	4-18
Printing by Mopria .....	4-18
Printing with Wi-Fi Direct .....	4-18
<b>Printing Data Saved on the Printer .....</b>	<b>4-19</b>
Specifying the Job Box from a Computer and Storing the Job .....	4-19
Printing Documents from Private Print Box .....	4-20
Deleting the Documents Stored in the Private Print Box .....	4-21
Printing Document from Stored Job Box .....	4-22
Deleting the Documents Stored in the Stored Job Box .....	4-23
Printing Document from Quick Copy Box .....	4-24
Deleting the Documents Stored in the Quick Copy Box .....	4-25
Printing Document from Proof and Hold Box .....	4-26
Deleting the Documents Stored in the Proof and Hold Box .....	4-27
Printing Documents from PIN Print Box .....	4-28
Deleting the Documents Stored in the PIN Print Box .....	4-28
Printing Document from the Universal Print box .....	4-29
Deleting the Documents Stored in the Universal Print Box .....	4-30
<b>Monitoring the Printer Status (Status Monitor) .....</b>	<b>4-31</b>
Accessing the Status Monitor .....	4-31
Exiting the Status Monitor .....	4-31
Quick View State .....	4-31

## **5      Operation on the Machine .....**      **5-1**

<b>Loading Originals .....</b>	<b>5-2</b>
Placing Originals on the Platen .....	5-2
Original Specifications available in the Document Processor .....	5-4
<b>Favorites .....</b>	<b>5-7</b>
Registering Favorites .....	5-8
Recalling Favorites .....	5-8
Editing Favorites .....	5-9
Deleting Favorites .....	5-9

<b>Application</b> .....	<b>5-10</b>
Installing Applications .....	5-10
Activating Applications .....	5-11
Deactivating Applications .....	5-12
Uninstalling Applications .....	5-12
<b>Registering Shortcuts</b> .....	<b>5-13</b>
Adding Shortcuts .....	5-13
Editing Shortcuts .....	5-14
Deleting Shortcuts .....	5-14
<b>Copying</b> .....	<b>5-15</b>
Basic Operation .....	5-15
Canceling Jobs .....	5-16
<b>Basic Scanning (Sending)</b> .....	<b>5-17</b>
<b>Sending Document via E-mail</b> .....	<b>5-18</b>
<b>Sending Document to Desired Shared Folder on a Computer (Scan to PC)</b> .....	<b>5-20</b>
<b>Sending Document to Folder on an FTP Server (Scan to FTP)</b> .....	<b>5-23</b>
<b>Scanning using TWAIN or WIA</b> .....	<b>5-25</b>
<b>Scanning Document stored in a Custom Box</b> .....	<b>5-26</b>
<b>Useful Sending Method</b> .....	<b>5-27</b>
<b>WSD Scan</b> .....	<b>5-28</b>
Install the Driver (for Windows 10) .....	5-28
Install the Driver (for Windows 8.1, Microsoft Windows Server 2012) .....	5-28
Executing WSD scan .....	5-29
<b>Scanning with File Management Utility</b> .....	<b>5-30</b>
Sending to Different Types of Destinations (Multi Sending) .....	5-31
<b>Sending Documents to E-mail Address of Logged in User (to myself)</b> .....	<b>5-32</b>
<b>Using a Fax Server to Send (Fax Server Send)</b> .....	<b>5-33</b>
<b>Canceling Sending Jobs</b> .....	<b>5-35</b>
<b>Handling Destination</b> .....	<b>5-36</b>
Specifying Destination .....	5-36
Choosing from the Address Book .....	5-36
Choosing from the One Touch Key .....	5-38
Choosing from the Search (No.) .....	5-38
Checking and Editing Destinations .....	5-39
Confirmation Screen of Destinations .....	5-40
Recall .....	5-41
<b>How to use the FAX Function</b> .....	<b>5-42</b>
<b>Using Document Boxes</b> .....	<b>5-43</b>
What is Custom Box? .....	5-43
What is Job Box? .....	5-44
What is USB Drive Box? .....	5-44
Fax Box .....	5-44
Basic Operation for Document Box .....	5-44
Creating a New Custom Box .....	5-50
Editing Custom Box .....	5-51
Deleting Custom Box .....	5-52
Storing Documents to a Custom Box .....	5-52
Printing Documents in Custom Box .....	5-53
Saving Scanned Documents to a Custom Box .....	5-54
Sending Documents in Custom Box .....	5-55
Sending Documents in Custom Box to E-mail Address of Logged in User .....	5-56
Moving Documents in Custom Box .....	5-56
Copying Documents in Custom Box into Other Boxes .....	5-57
Copying Documents in Custom Box to USB Drive .....	5-57
Joining Documents in Custom Box .....	5-58
Deleting Documents in Custom Box .....	5-59
Operating using Removable USB Drive .....	5-60
Printing Documents Stored in Removable USB Drive .....	5-60
Saving Documents to USB Drive (Scan to USB) .....	5-62
Check the USB Drive Information .....	5-63

Removing USB Drive .....	5-63
<b>Using the Manual Stapler</b>	
<b>(ECOSYS MA6000ifx/ECOSYS MA5500ifx only) .....</b>	<b>5-64</b>

## **6 Using Various Functions ..... 6-1**

<b>About Functions Available on the Machine .....</b>	<b>6-2</b>
Copy .....	6-2
Send .....	6-4
Custom Box (Store File) .....	6-7
Custom Box (Print) .....	6-9
Custom Box (Send) .....	6-10
USB Drive (Store File) .....	6-11
USB Drive (Printing Documents) .....	6-13
<b>Functions .....</b>	<b>6-14</b>
Original Size .....	6-14
Paper Selection .....	6-15
Mixed Size Originals .....	6-16
Original Orientation .....	6-18
Collate .....	6-19
ID Card Copy .....	6-19
Zoom .....	6-19
Combine .....	6-21
Border Erase, Border Erase/Full Scan .....	6-23
Duplex .....	6-25
Density .....	6-27
Original Image .....	6-28
EcoPrint .....	6-29
Color Selection .....	6-29
Sharpness .....	6-30
Background Density Adj. (Background Density Adjustment) .....	6-30
Prevent Bleed-thru .....	6-31
Contrast .....	6-31
Erase Colors .....	6-32
Continuous Scan .....	6-32
Job Finish Notice .....	6-33
File Name Entry .....	6-33
Priority Override .....	6-34
Detect Multi-fed Originals .....	6-34
Detect Bent Corner Originals .....	6-34
Skip Blank Page .....	6-35
Quiet Mode .....	6-35
2-sided .....	6-35
Sending Size .....	6-36
Long Original .....	6-37
File Format .....	6-37
File Separation .....	6-44
Scan Resolution .....	6-44
Clarify Text (Noise Removal) .....	6-45
Email Subject/Body .....	6-45
FTP Encrypted TX .....	6-45
Email Encrypted TX .....	6-46
Digital Signature Email .....	6-46
Delete after Printed .....	6-47
Delete after Transmitted .....	6-47
Storing Size .....	6-48
Encrypted PDF Password .....	6-48
JPEG/TIFF Print .....	6-49
XPS Fit to Page .....	6-49

<b>7</b>	<b>Status/Job Cancel .....</b>	<b>7-1</b>
	<b>Checking Job Status .....</b>	<b>7-2</b>
	Details of the Status Screens .....	7-3
	Checking Detailed Information of Jobs .....	7-8
	<b>Checking Job History .....</b>	<b>7-9</b>
	Checking the Detailed Information of Histories .....	7-10
	Sending the Log History .....	7-10
	<b>Job Operation .....</b>	<b>7-11</b>
	Pause and Resumption of Jobs .....	7-11
	Canceling of Jobs .....	7-11
	<b>Device Information .....</b>	<b>7-12</b>
	<b>Check the remaining amount of toner and paper, and the condition of the unit .....</b>	<b>7-14</b>
<b>8</b>	<b>Setup and Registration (System Menu) .....</b>	<b>8-1</b>
	<b>System Menu .....</b>	<b>8-2</b>
	Operation Method .....	8-2
	System Menu Settings .....	8-4
	Device Settings .....	8-7
	Notification/Report .....	8-21
	Function Settings .....	8-25
	Network Settings .....	8-39
	Security Settings .....	8-55
	Job Accounting/Authentication .....	8-61
	Add/Delete Application .....	8-61
	Adjustment/Maintenance .....	8-62
<b>9</b>	<b>User Authentication and Accounting (User Login, Job Accounting) ..</b>	<b>9-1</b>
	<b>Overview of User Login Administration .....</b>	<b>9-2</b>
	<b>Enabling User Login Administration .....</b>	<b>9-3</b>
	<b>Setting User Login Administration .....</b>	<b>9-4</b>
	Authentication Security .....	9-4
	Adding a User (Local User List) .....	9-6
	Changing User Properties .....	9-9
	Delete a user .....	9-10
	User Login Administration for Printing .....	9-11
	To Manage the Users to Scan Using TWAIN .....	9-13
	To Manage the Users to Scan Using WIA .....	9-14
	To Manage the Users that Send Faxes from a PC .....	9-15
	Local Authorization .....	9-16
	Server Settings .....	9-17
	Configuring Network User Privileges .....	9-18
	Group Authorization Settings .....	9-19
	Guest Authorization Set. ....	9-21
	Obtain NW User Property .....	9-24
	Simple Login Settings .....	9-26
	ID Card Settings .....	9-29
	PIN Code Authorization .....	9-31
	<b>Using User Login Administration .....</b>	<b>9-32</b>
	Login/Logout .....	9-32
	<b>Overview of Job Accounting .....</b>	<b>9-33</b>
	<b>Enabling Job Accounting .....</b>	<b>9-35</b>
	<b>Job Accounting (Local) .....</b>	<b>9-36</b>
	Adding an Account .....	9-36
	Restricting the Use of the Machine .....	9-37
	Editing an Account .....	9-38



	Deleting an Account .....	9-39
	Job Accounting for Printing .....	9-40
	Job Accounting for Scan Using TWAIN .....	9-41
	Job Accounting for Scan Using WIA .....	9-42
	Job Accounting for the FAX Transmitted from a Computer .....	9-43
	<b>Configuring Job Accounting .....</b>	<b>9-44</b>
	Default Counter Limit .....	9-44
	Counting the Number of Pages Printed .....	9-45
	Print Accounting Report .....	9-47
	<b>Using Job Accounting .....</b>	<b>9-48</b>
	Login/Logout .....	9-48
	Apply Limit .....	9-49
	Copier/Printer Count .....	9-50
	<b>Unknown User Settings .....</b>	<b>9-51</b>
	Unknown ID Job .....	9-51
	Registering Information for a User whose ID is Unknown .....	9-52
<b>10</b>	<b>Troubleshooting .....</b>	<b>10-1</b>
	<b>Regular Maintenance .....</b>	<b>10-2</b>
	Cleaning .....	10-2
	Replacing the Toner Container .....	10-6
	Replacing the Waste Toner Box .....	10-11
	Replacing Staples (ECOSYS MA6000ifx/ECOSYS MA5500ifx only) .....	10-13
	<b>Troubleshooting .....</b>	<b>10-14</b>
	Solving Malfunctions .....	10-14
	Machine Operation Trouble .....	10-14
	Printed Image Trouble .....	10-19
	Remote Operation .....	10-21
	Responding to Messages .....	10-23
	<b>Adjustment/Maintenance .....</b>	<b>10-40</b>
	Overview of Adjustment/Maintenance .....	10-40
	Drum Refresh .....	10-40
	Drum Refresh 2 .....	10-41
	<b>Clearing Paper Jams .....</b>	<b>10-42</b>
	Remove any jammed paper in the Multipurpose Tray .....	10-44
	Remove any jammed paper in Cassette 1 - Cassette 5 .....	10-45
	Remove any jammed paper in Duplex Unit .....	10-46
	Remove any jammed paper Inside the Machine .....	10-47
	Remove any jammed paper in Inner Tray / Inside Rear Cover .....	10-49
	Remove any jammed paper in Document Processor .....	10-51
	Clearing a Staple Jam (ECOSYS MA6000ifx/ECOSYS MA5500ifx only) .....	10-54
<b>11</b>	<b>Appendix .....</b>	<b>11-1</b>
	<b>Optional Equipment .....</b>	<b>11-2</b>
	Overview of Optional Equipment .....	11-2
	Optional Applications .....	11-8
	<b>Character Entry Method .....</b>	<b>11-10</b>
	Entry Screens .....	11-10
	Entering Characters .....	11-12
	<b>Paper .....</b>	<b>11-13</b>
	Basic Paper Specifications .....	11-13
	Choosing the Appropriate Paper .....	11-14
	Special Paper .....	11-17
	<b>Specifications .....</b>	<b>11-21</b>
	Machine .....	11-21
	Copy Functions .....	11-23

Printer Functions .....	11-24
Scanner Functions .....	11-25
Document Processor .....	11-26
Paper Feeder (500-sheet) (Option) .....	11-26
Manual Stapler (ECOSYS MA6000ifx/ECOSYS MA5500ifx only) .....	11-27
<b>Back up Data .....</b>	<b>11-28</b>
Data backup using KYOCERA Net Viewer .....	11-28
Data backup using Command Center RX .....	11-28
Back up Data Using USB Drive .....	11-29
<b>Functions List of Security Quick Setup .....</b>	<b>11-30</b>
TLS .....	11-30
Settings for Server Function .....	11-30
Settings for Client Function .....	11-31
IPv4 Settings (Wired Network) .....	11-31
IPv4 Settings (Wireless Network) .....	11-31
IPv6 Settings (Wired Network) .....	11-32
IPv6 Settings (Wireless Network) .....	11-33
Transmission protocol: FTP Client (Transmission) .....	11-33
Other Protocols: HTTP (Client) .....	11-33
Other Protocols: SOAP .....	11-34
Other Protocols: LDAP .....	11-34
Transmission Protocols: SMTP (Sending Emails) .....	11-34
Email: POP3 User Settings .....	11-35
Print protocols .....	11-35
Transmission Protocol .....	11-36
Other Protocols .....	11-37
TCP/IP: Bonjour Settings .....	11-38
Network Settings .....	11-38
Connectivity .....	11-38
Interface Block Setting .....	11-39
Energy Saver/Timer .....	11-39
Authentication Security Settings .....	11-39
Job Status/Job History Settings .....	11-39
Edit Restriction .....	11-40
Prevent Mis-sending Settings .....	11-40
History Settings .....	11-41
<b>Glossary .....</b>	<b>11-42</b>
<b>Index .....</b>	<b>Index-1</b>

# Machine Features

The machine is equipped with many useful functions.

➔ [Using Various Functions \(page 6-1\)](#)

Here are some examples.

## Optimize your office workflow

### Access to frequently used functions with just one touch (Favorites)

You can preset frequently used functions.

Once you register frequently used settings as favorite, you can call up the settings easily. Using this favorite brings the same results even if operated by another person.

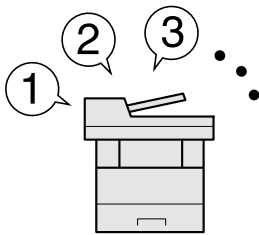

➔ [Favorites \(page 5-7\)](#)

### Scan originals of different sizes at a time (Mixed Size Originals)

It is useful when preparing conference materials.

You can set the different sized originals at one time so you don't need to reset the originals regardless of size.

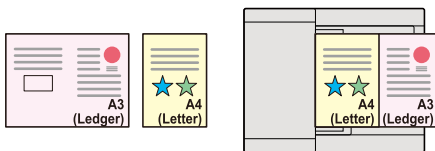

➔ [Mixed Size Originals \(page 6-16\)](#)

### Scan a large number of originals in separate batches and produce as one job (Continuous Scan)

It is useful when preparing many-page handouts.

When a large number of originals cannot be placed in the document processor at one time, the originals can be scanned in separate batches and then copied or sent as one job.

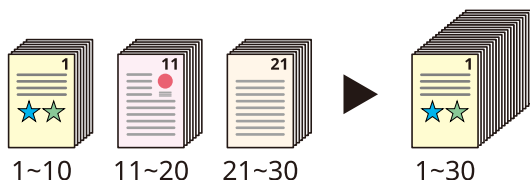

➔ [Continuous Scan \(page 6-32\)](#)

## Send one time with multiple sending options (Multi Sending)

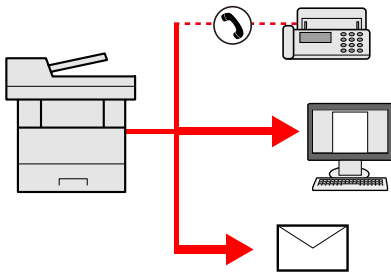

You can send a same document to the multiple destinations using a different method.  
You can specify multiple destinations of different send methods such as E-mail, SMB, and Fax.  
You can reduce your workflow by sending a job at once.

➔ [Sending to Different Types of Destinations \(Multi Sending\) \(page 5-31\)](#)

## Save frequently used documents in the machine (Custom Box)

You can save the frequently used document in the machine and print it when needed.

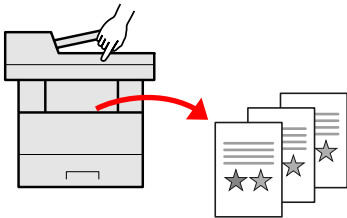

➔ [Creating a New Custom Box on page 5-50](#)

## Save energy and cost

### Save energy as needed (Energy Saver function)

The machine is equipped with Energy Saver function that automatically switched into Low Power Mode or Sleep Mode. You can set appropriate Energy Saver Recovery Level depending on the operation.  
In addition, the machine can automatically be switched into Sleep and recovered at a specified time for each day of the week.

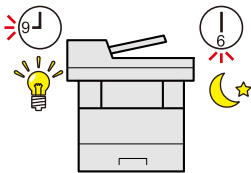

➔ [Energy Saver function \(page 2-46\)](#)

## Use less toner for printing (EcoPrint)

You can save toner consumption with this function.

When you only need to check the printed content, such as a trial print run or documents for internal confirmation, use this function to save toner.

Use this function when a high-quality print is not required.

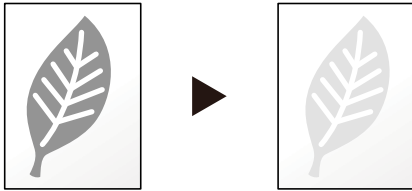

➔ [EcoPrint \(page 6-29\)](#)

## Reduce paper use (Paper Saving Printing)

You can print originals on both sides of the paper. You can also print multiple originals onto one sheet.

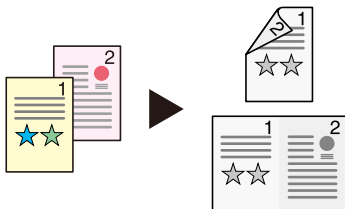

➔ [Favorites \(page 5-7\)](#)

➔ [2-sided \(page 6-35\)](#)

## Skip blank pages when printing (Skip Blank Page)

When there are blank pages in a scanned document, this function skips the blank pages and prints only pages that are not blank.

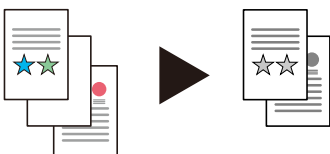

➔ [Skip Blank Page on page 6-35](#)

## Create attractive documents

### Prevent image bleed-through (Prevent Bleed-through)

You can prevent image bleed-through from the reverse side when scanning thin originals.

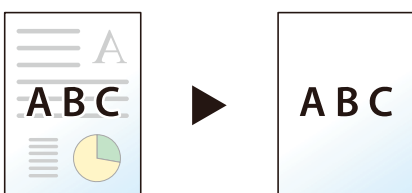

➔ [Prevent Bleed-thru \(page 6-31\)](#)

## Strengthen security

### Password-protect a PDF file (PDF Encryption Functions)

Use the PDF format's password security options to restrict document viewing, printing and editing.

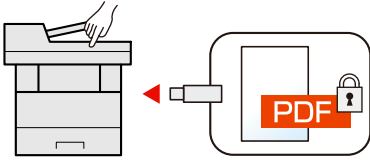

➔ [Encrypted PDF Password \(page 6-48\)](#)

### Protect data on the SSD (Encryption / Overwrite)

You can overwrite the unnecessary data that remains on the SSD automatically.

To prevent an external leakage, the machine is able to encrypt data before writing it to the SSD.

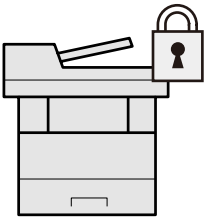

➔ [Data Security \(page 8-58\)](#)

### Prevent loss of finished documents (Private Print)

You can temporarily save a printer document in the machine. By printing the document from the machine prevents someone takes your document.

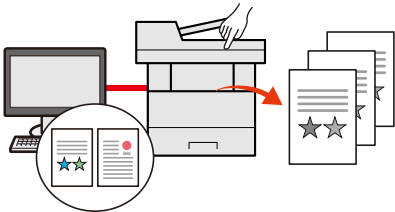

➔ [Printing Data Saved on the Printer \(page 4-19\)](#)

### Log in by ID card (Card Authentication)

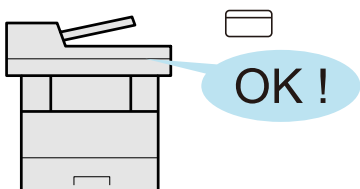

You can log in simply by touching an ID card. You don't need to enter your user name and password.

➔ [Card reader \(page 11-7\)](#)

## Strengthen security (Settings for Administrator)

Various functions are available for administrators to strengthen security.

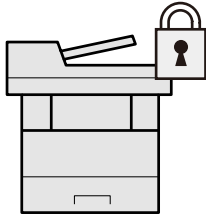

➔ [Strengthening the Security \(page 2-69\)](#)

## Prevent the execution of malware (Allowlisting)

Prevent malware from running and prevent software tampering and maintain system reliability.

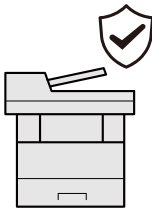

➔ [Allowlisting on page 8-58](#)

## Make the machine quiet (Quiet Mode)

You can make the machine quiet by reducing its running noise. You can configure this mode by job.

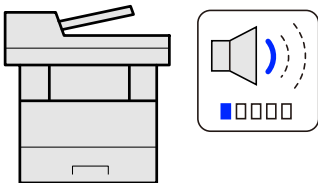

➔ [Quiet Mode on page 6-35](#)

## Expand functions as necessary (Application)

The functionality of the machine can be expanded by installing applications.

Applications that help you perform your daily more efficiently such as a scan feature and an authentication feature are available.

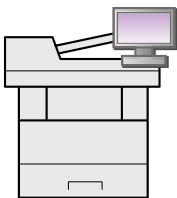

➔ [Application \(page 5-10\)](#)

## Install the machine without concerning the network cables (Wireless Network)

In an environment where the wireless LAN is used, you can install the machine without concerning the network cables. In addition, Wi-Fi Direct, etc. are supported.

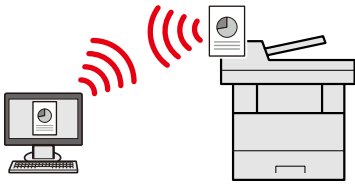

➔ [Configuring the Wireless Network \(page 2-38\)](#)

➔ [Setting Wi-Fi Direct \(page 2-44\)](#)

## Use USB drive (USB Drive)

It is useful when you need to print documents outside your office or you cannot print documents from your PC. You can print the document from the USB drive by plugging it directly into the machine. Original scanned at the machine can be saved in the USB drive also.

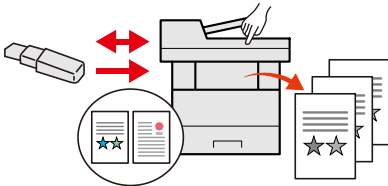

➔ [Printing Documents Stored in Removable USB Drive \(page 5-60\)](#)

➔ [Saving Documents to USB Drive \(Scan to USB\) \(page 5-62\)](#)

## Specify image file format (File Format)

You can select the various file formats when sending/storing images.

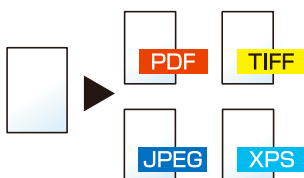

➔ [File Format \(page 6-37\)](#)

## Scan the long originals (Long Original)

You can scan the long originals such as Contract and Data log.

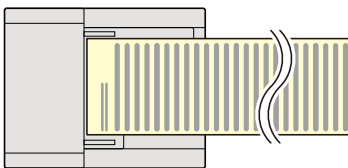

➔ [Long Original \(page 6-37\)](#)



## Detect the multiple feeding of originals (Detect Multi-fed Originals)

When reading a document from the document processor, if the multiple feeding of documents is detected, then the reading stops automatically.

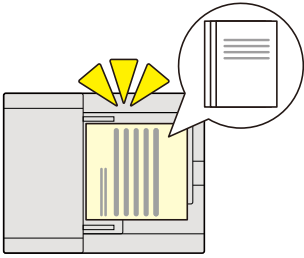

➔ [Detect Multi-fed Originals on page 6-34](#)

## Detects a bent corner on the original (detection of a bent corner on the original)

When reading a document from the document processor, if a bent corner is detected, then the reading stops automatically.



➔ [Detect Bent Corner Originals on page 6-34](#)

## Perform remote operation (Command Center RX)

You can access to the machine remotely to print, send or download data.  
Administrators can configure the machine behavior or management settings.

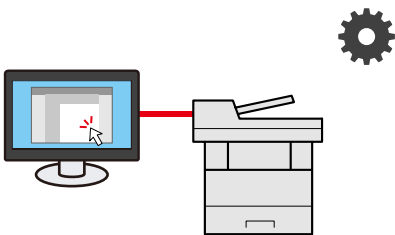

➔ [Command Center RX \(page 2-71\)](#)

# Color and Image Quality Functions

The machine is equipped with various color and image quality functions. You can adjust the scanned image as desired.

## Basic Color Modes

The basic color modes are as follows.

### Auto Color

Automatically recognizes whether a document being scanned is color or black & white.

#### Reference image

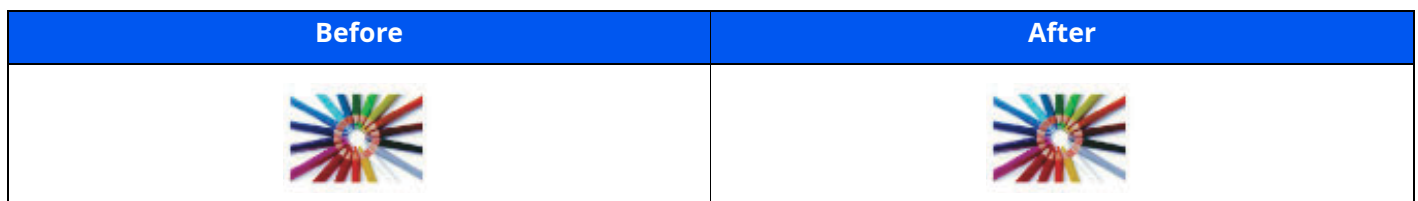

### Full Color

Scans a document in full color.

#### Reference image

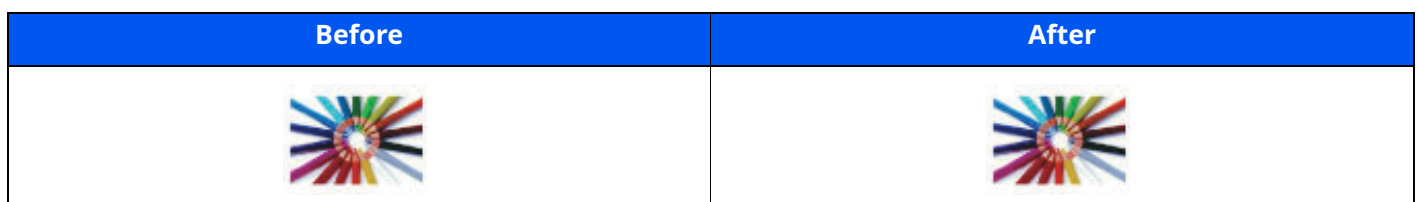

### Grayscale

Scans a document in grayscale.

#### Reference image

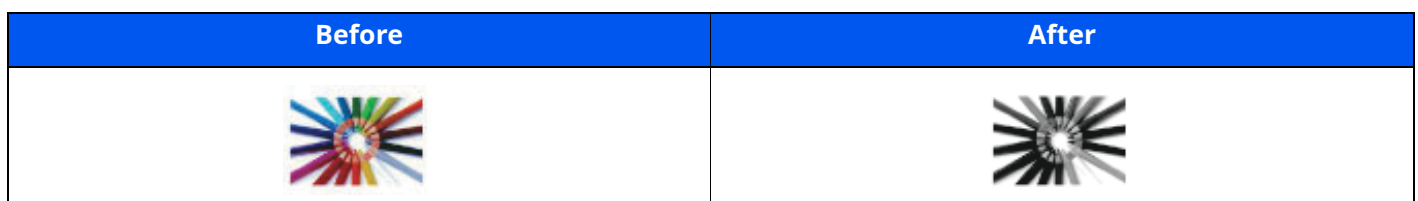

### Black & White

Scans a document in black & white.

#### Reference image

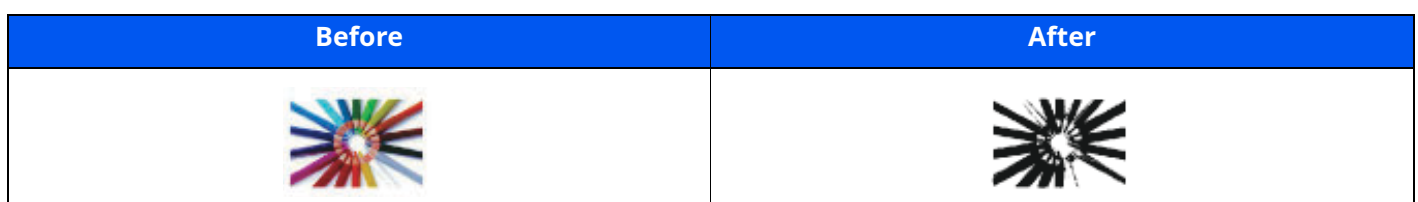



For details, refer to the following:

➔ [Color Selection \(page 6-29\)](#)

## Adjusting Image Quality and Color

To adjust the image quality or color of an image, use the following functions.









### Adjust the color precisely

I want to...	Sample image (before)	Sample image (after)	Function
Adjust the density.			Density

For details, refer to the following:

➔ [Density \(page 6-27\)](#)

### Adjust the image quality precisely

I want to...	Sample image (before)	Sample image (after)	Function
Emphasize or blur the image outline. Example: Emphasize the image outlines			Sharpness
Adjust the difference between dark and light parts of the image.			Contrast
Darken or lighten the background (the area with no texts or images) of a document. Example: Lightening the background			Background Density
Prevent bleed-through in 2-sided originals.			Prevent Bleed-through

For details, refer to the following:



➔ [Sharpness \(page 6-30\)](#)

➔ [Contrast \(page 6-31\)](#)

➔ [Background Density Adj. \(Background Density Adjustment\) \(page 6-30\)](#)

➔ [Prevent Bleed-thru \(page 6-31\)](#)

### Adjust the scanned image

I want to...	Sample image (before)	Sample image (after)	Function
Decrease the file size and produce the characters clearly.			File format [High Comp. PDF]

For details, refer to the following:

➔ [File Format \(page 6-37\)](#)

## Guides Provided with the Machine

The following guides are provided with the machine. Refer to each guide as needed.

The contents of the guides are subject to change without notice for the purpose of improvement of machine performance.

### Printed guides

<b>Start using the machine quickly</b>	<b>Quick Guide</b> Explains how to use basic functions of the machine, how to use convenient features, how to perform routine maintenance, and what to do when problems occur.
<b>For safe use of the machine</b>	<b>Safety Guide</b> Provides safety and cautionary information for installation environment and use of the machine. Be sure to read this guide before using the machine.
	<b>Safety Guide (ECOSYS MA6000ifx/ECOSYS MA5500ifx/ECOSYS MA4500ifx/ECOSYS MA4500ix)</b> Indicates the space required for machine installation, and describes the cautionary labels and other safety information. Be sure to read this guide before using the machine.

### Guides (PDF) on our website

<b>Use the machine thoughtfully</b>	<b>Operation Guide (This Guide)</b> Explains how to load paper and perform copy, print and scan operations, and indicates default settings and other information.
<b>Use the fax functions</b>	<b>FAX Operation Guide</b> Explains how to use the fax function.
<b>Use the ID card</b>	<b>Card Authentication Kit (B) Operation Guide</b> Explains how to perform authentication using the ID card.
<b>Strengthen security</b>	<b>Data Security Kit (E) Operation Guide</b> Explains how to introduce and use the Data Security kit (E), and how to overwrite and encrypt data.
<b>Easily register machine information and configure settings</b>	<b>Command Center RX User Guide</b> Explains how to access the machine from a Web browser on your computer to check and change settings.
<b>Print data from a computer</b>	<b>Printer Driver User Guide</b> Explains how to install the printer driver and use the printer function.
<b>Directly print a PDF file</b>	<b>KYOCERA Net Direct Print Operation Guide</b> Explains how to print PDF files without launching Adobe Acrobat or Reader.
<b>Monitor the machine and printers on the network</b>	<b>KYOCERA Net Viewer User Guide</b> Explains how to monitor your network printing system (the machine) with KYOCERA Net Viewer.
<b>Scan images and save with information</b>	<b>File Management Utility User Guide</b> Explains how to use File Management Utility to set various parameters and send and save scanned documents.
<b>Print without using the printer driver</b>	<b>PRESCRIBE Commands Command Reference</b> Describes the native printer language (PRESCRIBE commands).
	<b>PRESCRIBE Commands Technical Reference</b> Describes the PRESCRIBE command functions and control for each type of emulation.
<b>Adjust the print or scan position</b>	<b>Maintenance Menu User Guide</b> Maintenance Menu provides the explanation on how to configure the print, scan, and other settings.

Install the following versions of Adobe Reader to view the manuals.

Version 8.0 or later

# About the Operation Guide (this Guide)

## Structure of the guide

The Operation Guide contains the following chapters.

Chapter	Contents
<b>Legal and Safety Information</b>	Provides precautions regarding use of the machine and trademark information.
<b>Installing and Setting up the Machine</b>	Explains part names, cable connections, installation of the software, login, logout, and other matters related to administration of the machine.
<b>Preparation before Use</b>	Explains preparations and settings that are required in order to use the machine, such as how to use the operation panel, load paper, and create an address book.
<b>Printing from PC</b>	Explains functions that are available when the machine is used as a printer.
<b>Operation on the Machine</b>	Explains the basic procedures for using the machine, such as placing originals, making copies, sending documents, and using document boxes.
<b>Using Various Functions</b>	Explains convenient functions that are available on the machine.
<b>Status/Job Cancel</b>	Explains how to check the status of a job and the job history, and how to cancel jobs being printed or waiting to print. Also explains how to check paper and toner levels, how to check the device status, and how to cancel fax transmission.
<b>Setup and Registration (System Menu)</b>	Explains System Menu and how it relates to the operation of the machine.
<b>User Authentication and Accounting (User Login, Job Accounting)</b>	Explains user login and job accounting.
<b>Troubleshooting</b>	Explains what to do when toner runs out, an error is displayed, or a paper jam or other problem occurs.
<b>Appendix</b>	Describes convenient options that are available for the machine. Provides information on media types and paper sizes, and gives a glossary of terms. Explains how to enter characters, and lists the specifications of the machine.

## Conventions Used in This Guide

Adobe Reader XI is used as an example in the explanations below.

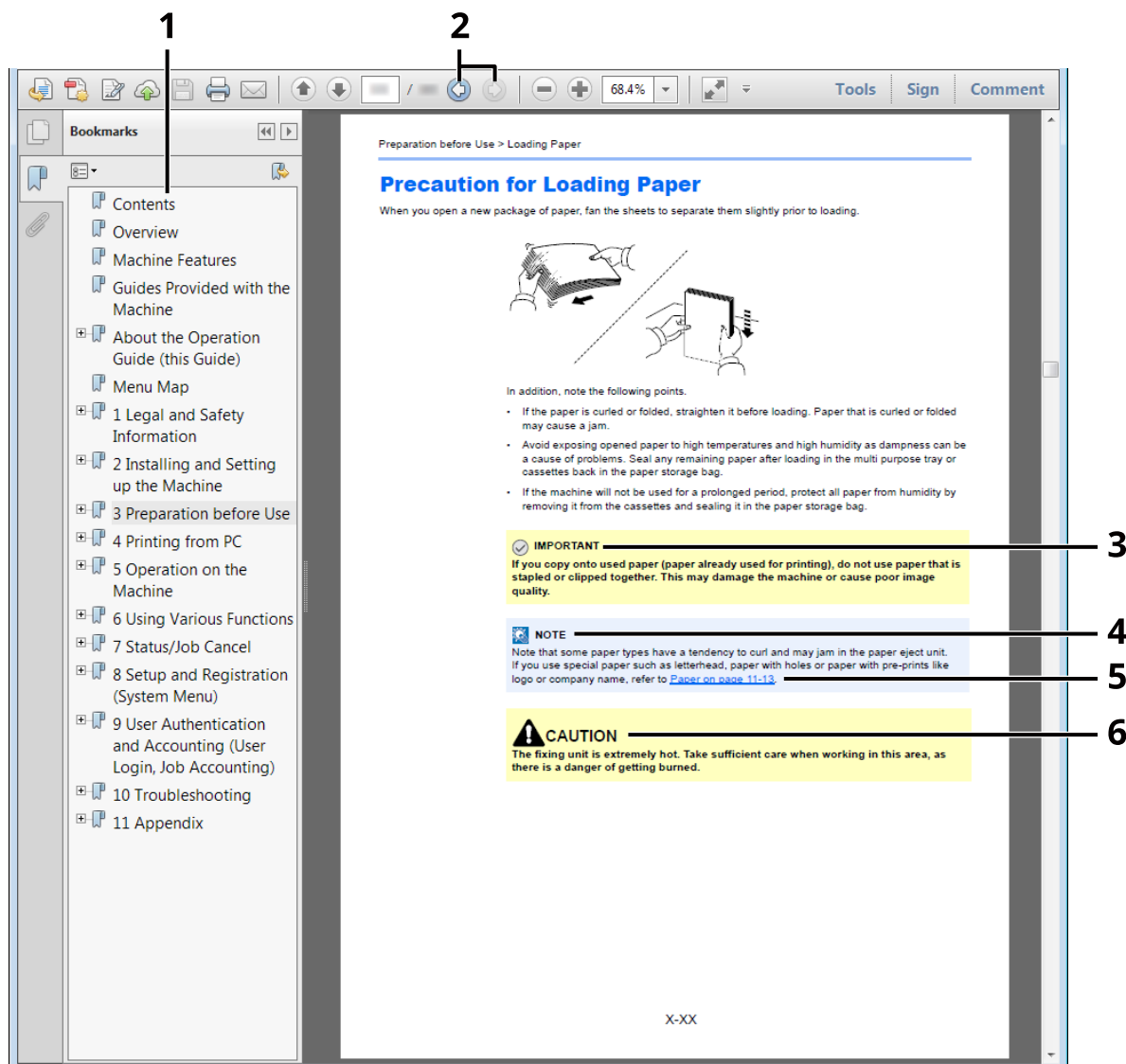

- 1 Click an item in the Table of Contents to jump to the corresponding page.
- 2 Click to move from the current page to the previously displayed page. This is convenient when you want to return to the page from which you jumped to the current page.
- 3 Indicates operational requirements and restrictions to operate the machine correctly, and avoid damage to the machine or property.
- 4 Indicates supplemental explanations and reference information for operations.
- 5 Click the underlined text to jump to the corresponding page.
- 6 Indicates that personal injury or mechanical damage may result from insufficient attention to or incorrect compliance with the related points.

**NOTE**  
The items that appear in Adobe Reader vary depending on how it is used. If the Table of Contents or tools do not appear, refer to Adobe Reader Help.

Certain items are indicated in this guide by the conventions described below.

Convention	Description
<b>[Bold]</b>	Indicates keys and buttons.
"Regular"	Indicates a message or setting.

## Conventions used in procedures for operating the machine

In this Operation Guide, continuous operation of the keys on the touch panel is as follows:

### Actual procedure

- 1 Select the [**Home**] key.
- 2 Select the [...].
- 3 Select the [**System Menu**].
- 4 Select [**Device Settings**].
- 5 Move the screen downwards (i.e. swiping)
- 6 Select [**Sound**].

### Procedure indicated in this guide

[**Home**] key > [...] > [**System Menu**] > [**Device Settings**] > [**Sound**]

### Actual procedure

- 1 Select [**Job Accounting/Authentication**].

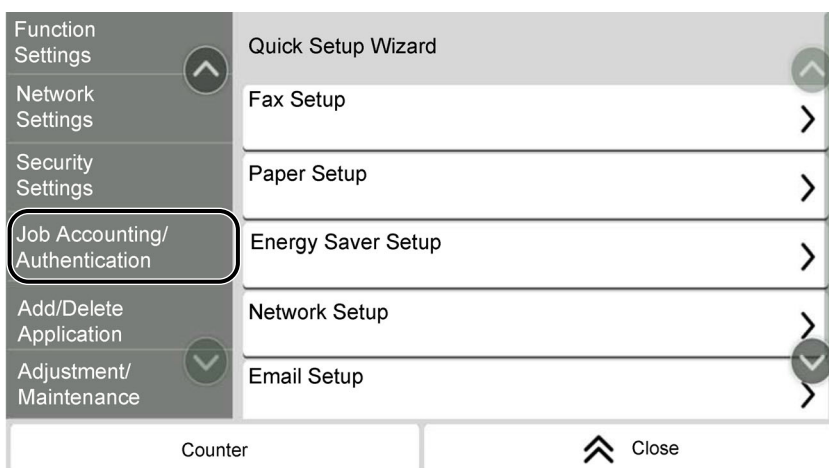

- 2 Select [**Job Accounting**] in " Job Accounting Setting".

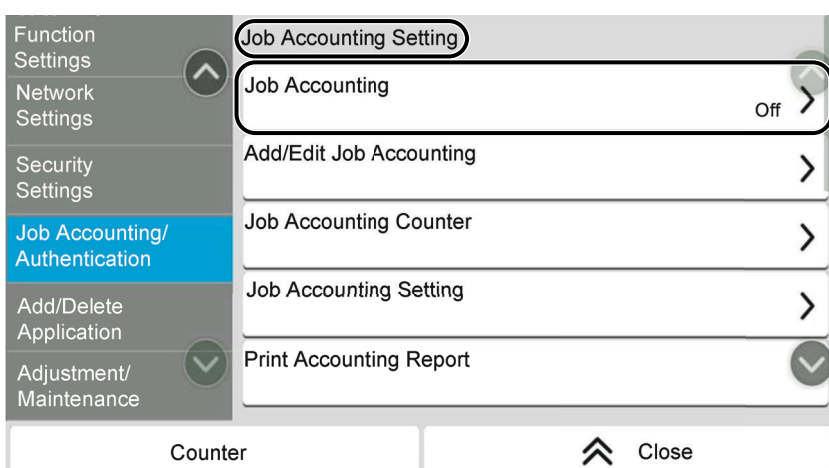

### Procedure indicated in this guide







[**Job Accounting/Authentication**] > " Job Accounting Setting" [**Job Accounting**]

For details on touch panel operation, refer to the following:

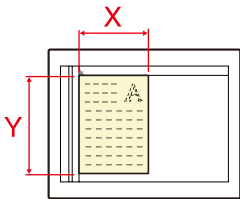
➔ [Using the Touch Panel \(page 2-14\)](#)

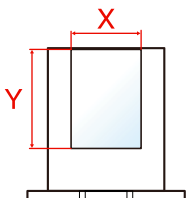
## Size and Orientation of Originals and Paper

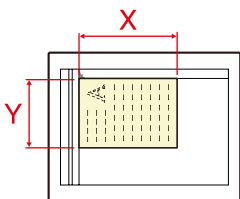
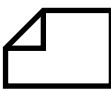
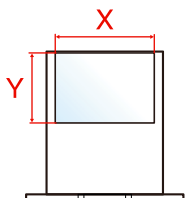
Original sizes and paper sizes such as A5 can be used in both the horizontal and vertical orientations. To distinguish the orientations when these sizes are used, "R" is added to sizes used in the horizontal orientation. In addition, the following icons are used to indicate original and paper placement orientations on the touch panel.

Orientation		Setting Position (X=Length, Y=Width)	Icons on the touch panel	Indicated size in this Guide*
Vertical orientation	Original	 Original	 Original	A5
	Paper	 Paper	 Paper	
Horizontal orientation (-R)	Original	 Original	 Original	A5-R
	Paper	 Paper	 Paper	

\* Original/paper sizes that can be used vary depending on the function and source tray. For details, refer to the following.

➔ [Specifications \(page 11-21\)](#)



# Menu Map

This is a list of menus displayed on the touch panel. Depending on the settings, some menus may not be displayed. Some menu names may differ from their reference titles.

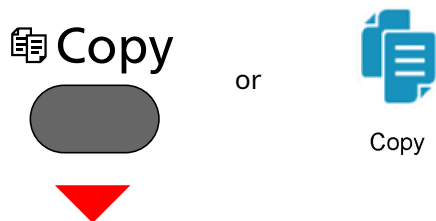

<b>Org./Paper/Finishing</b>	Original Size ( <a href="#">page 6-14</a> )
	Paper Selection ( <a href="#">page 6-15</a> )
	Mixed Size Originals ( <a href="#">page 6-16</a> )
	Original Orientation ( <a href="#">page 6-18</a> )
	Collate ( <a href="#">page 6-19</a> )
	ID Card Copy ( <a href="#">page 6-19</a> )
<b>Layout/Edit</b>	Zoom ( <a href="#">page 6-19</a> )
	Combine ( <a href="#">page 6-21</a> )
	Erase Shadowed Areas ( <a href="#">page 6-23</a> )
	Duplex ( <a href="#">page 6-25</a> )
<b>Image Quality</b>	Density ( <a href="#">page 6-27</a> )
	Original Image ( <a href="#">page 6-28</a> )
	EcoPrint ( <a href="#">page 6-29</a> )
	Sharpness ( <a href="#">page 6-30</a> )
	Background Density Adj. ( <a href="#">page 6-30</a> )
	Prevent Bleed-thru ( <a href="#">page 6-31</a> )
	Contrast ( <a href="#">page 6-31</a> )
	Erase Colors ( <a href="#">page 6-32</a> )
<b>Advanced Setup</b>	Continuous Scan ( <a href="#">page 6-32</a> )
	Job Finish Notice ( <a href="#">page 6-33</a> )
	File Name Entry ( <a href="#">page 6-33</a> )
	Priority Override ( <a href="#">page 6-34</a> )
	Detect Multi-fed Originals ( <a href="#">page 6-34</a> )
	Detect Bent Corner Originals ( <a href="#">page 6-34</a> )
	Skip Blank Page ( <a href="#">page 6-35</a> )
	Quiet Mode ( <a href="#">page 6-35</a> )
<b>Favorites (<a href="#">page 5-7</a>)</b>	
<b>Shortcut (<a href="#">page 5-13</a>)</b>	

 Send



or



Send



<b>Destination</b>	Email ( <a href="#">page 5-17</a> )
	SMB ( <a href="#">page 5-17</a> )
	FTP ( <a href="#">page 5-17</a> )
	Fax (refer to <b>FAX Operation Guide</b> )
	Fax Server ( <a href="#">page 8-54</a> )
	WSD Scan ( <a href="#">page 8-32</a> )
	Address Book ( <a href="#">page 5-36</a> )
<b>Org./Sending Data Format</b>	Original Size ( <a href="#">page 6-14</a> )
	Mixed Size Originals ( <a href="#">page 6-16</a> )
	2-sided ( <a href="#">page 6-35</a> )
	Sending Size ( <a href="#">page 6-36</a> )
	Original Orientation ( <a href="#">page 6-18</a> )
	Long Original ( <a href="#">page 6-37</a> )
	File Format ( <a href="#">page 6-37</a> )
	File Separation ( <a href="#">page 6-44</a> )
<b>Color/Image Quality</b>	Density ( <a href="#">page 6-27</a> )
	Original Image ( <a href="#">page 6-28</a> )
	Scan Resolution ( <a href="#">page 6-44</a> )
	Fax TX Resolution (refer to <b>FAX Operation Guide</b> )
	Color Selection ( <a href="#">page 6-29</a> )
	Sharpness ( <a href="#">page 6-30</a> )
	Clarify Text (Noise Removal) ( <a href="#">page 6-45</a> )
	Background Density Adj. ( <a href="#">page 6-30</a> )
	Prevent Bleed-thru ( <a href="#">page 6-31</a> )
	Contrast ( <a href="#">page 6-31</a> )
Erase Colors ( <a href="#">page 6-32</a> )	

<b>Advanced Setup</b>	Border Erase/Full Scan ( <a href="#">page 6-23</a> )
	Zoom ( <a href="#">page 6-19</a> )
	Job Finish Notice ( <a href="#">page 6-33</a> )
	Fax Delayed Transmission (refer to <b>FAX Operation Guide</b> )
	File Name Entry ( <a href="#">page 6-33</a> )
	Continuous Scan ( <a href="#">page 6-32</a> )
	Email Subject/Body ( <a href="#">page 6-45</a> )
	Fax Direct Transmission (refer to <b>FAX Operation Guide</b> )
	Fax Polling RX (refer to <b>FAX Operation Guide</b> )
	FTP Encrypted TX ( <a href="#">page 6-45</a> )
	Email Encrypted TX ( <a href="#">page 6-46</a> )
	Digital Signature to Email ( <a href="#">page 6-46</a> )
	Fax TX Report (refer to <b>FAX Operation Guide</b> )
	Detect Multi-fed Originals ( <a href="#">page 6-34</a> )
	Detect Bent Corner Originals ( <a href="#">page 6-34</a> )
Skip Blank Page ( <a href="#">page 6-35</a> )	
Quiet Mode ( <a href="#">page 6-35</a> )	
<b>Favorites (<a href="#">page 5-7</a>)</b>	
<b>Shortcut (<a href="#">page 5-13</a>)</b>	



Custom Box



Add/Edit ( <a href="#">page 5-50</a> )					
Search (No.) ( <a href="#">page 5-44</a> )					
Search (Name) ( <a href="#">page 5-44</a> )					
(Open any box)	Store File	Functions	Original Size ( <a href="#">page 6-14</a> )		
			Mixed Size Originals ( <a href="#">page 6-16</a> )		
			2-sided ( <a href="#">page 6-35</a> )		
			Original Orientation ( <a href="#">page 6-18</a> )		
			Storing Size ( <a href="#">page 6-48</a> )		
			Prevent Bleed-thru ( <a href="#">page 6-31</a> )		
			Density ( <a href="#">page 6-27</a> )		
			Original Image ( <a href="#">page 6-28</a> )		
			Scan Resolution ( <a href="#">page 6-44</a> )		
			Color Selection ( <a href="#">page 6-29</a> )		
			Erase Colors ( <a href="#">page 6-32</a> )		
			Sharpness ( <a href="#">page 6-30</a> )		
			Background Density Adj. ( <a href="#">page 6-30</a> )		
			Zoom ( <a href="#">page 6-19</a> )		
			Border Erase/Full Scan ( <a href="#">page 6-23</a> )		
			Continuous Scan ( <a href="#">page 6-32</a> )		
			Job Finish Notice ( <a href="#">page 6-33</a> )		
			File Name Entry ( <a href="#">page 6-33</a> )		
			Detect Multi-fed Originals ( <a href="#">page 6-34</a> )		
			Detect Bent Corner Originals ( <a href="#">page 6-34</a> )		
			Skip Blank Page ( <a href="#">page 6-35</a> )		
			Quiet Mode ( <a href="#">page 6-35</a> )		
			Contrast ( <a href="#">page 6-31</a> )		
			<b>Favorites (<a href="#">page 5-7</a>)</b>		
			<b>Shortcut (<a href="#">page 5-13</a>)</b>		

(Open any box)	<b>Print</b>	<b>Functions</b>	Paper Selection ( <a href="#">page 6-15</a> )
			Collate ( <a href="#">page 6-19</a> )
			Duplex ( <a href="#">page 6-25</a> )
			File Name Entry ( <a href="#">page 6-33</a> )
			Job Finish Notice ( <a href="#">page 6-33</a> )
			EcoPrint ( <a href="#">page 6-29</a> )
			Priority Override ( <a href="#">page 6-34</a> )
			Delete after Printed ( <a href="#">page 6-47</a> )
			Quiet Mode ( <a href="#">page 6-35</a> )
		<b>Favorites (<a href="#">page 5-7</a>)</b>	
<b>Shortcut (<a href="#">page 5-13</a>)</b>			
(Open any box)	<b>Send</b>	Destination ( <a href="#">page 5-36</a> )	
		<b>Functions</b>	File Format ( <a href="#">page 6-37</a> )
			Fax TX Resolution (refer to <b>FAX Operation Guide</b> )
			Job Finish Notice ( <a href="#">page 6-33</a> )
			Fax Delayed Transmission (refer to <b>FAX Operation Guide</b> )
			File Name Entry ( <a href="#">page 6-33</a> )
			Email Subject/Body ( <a href="#">page 6-45</a> )
			Delete after Transmitted ( <a href="#">page 6-47</a> )
			FTP Encrypted TX ( <a href="#">page 6-45</a> )
			Email Encrypted TX ( <a href="#">page 6-46</a> )
			Digital Signature to Email ( <a href="#">page 6-46</a> )
			File Separation ( <a href="#">page 6-44</a> )
			Fax TX Report (refer to <b>FAX Operation Guide</b> )
		<b>Image Quality</b>	Resolution ( <a href="#">page 6-44</a> )
		<b>Favorites (<a href="#">page 5-7</a>)</b>	
<b>Shortcut (<a href="#">page 5-13</a>)</b>			

(Open any box)	<b>Others</b>	Join ( <a href="#">page 5-44</a> )
		Move/Copy ( <a href="#">page 5-56</a> )
		Preview ( <a href="#">page 5-48</a> )
		Page Selection ( <a href="#">page 5-44</a> )
		Delete ( <a href="#">page 5-59</a> )
	Search(Name) ( <a href="#">page 5-44</a> )	
	Search(No.) ( <a href="#">page 5-44</a> )	
	 ( <a href="#">page 5-44</a> )	



Job Box



<b>Private Print/Stored Job</b> ( <a href="#">page 4-20</a> , <a href="#">page 4-21</a> )
<b>Quick Copy/Proof and Hold</b> ( <a href="#">page 4-23</a> , <a href="#">page 4-25</a> )
<b>PIN Print</b> ( <a href="#">page 4-28</a> )



USB Drive



<b>Print</b>	<b>Functions</b>	
		Paper Selection ( <a href="#">page 6-15</a> )
		Collate ( <a href="#">page 6-19</a> )
		Duplex ( <a href="#">page 6-25</a> )
		File Name Entry ( <a href="#">page 6-33</a> )
		Job Finish Notice ( <a href="#">page 6-33</a> )
		EcoPrint ( <a href="#">page 6-29</a> )
		Priority Override ( <a href="#">page 6-34</a> )
		Encrypted PDF Password ( <a href="#">page 6-48</a> )
		JPEG/TIFF Print ( <a href="#">page 6-49</a> )
		XPS Fit to Page ( <a href="#">page 6-49</a> )
		Quiet Mode ( <a href="#">page 6-35</a> )



Store File	Functions	
		Original Size ( <a href="#">page 6-14</a> )
		Mixed Size Originals ( <a href="#">page 6-16</a> )
		2-sided ( <a href="#">page 6-35</a> )
		Original Orientation ( <a href="#">page 6-18</a> )
		Storing Size ( <a href="#">page 6-48</a> )
		Prevent Bleed-thru ( <a href="#">page 6-31</a> )
		Density ( <a href="#">page 6-27</a> )
		Original Image ( <a href="#">page 6-28</a> )
		Scan Resolution ( <a href="#">page 6-44</a> )
		Color Selection ( <a href="#">page 6-29</a> )
		Erase Colors ( <a href="#">page 6-32</a> )
		Sharpness ( <a href="#">page 6-30</a> )
		Clarify Text (Noise Removal) ( <a href="#">page 6-45</a> )
		Background Density Adj. ( <a href="#">page 6-30</a> )
		Zoom ( <a href="#">page 6-19</a> )
		Border Erase/Full Scan ( <a href="#">page 6-23</a> )
		Continuous Scan ( <a href="#">page 6-32</a> )
		File Name Entry ( <a href="#">page 6-33</a> )
		File Format ( <a href="#">page 6-37</a> )
		Job Finish Notice ( <a href="#">page 6-33</a> )
		File Separation ( <a href="#">page 6-44</a> )
		Detect Multi-fed Originals ( <a href="#">page 6-34</a> )
		Detect Bent Corner Originals ( <a href="#">page 6-34</a> )
		Skip Blank Page ( <a href="#">page 6-35</a> )
		Contrast ( <a href="#">page 6-31</a> )
		Quiet Mode ( <a href="#">page 6-35</a> )
		Long Original ( <a href="#">page 6-37</a> )
<b>Remove USB (<a href="#">page 5-63</a>)</b>		
<b>USB Info (<a href="#">page 5-63</a>)</b>		
<b>Delete (<a href="#">page 5-46</a>)</b>		
 ( <a href="#">page 5-46</a> )		

Status/  
Job Cancel

or



Status/  
Job Cancel



<b>Printing Jobs</b>	Status ( <a href="#">page 7-3</a> )
	Log ( <a href="#">page 7-2</a> )
<b>Sending Jobs</b>	Status ( <a href="#">page 7-5</a> )
	Scheduled ( <a href="#">page 7-7</a> )
	Log ( <a href="#">page 7-2</a> )
<b>Storing Jobs</b>	Status ( <a href="#">page 7-6</a> )
	Log ( <a href="#">page 7-2</a> )
<b>Fax Communication Status (refer to FAX Operation Guide)</b>	
<b>Fax Incoming/Outgoing Log (refer to FAX Operation Guide)</b>	

System Menu / Counter



OR



System Menu



<b>Quick Setup Wizard</b>	Fax Setup ( <a href="#">page 2-49</a> )	
	Paper Setup ( <a href="#">page 2-49</a> )	
	Energy Saver Setup ( <a href="#">page 2-50</a> )	
	Network Setup ( <a href="#">page 2-50</a> )	
	Email Setup ( <a href="#">page 2-50</a> )	
	Security Setup ( <a href="#">page 2-50</a> )	
<b>Device Settings</b>	<b>Language/System of Units</b>	Language ( <a href="#">page 8-7</a> )
		Measurement ( <a href="#">page 8-7</a> )
	<b>Keyboard</b>	Keyboard Layout ( <a href="#">page 8-7</a> )
		Optional Keyboard Type ( <a href="#">page 8-7</a> )
	<b>Numeric Keypad</b>	Default Display ( <a href="#">page 8-7</a> )
		Layout (HyPAS Application) ( <a href="#">page 8-7</a> )
	<b>Date/Time</b>	Date and Time ( <a href="#">page 8-7</a> )
		Date Format ( <a href="#">page 8-8</a> )
		Time Zone ( <a href="#">page 8-8</a> )
	<b>Energy Saver/Timer</b>	Auto Panel Reset ( <a href="#">page 8-8</a> )
		Panel Reset Timer ( <a href="#">page 8-8</a> )
		Low Power Timer ( <a href="#">page 8-8</a> )
		Sleep Timer ( <a href="#">page 8-8</a> )
		Sleep Rules (models for Europe) ( <a href="#">page 8-8</a> )
		Sleep Level (models except for Europe) ( <a href="#">page 8-8</a> )
		Weekly Timer Settings ( <a href="#">page 8-9</a> )
		Power Off Timer (models for Europe) ( <a href="#">page 8-9</a> )
		Power Off Rule (models for Europe) ( <a href="#">page 8-9</a> )
Energy Saver Recovery Level ( <a href="#">page 8-9</a> )		
Ping Timeout ( <a href="#">page 8-9</a> )		

<b>Device Settings</b>	<b>Display Settings</b>	Display Brightness ( <a href="#">page 8-10</a> )		
		Default Screen ( <a href="#">page 8-10</a> )		
		Wallpaper ( <a href="#">page 2-19</a> )		
		Show Power Off Message ( <a href="#">page 8-10</a> )		
		Quick Setup Registration (Copy) ( <a href="#">page 8-10</a> )		
		Quick Setup Registration (Send) ( <a href="#">page 8-10</a> )		
		Quick Setup Registration (Fax) (refer to <b>FAX Operation Guide</b> )		
		Quick Setup Registration (Storing in Box) ( <a href="#">page 8-10</a> )		
		Quick Setup Registration (Box Print) ( <a href="#">page 8-10</a> )		
		Quick Setup Registration (Sending from Box) ( <a href="#">page 8-10</a> )		
	<b>Sound</b>	Buzzer ( <a href="#">page 8-11</a> )		
		Fax Speaker Volume (refer to <b>FAX Operation Guide</b> )		
		Fax Monitor Volume (refer to <b>FAX Operation Guide</b> )		
	<b>Original/Scan Settings</b>	Auto Detect Original Size (DP) ( <a href="#">page 8-11</a> )		
		Custom Original Size ( <a href="#">page 8-12</a> )		
		Default Original Size ( <a href="#">page 8-12</a> )		
		Default Original Size (Platen) ( <a href="#">page 8-12</a> )		
	<b>Paper Feeding</b>	Cassette 1 Settings ( <a href="#">page 8-13</a> )		
		Cassette 2 Settings ( <a href="#">page 8-13</a> )		
		Cassette 3 Settings ( <a href="#">page 8-13</a> )		
		Cassette 4 Settings ( <a href="#">page 8-13</a> )		
		Cassette 5 Settings ( <a href="#">page 8-13</a> )		
		MP Tray Settings ( <a href="#">page 8-14</a> )		
		Custom Paper Settings ( <a href="#">page 8-15</a> )		
		Media Type Setting ( <a href="#">page 8-17</a> )		
		Show Paper Setup Message ( <a href="#">page 8-17</a> )		
		<b>Paper Feed Settings</b>	Default Paper Source ( <a href="#">page 8-18</a> )	
			Paper Selection ( <a href="#">page 8-18</a> )	
			Auto Paper Selection ( <a href="#">page 8-18</a> )	
			Media for Auto (B&W) ( <a href="#">page 8-18</a> )	
Special Paper Action ( <a href="#">page 8-18</a> )				

<b>Device Settings</b>	Function Key Assignment ( <a href="#">page 8-19</a> )	
	<b>Operation Assist</b>	Orientation Confirmation ( <a href="#">page 8-19</a> )
		Preset Limit ( <a href="#">page 8-19</a> )
		Clear Settings after Job Started ( <a href="#">page 8-19</a> )
	<b>Error Handling</b>	Duplexing Error ( <a href="#">page 8-19</a> )
		Paper Mismatch Error ( <a href="#">page 8-19</a> )
		Wrong Size Paper Loaded ( <a href="#">page 8-20</a> )
		Auto Error Clear ( <a href="#">page 8-20</a> )
		Continue or Cancel Error Job ( <a href="#">page 8-20</a> )
	<b>Toner Settings</b>	Low Toner Alert ( <a href="#">page 8-20</a> )
<b>Notification/Report</b>	<b>Printing Report/List</b>	Status Page ( <a href="#">page 8-21</a> )
		Service Status ( <a href="#">page 8-21</a> )
		Network Status ( <a href="#">page 8-21</a> )
		Optional Network Status ( <a href="#">page 8-21</a> )
		Print Accounting Report ( <a href="#">page 9-47</a> )
		Font List ( <a href="#">page 8-22</a> )
		Outgoing Fax Report (refer to <b>FAX Operation Guide</b> )
		Incoming Fax Report (refer to <b>FAX Operation Guide</b> )
		Fax List (Index) (refer to <b>FAX Operation Guide</b> )
		Fax List (No.) (refer to <b>FAX Operation Guide</b> )
		One Touch List (ALL) ( <a href="#">page 8-22</a> )
		One Touch List (Fax) (refer to <b>FAX Operation Guide</b> )
		Subaddress Box List (refer to <b>FAX Operation Guide</b> )
		Application Status ( <a href="#">page 8-22</a> )
		Configuration List ( <a href="#">page 8-22</a> )
		Data Sanitization Report ( <a href="#">page 8-22</a> )
	<b>Result Report Settings</b>	Send Result Report ( <a href="#">page 8-22</a> )
		RX Result (refer to <b>FAX Operation Guide</b> )
		Job Finish Notice Setting (refer to <b>FAX Operation Guide</b> )
	<b>Device Status Notification</b>	Low Toner Alert ( <a href="#">page 8-20</a> )
		Periodic Inspection Notification ( <a href="#">page 8-23</a> )
	Fax Communication Report (refer to <b>FAX Operation Guide</b> )	

<b>Notification/Report</b>	<b>History Settings</b>	<b>Sending Log History</b>	Auto Sending ( <a href="#">page 8-24</a> )
			Destination ( <a href="#">page 8-24</a> )
			Subject ( <a href="#">page 8-24</a> )
			SSFC ( <a href="#">page 8-24</a> )
			Personal Information ( <a href="#">page 8-24</a> )
			Sending Log History ( <a href="#">page 8-24</a> )
<b>Function Settings</b>	<b>Function Defaults</b>	<b>Common</b>	Clear Settings after Job Started ( <a href="#">page 8-25</a> )
			File Name Entry ( <a href="#">page 8-25</a> )
			Border Erase Default ( <a href="#">page 8-25</a> )
			Zoom ( <a href="#">page 8-25</a> )
			DP Read Action ( <a href="#">page 8-25</a> )
			Detect Multi-fed Originals ( <a href="#">page 8-25</a> )
			Detection of Bent Corner of the Original ( <a href="#">page 8-25</a> )
			Quiet Mode ( <a href="#">page 8-26</a> )
		<b>Copy/Print</b>	Original Size ( <a href="#">page 8-26</a> )
			Original Orientation (Copy) ( <a href="#">page 8-26</a> )
			Original Image (Copy) ( <a href="#">page 8-26</a> )
			Background Density Adj. (Copy) ( <a href="#">page 8-26</a> )
			Continuous Scan (Copy) ( <a href="#">page 8-26</a> )
			Prevent Bleed-through (Copy) ( <a href="#">page 8-26</a> )
			Skip Blank Page (Copy) ( <a href="#">page 8-26</a> )
			EcoPrint ( <a href="#">page 8-26</a> )
			Border Erase (Copy) ( <a href="#">page 8-26</a> )
			Collate ( <a href="#">page 8-26</a> )
			JPEG/TIFF Print ( <a href="#">page 8-26</a> )
			XPS Fit to Page ( <a href="#">page 8-26</a> )
Reserve Next Priority ( <a href="#">page 8-26</a> )			
Auto % Priority ( <a href="#">page 8-27</a> )			
ID Card Copy ( <a href="#">page 8-27</a> )			

Function Settings	Function Defaults	Send/Store	
			Original Size ( <a href="#">page 8-27</a> )
			Original Orientation (Send/Store) ( <a href="#">page 8-27</a> )
			Scan Resolution ( <a href="#">page 8-27</a> )
			Fax TX Resolution (refer to <b>FAX Operation Guide</b> )
			Org. Image (Send/Store) ( <a href="#">page 8-27</a> )
			Clarify Text (noise removal) ( <a href="#">page 8-27</a> )
			Background Density Adj. (Send/Store) ( <a href="#">page 8-27</a> )
			Continuous Scan (Send/Store) ( <a href="#">page 8-27</a> )
			Continuous Scan (Fax) (refer to <b>FAX Operation Guide</b> )
			Prevent Bleed-through (Send/Store) ( <a href="#">page 8-27</a> )
			Border Erase/Full Scan (Send/Store) ( <a href="#">page 8-28</a> )
			Border Erase/Full Scan (Fax) (refer to <b>FAX Operation Guide</b> )
			Skip Blank Page (Send/Store) ( <a href="#">page 8-28</a> )
			File Format ( <a href="#">page 8-28</a> )
			Image Quality (File Format) ( <a href="#">page 8-28</a> )
			High Comp. PDF Image ( <a href="#">page 8-28</a> )
			Color TIFF Compression ( <a href="#">page 8-28</a> )
			PDF/A ( <a href="#">page 8-28</a> )
			OCR Text Recognition Action ( <a href="#">page 8-28</a> )
			OCR Text Recognition ( <a href="#">page 8-28</a> )
			Primary OCR Language ( <a href="#">page 8-28</a> )
			OCR Output Format ( <a href="#">page 8-28</a> )
			File Separation ( <a href="#">page 8-28</a> )
			Email Subject/Body ( <a href="#">page 8-28</a> )

<b>Function Settings</b>	<b>Copy/Print</b>	Quick Setup Registration (Copy) ( <a href="#">page 8-10</a> )	
	<b>Send/Store</b>	Default Screen ( <a href="#">page 8-29</a> )	
		<b>Prevent Mis-sending Settings</b>	Destination Check before Send ( <a href="#">page 8-29</a> )
			Entry Check for New Dest. ( <a href="#">page 8-29</a> )
			New Destination Entry ( <a href="#">page 8-29</a> )
			Recall Destination ( <a href="#">page 8-29</a> )
			Broadcast ( <a href="#">page 8-29</a> )
			Destination History Usage( <a href="#">page 8-29</a> )
			Delete Destination History ( <a href="#">page 8-29</a> )
		Quick Setup Registration (Send) ( <a href="#">page 8-10</a> )	
		<b>Digital Signature to File</b>	Digital Signature ( <a href="#">page 8-30</a> )
	Digital Signature Format ( <a href="#">page 8-30</a> )		
	Password Confirmation on Signature Permission ( <a href="#">page 8-30</a> )		
	Password ( <a href="#">page 8-30</a> )		
	<b>Email</b>	<b>Email Settings</b>	SMTP (Email TX) ( <a href="#">page 8-31</a> )
			SMTP Server Name ( <a href="#">page 8-31</a> )
			SMTP Port Number ( <a href="#">page 8-31</a> )
			Sender Address ( <a href="#">page 8-31</a> )
			SMT Auth and Sender Address ( <a href="#">page 8-31</a> )
		<b>POP3</b>	POP3 ( <a href="#">page 8-31</a> )
			Remote Printing ( <a href="#">page 8-31</a> )
	<b>Sending Job - Folder</b>	FTP Settings ( <a href="#">page 8-31</a> )	
		SMB Settings ( <a href="#">page 8-31</a> )	
Fax (refer to <b>FAX Operation Guide</b> )			
<b>WSD</b>	WSD Scan ( <a href="#">page 8-32</a> )		
	WSD Print ( <a href="#">page 8-32</a> )		
<b>Address Book</b>	Add/Edit Machine Address Book ( <a href="#">page 8-32</a> )		
	<b>Machine Address Book</b>	Sort ( <a href="#">page 8-32</a> )	
		Narrow Down ( <a href="#">page 8-32</a> )	
		Edit Restriction ( <a href="#">page 8-32</a> )	
	External Address Book ( <a href="#">page 8-32</a> )		
	Address Book Type ( <a href="#">page 8-32</a> )		
<b>One-Touch Key</b>	Add/Edit One Touch Key ( <a href="#">page 8-32</a> )		
	Edit Restriction ( <a href="#">page 8-32</a> )		
Send and Forward ( <a href="#">page 8-33</a> )			
Forward Rules (refer to <b>FAX Operation Guide</b> )			



<b>Function Settings</b>	<b>Printer</b>	Emulation ( <a href="#">page 8-33</a> )
		EcoPrint ( <a href="#">page 8-33</a> )
		Override A4/Letter ( <a href="#">page 8-34</a> )
		Duplex ( <a href="#">page 8-34</a> )
		Copies ( <a href="#">page 8-34</a> )
		Orientation ( <a href="#">page 8-34</a> )
		Form Feed Timeout ( <a href="#">page 8-34</a> )
		LF Action ( <a href="#">page 8-34</a> )
		CR Action ( <a href="#">page 8-34</a> )
		Job Name ( <a href="#">page 8-34</a> )
		User Name ( <a href="#">page 8-34</a> )
		Paper Feed Mode ( <a href="#">page 8-34</a> )
		MP Tray Priority ( <a href="#">page 8-34</a> )
		Auto Cassette Change ( <a href="#">page 8-35</a> )
		Message Banner Print ( <a href="#">page 8-35</a> )
		Wide A4 ( <a href="#">page 8-35</a> )
		Resolution ( <a href="#">page 8-35</a> )
		KIR ( <a href="#">page 8-35</a> )
		Printing Job Terminator ( <a href="#">page 8-35</a> )
		Remote Printing ( <a href="#">page 8-35</a> )
		Direct Printing from Web ( <a href="#">page 8-35</a> )
	<b>Document Box</b>	Custom Box - Add/Edit ( <a href="#">page 5-50</a> )
		Auto File Deletion Time ( <a href="#">page 8-36</a> )
		Quick Setup Registration (Storing in Box) ( <a href="#">page 8-10</a> )
		Quick Setup Registration (Box Print) ( <a href="#">page 8-10</a> )
		Quick Setup Registration (Sending from Box) ( <a href="#">page 8-10</a> )
	<b>Job Box</b>	Quick Copy Job Retention ( <a href="#">page 8-36</a> )
		Deletion of Job Retention ( <a href="#">page 8-36</a> )
		Deletion of PIN Print at Power Off ( <a href="#">page 8-36</a> )

<b>Function Settings</b>	Subaddress Box (refer to <b>FAX Operation Guide</b> )		
	Fax Memory RX Box (refer to <b>FAX Operation Guide</b> )		
	<b>Home</b>	Customize Desktop ( <a href="#">page 2-19</a> )	
		Customize Taskbar ( <a href="#">page 2-19</a> )	
		Wallpaper ( <a href="#">page 2-19</a> )	
	<b>Status</b>	Job Status/Job Logs Settings ( <a href="#">page 8-37</a> )	
Remote Services ( <a href="#">page 8-37</a> )			
TWAIN/WIA ( <a href="#">page 8-38</a> )			
<b>Network Settings</b>	<b>Network Settings</b>	Host Name ( <a href="#">page 8-39</a> )	
		Proxy ( <a href="#">page 8-39</a> )	
		<b>Wi-Fi Direct Settings</b>	Wi-Fi Direct ( <a href="#">page 8-39</a> )
			Device Name ( <a href="#">page 8-39</a> )
			IP Address ( <a href="#">page 8-40</a> )
			Auto Disconnect ( <a href="#">page 8-40</a> )
			Persistent Group ( <a href="#">page 8-40</a> )
			Password ( <a href="#">page 8-40</a> )
			Frequency band ( <a href="#">page 8-40</a> )
		<b>Wi-Fi Settings</b>	Wi-Fi ( <a href="#">page 8-40</a> )
			Setup ( <a href="#">page 8-40</a> )
			TCP/IP Setting ( <a href="#">page 8-42</a> )
		<b>Wired Network Settings</b>	TCP/IP Setting ( <a href="#">page 8-44</a> )
			Others ( <a href="#">page 8-46</a> )

Network Settings	Network Settings	Protocol Settings	SMTP (Email TX) ( <a href="#">page 8-31</a> )
			POP3 (Email RX) ( <a href="#">page 8-31</a> )
			FTP Client (Transmission) ( <a href="#">page 8-46</a> )
			FTP Server (Reception) ( <a href="#">page 8-46</a> )
			SMB Client (Transmission) ( <a href="#">page 8-46</a> )
			NetBEUI ( <a href="#">page 8-46</a> )
			WSD Scan ( <a href="#">page 8-32</a> )
			WSD Print ( <a href="#">page 8-32</a> )
			ThinPrint ( <a href="#">page 8-47</a> )
			LPD ( <a href="#">page 8-47</a> )
			Raw ( <a href="#">page 8-47</a> )
			IPP ( <a href="#">page 8-47</a> )
			IPP over TLS ( <a href="#">page 8-47</a> )
			HTTP ( <a href="#">page 8-48</a> )
			HTTPS ( <a href="#">page 8-48</a> )
			LDAP ( <a href="#">page 8-48</a> )
			SNMPv1/v2c ( <a href="#">page 8-48</a> )
			SNMPv3 ( <a href="#">page 8-48</a> )
			Enhanced WSD ( <a href="#">page 8-48</a> )
			Enhanced WSD over TLS ( <a href="#">page 8-48</a> )
			eSCL ( <a href="#">page 8-48</a> )
			eSCL over TLS ( <a href="#">page 8-49</a> )
			VNC (RFB) ( <a href="#">page 8-49</a> )
			VNC (RFB) over TLS ( <a href="#">page 8-49</a> )
			Enhanced VNC over TLS ( <a href="#">page 8-49</a> )
		Ping ( <a href="#">page 8-50</a> )	
		Bonjour ( <a href="#">page 8-50</a> )	
		IP Filter (IPv4) ( <a href="#">page 8-50</a> )	
		IP Filter (IPv6) ( <a href="#">page 8-50</a> )	
		IPSec ( <a href="#">page 8-51</a> )	
		Restart Network ( <a href="#">page 8-51</a> )	

<b>Network Settings</b>	<b>Optional Network</b>	Host Name ( <a href="#">page 8-51</a> )		
		<b>Wireless Network</b>	Connection Status ( <a href="#">page 8-51</a> )	
			Setup ( <a href="#">page 8-51</a> )	
			TCP/IP Setting ( <a href="#">page 8-52</a> )	
			Others ( <a href="#">page 8-52</a> )	
		<b>Wired Network Settings</b>	TCP/IP Setting ( <a href="#">page 8-53</a> )	
			Others ( <a href="#">page 8-53</a> )	
	Restart Network ( <a href="#">page 8-53</a> )			
	<b>Connectivity</b>	Bluetooth Settings ( <a href="#">page 8-54</a> )		
		Fax Server ( <a href="#">page 8-54</a> )		
		Remote Operation ( <a href="#">page 8-54</a> )		
<b>Others</b>	Primary Network (Client) ( <a href="#">page 8-55</a> )			
	Restart Entire Device ( <a href="#">page 8-55</a> )			
<b>Security Settings</b>	Security Quick Setup ( <a href="#">page 8-55</a> )			
	<b>Interface Block Setting</b>	USB Host ( <a href="#">page 8-56</a> )		
		USB Device ( <a href="#">page 8-56</a> )		
		USB Drive ( <a href="#">page 8-56</a> )		
		Optional Interface ( <a href="#">page 8-56</a> )		
		Restart Entire Device ( <a href="#">page 8-56</a> )		
	<b>Device Security Settings</b>	Unusable Time (refer to <b>FAX Operation Guide</b> )		
		Job Status/Job Logs Settings ( <a href="#">page 8-37</a> )		
		Security Level ( <a href="#">page 8-57</a> )		
		Remote Printing ( <a href="#">page 8-57</a> )		
		RAM Disk Settings ( <a href="#">page 8-57</a> )		
		Software Verification ( <a href="#">page 8-57</a> )		
		Administrator Authentication on Firm Update ( <a href="#">page 8-57</a> )		
		Secure Boot ( <a href="#">page 8-57</a> )		
		Allowlisting ( <a href="#">page 8-58</a> )		
		Administrator Authentication for Data Import/Export ( <a href="#">page 8-58</a> )		
		<b>Data Security</b>	SSD Initialization ( <a href="#">page 8-58</a> )	
	Data Sanitization ( <a href="#">page 8-59</a> )			
	Installation of OCR Dictionary ( <a href="#">page 8-60</a> )			
	<b>Authentication Security</b>	User Account Lockout Settings ( <a href="#">page 9-4</a> )		
		Password Policy Settings ( <a href="#">page 9-5</a> )		
	Unknown User Settings ( <a href="#">page 9-51</a> )			
	<b>Network</b>	TLS ( <a href="#">page 8-61</a> )		
Network Access ( <a href="#">page 8-61</a> )				

<b>Job Accounting/ Authentication</b>	<b>Job Accounting Setting</b>	Job Accounting ( <a href="#">page 9-35</a> )		
		Add/Edit Job Accounting ( <a href="#">page 9-38</a> )		
		Job Accounting Counter ( <a href="#">page 9-45</a> )		
		<b>Job Accounting Setting</b>	Default Setting ( <a href="#">page 9-49</a> , <a href="#">page 9-50</a> )	
			Default Counter Limit ( <a href="#">page 9-44</a> )	
	Print Accounting Report ( <a href="#">page 9-47</a> )			
	<b>User Login Setting</b>	User Login ( <a href="#">page 9-3</a> )		
		Add/Edit Local User ( <a href="#">page 9-6</a> )		
		Local Authorization ( <a href="#">page 9-16</a> )		
		Obtain NW User Property ( <a href="#">page 9-24</a> )		
		Network User Authority ( <a href="#">page 9-18</a> )		
		Group Authorization ( <a href="#">page 9-19</a> )		
		Group List ( <a href="#">page 9-20</a> )		
		Guest Authorization Set. ( <a href="#">page 9-21</a> )		
		Guest Property ( <a href="#">page 9-22</a> )		
		Simple Login ( <a href="#">page 9-26</a> )		
		Simple Login Key ( <a href="#">page 9-27</a> )		
		Quick Job Printing ( <a href="#">page 9-30</a> )		
		PIN Login ( <a href="#">page 9-31</a> )		
	<b>Authentication Security</b>	User Account Lockout Settings ( <a href="#">page 9-4</a> )		
Password Policy Settings ( <a href="#">page 9-5</a> )				
Unknown User Settings ( <a href="#">page 9-51</a> )				
<b>ID Card Settings</b>	Keyboard Login ( <a href="#">page 9-29</a> )			
	Additional Authentication ( <a href="#">page 9-29</a> )			
<b>Add/Delete Application</b>	Application ( <a href="#">page 5-10</a> )			
	Optional Function ( <a href="#">page 11-8</a> )			

<b>Adjustment/ Maintenance</b>	<b>Image Adjustment</b>	<b>Density Adjustment</b>	Copy ( <a href="#">page 8-62</a> )
			Send/Box ( <a href="#">page 8-62</a> )
			Fax (refer to <b>FAX Operation Guide</b> )
			Clarify Text (Noise Removal) Settings ( <a href="#">page 8-62</a> )
		<b>Background Density Adj.</b>	Copy (Auto) ( <a href="#">page 8-62</a> )
			Send/Box (Auto) ( <a href="#">page 8-62</a> )
		<b>Sharpness Adjustment</b>	Copy ( <a href="#">page 8-62</a> )
			Send/Box ( <a href="#">page 8-62</a> )
		<b>Contrast</b>	Copy( <a href="#">page 8-62</a> )
			Send/Box ( <a href="#">page 8-62</a> )
		<b>Toner Save Level (EcoPrint)</b>	Copy( <a href="#">page 8-63</a> )
			Printer ( <a href="#">page 8-63</a> )
		Print Density ( <a href="#">page 8-63</a> )	
		Auto Color Correction ( <a href="#">page 8-63</a> )	
		Correcting Black Lines ( <a href="#">page 8-63</a> )	
	Auto Drum Refresh ( <a href="#">page 8-63</a> )		
	Drum Refresh ( <a href="#">page 8-63</a> )		
	Drum Refresh 2 ( <a href="#">page 8-63</a> )		
	<b>Others</b>	Amount of Optional Memory Used ( <a href="#">page 8-64</a> )	
		Altitude Adjustment ( <a href="#">page 8-64</a> )	
		MC ( <a href="#">page 8-64</a> )	
		<b>Diagnostics</b>	Memory Diagnostics ( <a href="#">page 8-64</a> )
			Software Verification ( <a href="#">page 8-57</a> )
		Test Page ( <a href="#">page 8-64</a> )	
		<b>Restart/ Initialization</b>	Restart Network ( <a href="#">page 8-51</a> )
			Restart Network (Optional Network) ( <a href="#">page 8-53</a> )
			Restart Entire Device ( <a href="#">page 8-55</a> )
Format SSD ( <a href="#">page 8-64</a> )			
Format SD Card ( <a href="#">page 8-64</a> )			
Service Settings ( <a href="#">page 8-64</a> )			

# 1 Legal and Safety Information

Please read this information before using your machine. This chapter provides information on the following topics.

Notice .....	1-2
Safety Conventions in This Guide .....	1-2
Environment .....	1-3
Precautions for Use .....	1-4
Laser Safety (Europe) .....	1-5
SAFETY OF LASER BEAM (USA) .....	1-6
Safety Instructions Regarding the Disconnection of Power .....	1-7
Compliance and Conformity .....	1-7
Radio Tag Technology .....	1-9
Other precautions (for users in California, the United States) .....	1-9
Legal Restriction on Copying/Scanning .....	1-9
EN ISO 7779 .....	1-9
EK1-ITB 2000 .....	1-9
Wireless Connection (Mexico only) .....	1-9
Security Precautions when Using Wireless LAN (If equipped) .....	1-9
Limited Use of This Product (If equipped) .....	1-10
Legal Information .....	1-11
Energy Saving Control Function .....	1-13
Automatic 2-Sided Print Function .....	1-13
Resource Saving - Paper .....	1-13
Environmental benefits of "Power Management" .....	1-13
Energy Star (ENERGY STAR®) Program .....	1-13
Warranty (the United States and Canada) .....	1-14

# Notice

## Safety Conventions in This Guide

The sections of this guide and parts of the machine marked with symbols are safety warnings meant to protect the user, other individuals and surrounding objects, and ensure correct and safe usage of the machine. The symbols and their meanings are indicated below.



**WARNING:** Indicates that serious injury or even death may result from insufficient attention to or incorrect compliance with the related points.



**CAUTION:** Indicates that personal injury or mechanical damage may result from insufficient attention to or incorrect compliance with the related points.

## Symbols

The  $\triangle$  symbol indicates that the related section includes safety warnings. Specific points of attention are indicated inside the symbol.



... [General warning]



... [Warning of high temperature]

The  $\otimes$  symbol indicates that the related section includes information on prohibited actions. Specifics of the prohibited action are indicated inside the symbol.



... [Warning of prohibited action]



... [Disassembly prohibited]

The  $\bullet$  symbol indicates that the related section includes information on actions which must be performed. Specifics of the required action are indicated inside the symbol.



... [Alert of required action]



... [Remove the power plug from the outlet]



... [Always connect the machine to an outlet with a ground connection]



### NOTE

An original which resembles a bank note closely may not be copied properly in some rare cases because this machine is equipped with a counterfeiting prevention function.



## Environment

The service environmental conditions are as follows:

<b>Temperature</b>	50 to 90.5 °F (10 to 32.5 °C)
<b>Humidity</b>	15 to 80%

Avoid the following locations when selecting a site for the machine.

- Avoid locations near a window or with exposure to direct sunlight.
- Avoid locations with vibrations.
- Avoid locations with drastic temperature fluctuations.
- Avoid locations with direct exposure to hot or cold air.
- Avoid poorly ventilated locations.

If the floor is delicate against casters, when this machine is moved after installation, the floor material may be damaged.

During copying, some ozone is released, but the amount does not cause any ill effect to one's health. If, however, the machine is used over a long period of time in a poorly ventilated room or when making an extremely large number of copies, the smell may become unpleasant. To maintain the appropriate environment for copy work, it is suggested that the room be properly ventilated.

## Precautions for Use

### Cautions when handling consumables

#### CAUTION

Do not attempt to incinerate parts which contain toner. Dangerous sparks may cause burns.

Keep parts which contain toner out of the reach of children.

If toner happens to spill from parts which contain toner, avoid inhalation and ingestion, as well as contact with your eyes and skin.

- If you do happen to inhale toner, move to a place with fresh air and gargle thoroughly with a large amount of water. If coughing develops, contact a physician.
- If you do happen to ingest toner, rinse your mouth with water and drink 1 or 2 cups of water to dilute the contents of your stomach. If necessary, contact a physician.
- If you do happen to get toner in your eyes, flush them thoroughly with water. If there is any remaining tenderness, contact a physician.
- If toner does happen to get on your skin, wash with soap and water.

Do not attempt to force open or destroy parts which contain toner.

### Other precautions

Return the exhausted toner container and waste toner box to your dealer or service representative. The collected toner container and waste toner box will be recycled or disposed in accordance with the relevant regulations.

Store the machine while avoiding exposure to direct sunlight.

Store the machine in a place where the temperature stays below 40 °C while avoiding sharp changes of temperature and humidity.

If the machine will not be used for an extended period of time, remove the paper from the cassette and the Multi Purpose (MP) Tray, return it to its original package and reseal it.

## Laser Safety (Europe)

Laser radiation could be hazardous to the human body. For this reason, laser radiation emitted inside this machine is hermetically sealed within the protective housing and external cover. In the normal operation of the product by user, no radiation can leak from the machine.

This machine is classified as Class 1 laser product under IEC/EN 60825-1:2014.

Regarding CLASS 1 laser products, information is provided on the rating label.

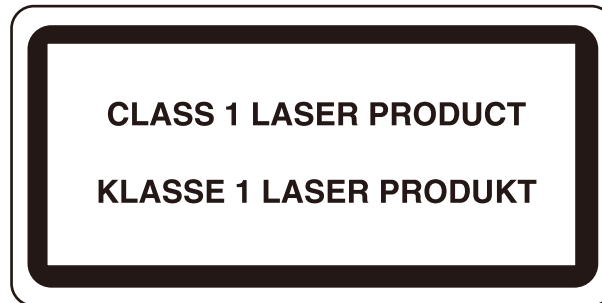

## SAFETY OF LASER BEAM (USA)

### 1. Safety of laser beam

This machine has been certified by the manufacturer to Class 1 level under the radiation performance standards established by the U.S.DHHS (Department of Health and Human Services) in 1968. This indicates that the product is safe to use during normal operation and maintenance. The laser optical system, enclosed in a protective housing and sealed within the external covers, never permits the laser beam to escape.

### 2. The CDRH Act

A laser-product-related act was implemented on Aug. 2, 1976, by the Center for Devices and Radiological Health (CDRH) of the U.S. Food and Drug Administration (FDA). This act prohibits the sale of laser products in the U.S. without certification, and applies to laser products manufactured after Aug. 1, 1976. The label shown below indicates compliance with the CDRH regulations and must be attached to laser products marketed in the United States. On this machine, the label is on the rear.

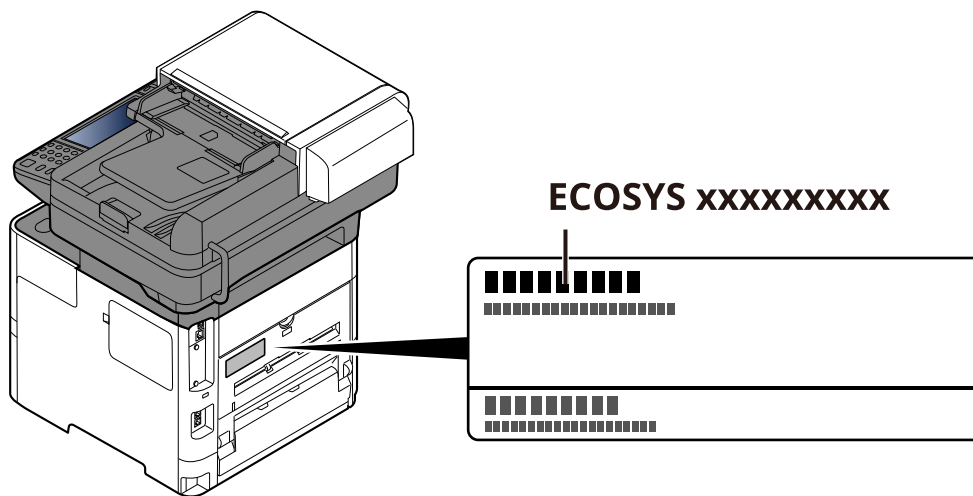

### 3. Maintenance

For safety of the service personnel, follow the maintenance instructions in the other section of this manual.

### 4. Safety switch

The power to the laser unit is cut off when the front cover is opened.

## Safety Instructions Regarding the Disconnection of Power

**Caution:** The power plug is the main isolation device! Other switches on the equipment are only functional switches and are not suitable for isolating the equipment from the power source.

**Attention:** Le débranchement de la fiche secteur est le seul moyen de mettre l'appareil hors tension. Les interrupteurs sur l'appareil ne sont que des interrupteurs de fonctionnement: ils ne mettent pas l'appareil hors tension.

## Compliance and Conformity

Hereby, KYOCERA Document Solutions Inc. declares that the radio equipment type ECOSYS MA6000ifx/ECOSYS MA5500ifx/ECOSYS MA4500ifx/ECOSYS MA4500ix are in compliance with Directive 2014/53/EU.

The full text of the EU declaration of conformity is available at the following internet address:

<https://www.kyoceradocumentsolutions.eu/index/service/dlc.html>

Module name	Software Ver.	Frequency band in which the radio equipment operates:	Maximum radio-frequency power transmitted in the frequency band in which the radio equipment operates:
IB-51 (Option)	2.2.6	2.4GHz	100mW
IB-37 (Option)	1.0	2.4 GHz	100mW
		5 GHz	50mW - 1 W
IB-38 (Option)	1.0	2.4 GHz	100mW
UG-35 (Option)	2005.11	13.56 GHz	0.2 nW

This equipment has been tested and found to comply with the limits for a Class B digital device, pursuant to Part 15 of the FCC Rules.

These limits are designed to provide reasonable protection against harmful interference in a residential installation. This equipment generates, uses and can radiate radio frequency energy and, if not installed and used in accordance with the instructions, may cause harmful interference to radio communications. However, there is no guarantee that interference will not occur in a particular installation. If this equipment does cause harmful interference to radio or television reception, which can be determined by turning the equipment off and on, the user is encouraged to try to correct the interference by one or more of the following measures:

- Reorient or relocate the receiving antenna.
- Increase the separation between the equipment and receiver.
- Connect the equipment into an outlet on a circuit different from that to which the receiver is connected.
- Consult the dealer or an experienced radio/TV technician for help.
- The use of a non-shielded interface cable with the referenced device is prohibited.

FCC Caution: Any changes or modifications not expressly approved by the party responsible for compliance could void the user's authority to operate this equipment.

This device complies with Part 15 of the FCC Rules. Operation is subject to the following two conditions: (1) This device may not cause harmful interference, and (2) this device must accept any interference received, including interference that may cause undesired operation.

### IMPORTANT NOTE:

#### Radiation Exposure Statement:

This equipment complies with FCC radiation exposure limits set forth for an uncontrolled environment. This equipment should be installed and operated with minimum distance 20cm between the radiator & your body. This transmitter must not be co-located or operating in conjunction with any other antenna or transmitter.

These limits are designed to provide reasonable protection against harmful interference when the equipment is operated in a commercial environment. This equipment generates, uses, and can radiate radio frequency energy and, if not installed and used in accordance with the instruction manual, may cause harmful interference to radio communications.

### Industry Canada statement:

This device contains licence-exempt transmitter(s) / receiver(s) that complies with Innovation, Science and Economic Development Canada's licence-exempt RSS (s). Operation is subject to the following two conditions:

- (1) This device may not cause interference.
- (2) This device must accept any interference, including interference that may cause undesired operation of the device.

The antenna(s) used for this transmitter must be installed to provide a separation distance of at least 20 cm from all persons and must not be co-located or operating in conjunction with any other transmitter.

Industry Canada ICES-003 Compliance Label: CAN ICES-3B/NMB-3B

### Caution:

The device for operation in the band 5150-5250 MHz is only for indoor use to reduce the potential for harmful interference to co-channel mobile satellite systems;

Operations in the 5.25-5.35GHz band are restricted to indoor usage only.

### Radiation Exposure Statement:

This equipment complies with Canada radiation exposure limits set forth for an uncontrolled environment. This equipment should be installed and operated with minimum distance 20cm between the radiator & your body.

\* These above statements are valid in the United States of America, Canada and EU.

### For Singapore (IB-37)



### For Brazil

IB-37 e IB-38



18780-20-09076

Para maiores informações, consulte o site da ANATEL [www.anatel.gov.br](http://www.anatel.gov.br)

Este equipamento não tem direito à proteção contra interferência prejudicial e não pode causar interferência em sistemas devidamente autorizados.

### For Paraguay

IB-37

IB-38



NR: 2021-01-I-0031 NR: 2021-01-I-0032

## Radio Tag Technology

In some countries the radio tag technology used in this equipment to identify the toner container may be subject to authorization and the use of this equipment may consequently be restricted.

## Other precautions (for users in California, the United States)

Perchlorate Material - special handling may apply. See [www.dtsc.ca.gov/hazardouswaste/perchlorate](http://www.dtsc.ca.gov/hazardouswaste/perchlorate).

## Legal Restriction on Copying/Scanning

It may be prohibited to copy/scan copyrighted material without permission of the copyright owner.

Copying/Scanning the following items is prohibited and may be penalized by law. It may not be limited to these items. Do not knowingly copy/scan the items that are not to be copied/scanned.

- Paper money
- Bank note
- Securities
- Stamp
- Passport
- Certificate

Local laws and regulations may prohibit or restrict copying/scanning of other items not mentioned above.

## EN ISO 7779

Maschinenlärminformations-Verordnung 3. GPSGV, 06.01.2004: Der höchste Schalldruckpegel beträgt 70 dB (A) oder weniger gemäß EN ISO 7779.

## EK1-ITB 2000

Das Gerät ist nicht für die Benutzung im unmittelbaren Gesichtsfeld am Bildschirmarbeitsplatz vorgesehen. Um störende Reflexionen am Bildschirmarbeitsplatz zu vermeiden, darf dieses Produkt nicht im unmittelbaren Gesichtsfeld platziert werden.

## Wireless Connection (Mexico only)

The operation of this equipment is subject to the following two conditions:

(1) it is possible that this equipment or device may not cause harmful interference, and (2) this equipment or device must accept any interference, including interference that may cause undesired operation.

La operación de este equipo está sujeta a las siguientes dos condiciones:

(1) es posible que este equipo o dispositivo no cause interferencia perjudicial y (2) este equipo o dispositivo debe aceptar cualquier interferencia, incluyendo la que pueda causar su operación no deseada.

## Security Precautions when Using Wireless LAN (If equipped)

Wireless LAN allows information to be exchanged between wireless access points instead of using a network cable, which offers the advantage that a LAN connection can be established freely within an area in which radio waves can be transmitted.

On the other hand, the following problems may occur if security settings are not configured, because radio waves can pass through obstacles (including walls) and reach everywhere within a certain area.

## Secretly Viewing Communication Contents

A third person with malicious objectives may intentionally monitor radio waves and gain unauthorized access to the following communication contents.

- Personal information including ID, passwords, and credit card numbers
- Contents of email messages

## Illegal Intrusion

A third party with malicious intent may gain unauthorized access to personal or company networks and conduct the following illegal actions.

- Extracting personal and confidential information (information leak)
- Entering into communication while impersonating a specific person and distributing unauthorized information (spoofing)
- Modifying and retransmitting intercepted communications (falsification)
- Transmitting computer viruses and destroying data and systems (destruction)

Wireless LAN cards and wireless access points contain built-in security mechanisms to address these problems and to reduce the possibility of these problems occurring by configuring the security settings of wireless LAN products when the product is used.

We recommend that customers take responsibility and use their judgment when configuring the security settings and that they ensure that they fully understand the problems that can occur when the product is used without configuring the security settings.

## Limited Use of This Product (If equipped)

- Radio waves transmitted from this product may affect medical equipment. When using this product in a medical institution or in the vicinity of medical instruments, either use this product according to the instructions and precautions provided by the administrator of the institution or those provided on the medical instruments.
- Radio waves transmitted from this product may affect automatic control equipment including automatic doors and fire alarms. When using this product in the vicinity of the automatic control equipment, use this product according to the instructions and precautions provided on the automatic control equipment.
- If this product is used in devices that are directly related to service including airplanes, trains, ships, and automobiles or this product is used in applications requiring high reliability and safety to function and in devices requiring accuracy including those used in disaster prevention and crime prevention and those used for various safety purposes, please use this product after considering the safety design of the entire system including adoption of a failsafe design and redundancy design for reliability and safety maintenance of the entire system. This product is not intended for use in applications requiring high reliability and safety including aerospace instruments, trunk communication equipment, nuclear power control equipment, and medical equipment; hence, the decision as to whether to use this product in these applications needs to be fully considered and determined.

## Sólo México (Mexico only)

Este equipo utiliza el módulo de interfaz de red inalámbrica modelo LBWA1ZZ1CA para conectarse a las redes Inalámbricas.



## Legal Information

Copying or other reproduction of all or part of this guide without the prior written consent of KYOCERA Document Solutions Inc. is prohibited.

### Regarding Trade Names

- PRESCRIBE and ECOSYS are registered trademark of Kyocera Corporation.
- KPDL is a trademark of Kyocera Corporation.
- Active Directory, Azure, Microsoft, Microsoft 365, Microsoft Edge, Windows and Windows Server are registered trademarks or trademarks of Microsoft Corporation in the U.S. and/or other countries.
- PCL is a trademark of Hewlett-Packard Company.
- Adobe, Acrobat, PostScript, and Reader are either registered trademarks or trademarks of Adobe in the U.S. and/or other countries.
- Ethernet is a registered trademark of FUJIFILM Business Innovation Corporation.
- IBM and IBM PC/AT are trademarks of International Business Machines Corporation.
- AirPrint, the AirPrint logo, AppleTalk, Bonjour, iPad, iPhone, iPod touch, Mac, Mac OS and TrueType are trademarks of Apple Inc., registered in the U.S. and other countries.
- All European language fonts installed in this machine are used under licensing agreement with Monotype Imaging Inc.
- Helvetica, Palatino and Times are registered trademarks of Linotype GmbH.
- ITC Avant Garde Gothic, ITC Bookman, ITC ZapfChancery and ITC ZapfDingbats are registered trademarks of International Typeface Corporation.
- ThinPrint is a registered trademark or trademark of Cortado AG in Germany and other countries.
- UFST™ MicroType® fonts by Monotype Imaging Inc. are installed in this machine.
- iOS is a registered trademark or trademark of Cisco in the U.S. and other countries and is used under license by Apple Inc.
- Google is a registered trademark and/or trademark of Google LLC.
- Mopria and Mopira logo are registered trademarks or trademarks of Mopria Alliance, Inc. in the U.S. and/or other countries.
- Wi-Fi, Wi-Fi Direct and Wi-Fi Protected Setup are registered trademarks and/or trademarks of Wi-Fi Alliance.
- RealVNC, VNC and RFB are registered trademarks or trademarks of RealVNC Ltd. in the U.S. and/or other countries.

All other brands and product names are registered trademarks or trademarks of their respective companies. The designations ™ and ® will not be used in this Operation Guide.

## Monotype Imaging License Agreement

- 1 *Software* shall mean the digitally encoded, machine readable, scalable outline data as encoded in a special format as well as the UFST Software.
- 2 You agree to accept a non-exclusive license to use the Software to reproduce and display weights, styles and versions of letters, numerals, characters and symbols (*Typefaces*) solely for your own customary business or personal purposes at the address stated on the registration card you return to Monotype Imaging. Under the terms of this License Agreement, you have the right to use the Fonts on up to three printers. If you need to have access to the fonts on more than three printers, you need to acquire a multiuser license agreement which can be obtained from Monotype Imaging. Monotype Imaging retains all rights, title and interest to the Software and Typefaces and no rights are granted to you other than a License to use the Software on the terms expressly set forth in this Agreement.
- 3 To protect proprietary rights of Monotype Imaging, you agree to maintain the Software and other proprietary information concerning the Typefaces in strict confidence and to establish reasonable procedures regulating access to and use of the Software and Typefaces.
- 4 You agree not to duplicate or copy the Software or Typefaces, except that you may make one backup copy. You agree that any such copy shall contain the same proprietary notices as those appearing on the original.
- 5 This License shall continue until the last use of the Software and Typefaces, unless sooner terminated. This License may be terminated by Monotype Imaging if you fail to comply with the terms of this License and such failure is not remedied within thirty (30) days after notice from Monotype Imaging. When this License expires or is terminated, you shall either return to Monotype Imaging or destroy all copies of the Software and Typefaces and documentation as requested.
- 6 You agree that you will not modify, alter, disassemble, decrypt, reverse engineer or decompile the Software.
- 7 Monotype Imaging warrants that for ninety (90) days after delivery, the Software will perform in accordance with Monotype Imaging-published specifications, and the diskette will be free from defects in material and workmanship. Monotype Imaging does not warrant that the Software is free from all bugs, errors and omissions.  
  
The parties agree that all other warranties, expressed or implied, including warranties of fitness for a particular purpose and merchantability, are excluded.
- 8 Your exclusive remedy and the sole liability of Monotype Imaging in connection with the Software and Typefaces is repair or replacement of defective parts, upon their return to Monotype Imaging.  
  
In no event will Monotype Imaging be liable for lost profits, lost data, or any other incidental or consequential damages, or any damages caused by abuse or misapplication of the Software and Typefaces.
- 9 Massachusetts U.S.A. law governs this Agreement.
- 10 You shall not sublicense, sell, lease, or otherwise transfer the Software and/or Typefaces without the prior written consent of Monotype Imaging.
- 11 Use, duplication or disclosure by the Government is subject to restrictions as set forth in the Rights in Technical Data and Computer Software clause at FAR 252-227-7013, subdivision (b)(3)(ii) or subparagraph (c)(1)(ii), as appropriate. Further use, duplication or disclosure is subject to restrictions applicable to restricted rights software as set forth in FAR 52.227-19 (c)(2).
- 12 You acknowledge that you have read this Agreement, understand it, and agree to be bound by its terms and conditions. Neither party shall be bound by any statement or representation not contained in this Agreement. No change in this Agreement is effective unless written and signed by properly authorized representatives of each party. By opening this diskette package, you agree to accept the terms and conditions of this Agreement.

## Open Source Software License

For the "Open Source Software license, go into the following URL and select Country > Product Name > OS > Language and then, refer to the "OSS\_Notice" from the manual tab in the "Download".  
<https://kyocera.info/>

## Energy Saving Control Function

The device comes equipped with a **Sleep** where printer and fax functions remain in a waiting state but power consumption is reduced to a minimum after a certain amount of time elapses since the device was last used.

### Sleep

The device automatically enters Sleep when 1 minute has passed since the device was last used. The amount of time of no activity that must pass before Sleep is activated may be lengthened.

➔ [Sleep \(page 2-46\)](#)

## Automatic 2-Sided Print Function

This device includes 2-sided printing as a standard function. For example, by printing two 1-sided originals onto a single sheet of paper as a 2-sided print, it is possible to lower the amount of paper used.

➔ [Duplex \(page 6-25\)](#)

Printing in duplex mode reduces paper consumption and contributes to the conservation of forest resources. Duplex mode also reduces the amount of paper that must be purchased, and thereby reduces cost. It is recommended that machines capable of duplex printing be set to use duplex mode by default.

## Resource Saving - Paper

For the preservation and sustainable use of forest resources, it is recommended that recycled as well as virgin paper certified under environmental stewardship initiatives or carrying recognised ecolabels, which meet EN 12281:2002\* or an equivalent quality standard, be used.

This machine also supports printing on 64 g/m<sup>2</sup> paper. Using such paper containing less raw materials can lead to further saving of forest resources.

\* : EN12281:2002 "Printing and business paper - Requirements for copy paper for dry toner imaging processes"

Your sales or service representative can provide information about recommended paper types.

## Environmental benefits of "Power Management"

To reduce power consumption when idle, this machine is equipped with a power management function that automatically activates energy-saving mode when the machine is idle for a certain period of time.

Although it takes the machine a slight amount of time to return to READY mode when in energy-saving mode, a significant reduction in energy consumption is possible. It is recommended that the machine be used with the activation time for energy-saving mode set to the default setting.

## Energy Star (ENERGY STAR®) Program

We participate in the ENERGY STAR® Program.

We provide the products complied with ENERGY STAR® to the market.

ENERGY STAR® is an energy efficiency program with the goal of developing and promoting the use of products with high energy efficiency in order to help prevent global warming. By purchasing the products complied with ENERGY STAR®, customers can help reduce emissions of greenhouse gases during product use and cut energy-related costs.

## Warranty (the United States and Canada)

### **ECOSYS MA4500ifx / ECOSYS MA4500ix MULTIFUNCTIONAL PRODUCT LIMITED WARRANTY**

KYOCERA Document Solutions America, Inc. and KYOCERA Document Solutions Canada, Ltd. (both referred to as "KYOCERA") warrant the Customer's new Multifunctional Product (referred to as "MFP"), and the new accessories installed with the initial installation of the MFP, against any defects in material and workmanship for a period of one year, or 300,000 copies/prints from date of installation, whichever first occurs. In the event the MFP or an accessory is found to be defective within the warranty period, KYOCERA's only obligation and the Customer's exclusive remedy shall be replacement of any defective parts. KYOCERA shall have no obligation to furnish labor.

This warranty is valid only for the original retail purchaser (referred to as the "Customer") of a new KYOCERA MFP in the United States of America or Canada, based upon the country of purchase.

In order to obtain performance of this warranty, the Customer must immediately notify the Authorized KYOCERA Dealer from whom the product was purchased. If the KYOCERA Dealer is not able to provide service, write to KYOCERA at the address below for the name and address of the Authorized KYOCERA Dealer in your area, or check KYOCERA's website at

<http://www.kyoceradocumentsolutions.com/us> for KYOCERA Document Solutions America, Inc. or <http://www.kyoceradocumentsolutions.ca> for KYOCERA Document Solutions Canada, Ltd.

This warranty does not cover MFPs or accessories which: (a) have become damaged due to operator negligence, misuse, accidents, improper storage or unusual physical or electrical stress, (b) have used parts or supplies which are not genuine KYOCERA brand parts or supplies, (c) have been installed or serviced by a technician not employed by KYOCERA or an Authorized KYOCERA Dealer, or (d) have had the serial number modified, altered, or removed.

This warranty gives the Customer specific legal rights. The Customer may also have other rights, which vary from state to state, or province to province. Neither the seller, nor any other person, is authorized to extend the time period or expand this warranty on behalf of KYOCERA.

THIS WARRANTY IS MADE IN LIEU OF ALL OTHER WARRANTIES AND CONDITIONS, EXPRESS OR IMPLIED, AND KYOCERA SPECIFICALLY DISCLAIMS ANY IMPLIED WARRANTY OR CONDITION OF MERCHANTABILITY OR FITNESS FOR A PARTICULAR PURPOSE. THIS WARRANTY SHALL NOT EXTEND TO, AND KYOCERA SHALL NOT BE LIABLE FOR, ANY INCIDENTAL OR CONSEQUENTIAL DAMAGES WHICH MAY ARISE OUT OF THE USE OF, OR INABILITY TO USE, THE MFP.

#### **KYOCERA Document Solutions America, Inc.**

225 Sand Road,  
Fairfield, New Jersey 07004-0008, USA

#### **KYOCERA Document Solutions Canada, Ltd.**

6120 Kestrel Rd., Mississauga, ON L5T 1S8,  
Canada

**ECOSYS MA6000ifx / ECOSYS MA5500ifx  
MULTIFUNCTIONAL PRODUCT LIMITED WARRANTY**

KYOCERA Document Solutions America, Inc. and KYOCERA Document Solutions Canada, Ltd. (both referred to as "KYOCERA") warrant the Customer's new Multifunctional Product (referred to as "MFP"), and the new accessories installed with the initial installation of the MFP, against any defects in material and workmanship for a period of one year, or 500,000 copies/prints from date of installation, whichever first occurs. In the event the MFP or an accessory is found to be defective within the warranty period, KYOCERA's only obligation and the Customer's exclusive remedy shall be replacement of any defective parts. KYOCERA shall have no obligation to furnish labor.

This warranty is valid only for the original retail purchaser (referred to as the "Customer") of a new KYOCERA MFP in the United States of America or Canada, based upon the country of purchase.

In order to obtain performance of this warranty, the Customer must immediately notify the Authorized KYOCERA Dealer from whom the product was purchased. If the KYOCERA Dealer is not able to provide service, write to KYOCERA at the address below for the name and address of the Authorized KYOCERA Dealer in your area, or check KYOCERA's website at <http://www.kyoceradocumentsolutions.com/us> for KYOCERA Document Solutions America, Inc. or <http://www.kyoceradocumentsolutions.ca> for KYOCERA Document Solutions Canada, Ltd.

This warranty does not cover MFPs or accessories which: (a) have become damaged due to operator negligence, misuse, accidents, improper storage or unusual physical or electrical stress, (b) have used parts or supplies which are not genuine KYOCERA brand parts or supplies, (c) have been installed or serviced by a technician not employed by KYOCERA or an Authorized KYOCERA Dealer, or (d) have had the serial number modified, altered, or removed.

This warranty gives the Customer specific legal rights. The Customer may also have other rights, which vary from state to state, or province to province. Neither the seller, nor any other person, is authorized to extend the time period or expand this warranty on behalf of KYOCERA.

THIS WARRANTY IS MADE IN LIEU OF ALL OTHER WARRANTIES AND CONDITIONS, EXPRESS OR IMPLIED, AND KYOCERA SPECIFICALLY DISCLAIMS ANY IMPLIED WARRANTY OR CONDITION OF MERCHANTABILITY OR FITNESS FOR A PARTICULAR PURPOSE. THIS WARRANTY SHALL NOT EXTEND TO, AND KYOCERA SHALL NOT BE LIABLE FOR, ANY INCIDENTAL OR CONSEQUENTIAL DAMAGES WHICH MAY ARISE OUT OF THE USE OF, OR INABILITY TO USE, THE MFP.

**KYOCERA Document Solutions America, Inc.**

225 Sand Road,  
Fairfield, New Jersey 07004-0008, USA

**KYOCERA Document Solutions Canada, Ltd.**

6120 Kestrel Rd., Mississauga, ON L5T 1S8,  
Canada

# 2 Installing and Setting up the Machine

This chapter provides information for the administrator of this machine, such as part names, cable connection, and software installation.

Part Names .....	2-2	Sleep Level (Energy Saver and Quick Recovery) (models except for Europe) .....	2-47
Machine Exterior .....	2-2	Energy Saver Recovery Level .....	2-48
Connectors/Interior .....	2-4	Weekly Timer Settings .....	2-48
With Optional Equipments Attached .....	2-7	Power Off Timer (models for Europe) .....	2-48
Connecting the Machine and Other Devices .....	2-8	Quick Setup Wizard .....	2-49
Connecting Cables .....	2-9	Configuring Settings Quick Setup Wizard .....	2-51
Connecting LAN Cable .....	2-9	Installing Software .....	2-52
Connecting USB Cable .....	2-10	Published Software (Windows) .....	2-52
Connecting the Power Cable .....	2-10	Installing Software in Windows .....	2-53
Power On/Off .....	2-11	Uninstalling the Software .....	2-59
Power On .....	2-11	Installing Software in Mac Computer .....	2-60
Power Off .....	2-11	Setting TWAIN Driver .....	2-64
Using the Operation Panel .....	2-12	Setting WIA Driver .....	2-66
Operation Panel Keys .....	2-12	Checking the Counter .....	2-67
Adjusting the Operation Panel Angle .....	2-13	Additional Preparations for the Administrator .....	2-68
Touch Panel .....	2-14	Administrator Privileges Overview .....	2-68
Using the Touch Panel .....	2-14	Log in as Machine Administrator or Administrator .....	2-68
Home Screen .....	2-17	Strengthening the Security .....	2-69
Assigning Functions to Function Keys .....	2-22	Command Center RX .....	2-71
Display for Device Information .....	2-23	Accessing Command Center RX .....	2-72
Display Setting Screen .....	2-24	Changing Security Settings .....	2-73
Display of Keys That Cannot Be Set .....	2-26	Changing Device Information .....	2-74
Original Preview .....	2-27	E-mail Settings .....	2-75
Help Screen .....	2-31	Registering Destinations .....	2-78
Accessibility Functions (Magnifying the View) .....	2-32	Creating a New Custom Box .....	2-79
Login/Logout .....	2-33	Printing a document stored in a Custom Box .....	2-80
Login .....	2-33	Transferring Data from Our Other Products .....	2-81
Simple Login .....	2-34	Migrating the Address Book .....	2-81
Logout .....	2-34		
Default Settings of the Machine .....	2-35		
Setting Date and Time .....	2-35		
Network Setup .....	2-36		
Configuring the Wired Network .....	2-36		
Configuring the Wireless Network .....	2-38		
Setting Wi-Fi Direct .....	2-44		
Energy Saver function .....	2-46		
Low Power Mode .....	2-46		
Sleep .....	2-46		
Sleep Rules (models for Europe) .....	2-47		

# Part Names

## Machine Exterior

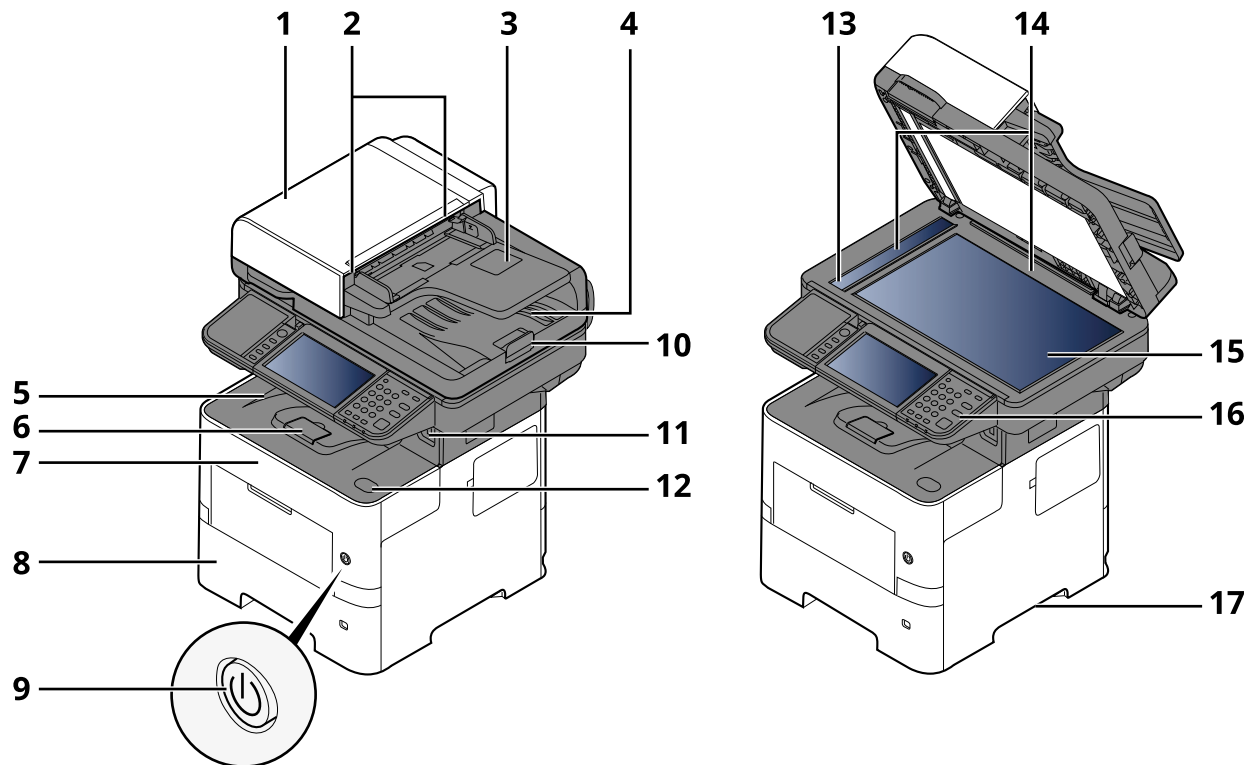

- 1 Document Processor
- 2 Original Width Guides
- 3 Original Table
- 4 Original Eject Table
- 5 Inner Tray
- 6 Paper Stopper
- 7 Front Cover
- 8 Cassette 1
- 9 Power Switch
- 10 Original Stopper
- 11 USB Drive Slot
- 12 Front Cover Open Button
- 13 Slit Glass
- 14 Original Size Indicator Plates
- 15 Platen
- 16 Operation Panel
- 17 Handles

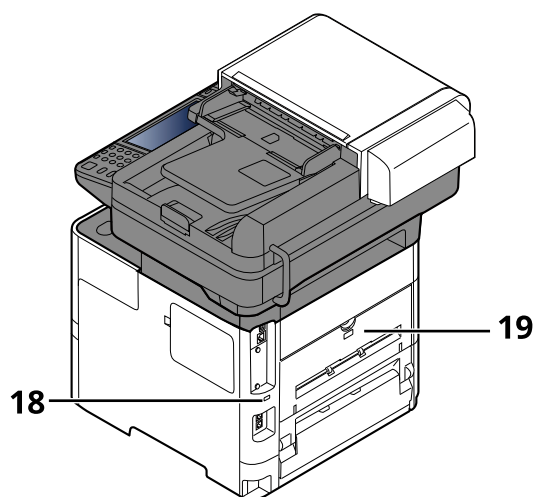

18 Anti-theft Lock Slot

19 Rear Cover



## Connectors/Interior

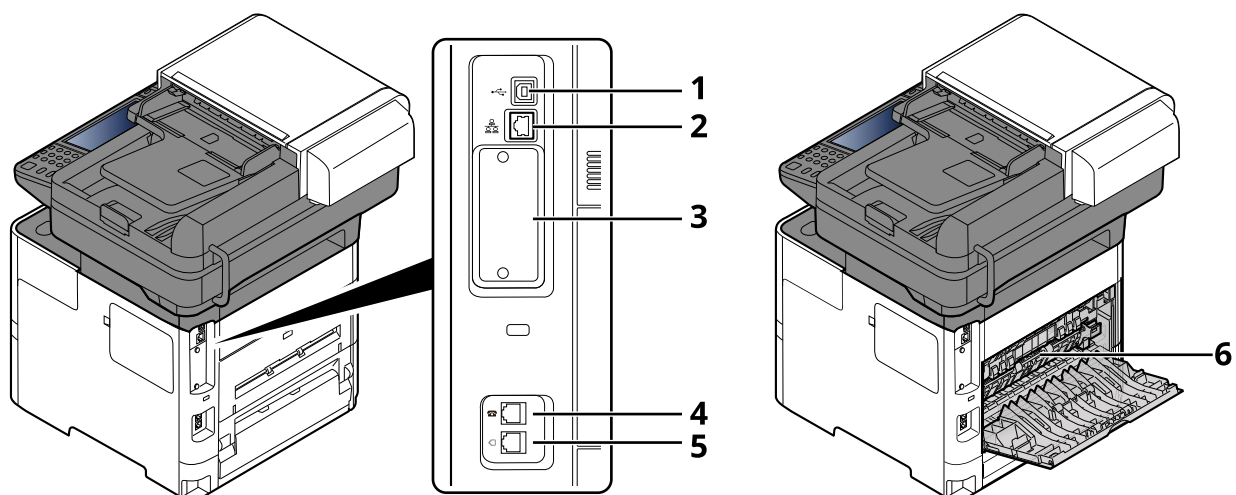

- 1 USB Interface Connector
- 2 Network Interface Connector
- 3 Option Interface Slot
- 4 TEL Connector
- 5 LINE Connector
- 6 Fuser Cover

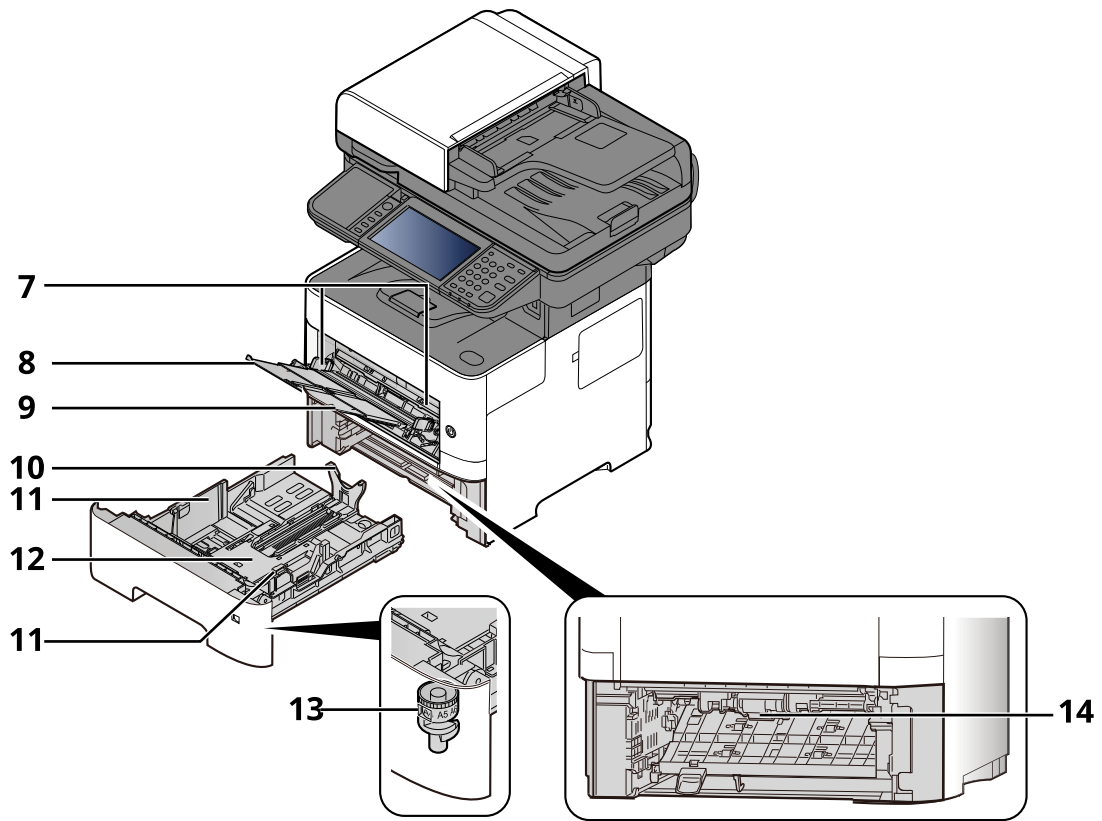

- 7 Paper Width Guides
- 8 Tray Extension
- 9 Multi Purpose Tray
- 10 Paper Length Guide
- 11 Paper Width Guides
- 12 Bottom Plate
- 13 Size Dial
- 14 Duplex Cover

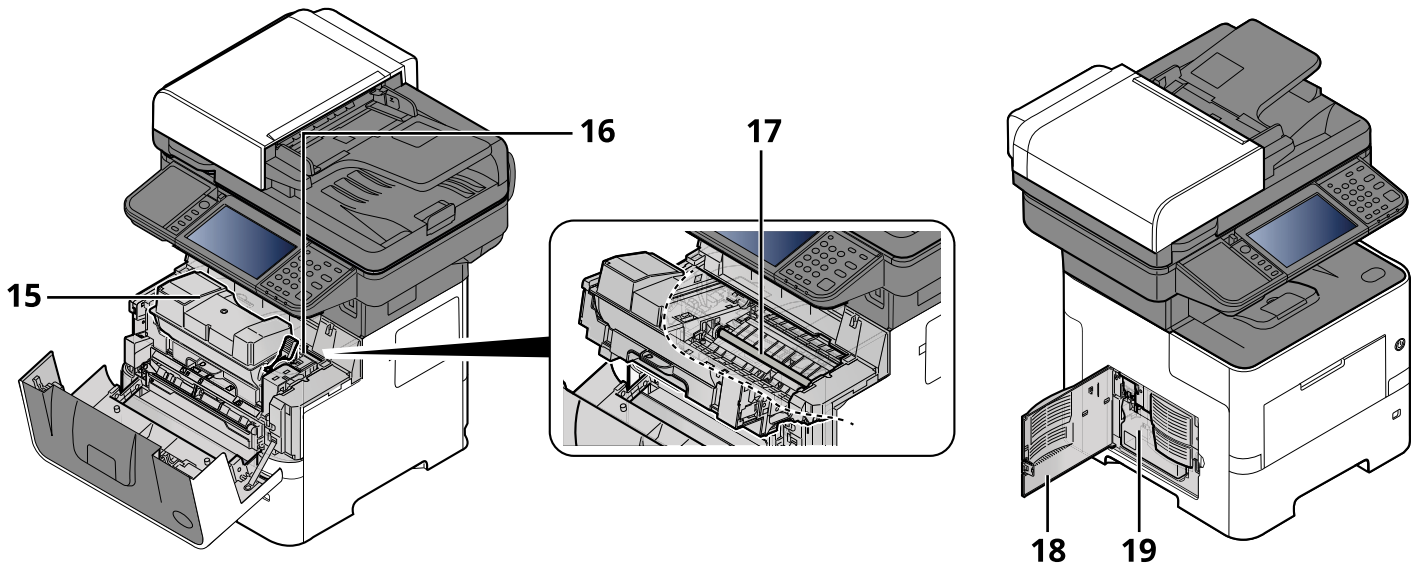

- 15 Toner Container
- 16 Toner Container Lock Lever
- 17 Registration Roller
- 18 Left Cover
- 19 Waste Toner Box

## With Optional Equipments Attached

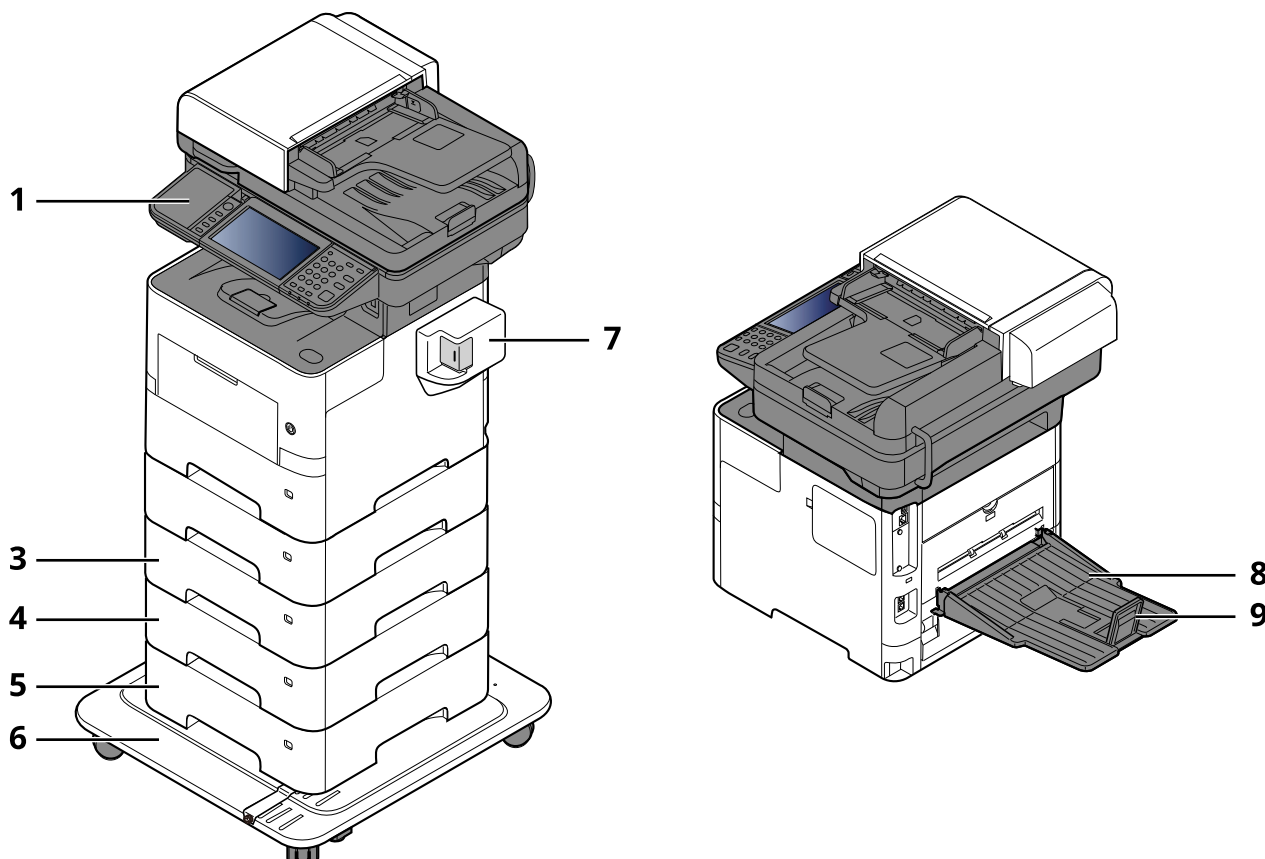

- 1 Card Reader
- 2 Cassette 2
- 3 Cassette 3
- 4 Cassette 4
- 5 Cassette 5
- 6 CA-3100
- 7 Manual Stapler  
(ECOSYS MA6000ifx and ECOSYS MA5500ifx only)
- 8 Rear Tray  
(ECOSYS MA6000ifx and ECOSYS MA5500ifx only)
- 9 Paper Stopper  
(ECOSYS MA6000ifx and ECOSYS MA5500ifx only)

➔ [Optional Equipment \(page 11-2\)](#)

# Connecting the Machine and Other Devices

Prepare the cables necessary to suit the environment and purpose of the machine use.

## When Connecting the Machine to the PC via USB

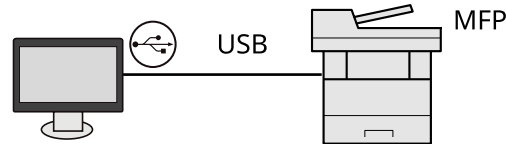

## When Connecting the Machine to the PC or Tablet by network cable, Wi-Fi, or Wi-Fi direct

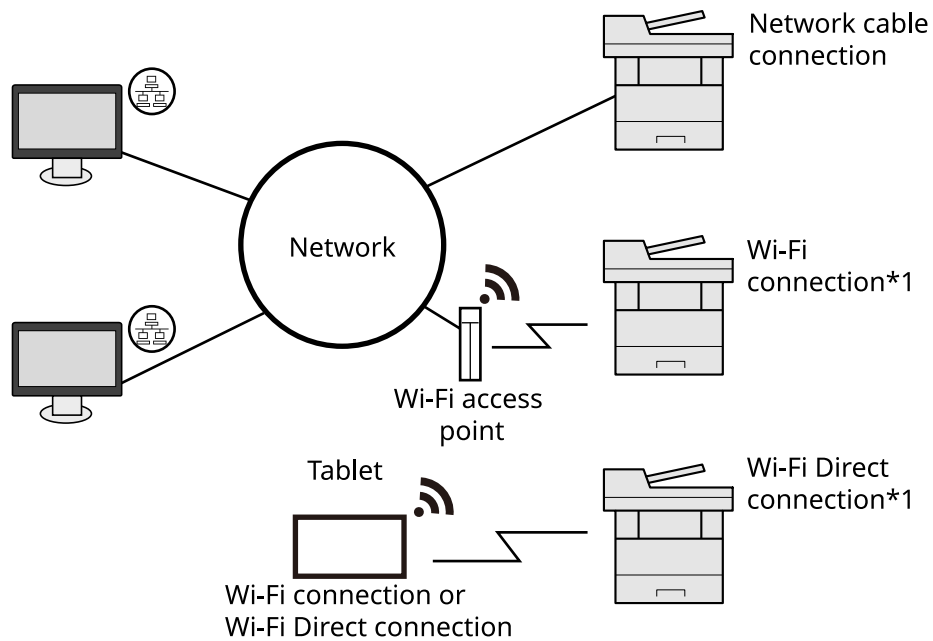

\*1 Only for models with the optional Wireless Network Interface Kit (IB-37/IB-38).

### NOTE

If you are using wireless LAN, refer to the following.

➔ [Configuring the Wireless Network \(page 2-38\)](#)

## Cables that Can Be Used

Connection Environment	Function	Necessary Cable
Connect a LAN cable to the machine.	Printer/Scanner/Network FAX	LAN cable (10BASE-T, 100BASE-TX, 1000BASE-T)
Connect a USB cable to the machine.	Printer/Scanner (TWAIN/WIA)	USB 2.0 compatible cable (Hi-Speed USB compliant, max. 5.0 m , shielded)

### IMPORTANT

Using a cable other than a USB 2.0 compatible cable may cause failure.

# Connecting Cables

## Connecting LAN Cable

✔ **IMPORTANT**

If the power is on, turn the power switch off.

➔ [Power Off \(page 2-11\)](#)

### 1 Connect the cable to the machine.

- 1 Connect the LAN cable to the network interface connector.

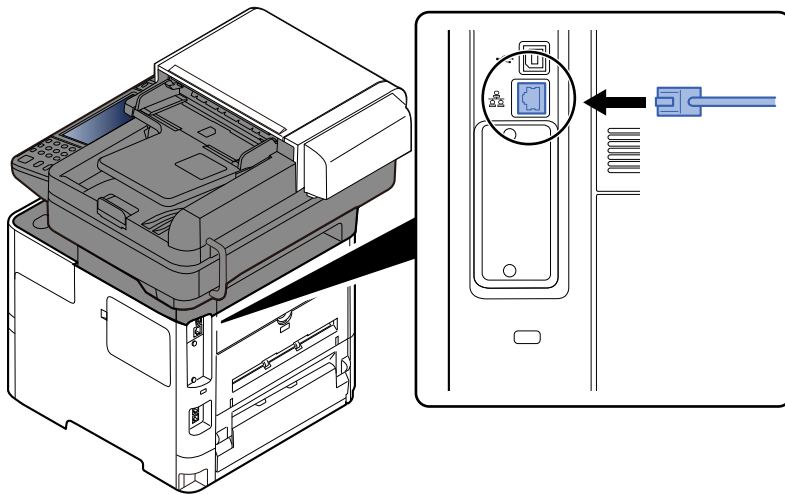

- 2 Connect the other end of the cable to the hub.

### 2 Power on the machine and configure the network.

➔ [Network Setup \(page 2-36\)](#)

## Connecting USB Cable

✔ **IMPORTANT**

If the power is on, turn the power switch off.

➔ [Power Off \(page 2-11\)](#)

### 1 Connect the cable to the machine.

- 1 Connect the USB cable to the USB interface connector located on the left side of the body.

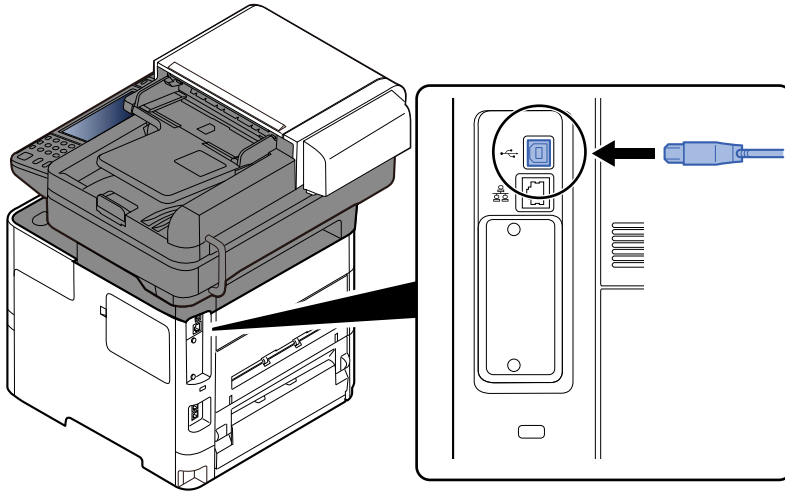

- 2 Connect the other end of the cable to the PC.

### 2 Power on the machine.

## Connecting the Power Cable

### 1 Connect the cable to the machine.

Connect one end of the supplied power cable to the machine and the other end to a power outlet.

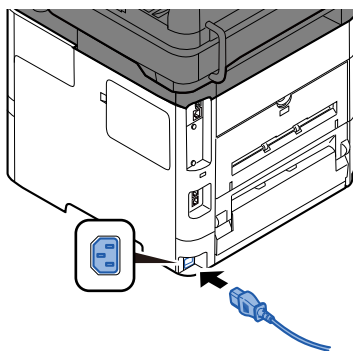

✔ **IMPORTANT**

Only use the power cable that comes with the machine.

# Power On/Off

## Power On

- 1 Turn the power switch on.

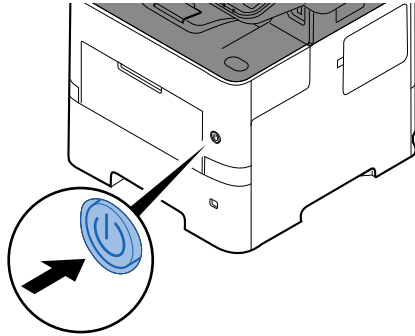

✔ **IMPORTANT**

When turning off the power switch, do not turn on the power switch again immediately. Wait more than 5 seconds, and then turn on the power switch.

## Power Off

- 1 Turn the power switch off.

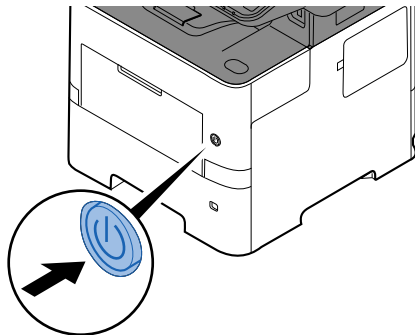

The confirmation message for power supply off is displayed.

➔ [Show Power Off Message \(page 8-10\)](#)

It takes approximately 3 minutes for power off.

**⚠ CAUTION**

If this machine will be left unused for an extended period (e.g. overnight), turn it off at the main power switch. If the machine will not be used for an even longer period of time (e.g. vacation), remove the power plug from the outlet as a safety precaution.

✔ **IMPORTANT**

- If using the products equipped with the fax function, note that turning the machine off at the main power switch disables fax transmission and reception.
- Remove paper from the cassettes and seal it in the paper storage bag to protect it from humidity.



# Using the Operation Panel

## Operation Panel Keys

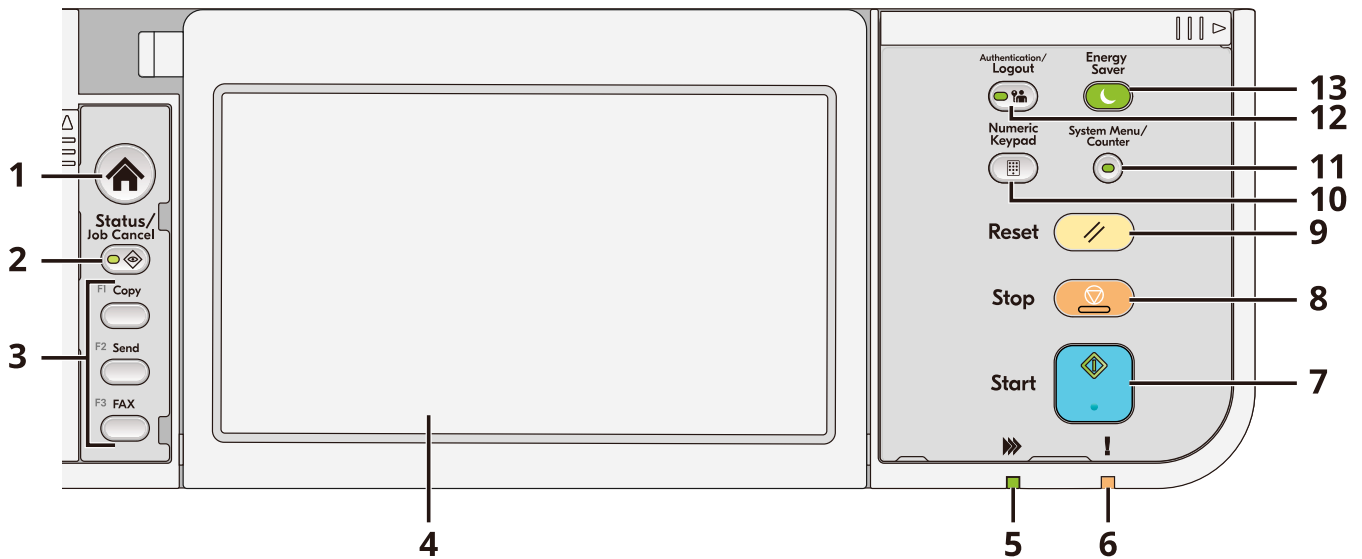

- 1 **[Home]** key: Displays the Home screen.
- 2 **[Status/Job Cancel]** key: Displays the Status/Job Cancel screen.
- 3 **Function Keys:** Keys to which various functions and applications, including copy and scan, can be assigned.  
➔ [Function Key Assignment \(page 8-19\)](#)
- 4 **Touch panel:** The touch panel. Touch the keys here to configure various settings.
- 5 **[Processing]** indicator: Blinks during printing or transmission.
- 6 **[Attention]** indicator: Lights or blinks when an error occurs and a job is stopped.
- 7 **[Start]** key: Starts copying and scanning operations and processing for setting operations.
- 8 **[Stop]** key: Cancels or pauses the job in progress.
- 9 **[Reset]** key: Returns settings to their default states.
- 10 **[Numeric Keypad]** key: Calls the numeric keypad when typing a number or a symbol.
- 11 **[System Menu/Counter]** key: Displays the System Menu/Counter screen.
- 12 **[Authentication/Logout]** key: Authenticates user switching and finishes (logs out) the operation for each user.
- 13 **[Energy Saver]** key: Puts the machine into Sleep Mode. Recovers from sleep when in Sleep Mode.

## Adjusting the Operation Panel Angle

The angle of the operation panel can be adjusted.

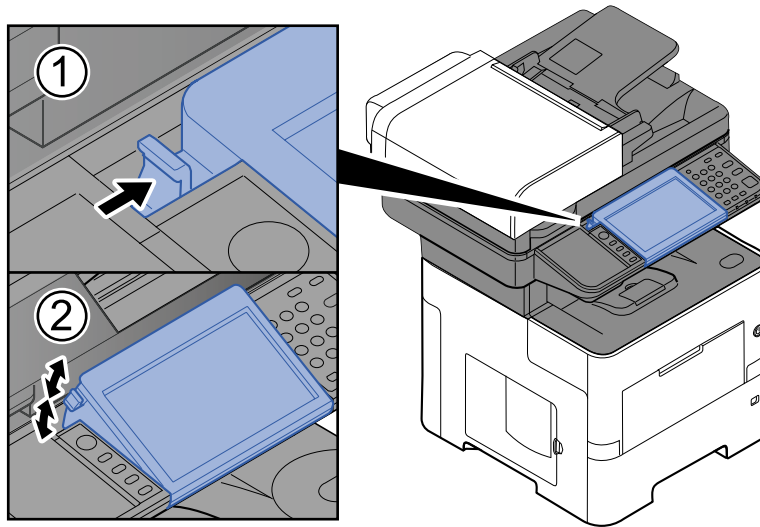

# Touch Panel

## Using the Touch Panel

This section explains the basic operation of the touch panel.

### Tapping

This is the operation used to select an icon or key.

In this document, the tap operation is expressed as "select."

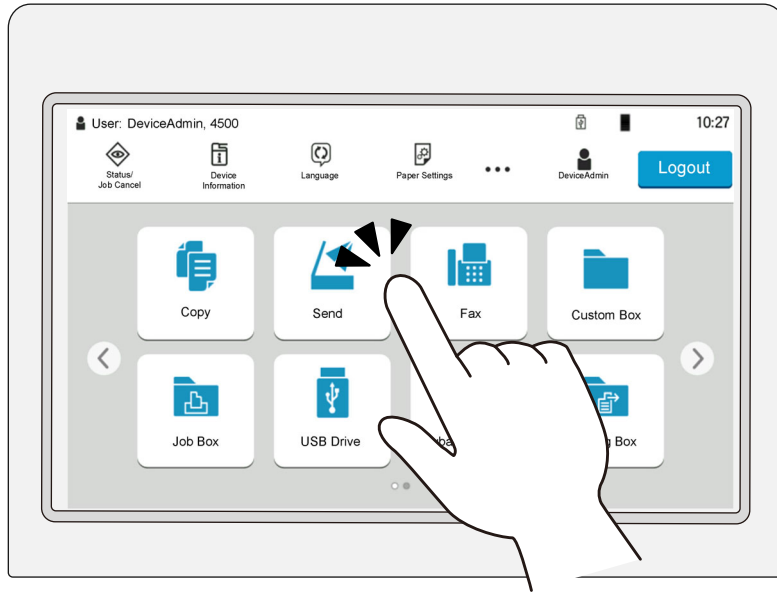

### Popover

Tap the icons and keys to display detailed information on the icons and menus. A popover displays information and menus without switching between screens.

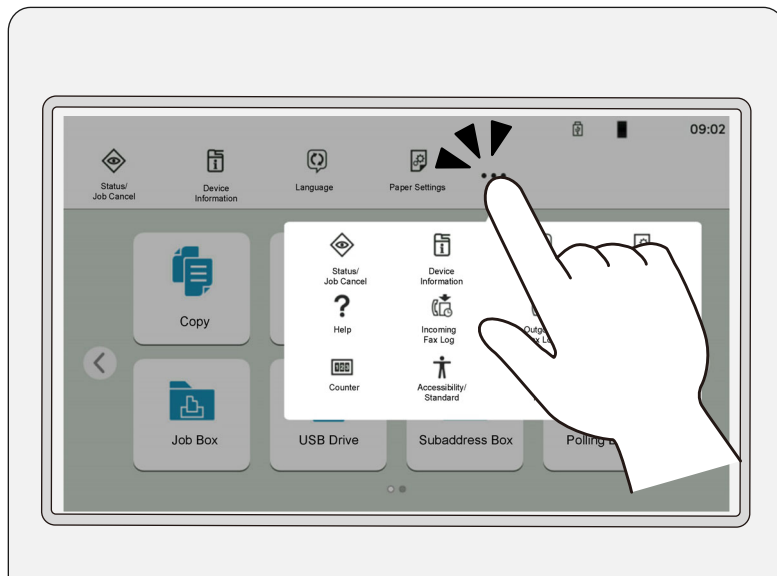

## Swiping

This is the operation used to switch between screens and to display items that are not displayed in the list. Move in one direction as if tracing on the screen.

### Example: Home Screen

Move the screen to the left and right.

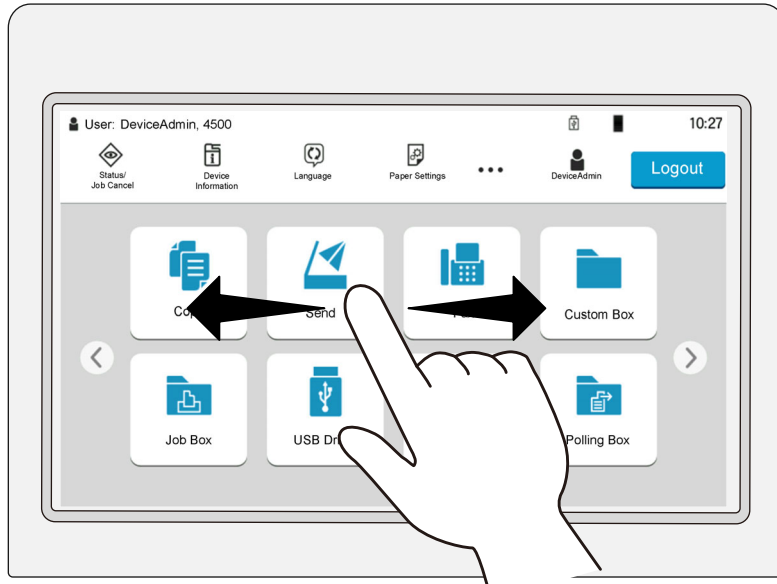

### Example: System Menu Screen

Move the screen up and down.

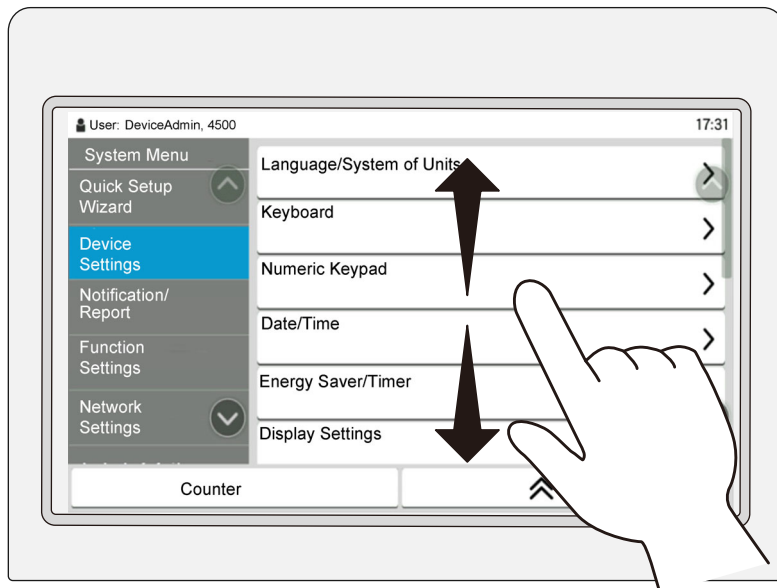

## Operating the touch panel

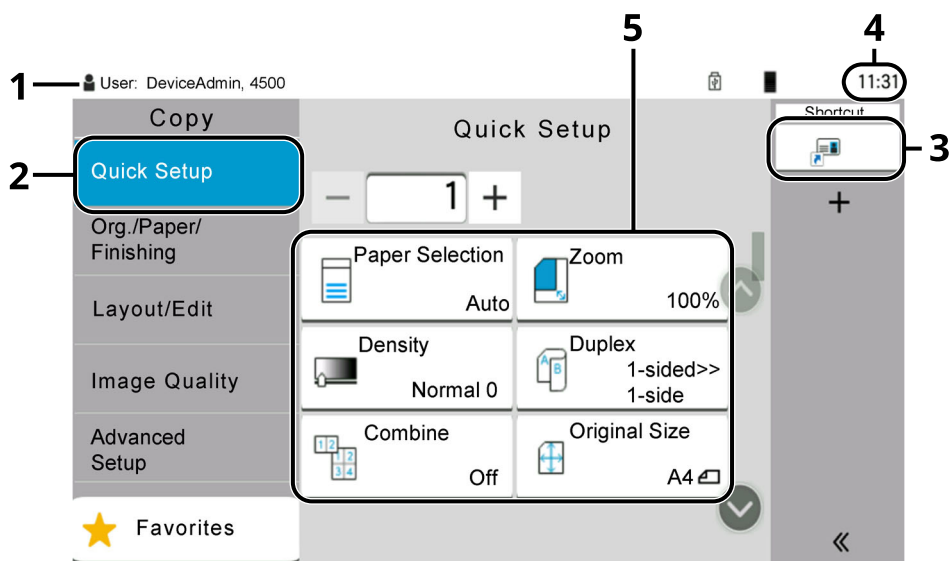

- 1 Displays the status of the equipment as well as necessary operation messages.
- 2 Displays the Quick Setup screen.
- 3 Displays registered shortcuts.
- 4 Displays the time.
- 5 Set the copy functions.

## Home Screen

This screen is displayed by selecting the [**Home**] key on the operation panel. Touching an icon will display the corresponding screen.

You can change the icons to display on the Home screen as well as its background.

➔ [Editing the Home Screen \(page 2-19\)](#)

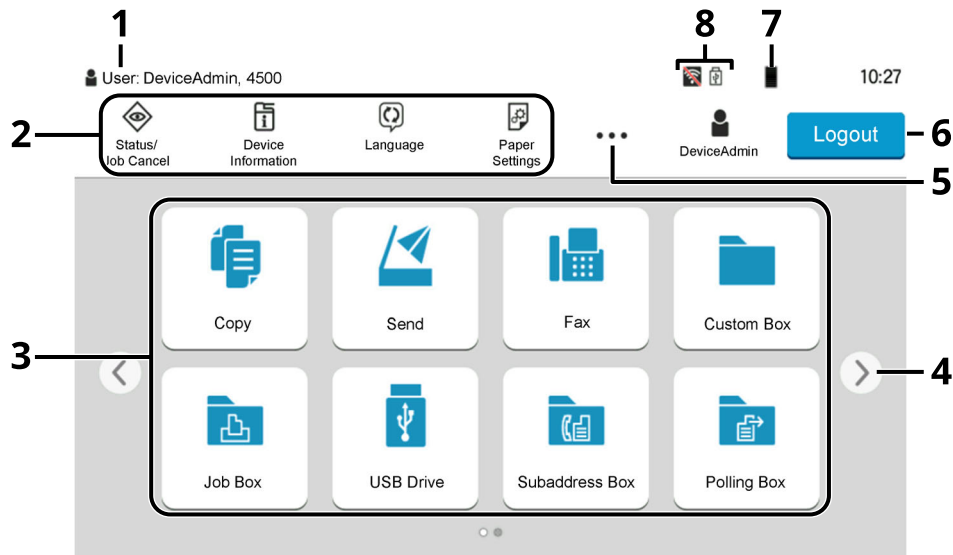

\* The appearance may differ from your actual screen, depending on your configuration and option settings.

No.	Item	Description
1	Status Area	Displays the messages and status icons for the current status. Displays the logged-in user name when user login administration is enabled.
2	Taskbar	Displays task icons. If an error occurs, the [Status/Job Cancel] icon will show "!" . is displayed. Once the error clears, the display will return to normal.
3	Desktop	Displays the application icons. Also displays registered favorite features. Icons that are not displayed on the first page will appear by changing the page.
4	Screen-switching keys	Use these buttons to switch between desktop pages.  <b>NOTE</b> It is also possible to use swiping to switch between displays. ➔ <a href="#">Using the Touch Panel (page 2-14)</a>
5	[...]	Displays every task icons including the icons displayed in an taskbar area in a popover.
6	[Login] / [Logout]	Logs in or logs out when user login administration is enabled.
7	Remaining amount of toner	Displays the remaining amount of toner. Select this icon to display details of the remaining amount of toner in a popover.

No.	Item	Description
8	Sub status icons	Displays the icons that indicate the status of the machine. 5 icons can be displayed. Select this area to display the icon information in a popover.
	Status Icon (Wi-Fi)	The icon "📶" is displayed when Wi-Fi is connected. When Wi-Fi is not connected, "🚫" is displayed.
	Status Icon (Security level: Low)	"🔒" is displayed when the security level is set at <b>[Low]</b> .
	Status Icon (Remote operation)	"🖥️" is displayed when using the remote operation.
	Status Icon (Security information)	When you activate the Data Encryption/Overwrite Function, the Security information icon will be displayed. "🔒" is displayed while the data is overwriting. "📁" is displayed if there is remaining data in the SSD. "🗑️" is displayed if there is no remaining data in the SSD.
	Status Icon (FAX Memory RX Box capacity)	"📠" is displayed when the capacity of the FAX Memory RX Box is 10% or less.
	Status Icon (USB drive)	"🗑️" is displayed when a USB drive is connected to this machine. Tapping the USB drive icon and selecting [Remove USB] allows you to safely remove the USB drive.

## Editing the Home Screen

You can change the background of the Home screen as well as which icons are displayed.

### 1 Display the screen.

- 1 [Home] key > [...] > [System Menu] > [Function Settings] > [Home]



#### NOTE

If the User Authentication screen appears, log in with a user who has the privilege to configure this setting.

If you do not know your login User Name or Password, please contact your Administrator.













### 2 Configure the settings.

The available settings are shown below.

Item	Description
<b>Customize Desktop</b>	Specify the function icons to display on the desktop. Displays a maximum of 60 function icons including the installed applications and the functions that can be used when options are installed. Select <b>[Add]</b> to display the screen for selecting the function to display. Select <b>[Function Type]</b> to narrow down the functions by applications and favorites. Select the function to display, and select <b>[OK]</b> . Select an icon and <b>[Previous]</b> or <b>[Next]</b> to change the display position of the selected icon on the Desktop. To delete an icon from desktop, select the desired one and select <b>[Delete]</b> .
<b>Customize Taskbar</b>	Specify the task icons to display on the taskbar. Select <b>[Taskbar Button 1]</b> to <b>[Taskbar Button 4]</b> . Select the function to display, and select <b>[OK]</b> . 4 task icons can be displayed.
<b>Wallpaper</b>	Configure the wallpaper of the Home screen. <b>Value:</b> Images 1 to 8



## Available Functions to Display on Desktop

Function	Icon	Description	Reference page
Copy <sup>*1</sup>		Displays the Copy screen.	<a href="#">page 5-15</a>
Send <sup>*1</sup>		Displays the Send screen.	<a href="#">page 5-17</a>
Fax Server		Displays the FAX Server screen.	<a href="#">page 8-54</a>
Fax <sup>*2</sup>		Displays the FAX screen.	Refer to <b>FAX Operation Guide</b> .
Custom Box <sup>*1</sup>		Displays the Custom Box screen.	<a href="#">page 5-50</a>
Job Box <sup>*1</sup>		Displays the Job Box screen.	<a href="#">page 4-19</a>
USB Drive <sup>*1</sup>		Displays the USB Drive screen.	<a href="#">page 5-60</a>
Subaddress Box <sup>*2</sup>		Displays the Subaddress Box screen.	Refer to <b>FAX Operation Guide</b> .
Polling Box <sup>*2</sup>		Displays the Polling Box screen.	Refer to <b>FAX Operation Guide</b> .
Fax Memory RX Box <sup>*2</sup>		Displays the Fax Memory RX Box screen.	Refer to <b>FAX Operation Guide</b> .
Send to Me (Email) <sup>*3</sup>		Displays the Send screen. The E-mail address of the logged-in user is set as the destination.	<a href="#">page 5-56</a>
Send to Me from Box (Email) <sup>*3</sup>		Displays the Custom Box screen. The E-mail address of the logged-in user is set as the destination.	<a href="#">page 5-56</a>
Favorites		Calls up the registered favorite. The icon will change according to the function of the favorite.	<a href="#">page 5-7</a>
Application Name <sup>*4</sup>	—	Displays the selected applications.	<a href="#">page 5-10</a>















\*1 Selected at the time of shipment from factory.

\*2 Displayed only on products with the fax function installed.

\*3 Displayed when user login administration is enabled.

\*4 The icon of the application appears.

## Available Functions to Display on Taskbar

Function	Icon	Description	Reference page
Status/Job Cancel <sup>*1</sup>		Displays the Status/Job Cancel screen.	—
Device Information <sup>*1</sup>		Displays the Device Information screen. Check the system and network information, and information on the options that are used. It is possible to print various reports and lists.	<a href="#">page 2-23</a>
Language <sup>*1</sup>		Displays the Language setting screen in System Menu.	<a href="#">page 8-7</a>
Paper Settings <sup>*1</sup>		Displays the Paper setting screen in System Menu.	<a href="#">page 8-13</a>
Wi-Fi Direct <sup>*2</sup>		Wi-Fi Direct is set and a list of information relating to the machine that can use the network appears.	<a href="#">page 2-44</a>
Help		Displays the Help screen.	<a href="#">page 2-31</a>
User Property		Displays the User Property screen.	<a href="#">page 9-9</a>
Incoming Fax Log <sup>*3</sup>		Displays the Incoming Fax Log screen.	Refer to <b>FAX Operation Guide</b> .
Outgoing Fax Log <sup>*3</sup>		Displays the Outgoing Fax Log screen.	Refer to the <b>FAX Operation Guide</b> .
System Menu		Displays the System Menu screen.	<a href="#">page 8-2</a>
Counter		Displays the Counter screen.	<a href="#">page 2-67</a>
Accessibility/Standard		Magnifies the text and icons on the screen. Select <b>[Accessibility/Standard]</b> again to return to the previous view.	<a href="#">page 2-32</a>
Numeric Keypad		Displays the numeric keys on the touch panel.	—
Favorites		Displays the favorite list screen.	<a href="#">page 5-7</a>

\*1 Selected at the time of shipment from factory.

\*2 Displayed when the optional Wireless Network Interface Kit is installed.

\*3 Displayed only on products with the fax function installed.

## Assigning Functions to Function Keys

Function keys are keys to which various functions and applications, including copy and scan, can be assigned. Frequently used functions and applications can be assigned and the screen can easily be displayed.

For this machine, the following functions are pre-assigned; however, alternative functions can be registered by re-assigning these functions.

- [F1] (Function key 1): Copy
- [F2] (Function key 2): Send
- [F3] (Function key 3): FAX (Option)

### 1 Display the screen.

[Home] key > [...] > [System Menu] > [Device Settings] > [Function Key Assignment]



#### NOTE

If the User Authentication screen appears, log in with a user who has the privilege to configure this setting. If you do not know your login User Name or Password, please contact your Administrator.

### 2 Configure the settings.

- 1 Select the function key to be set.
- 2 Select the function to be assigned.

Function	Description	Reference page
None	No function has been assigned.	—
Copy	Displays the Copy screen.	<a href="#">page 5-15</a>
Send	Displays the Send screen.	<a href="#">page 5-17</a>
Fax Server	Displays the Fax Server screen.	<a href="#">page 8-54</a>
Fax <sup>*1</sup>	Displays the Fax screen.	Refer to <b>FAX Operation Guide</b> .
Custom Box	Displays the Custom Box screen.	<a href="#">page 5-50</a>
Job Box	Displays the Job Box screen.	<a href="#">page 4-19</a>
USB Drive	Displays the USB Drive screen.	<a href="#">page 5-60</a>
Subaddress Box <sup>*1</sup>	Displays the Subaddress Box screen.	Refer to <b>FAX Operation Guide</b> .
Polling Box <sup>*1</sup>	Displays the Polling Box screen.	
Fax Memory RX Box <sup>*1</sup>	Displays the Fax Memory RX Box screen.	
Send to Me (Email) <sup>*2</sup>	Displays the Send screen. The E-mail address of the logged-in user is set as the destination.	<a href="#">page 5-56</a>
Send to Me from Box (Email) <sup>*2</sup>	Displays the Custom Box screen. The E-mail address of the logged-in user is set as the destination.	<a href="#">page 5-56</a>
Favorites Name	Calls up the registered favorite.	<a href="#">page 5-7</a>
Application Name	Displays the selected applications.	<a href="#">page 5-10</a>

\*1 Displayed only on products with the fax function installed.

\*2 Displayed when user login administration is enabled.

## Display for Device Information

Shows device information. Allows you to check system and network information, as well as options that are used.

- 1 [Home] key > [Device Information]
- 2 Check the device information.

Tab	Description
<b>Identification/Wired Network</b>	You can check ID information such as the model name, serial number, host name and location, and the IP address of the wired network.
<b>Wi-Fi<sup>*1</sup></b>	You can check the status of Wi-Fi connection, such as the device name, network name and IP address. Displayed when the optional Wireless Network Interface Kit is installed.
<b>Supplies/Unit Status</b>	You can check the presence of toner and paper, and the status of the unit.
<b>FAX<sup>*2</sup></b>	You can check the local fax number, local fax name, local fax ID and other fax information.
<b>USB/Bluetooth</b>	You can check the connection status of USB drive and Bluetooth keyboard.
<b>Option/Application</b>	You can check information on the options and applications that are used.
<b>Capability/Software Version</b>	You can check the software version and performance.
<b>Security</b>	You can check the security information on the machine.
<b>Report</b>	You can print various reports and lists.
<b>Remote Ope. Status</b>	You can check the status of remote operation.

\*1 Displayed only when the wireless network function is available on the machine.

\*2 Displayed only on products with the fax function installed.

## Display Setting Screen

The following procedure is an example of the Copy screen.

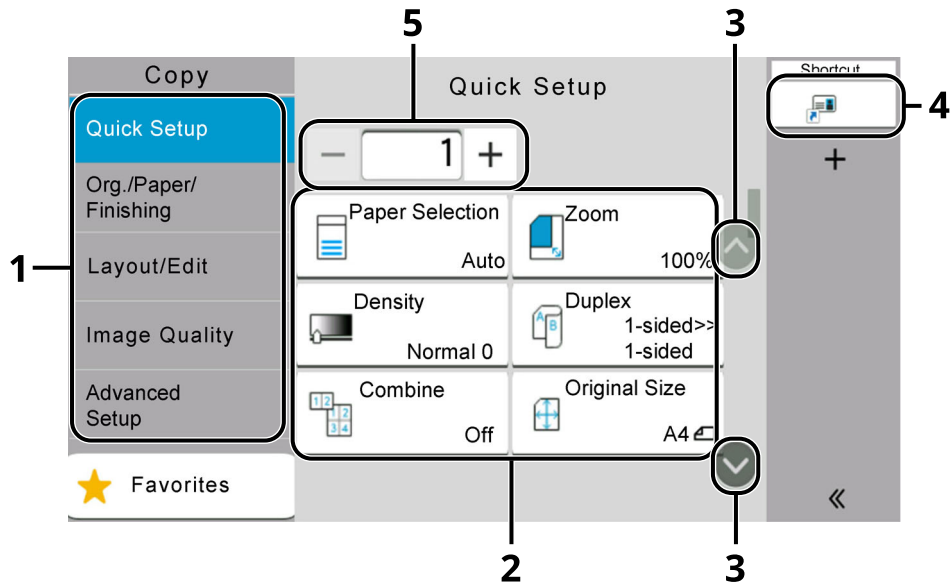

1 Global Navigation  
Displays the function categories.

2 Body  
Display functions and shortcuts of copy.

3 Arrow Button  
Moves the screen up or down.

4 Displays registered shortcuts.

5 Enter the number of copies.

Select Global Navigation and configure each function. Select the Arrow Button to display the following functions.

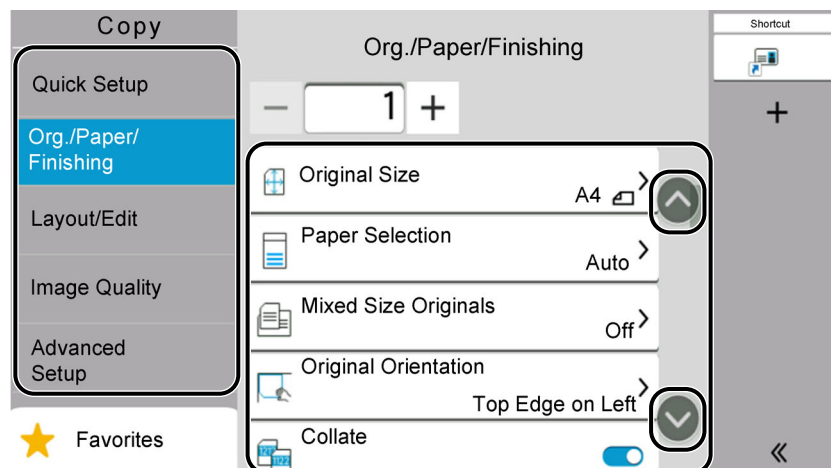

When an On/Off Flipswitch is displayed for a function, select the switch to change between ON and OFF.

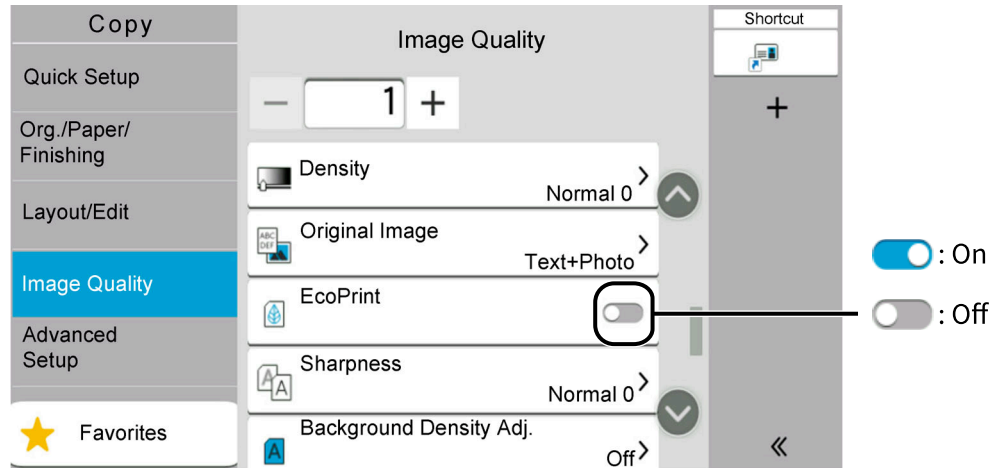

## Display of Keys That Cannot Be Set

Keys of features that cannot be used due to feature combination restrictions or non-installation of options are in a non-selectable state.

### Normal

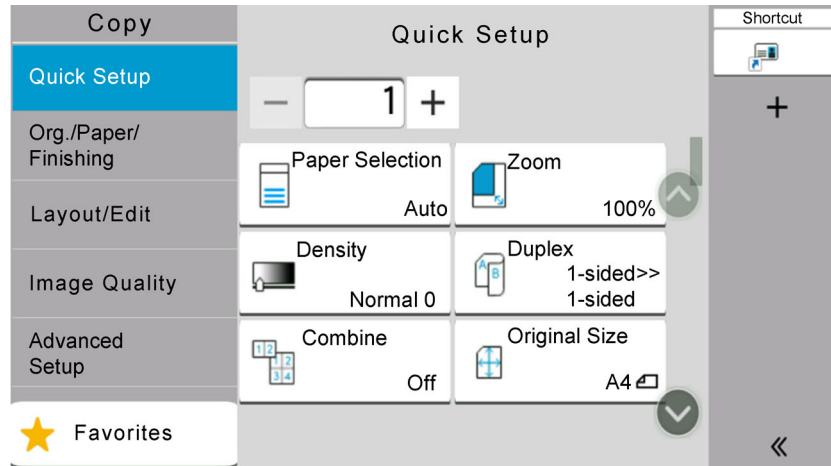

### Grayed out

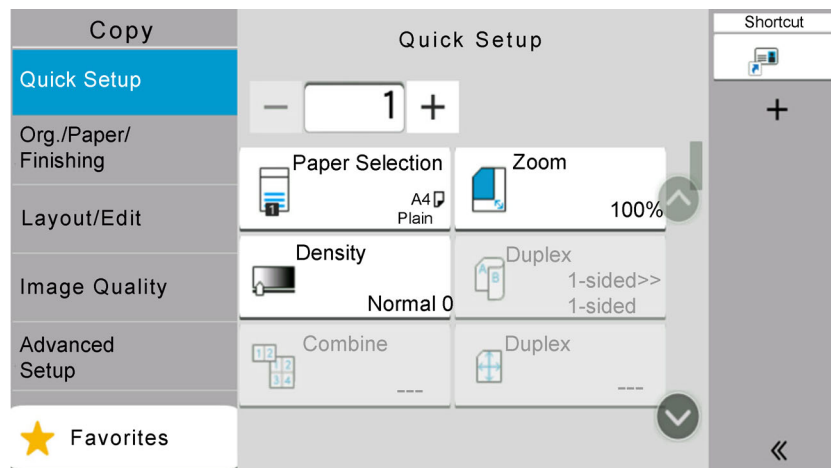

In the following cases, the key is grayed out and cannot be selected.

- Cannot be used in combination with a feature that is already selected.
- Use prohibited by user control.
- For functions that cannot be changed when using proof copy.

## Hidden

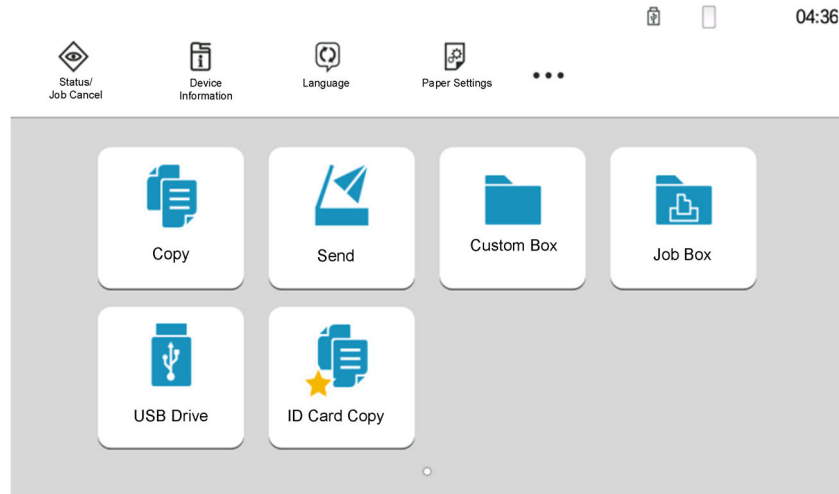

Cannot be used because an option is not installed.

### NOTE

- If a key that you wish to use is grayed out, the settings of the previous user may still be in effect. In this case, select the **[Reset]** key and try again.
- If the key is still grayed out after the **[Reset]** key is selected, it is possible that you are prohibited from using the function by user login administration. Check with the administrator of the machine.

## Original Preview

You can display a preview image of the scanned document on the panel.

### NOTE

To view a preview of an image stored in a Custom Box, refer to the following:

➔ [Previewing Documents/Checking Document Details \(page 5-48\)](#)

The procedure described here is for copying a single-page original.

### **1** Display the screen.

[Home] key > [Send]

### **2** Place the originals.



### 3 Display a preview image.

- 1 Select **[Preview]**.

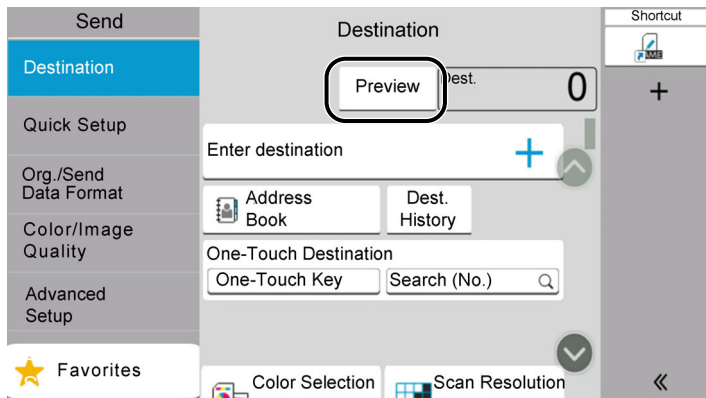

The machine starts scanning the original. When scanning is completed, the preview image appears on the panel.

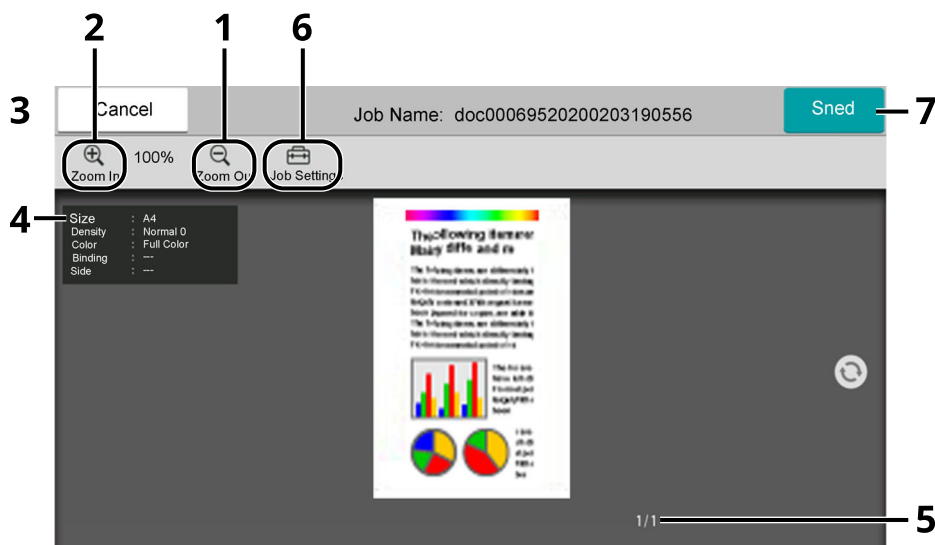

- 1 Zoom out.
- 2 Zoom in.
- 3 Cancel the job.
- 4 Displays the data information.
- 5 Displays the current number of pages and overall number of pages.
- 6 You can change the job settings.
- 7 Start the sending.

#### NOTE

- To change the quality or the layout, select **[Cancel]**. Change the settings and select **[Preview]** again to see a preview image with the new settings.
- Depending on the function you are using, even if you scan a multi-page original, only the first page can be previewed.

- 2 If there is no problem with the preview image, select **[Send]**.  
Sending starts.

## Using the Preview Screen

When the Preview screen is displayed, you can do the following by moving the finger that is touching the touch panel.

Function	Description
<b>Swipe</b>	If a document with multiple pages is placed on the Document Processor, then all of the document is read and then the preview for the first page is displayed. Swipe the preview to the left and right to display a preview of the pages in the order read.
<b>Drag</b>	With the finger touching the touch panel, slide the finger to move the position of the displayed preview.
<b>Pinch in Pinch out</b>	With two fingers touching the touch panel, widen or tighten the space between the two fingers to zoom in and out on the view.

## Entering Numbers

When entering numbers, numeric keys appear on the touch panel if you select the area in which the number is entered.

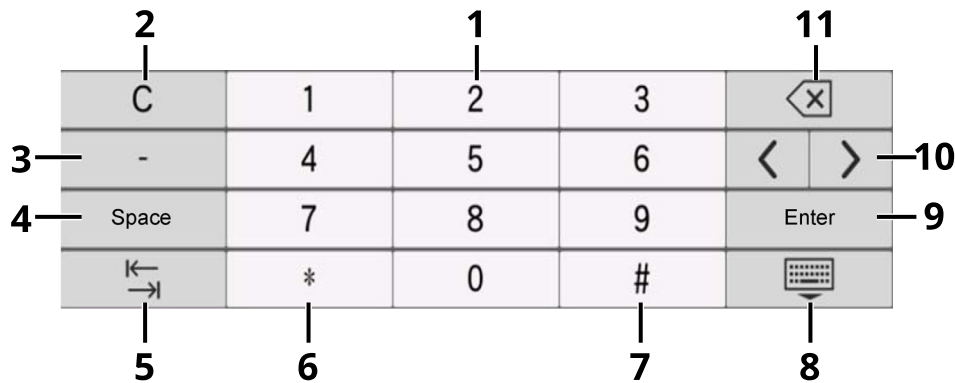

- 1 Enter numbers.
- 2 Clear entered numbers.
- 3 Enters [-].
- 4 Insert a space.
- 5 Move to the next input box.
- 6 When [.] is displayed: Enters the decimal point. The numbers entered after selecting this key will be the numbers after the decimal point.  
When [\*] is displayed: Enters [\*].
- 7 When [+/-] is displayed: Switches between positive and negative numbers.  
When [#] is displayed: Enters [#].
- 8 Close the numeric keypad.
- 9 Entry by numeric keys is confirmed.
- 10 Move the cursor.
- 11 Delete a character to the left of the cursor.

### NOTE

- Depending on the item being entered, some of the keys other than the number keys may not be usable.
- Numeric keys do not appear on the touch panel if an optional numeric keypad is installed.

**Example: When entering the number of copies**

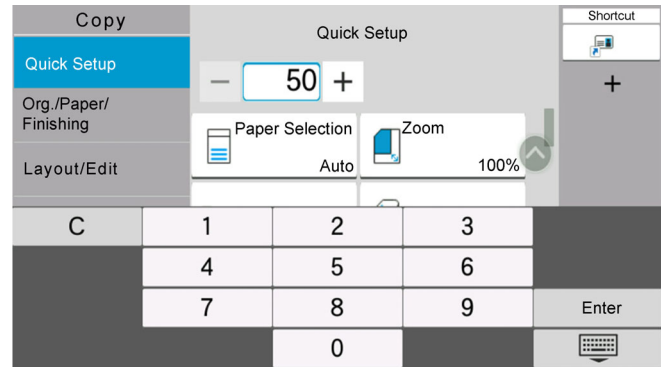
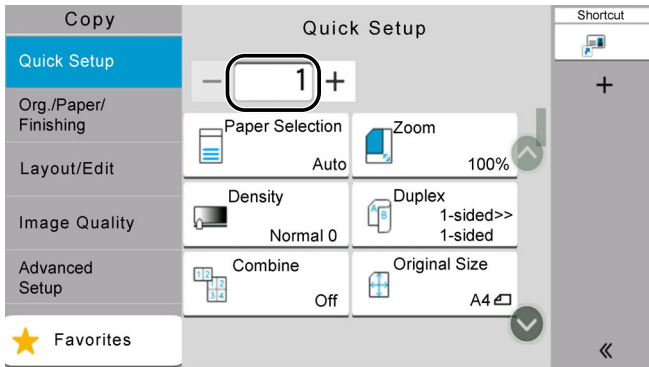

**Example: When entering a one-touch key number**

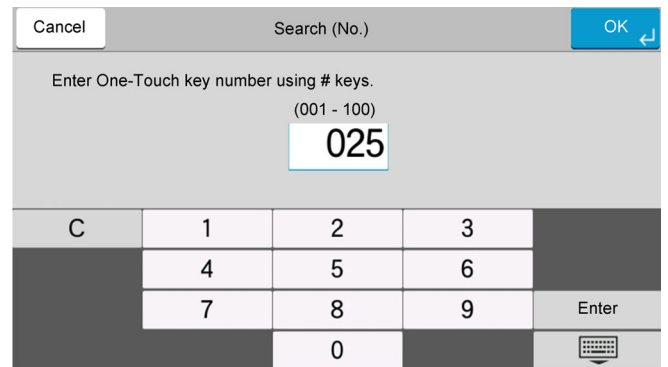
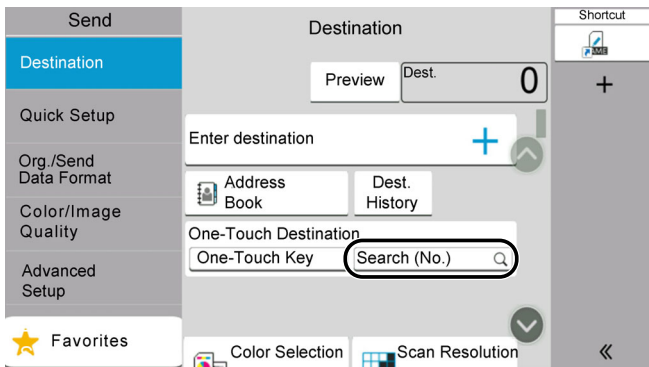

**Example: When searching for an address number**

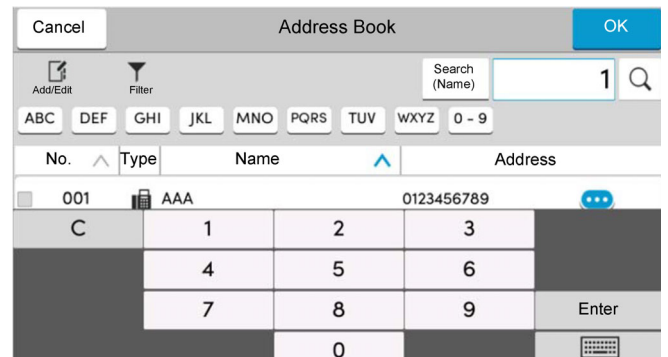
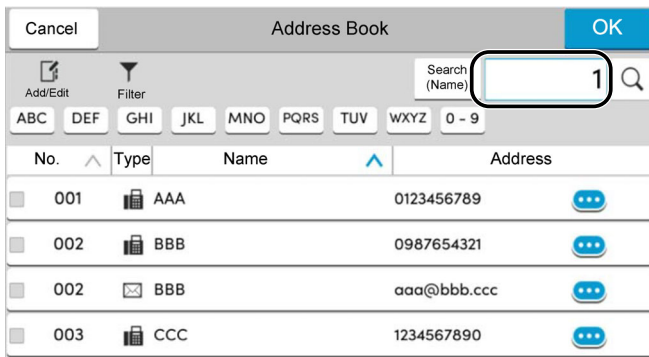

**NOTE**  
 For copy and print screens, you can set numeric keys to be displayed in advance. In addition, you can select the layout for numeric keys that are used on the application.  
 ➔ [Numeric Keypad \(page 8-7\)](#)

## Help Screen

If you have difficulty operating the machine, you can check how to operate it using the touch panel. Select **[Help]** on the Home screen to show the Help list.

### 1 [Home] key > [...] > [Help]

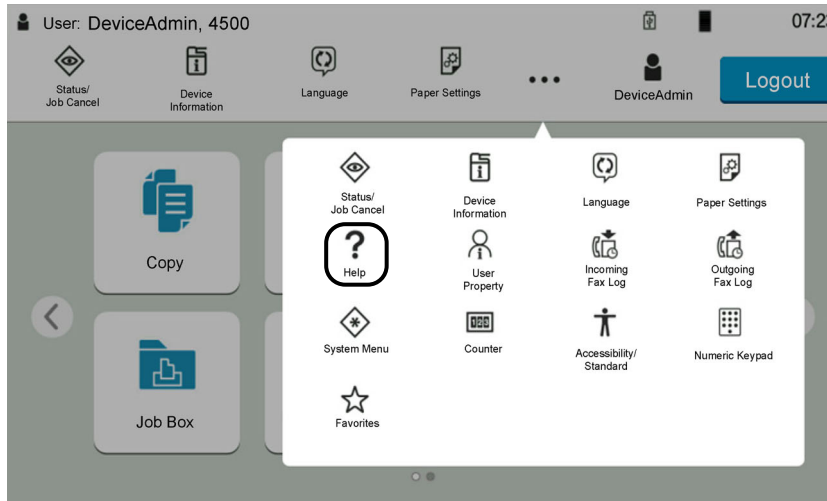

### 2 Select the items to check from the list.

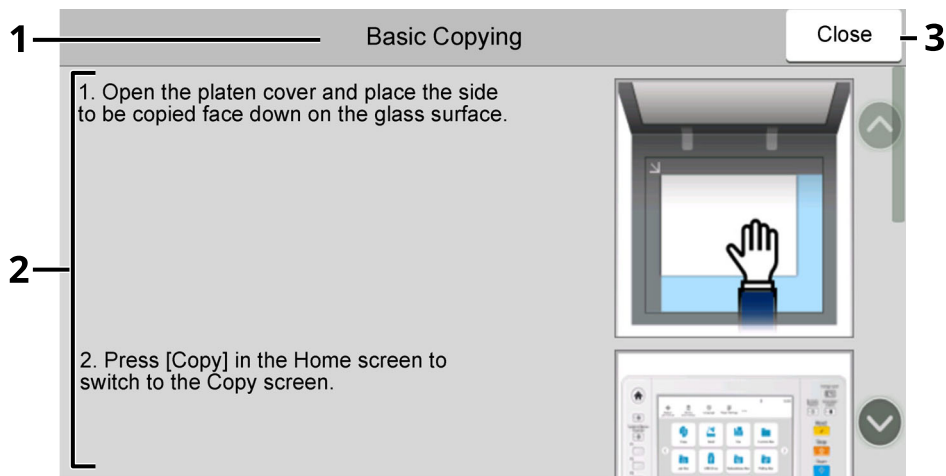
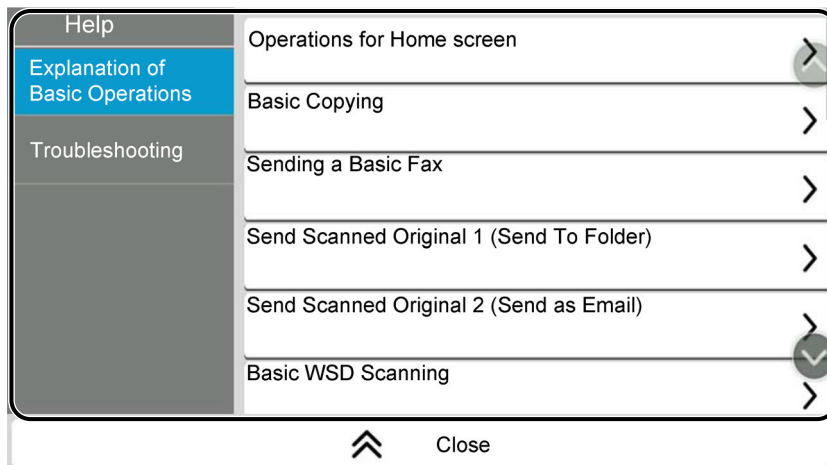

- 1 Help titles
- 2 Displays information about functions and machine operation.
- 3 Closes the Help screen and returns to the original screen.

## Accessibility Functions (Magnifying the View)

You can magnify the text and keys displayed on the touch panel. You can also select items and move to the next screen using the numeric keys.

Select [**Home**] key > [...] > [**Accessibility/Standard**]

Large keys and text appear on the touch panel.



### NOTE

- This function can be used on the Home screen and on the functions that were registered via Copy/Send/Fax Quick Setup.
- To configure any functions that are not displayed on the Accessibility screen, you need to return to the original view. Select [**Accessibility/Standard**] again.
- Long press the [**Home**] key to switch between the Standard screen and the Accessibility screen.

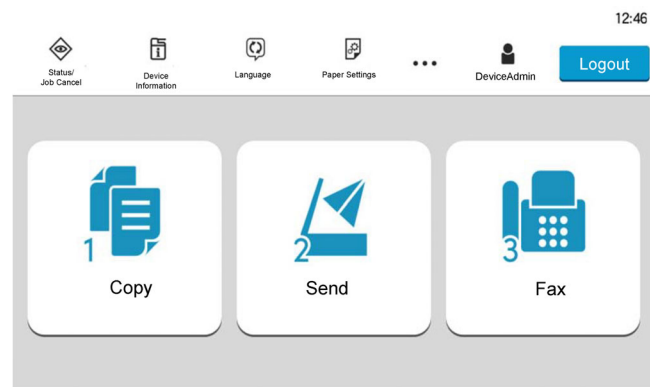
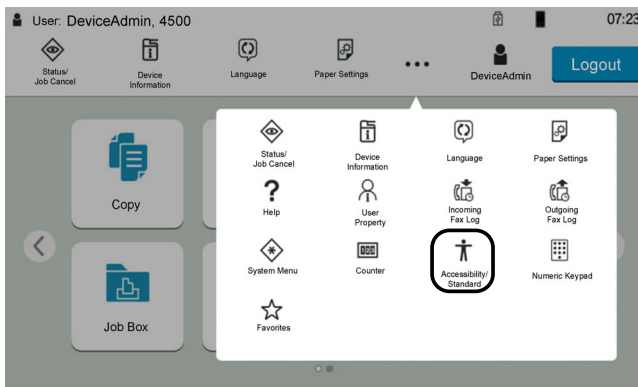

You can also control the screen using the numeric key corresponding to the number in circle. (Example: Select the [2] key on the numeric key pad to display the Send screen.)

Control the functions according to the display on the screen.

# Login/Logout

## Login

### 1 Enter the login user name and login password to login.

If this screen is displayed during operations, enter the login user name and login password.

- 1 If **[Network Authentication]** is selected as the user authentication method, authentication destinations are displayed and either **[Local]** or **[Network]** can be selected as the authentication destination.
- 2 Enter the login user name.

#### NOTE

If you do not know your login User Name, please contact your Administrator.

- 3 Enter the login password.
  - ➔ [Character Entry Method \(page 11-10\)](#)
- 4 Select the login method from **[Simple login]**, **[PIN code login]** and **[ID card login]**.
  - ➔ [User Authentication and Accounting \(User Login, Job Accounting\) \(page 9-1\)](#)
- 5 Check the Wi-Fi Direct environment.
- 6 Refer to the number of pages printed and the number of pages scanned. Displayed when job accounting is enabled.

### 2 Select [Login].

## Simple Login

- 1 If the following screen is displayed during operations, select a user and log in.

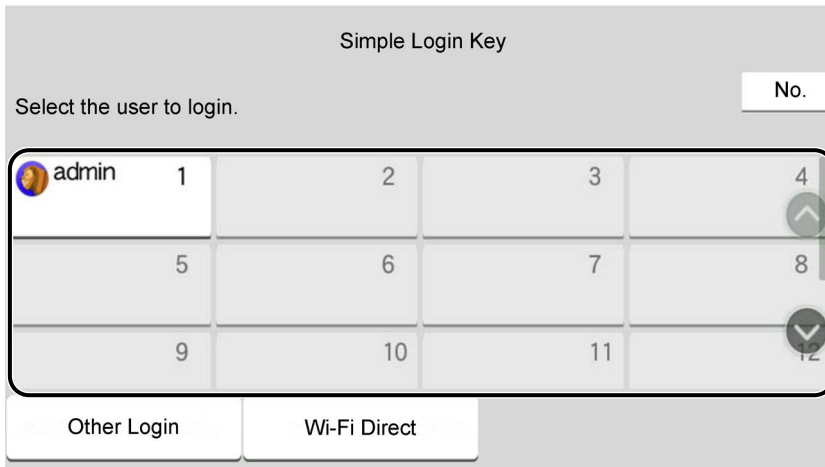

### NOTE

If a user password is required, an input screen will be displayed.

➔ [Simple Login Settings \(page 9-26\)](#)

## Logout

- 1 Select the [Logout] key.

The login user name/login password entry screen is returned.

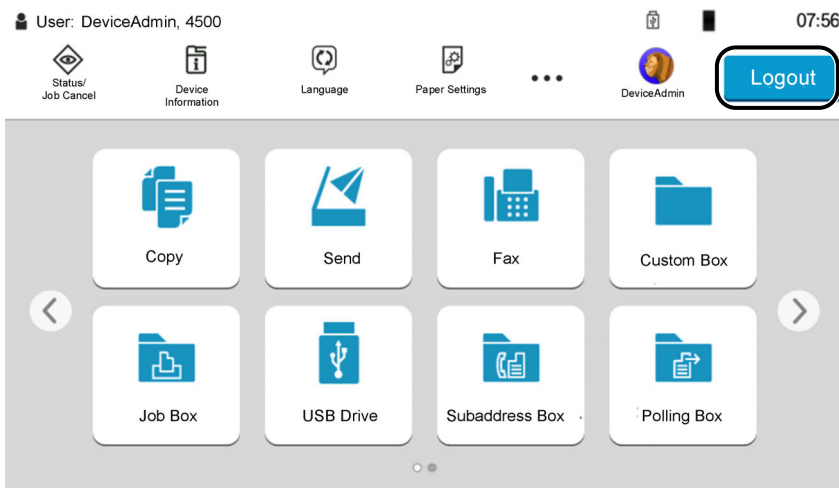

### NOTE

Users are automatically logged out in the following circumstances:

- When the machine enters the sleep state.
- When the auto panel reset function is activated.

# Default Settings of the Machine

The default settings of the machine can be changed in System Menu. Before using this machine, configure such settings as date and time, network configuration, and energy saving functions as needed.

## NOTE

For settings that are configurable from System Menu, refer to the following:

➔ [Setup and Registration \(System Menu\) \(page 8-1\)](#)

## Setting Date and Time

Follow the steps below to set the local date and time at the place of installation.

When you send an E-mail using the transmission function, the date and time as set here will be printed in the header of the E-mail message. Set the date, time and time difference from GMT of the region where the machine is used.

## NOTE

- To make changes after this initial configuration, refer to the following:

➔ [Date/Time \(page 8-7\)](#)

- The correct time can be periodically set by obtaining the time from the network time server.

➔ **Command Center RX User Guide**

### 1 Display the screen.

[Home] key > [...] > [System Menu] > [Device Settings] > [Date/Time]

### 2 Configure the settings.

[Time Zone] > [Date/Time] > [Date Format]

Item	Description
<b>Time Zone</b>	Set the time difference from GMT. Choose the nearest listed location from the list. If you select a region that utilizes summer time, configure settings for summer time.
<b>Date/Time</b>	Set the date and time for the location where you use the machine. If you perform Send as E-mail, the date and time set here will be displayed on the header. <b>Value: Year (2000 to 2035), Month (1 to 12), Day (1 to 31), Hour (00 to 23), Minute (00 to 59), Second (00 to 59)</b>
<b>Date Format</b>	Select the display format of year, month, and date. The year is displayed in Western notation. <b>Value: Month/Day/Year, Day/Month/Year, Year/Month/Day</b>



# Network Setup

## Configuring the Wired Network

The machine is equipped with network interface, which is compatible with network protocols such as TCP/IP (IPv4), TCP/IP (IPv6), NetBEUI, and IPSec. It enables network printing on the Windows, Macintosh, UNIX and other platforms.

The configuration methods are as follows

Configuration Method	Description	Reference Page
Configuring the Connection from the Operation Panel on This Machine	Use Quick Setup Wizard when configuring the network in a wizard-style screen, without setting individually in System menu.	<a href="#">Quick Setup Wizard (page 2-49)</a>
	Use Wired Network Settings or Optional Network to configure the network in details from System menu.	<a href="#">Wired Network Settings (page 8-44)</a> <a href="#">Optional Network (page 8-51)</a>
Configuring Connections on the Web Page	For the equipped network interface, the connection can be set by using Command Center RX. For the optional IB-50, the connection can be set by using the dedicated Web page.	<b>Command Center RX User Guide</b> IB-50 Operation Guide
Setting the Connection by Using the Setup Utility of IB-50	This is the setup tool included in the CD of IB-50. You can use it on Windows.	IB-50 Operation Guide

 **NOTE**  
When you want to switch to the network interface other than Wired (default) after installing an optional Network Interface Kit (IB-50) and a Wireless Network Interface Kit (IB-37/IB-38/IB-51), select the desired setting on "Primary Network (Client)".

➔ [Primary Network \(Client\) \(page 8-55\)](#)

For other network settings, refer to the following:

➔ [Network \(page 8-61\)](#)

## IPv4 setting

### NOTE

If the User Authentication screen appears, log in with a user who has the privilege to configure this setting. If you do not know your login User Name or Password, please contact your Administrator.

### 1 Display the screen.

[Home] key > [...] > [System Menu] > "Network Settings" [Wired Network Settings] > "TCP/IP Setting" [IPv4 Settings]

### 2 Configure the settings.

#### When using DHCP server

[DHCP]: Set to [On].

#### When setting the static IP address

[DHCP]: Set to [Off].

[IP Address]: Enter the address.

[Subnet Mask]: Enter the subnet mask in decimal representation (0 to 255).

[Default Gateway]: Enter the address.

When using the Auto-IP, enter "0.0.0.0" in [IP Address].

#### When setting the DNS server

In the following cases, set the IP address of DNS (Domain Name System) server.

- When using the host name with [DHCP] setting set to [Off].
- When using the DNS server with IP address that is not assigned by DHCP automatically.

Select [Use DNS Server from DHCP] or [Use following DNS Server]. When [Use following DNS Server] is selected, you can enter static DNS server information in the Primary and Secondary fields provided.

### IMPORTANT

After changing the setting, restart the network from System Menu, or turn the machine OFF and then ON.

➔ [Restart Network \(page 8-51\)](#)

### NOTE

Ask your network administrator for the IP address in advance, and have it ready when you configure this setting.

## Configuring the Wireless Network

When the Wireless Network Interface Kit (IB-37/IB-38/IB-51) is installed on the machine and the connection settings are configured, it is possible to print or send in a wireless network (wireless LAN) environment. The configuration methods are as follows:

Configuration Method	Description	Reference Page
<b>Configuring the Connection from the Operation Panel on This Machine</b>	Use Quick Setup Wizard when configuring the network in a wizard-style screen, without setting individually in System menu.	<a href="#">Quick Setup Wizard (page 2-49)</a>
	Use Wi-Fi Settings to configure the network in details from System menu.	<a href="#">Wi-Fi Settings (page 8-40)</a>
<b>Setting the Connection by Using the Wi-Fi Setup Tool</b>	This is a tool that can be downloaded from our website. You can configure the connection according to the instructions provided by the wizard.	<a href="#">Wired Connection with LAN Cable Using Wi-Fi Setup Tool (page 2-38)</a>
<b>Configuring Connections on the Web Page</b>	For the IB-37/IB-38, the connection can be set from the Command Center RX.	<b>Command Center RX User Guide</b>
	For the IB-51, the connection can be set on the dedicated Web page.	<b>IB-51 Operation Guide</b>
<b>Setting the Connection by Using the Setup Utility of IB-51</b>	This is the setup tool included in the CD of IB-51. You can use it on both Windows and Mac OS.	<b>IB-51 Operation Guide</b>

### NOTE

When you want to switch to the network interface other than Wired (default) after installing an optional Network Interface Kit (IB-50) and a Wireless Network Interface Kit (IB-37/IB-38/IB-51), select the desired setting on "Primary Network (Client)".

➔ [Primary Network \(Client\) \(page 8-55\)](#)

## Wired Connection with LAN Cable Using Wi-Fi Setup Tool

To send the Wi-Fi settings configured in the Wi-Fi Setup Tool to the machine, connect the computer or handheld device with the machine locally. To use a wired LAN cable directly connected to the machine, the Auto-IP (Link-local) address will be assigned to the machine and the computer. This machine applies Auto-IP as the default settings.

### NOTE

Configure the settings on the operation panel if your computer supports WPS.

➔ [Wi-Fi Settings \(page 8-40\)](#)

➔ [Wireless Network \(page 8-51\)](#)

## 1 Connect the machine with a computer

- 1 Connect the machine with a computer via LAN cable when the machine is powered on.
- 2 Turn on the computer.  
IP address (link local address) of the machine and computer is generated automatically.

## 2 Launch the Wi-Fi Setup Tool.

- 1 Launch a web browser.

- 2 Enter "https://kyocera.info/" to the browser's address bar or location bar.

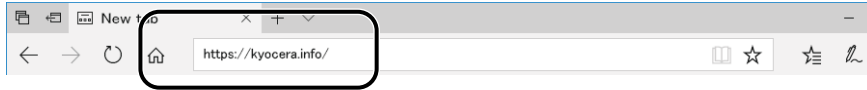

- 3 Enter and search the product name, and select this product from the candidate list.

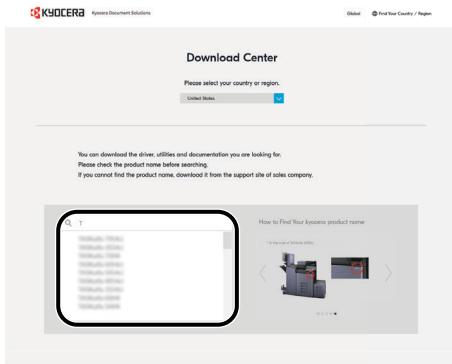

- 4 Change the selected operating system and its language setting as needed.

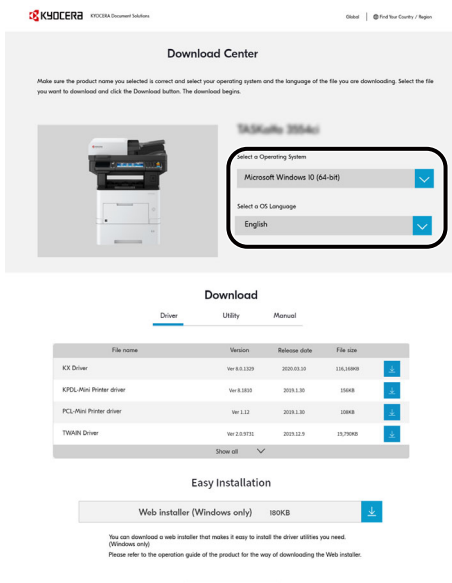

5 Utility tab > "Wi-Fi Setup Tool" 

The Wi-Fi Setup Tool will be downloaded.

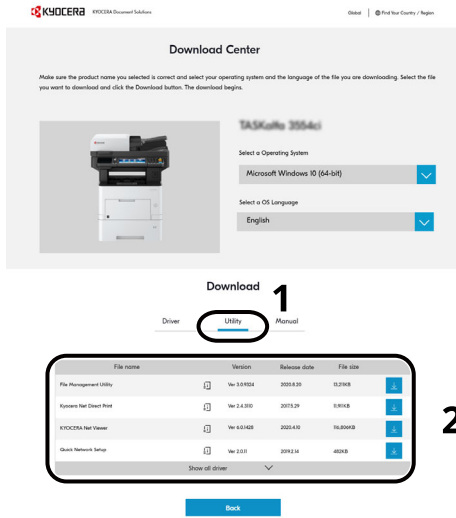

6 Double-click the downloaded installer to launch.

 **NOTE**

- Installation on Windows must be done by a user logged on with administrator privileges.
- If the user account management window appears, click **[Yes]** (**[Allow]**).

3 **Configure the settings.**

1 **[Do not use automatic configuration]** > **[Next]** > **[Next]**

2 **[Use LAN cable]** > **[Next]** > **[Next]**

3 **[Easy setup]** > **[Next]**

The machine is detected.

 **NOTE**

- Only one machine can be searched using Wi-Fi Setup Tool. It may take times to search the machine.
- If the machine is not detected, select **[Advanced setup]** > **[Next]**. Select **[Express]** or **[Custom]** as device discovery method and specify the IP address or host name to search the machine.

4 Select the machine > **[Next]**

5 Select **[Use the device settings.]** on **[Authentication mode]**, and enter the login user name and password. Login user name and Password are both Admin.

6 Configure the communication settings > **[Next]**

7 Change the settings of access point as necessary > **[Next]**

The network is configured.

## Wireless LAN Connection by Wi-Fi Direct Using Wi-Fi Setup Tool

To send the Wi-Fi settings configured in the Wi-Fi Setup Tool to the machine, connect the computer or handheld device with the machine locally.

To use Wi-Fi Direct, confirm that the Wi-Fi Direct is enabled (Wi-Fi Direct is set to **[On]**) and Restart Network from the operation panel, before your computer will be connected to this machine with Wi-Fi Direct.



### NOTE

Configure the settings on the operation panel if your computer supports WPS.

➔ [Wi-Fi Settings \(page 8-40\)](#)

➔ [Wireless Network \(page 8-51\)](#)

## 1 Display the screen.

[Home] key > [...] > [System Menu] > [Network Settings] > "Network Settings" [Wi-Fi Direct Settings]

## 2 Configure the settings.

[Wi-Fi Direct]: [On] > [OK]

## 3 Restart the network.

[Home] key > [...] > [System Menu] > [Network Settings] > "Network Settings" [Restart Network] > [Restart]

## 4 Connect a computer or a handheld device with the machine.

➔ [Setting Wi-Fi Direct \(page 2-44\)](#)

## 5 Launch the Wi-Fi Setup Tool.

1 Launch a web browser.

2 Enter "https://kyocera.info/" to the browser's address bar or location bar.

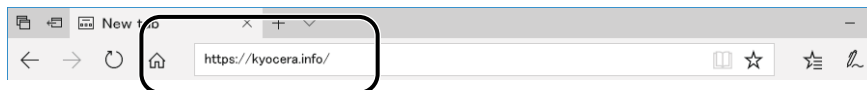

3 Enter and search the product name, and select this product from the candidate list.

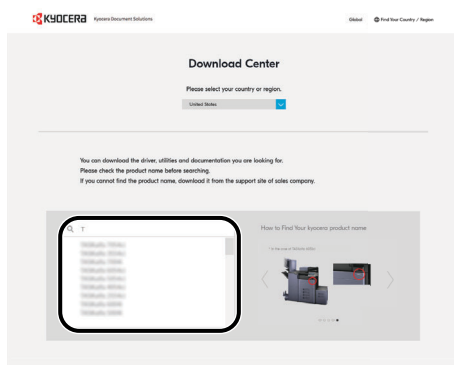

4 Change the selected operating system and its language setting as needed.

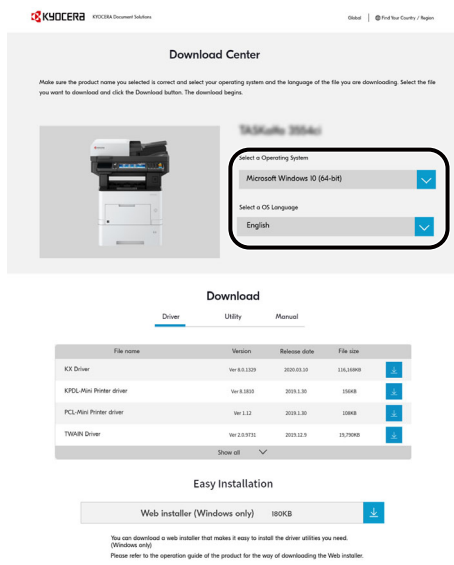

5 Utility tab > "Wi-Fi Setup Tool"  The Wi-Fi Setup Tool will be downloaded.

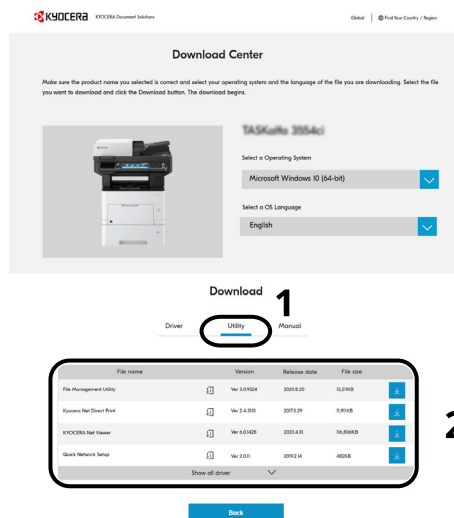

6 Double-click the downloaded installer to launch.



**NOTE**

- Installation on Windows must be done by a user logged on with administrator privileges.
- If the user account management window appears, click **[Yes]** (**[Allow]**).

6 Configure the settings.

1 **[Do not use automatic configuration]** > **[Next]** > **[Next]**

2 **[Wi-Fi Direct]** > **[Next]** > **[Next]**

**3 [Advanced setup] > [Next]**

Select [**Express**] or [**Custom**] as device discovery method and specify the IP address or host name to search the machine.

**4** Select the machine > [**Next**]

**5** Select [**Use the device settings.**] on [**Authentication mode**], and enter the login user name and password. Login user name and Password are both Admin.

**6** Configure the communication settings > [**Next**]

**7** Change the settings of access point as necessary > [**Next**]

The network is configured.



## Setting Wi-Fi Direct

You can install the optional Wireless Network Interface Kit (IB-37/IB-38) on the machine and configure the connection settings to print in a Wi-Fi Direct environment. The configuration methods are as follows:

### Connecting to Devices that Support Wi-Fi Direct from Operation Panel

#### 1 Display the screen.

[Home] key > [...] > [System Menu] > [Network Settings] > " Network Settings" [Wi-Fi Direct Settings]

#### 2 Configure the settings.

[Wi-Fi Direct]: [On] > [OK]

#### 3 Restart the network.

[Home] key > [...] > [System Menu] > [Network Settings] > " Network Settings" [Restart Network] > [Restart]

#### 4 Specify the machine name from the computer or handheld device.

If a confirmation message appears on the operation panel of the machine, select [Yes].

The network between this machine and the handheld device is configured.

### Connecting to Computers or Handheld Devices Unsupported Wi-Fi Direct

Here, we'll explain the procedures for connecting to iOS handheld devices.

#### 1 Display the screen.

[Home] key > [...] > [System Menu] > [Network Settings] > " Network Settings" [Wi-Fi Direct Settings]

#### 2 Configure the settings.

[Wi-Fi Direct]: [On] > [OK]

#### 3 Restart the network.

[Home] key > [...] > [System Menu] > [Network Settings] > " Network Settings" [Restart Network] > [Restart]

#### 4 [Home] key > [Device Information] > [Wi-Fi]

#### 5 Note the network name (SSID), IP address, and password.

#### 6 Configure the handheld device.

1 [Settings] > [Wi-Fi]

2 Select the network name (SSID) appeared in step 5 from the list.

3 Enter the password that was provided in step 5 > [Connect]

The network between this machine and the handheld device is configured.

## Configuring the Connection by Using Push Button

When your computer or handheld device does not support Wi-Fi Direct but supports WPS, you can configure the network using push button.

### 1 Display the screen.

[Home] key > [...] > [System Menu] > [Network Settings] > " Network Settings" [Wi-Fi Direct Settings]

### 2 Configure the settings.

[Wi-Fi Direct]: [On] > [OK]

### 3 Restart the network.

[Home] key > [...] > [System Menu] > [Network Settings] > " Network Settings" [Restart Network] > [Restart]

### 4 [Home] key > [Device Information] > [Wi-Fi Direct/Wi-Fi]

### 5 Press the push button on the computer or handheld device and select [Push Button] on the screen of operation panel simultaneously.

The network between this machine and the computer or handheld device is configured.

#### IMPORTANT

You can connect up to 10 handheld devices at the same time using Wi-Fi Direct setting. When the devices that support Wi-Fi Direct are connected, if you want to connect other device, disconnect the already-connected devices from the network. The disconnection methods are as follows:

- Disconnect the network from the computer or handheld computer
  - Disconnecting all devices from the network on the operation panel  
Select [Home] key > [Device Information] > [Wi-Fi Direct/Wi-Fi] > "Wi-Fi Direct" [Device] > [Disconnect All] > [Disconnect]
  - Configuring auto disconnecting time from the System menu
- ➔ [Wi-Fi Settings \(page 8-40\)](#)
- Configuring auto disconnecting time from the Command Center RX
- ➔ [Command Center RX User Guide](#)

# Energy Saver function

If a certain period of time elapses after the machine is last used, the machine automatically enters Low Power Mode to reduce power consumption. If a further period of time elapses without the machine being used, the machine automatically enters Sleep Mode, which minimizes power consumption.

## Low Power Mode

If the machine is not operated for a certain period of time, the energy saver indicator will light up and the screen will become dark to reduce power consumption. This status is referred to as Low Power Mode.

"Low power." will be displayed on the screen.

The amount of time before entering Low Power Mode: 1 minutes (default setting).

If print data is received during Low Power Mode, the machine automatically wakes up and starts printing. Also when fax data arrives while the machine is in Low Power Mode, the machine automatically wakes up and starts printing.

To resume, perform one of the following actions.

- Select any key on the operation panel.
- Touch the touch panel.
- Place originals in the document processor.

Recovery time from Low Power Mode is as follows.

- 10 seconds or less

Note that ambient environmental conditions, such as ventilation, may cause the machine to respond more slowly.

### NOTE

If the Low Power Timer is equal to the Sleep Timer, a Sleep mode is preceded.

## Sleep

### Sleep

To enter Sleep, select the [**Energy Saver**] key. Touch panel and all indicators on the operation panel will go out to save a maximum amount of power except the Energy Saver indicator. This status is referred to as Sleep.

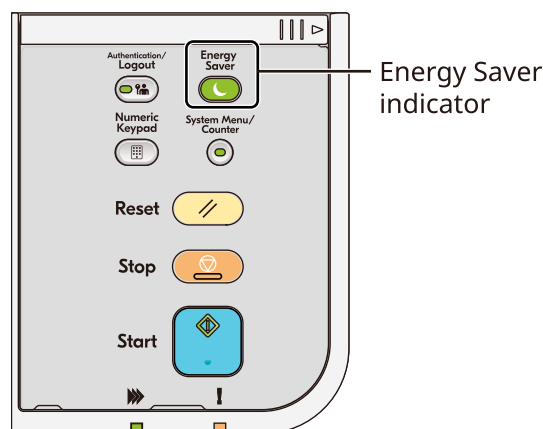

If print data is received during Sleep, the machine automatically wakes up and starts printing.

Also when fax data arrives while the machine is in Sleep, the machine automatically wakes up and starts printing.

To resume, perform the following actions.

- Select any key on the operation panel.
- Touch the touch panel.
- Place originals in the document processor.
- Open the document processor.

Recovery time from Sleep Mode is as follows.

- ECOSYS MA6000ifx/ECOSYS MA5500ifx: 21.0 seconds or less
- ECOSYS MA4500ifx/ECOSYS MA4500ix: 25.0 seconds or less

Note that ambient environmental conditions, such as ventilation, may cause the machine to respond more slowly.

## Auto Sleep

Auto Sleep automatically switches the machine into Sleep if left idle for a preset time.

The amount of time before entering Sleep is as follows.

- 1 minutes (default setting)

To change the preset sleep time, refer to the following:

➔ [Quick Setup Wizard \(page 2-49\)](#)

## Sleep Rules (models for Europe)

You can set whether sleep mode operates for each function. When the machine enters sleep mode, the ID card cannot be recognized.

For more information on Sleep Rules settings, refer to the following:

➔ [Sleep Rules \(models for Europe\) \(page 8-8\)](#)

## Sleep Level (Energy Saver and Quick Recovery) (models except for Europe)

This mode reduces power consumption even more than normal Sleep mode, and allows Sleep Mode to be set separately for each function. Printing from a computer connected with a USB cable is not available while the machine is asleep. The time required for the machine to wake up from power save mode and resume normal operation will be longer than for normal Sleep Mode.



### NOTE

If the optional Network Interface Kit is installed, Energy Saver cannot be specified.

For more information on Sleep Level settings, refer to the following:

➔ [Quick Setup Wizard \(page 2-49\)](#)

## Energy Saver Recovery Level

This machine can reduce power consumption when recovering from Energy Saver Mode. For EnergySaver RecoveryLevel, "Full Recovery" or "Normal Recovery" can be selected. The factory default is "Normal Recovery".

For more information on Energy Saver Mode settings, refer to the following:

- ➔ [Quick Setup Wizard \(page 2-49\)](#)
- ➔ [Energy Saver Recovery Level \(page 8-9\)](#)

## Weekly Timer Settings

Set the machine to automatically sleep and wake up at times specified for each day.

For more information on Weekly Timer Settings, refer to the following:

- ➔ [Quick Setup Wizard \(page 2-49\)](#)
- ➔ [Weekly Timer Settings \(page 8-9\)](#)

## Power Off Timer (models for Europe)

If the machine is not used while in sleep mode, the power automatically turns off. The Power Off Timer is used to set the time until the power turns off.

The factory setting for the time until the power turns off: 3 days

- ➔ [Power Off Timer \(models for Europe\) \(page 8-9\)](#)

# Quick Setup Wizard

For FAX functions, paper settings, Energy Saver functions and network settings, the following settings can be configured in a wizard-style screen.

<b>FAX Setup</b> <sup>*1</sup>	Configures basic fax settings.	
	Dialing/RX Mode	Dialing Mode Reception Mode Auto (DRD)
	Local FAX Info.	Local FAX Name Local FAX Number Local FAX ID TTI
	Sound	Fax Speaker Volume Fax Monitor Volume Job Finish Buzzer
	Rings	Rings (Normal) Rings (TAD) Rings (Fax/Phone)
	Paper Source/Output	Paper Source Settings
	Redial	Retry Times
	Show Power Off Message	Show Power Off Message
<b>Paper Setup</b>	Configures the paper size and media type of paper to be used in cassettes and multi purpose tray.	
	Cassette 1	Paper Size <sup>*2</sup> Media Type
	Cassette 2 <sup>*3</sup>	Paper Size <sup>*2</sup> Media Type
	Cassette 3 <sup>*3</sup>	Paper Size <sup>*2</sup> Media Type
	Cassette 4 <sup>*3</sup>	Paper Size <sup>*2</sup> Media Type
	Cassette 5 <sup>*3</sup>	Paper Size <sup>*2</sup> Media Type
	MP Tray	Paper Size Media Type

<b>Energy Saver Setup</b>	Configures sleep mode.	
	Sleep Mode	Sleep Timer Sleep Level (models except for Europe)
	Low Power Mode	Low Power Timer
	Recovery Mode	Energy Saver Recovery Level
	Weekly Timer	Weekly Timer Settings Schedule <sup>*4</sup> Retry <sup>*4</sup> Retry Times <sup>*4</sup> Retry Interval <sup>*4</sup>
<b>Network Setup</b>	Configures network settings.	
	Network	Network Selection <sup>*5</sup> Wi-Fi <sup>*6</sup> DHCP <sup>*7</sup> IP Address <sup>*8</sup> Subnet Mask <sup>*8</sup> Default Gateway <sup>*8</sup>
<b>Email Setup</b>	Set SMTP server name and sender address to enable mail sending.	
	Email	SMTP (Email TX) SMTP Server Name <sup>*9</sup> SMTP Port Number <sup>*9</sup> Sender Address <sup>*9</sup>
<b>Security Setup</b>	Specify the security level.	
	Security Quick Setup	

\*1 FAX functions are available only on products with the fax function installed.

\*2 Displayed only when the size dial on the cassette is set to "Other".

\*3 Displayed only when the optional paper feeder is installed.

\*4 This function is displayed when **[Weekly Timer]** is set to **[On]**.

\*5 This function is displayed when the Wireless Network Interface Kit (IB-37 or IB-38) is installed.

\*6 This function is displayed when **[Network Selection]** is set to **[Wi-Fi]**.

\*7 This function is displayed when **[Network Selection]** is set to **[Wired Network]**.

\*8 This function is displayed when **[DHCP]** is set to **[Off]**.

\*9 This function is displayed when **[SMTP (Email TX)]** is set to **[On]**.

## Configuring Settings Quick Setup Wizard

### NOTE

If the User Authentication screen appears, log in with a user who has the privilege to configure this setting. If you do not know your login User Name or Password, please contact your Administrator.

### 1 Display the screen.

[Home] key > [...] > [System Menu] > [Quick Setup Wizard]

### 2 Select a function.

### 3 Configure the settings.

Start the wizard. Follow the instructions on the screen to configure settings.

### NOTE

If you experience difficulty configuring the settings, refer to the following:

➔ [Help Screen \(page 2-31\)](#)

Control	Description
End	Exits the wizard. Settings configured so far are applied.
Previous	Returns to the previous item.
Skip	Advances to the next item without setting the current item.
Next	Advances to the next screen.
Back	Returns to the previous screen.
Complete	Register the settings and exit the wizard.



# Installing Software

To use printer function, TWAIN/WIA connection, or network fax function, download and install prerequisite softwares from our website (<https://kyocera.info/>).

## Published Software (Windows)

Software	Description	Recommended software
KX DRIVER	This driver enables files on a computer to be printed by the machine. Multiple page description languages (PCL XL, KPDL, etc.) are supported by a single driver. This printer driver allows you to take full advantage of the features of the machine. Use this driver to create PDF files.	○
KPDL mini-driver/PCL mini-driver	This is a Microsoft MiniDriver that supports PCL and KPDL. There are some restrictions on the machine features and option features that can be used with this driver.	-
FAX Driver	This makes it possible to send a document created in a computer software application as a fax via the machine.	-
Kyocera TWAIN Driver	This driver enables scanning on the machine using a TWAIN-compliant software application.	○
Kyocera WIA Driver	WIA (Windows Imaging Acquisition) is a function of Windows that enables reciprocal communication between an imaging device such as a scanner and an image processing software application. An image can be acquired using a WIA-compliant software application, which is convenient when a TWAIN-compliant software application is not installed in the computer.	-
KYOCERA Net Viewer	This is a utility that enables monitoring of the machine on the network.	-
Status Monitor	This is a utility that monitors the printer status and provides an ongoing reporting function.	○
File Management Utility	This makes it possible to send and save a scanned document to a specified network folder.	-
KYOCERA Net Direct Print	This makes it possible to print a PDF file without starting Adobe Acrobat/Reader.	-
FONTS	These are display fonts that enable the machine's built-in fonts to be used in a software application.	○
Wi-Fi Setup Tool	This is a tool for wireless network (wireless LAN) configuration of this machine.	-
Scan to Folder Setup Tool for SMB	This is a tool to create a shared folder in personal computers and set the shared folder as a destination.	-



### NOTE

- Installation on Windows must be done by a user logged on with administrator privileges.
- Fax functionality can only be used on products equipped with fax capability.

# Installing Software in Windows

## Downloading and installing from the website

Download and install a software from our website.

### 1 Download a software from the website.

- 1 Launch a web browser.
- 2 Enter "https://kyocera.info/" to the browser's address bar or location bar.

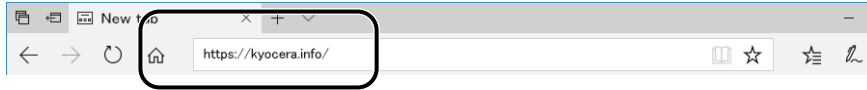

- 3 Enter and search the product name, and select this product from the candidate list.

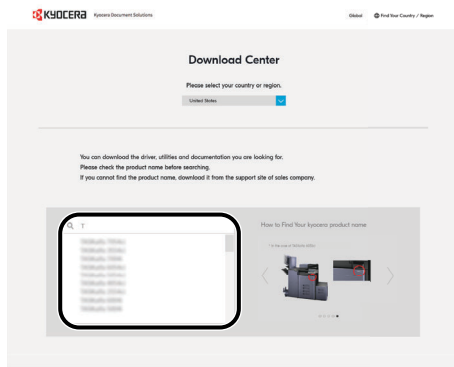

- 4 Change the selected operating system and its language setting as needed.

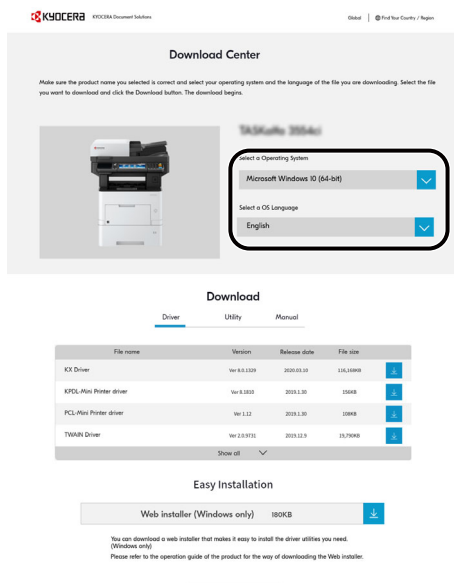

- 5 Click Driver tab or Utility tab > Click  of the software you want to download  
An installer of the selected software will be downloaded.

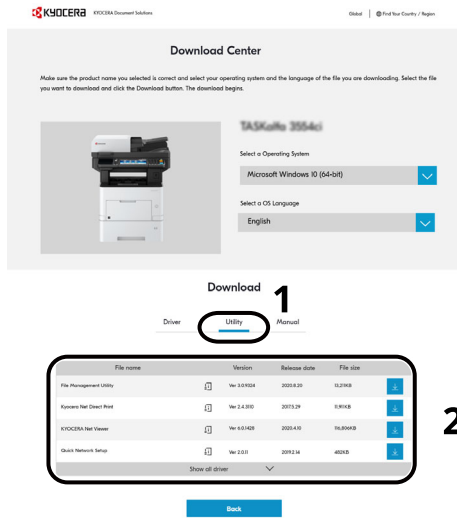

## 2 Double-click the downloaded installer to launch.

Follow the guidance on the screen to install the software.

### NOTE

- Installation on Windows must be done by a user logged on with administrator privileges.
- If the user account management window appears, click **[Yes]** (**[Allow]**).

## Using the web installer

Install a software by using a web installer downloaded from our website.

### 1 Download a software from the website.

- 1 Launch a web browser.
- 2 Enter "https://kyocera.info/" to the browser's address bar or location bar.

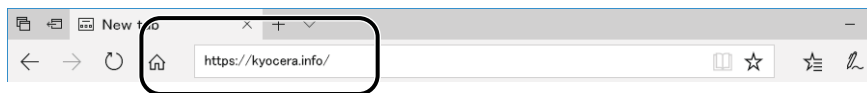

3 Enter and search the product name, and select this product from the candidate list.

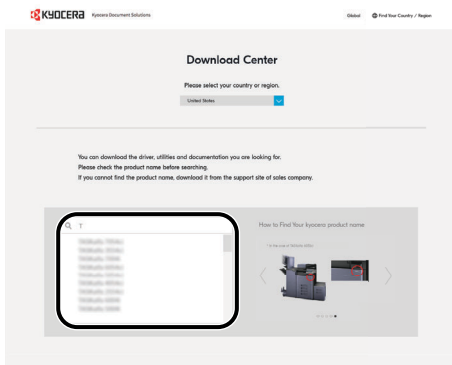

4 Change the selected operating system and its language setting as needed.

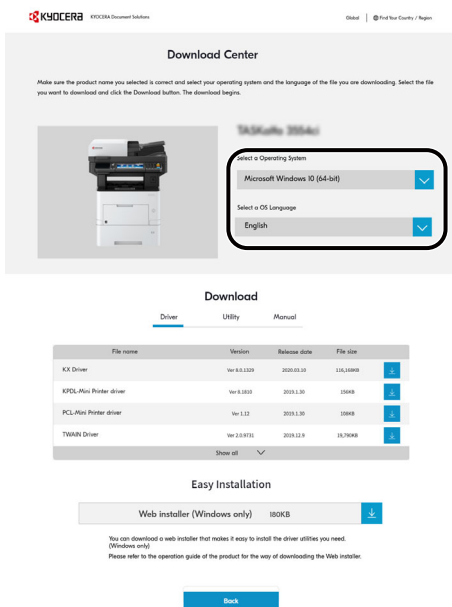

5 Click "Web installer"

A web installer will be downloaded.

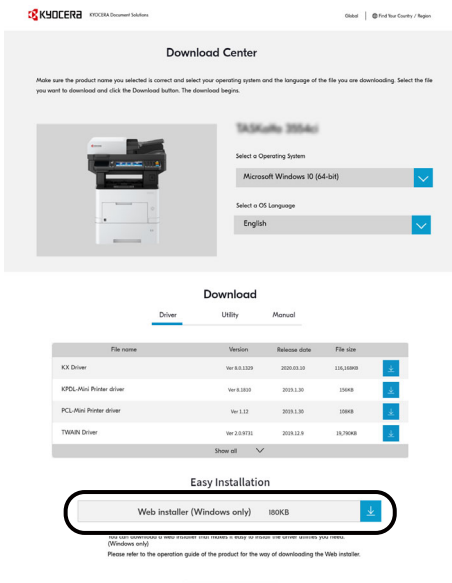

## 2 Double-click the downloaded installer to launch.



### NOTE

- Installation on Windows must be done by a user logged on with administrator privileges.
- If the user account management window appears, click **[Yes]** (**[Allow]**).

## 3 Display the screen.

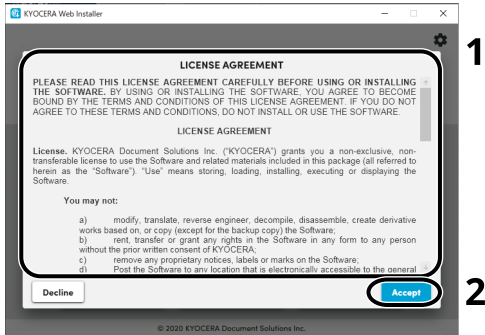

- 1 Read the license agreement.
- 2 Click **[Accept]** if there is no problem.

## 4 Click **[Install]**.

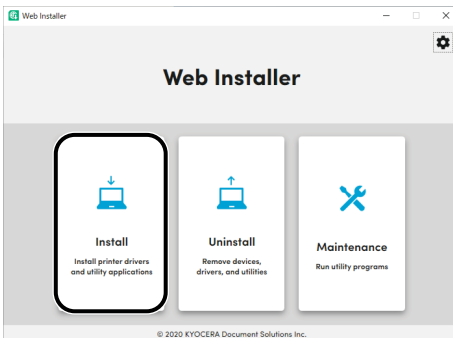

## 5 Select a model and click [Next].

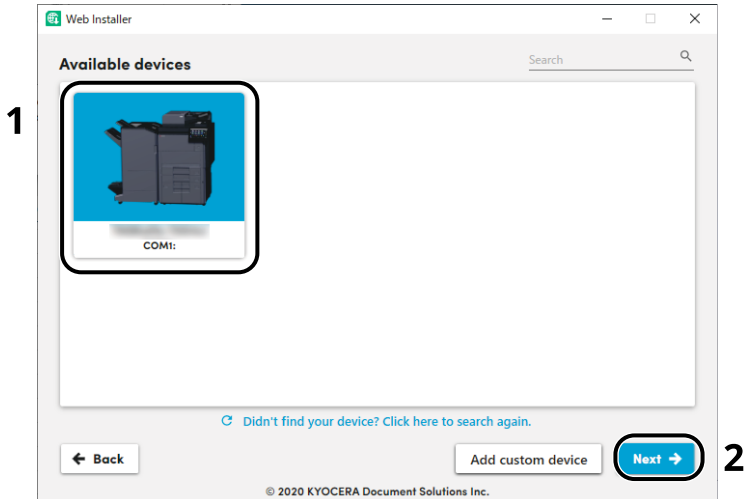

### NOTE

- The machine cannot be detected unless it is on. If the computer fails to detect the machine, verify that it is connected to the computer via a network or USB cable.
- If a desired device is not displayed, select **[Add custom device]** to directly select the device you want to use.

## 6 Install the softwares.

- 1 Select softwares you want to install.

### NOTE

Softwares recommended to install have  in their checkboxes by default. Configure them as needed.

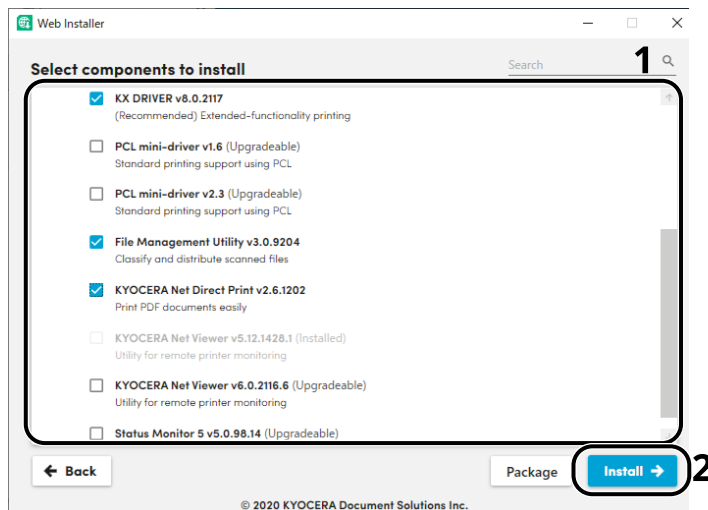

2 Click **[Install]**.

When **[Install]** is clicked, a screen which asks for cooperation for data collection may appear. Select one of the answer choices and click **[OK]**.

**NOTE**

- If the Windows security window appears, click **[Install this driver software anyway]**.
- To install Status Monitor for Windows 8.1, it is necessary to install Microsoft.NET Framework 4.0 beforehand.

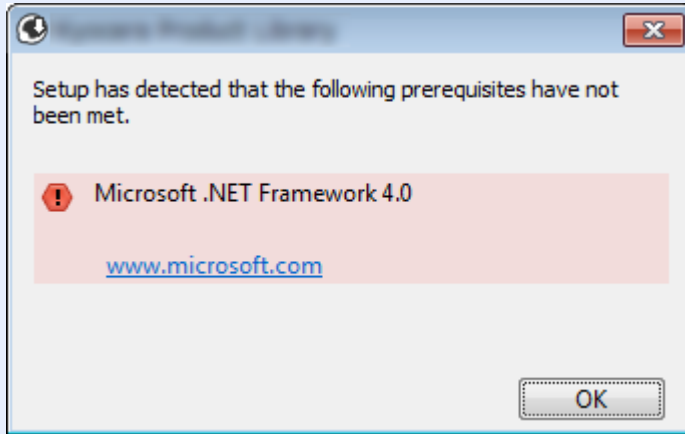

7 **Finish the installation.**

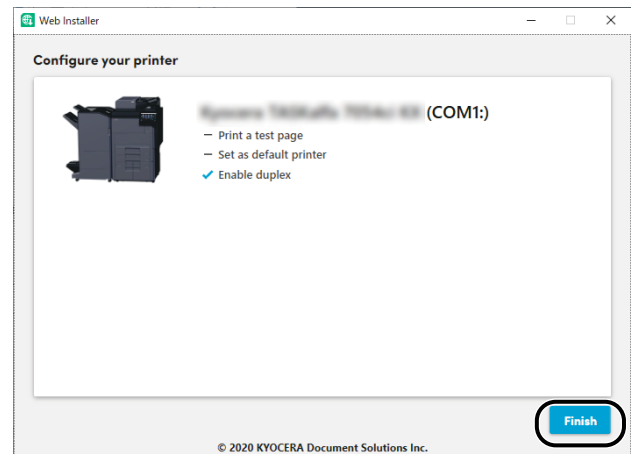
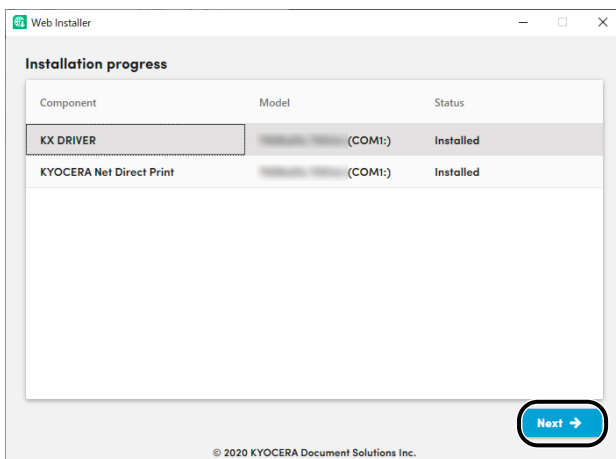

Click **[Next]** > **[Finish]** to finish the installation wizard.

If a system restart message appears, restart the computer by following the screen prompts. This completes the printer driver installation procedure.

## Uninstalling the Software

Perform the following procedure to delete the Software from your computer.

### NOTE

Uninstallation on Windows must be done by a user logged on with administrator privileges.

### 1 Display the screen.

Click the search box in the taskbar, and type "Uninstall Kyocera Product Library" in there. Select [**Uninstall Kyocera Product Library**] in the search list. The Software Uninstall Wizard is displayed.

### NOTE

In Windows 8.1, click [**Search**] in charms, and enter "Uninstall Kyocera Product Library" in the search box. Select [**Uninstall Kyocera Product Library**] in the search list.

### 2 Uninstall the software.

Place a check in the check box of the software to be deleted.

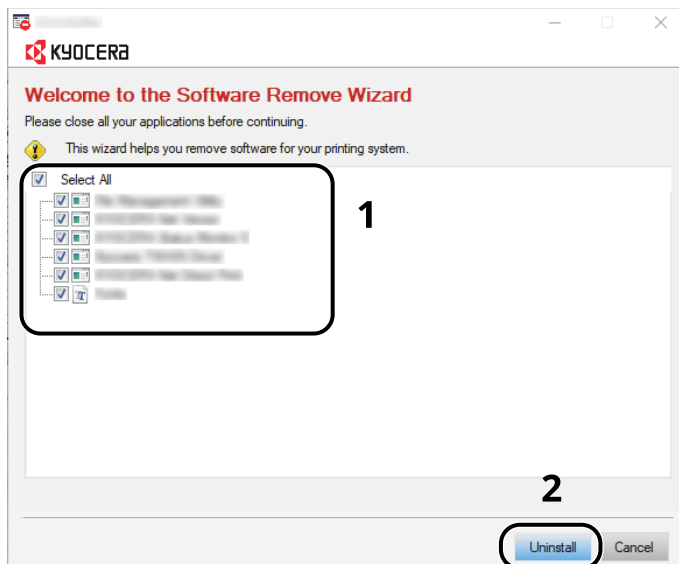

### 3 Finish uninstalling.

If a system restart message appears, restart the computer by following the screen prompts. This completes the software uninstallation procedure.

### NOTE

The software can also be uninstalled using Web Installer. In the screen of Web Installer, click [**Uninstall**], and follow the on-screen instructions to uninstall the software.



## Installing Software in Mac Computer

The machine's printer functionality can be used by a Mac computer.

### NOTE

- Installation on Mac OS must be done by a user logged on with administrator privileges.
- When printing from a Mac computer, set the machine's emulation to **[KPDL]** or **[KPDL(Auto)]**.
- ➔ [Printer \(page 8-33\)](#)
- If connecting by Bonjour, enable Bonjour in the machine's network settings.
- ➔ [Bonjour \(page 8-50\)](#)
- In the Authenticate screen, enter the name and password used to log in to the operating system.
- When printing via AirPrint, you do not have to install the software.

### 1 Download a software from the website.

- 1 Launch a web browser.
- 2 Enter "https://kyocera.info/" into the address bar.

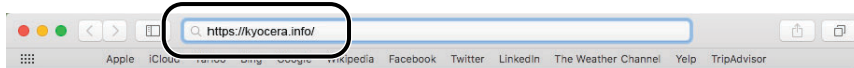

- 3 Enter and search the product name, and select this product from the candidate list.

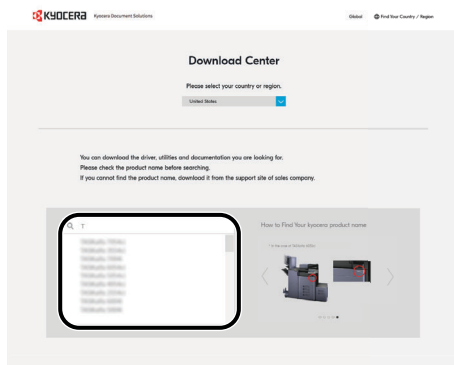

4 Change the selected operating system and its language setting as needed.

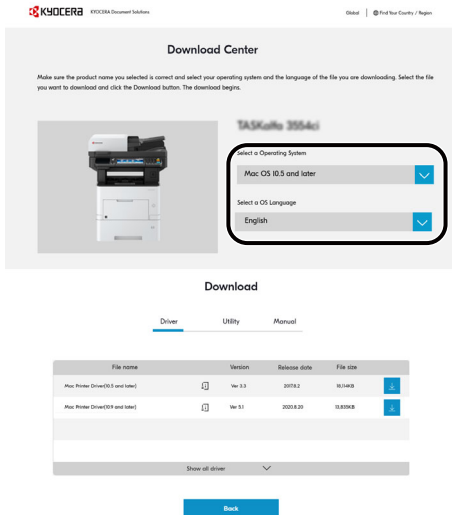

5 Driver tab > Click "Mac Printer Driver(x.x and later)"

An installer of the selected software will be downloaded.

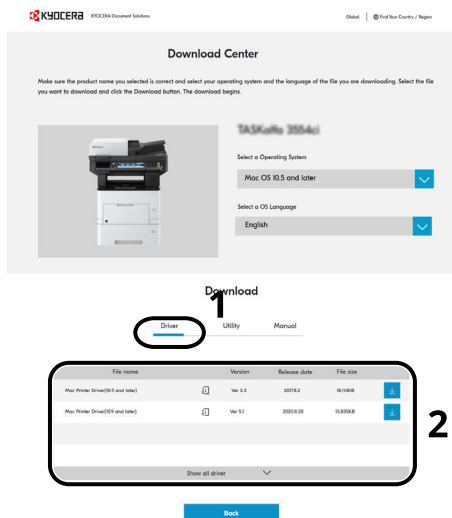

## 2 Install the Printer Driver.

Double click to launch the downloaded installer.

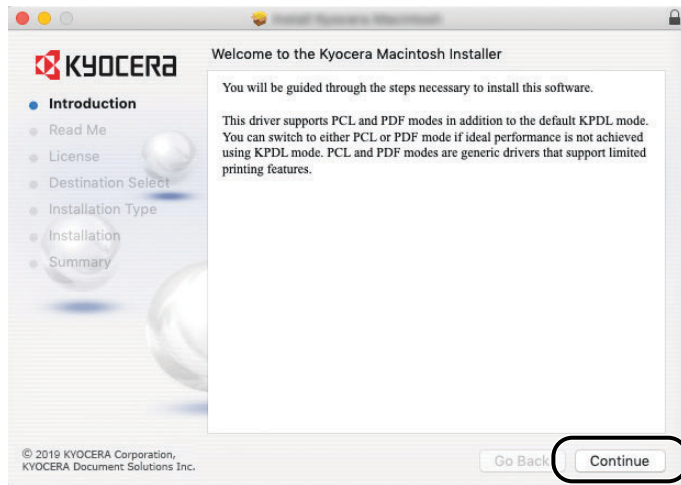

Install the printer driver as directed by the instructions in the installation software.

This completes the printer driver installation.

If a USB connection is used, the machine is automatically recognized and connected.

If an IP connection is used, the settings below are required.

## 3 Configure the printer.

1 Open System Preferences and add the printer.

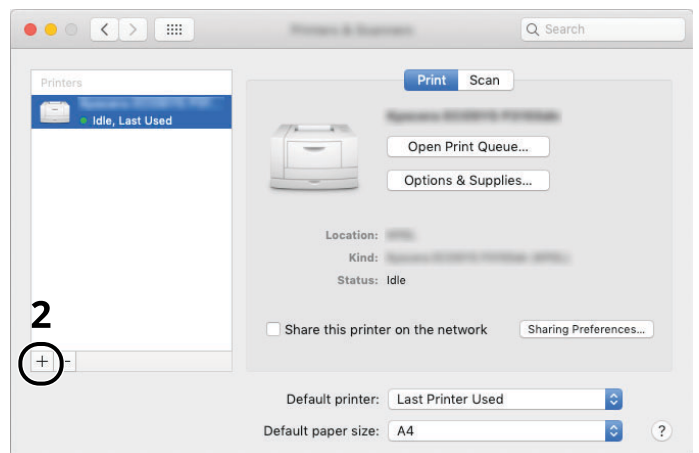
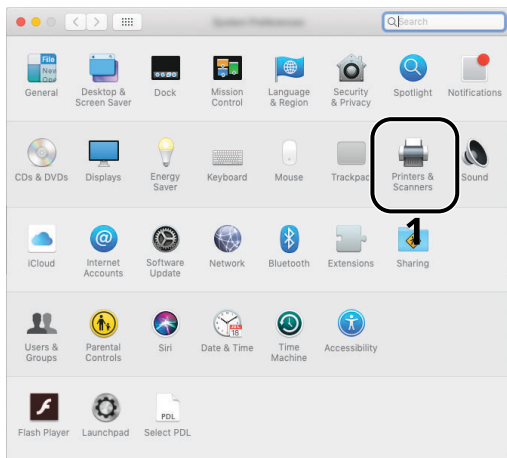

- 2 Select [**Default**] and click the item that appears in "Name" and then select the driver in "Use".

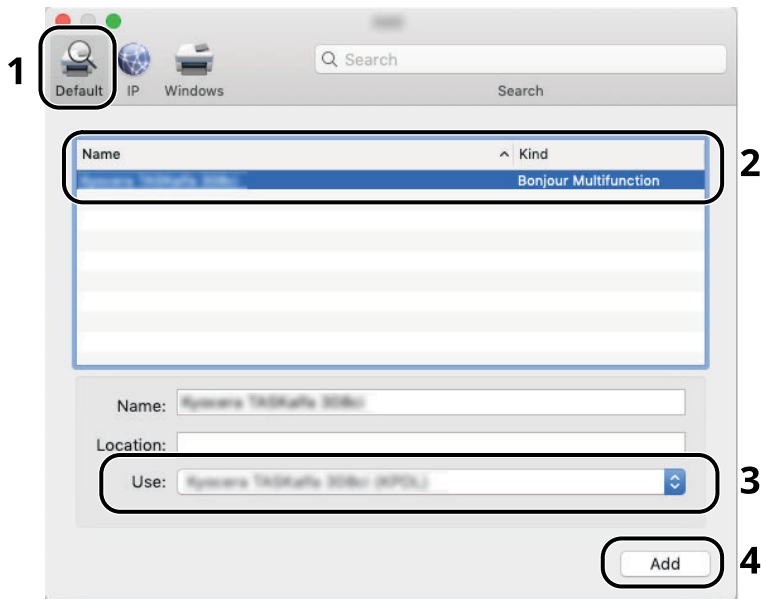

- 3 The selected machine is added.

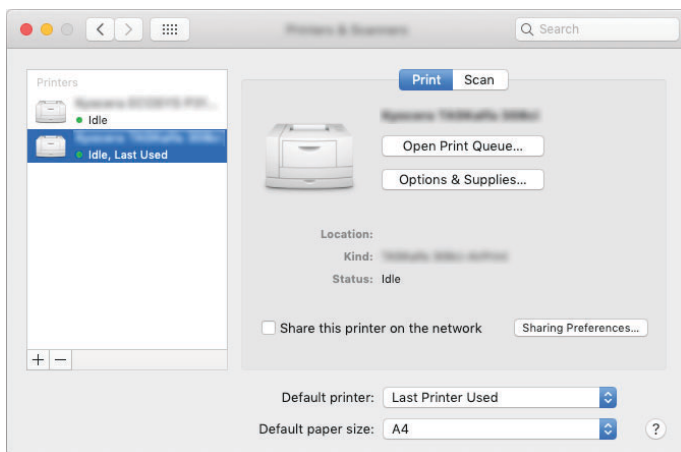

**NOTE**

When using an IP connection, click the IP icon for an IP connection and then enter the host name or IP address. The number entered in "Address" will automatically appear in "Name". Change if needed.

- 4 Select the printer added newly, and click the [**Options & Supplies...**] to select the options equipped with the machine.

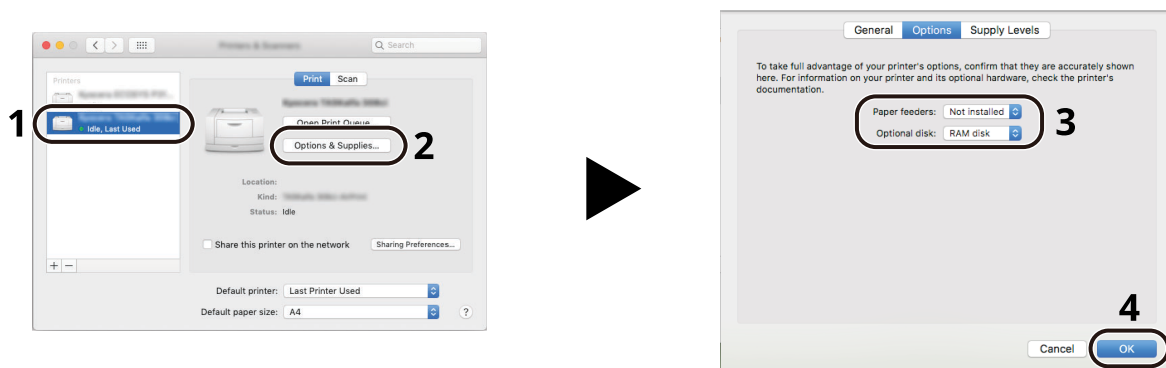

## Setting TWAIN Driver

Register this machine to the TWAIN Driver. Instructions are based on interface elements as they appear in Windows 10.

### 1 Display the screen.

- 1 Click Search box in taskbar, and enter "TWAIN Driver Setting" in the search box. Select **[TWAIN Driver Setting]** in the search list.



#### NOTE

In Windows 8.1, Click **[Search]** in charms, and enter "TWAIN Driver Setting" in the search box. Select **[TWAIN Driver Setting]** in the search list.

- 2 Click **[Add]**.

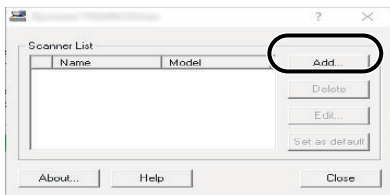

### 2 Configure TWAIN Driver.

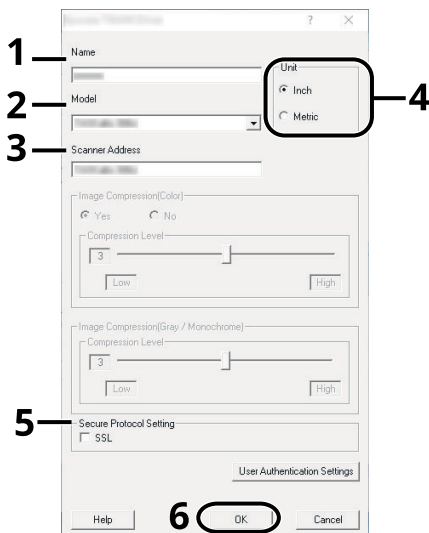

- 1 Enter the machine name.
- 2 Select this machine from the list.
- 3 Enter the machine's IP address or host name.
- 4 Set units of measurement.
- 5 When using SSL, select the checkbox beside SSL.
- 6 Click **[OK]**.



#### NOTE

When the machine's IP address or host name is unknown, contact Administrator.

### 3 Finish registering.

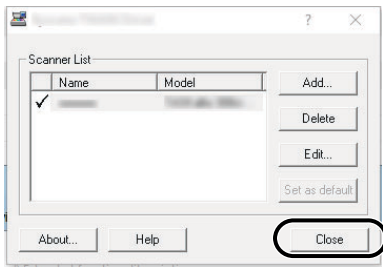

#### NOTE

Click [**Delete**] to delete the added machine. Click [**Edit**] to change names.

## Setting WIA Driver

Register this machine to the WIA Driver. Instructions are based on interface elements as they appear in Windows 10.

### 1 Display the screen.

- 1 Click Search box in taskbar, and enter "View scanners and cameras" in the search box. Select **[View scanners and cameras]** in the search list then the Scanners and Cameras screen appears.

#### NOTE

In Windows 8.1, click **[Search]** in charms, and enter "View scanners and cameras" in the search box. Select **[View scanners and cameras]** in the search list then the Scanners and Cameras screen appears.

- 2 Select the same name as this machine from WIA Drivers, and click **[Properties]**.

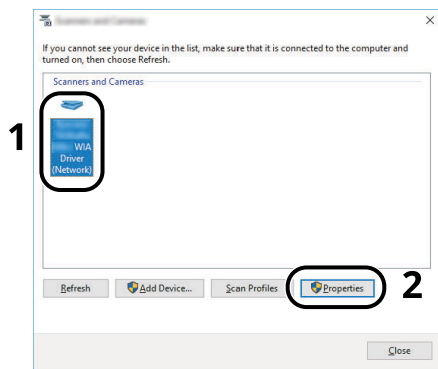

### 2 Configure WIA Driver.

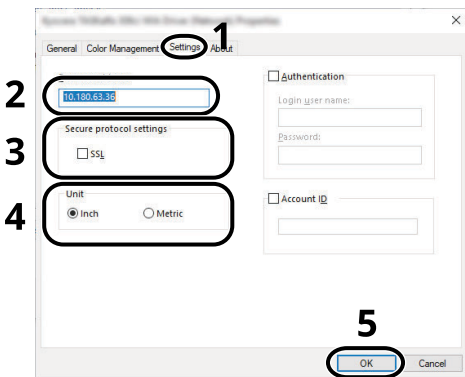

- 1 Click the **[Settings]** tab.
- 2 Enter the machine IP addresses or host name.
- 3 When using SSL, select the checkbox beside SSL.
- 4 Set units of measurement.
- 5 Click **[OK]**.

## Checking the Counter

Check the number of sheets printed and scanned.

- 1 Display the screen.**  
[Home] key > [...] > [Counter]
- 2 Check the counter.**



# Additional Preparations for the Administrator

## Administrator Privileges Overview

This machine is shipped with two default users registered one with Machine Administrator privileges, and another with Administrator privileges. The user with Machine Administrator privileges and the user with Administrator privileges can configure important settings for the machine. The differences in the privileges are as follows:

### User with Machine Administrator privileges

This user can configure the product's network settings, security settings such as user registration, and the machine's security level.

➔ [Security Level \(page 8-57\)](#)

### User with Administrator privileges

This user can configure the product's network settings, user registration, and other security settings. This user cannot set the machine's security level.

## Log in as Machine Administrator or Administrator

The user with Machine Administrator privileges or the user with Administrator privileges must log in to configure important settings for the product, such as network settings and security settings. The factory default login user name and login password are set as shown below.

### Machine Administrator

<b>User Name</b>	DeviceAdmin
<b>Login User Name</b>	ECOSYS MA6000ifx: 6000, ECOSYS MA5500ifx: 5500, ECOSYS MA4500ifx: 4500, ECOSYS MA4500ix: 4500
<b>Login Password</b>	ECOSYS MA6000ifx: 6000, ECOSYS MA5500ifx: 5500, ECOSYS MA4500ifx: 4500, ECOSYS MA4500ix: 4500

### Administrator

<b>User Name</b>	Admin
<b>Login User Name</b>	Admin
<b>Login Password</b>	xxxxxxxxxx (Serial Number) ➔ <a href="#">Checking the Equipment's Serial Number (page i)</a>

#### IMPORTANT

To ensure security, be sure to change the factory default user name, login user name, and login password. Also, change your password regularly.

➔ [Changing User Properties \(page 9-9\)](#)

## Strengthening the Security

This machine is shipped with two default users registered one with Machine Administrator rights, and another with Administrator rights. Logging in as this user will allow you to configure all settings; therefore, please change the login user name and password.

In addition, this machine is equipped with user authentication function, which can be configured to limit the access to this machine to only those who have a registered login name and password.

➔ [User Authentication and Accounting \(User Login, Job Accounting\) \(page 9-1\)](#)

I want to...	Function	Reference page
<b>Restrict the users of the machine.</b>	User Login	<a href="#">page 9-2</a>
	Authentication Security	<a href="#">page 9-4</a>
	Auto Panel Reset	<a href="#">page 8-8</a>
	ID Card Settings <sup>*1</sup>	<a href="#">page 9-29</a>
<b>Restrict the basic functions that can be used.</b>	Local Authorization	<a href="#">page 9-16</a>
	Group Authorization Set.	<a href="#">page 9-19</a>
	Guest Authorization Set.	<a href="#">page 9-21</a>
<b>Prevent another user from handling the documents stored in the machine.</b>	Custom Box <sup>*2</sup>	<a href="#">page 5-50</a>
<b>Output the document stored in the machine at the time when user operates the device via operation panel.</b>	Remote Printing	<a href="#">page 8-35</a>
<b>Prevent the data stored in the machine from being leaked.</b>	Data Overwrite <sup>*3</sup>	Refer to the <b>Data Security Kit (E) Operation Guide.</b>
	Encryption <sup>*3</sup>	
	PDF Encryption Functions	<a href="#">page 6-39</a>
<b>Completely delete the data on the machine before disposing of the machine.</b>	Data Sanitization	<a href="#">page 8-59</a>

\*1 The optional Card Authentication Kit is required.

\*2 The optional SSD is required.

\*3 The optional Data Security Kit is required.

I want to...	Function	Reference page
<b>Protect the transmission from interception and wiretapping.</b>	IPP over TLS	<a href="#">page 8-47</a>
	HTTPS	<a href="#">page 8-48</a>
	LDAP Security	Refer to the <b>Command Center RX User Guide</b> .
	SMTP Security	<a href="#">page 8-46</a>
	POP3 Security	<a href="#">page 8-46</a>
	FTP Encrypted TX	<a href="#">page 6-45</a>
	Enhanced WSD (TLS)	<a href="#">page 8-48</a>
	IPSec	<a href="#">page 8-51</a>
SNMPv3	<a href="#">page 8-48</a>	
<b>Verify the software in the machine.</b>	Software Verification	<a href="#">page 8-57</a>
<b>Preventing from execution of the unauthorized programs.</b>	Allowlisting	<a href="#">page 8-58</a>

# Command Center RX

If the machine is connected to the network, you can configure various settings using Command Center RX. This section explains how to access Command Center RX, and how to change security settings and the host name.

## ➔ Command Center RX User Guide

### NOTE

To fully access the features of the Command Center RX pages, enter the User Name and Password and click **[Login]**. Entering the predefined administrator password allows the user to access all pages, including Document Box, Address Book, and Settings on the navigation menu.

Settings that the administrator and general users can configure in Command Center RX are as follows.

Setting	Description	Administ -rator	General User
<b>Device Information/ Remote Operation</b>	The machine's structure can be checked.	<input type="radio"/>	<input type="radio"/>
<b>Job Status</b>	Displays all device information, including print and scan jobs, storing jobs, scheduled jobs, and job log history.	<input type="radio"/>	<input type="radio"/>
<b>Document Box</b>	Add or delete document boxes, or delete documents within a document box.	<input type="radio"/>	<input type="radio"/> *1
<b>Address Book</b>	Create, edit, or delete addresses and address groups.	<input type="radio"/>	<input type="radio"/> *1
<b>Device Settings</b>	Configure the advanced settings of the machine.	<input type="radio"/>	-
<b>Function Settings</b>	Configure the advanced function settings.	<input type="radio"/>	-
<b>Network Settings</b>	Configure the network advanced settings.	<input type="radio"/>	-
<b>Security Settings</b>	Configure the security advanced settings.	<input type="radio"/>	-
<b>Management Settings</b>	Configure the advanced management settings.	<input type="radio"/>	-

\*1 The logged in user may not be able to configure some settings, depending on the permissions of the user.

### NOTE

- FAX functions are available only on products with the fax function installed.
- Here, information on the FAX settings has been omitted.

## ➔ FAX Operation Guide

# Accessing Command Center RX

## 1 Display the screen.

- 1 Launch your Web browser.
- 2 In the address or location bar, enter the machine's IP address or the host name.

Click in the following order to check the machine's IP address and the host name.

[**Device Information**] in the home screen > [**Identification/Wired Network**]

Examples:     https://10.180.81.3/ (for IP address)  
                   https://MFP001 (if the host name is "MFP001")

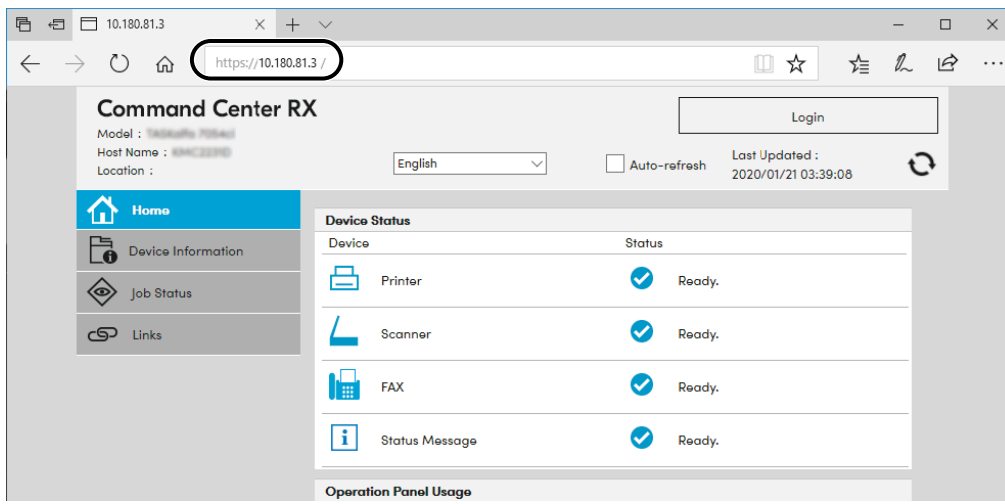

The web page displays basic information about the machine and Command Center RX as well as their current status.

### NOTE

If the screen "There is a problem with this website's security certificate." is displayed, configure the certificate.

#### ➔ **Command Center RX User Guide**

You can also continue the operation without configuring the certificate.

## 2 Configure the function.

Select a category from the navigation bar on the left of the screen.

### NOTE

To fully access the features of the Command Center RX pages, enter the User Name and Password and click [**Login**]. Entering the predefined administrator password allows the user to access all pages, including Document Box, Address Book, and Settings on the navigation menu.

## Changing Security Settings

### 1 Display the screen.

- 1 Launch your Web browser.
- 2 In the address or location bar, enter the machine's IP address or the host name.  
Click in the following order to check the machine's IP address and the host name.  
[Device Information] in the home screen > [Identification/Wired Network]
- 3 Log in with administrator privileges.

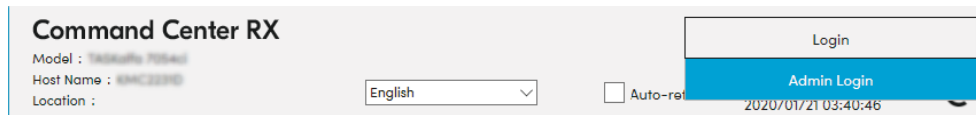

- 4 Click [Security Settings].

### 2 Configure the Security Settings.

From the [Security Settings] menu, select the setting you want to configure.

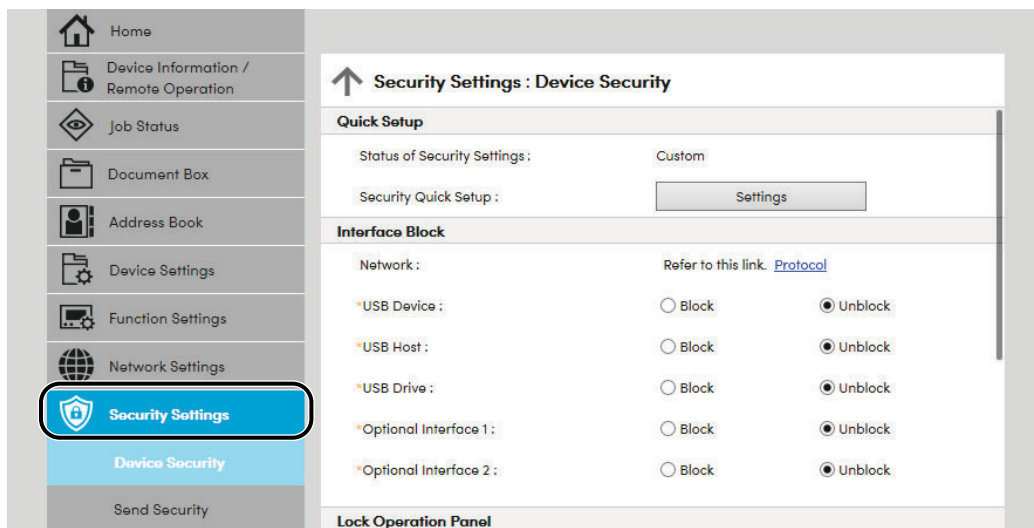

#### NOTE

For details on settings related to certificates, refer to the following:

➔ **Command Center RX User Guide**

## Changing Device Information

### 1 Display the screen.

- 1 Launch your Web browser.
- 2 In the address or location bar, enter the machine's IP address or the host name.  
Click in the following order to check the machine's IP address and the host name.  
[Device Information] in the home screen > [Identification/Wired Network]
- 3 Log in with administrator privileges.

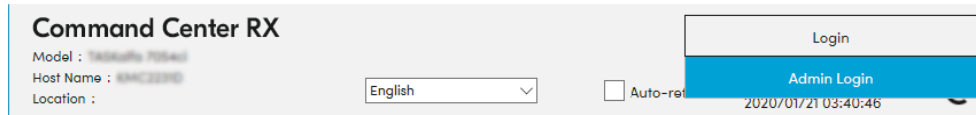

- 4 From the [Device Settings] menu, click [System].

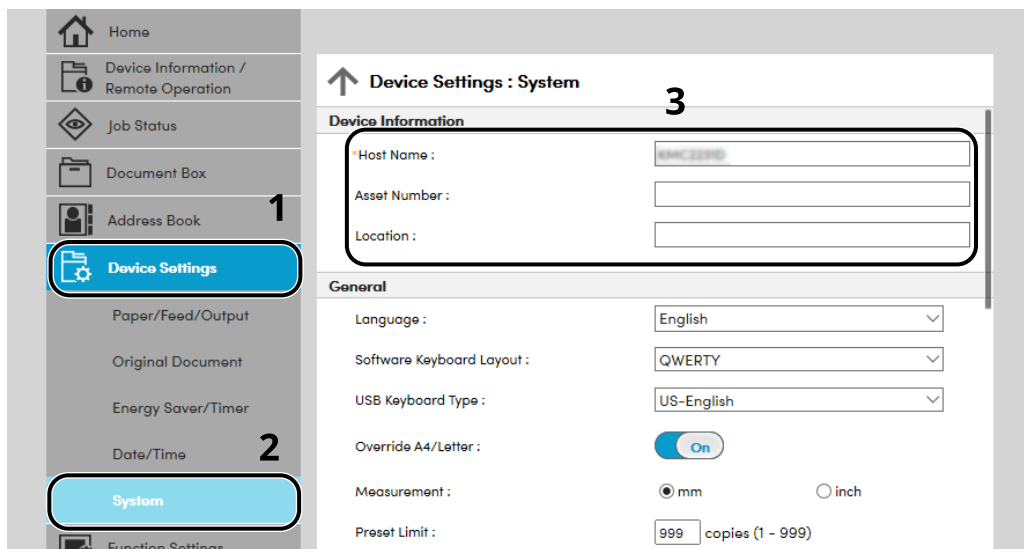

### 2 Specify the host name.

Enter the device information, and then click [Submit].

#### ✔ IMPORTANT

After changing the setting, restart the network or turn the machine OFF and then ON.

To restart the network interface card, click [Reset] in the [Management Settings] menu, and then click [Restart Network] in "Restart".

## E-mail Settings

By configuring the SMTP settings, it is possible to send the images scanned by the machine as E-mail attachments and to send E-mail notices when jobs have been completed.

To use this function, this machine must be connected to a mail server using the SMTP protocol.

In addition, configure the following.

- SMTP settings  
Item: "SMTP Protocol" and "SMTP Server Name" in "SMTP"
- The sender address when the machine sends E-mails  
Item: "Sender Address" in "E-mail Send Settings"
- The setting to limit the size of E-mails  
Item: "E-mail Size Limit" in "E-mail Send Settings"

The procedure for specifying the SMTP settings is explained below.

### 1 Display the screen.

Display the SMTP Protocol screen.

- 1 Launch your Web browser.
- 2 In the address or location bar, enter the machine's IP address or the host name.  
Click in the following order to check the machine's IP address and the host name.  
[Device Information] in the home screen > [Identification/Wired Network]
- 3 Log in with administrator privileges.

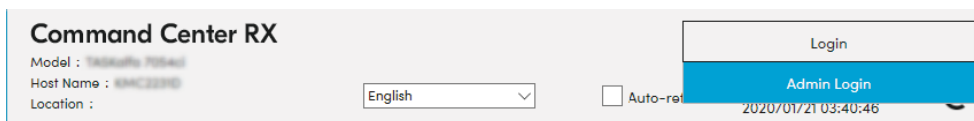

- 4 From the [Network Settings] menu, click [Protocol].

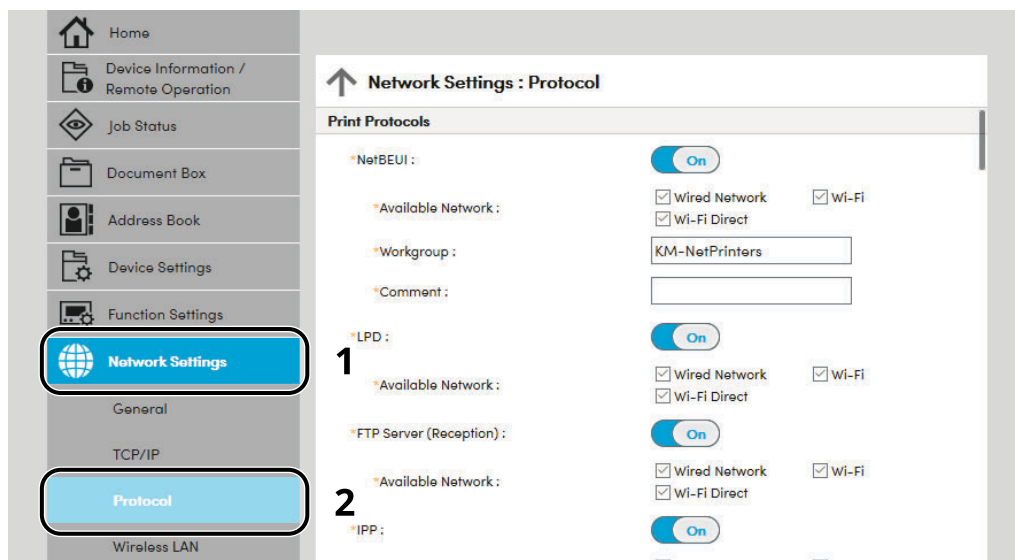



## 2 Configure the settings.

Set "SMTP (E-mail TX)" to **[On]** in the "Send Protocols".

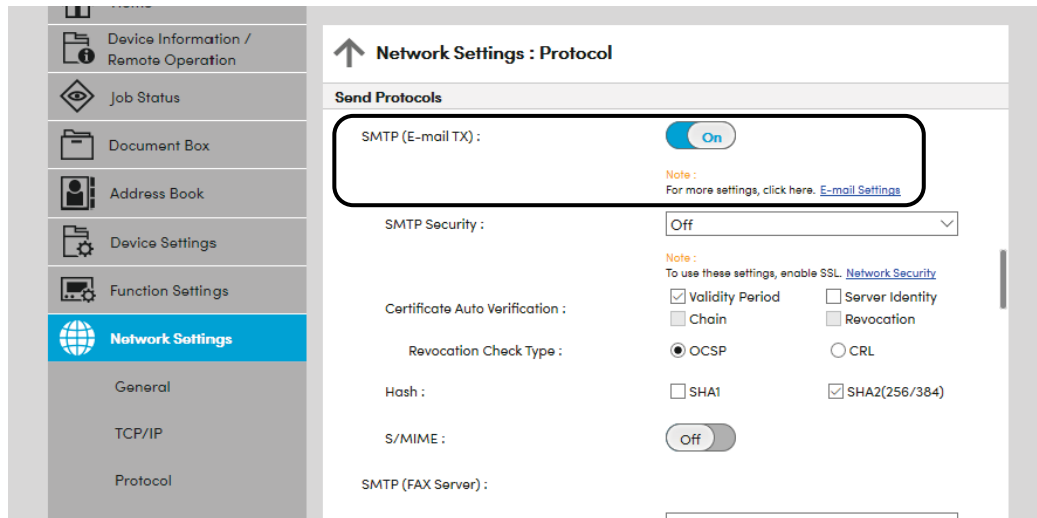

## 3 Display the screen.

Display the E-mail Settings screen.

From the **[Function Settings]** menu, click **[E-mail]**.

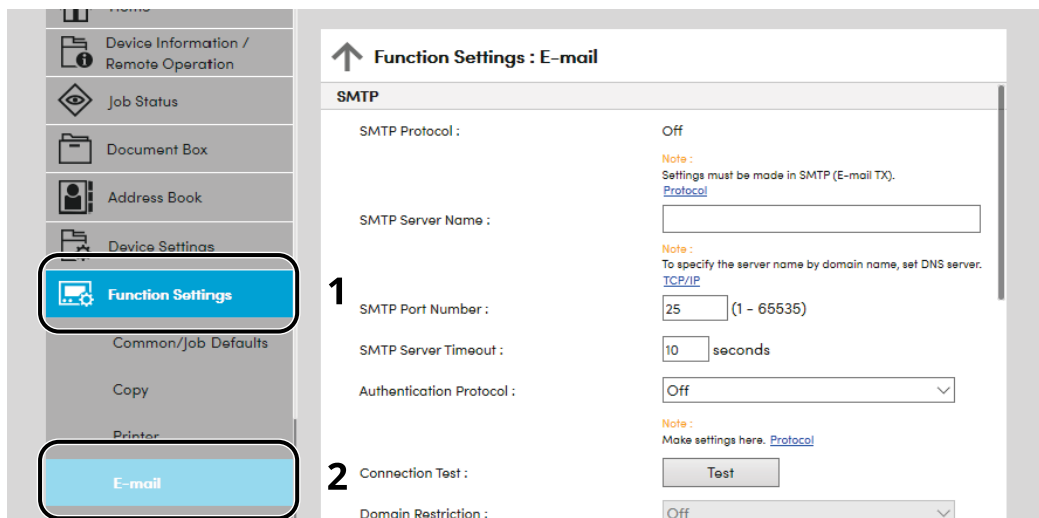

## 4 Configure the settings.

Enter "SMTP" and "E-mail Send Settings" items.

Setting	Description
<b>SMTP</b>	Set to send e-mail from the machine.
<b>SMTP Protocol</b>	Displays the SMTP protocol settings. Check that "SMTP Protocol" is set to <b>[On]</b> . If <b>[Off]</b> is set, click <b>[Protocol]</b> and set the SMTP protocol to <b>[On]</b> .
<b>SMTP Server Name*<sup>1</sup></b>	Enter the host name or IP address of the SMTP server.
<b>SMTP Port Number</b>	Specify the port number to be used for SMTP. The default port number is 25.
<b>SMTP Server Timeout</b>	Set the amount of time to wait before time-out in seconds.
<b>Authentication Protocol</b>	To use SMTP authentication, enter the user information for authentication.
<b>SMTP Security</b>	Set SMTP security. Turn on "SMTP Security" in "SMTP (E-mail TX)" on the <b>[Protocol Settings]</b> page.
<b>Connection Test</b>	Tests to confirm that the E-mail function is operating under the settings without sending a mail.
<b>Domain Restriction</b>	To restrict the domains, click the <b>[Domain List]</b> and enter the domain names of addresses to be allowed or rejected. Restriction can also be specified by e-mail address.
<b>POP3</b>	You don't need to set the following items when you only enable the function of sending e-mail from the machine. Set the following items if you want to enable the function of receiving e-mail on the machine.  ➡ <b>Command Center RX User Guide</b>
<b>POP3 Protocol</b>	
<b>Check Interval</b>	
<b>Run once now</b>	
<b>Domain Restriction</b>	
<b>POP3 User Settings</b>	
<b>E-mail Send Settings</b>	
<b>E-mail Size Limit</b>	Enter the maximum size of E-mail that can be sent in kilobytes. When E-mail size is greater than this value, an error message appears and E-mail sending is cancelled. Use this setting if you have set E-mail Size Limit for SMTP server. If not, enter a value of 0 (zero) to enable E-mail sending regardless of the size limit.
<b>Sender Address*<sup>1</sup></b>	Specify the sender address for when the machine sends E-mails, such as the machine administrator, so that a reply or non-delivery report will go to a person rather than to the machine. The sender address must be entered correctly for SMTP authentication. The maximum length of the sender address is 128 characters.
<b>Signature</b>	Enter the signature. The signature is free form text that will appear at the end of the E-mail body. It is often used for further identification of the machine. The maximum length of the signature is 512 characters.
<b>Function Defaults</b>	Change the function default settings in <b>[Common/Job Default Settings]</b> page.

\*1 Be sure to enter the items.

## 5 Click [Submit].

## Registering Destinations

### 1 Display the screen.

- 1 Launch your Web browser.
- 2 In the address or location bar, enter the machine's IP address or the host name.  
Click in the following order to check the machine's IP address and the host name.  
[Device Information] in the home screen > [Identification/Wired Network]
- 3 Log in with administrator privileges.

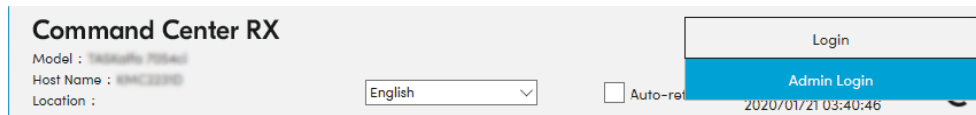

- 4 From the [Address Book] menu, click [Machine Address Book].

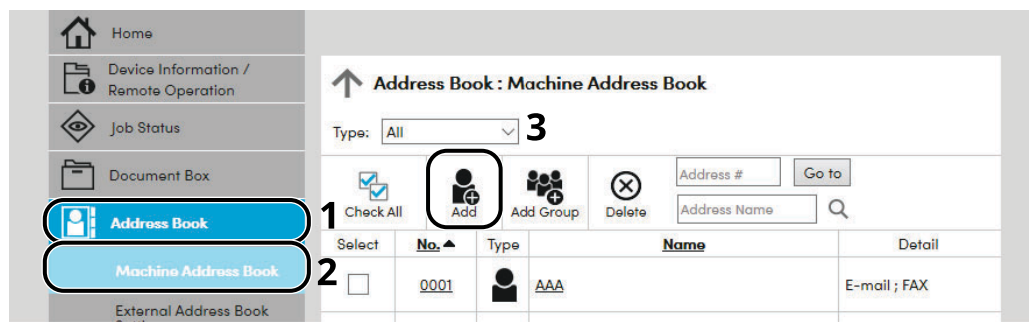

- 5 Click [Add].

### 2 Populate the fields.

- 1 Enter the destination information.  
Enter the information for the destination you want to register. The fields to populate are the same as when registering via operation panel.  
➔ [Registering Destinations in the Address Book \(page 3-33\)](#)
- 2 Click [Submit].

## Creating a New Custom Box



### NOTE

To use Custom Box, an optional SSD must be installed in the machine.

## 1 Display the screen.

- 1 Launch your Web browser.
- 2 In the address or location bar, enter the machine's IP address or the host name.  
Click in the following order to check the machine's IP address and the host name.  
[Device Information] in the home screen > [Identification/Wired Network]
- 3 From the [Document Box] menu, click [Custom Box].

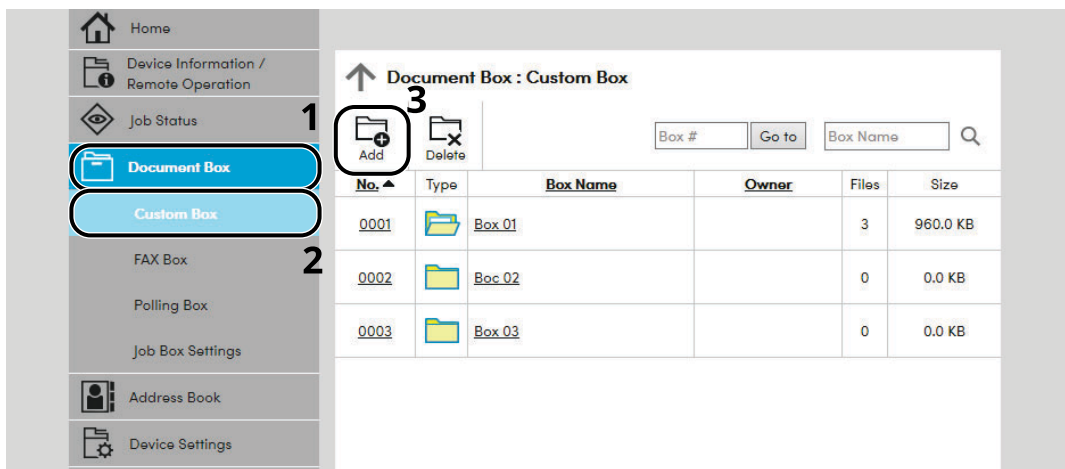

- 4 Click [Add].

## 2 Configure the Custom Box.

- 1 Enter the box details.  
Enter the information for the custom box you want to register. For details on the fields to populate, refer to the following:  
➔ **Command Center RX User Guide**
- 2 Click [Submit].

## Printing a document stored in a Custom Box

### 1 Display the screen.

- 1 Launch your Web browser.
- 2 In the address or location bar, enter the machine's IP address or the host name.  
Click in the following order to check the machine's IP address and the host name.  
[Device Information] in the home screen > [Identification/Wired Network]
- 3 From the [Document Box] menu, click [Custom Box].

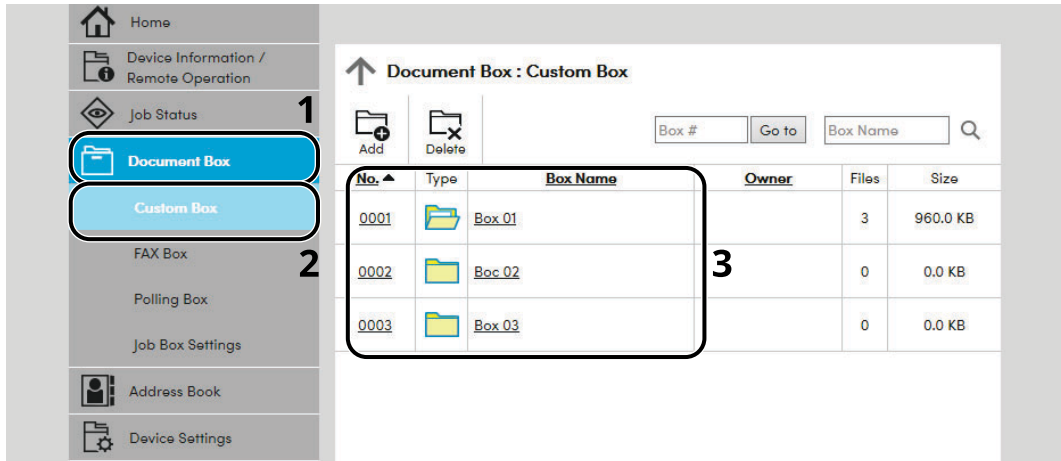

- 4 Click the number or name of the Custom Box in which the document is stored.

### 2 Print the document.

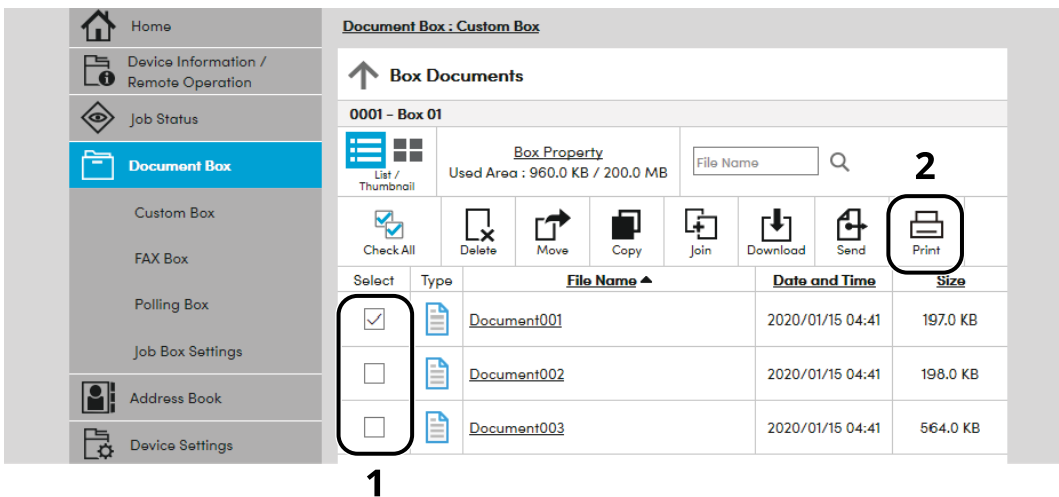

- 1 Select the document you wish to print.  
Select the checkbox of the document to be printed.
- 2 Click [Print].
- 3 Configure settings for printing, click [Print].

# Transferring Data from Our Other Products

By using the machine's utility, you can smoothly migrate address books when the machine is to be replaced. This section explains how to transfer data between our products.

## Migrating the Address Book

The Address Book registered on the machine can be backed up or migrated using the KYOCERA Net Viewer downloaded from our website.

For details on operating the KYOCERA Net Viewer, refer to the following:

➔ **KYOCERA Net Viewer User Guide**

### Backing Up Address Book Data to PC

**1** Launch the KYOCERA Net Viewer.

**2** Create a backup.

- 1 Right-click on the model name from which you want to back up the Address Book, and select **[Advanced]** - **[Set multiple devices]**.

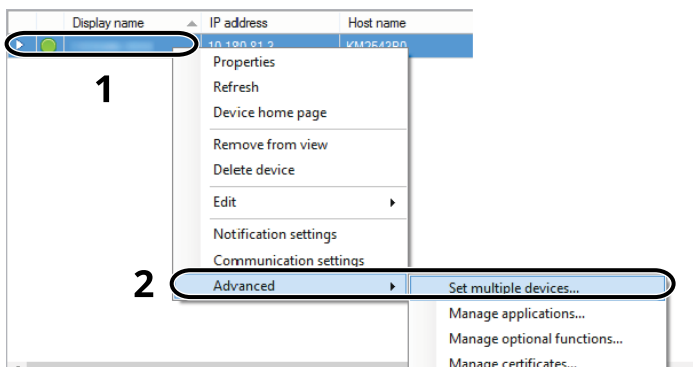

- 2 Select **[Custom Mode]** and click **[Next]**.

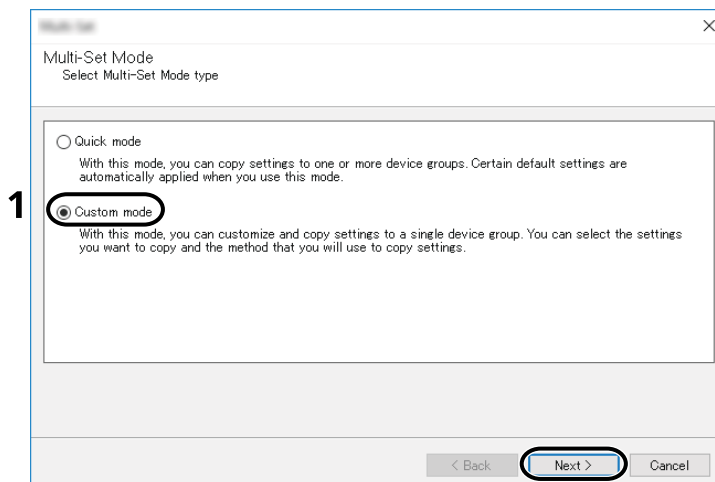

**2**

3 Select destination device group and click **[Next]**.

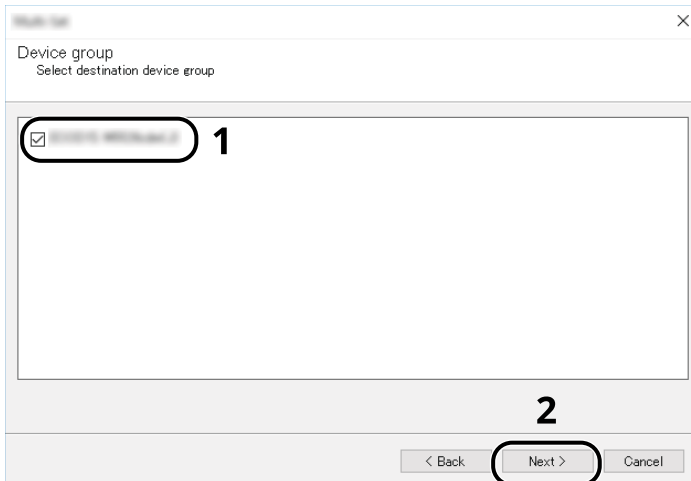

4 Select **[Device Address Book]** and click **[Next]**.

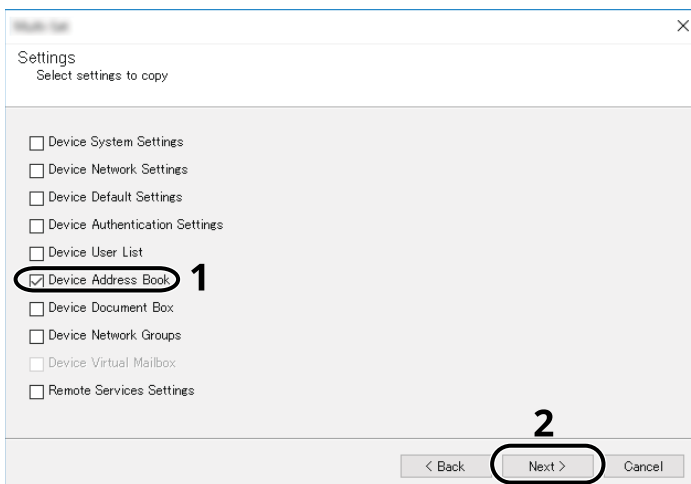

5 Select **[Create from device]** and remove the checkmark from **[Overwrite settings on target device]**, and then click **[Next]**.

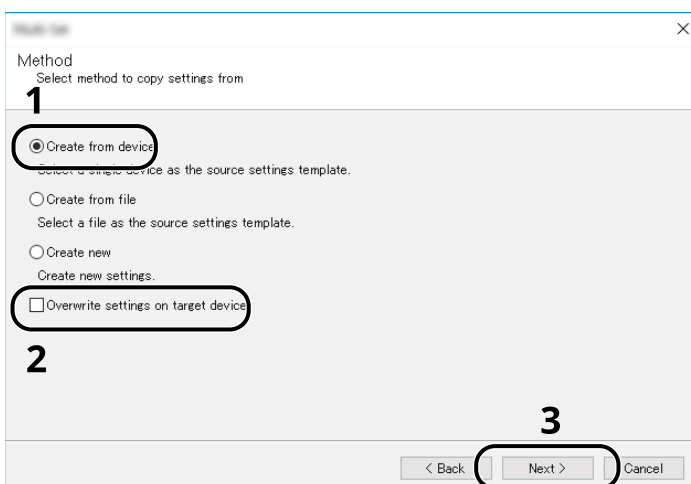

- 6 Select the model you want to back up, and click **[Next]**.

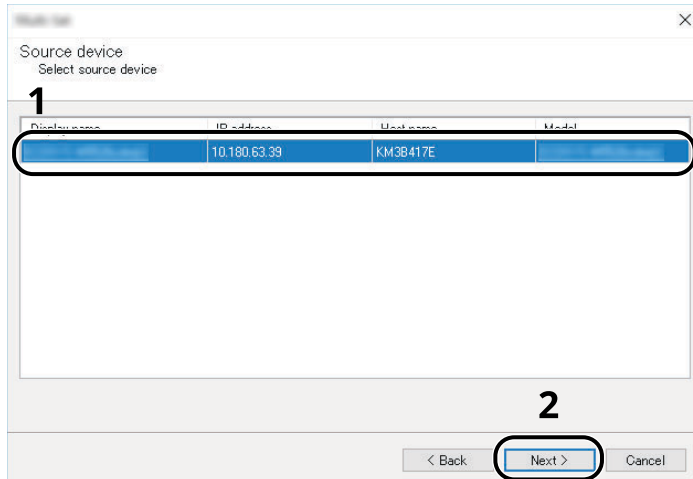

**NOTE**

If the "Admin Login" screen appears, enter the "Admin Login" and "Login Password", and then click **[OK]**.

- 7 Click on **[Save to file]**.

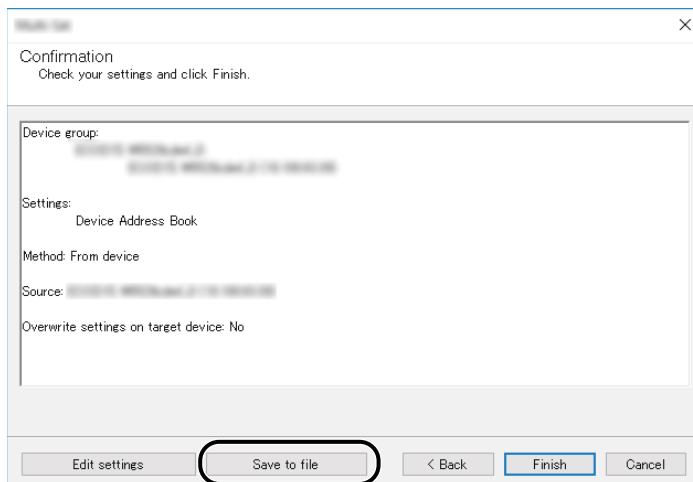

- 8 Specify the location to save the file, enter the file name, and then click **[Save]**.  
For "Save as type", make sure to select "XML File".



- 9 After saving the file, always click [**Cancel**] to close the screen.

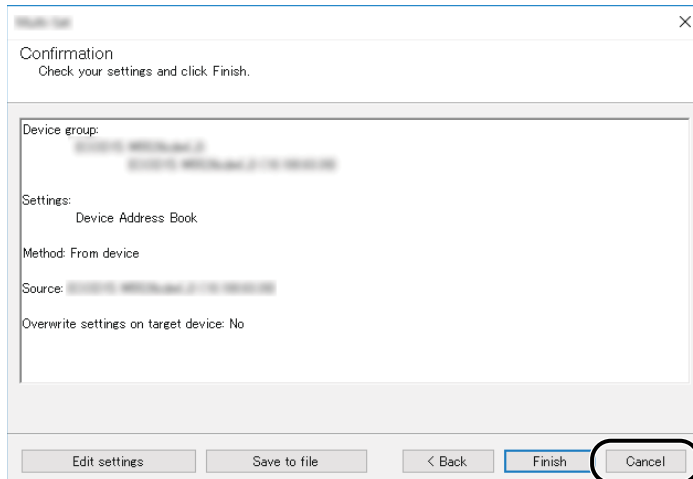

Please note that selecting [**Finish**] will write the data to the machine's Address Book.

## Writing Address Book Data to the Machine

- 1 Launch the KYOCERA Net Viewer.

- 2 Load the Address Book data.

- 1 Right-click on the model name from which you want to back up the Address Book, and select [**Advanced**] - [**Set multiple devices**].

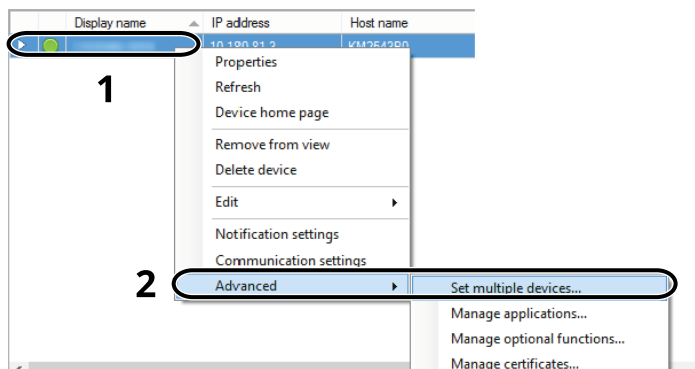

2 Select **[Custom Mode]** and click **[Next]**.

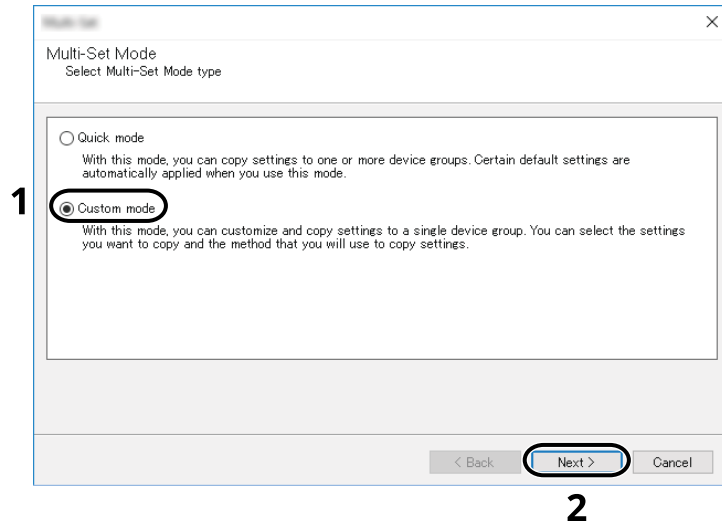

3 Select destination device group and click **[Next]**.

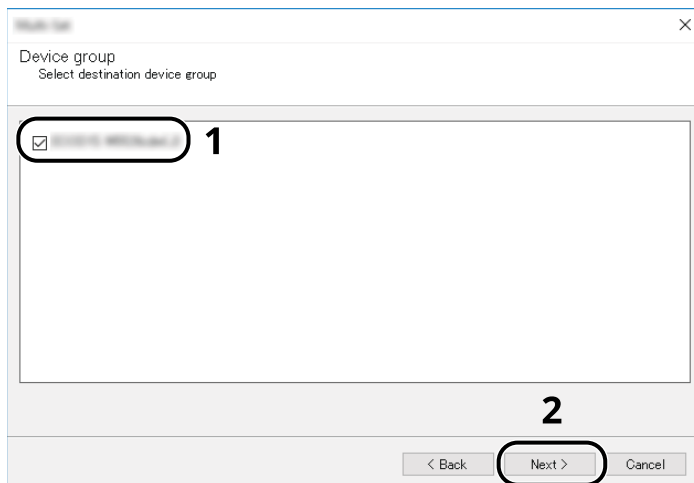

4 Select **[Device Address Book]** and click **[Next]**.

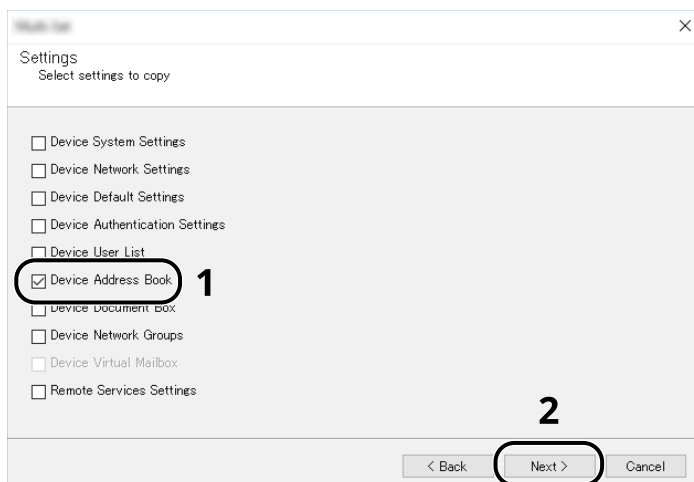

- 5 Select **[Create from file]** and remove the checkmark from **[Overwrite settings on target device]**, and then click **[Next]**.

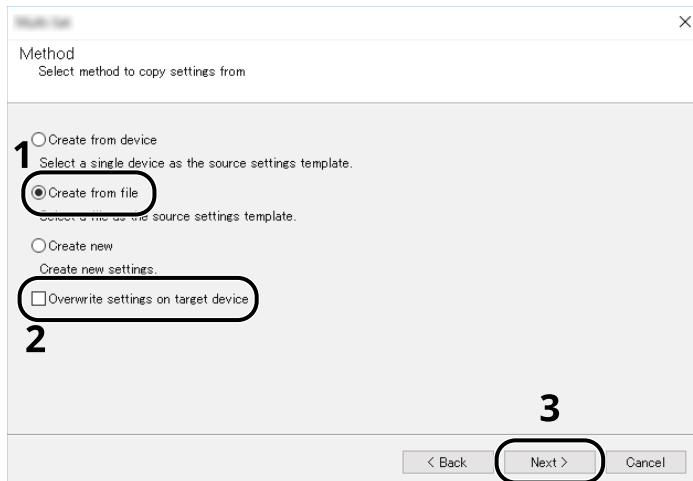

Selecting the **[Overwrite settings on target device]** checkbox will overwrite the machine's Address Book from entry No.1.

- 6 Click **[Browse]** and select the backup Address Book file, and then click **[Next]**.



- 7 Click **[Finish]**.

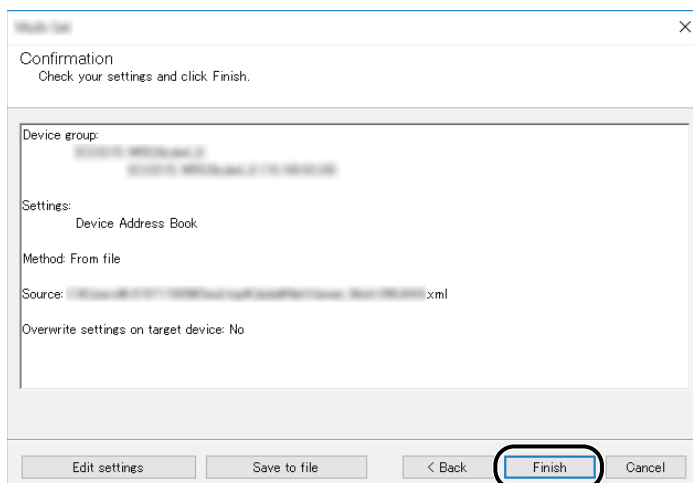

The write process of the Address Book data starts.

- 8 Once the write process is complete, click **[Close]**.

# 3 Preparation before Use

This chapter explains the following operations.

Loading Paper .....	3-2
Precaution for Loading Paper .....	3-3
Loading in the Cassettes .....	3-4
Loading Statement in the Cassettes (ECOSYS MA6000ifx/ECOSYS MA5500ifx for inch models) .....	3-8
Loading Paper in the Multi Purpose Tray .....	3-11
Specifying Paper Size and Media Type .....	3-15
Paper Stopper .....	3-16
Preparation for Sending a Document to a Shared Folder in a PC .....	3-17
Making a note of the computer name and full computer name .....	3-17
Making a note of the user name and domain name .....	3-18
Creating a Shared Folder, Making a Note of a Shared Folder .....	3-19
Configuring Windows Firewall .....	3-23
Scan to Folder Setup Tool for SMB .....	3-28
Registering Destinations in the Address Book .....	3-33
Adding a Destination (Address Book) .....	3-33
Adding a Destination on One Touch Key (One Touch Key) .....	3-41

# Loading Paper

Load paper in the cassettes and multipurpose tray.

For the paper load methods for each cassette, refer to the page below.

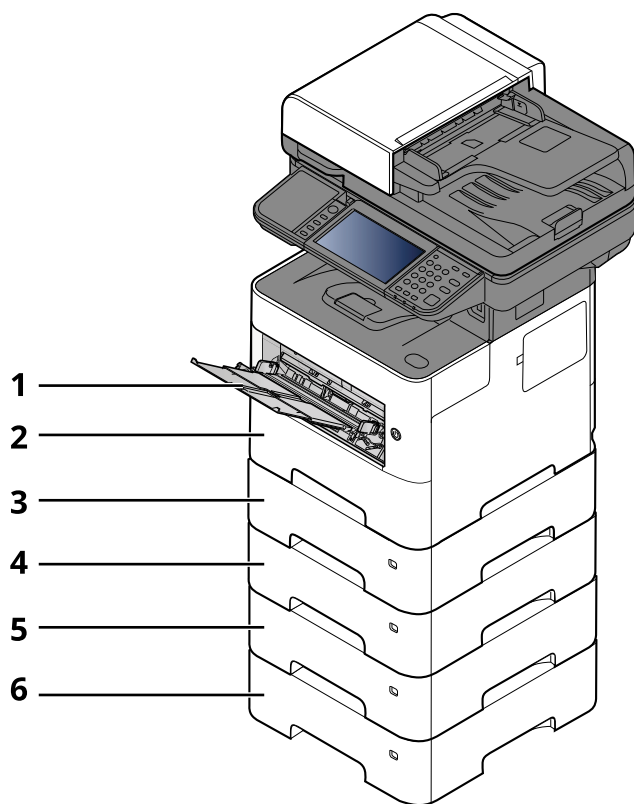

No.	Name	Page
1	Multi Purpose Tray	<a href="#">page 3-11</a>
2	Cassette 1	<a href="#">page 3-4</a>
3	Cassette 2	<a href="#">page 3-4</a>
4	Cassette 3	<a href="#">page 3-4</a>
5	Cassette 4	<a href="#">page 3-4</a>
6	Cassette 5	<a href="#">page 3-4</a>

## NOTE

- The number of sheets that can be held varies depending on your environment and paper type.
- You should not use inkjet printer paper or any paper with a special surface coating. (Such paper may cause paper jams or other faults.)

## Precaution for Loading Paper

When you open a new package of paper, fan the sheets to separate them slightly prior to loading in the following steps.

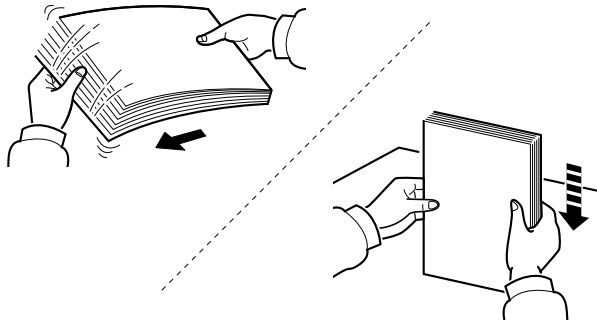

Fan the paper, then tap it on a level surface.

In addition, note the following points.

- If the paper is curled or folded, straighten it before loading. Paper that is curled or folded may cause a jam.
- Avoid exposing opened paper to high temperatures and high humidity as dampness can be a cause of problems. Seal any remaining paper after loading in the multi purpose tray or cassettes back in the paper storage bag.
- If the machine will not be used for a prolonged period, protect all paper from humidity by removing it from the cassettes and sealing it in the paper storage bag.

### ✔ IMPORTANT

**If you copy onto used paper (paper already used for printing), do not use paper that is stapled or clipped together. This may damage the machine or cause poor image quality.**

### 💡 NOTE

If you use special paper such as letterhead, paper with holes or paper with pre-prints like logo or company name, refer to the following:

➔ [Paper \(page 11-13\)](#)

## Loading in the Cassettes

The cassettes can hold plain paper, recycled paper or color paper.

The number of sheets that can be loaded in each cassette is shown below.

Cassette	No. Sheets
Cassette 1 to 5	500 sheets (Plain paper: 80 g/m <sup>2</sup> )

For details of the supported paper sizes, refer to the following:

➔ [Choosing the Appropriate Paper \(page 11-14\)](#)

### NOTE

A6 can only be used in Cassette 1 of the ECOSYS MA6000ifx/ECOSYS MA5500ifx.

For the paper type setting, refer to the following:

➔ [Media Type Setting \(page 8-17\)](#)

### IMPORTANT

- The cassettes can hold paper with weight between 60 - 120 g/m<sup>2</sup>.
- Do not load thick paper that is heavier than 120 g/m<sup>2</sup> in the cassettes. Use the multi purpose tray for paper that is heavier than 120 g/m<sup>2</sup>.

**1** Pull the cassette completely out of the machine.

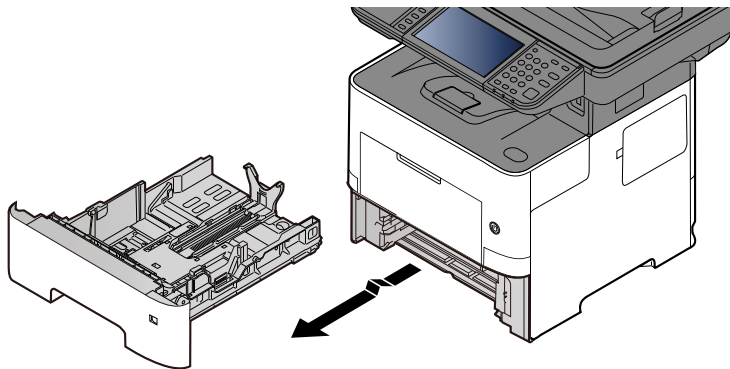

### NOTE

When pulling the cassette out of the machine, ensure it is supported and does not fall out.

## 2 Adjust the cassette size.

- 1 Adjust the position of the paper width guides located on the left and right sides of the cassette. Press the paper width adjusting tab and slide the guides to the paper size required.

Paper sizes are marked on the cassette.

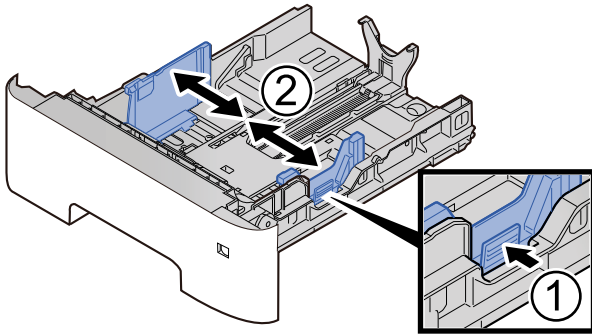

- 2 Adjust the paper length guide to the paper size required. Press the paper length adjusting tab and slide the guides to the paper size required.

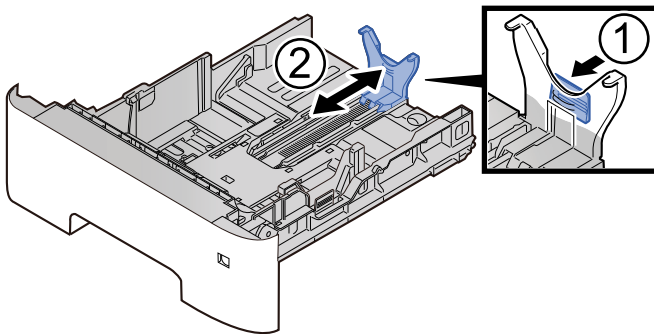

### NOTE

If you are going to use paper that is longer than A4, pull out the paper length guide backwards.

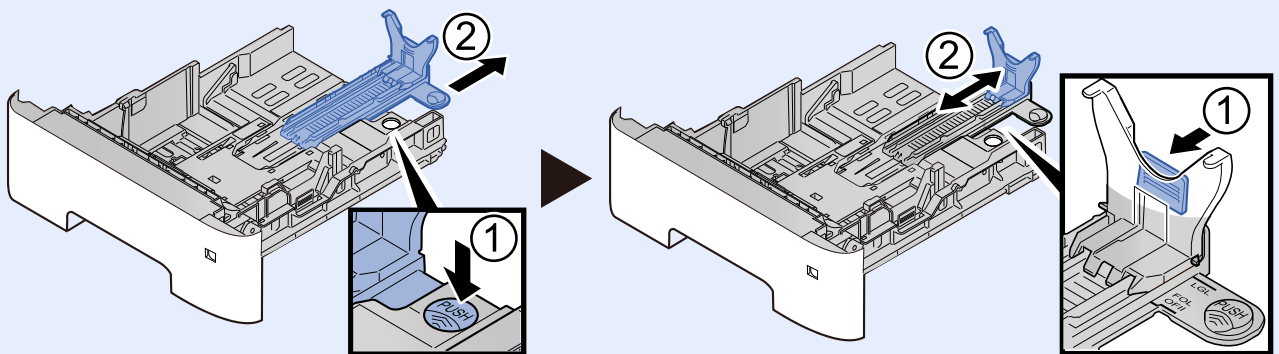



- 3 Turn the size dial so that the size of the paper you are going to use appears in the paper size window.

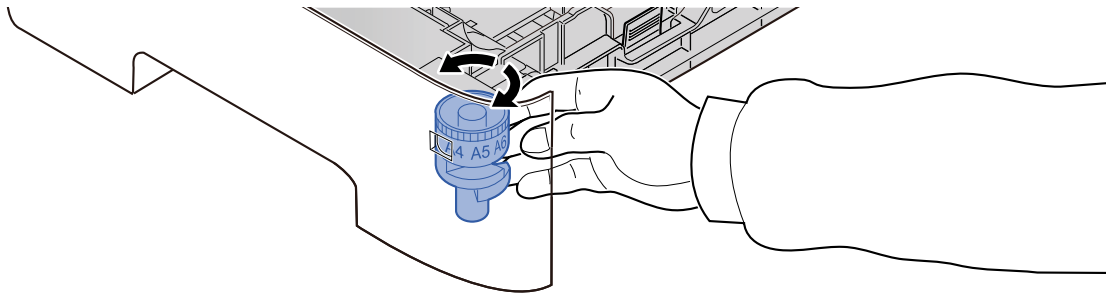

**NOTE**

When the size dial is set to "Other" the paper size must be set into the machine on the operation panel.

➔ [Paper Size and Media Type for the Cassettes \(page 3-15\)](#)

- 3 Press the bottom plate down until it locks. (ECOSYS MA4500ifx/ECOSYS MA4500ix only)

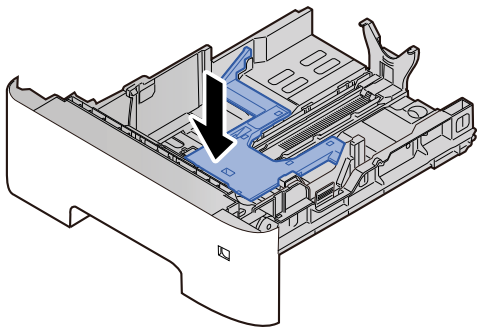

- 4 **Load paper.**

- 1 Fan the paper, then tap it on a level surface to avoid paper jams or skewed printing.
- 2 Load the paper in the cassette.

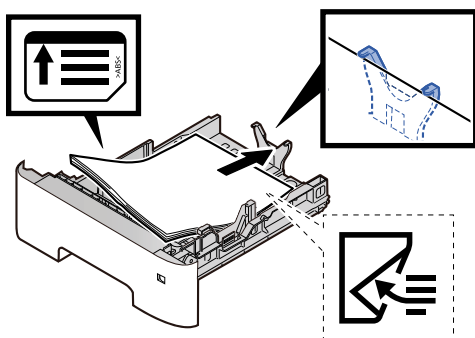

✔ **IMPORTANT**

- Load the paper with the print side facing down.
- After removing new paper from its packaging, fan the paper before loading it in the cassette.
- ➔ [Precaution for Loading Paper \(page 3-3\)](#)
- Before loading the paper, be sure that it is not curled or folded. Paper that is curled or folded may cause paper jams.
- Ensure that the loaded paper does not exceed the level indicator (see illustration above).
- If paper is loaded without adjusting the paper length guide and paper width guide, the paper may skew or become jammed.

**5** Gently push the cassette back in.

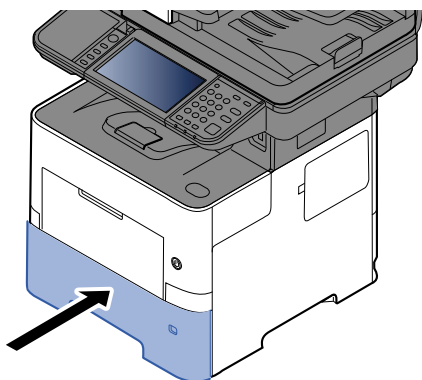

**6** Specify the type of paper loaded in the cassette using the operation panel.

- ➔ [Paper Size and Media Type for the Cassettes \(page 3-15\)](#)

## Loading Statement in the Cassettes (ECOSYS MA6000ifx/ECOSYS MA5500ifx for inch models)

Load Statement in the cassettes. Here, we'll explain the procedures for cassette 1, as an example.

### 1 Pull the cassette completely out of the machine.

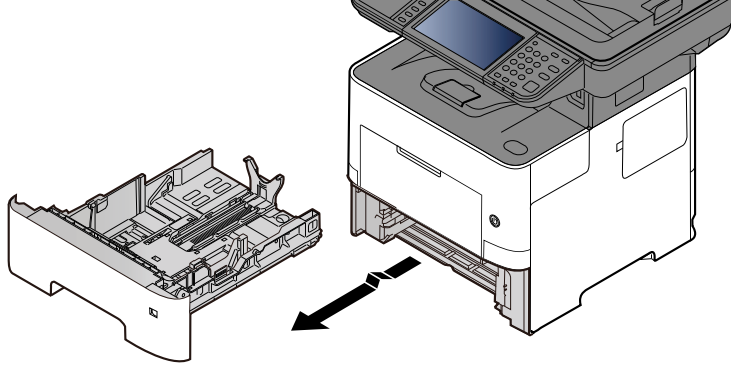

#### NOTE

When pulling the cassette out of the machine, ensure it is supported and does not fall out.

### 2 Adjust the cassette size.

- 1 Adjust the position of the paper width guides located on the left and right sides of the cassette. Press the paper width adjusting tab and slide the guides to the Letter/Legal size.

Paper sizes are marked on the cassette.

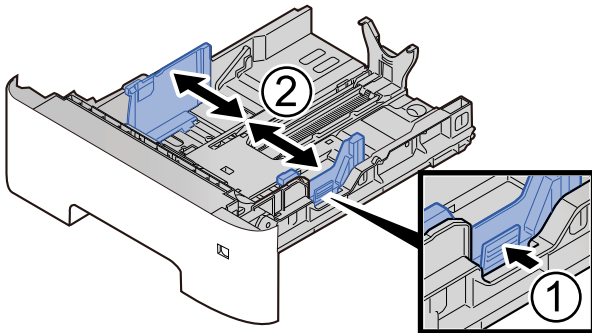

- 2 Adjust the paper length guide to the paper size required. Press the paper length adjusting tab and slide the guides to the A6 size.

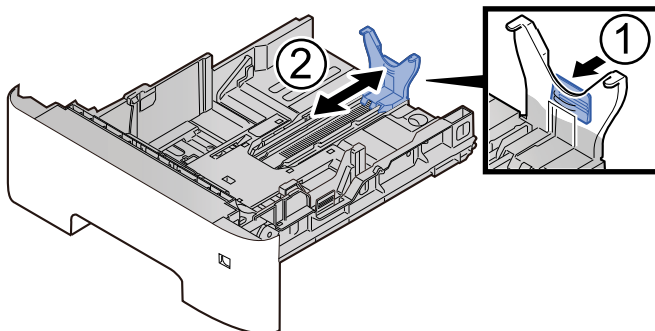

- 3 Attach the auxiliary guide to the paper length guide as shown in the illustration.

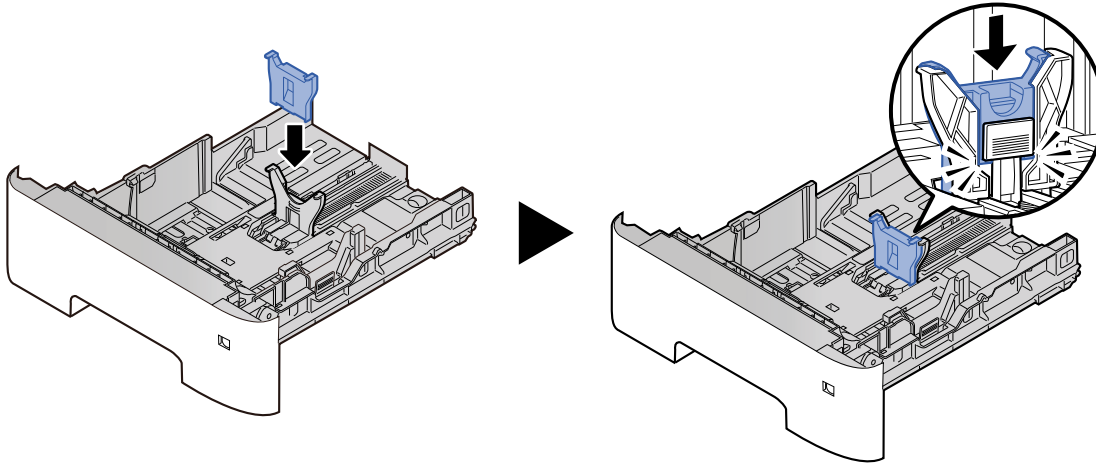

- 4 Turn the size dial so that "Other" appears in the paper size window.

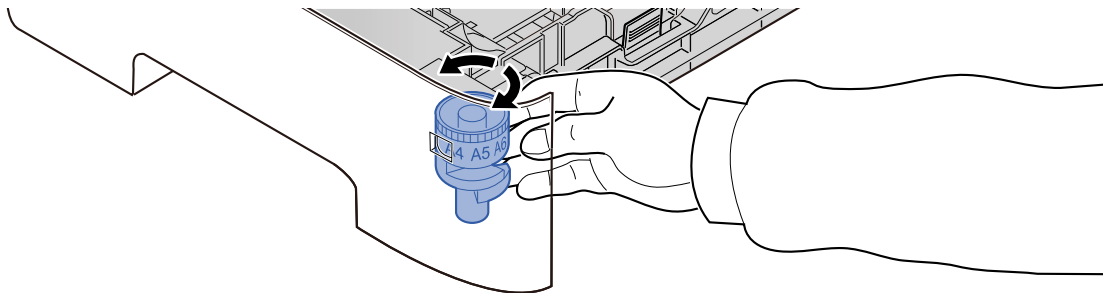

### 3 Load paper.

- 1 Fan the paper, then tap it on a level surface to avoid paper jams or skewed printing.
- 2 Load the paper in the cassette.

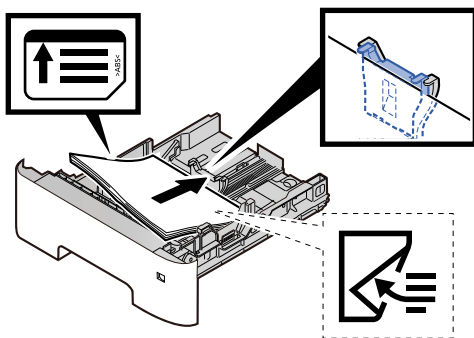

#### ✔ IMPORTANT

- Load the paper with the print side facing down.
- After removing new paper from its packaging, fan the paper before loading it in the cassette.  
➔ [Precaution for Loading Paper \(page 3-3\)](#)
- Before loading the paper, be sure that it is not curled or folded. Paper that is curled or folded may cause paper jams.
- Ensure that the loaded paper does not exceed the level indicator (see illustration above).
- If paper is loaded without adjusting the paper length guide and paper width guide, the paper may skew or become jammed.

**4 Gently push the cassette back in.**

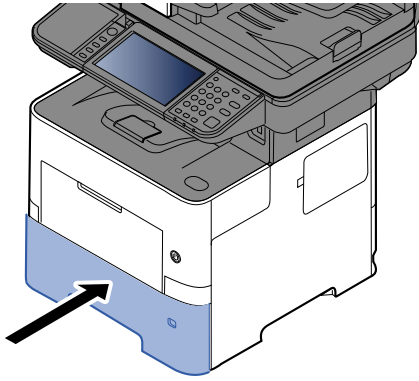

**5 Specify the type of paper loaded in the cassette using the operation panel.**

➔ [Paper Size and Media Type for the Cassettes \(page 3-15\)](#)

 **NOTE**

When removing the auxiliary guide, hold down the paper length adjusting tab and removing the auxiliary guide.

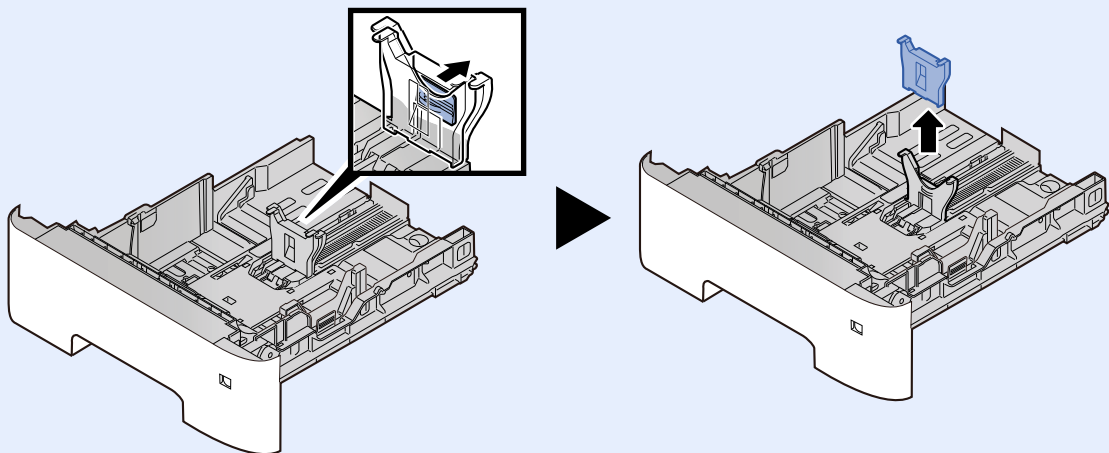

## Loading Paper in the Multi Purpose Tray

The multi purpose tray will hold up to 100 sheets of plain paper (80 g/m<sup>2</sup>).

For details of the supported paper sizes, refer to the following:

➔ [Choosing the Appropriate Paper \(page 11-14\)](#)

For the paper type setting, refer to the following:

➔ [Media Type Setting \(page 8-17\)](#)

Be sure to use the multi purpose tray when you print on any special paper.

### ✔ IMPORTANT

- **If you are using a paper weight of 106 g/m<sup>2</sup> or more, set the media type to Thick and set the weight of the paper you are using.**
- **Remove each transparency from the inner tray as it is printed. Leaving transparencies in the inner tray may cause a paper jam.**

The capacity of the multi purpose tray is as follows.

- Plain paper (80 g/m<sup>2</sup>), recycled paper or color paper: 100 sheets
- Thick paper (106 to 220 g/m<sup>2</sup>): 5 sheets
- Thick paper (104.7 g/m<sup>2</sup>): 100 sheets
- Hagaki (Cardstock): 1 sheets
- Envelope DL, Envelope C5, Envelope #10, Envelope #9, Envelope #6 3/4, Envelope Monarch, Youkei 4, Youkei 2: 5 sheets
- OHP film: 1 sheet

### 💡 NOTE

- When you load custom size paper, enter the paper size by referring to the following:  
➔ [Paper Size and Media Type for the Multi Purpose Tray \(MP Tray Setting\) \(page 3-16\)](#)
- When you use special paper such as transparencies or thick paper, select the media type by referring to the following:  
➔ [Paper Size and Media Type for the Multi Purpose Tray \(MP Tray Setting\) \(page 3-16\)](#)

## 1 Open the multi purpose tray.

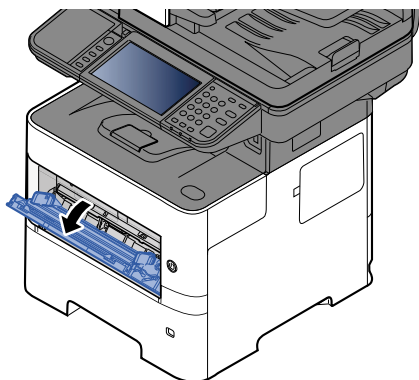

## 2 Pull out the support tray section of the MP tray.

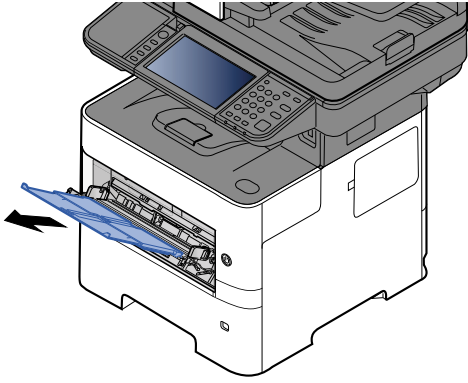

## 3 Adjust the multi purpose tray size.

Paper sizes are marked on the multi purpose tray.

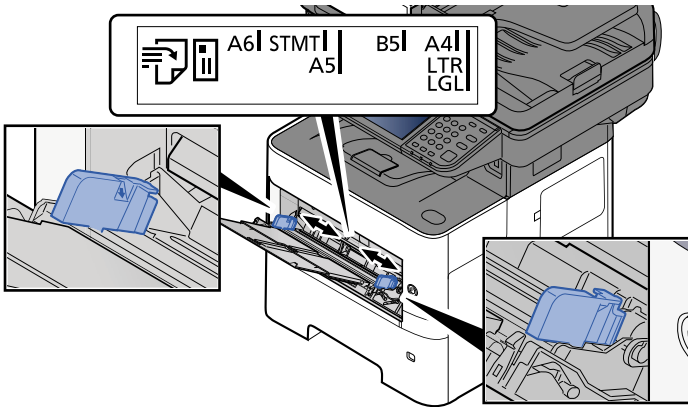

## 4 Load paper.

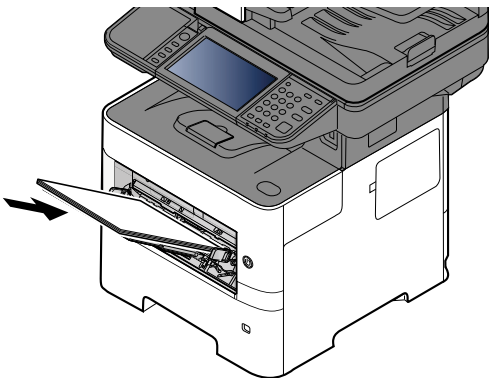

Insert the paper along the paper width guides into the tray until it stops.

After removing new paper from its packaging, fan the paper before loading it in the multi purpose tray.

➔ [Precaution for Loading Paper \(page 3-3\)](#)

✔ **IMPORTANT**

- **When loading the paper, keep the print side facing up.**
- **Curled paper must be uncurled before use.**
- **When loading paper into the multi purpose tray, check that there is no paper left over in the tray from a previous job before loading the paper. If there is just a small amount of paper left over in the multi purpose tray and you want to add more, first remove the left-over paper from the tray and include it with the new paper before loading the paper back into the tray.**
- **If there is a gap between the paper and the paper width guides, readjust the guides to fit the paper in order to prevent skewed feeding and paper jams.**
- **Ensure that the loaded paper does not exceed the level indicator (see illustration above).**

**5 Specify the type of paper loaded in the multi purpose tray using the operation panel.**

- ➔ [Paper Size and Media Type for the Multi Purpose Tray \(MP Tray Setting\) \(page 3-16\)](#)



## When you load envelopes or cardstock in the multi purpose tray

Load the paper with the print side facing up. For the procedure for printing, refer to the following:

### ➔ Printer Driver User Guide

Example: When printing the address.

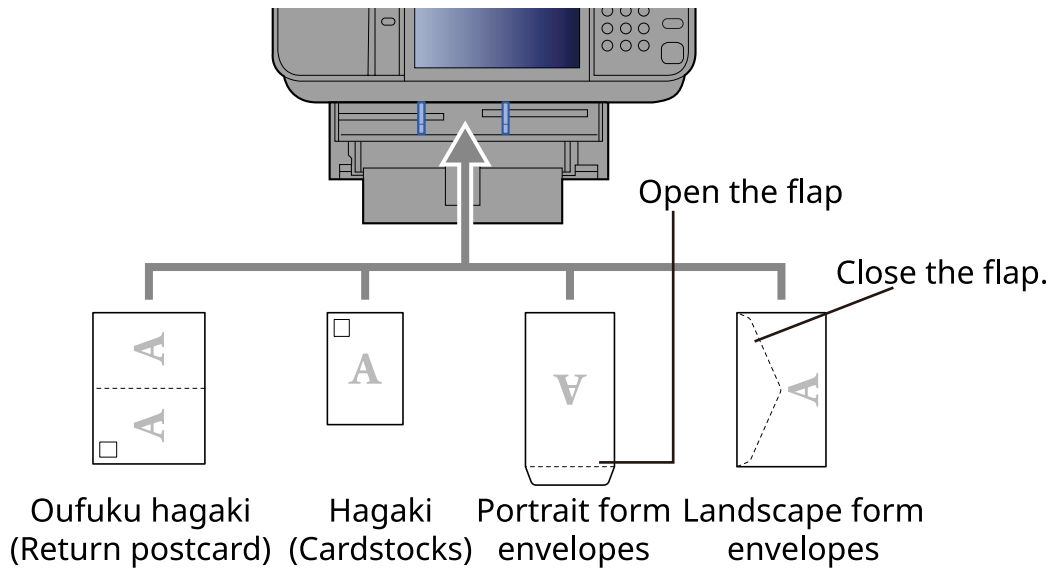

### ✔ IMPORTANT

- Use unfolded Oufuku hagaki (Return postcard).
- How to load envelopes (orientation and facing) will differ depending on the type of envelope. Be sure to load it in correctly, otherwise printing may be done in the wrong direction or on the wrong face.

### 💡 NOTE

When you load envelopes in the multi purpose tray, select the envelope type by referring to the following:

- ➔ [Paper Size and Media Type for the Multi Purpose Tray \(MP Tray Setting\) \(page 3-16\)](#)

## Specifying Paper Size and Media Type

The default paper size setting for cassette 1, for the multi purpose tray and for the optional paper feeder (cassettes 2 to 5) is "A4" or "Letter", and the default media type setting is "Plain".

To change the type of paper to be used in cassettes, specify the paper size and media type setting.

### 1 Display the screen.

[Home] key > [...] > [System Menu] > [Device Settings] > [Paper Feeding] > Select cassette

### 2 Select the paper size and paper type.

#### Paper Size and Media Type for the Cassettes

Specify the paper size and media type of paper to be used in cassettes.



#### NOTE

[Cassette 2] to [Cassette 5] are displayed when the following optional paper feeder is installed.

[Cassette 2] : Paper Feeder (550-sheet)

[Cassette 3] : Paper Feeder (550-sheet)

[Cassette 4] : Paper Feeder (550-sheet)

[Cassette 5] : Paper Feeder (550-sheet)

Item	Description
Paper Size <sup>*1</sup>	<p>Select from the Metric standard sizes.</p> <p><b>Values</b></p> <p><b>Cassette 1:</b> A4<sup>*2</sup>, A5-R<sup>*2</sup>, A5<sup>*3</sup>, A6<sup>*2*3</sup>, B5<sup>*2</sup>, B6<sup>*3</sup>, Folio, 216.0mm×340.0mm, Letter<sup>*2</sup>, Legal<sup>*2</sup>, Statement, Statement-R<sup>*2</sup>, Executive, Oficio II, 16K, ISO B5, Envelope DL<sup>*2</sup>, Envelope C5, Oufuku Hagaki<sup>*2</sup>, Custom<sup>*4</sup></p> <p><b>Cassettes 2 to 5:</b> A4<sup>*2</sup>, A5<sup>*2</sup>, B5<sup>*2</sup>, B6, Folio, 216.0mm×340.0mm, Letter<sup>*2</sup>, Legal<sup>*2</sup>, Statement, Executive, Oficio II, 16K, ISO B5, Envelope #10, Envelope #9, Envelope #6, Envelope Monarch, Envelope DL, Envelope C5, Oufuku Hagaki, Youkei 4, Youkei 2, Younaga3, Nagagata 3, Custom<sup>*4</sup></p>
Media type <sup>*5</sup>	<p>Select the media type.</p> <p><b>Values</b></p> <p><b>Cassette 1:</b> Plain, Rough, Recycled, Preprinted<sup>*6</sup>, Bond, Color, Prepunched<sup>*6</sup>, Letterhead<sup>*6</sup>, High Quality, Custom 1 - 8</p> <p><b>Cassettes 2 to 5:</b> Plain, Rough, Recycled, Preprinted<sup>*6</sup>, Bond, Color, Prepunched<sup>*6</sup>, Letterhead<sup>*6</sup>, Envelope, High Quality, Custom 1 - 8</p>

\*1 Only set this when the size dial on the cassette is set to "Other".

\*2 Paper size automatically detected in the cassette.

\*3 ECOSYS MA6000ifx/ECOSYS MA5500ifx only.

\*4 Custom paper sizes are set per cassette.

\*5 To change to a media type other than Plain, refer to the following:

➔ [Media Type Setting \(page 8-17\)](#)

When a paper weight that cannot be loaded in the cassette is set for a media type, that media type does not appear.

\*6 To print on preprinted or prepunched paper or on letterhead, refer to the following:

➔ [Special Paper Action \(page 8-18\)](#)

**NOTE**

- The available media types for printing received faxes are as shown below.  
Plain, Labels, Recycled, Bond, Vellum, Color, Envelope, Thick, High Quality, Rough and Custom 1 to 8
- Set the paper size of the cassette used for fax reception as follows:  
Inch models: Letter, Legal, Statement  
Metric models: A4, B5, A5, Folio  
If the above setting is changed, it will not be possible to print faxes.

**Paper Size and Media Type for the Multi Purpose Tray (MP Tray Setting)**

Specify the paper size and media type of paper to be used in the multi purpose tray.

Item		Description
Paper Size	Metric	Select from the Metric standard sizes. <b>Values: A4, A5, A6, B5, B6, Folio, 216 × 340 mm</b>
	Inch	Select from the Inch series standard sizes. <b>Values: Letter, Legal, Statement, Executive, Oficio II</b>
	Other	Select from special standard sizes and custom sizes. <b>Values: 16K, ISO B5, Envelope #10, Envelope #9, Envelope #6, Envelope Monarch, Envelope DL, Envelope C5, Hagaki (Cardstock), Oufukuhagaki (Return postcard), Youkei 4, Youkei 2, Younaga3, Nagagata 3, Nagagata 4, Custom<sup>*1</sup></b>
Media Type <sup>*2</sup>		Select the media type. <b>Values: Plain (60 to 105 g/m<sup>2</sup>), Rough, Transparency, Vellum, Labels, Recycled, Preprinted<sup>*3</sup>, Bond, Cardstock, Color, Prepunched<sup>*3</sup>, Letterhead<sup>*3</sup>, Envelope, Thick (106 to 220 g/m<sup>2</sup>), High Quality, Custom 1-8</b>

\*1 For instructions on how to specify the custom paper size, refer to the following:

➔ [Cassette 1 Size \(page 8-15\)](#)

\*2 To change to a media type other than "Plain", refer to the following:

➔ [Media Type Setting \(page 8-17\)](#)

\*3 To print on preprinted or prepunched paper or on letterhead, refer to the following:

➔ [Special Paper Action \(page 8-18\)](#)

**NOTE**

- The available media types for printing received faxes are as shown below.  
Plain, Label, Recycled, Bond, Vellum, Color, Envelope, Cardstock, Thick, High Quality, Rough and Custom 1 to 8
- Set the paper size of the multi purpose tray used for fax reception as follows:  
Inch models: Letter, Legal, Statement  
Metric models: A4, B5, A5, Folio  
If the above setting is changed, it will not be possible to print faxes.

## Paper Stopper

When using paper A4/Letter or larger, open the paper stopper shown in the figure.

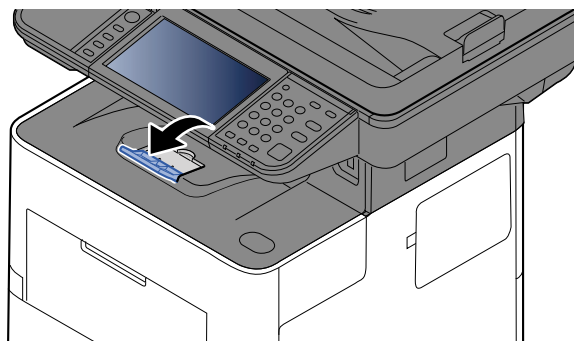

# Preparation for Sending a Document to a Shared Folder in a PC

Check the information that needs to be set on the machine and create a folder to receive the document on your computer. Screens of Windows 10 are used in the following explanation. The details of the screens will vary in other versions of Windows.



## NOTE

Log on to Windows with administrator privileges.

## Making a note of the computer name and full computer name

Check the name of the computer name and full computer name.

### 1 Display the screen.

Click **[Start]** button on the Windows and then select **[Windows System]**, **[Control Panel]**, **[System and Security]**, and **[System]**.



## NOTE

In Windows 8.1, right-click **[PC]** in the Start screen and select **[Properties]**. Or, right-click the Window icon and select **[System]**.

### 2 Check the computer name.

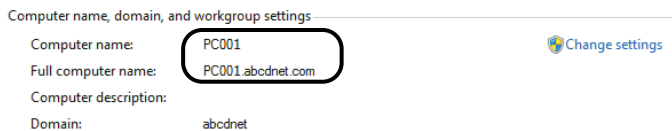

Check the computer name and full computer name.

Screen example:

Computer name: PC001  
Full computer name: PC001.abcdnet.com

After checking the computer name, click the  **[Close]** button to close the "System Properties" screen.

## Making a note of the user name and domain name

Check the domain name and user name for logging onto Windows.

### 1 Display the screen.

Click [**Start**] button on the Windows and then select [**Windows System**] and [**Command Prompt**].

In Windows 8.1, click [**Search**] in charms, and enter "Command Prompt" in the search box. Select [**Command Prompt**] in the search list.

The Command Prompt window appears.

### 2 Check the domain name and user name.

At the Command Prompt, enter "net config workstation" and then press [**Enter**].

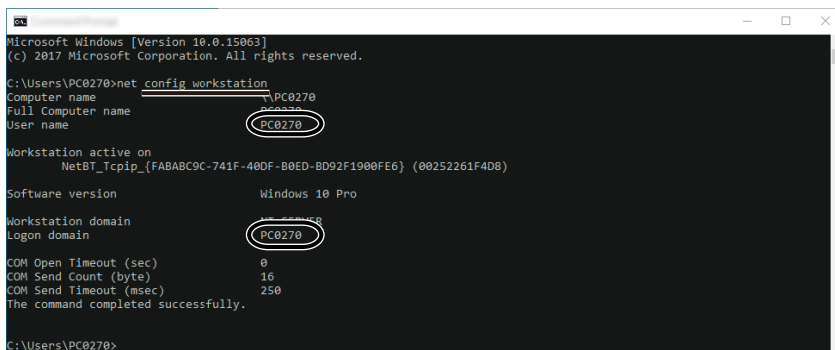

```
Microsoft Windows [Version 10.0.15063]
(c) 2017 Microsoft Corporation. All rights reserved.

C:\Users\PC0270>net config workstation
Computer name                \PC0270
Full Computer name           PC0270
User name                    PC0270

Workstation active on
NetBT_Tcpip_{FABABC9C-741F-40DF-B0E0-BD92F1900FE6} (00252261F4D8)

Software version             Windows 10 Pro

Workstation domain           PC0270
Logon domain                 PC0270

COM Open Timeout (sec)      0
COM Send Count (byte)      16
COM Send Timeout (msec)    250
The command completed successfully.

C:\Users\PC0270>
```

Check the user name and domain name.

Screen example:

User Name: james.smith  
Domain Name:ABCDNET

## Creating a Shared Folder, Making a Note of a Shared Folder

Create a shared folder to receive the document in the destination computer.

### NOTE

If there is a workgroup in System Properties, configure the settings below to limit folder access to a specific user or group.

- 1 Open up a window in File Explorer and select [**View**], [**Options**], and then [**Folder Options**].  
In Windows 8.1, select [**Settings**] in charms on Desktop, and select [**Control Panel**], [**Appearance and Personalization**], and then [**Folder Options**].

2

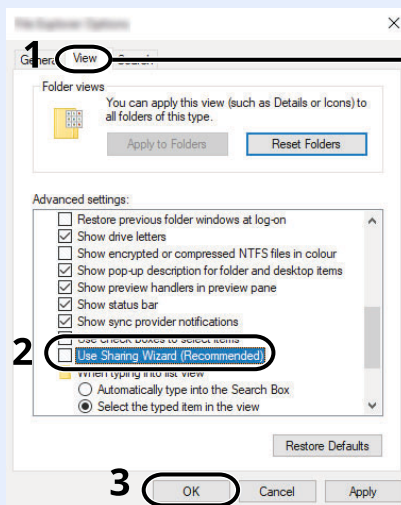

Make sure that the [**View**] tab is selected.

Remove the checkmark from [**Use Sharing Wizard (Recommended)**] in "Advanced settings".

### 1 Create a folder.

- 1 Create a folder on your computer.

For example, create a folder with the name "**scannerdata**" on the desktop.

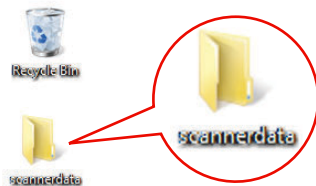

## 2 Configure permission settings.

- 1 Right-click the "scannerdata" folder, select [Property], and click [Sharing] and [Advanced Sharing].

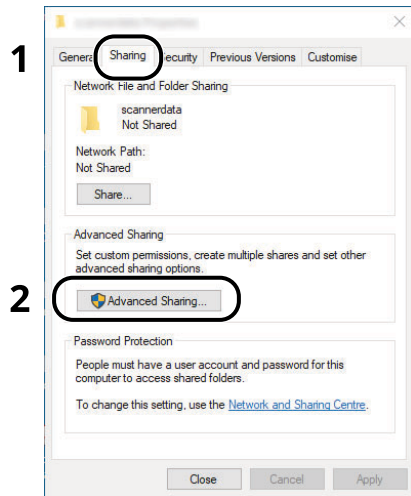

- 2 Select the [Share this folder] checkbox and click the [Permissions] button.

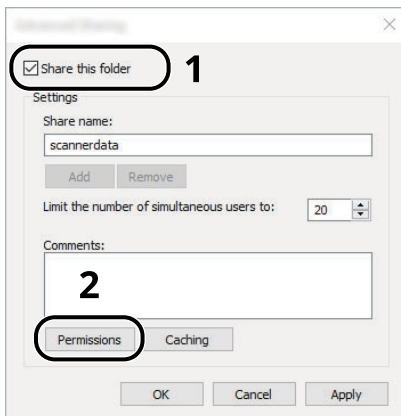

- 3 Make a note of the [Share name].

- 4 Click the [Add] button.

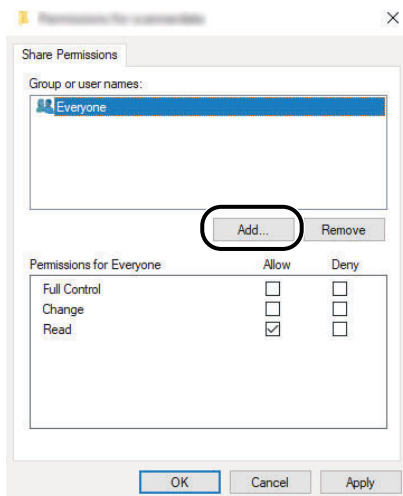

## 5 Specify the location.

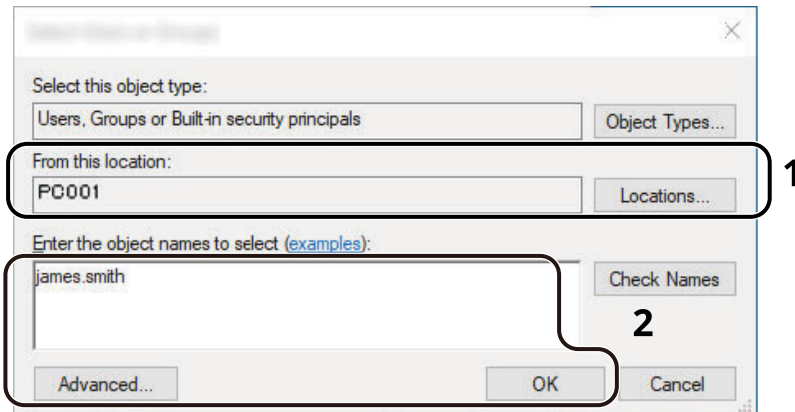

- 1 If the computer name that you made a note is the same as the domain name:  
If the computer name is not shown in "From this location", click the **[Locations]** button, select the computer name, and click the **[OK]** button.

Example: PC001

If the computer name that you made a note is not the same as the domain name:

If the text after the first dot (.) in the full computer name that you made a note of does not appear in "From this location", click the **[Locations]** button, select the text after the dot (.), and click the **[OK]** button.

Example: abcdnet.com

➔ [Making a note of the user name and domain name \(page 3-18\)](#)

- 2 Enter the user name that you made a note of on page in the text box, and click the **[OK]** button. Also the user name can be made by clicking the **[Advanced]** button and selecting a user.

## 5 Set the access permission for the user selected.

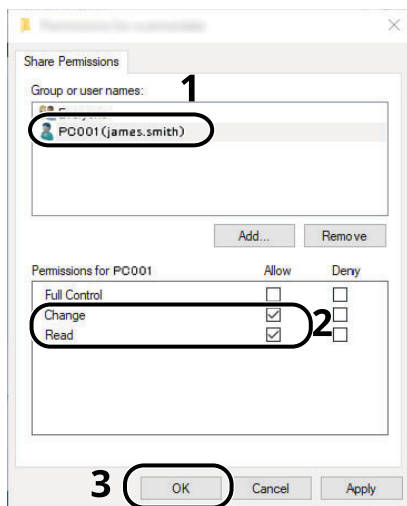

- 1 Select the user you entered.
- 2 Select the **[Allow]** checkbox of the "Change" and "Read" permissions
- 3 Press **[OK]**.

 **NOTE**

"**Everyone**" gives sharing permission to everyone on the network. To strengthen security, it is recommended that you select "**Everyone**" and remove the "**Read**" **[Allow]** checkmark.

6 Click the **[OK]** button in the "**Advanced Sharing**" screen to close the screen.



7 Check the details set in the [Security] tab.

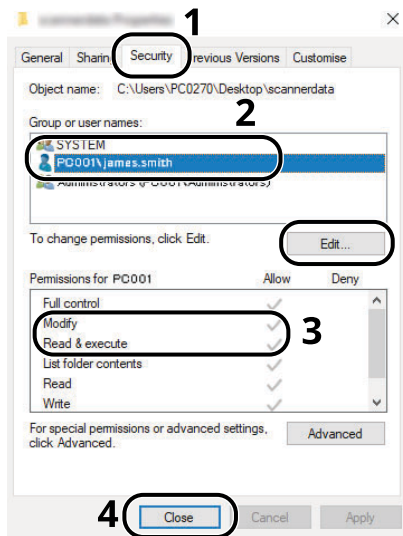

- 1 Select the [Security] tab.
- 2 Select the user you entered.  
If the user does not appear on "Group or user names", click [Edit] button to add user in a similar way of "configuration of permission settings".
- 3 Make sure that checkmarks appear on [Allow] checkbox for the "Modify" and "Read & execute" permissions.
- 4 Click the [Close] button.

# Configuring Windows Firewall

Permit sharing of files and printers and set the port used for SMB transmission.

## NOTE

Log on to Windows with administrator privileges.

## 1 Check file and printer sharing.

- 1 Click **[Start]** button on the Windows and then select **[Windows System]**, **[Control Panel]**, **[System and Security]**, and **[Allow an app through Windows Firewall]**.

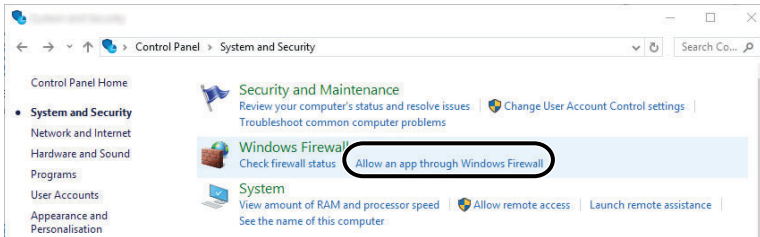

## NOTE

- In Windows 8.1, in charms on Desktop, click **[Settings]**, **[Control Panel]**, **[System and Security]**, and then **[Windows Firewall]**.
- If the User Account Control dialog box appears, click the **[Continue]** button.

- 2 Select the **[File and Printer Sharing]** checkbox.

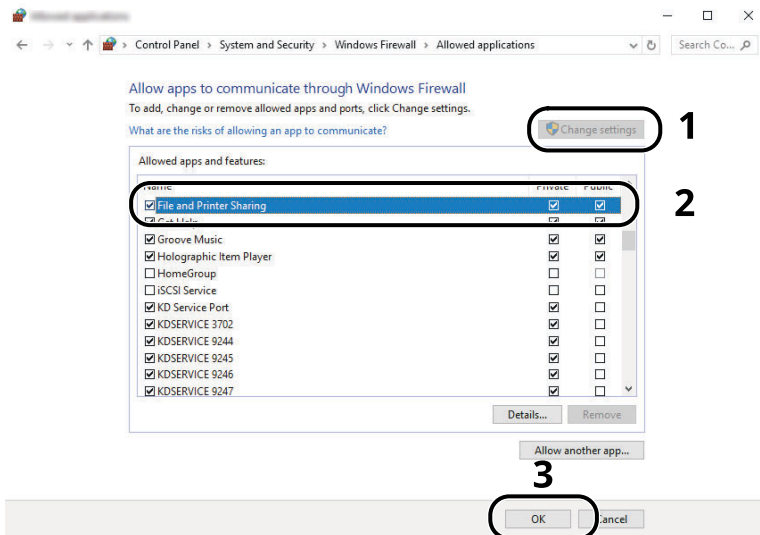

## 2 Add a port.

- 1 Click **[Start]** button on the Windows and then select **[Windows System]**, **[Control Panel]**, **[System and Security]**, and **[Check firewall status]**.

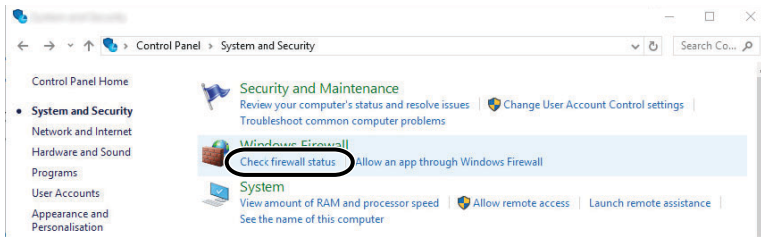

- 2 Select **[Advanced settings]**.

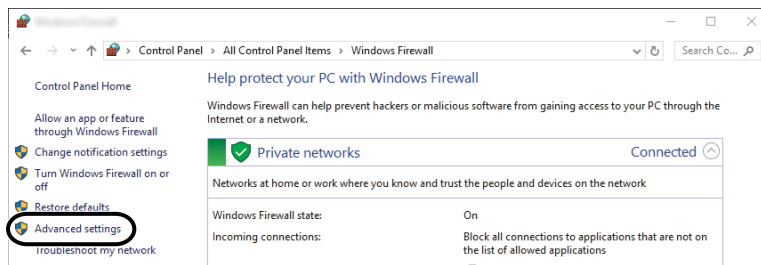

- 3 Select **[Inbound Rules]**.



- 4 Select **[New Rules]**.

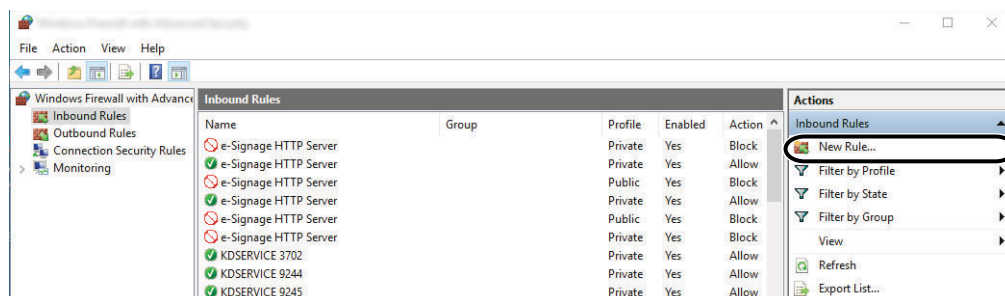

5 Select **[Port]**.

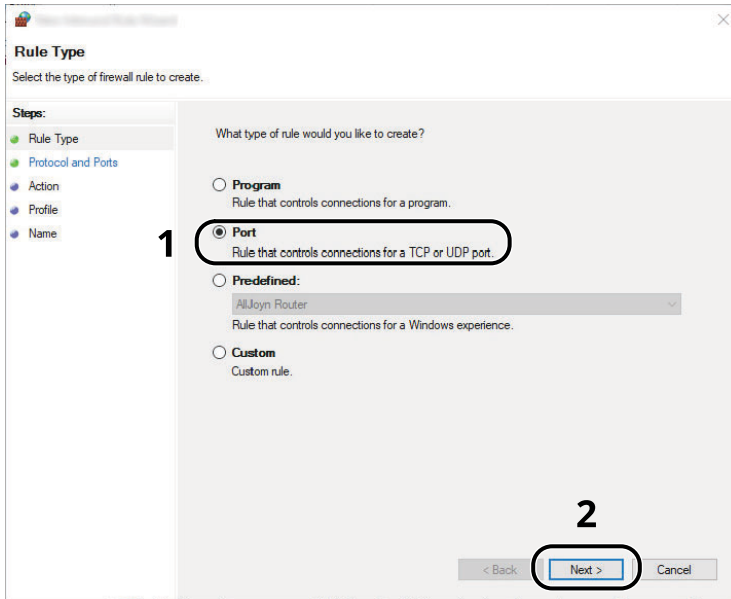

6 Select **[TCP]** as the port to apply the rule to. Then select **[Specific local ports]** and enter "445" then click **[Next]**.

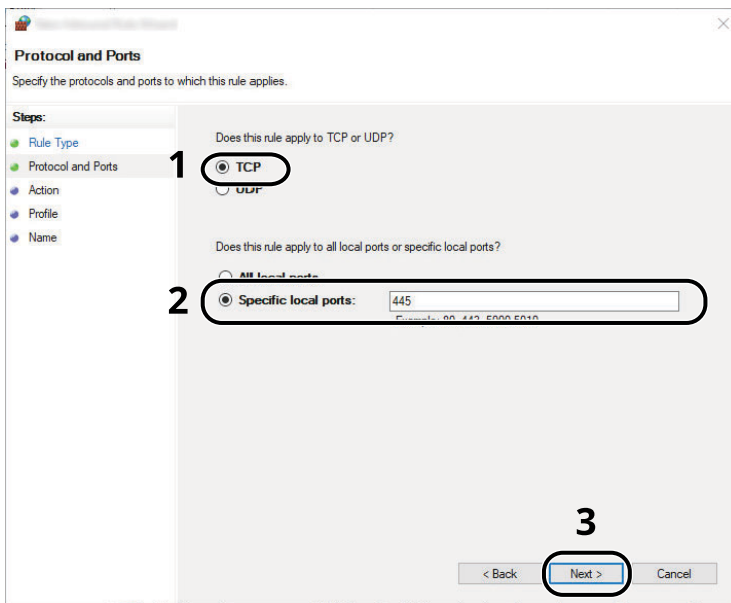

7 Select **[Allow the connection]** and click the **[Next]** button.

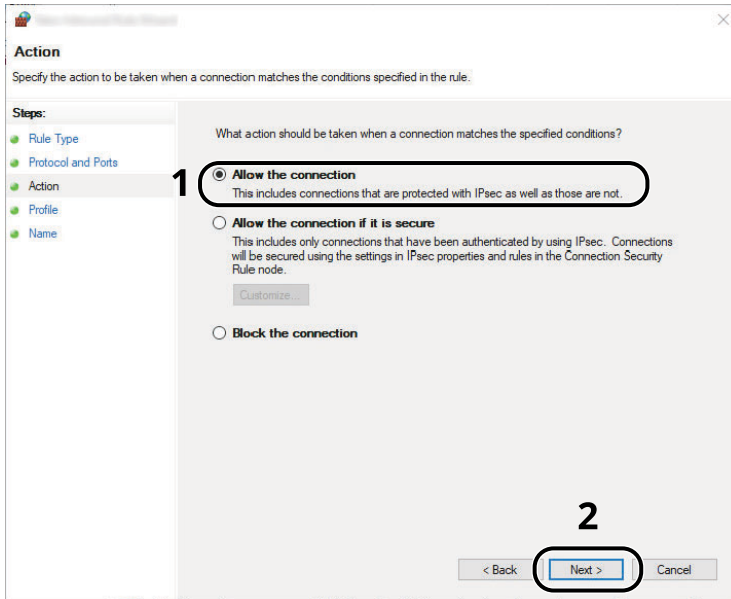

8 Make sure all checkboxes are selected and click the **[Next]** button.

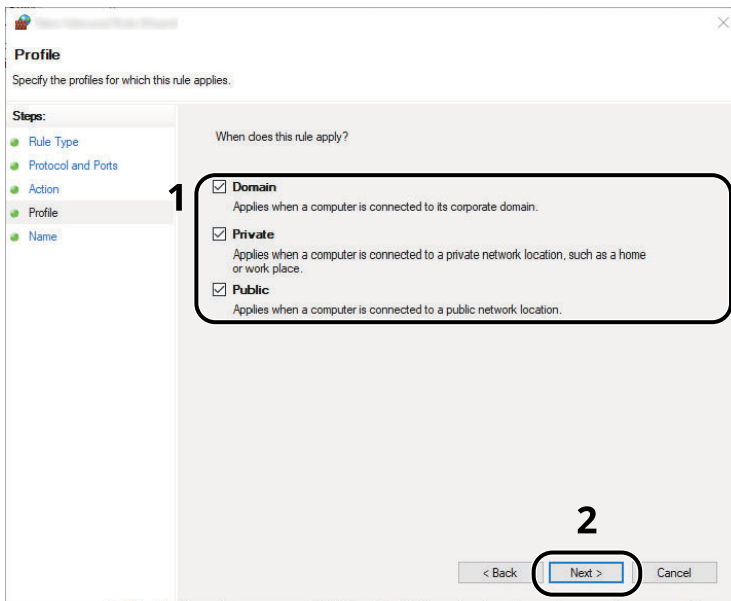

- 9 Enter "**Scan to SMB**" in "**Name**" and click [**Finish**].

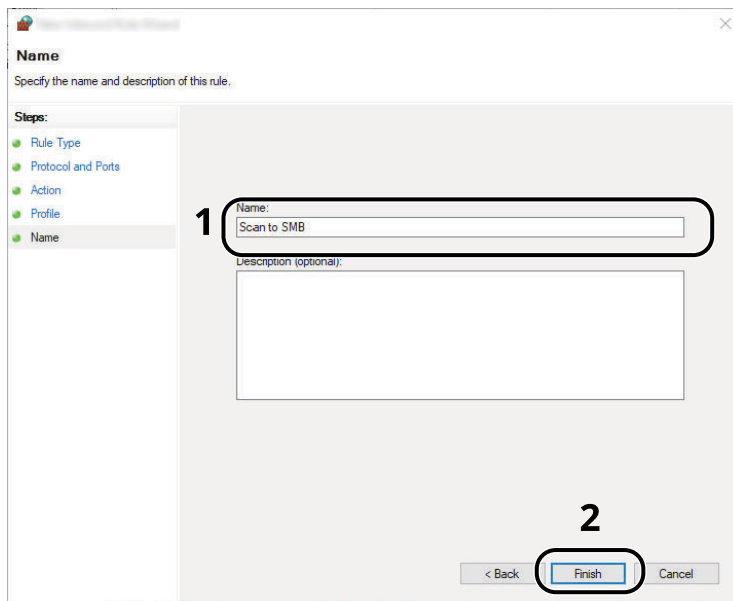

## In Windows 8.1

- 1 In Windows 8.1, select [**Settings**] in charms on Desktop, and select [**Control Panel**], [**System and Security**], and then [**Windows Firewall**].  
If the User Account Control dialog box appears, click the [**Continue**] button.
- 2 Configure the settings.
  - ➔ [Configuring Windows Firewall \(page 3-23\)](#)

## Scan to Folder Setup Tool for SMB

An environment for sending a document to Windows can be set up smoothly by using the Scan to Folder Setup Tool for SMB downloaded from our website.

By operating the Scan to Folder Setup Tool for SMB, you can configure the following settings.

- Create a shared folder in a PC for receiving documents  
A new folder can be easily created on the desktop. Also, the newly created folder is automatically set as a shared folder.
- Set the created shared folder as an address on this machine  
Information about such things as the name of the computer and shared names for the shared folder is easily recorded in the address book of this machine with a sequence of actions. Can also be registered on the One Touch Keys.



### NOTE

- Log in to Windows with administrator privileges.
- If user login administration is enabled, log in with administrator privileges or as a user with execution authority.

## 1 Download a software from the website.

- 1 Launch a web browser.
- 2 Enter "https://kyocera.info/" to the browser's address bar or location bar.

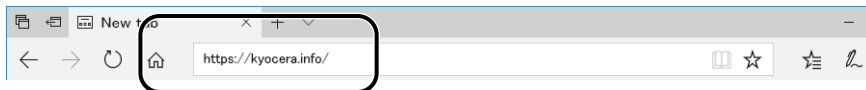

- 3 Enter and search the product name, and select this product from the candidate list.

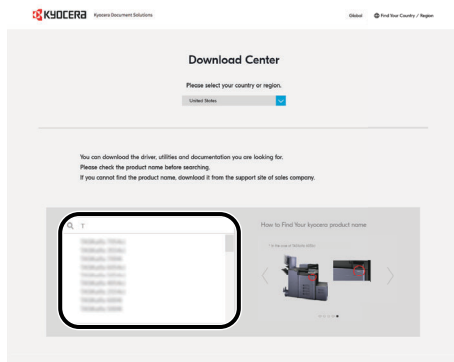

4 Change the selected operating system and its language setting as needed.

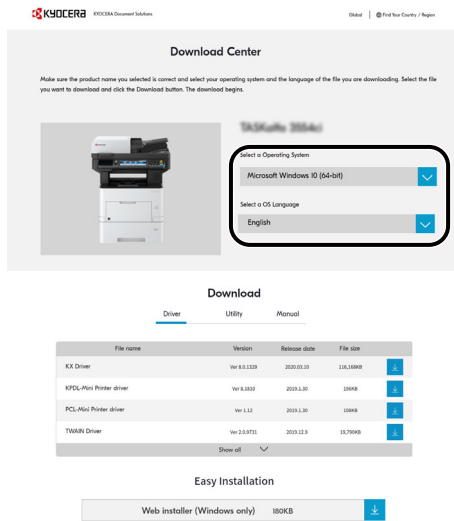

5 Utility tab > "Scan to Folder Setup Tool for SMB"   
Scan to Folder Setup Tool for SMB will be downloaded.

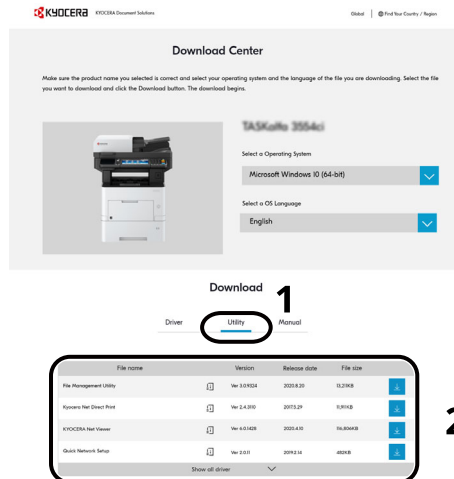

6 Double click to launch the downloaded installer.



## 2 Configure the settings.

- 1 Select the device to use and click **[Next]**.

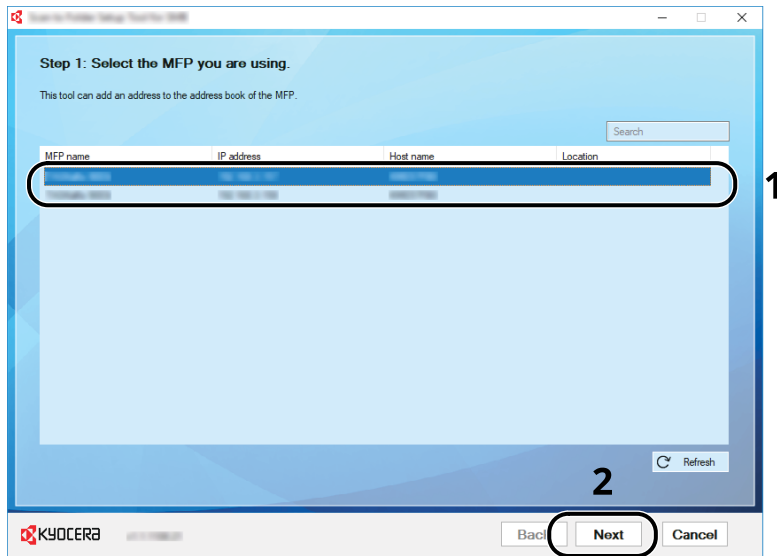

### NOTE

- The machine cannot be detected unless it is on. If the computer fails to detect the machine, verify that it is connected to the computer via a network cable and that it is turned on and click **[Refresh]**.
- If user administration is valid on this machine, the user authentication screen appears. Log in with administrator privileges or as a user with execution authority.

The address book of the device appears.

- 2 Select **[Add]**.

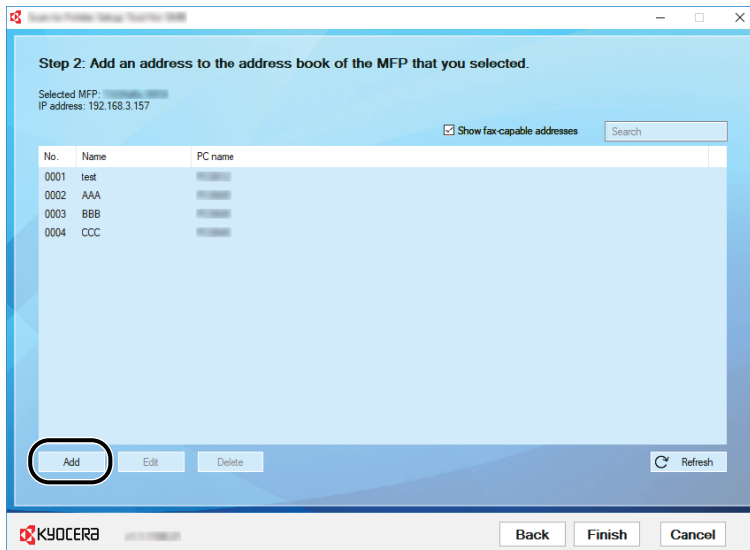

### NOTE

- Clicking on **[Edit]** after selecting the registered address allows you to change the content of the registration.
- Unchecking the **[Show fax-capable addresses]** check-box will hide the address containing the fax.

3 Create a new folder.

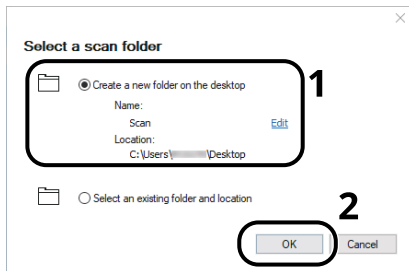

Select "Create a new folder on the desktop" and click **[OK]** to create a new folder on the desktop. (The default folder name is "Scan".)

 **NOTE**

- Click **[Edit]** to change the desktop folder name.
- Selecting **[Select an existing folder and address]** allows you to select an existing folder that is already set as a shared folder on the PC.

4 Enter the information requested to register the address.

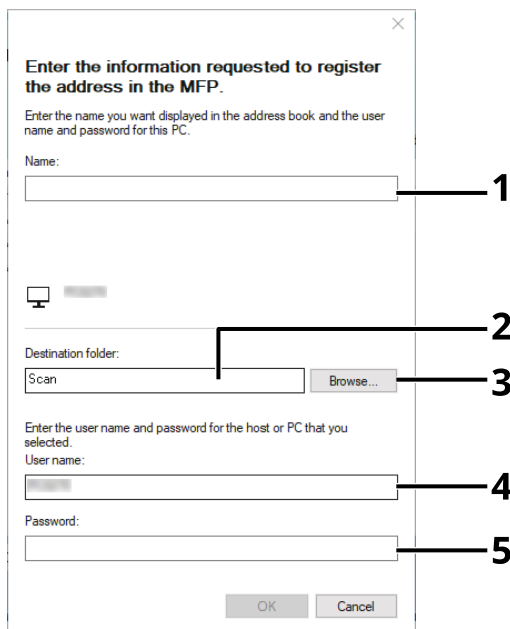

- 1 Enter the name for display in the address book.
- 2 Display the folder name and path to the shared folder.
- 3 Shared folders can be selected from a PC on the network.
- 4 Display the user name of the selected PC.
- 5 Enter the password corresponds to the log in user name of the selected PC.

5 Click **[OK]** to register the address to the address book.

6 Click **[Close]**.

- 7 To register the registered address in a One Touch key, click [**Yes**].

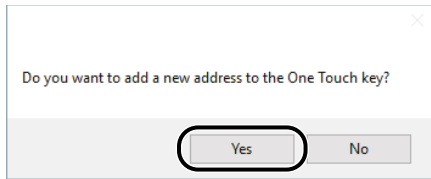

- 8 Select a One Touch Key with no registered destination, and click [**Submit**].

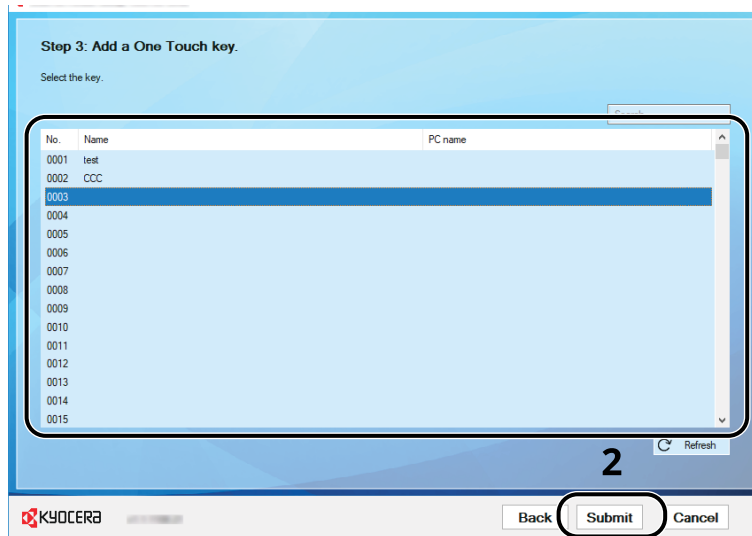

- 9 Click [**Close**].
- 10 Click [**Finish**] to exit the Scan to Folder Setup Tool.

# Registering Destinations in the Address Book

Save frequently used destinations to the Address Book or One Touch Keys. The saved destinations can be changed. The destinations are available for Send as E-mail, Send to Folder, and Fax Transmission (Only on products with the fax function installed).

## NOTE

- Registering and editing of the Address Book can also be done in Command Center RX.
- ➔ [Registering Destinations \(page 2-78\)](#)
- Editing of the Address Book and One Touch Keys can be restricted to administrators.
- ➔ [Edit Restriction \(page 8-32\)](#)

## Adding a Destination (Address Book)

Add a new destination to the Address Book. There are two registering methods, contacts and groups. When adding a group, enter the group name and select group members from the Address Book.

## NOTE

If registering and editing of the Address Book is restricted to administrators, you can edit the Address Book by logging in with administrator privileges.

- ➔ [Edit Restriction \(page 8-32\)](#)
- ➔ **Command Center RX User Guide**

## Registering an Address (E-mail Address)

The registering method of an E-mail address to Address Book is as follows.

### 1 Display the screen.

[Home] key > [...] > [System Menu] > [Function Settings] > [Address Book] > [Add/Edit Machine Address Book] > [Add] > [Contact]

### 2 Add the name.

- 1 Enter the destination name to be displayed on the Address Book.

## NOTE

For details on entering characters, refer to the following:

- ➔ [Character Entry Method \(page 11-10\)](#)

- 2 Enter an address number.

To have the number assigned automatically, select [Auto] (0000) .

## NOTE

- Address Number is an ID for a destination. You can select any available number out of 200 numbers for contacts and 50 numbers for groups.
- If you specify an address number that is already in use, an error message appears when you select [Save] and the number cannot be registered. If you set [Auto] (0000) as the address number, the address is registered under the lowest available number.

### 3 Add the address.

- 1 Select **[E-mail]**.
- 2 Select the entry field, and enter the E-mail address.



#### NOTE

For details on entering characters, refer to the following:

➔ [Character Entry Method \(page 11-10\)](#)

### 4 Check if the destination entry is correct > **[Register]**

The destination is added to the Address Book.

To add a new address to the One Touch Key, select **[Register]** and follow the on-screen instructions to enter the necessary information.



#### NOTE

Refer to the following for registering the One Touch Key.

➔ [Adding a Destination on One Touch Key \(One Touch Key\) \(page 3-41\)](#)

## Registering an Address (Folder (SMB) Address)

The registering method of an E-mail address to Address Book is as follows.

### 1 Display the screen.

**[Home]** key > **[...]** > **[System Menu]** > **[Function Settings]** > **[Address Book]** > **[Add/Edit Machine Address Book]** > **[Add]** > **[Contact]**

### 2 Add the name.

- 1 Enter the destination name to be displayed on the Address Book.



#### NOTE

For details on entering characters, refer to the following:

➔ [Character Entry Method \(page 11-10\)](#)

- 2 Enter an address number.

To have the number assigned automatically, select **[Auto]** (0000).



#### NOTE

- Address Number is an ID for a destination. You can select any available number out of 200 numbers for contacts and 50 numbers for groups.
- If you specify an address number that is already in use, an error message appears when you select **[Save]** and the number cannot be registered. If you set **[Auto]** (0000) as the address number, the address is registered under the lowest available number.

### 3 Add the address.

- 1 Select **[Folder]**.

- 2 To directly specify the SMB folder, enter the "Host name", "Port", "Folder Path", "Login User Name", and "Login Password".

**NOTE**

For the computer name, share name, domain name, and user name, enter the information that you noted when you created the shared folder. For details on creating shared folders, refer to the following:

➔ [Preparation for Sending a Document to a Shared Folder in a PC \(page 3-17\)](#)

You can search for a folder on a PC on the network. Select [Search Folder from Network] or [Search Folder by Host Name]. Select the folder from the Search Results list.

**NOTE**

- If you selected [Search Folder from Network], you can search all PCs on the network for a destination.
- If you selected [Search Folder by Host Name], you can enter the "Domain/Workgroup", and "Host Name" to search PCs on the network for the destination.
- A maximum of 500 addresses can be displayed. Select the host name (PC name) that you want to specify in the screen that appears, and select [OK]. The login user name and login password entry screen appears.
- After you enter the login user name and login password name of the destination PC, the shared folders appear. Select the folder that you want to specify and select [OK]. The address of the selected shared folder is set.

The table below explains the items to be entered.

Item	Description
<b>Host Name</b> *1	Computer name
<b>Port</b>	Port number If the port number is not specified, the default port number is 445.
<b>Folder Path</b>	Share name. For example: scannerdata If saving in a folder in the shared folder: share name \ folder name in shared folder
<b>Login User Name</b> *2	<ul style="list-style-type: none"> <li>• If the computer name and domain name are the same User Name For example: james.smith.</li> <li>• If the computer name and domain name are different Domain name \ User name For example: abcdnet \ james.smith</li> </ul>
<b>Login Password</b>	Windows logon password (Case sensitive.)

\*1 Specify "Host name" or "IP address". To enter the IPv6 address, enclose the address in brackets [ ].  
(Example: [2001:db8:a0b:12f0::10])

\*2 For "Login User Name", you can use double-byte characters such as Chinese characters, hiragana, or katakana. However, the number of characters that can be entered may become less than 64.  
When transmitting using the optional network interface (IB-50 or IB-51), only alphanumeric characters are allowed. Also, if the computer name and domain name are different because ¥ is not available, use @ to enter the user name in the following format.  
User name@Domain name  
(Example: james.smith@abcdnet)

 **NOTE**

- For details on entering characters, refer to the following:
  - ➔ [Character Entry Method \(page 11-10\)](#)
- Select [Connection Test] to check the connection to the server you chose. If the connection fails, check the entries you made.

## 4 Check if the destination entry is correct > [Register]

The destination is added to the Address Book.

To add a new address to the One Touch Key, select [Register] and follow the on-screen instructions to enter the necessary information.

 **NOTE**

- Refer to the following for registering the One Touch Key.
  - ➔ [Adding a Destination on One Touch Key \(One Touch Key\) \(page 3-41\)](#)

## Registering an Address (Folder (FTP) Address)

The registering method of an folder (FTP) address to Address Book is as follows.

### 1 Display the screen.

[Home] key > [...] > [System Menu] > [Function Settings] > [Address Book] > [Add/Edit Machine Address Book] > [Add] > [Contact]

### 2 Add the name.

- 1 Enter the destination name to be displayed on the Address Book.

 **NOTE**

For details on entering characters, refer to the following:

- ➔ [Character Entry Method \(page 11-10\)](#)

- 2 Enter an address number.

To have the number assigned automatically, select [Auto] (0000) .

 **NOTE**

- Address Number is an ID for a destination. You can select any available number out of 200 numbers for contacts and 50 numbers for groups.
- If you specify an address number that is already in use, an error message appears when you select [Save] and the number cannot be registered. If you set [Auto] (0000) as the address number, the address is registered under the lowest available number.

### 3 Add the address.

- 1 Select [Folder].
- 2 Enter the "Host name", "Port", "Folder Path", "Login User Name", and " Login Password" .

The table below explains the items to be entered.

Item	Description
<b>Host Name</b> *1	Host name or IP address of FTP server
<b>Port</b>	Port number If the port number is not specified, the default port number is 21.
<b>Folder Path</b> *2	Path for the file to be stored. For example: User \ ScanData If no path is entered, the file is stored in the home directory.
<b>Login User Name</b>	FTP server login user name
<b>Login Password</b>	FTP server login password

\*1 To enter the IPv6 address, enclose the address in brackets [ ].  
(Example: [2001:db8:a0b:12f0::10])

\*2 When the FTP server is based on Linux/UNIX, the path including the sub-folder is combined by the slash "/" not using the back-slash.



#### NOTE

- For details on entering characters, refer to the following:  
➔ [Character Entry Method \(page 11-10\)](#)
- Select [Connection Test] or [Connection Test (Encrypted TX)] to check the connection to the server you chose. If the connection fails, check the entries you made.

## 4 Check if the destination entry is correct > [Register]

The destination is added to the Address Book.

To add a new address to the One Touch Key, select [Register] and follow the on-screen instructions to enter the necessary information.



#### NOTE

- Refer to the following for registering the One Touch Key.  
➔ [Adding a Destination on One Touch Key \(One Touch Key\) \(page 3-41\)](#)



## Add the group

Compile two or more contacts into a group. Designations in the group can be added at the same time. When adding a group, a maximum of 50 groups can be added in the Address Book..

### NOTE

To add a group, you need individually added destinations. Register one or more individual destinations as needed before proceeding. Up to 100 individually registered destinations and a combined total of up to 5 SMB and FTP destination folders can be registered in a single group.

## 1 Display the screen.

[Home] key > [...] > [System Menu] > [Function Settings] > [Address Book] > [Add/Edit Machine Address Book] > [Add] > [Group]

## 2 Add the name.

- 1 Enter an address number.

To have the number assigned automatically, select [Auto] (0000) .

### NOTE

- Address Number is an ID for a destination. You can select any available number out of 200 numbers for contacts and 50 numbers for groups.
- If you specify an address number that is already in use, an error message appears when you select [Save] and the number cannot be registered. If you set [Auto] (0000) as the address number, the address is registered under the lowest available number.

- 2 Enter the group name displayed on the Address Book.

### NOTE

For details on entering characters, refer to the following:

➔ [Entering Characters \(page 11-12\)](#)

## 3 Select the destinations.

- 1 Select destinations (contacts) to add to the group.

Put a checkmark in the checkbox to select an item and remove the checkmark to cancel the selection.

### NOTE

Destinations can be sorted or searched by destination name or address number.

➔ [Choosing from the Address Book \(page 5-36\)](#)

## 4 Check if the group entry is correct > [Save]

The group is added to the Address Book.

To add a new address to the One Touch Key, select [Register] and follow the on-screen instructions to enter the necessary information.

### NOTE

Refer to the following for registering the One Touch Key.

➔ [Adding a Destination on One Touch Key \(One Touch Key\) \(page 3-41\)](#)

## Editing Contact Address in Address Book

Edit the destinations (contacts) you added to the Address Book.

### 1 Display the screen.

- 1 [Home] key > [...] > [System Menu] > [Function Settings] > [Address Book] > [Add/Edit Machine Address Book]
- 2 Select [] (information icon) for the destination or group to edit.



#### NOTE

Destinations can be sorted or searched by destination name or address number.

➔ [Choosing from the Address Book \(page 5-36\)](#)

### 2 Edit a contact address.

- 1 Change " Name" , " Address Number" and destination type and address.
  - ➔ [Registering an Address \(E-mail Address\) \(page 3-33\)](#)
  - ➔ [Registering an Address \(Folder \(FTP\) Address\) \(page 3-36\)](#)
  - ➔ [Add the group \(page 3-38\)](#)
- 2 [Save] > [OK].

Register the changed destination.

## Editing Group Address in Address Book

Edit the destinations (group address) you added to the Address Book.

### 1 Display the screen.

- 1 [Home] key > [...] > [System Menu] > [Function Settings] > [Address Book] > [Add/Edit Machine Address Book]
- 2 Select [] (information icon) for the destination or group to edit.



#### NOTE

Destinations can be sorted or searched by destination name or address number.

➔ [Choosing from the Address Book \(page 5-36\)](#)

### 2 Edit a contact address.

- 1 Change " Name" and " Address Number" .
  - ➔ [Registering an Address \(E-mail Address\) \(page 3-33\)](#)
- 2 Change the destination.

Put a checkmark in the checkbox to select an item and remove the checkmark to cancel the selection.
- 3 [Save] > [OK].

Register the changed destination.

## Deleting Address Book Entries

Edit the destinations (group address) you added to the Address Book.

### 1 Display the screen.

- 1 [Home] key > [...] > [System Menu] > [Function Settings] > [Address Book] > [Add/Edit Machine Address Book]
- 2 Select a destination or group to delete.



#### NOTE

Destinations can be sorted or searched by destination name or address number.

➔ [Choosing from the Address Book \(page 5-36\)](#)

### 2 [Delete] > [Delete]

Delete the contact or group.

## Adding a Destination on One Touch Key (One Touch Key)

Assign a new destination (contact or group) to an one touch key.

### NOTE

- Refer to the following for use of One Touch Key.
  - ➔ [Checking and Editing Destinations \(page 5-39\)](#)
- Registration/editing of One Touch Keys can also be performed from Command Center RX.
  - ➔ [Registering Destinations \(page 2-78\)](#)
- If registering and editing of the One Touch Keys is restricted to administrators, you can edit the One Touch Keys by logging in with administrator privileges.
  - ➔ [Edit Restriction \(page 8-32\)](#)
- ➔ [Command Center RX User Guide](#)

### 1 Display the screen.







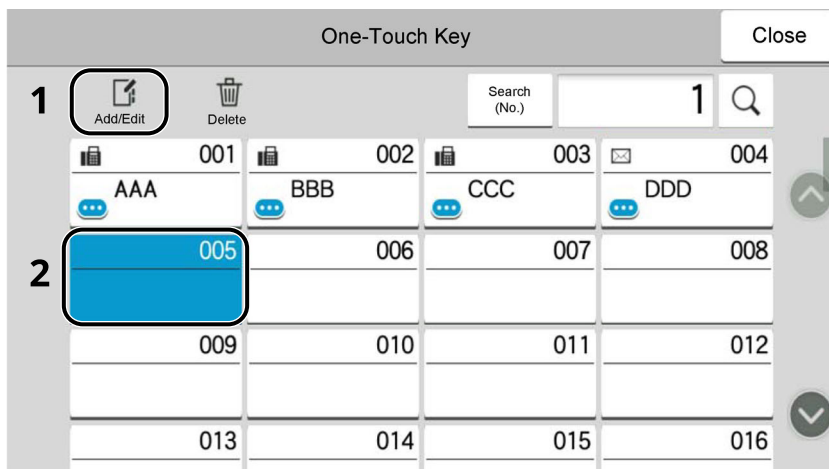

[Home] key > [...] > [System Menu] > [Function Settings] > [One-Touch Key] > [Add/Edit One Touch Key]

### 2 Add One Touch Keys.

- 1 Select a One Touch Key number for the destination > [Add/Edit]

Enter a number in [Search (No.)] and select  (search icon) to display that One Touch Key.  
Select a One Touch Key with no registered destination.



One-Touch Key		Close	
1	 Add/Edit	 Delete	Search (No.) 1 
	 001 AAA	 002 BBB	 003 CCC
	 004 DDD		
2	 005		

- 2 Enter the One Touch Key name displayed in the send base screen.

### NOTE

For details on entering characters, refer to the following:

- ➔ [Character Entry Method \(page 11-10\)](#)

- 3 Select [Destination].

The Address Book appears.

- 4 Select a destination (contact or group) to add to the One Touch Key number > [OK]  
Selecting [⋮] (information icon) shows the detailed information of the selected destination.



**NOTE**

Destinations can be sorted or searched by destination name or address number.

➔ [Choosing from the Address Book \(page 5-36\)](#)

- 5 Select [OK].  
Add the destination to the One Touch Key.

## Editing the Destination to the One Touch Key

### 1 Display the screen.

- 1 [Home] key > [...] > [System Menu] > [Function Settings] > [One-Touch Key] > [Add/Edit One Touch Key]
- 2 Select a One Touch Key number to edit > [Add/Edit]  
Enter a number in [Search (No.)] and select 🔍 (search icon) to display that One Touch Key.



**NOTE**

Select [⋮] (information icon) for the One Touch Key to display the information registered in the One Touch Key.

### 2 Change the Registered Information.

- 1 Change " Display Name" .



**NOTE**

For details on entering characters, refer to the following:

➔ [Character Entry Method \(page 11-10\)](#)

- 2 Select [Destination] , and select a new destination (contact or group). [⋮] (information icon) selection shows the detailed information of the selected destination.



**NOTE**

Destinations can be sorted or searched by destination name or address number.

➔ [Choosing from the Address Book \(page 5-36\)](#)

- 3 [OK] > [OK]  
Add the destination to the One Touch Key.

## Deleting the Destination to the One Touch Key

### 1 Display the screen.

1 [Home] key > [...] > [System Menu] > [Function Settings] > [One-Touch Key] > [Add/Edit One Touch Key]

2 Select a One Touch Key number to delete.

Enter a number in [Search (No.)] and select  (search icon) to display that One Touch Key.

### 2 Delete the Registered Information.

1 [Delete] > [Delete]

2 The data registered in the One Touch Key is deleted.

# 4 Printing from PC

This chapter explains the following topics:

Printer Driver Print Settings Screen .....	4-2
Printer Driver Help .....	4-3
Changing the Default Printer Driver Settings (Windows 10) .....	4-3
Printing from PC .....	4-4
Printing on Non-standard Sized Paper .....	4-7
Printing with Universal Print .....	4-10
Banner printing .....	4-13
Canceling Printing from a Computer .....	4-17
Printing from the Handheld Device .....	4-18
Printing by AirPrint .....	4-18
Printing by Mopria .....	4-18
Printing with Wi-Fi Direct .....	4-18
Printing Data Saved on the Printer .....	4-19
Specifying the Job Box from a Computer and Storing the Job .....	4-19
Printing Documents from Private Print Box .....	4-20
Deleting the Documents Stored in the Private Print Box .....	4-21
Printing Document from Stored Job Box .....	4-22
Deleting the Documents Stored in the Stored Job Box .....	4-23
Printing Document from Quick Copy Box .....	4-24
Deleting the Documents Stored in the Quick Copy Box .....	4-25
Printing Document from Proof and Hold Box .....	4-26
Deleting the Documents Stored in the Proof and Hold Box .....	4-27
Printing Documents from PIN Print Box .....	4-28
Deleting the Documents Stored in the PIN Print Box .....	4-28
Printing Document from the Universal Print box .....	4-29
Deleting the Documents Stored in the Universal Print Box .....	4-30
Monitoring the Printer Status (Status Monitor) .....	4-31
Accessing the Status Monitor .....	4-31
Exiting the Status Monitor .....	4-31
Quick View State .....	4-31

# Printer Driver Print Settings Screen

The printer driver print settings screen allows you to configure a variety of print-related settings.

➔ **Printer Driver User Guide**

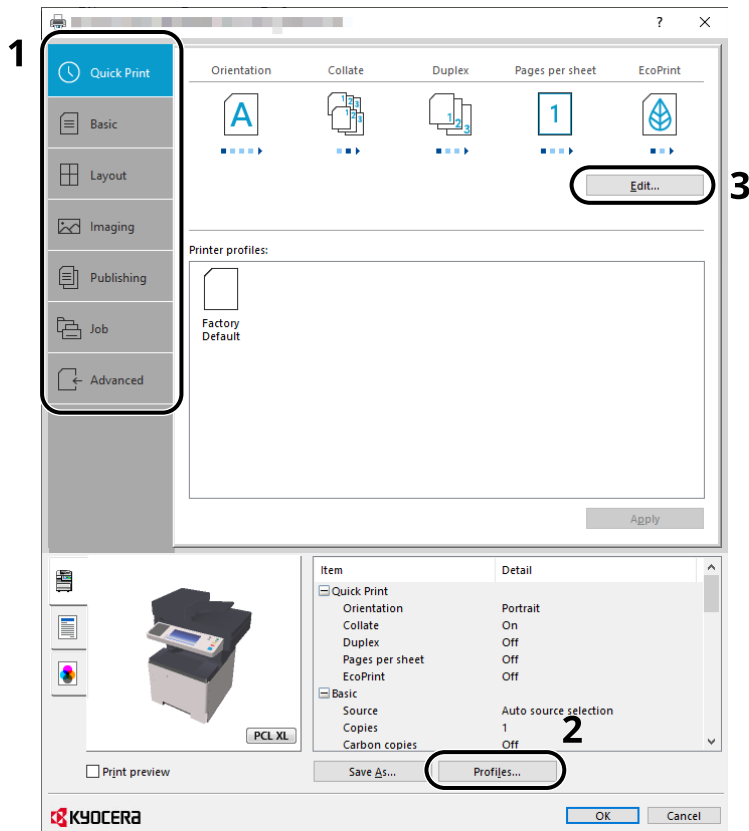

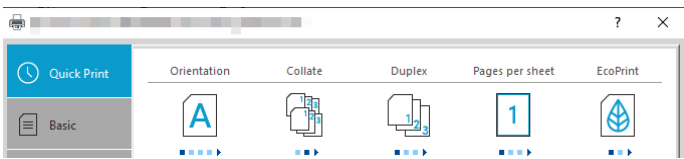
No.	Description
1	<p><b>[Quick Print] tab</b> Provides icons that can be used to easily configure frequently used functions. Each time you click an icon, it changes to an image resembling the print results and applies the settings.</p>  <p><b>[Basic] tab</b> This tab groups basic functions that are frequently used. You can use it to configure the paper size, and duplex printing.</p> <p><b>[Layout] tab</b> This tab lets you configure settings for printing various layouts, including booklet printing, combine mode, poster printing, and scaling.</p> <p><b>[Imaging] tab</b> This tab lets you configure settings related to the quality of the print results.</p> <p><b>[Publishing] tab</b> This tab lets you create covers and inserts for print jobs and put inserts between sheets of OHP film.</p> <p><b>[Job] tab</b> This tab lets you configure settings for saving print data from the computer to the machine. Regularly used documents and other data can be saved to the machine for easy printing later. Since saved documents can be printed directly from the machine, this function is also convenient when you wish to print a document that you don't want others to see.</p> <p><b>[Advanced] tab</b> This tab lets you configure settings for adding text pages or watermarks to print data.</p>



No.	Description
2	<b>[Profiles]</b> Printer driver settings can be saved as a profile. Saved profiles can be recalled at any time, so it's a convenient practice to save frequently used settings.
3	<b>[Edit...]</b> The assortment of icons at the top of the Quick Print tab can be customized to include features that you use most often.

## Printer Driver Help

The printer driver includes Help. To learn about print settings, open the printer driver print settings screen and display Help as explained below.

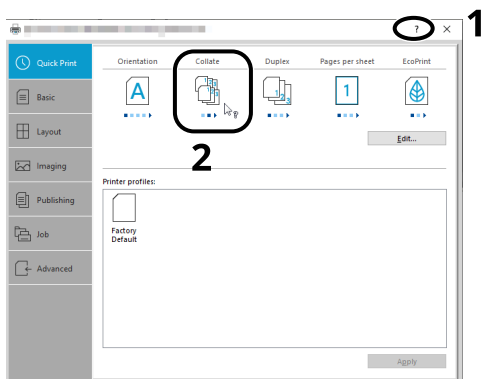

- 1 Click the [?] button in the upper right corner of the screen and then click the item you want to know about.
- 2 Click the item you want to know about and press the [F1] key on your keyboard.

## Changing the Default Printer Driver Settings (Windows 10)

The default printer driver settings can be changed. By selecting frequently used settings, you can omit steps when printing. For the settings, refer to the following:

### ➔ Printer Driver User Guide

- 1 Click [Start] button on the Windows and then select [Windows System], [Control Panel], and [View devices and printers].
- 2 Right-click the printer driver icon of the machine, and click the [Print Setup] menu of the printer driver.
- 3 Click the [Basic] button on the [General] tab.
- 4 Select the default settings and click the [OK] button.

# Printing from PC

This section provides the printing method using the KX DRIVER.

## NOTE

- To print the document from applications, install the printer driver on your computer.
- In some environments, the current settings are displayed at the bottom of the printer driver.

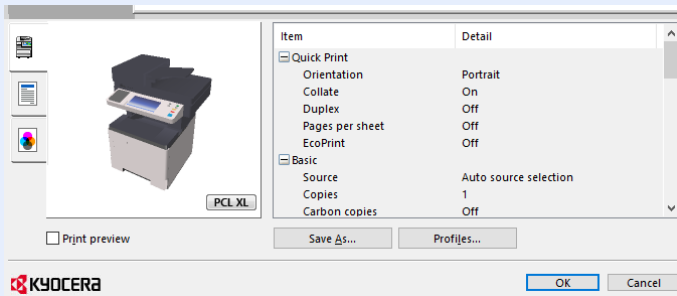

- When printing the cardstock or envelopes, load the cardstock or envelopes in the multi purpose tray before performing the following procedure.

➔ [When you load envelopes or cardstock in the multi purpose tray \(page 3-14\)](#)

# Printing on Standard Sized Paper

If you loaded a paper size that is included in the print sizes of the machine, select the paper size in the [**Basic**] tab of the print settings screen of the printer driver.

## NOTE

- To execute printing at the machine, set the paper size and type in the following:

➔ [Paper Feed Settings \(page 8-18\)](#)

## 1 Display the screen.

Click [**File**] and select [**Print**] in the application.

## 2 Configure the settings.

- 1 Select the machine from the "Printer" menu and click the [**Properties**] button.

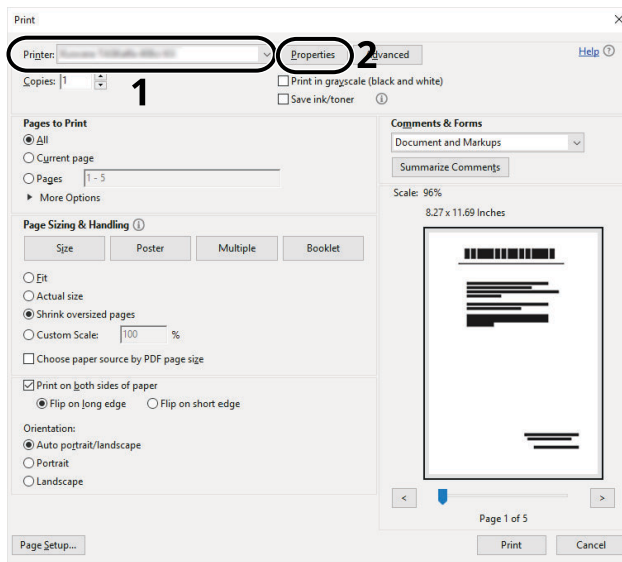

- 2 Select the **[Basic]** tab.
- 3 Click "Print size" menu and select the paper size to use for printing.

To load the paper of size that is not included in print sizes of the machine such as cardstock or envelopes, the paper size needs to be registered.

➔ [Printing on Non-standard Sized Paper \(page 4-7\)](#)

To print on the special paper such as thick paper or transparency, click "Media type" menu and select the media type.

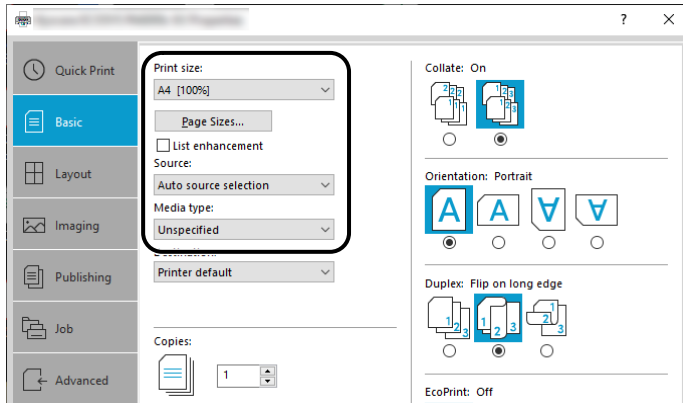

- 4 Click **[OK]** button to return to the Print dialog box.

### 3 Start printing.

Click the **[OK]** button.

## Printing on Non-standard Sized Paper

If you loaded a paper size that is not included in the print sizes of the machine, register the paper size in the **[Basic]** tab of the print settings screen of the printer driver.

The registered size can be selected from the "Print size" menu.

### NOTE

To execute printing at the machine, set the paper size and type in the following:

➔ [Paper Size and Media Type for the Multi Purpose Tray \(MP Tray Setting\) \(page 3-16\)](#)

## 1 Display the screen.

- 1 Click **[Start]** button on the Windows and then select **[Windows System]**, **[Control Panel]**, and **[View devices and printers]**.

### NOTE

In Windows 8.1, in charms on Desktop, click **[Settings]**, **[Control Panel]**, and then **[Devices and Printers]**.

- 2 Right-click the printer driver icon of the machine, and click the **[Printer properties]** menu of the printer driver.
- 3 Click the **[Preferences]** button on the **[General]** tab.

## 2 Register the paper size.

- 1 Click the **[Basic]** tab.

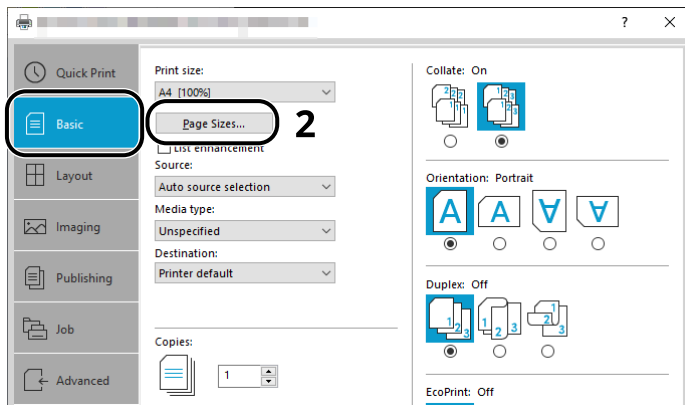

- 2 Click the **[Page Size...]** button.

- 3 Click the **[New]** button.

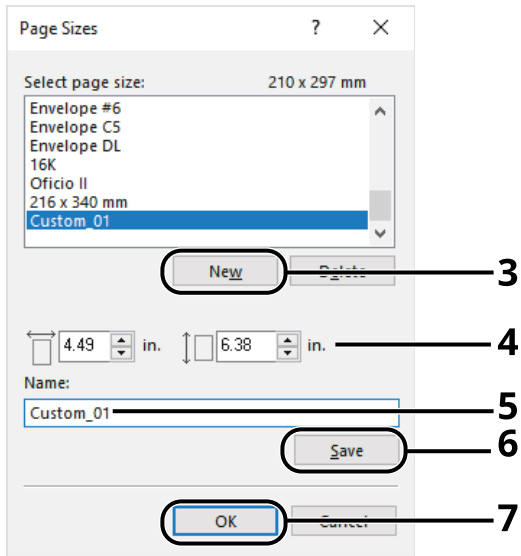

- 4 Enter the paper size.
- 5 Enter the name of the paper.
- 6 Click the **[Save]** button.
- 7 Click the **[OK]** button.
- 8 Click the **[OK]** button.

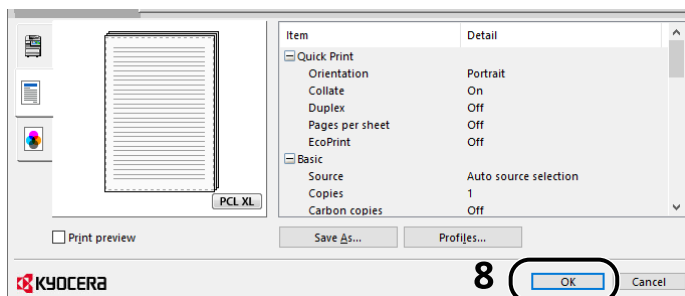

- 3 **Display the print settings screen.**  
Click **[File]** and select **[Print]** in the application.

## 4 Select the paper size and type of non-standard size paper.

- 1 Select the machine from the "Printer" menu and click the **[Properties]** button.

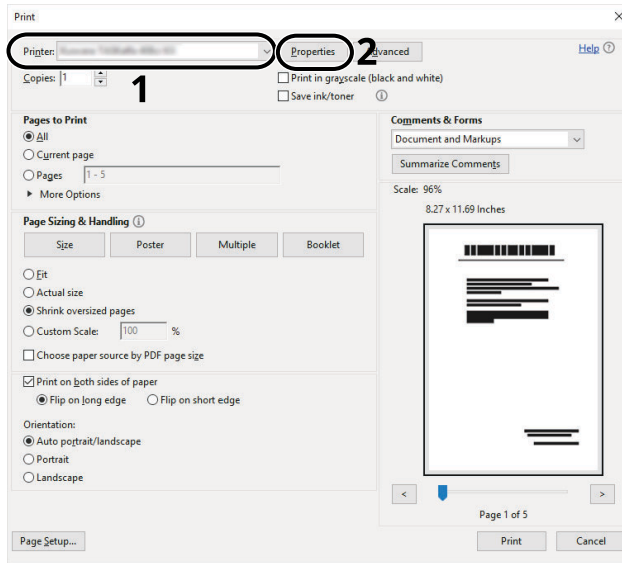

- 2 Select the **[Basic]** tab.
- 3 Click "Print size" menu and select the paper size registered in step 2.

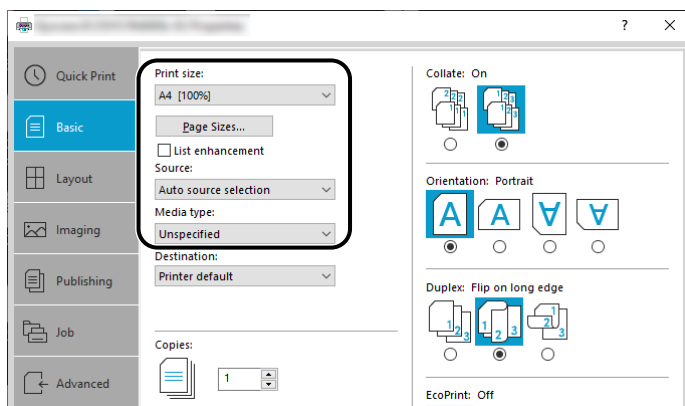

To print on the special paper such as thick paper or transparency, click "Media type" menu and select the media type.

### NOTE

If you loaded a postcard or envelope, select **[Cardstock]** or **[Envelope]** in the "Media type" menu.

- 4 Select the paper source in the "Source" menu.
- 5 Click **[OK]** button to return to the Print dialog box.

## 5 Start printing.

Click the **[OK]** button.

## Printing with Universal Print

You can use the "Universal Print" cloud service provided by Microsoft to print jobs via the cloud. Users who are authorized in Azure Active Directory can print from any location using printers that are compatible with Universal Print.

### NOTE

- In order to use Universal Print, it is necessary for Microsoft365 license, and Azure Active Directory account. If not, please acquire those license and the account.
- To use Universal Print, the following conditions are required.
  - The license of Universal Printer has been granted.
  - All administrators have Printer Administrator or Global Administrator privileges.

### Register this machine on Universal Print

#### 1 Start up the browser.

Enter "https://" and host name of the machine to access the Command Center RX

➔ [Accessing Command Center RX \(page 2-72\)](#)

#### 2 Display the screen.

[Function Settings] > [Printer] > "Universal Print Settings" [Settings]

#### 3 Configure the settings.

- 1 Enter "Printer Name" for "General".

### NOTE

Configure proxy settings as necessary.

➔ [Command Center RX User Guide](#)

- 2 Click [**Register**] in "Universal Print".

The URL and access code of the Microsoft web page are displayed.

- 3 Click the URL, enter the access code displayed in procedure 2 > [**Next**]

- 4 Log in using your Azure administrator's account name and password.

### NOTE

Permission is required only when registering for the first time. Click [**Accept**].

- 5 Close the Microsoft web page and return to the Command Center RX.

- 6 Click [**OK**].

Return to the Universal Print setting screen.

### NOTE

On completing registration, [**Register**] in "Universal Print" changes to [**Unregister**], and the validity period of the certificate is displayed. If the display does not change, click [**Refresh**].

- 7 Click [**Edit**] in "Universal Print Preferences" and copy the Unregistration URL.



- 8 Open the new tab on the browser and paste the copied URL.  
The Universal Print web page is displayed.
- 9 Click [**Printer**].  
The printers registered are displayed.
- 10 Check the checkbox next to the name of the printer you want to share and click [**Share**].  
The "Share Printers" setting screen is displayed.
- 11 Select users to share this machine from the "Select members" list, and click [**Share Printer**].



#### NOTE

Set [**Allow access to everyone in my organization**] to on to all users in your organization to share the printer.

- 12 Close the Universal Print website.

## Register shared printers on a PC

To use Universal Print, shared printers registered in Universal Print must be added to the PC.

### 1 Log in.

- 1 Select in Windows [**Start**] button > [**Settings**] > [**Account**] > [**Access work or school**] in that order.
- 2 Check that the Azure administrator account name is displayed in [**Work or school account**], and click.



#### NOTE

When the Azure administrator account name is not displayed, click [**+**] (connect), and log in using the Azure administrator account name and password.

### 2 Display the screen.

Select [**Home**] > [**Device**] > [**Printers & scanners**] in that order.

### 3 Configure the settings.

- 1 Click [**Add a printer or scanner**].
- 2 Select a shared printer and click [**Add device**].  
The shared printer is registered.

## Print a job

### 1 Display the screen.

Click [**File**] and select [**Print**] in the application.

### 2 Configure the settings.

1 Select a registered shared printer from the "Printer" menu, and click the [**Properties**] button.

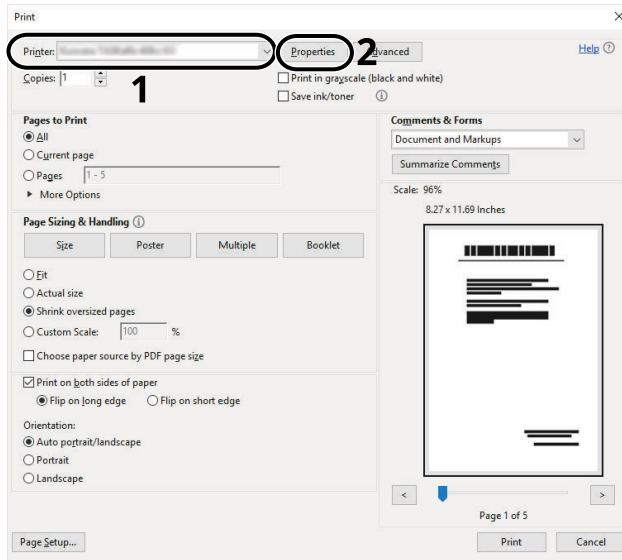

2 Configure the paper size and printer functions as necessary.

3 Click [**OK**] button to return to the Print dialog box.

### 3 Start printing.

Click the [**OK**] button.

## Banner printing

When a document length from 470.1 mm (18.52") to a maximum of 915.0 mm (36.03") is specified for printing, the print job is treated as banner printing.

<b>Max. number of sheets</b>	1 sheet (multi purpose tray)
<b>Paper width</b>	210 mm to 216 (8.5") mm
<b>Paper length</b>	470.1 mm to 915 mm (18.51" to 36.03")
<b>Paper weight</b>	136 to 163 g/m <sup>2</sup>
<b>Paper type</b>	Heavy 2

### 1 Display the screen.

Click [File] and select [Print] in the application.

### 2 Configure the settings.

1 Select the machine from the "Name" menu and click the [Properties] button.

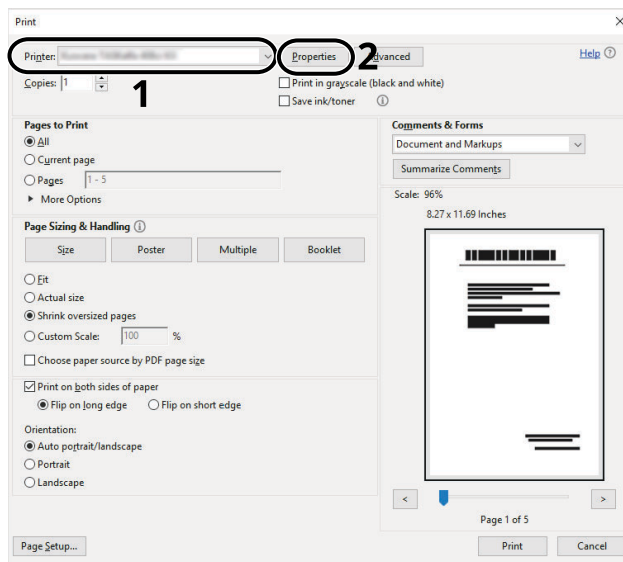

2 Select the [Basic] tab.

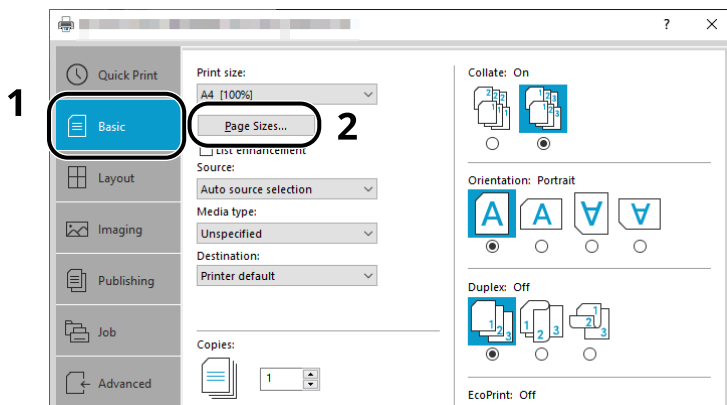

3 Click the [Page Size...] button.

### 3 Register the paper size.

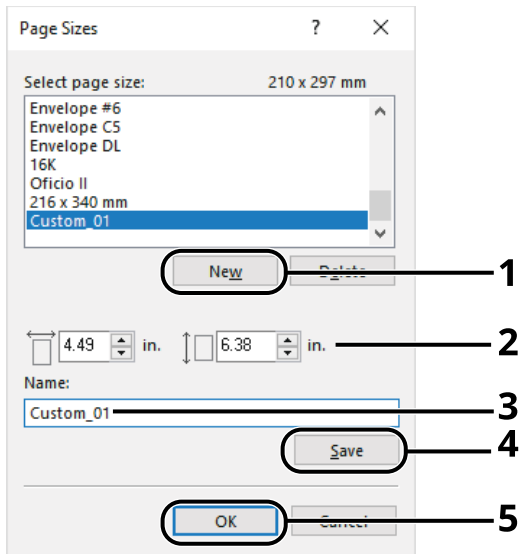

- 1 Click the **[New]** button.
- 2 Enter the length (470.1 mm (18.52") or longer), and width of the custom paper size being registered.
- 3 Enter the name of the paper.
- 4 Click the **[Save]** button.
- 5 Click the **[OK]** button.

### 4 Configure the print paper size.

- 1 Click "Print size" menu and select the paper size registered in step 3.

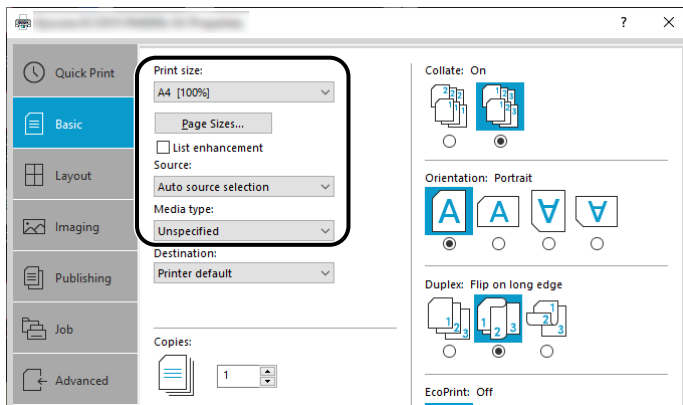

- 2 Click "Source" menu and select **[Multipurpose tray]**.
- 3 Click "Media type" menu and select **[Plain]**.
- 4 Click the **[OK]** button.

#### **NOTE**

When banner printing, a resolution of 600 dpi is set.

## 5 Load paper.

- 1 Open the multi purpose tray and extend the support tray section of the multi purpose tray.

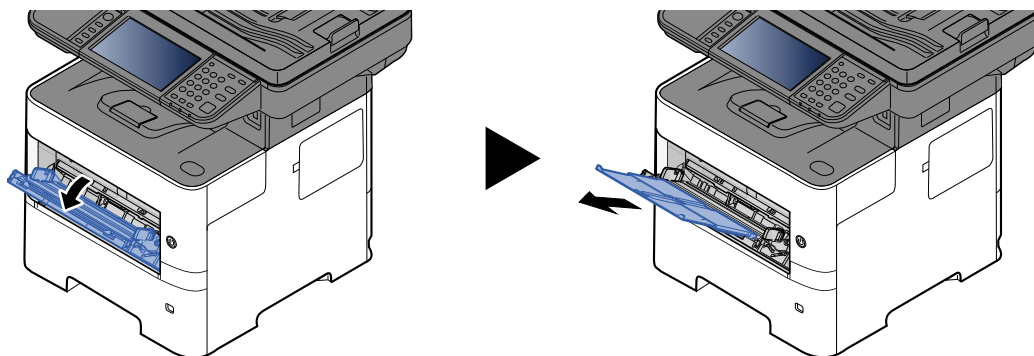

- 2 Load paper.

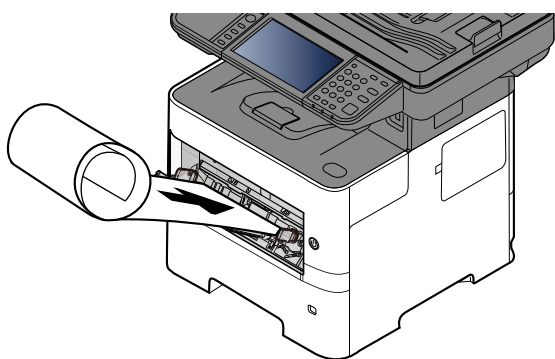

## 6 Start printing.

Click the **[OK]** button.

When you execute printing in this case, a message appears on the machine's operation panel. Place the paper in the Multi Purpose tray, continue to support it so that it does not fall, and select **[Continue]**. To cancel printing, select **[Cancel]**.

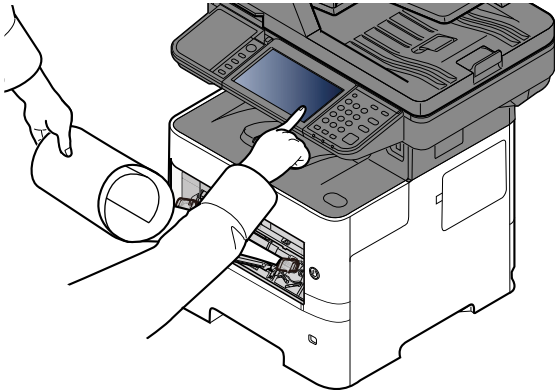

### ✔ IMPORTANT

**When printing multiple banner sheets, set the paper every time printing one sheet and select **[Continue]**.**

**After pressing **[Continue]**, support the paper with both hands so that it feeds in correctly.**

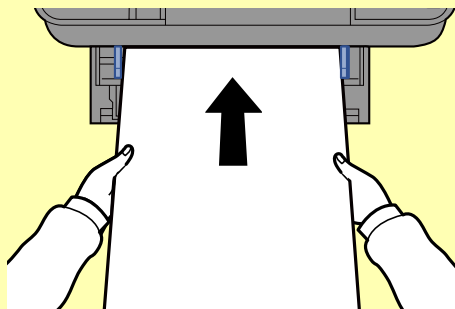

**After printing starts, catch the paper when it is output so that it does not fall. When using the inner tray as the output location, do not stand up the stopper.**

Set whether the confirmation screen appears before each sheet is printed when printing multiple banner sheets.

➔ [Message Banner Print \(page 8-35\)](#)

## Canceling Printing from a Computer

To cancel a print job executed using the printer driver before the printer begins printing, do the following:

 **NOTE**

When canceling printing from this machine, refer to the following:

➔ [Canceling Jobs \(page 5-16\)](#)

- 1 Double-click the printer icon (  ) displayed on the taskbar at the bottom right of the Windows desktop to display a dialog box for the printer.
- 2 Click the file for which you wish to cancel printing and select [**Cancel**] from the "Document" menu.

## Printing from the Handheld Device

This machine supports the AirPrint and Mopria. According to the supported OS and application, you can print the job from any handheld device or computer without installing a printer driver.

### Printing by AirPrint

AirPrint is a printing function that is included standard in iOS 4.2 and later products, and Mac OS X 10.7 and later products.

This function enables you to connect and print to any AirPrint compatible device without installing a printer driver.

To allow the machine to be found when printing by AirPrint, you can set machine location information in Command Center RX.

➔ **Command Center RX User Guide**



### Printing by Mopria

Mopria is a standard on printing function included in Android 4.4 or later products. Mopria Print Service needs to be installed and enabled in advance.

For details on how to use, refer to a Web site of Mopria Alliance.



### Printing with Wi-Fi Direct

Wi-Fi Direct is a wireless LAN standard that Wi-Fi Alliance has been established. This is one of the functions of the wireless LAN, without a wireless LAN access point or wireless LAN router, between devices can communicate directly on a peer to peer basis.

The printing procedure by the Wi-Fi Direct is the same as that from the normal handheld devices.

When you use a printer name or Bonjour name on the port settings of the printer property, you can print the job by specifying the name at Wi-Fi Direct connection.

When you use an IP address for the port, specify the IP address of this machine.



# Printing Data Saved on the Printer

You can save the print job into the Job Box of this device and print it as necessary. If you configure settings in the **[Job]** tab of the printer driver and then print, the print job will be saved in the Job Box (memory) and printing can be executed at the machine.

To print the job in Job Box, specify the Job Box from a computer and sending the print job, then specify a file within a Box and printing it, using the operation panel.

You can print the documents from the following boxes.

- Private Print Box
  - ➔ [Printing Documents from Private Print Box \(page 4-20\)](#)
- Stored Job Box
  - ➔ [Printing Document from Stored Job Box \(page 4-22\)](#)
- Quick Copy Box
  - ➔ [Printing Document from Quick Copy Box \(page 4-24\)](#)
- Proof and Hold Box
  - ➔ [Printing Document from Proof and Hold Box \(page 4-26\)](#)
- PIN Print Box
  - ➔ [Printing Documents from PIN Print Box \(page 4-28\)](#)

## Specifying the Job Box from a Computer and Storing the Job

Use the procedure below to store data in a Job Box.

- 1 Click **[File]** and select **[Print]** in the application. The Print dialog box displays.
- 2 Select the machine from the "Name" menu.
- 3 Click the **[Properties]** button. The Properties dialog box displays.
- 4 Click the **[Job]** tab and select the **[Job storage (e-MPS)]** check box to set the function.



### NOTE

- To use Stored Job Box and Quick Copy Box, an optional SSD must be installed in the machine.
- For information on how to use the printer driver software, refer to the following:
  - ➔ **Printer Driver User Guide**

## Printing Documents from Private Print Box

In Private Printing, you can specify that a job is not to be printed until you operate the machine. When sending the job from the application software, specify a 4-digit password in the printer driver. The job is released for printing by entering the password on the operation panel, ensuring confidentiality of the print job. The data will be deleted upon completion of the print job or after the power switch is turned off.

### 1 Display the screen.

- 1 Select the [**Home**] key > [**Job Box**].
- 2 Select [**Private Print/Stored Job**].
- 3 Select the creator of the document.

### 2 Print the document.

- 1 Select the document to print > [**Print**]
- 2 Enter the password.  
If a password is not set, go to step 3.
- 3 Specify the number of copies to print as desired.
- 4 Select [**OK**].

Printing starts.

Upon completion of printing, the Private Print job is automatically deleted.

## Deleting the Documents Stored in the Private Print Box

### 1 Display the screen.

- 1 Select the [Home] key > [Job Box].
- 2 Select [Private Print/Stored Job].
- 3 Select the creator of the document.

### 2 Delete the document.

- 1 Select the document to delete > [delete]

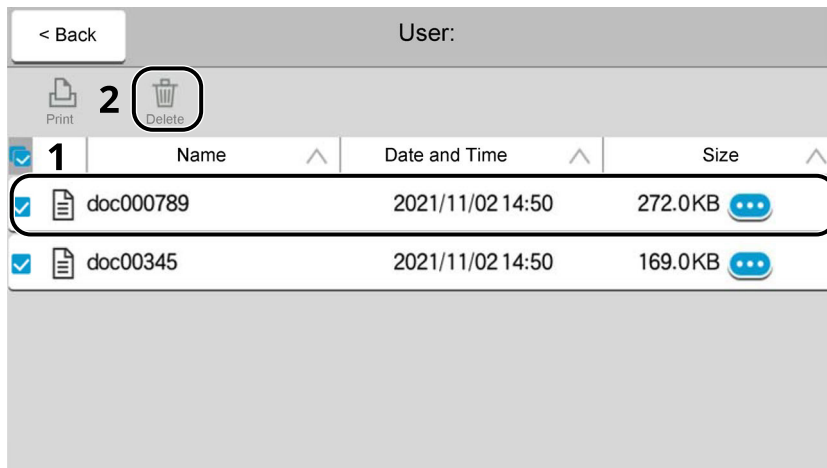

- 2 If the document is protected by a password, enter the password.  
The document is deleted.

## Printing Document from Stored Job Box

In Stored Job, the print data sent from the application is saved to the machine. You can set up a password as necessary. If you set up a password, enter the password when printing. Print data will be stored in the Stored Job Box after printing. This will allow printing of the same print data repeatedly.

### 1 Display the screen.

- 1 Select the **[Home]** key > **[Job Box]**.
- 2 Select **[Private Print/Stored Job]**.
- 3 Select the creator of the document.

### 2 Print the document.

- 1 Select the document to print > **[Print]**
- 2 Specify the number of copies to print as desired.
- 3 Select **[start print]**.

Printing starts.



#### NOTE

If the document is protected by a password, the password entry screen will be displayed. Enter the password using the numeric keys.

## Simple Job Printing

When you save a print job performed via user login to the Stored Job Box, logging in with an ID card at the time of printing displays a list of your print jobs in the Stored Job Box. When you run the print job, printing starts immediately.

User login administration that uses the optional ID card Authentication Kit is required. For details on user login administration for printing, refer to the following:

- ➔ [Adding a User \(Local User List\) \(page 9-6\)](#)
- ➔ [User Login Administration for Printing \(page 9-11\)](#)

For ID card settings, refer to the following:

- ➔ [ID Card Settings \(page 9-29\)](#)

For Simple Job Printing settings, refer to the following:

- ➔ [Quick Job Printing \(page 9-30\)](#)

## Deleting the Documents Stored in the Stored Job Box

### 1 Display the screen.

- 1 Select the [**Home**] key > [**Job Box**].
- 2 Select [**Private Print/Stored Job**].
- 3 Select the creator of the document.

### 2 Print and delete the document.

- 1 Select the document to delete > [**delete**] > [**delete**]

The document is deleted.



#### NOTE

If the document is protected by a password, the password entry screen will be displayed. Enter the password using the numeric keys.

## Printing Document from Quick Copy Box

Quick Copy feature facilitates additional prints of a document already printed. Activating Quick Copy and printing a document using the printer driver allow the print data to be stored in the Quick Copy Job Box. When additional copies are required, you can reprint the required number of copies from the touch panel. By default, up to 32 documents can be stored. When power is turned off, all stored jobs will be deleted.

### NOTE

- When the number of jobs reaches the limit, the oldest job will be overwritten by the new one.
- To maintain free space on the box, you can set the maximum number of stored jobs.

➔ [Quick Copy Job Retention \(page 8-36\)](#)

### 1 Display the screen.

- 1 Select the [**Home**] key > [**Job Box**].
- 2 Select [**Quick Copy/Proof and Hold**].
- 3 Select the creator of the document.

### 2 Print the document.

- 1 Select the document to print > [**Print**]
- 2 Specify the number of copies to print as desired.
- 3 Select [**start print**].  
Printing starts.

## Deleting the Documents Stored in the Quick Copy Box

### 1 Display the screen.

- 1 Select the [**Home**] key > [**Job Box**].
- 2 Select [**Quick Copy/Proof and Hold**].
- 3 Select the creator of the document.

### 2 Delete the document.

Select the document to delete, and [**delete**] > [**delete**].

The document is deleted.

## Printing Document from Proof and Hold Box

The Proof and Hold feature produces only a single proof print of multiple-print job and holds printing of the remaining copies. Printing a multiple-print job in Proof and Hold using the printer driver allows only a single copy to be printed while maintaining the document data in the Job Box. To continue to print the remaining copies, use the touch panel. You can change the number of copies to print.

### 1 Display the screen.

- 1 Select the **[Home]** key > **[Job Box]**.
- 2 Select **[Quick Copy/Proof and Hold]**.
- 3 Select the creator of the document.

### 2 Print the document.

- 1 Select the document to print > **[Print]**
- 2 Specify the number of copies to print as desired.
- 3 Select **[start print]**.  
Printing starts.



## Deleting the Documents Stored in the Proof and Hold Box

### 1 Display the screen.

- 1 Select the [**Home**] key > [**Job Box**].
- 2 Select [**Quick Copy/Proof and Hold**].
- 3 Select the creator of the document.

### 2 Delete the document.

Select the document to delete, and [**delete**] > [**delete**].

The document is deleted.

## Printing Documents from PIN Print Box

This PIN Print Box holds printing when printing is executed from applications that use the IPP protocol, such as AirPrint and Mopria. A pending print job can be output by entering the PIN code that was set at the time of printing. When printing was executed without a PIN code, you do not need to enter the PIN code when outputting.

### 1 Display the screen.

- 1 [Home] key > [Job Box]
- 2 Select [PIN Print].
- 3 Select the creator of the document.

### 2 Print the document.

- 1 Select the document to print > [Print]
- 2 Set the PIN code.  
If a PIN code is not set, go to step 3.
- 3 Specify the number of copies to print as desired.
- 4 Select [Start Print].  
Printing starts.

## Deleting the Documents Stored in the PIN Print Box

### 1 Display the screen.

- 1 [Home] key > [Job Box]
- 2 Select [PIN Print].
- 3 Select the creator of the document.

### 2 Delete the document.

- 1 Select the document to delete > [Delete] > [Delete]  
The document is deleted.

## Printing Document from the Universal Print box

For enhanced security, Universal Print allows PIN codes to be set for print jobs. Jobs for which PIN codes have been set will be saved in the cloud without being printed. Enter a PIN code from the operation panel to make jobs printable from this machine.

### NOTE

- To use Universal Print, you must register this machine as a shared printer.
- ➔ [Register this machine on Universal Print \(page 4-10\)](#)
- In order to use Universal Print, it is necessary for Windows 11 or Microsoft365 license, and Azure Active Directory account. If not, please acquire those license and the account.

### Save jobs to the Universal Print box

#### 1 Display the screen.

Click [**File**] and select [**Print**] in the application.

#### 2 Configure the settings.

- 1 Select a registered shared printer from the "Printer" menu, and click the [**Properties**] button.

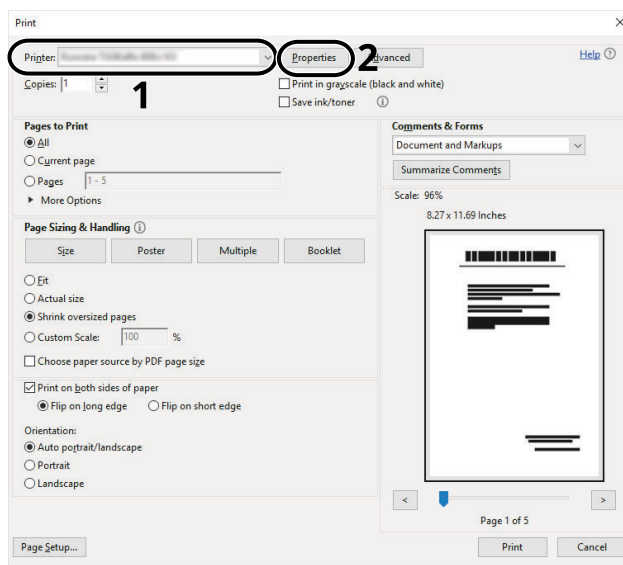

- 2 Click [**Advanced**].

- 3 Set [**PIN protected printing**] to [**On**], and set a 4-digit PIN code in [**PIN protected printing PIN**].

- 4 Select [**OK**] button > [**OK**] button in order, and return to the print dialog box.

#### 3 Start printing.

Click the [**OK**] button.

## Print jobs saved in the Universal Print box

### 1 Display the screen.

- 1 [Home] key > [Universal Print]
- 2 Select the creator of the document.

### 2 Print the document.

- 1 Select the document to print > [Print].
- 2 Enter the PIN code
- 3 Enter the number of copies, if necessary.
- 4 Select [Start Print].

Printing starts.

Automatically the Universal Print data is automatically deleted once printing is complete.

## Deleting the Documents Stored in the Universal Print Box

### 1 Display the screen.

- 1 [Home] key > [Universal Print]
- 2 Select the creator of the document.

### 2 Delete the document.

Select the document to delete > [Delete] > [Delete]

The document is deleted.

# Monitoring the Printer Status (Status Monitor)

The Status Monitor monitors the printer status and provides an ongoing reporting function.

## NOTE

When you activate Status Monitor, check the status below.

- KX DRIVER is installed.
- Either [Enhanced WSD] or [Enhanced WSD over TLS] is enabled.

➔ [Network Settings \(page 8-39\)](#)

## Accessing the Status Monitor

The Status Monitor also starts up when printing is started.

## Exiting the Status Monitor

Use either of the methods listed below to exit the Status Monitor.

- Exit manually:  
Click the settings icon and select Exit in the menu to exit the Status Monitor.
- Exit automatically:  
The Status Monitor automatically shuts down after 7 minutes if it is not being used.

## Quick View State

The status of the printer is displayed using icons. Detailed information is displayed when the Expand button is clicked.

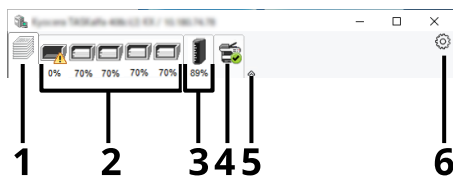

- 1 Printing Progress Tab
- 2 Paper Tray Status Tab
- 3 Toner Status Tab
- 4 Alert Tab
- 5 Expand button
- 6 Settings icon

Detailed information is displayed by clicking on each icon tab.

## Printing Progress Tab

The status of the print jobs is displayed.

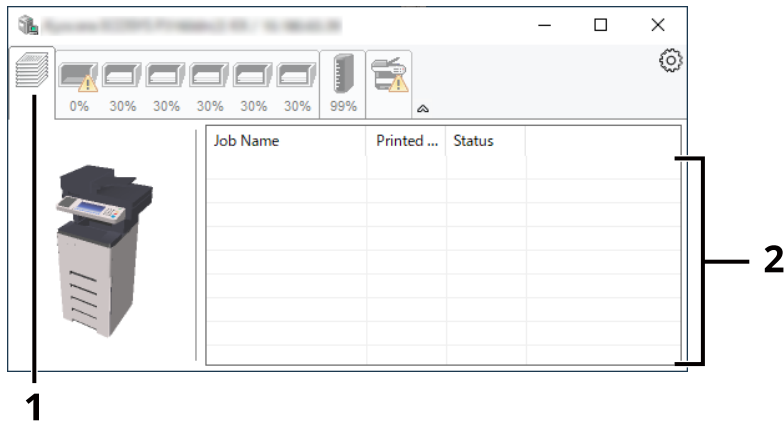

- 1 Status icon
- 2 Job list

## Paper Tray Status Tab

Information is displayed about the paper in the printer and about the amount of paper remaining.

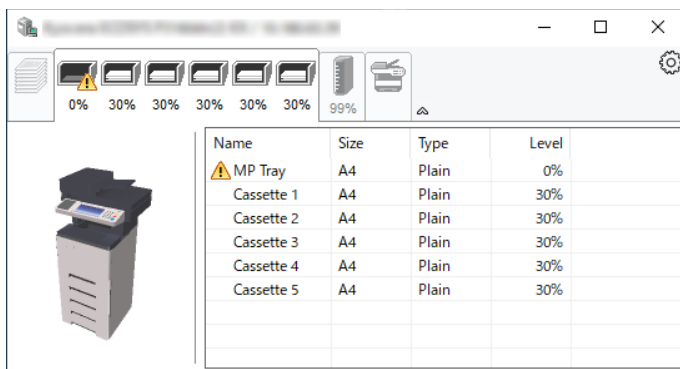

## Toner Status Tab

The amount of toner remaining is displayed.

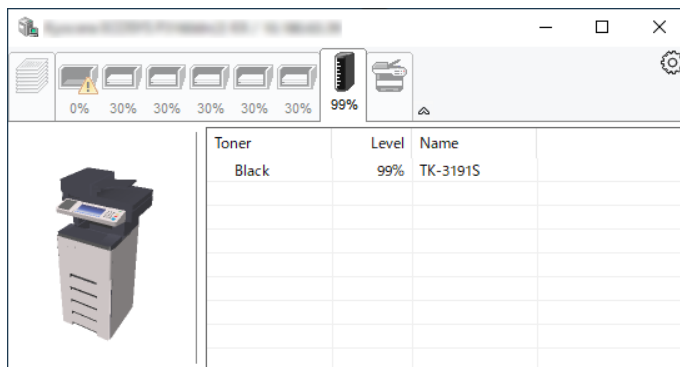

## Alert Tab

If an error occurs, a notice is displayed using a 3D image and a message.

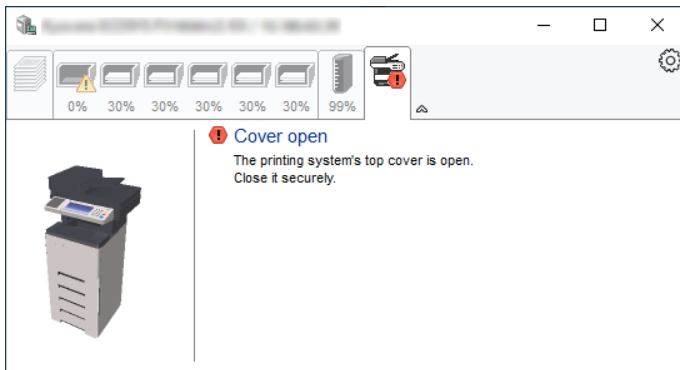

## Status Monitor Context Menu

The following menu is displayed when the settings icon is clicked.

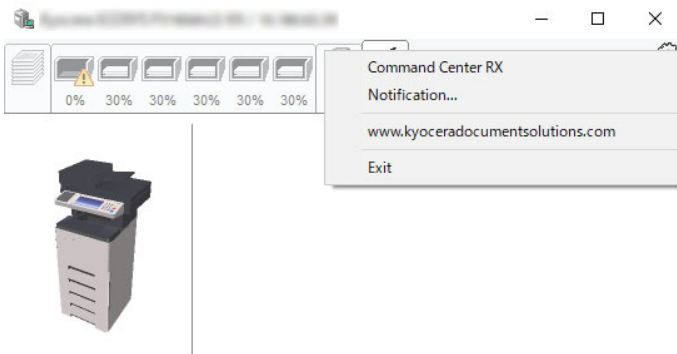

- **Command Center RX**  
If the printer is connected to a TCP/IP network and has its own IP address, use a web browser to access the Command Center RX to modify or confirm the network settings. This menu is not displayed when using USB connection.  
➔ **Command Center RX User Guide**
- **Notification...**  
This sets the display of the Status Monitor.  
➔ [Status Monitor Notification Settings \(page 4-34\)](#)
- **www.kyoceradocumentsolutions.com**  
Open our website.
- **Exit**  
Exits the Status Monitor.

## Status Monitor Notification Settings

The Status Monitor settings and event list details are displayed.

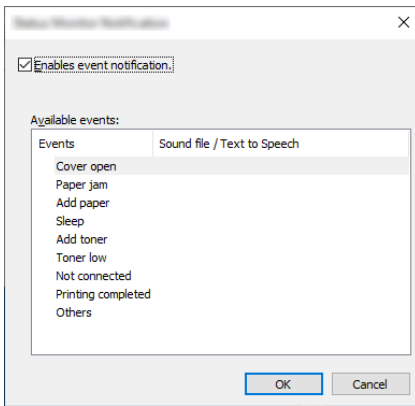

Select whether notification is performed when an error in the event list occurs.

### 1 Select Enable event notification.

If this setting is set to Off, then the Status Monitor will not start up even when printing is executed.

### 2 Select an event to use with the text to speech function in Available events.

### 3 Click Sound file / Text to Speech column.

Click the browse (...) button to notify the event by sound file.

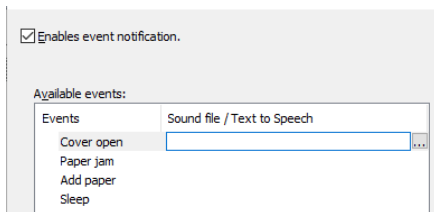

#### NOTE

The available file format is WAV.

When customizing the message texts to read on the screen aloud, enter the texts in the text box.



# 5 Operation on the Machine

This chapter explains the following topics:

Loading Originals .....	5-2	Specifying Destination .....	5-36
Placing Originals on the Platen .....	5-2	Choosing from the Address Book .....	5-36
Original Specifications available in the Document Processor .....	5-4	Choosing from the One Touch Key .....	5-38
Favorites .....	5-7	Choosing from the Search (No.) .....	5-38
Registering Favorites .....	5-8	Checking and Editing Destinations .....	5-39
Recalling Favorites .....	5-8	Confirmation Screen of Destinations .....	5-40
Editing Favorites .....	5-9	Recall .....	5-41
Application .....	5-10	How to use the FAX Function .....	5-42
Installing Applications .....	5-10	Using Document Boxes .....	5-43
Activating Applications .....	5-11	What is Custom Box? .....	5-43
Deactivating Applications .....	5-12	What is Job Box? .....	5-44
Uninstalling Applications .....	5-12	What is USB Drive Box? .....	5-44
Registering Shortcuts .....	5-13	Fax Box .....	5-44
Adding Shortcuts .....	5-13	Basic Operation for Document Box .....	5-44
Editing Shortcuts .....	5-14	Editing Custom Box .....	5-51
Deleting Shortcuts .....	5-14	Deleting Custom Box .....	5-52
Copying .....	5-15	Storing Documents to a Custom Box .....	5-52
Basic Operation .....	5-15	Printing Documents in Custom Box .....	5-53
Canceling Jobs .....	5-16	Saving Scanned Documents to a Custom Box .....	5-54
Basic Scanning (Sending) .....	5-17	Sending Documents in Custom Box .....	5-55
Sending Document via E-mail .....	5-18	Sending Documents in Custom Box to E-mail Address of Logged in User .....	5-56
Sending Document to Desired Shared Folder on a Computer (Scan to PC) .....	5-20	Moving Documents in Custom Box .....	5-56
Sending Document to Folder on an FTP Server (Scan to FTP) .....	5-23	Copying Documents in Custom Box into Other Boxes .....	5-57
Scanning using TWAIN or WIA .....	5-25	Copying Documents in Custom Box to USB Drive .....	5-57
Scanning Document stored in a Custom Box .....	5-26	Joining Documents in Custom Box .....	5-58
Useful Sending Method .....	5-27	Deleting Documents in Custom Box .....	5-59
WSD Scan .....	5-28	Operating using Removable USB Drive .....	5-60
Install the Driver (for Windows 10) .....	5-28	Printing Documents Stored in Removable USB Drive .....	5-60
Install the Driver (for Windows 8.1, Microsoft Windows Server 2012) .....	5-28	Saving Documents to USB Drive (Scan to USB) .....	5-62
Executing WSD scan .....	5-29	Check the USB Drive Information .....	5-63
Scanning with File Management Utility .....	5-30	Removing USB Drive .....	5-63
Sending to Different Types of Destinations (Multi Sending) .....	5-31	Using the Manual Stapler (ECOSYS MA6000ifx/ECOSYS MA5500ifx only) .....	5-64
Sending Documents to E-mail Address of Logged in User (to myself) .....	5-32		
Using a Fax Server to Send (Fax Server Send) .....	5-33		
Canceling Sending Jobs .....	5-35		
Handling Destination .....	5-36		

# Loading Originals

Load the originals on the platen or document processor, depending on the original size, type, volume, and function.

## Glass platen

Place the sheet, book, postcards, and envelopes.

## Document processor

Place the multiple originals. You can also place the two sided originals.

# Placing Originals on the Platen

You may place books or magazines on the platen in addition to ordinary sheet originals.

## 1 Put the scanning side facedown.

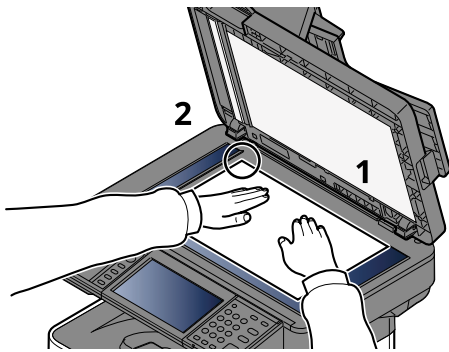

## 2 Align it flush against the original size indicator plates with the back left corner as the reference point.

### NOTE

For details on Original Orientation, refer to the following:

➔ [Original Orientation \(page 6-18\)](#)

## Placing Envelopes or Cardstock on the Platen

## 1 Put the scanning side facedown.

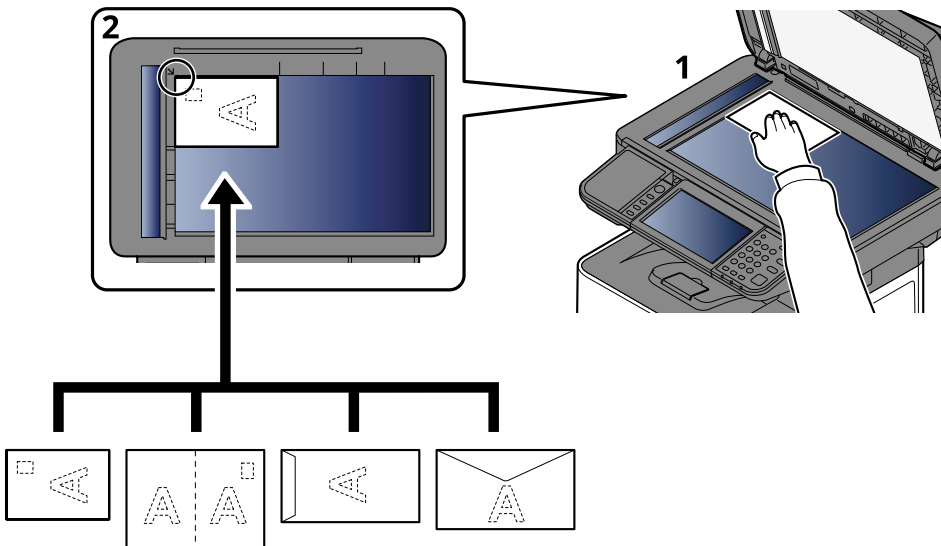

## 2 Align it flush against the original size indicator plates with the back left corner as the reference point.

### NOTE

For the procedure for feeding envelopes or cardstock, refer to the following:

➔ [When you load envelopes or cardstock in the multi purpose tray \(page 3-14\)](#)

### CAUTION

Do not leave the document processor open as there is a danger of personal injury.

### IMPORTANT

- Do not push the document processor forcefully when you close it. Excessive pressure may crack the platen glass.
- When placing books or magazines on the machine, do so with the document processor in the open position.

## Original Specifications available in the Document Processor

The document processor automatically scans each sheet of multiple originals. Both sides of two-sided originals are scanned.

### Originals Supported by the Document Processor

The document processor supports the following types of originals.

<b>Weight</b>	50 to 120 g/m <sup>2</sup> (duplex: 50 to 120 g/m <sup>2</sup> )
<b>Sizes</b>	Maximum 216 x 355.6 mm (Long-sized 216 x 915 mm) to Minimum 105 x 148 mm
<b>No. of sheets</b>	ECOSYS MA4500ifx/ECOSYS MA4500ix: 75 sheets or less (50 to 80 g/m <sup>2</sup> ) ECOSYS MA6000ifx/ECOSYS MA5500ifx: 100 sheets or less (50 to 80 g/m <sup>2</sup> )

### Originals Not Supported by the Document Processor

Do not use the document processor for the following types of originals. Otherwise, the originals may be jammed or the document processor may become dirty.

- Originals bound with clips or staples (Remove the clips or staples and straighten curls, wrinkles or creases before loading. Failure to do so may cause the originals to jam.)
- Originals with adhesive tape or glue
- Originals with cut-out sections
- Curled original
- Originals with folds (Straighten the folds before loading. Failure to do so may cause the originals to jam.)
- Carbon paper
- Crumpled paper

### How to Load Originals

#### ✔ IMPORTANT

- **Before loading originals, be sure that there are no originals left on the original eject table. Originals left on the original eject table may cause the new originals to jam.**
- **Do not make an impact on the document processor top cover, such as aligning the originals on the top cover. It may cause an error in the document processor.**

#### 1 Adjust the original width guides.

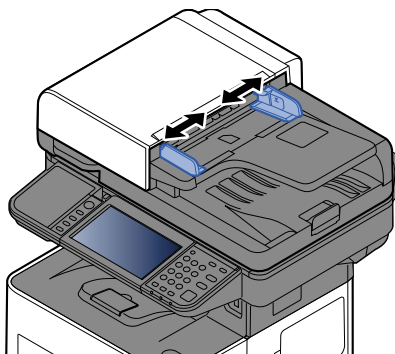

## 2 Place the originals.

- 1 Put the side to be scanned (or the first side of two-sided originals) face-up. Slide the leading edge into the document processor as far as it will go.

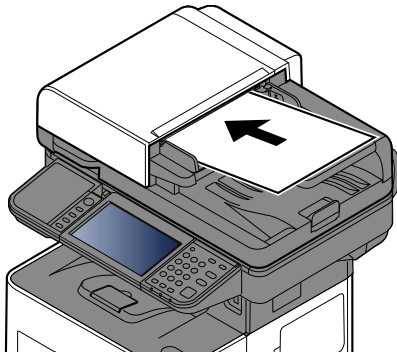

### NOTE

For details on Original Orientation, refer to the following:

➔ [Original Orientation \(page 6-18\)](#)



### IMPORTANT

**Confirm that the original width guides exactly fit the originals. If there is a gap, readjust the original width guides. The gap may cause the originals to jam.**

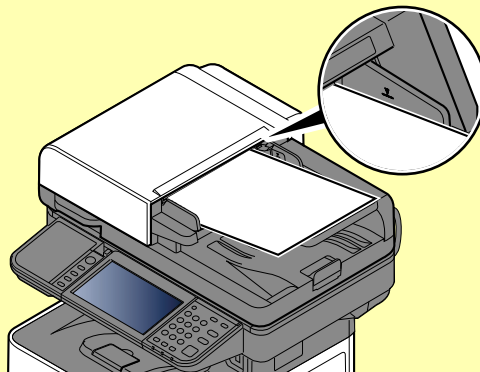

**Ensure that loaded originals do not exceed the level indicator. Exceeding the maximum level may cause the originals to jam.**

**Originals with punched holes or perforated lines should be placed in such a way that the holes or perforations will be scanned last (not first).**

- 2 Open the original stopper to fit the size of the original set.

ECOSYS MA4500ifx/ECOSYS MA4500ix:

A4, Letter, Legal

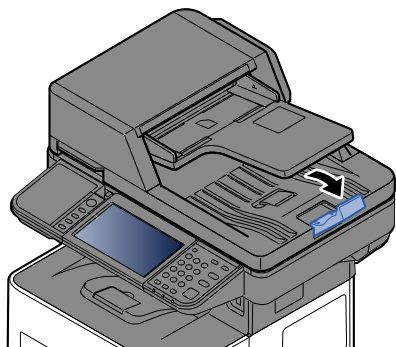

B5 or less

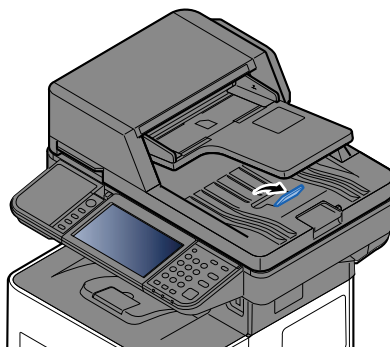

ECOSYS MA6000ifx/ECOSYS MA5500ifx:

A4, Letter, Legal

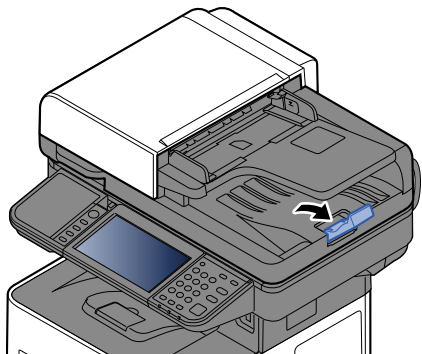

# Favorites

Frequently used functions can be registered as favorites so that they can be called up easily.

The following functions are pre-registered on this machine. You can delete these functions as well as register new functions.

Favorites Name	Description	Default Registration
<b>ID Card Copy</b>	Use this when you want to copy a driver's license or an insurance card. When you scan the front and back of the card, both sides will be combined and copied onto a single sheet.	<ul style="list-style-type: none"> <li>• Copying Functions</li> <li>• Original Size: <b>[A5]</b></li> <li>• Paper Selection: Cassette 1</li> <li>• Zoom: <b>[100%]</b></li> <li>• Erase Shadowed Areas: <b>[On]</b></li> </ul>
<b>Paper Saving Copy</b>	Use this when you want to reduce paper use. Page combining and two-sided copying can be set by following the screen.	<ul style="list-style-type: none"> <li>• Copying Functions</li> <li>• Combine: <b>[2 in 1]</b></li> <li>• Duplex: <b>[1-sided&gt;&gt;2-sided]</b></li> <li>• Paper Selection: Cassette 1</li> <li>• Copies: 1</li> </ul>
<b>Scan to PC (Address Entry)</b>	Use this when you want to send the image to either a shared folder on a PC or an FTP server folder. The settings such as the destination and color selection can be set by following the screen.	<ul style="list-style-type: none"> <li>• Sending Functions</li> <li>• Destination: New PC Folder</li> <li>• Color Selection: <b>[Full Color]</b></li> <li>• File Name Entry: Default</li> <li>• File Format: <b>[PDF]</b></li> <li>• Continuous Scan: <b>[On]</b></li> <li>• Scan Resolution: <b>[300×300 dpi]</b></li> </ul>
<b>Scan to PC (Address Book)</b>	Use this when you want to send the image to either a shared folder on a PC registered in the Address Book or to an FTP server folder. The settings such as the destination and color selection can be set by following the screen.	<ul style="list-style-type: none"> <li>• Sending Functions</li> <li>• Destination: Address Book</li> <li>• Color Selection: <b>[Full Color]</b></li> <li>• File Name Entry: Default</li> <li>• File Format: <b>[PDF]</b></li> <li>• Continuous Scan: <b>[On]</b></li> <li>• Scan Resolution: <b>[300×300 dpi]</b></li> </ul>
<b>Scan to E-mail (Address Entry)</b>	Use this when you want to send the image to an E-mail address. The settings such as the destination and color selection can be set by following the screen.	<ul style="list-style-type: none"> <li>• Sending Functions</li> <li>• Destination: New E-mail Address</li> <li>• Color Selection: <b>[Full Color]</b></li> <li>• File Name Entry: Default</li> <li>• File Format: <b>[PDF]</b></li> <li>• Continuous Scan: <b>[On]</b></li> <li>• Scan Resolution: <b>[300×300 dpi]</b></li> <li>• E-mail subject: Default</li> <li>• E-mail body: Default</li> </ul>
<b>Scan to E-mail (Address Book)</b>	Use this when you want to send the image to an E-mail address registered in the Address Book. The settings such as the destination and color selection can be set by following the screen.	<ul style="list-style-type: none"> <li>• Sending Functions</li> <li>• Destination: Address Book</li> <li>• Color Selection: <b>[Full Color]</b></li> <li>• File Name Entry: Default</li> <li>• File Format: <b>[PDF]</b></li> <li>• Continuous Scan: <b>[On]</b></li> <li>• Scan Resolution: <b>[300×300 dpi]</b></li> <li>• E-mail subject: Default</li> <li>• E-mail body: Default</li> </ul>



## NOTE

Up to 20 settings can be registered as favorites.

## Registering Favorites

The following procedure is an example of registering the copying function.

### 1 Display the screen.

- 1 [Home] key > [Copy]
- 2 Select [Favorites] while the copy mode is accessed.

### 2 Register the favorite.

- 1 [Add/Edit] > Select a number (01 to 50) for the favorite number



#### NOTE

If you register on a favorite number already registered, delete the currently registered favorite before registering.

- 2 Enter the new favorite name > [Register]  
The favorite is registered.  
To display a registered favorite on the Home screen, select [Add] on the confirmation screen that appears.
- 3 Select [OK].

## Recalling Favorites

### 1 Recall the favorite.

- 1 [Home] key > [...] > [Favorites] or select the icon of a favorite.  
If you selected the icon of a favorite, that favorite will be recalled. If you selected [Favorites], proceed to step 1-2.
- 2 Select the favorite number you want to recall.  
Select [Search] to enter the favorite number (01 to 50) directly for recalling.



#### NOTE

If the favorite cannot be recalled, the Document Box or the form overlay specified in the favorite might have been deleted. Check the Document Box.

### 2 Execute the favorite.

Place the originals > [Start] key



#### NOTE

[Favorites] can be selected in each function to call up the favorite registered for the function.



## Editing Favorites

You can change favorite number and favorite name.

### 1 Display the screen.

- 1 [Home] key > [...] > [Favorites]
- 2 Select [Add/Edit].

### 2 Edit the favorite.

- 1 Select corresponding to the favorite number (01 to 50) to change.
- 2 Select [Edit] to change the favorite number and favorite name.
  - ▶ [Registering Favorites \(page 5-8\)](#)
- 3 [OK] > [OK]

## Deleting Favorites

### 1 Display the screen.

- 1 [Home] key > [...] > [Favorites]
- 2 Select [Add/Edit].

### 2 Delete the favorite.

- 1 Select corresponding to the favorite number (01 to 50) to delete.
- 2 [Delete] > [Delete]

# Application

The functionality of the machine can be expanded by installing applications.

Applications that help you perform your daily more efficiently such as a scan feature and an authentication feature are available.

For details, consult your sales representative or dealer.

## Installing Applications

To use applications, first install the application in the machine and then activate the application.

### NOTE

You can install applications and certificates on the machine. The number of applications you can run may vary according to the type of application.

## 1 Display the screen.

[Home] key > [...] > [System Menu] > [Add/Delete Application] > "Application" [Add/Delete Application]

### NOTE

If the User Authentication screen appears, log in with a user who has the privilege to configure this setting. If you do not know your login User Name or Password, please contact your Administrator.

## 2 Install the application.

1 [Add] > [OK]

2 Insert the USB drive containing the application to be installed into the USB Memory Slot.

### NOTE

When the message "USB Drive is recognized. Displaying files." is displayed, select [Cancel].

3 Select the application to be installed > [Install]

You can view detailed information on the selected application by selecting [] (information icon).

4 Select [Yes].

Installation of the application begins. Depending on the application being installed, the installation may take some time.

Once the installation ends, the original screen reappears.

### NOTE

- To install another application, repeat steps 2-3 and 2-4.
- To remove the USB drive, select [Remove USB] and wait until the message "USB Drive can be safely removed." appears. Then remove the USB drive.

# Activating Applications

## 1 Display the screen.

[Home] key > [...] > [System Menu] > [Add/Delete Application] > "Application" [Add/Delete Application]

### NOTE

If the User Authentication screen appears, log in with a user who has the privilege to configure this setting.  
If you do not know your login User Name or Password, please contact your Administrator.

## 2 Activate the application.

### 1 Select the desired application > [Activate]

You can view detailed information on the selected application by selecting [] (information icon).

### 2 Enter the license key > [Official]

Some applications do not require you to enter a license key. If the license key entry screen does not appear, go to step 2-3. To use the application as a trial, select [Trial] without entering the license key.

### 3 Select [Yes].

### IMPORTANT

- If you change the date/time while using the trial version of an application, you will no longer be able to use the application.
- Icons of activated application are displayed in the Home screen.

### 4 Select the application icon in the Home screen.

Select the application icon.

The application will start up.

## Deactivating Applications

### 1 Display the screen.

[Home] key > [...] > [System Menu] > [Add/Delete Application] > "Application" [Add/Delete Application]

#### NOTE

If the User Authentication screen appears, log in with a user who has the privilege to configure this setting.  
If you do not know your login User Name or Password, please contact your Administrator.

### 2 Deactivate the application.

Select the desired application to exit > [Deactivate]

#### NOTE

- Select [x] on the screen if you want to exit the already activated application.
- The procedure for exiting some applications may differ.

## Uninstalling Applications

### 1 Display the screen.

[Home] key > [...] > [System Menu] > [Add/Delete Application] > "Application" [Add/Delete Application]

#### NOTE

If the User Authentication screen appears, log in with a user who has the privilege to configure this setting.  
If you do not know your login User Name or Password, please contact your Administrator.

### 2 Deactivate the application.

1 Select the application you want to delete > [Delete]

You can view detailed information on the selected application by selecting [>] (information icon).

2 Select [Yes].

# Registering Shortcuts

You can register shortcuts for easy access to the frequently used functions. The settings for the selected function can also be registered. A function name linked to a registered shortcut can be changed as necessary.

## Adding Shortcuts

Shortcut registration is performed in the basic screen of each function.

### 1 Display the basic screen you want to register.

### 2 Register the shortcuts.

#### 1 Select **[Shortcut]**.

Display the shortcut menu.

#### 2 Select **[Add]**.

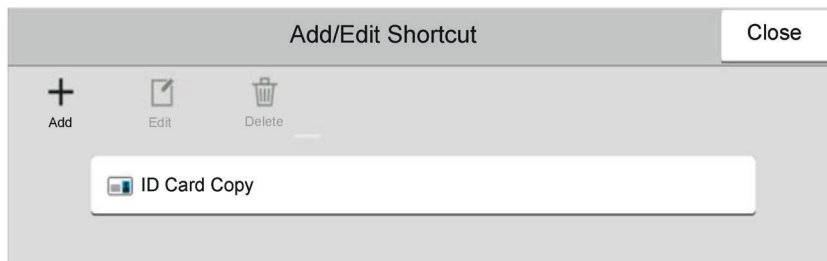

#### 3 Select the settings you want to add > **[Next >]**

#### 4 Enter the shortcut name > **[Next >]**.

#### **NOTE**

The function name will be displayed if you do not enter a shortcut key.

#### 5 Confirm the entry.

Select **[Shortcut Name]**, **[Function]**, or **[Permission]** to change the settings.

#### **NOTE**

[Permission] is displayed when the user login administration is enabled.

#### 6 Select **[Finish]**.

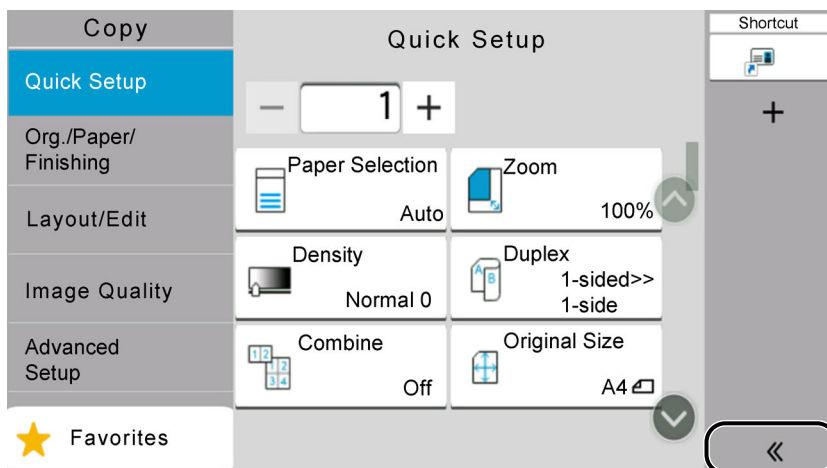

The shortcut is registered.

## Editing Shortcuts

### 1 Display the screen.

1 Select **[Shortcut]**.  
Display the shortcut menu.

2 Select  (edit icon).

### 2 Edit the shortcut.

1 Select the shortcut key you want to edit.

2 Select **[Edit]**.

3 Select **[Shortcut Name]** or **[Function]** > Change the settings > **[OK]**.

4 **[Finish]** > **[Update]**

## Deleting Shortcuts

### 1 Display the screen.

1 Select **[Shortcut]**.  
Display the shortcut menu.

2 Select  (edit icon).

### 2 Delete the shortcut.

Select the shortcut key you want to delete > **[Delete]** > **[Delete]**

# Copying

The procedures here represent the basic copy operation and how to cancel the copy.

## Basic Operation

**1** [Home] key > [Copy]

**2** Place the originals.

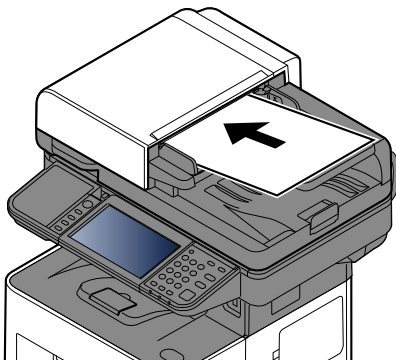

➔ [Loading Originals \(page 5-2\)](#)

**3** Select the functions.

To configure the settings for functions, select the Global Navigation.

➔ [Copy \(page 6-2\)](#)

**4** Use the numeric keys to enter the copy quantity.

Select the area for inputting the number of sheets to display the numeric keypad. Or, use [+] or [-] to enter the number of sheets. Specify the desired number up to 999.

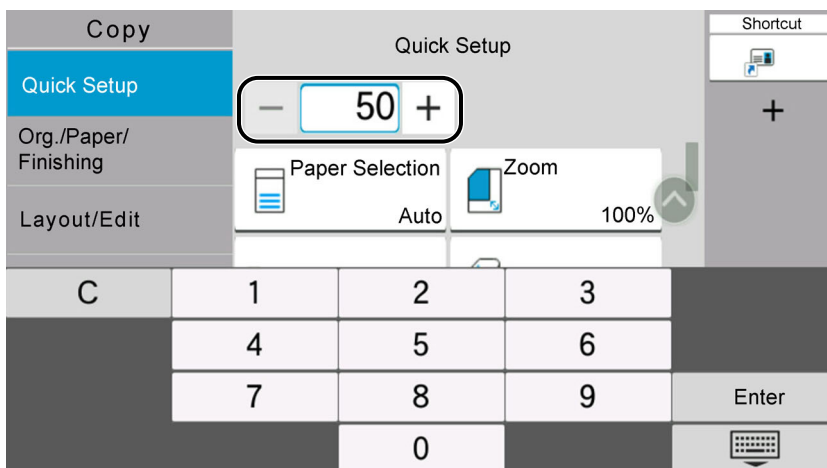

**5** Press the [Start] key.

Copying begins.

**NOTE**

This function allows you to reserve the next job during printing. Using this function, the original will be scanned while the machine is printing. When the current print job ends, the reserved copy job is printed. If "Reserve Next Priority" is set to **[Off]**, **[Reserve Next]** will appear. Select **[Reserve Next]** and configure the necessary settings for the copy job.

➔ [Reserve Next Priority \(page 8-26\)](#)

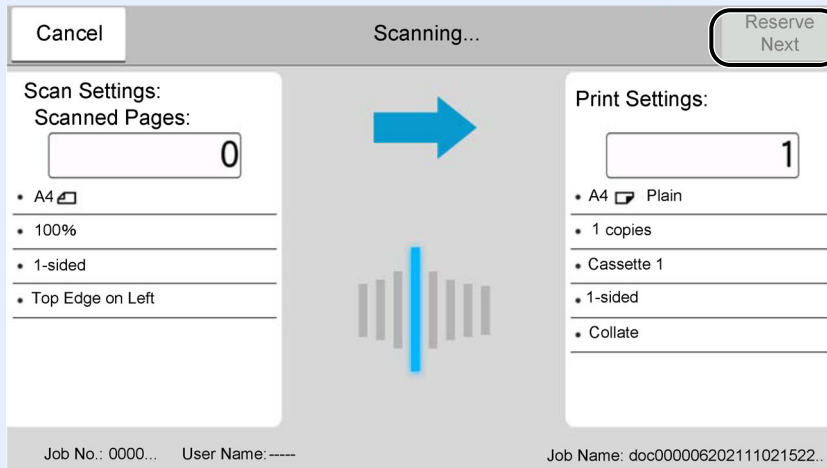

## Canceling Jobs

**1** Select the **[Stop]** key with the copy screen displayed.

**2** Cancel a job.

### When there is a job is being scanned

The copy job is canceled.

### When there is a job printing or on standby

Canceling job screen appears. The current print job is temporarily interrupted.

Select the job you wish to cancel > **[Cancel]** > **[Yes]**

**NOTE**

If "Reserve Next Priority" is set to **[Off]**, the Copying screen appears in the touch panel. In such case, selecting the **[Stop]** key or **[Cancel]** will cancel the printing job in progress.

➔ [Reserve Next Priority \(page 8-26\)](#)



## Basic Scanning (Sending)

This machine can send a scanned image as an attachment of an E-mail message or to a PC linked to the network. In order to do this, it is necessary to register the sender and destination (recipient) address on the network.

A network environment which enables the machine to connect to a mail server is required in order to send E-mail. It is recommended that a Local Area Network (LAN) be used to assist with transmission speed and security issues.

Follow the steps below for basic sending. The following four options are available.

- Send as E-mail (E-mail Addr Entry): Sends a scanned original image as an E-mail attachment.

➔ [Sending Document via E-mail \(page 5-18\)](#)

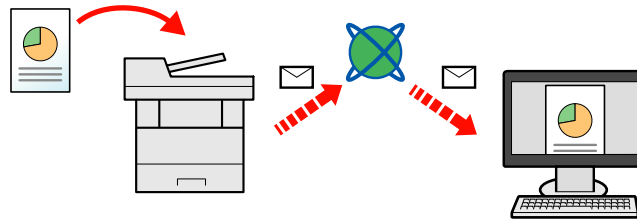

- Send to Folder (SMB): Stores a scanned original image in a shared folder of any PC.

➔ [Sending Document to Desired Shared Folder on a Computer \(Scan to PC\) \(page 5-20\)](#)

- Send to Folder (FTP): Stores a scanned original image in a folder of an FTP server.

➔ [Sending Document to Folder on an FTP Server \(Scan to FTP\) \(page 5-23\)](#)

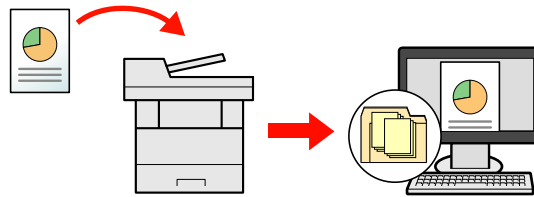

- Image Data Scanning with TWAIN / WIA: Scan the document using a TWAIN or WIA compatible application program.

➔ [Scanning using TWAIN or WIA \(page 5-25\)](#)

### NOTE

- Different sending options can be specified in combination.

➔ [Sending to Different Types of Destinations \(Multi Sending\) \(page 5-31\)](#)

- The fax function can be used on products equipped with fax capability.

➔ **FAX Operation Guide**

# Sending Document via E-mail

## NOTE

- When transmitting using wireless LAN, select the interface dedicated to the send function in advance.  
➔ [Primary Network \(Client\) \(page 8-55\)](#)
- Before sending a scanned document by e-mail, it is necessary to configure SMTP and e-mail sending from Command Center RX.  
➔ [E-mail Settings \(page 2-75\)](#)

**1** [Home] key > [Send]

**2** Place the originals.

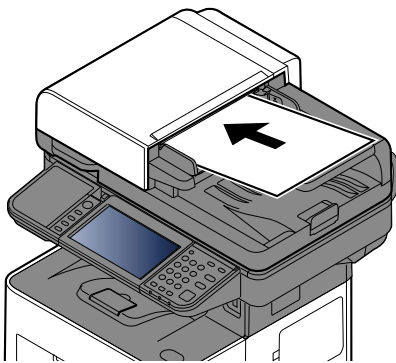

➔ [Loading Originals \(page 5-2\)](#)

**3** In the destination screen for sending, select [+] > [Email]

**4** Enter destination E-mail address > [OK]

Up to 256 characters can be entered.

➔ [Character Entry Method \(page 11-10\)](#)

To enter multiple destinations, select **[Next Destination]** and enter the next destination. Up to 100 E-mail addresses can be specified.

You can register the entered E-mail address in the Address Book by selecting **[Add to Address Book]**. You can also replace the information for a previously registered destination.

Destinations can be changed later.

➔ [Confirmation Screen of Destinations \(page 5-40\)](#)

## NOTE

If **[Prohibit]** is set to "Broadcast", multiple destinations cannot be entered.

➔ [Broadcast \(page 8-29\)](#)

## 5 Configure the functions.

Select the Global Navigation to display other functions.

➔ [Send \(page 6-4\)](#)

### IMPORTANT

- [Email Encrypted TX] and [Digital Signature to Email] appear when setting S/MIME on the Command Center RX.
  - ➔ [Command Center RX User Guide](#)
- When using [Email Encrypted TX] and [Digital Signature to Email], specify the E-mail addresses which have encryption certificate, from the address book. The directly-entered address can not be configured these functions. When entering E-mail address from the operation panel, you can not use these functions.

## 6 Press the [Start] key.

Sending starts.

# Sending Document to Desired Shared Folder on a Computer (Scan to PC)

You can store the scanned document into the desired shared folder on a computer.

 **NOTE**

- When transmitting using wireless LAN, select the interface dedicated to the send function in advance.
  - ➔ [Primary Network \(Client\) \(page 8-55\)](#)
- Before sending the scanned document to the shared folder on your computer, you must configure the following settings:
  - Make a note of the computer name and full computer name
    - ➔ [Making a note of the computer name and full computer name \(page 3-17\)](#)
  - Make a note of the user name and domain name
    - ➔ [Making a note of the user name and domain name \(page 3-18\)](#)
  - Create a shared folder and make a note of a shared folder
    - ➔ [Creating a Shared Folder, Making a Note of a Shared Folder \(page 3-19\)](#)
  - Configure the Windows firewall
    - ➔ [Configuring Windows Firewall \(page 3-23\)](#)

**1** [Home] key > [Send]

**2** Place the originals.

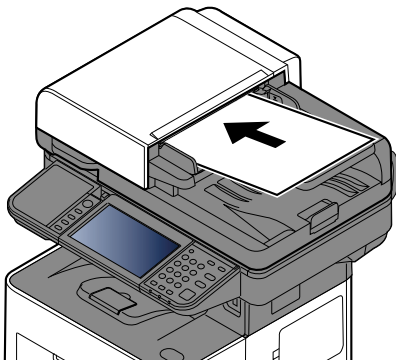

➔ [Loading Originals \(page 5-2\)](#)

**3** In the destination screen for sending, select [+] > [SMB]

**4** Enter the destination information.

To directly specify the SMB folder, select **[Folder Path Entry]** and enter each item.

The table below lists the items to be set.

Item	Description	Max. characters
Host Name* <sup>1</sup>	Computer name	Up to 256 characters
Port	Port number If the port number is not specified, the default port number is 445.	—

Item	Description	Max. characters
<b>Folder Path</b>	Share name For example: scannerdata If saving in a folder in the shared folder: share name\folder name in shared folder	Up to 260 characters
<b>Login User Name</b> <sup>*2</sup>	<ul style="list-style-type: none"> <li>If the computer name and domain name are the same: User Name For example: james.smith</li> <li>If the computer name and domain name are different:</li> </ul>	Up to 64 characters
<b>Login Password</b>	Windows logon password <b>(Case sensitive.)</b>	Up to 128 characters

\*1 Enter the Host name or IP address.

To enter the IPv6 address, enclose the address in brackets [ ].

(Example: [2001:db8:a0b:12f0::10])

\*2 Domain name\User name

For example: abcdnet\james.smith

When sending a document through an optional network interface (IB-37/IB-38/IB-51), "\" cannot be used. If the computer name is different from the domain name, login user name needs to be input by using "@."

(Example: james.smith@abcdnet)



#### NOTE

- If you selected [**Search Folder from Network**], you can search all PCs on the network for a destination.
- If you selected [**Search Folder by Host Name**], you can enter the "Domain/Workgroup", and "Host Name" to search PCs on the network for the destination.
- A maximum of 500 addresses can be displayed. Select the host name (PC name) that you want to specify in the screen that appears, and select [**OK**]. The login user name and login password entry screen appears.
- After you enter the login user name and login password name of the destination PC, the shared folders appear. Select the folder that you want to specify and select [**OK**]. The address of the selected shared folder is set.

## 5 Check the status.

1 Check the information.

Change the delay as required.

2 Select [**Connection Test**] to check the connection.

"Connected." appears when connection to the destination is correctly established. If "Cannot connect." appears, review the entry.

To enter multiple destinations, select [**Next Destination**] and enter the next destination.

You can register the entered information in the Address Book by selecting [**Add to Address Book**].



#### NOTE

If [**Prohibit**] is set to "Broadcast", multiple destinations cannot be entered.

➔ [Broadcast \(page 8-29\)](#)

## 6 Select [OK].

Destinations can be changed later.

➔ [Confirmation Screen of Destinations \(page 5-40\)](#)

## **7** Configure the functions.

Select the Global Navigation to display other functions.

➔ [Send \(page 6-4\)](#)

## **8** Press the [Start] key.

Sending starts.

# Sending Document to Folder on an FTP Server (Scan to FTP)

 **NOTE**

- When transmitting using wireless LAN, select the interface dedicated to the send function in advance.
- ➔ [Primary Network \(Client\) \(page 8-55\)](#)
- Before sending a document, configure the FTP Client (Transmission).
- ➔ [Making a note of the computer name and full computer name \(page 3-17\)](#)

**1 [Home] key > [Send]**

**2 Place the originals.**

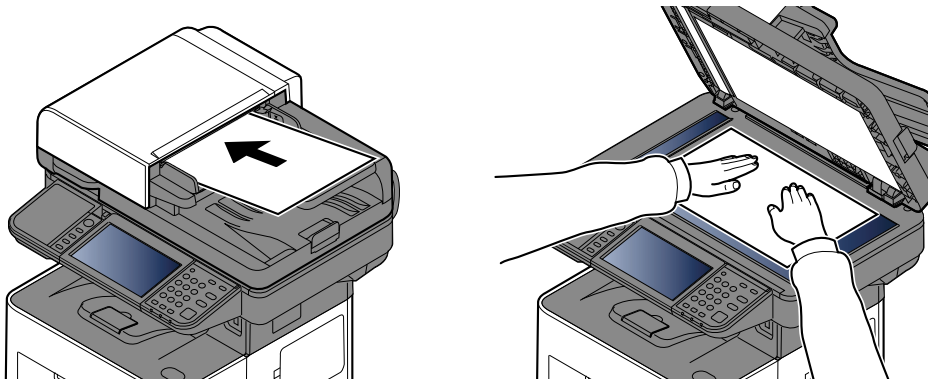

➔ [Loading Originals \(page 5-2\)](#)

**3 In the destination screen for sending, select [+] > [FTP]**

**4 Enter the destination information.**

➔ [Character Entry Method \(page 11-10\)](#)

The table below lists the items to be set.

Item	Descriptions	Max. characters
<b>Host Name<sup>*1</sup></b>	Host name or IP address of FTP server	Up to 64 characters
<b>Port</b>	Port number If the port number is not specified, the default port number is 21.	—
<b>Folder Path<sup>*2</sup></b>	Path for the file to be stored For example: User\ScanData If no path is entered, the file is stored in the home directory.	Up to 128 characters
<b>Login User Name</b>	FTP server login user name	Up to 64 characters
<b>Login Password</b>	FTP server login password	Up to 64 characters

\*1 To enter the IPv6 address, enclose the address in brackets [ ].  
(Example: [2001:db8:a0b:12f0::10])

\*2 When the FTP server is based on Linux/UNIX, the path including the sub-folder is combined by the slash "/" not using the back-slash.

## 5 Check the information

- 1 Check the information.

Change the delay as required.

- 2 Select [**Connection Test**] to check the connection.

"Connected." appears when connection to the destination is correctly established. If "Cannot connect." appears, review the entry.

To enter multiple destinations, select [**Next Destination**] and enter the next destination.

You can register the entered information in the Address Book by selecting [**Add to Address Book**].



### NOTE

If [**Prohibit**] is set to "Broadcast", multiple destinations cannot be entered.

➔ [Broadcast \(page 8-29\)](#)

## 6 Select [OK].

Destinations can be changed later.

➔ [Confirmation Screen of Destinations \(page 5-40\)](#)

## 7 Configure the functions.

Select the Global Navigation to display other functions.

➔ [Send \(page 6-4\)](#)

## 8 Press the [Start] key.

Sending starts.



# Scanning using TWAIN or WIA

This subsection explains how to scan an original using TWAIN. The WIA driver is used in the same way.

## NOTE

- When transmitting using wireless LAN, select the interface dedicated to the send function in advance.
  - ➔ [Primary Network \(Client\) \(page 8-55\)](#)
- Before sending a document, confirm that TWAIN/WIA driver is installed on a computer and the settings are configured.
  - ➔ [Setting TWAIN Driver \(page 2-64\)](#)
  - ➔ [Setting WIA Driver \(page 2-66\)](#)

## 1 Display the screen.

- 1 Activate the TWAIN compatible application software.
- 2 Select the machine using the application and display the dialog box.

## NOTE

For selecting the machine, see the Operation Guide or Help for each application software.

## 2 Configure the scan settings.

Select scanning settings in the dialog box that opens.

## NOTE

For the settings, refer to Help in the dialog box.

## 3 Place the originals.

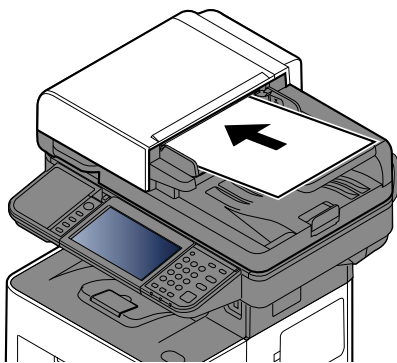

➔ [Loading Originals \(page 5-2\)](#)

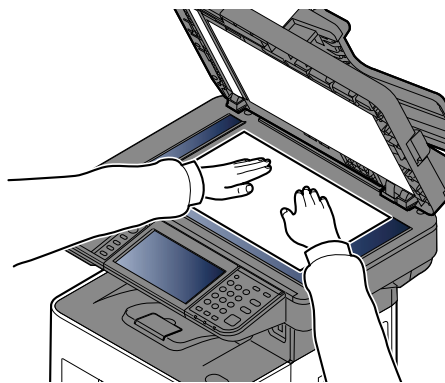

## 4 Scan the originals.

Click the [**Scan**] button. The document data is scanned.

# Scanning Document stored in a Custom Box

Follow the steps as below for scanning a document stored in a custom box using the TWAIN driver. When transmitting using wireless LAN, select the interface dedicated to the send function in advance.

## NOTE

- When transmitting using wireless LAN, select the interface dedicated to the send function in advance.
- ➔ [Primary Network \(Client\) \(page 8-55\)](#)
- Before sending a document, confirm that TWAIN/WIA driver is installed on a computer and the settings are configured.
- ➔ [Setting TWAIN Driver \(page 2-64\)](#)
- To load a document saved in the Custom Box, select the model name with (Box) from "Model" on the TWAIN driver configuration screen.

## 1 Display the screen.

- 1 Activate the TWAIN compatible application software.
- 2 Select the machine using the application and display the dialog box.

### NOTE

For selecting the machine, see the Operation Guide or Help for each application software.

## 2 Display lists of documents.

- 1 Select a custom box stored a document.  
If a password has been set for the box, the password entry screen appears. Enter the password and click the **[OK]** button. When you select a box, the document files in the Custom Box appear in "Document List".
- 2 Set how to display the document data. Click the **[Setting]** button to select each item.

### NOTE

For the settings, refer to Help in the dialog box.

- 3 Click **[OK]** button.

## 3 Scan the originals.

- 1 Select the document data to be scanned from "Document List".  
Enter the document data name in the "Search (Name)" to find the data having the same document data name or the document data name with the same beginning.  
Click the **[Detail]** button to display the selected document data. When the document data includes multiple pages, select the checkbox beside the pages you want to scan. The selected pages will be scanned.

### NOTE

In this case, the scanned page or the selected document data will not be deleted from the Custom Box.

- 2 Click the **[Acquire]** button.  
The document data is scanned.

## Useful Sending Method

You can specify the following useful scanning (sending) methods.

- WSD Scan: Saves images of originals scanned on this machine as files on a WSD-compatible computer.  
➔ [WSD Scan \(page 5-28\)](#)
- Scanning with File Management Utility: Scans a document using the settings of File Management Utility and saves it to a specified network folder or PC.  
➔ [Scanning with File Management Utility \(page 5-30\)](#)
- Scanning using the fax server: A scanned original is send via a fax server.  
➔ [Using a Fax Server to Send \(Fax Server Send\) \(page 5-33\)](#)
- Sending to different types of destinations (Multi sending): Sends to different types of destination (E-mail addresses, folders, etc.) in a single operation.  
➔ [Sending to Different Types of Destinations \(Multi Sending\) \(page 5-31\)](#)
- Send to Me (Email): Sends to the E-mail address of the logged in user when user login is enabled.  
➔ [Sending Documents to E-mail Address of Logged in User \(to myself\) \(page 5-32\)](#)

## WSD Scan

WSD Scan saves images of originals scanned on this machine as files on a WSD-compatible computer.

 **NOTE**

- To use WSD Scan, confirm that the computer used for WSD scanning and the machine is network-connected, and "WSD Scan" is set to **[On]** in the network settings.

➔ [WSD Scan \(page 8-32\)](#)

- For information on operating the computer, refer to the computer's help or the operation guide of your software.
- When transmitting using wireless LAN, select the interface dedicated to the send function in advance.

➔ [Primary Network \(Client\) \(page 8-55\)](#)

### Install the Driver (for Windows 10)

- 1 Right-click [Start] button on the Windows and select [Control Panel] and then [View devices and printer].**
- 2 Install the driver.**

Click **[Add a device]**. Select the machine's icon and then click **[Next]**.

When the machine's icon is displayed in "**Printers**" on the **[Devices and Printers]** screen, the installation is completed.

### Install the Driver (for Windows 8.1, Microsoft Windows Server 2012)

- 1 Click [Search] in charms, [Control Panel], and then [View devices and printers].**
- 2 Install the driver.**

Click **[Add a device]**. Select the machine's icon and then click **[Next]**.

When the machine's icon is displayed in "**Printers**" on the **[Devices and Printers]** screen, the installation is completed.

## Executing WSD scan

WSD Scan saves images of originals scanned on this machine as files on a WSD-compatible computer.

### NOTE

- When transmitting using wireless LAN, select the interface dedicated to the send function in advance.
  - ➔ [Primary Network \(Client\) \(page 8-55\)](#)
- To use WSD Scan, confirm that the computer used for WSD scanning and the machine is network-connected, and "WSD Scan" is set to [On] in the network settings.
  - ➔ [WSD Scan \(page 8-32\)](#)
- For information on operating the computer, refer to the computer's help or the operation guide of your software.

### 1 [Home] key > [Send]

### 2 Place the originals.

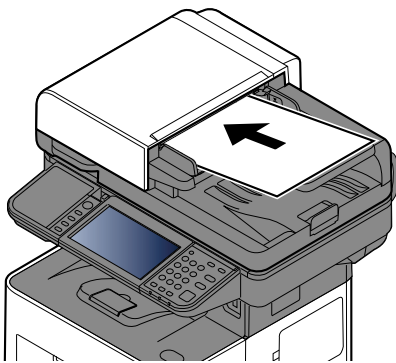

➔ [Loading Originals \(page 5-2\)](#)



### 3 Display the screen.

In the destination screen for sending, select [+] > **[WSD Scan]**

### 4 Scan the originals.

#### Procedure using this machine

- 1 **[From Operation Panel] > [Next]**
- 2 Select the destination computer > **[OK]**  
 Select **[Reload]** to reload the computer list.  
 You can view information on the selected computer by selecting [] (information icon).
- 3 Set the type of original, file format, etc., as desired.
- 4 Press the **[Start]** key.  
 Sending begins and the software installed on the computer is activated.

#### Procedure from Your Computer

- 1 **[From Computer] > [Start]**
- 2 Use the software installed on the computer to send the images.

# Scanning with File Management Utility

"FMU Connection" is installed on the machine as a standard application.

FMU Connection can be used to scan an original according to the settings configured with "File Management Utility" downloaded from our website, and save the image data and scanning information on a specified server or in a specified folder. Unlike regular transmission functions, this application lets you use metadata such as the scan date and time and the data format.

## 1 Configure the settings.

The first time you use FMU Connection, you must enable it in System Menu.

➔ [Activating Applications \(page 5-11\)](#)

To use this function, you must install File Management Utility on your computer and configure settings for the multifunction machine to be used, scanning conditions, and the file save location. To install File Management Utility, refer to the following.

➔ [Installing Software \(page 2-52\)](#)



### NOTE

For information on using File Management Utility, refer to the following:

➔ [File Management Utility User Guide](#)

## 2 Make sure that File Management Utility is running on the computer (or server) on which File Management Utility is installed.

## 3 Place the original.

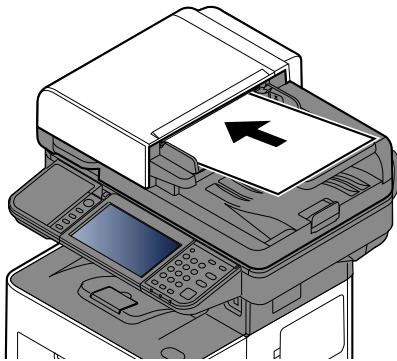

➔ [Loading Originals \(page 5-2\)](#)

## 4 Select [FMU Connection].

FMU Connection starts.

## 5 Follow the on-screen instructions to enter the necessary information and select [Next].

## 6 When the scan settings screen appears, select each item and configure the necessary settings.

The features that can be set depend on File Management Utility.

## 7 Press the [Start] key.

Sending starts.

## Sending to Different Types of Destinations (Multi Sending)

You can specify destinations that combine E-mail addresses, folders (SMB or FTP) and fax numbers (Fax functionality can only be used on products equipped with fax capability.). This is referred to as Multi Sending. This is useful for sending to different types of destination (E-mail addresses, folders, etc.) in a single operation.

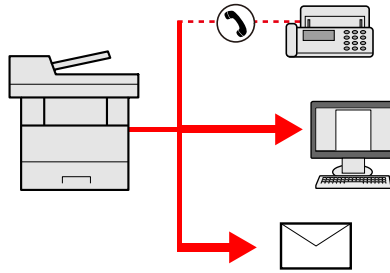

No. of broadcast items: Up to 50

However, number of items are restricted for the following sending options.

- E-mail and FAX: Up to 100 in total
- Folders (SMB, FTP): Total of 5 SMB and FTP

Also, depending on the settings, you can send and print at the same time.

Procedures are the same as used in specifying the destinations of respective types. Continue to enter E-mail address or folder path so that they appear in the destination list. Press the **[Start]** key to start transmission to all destinations at one time.

### NOTE

- If the destinations include a fax, the images sent to all destinations will be black and white.
- If **[Prohibit]** is set to "Broadcast", multiple destinations cannot be specified.

➔ [Broadcast \(page 8-29\)](#)

# Sending Documents to E-mail Address of Logged in User (to myself)

When user login is enabled, the document is sent to the E-mail address of the logged in user.

## 1 Configure the settings.

Before using this function, the following are necessary.

- To use this function, the function icon must be displayed in the home screen.

➔ [Editing the Home Screen \(page 2-19\)](#)

- An E-mail address must be set in user login for the user who logs in.

➔ [Adding a User \(Local User List\) \(page 9-6\)](#)

## 2 Select [Home] key.

## 3 Select [Send to Me (Email)].



### NOTE

When this function is used, functions other than transmission cannot be used.



## Using a Fax Server to Send (Fax Server Send)

You can send a scanned document via a fax server.

### NOTE

- A fax server is required to use this function. For information about the fax server, contact the applicable administrator.
- FAX server settings must be configured to send a FAX.

➔ **Command Center RX User Guide**

➔ [Fax Server \(page 8-54\)](#)

**1** [Home] key > [Send]

**2** Place the originals.

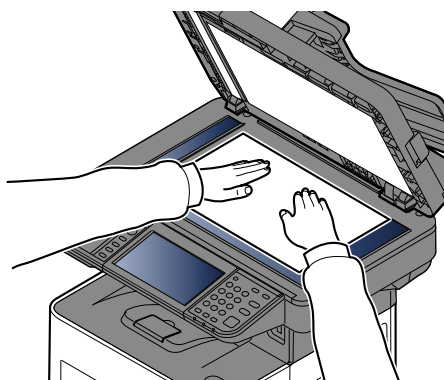
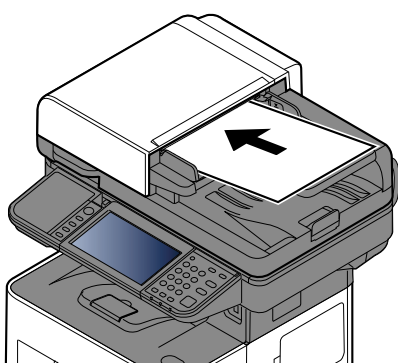

➔ [Loading Originals \(page 5-2\)](#)

**3** Display the screen.

In the destination screen for sending, select [+ ] > [Fax Server]

**4** Enter recipient information.

**Entering Information Directly**

**1** Select [Fax No. Entry].

**2** Enter the fax number > [OK]

### NOTE

Use the numeric keys to enter a number.

Destinations can be changed later.

➔ [Checking and Editing Destinations \(page 5-39\)](#)

### NOTE

- When selecting the information from the Address Book, select [Address Book], and specify the destination > [OK].

➔ [Choosing from the Address Book \(page 5-36\)](#)

- When selecting the information from an External Address Book, select [Ext Address Book], and specify the destination > [OK].

For details on the External Address Book, refer to the following:

➔ **Command Center RX User Guide**

## **5 Configure the functions.**

Select the Global Navigation to display other functions.

➔ [Send \(page 6-4\)](#)

## **6 Press the [Start] key.**

Sending starts.

## Canceling Sending Jobs

**1** Select the **[Stop]** key with the send screen displayed.

**2** **Cancel a job.**

When there is a job is being scanned, Job Cancel appears.

When there is a job sending or on standby, Canceling job screen appears. Select the job you wish to cancel

> **[Cancel]** > **[Yes]**



### **NOTE**

Selecting the **[Stop]** key will not temporarily stop a job that you have already started sending.

# Handling Destination

This section explains how to select and confirm the destination.

## Specifying Destination

Select the destination using either of the following methods except entering address directly:

- Choosing from the Address Book
  - ➔ [Choosing from the Address Book \(page 5-36\)](#)
- Choosing from the External Address Book
- For details on the External Address Book, refer to the following:
  - ➔ **Command Center RX User Guide**
- Choosing from One Touch key
  - ➔ [Choosing from the One Touch Key \(page 5-38\)](#)
- Choosing from the Search (No.)
  - ➔ [Choosing from the Search \(No.\) \(page 5-38\)](#)
- Choosing from the FAX
  - ➔ **FAX Operation Guide**

### NOTE

- You can set the machine up so that the address book screen appears when you select the **[Send]** key.
  - ➔ [Default Screen \(page 8-29\)](#)
- If you are using the products equipped with the fax function, you can specify the fax destination. Enter the other party number using the numeric keypad.

## Choosing from the Address Book

For more information about how to register destinations in the Address Book, refer to the following:

- ➔ [Registering Destinations in the Address Book \(page 3-33\)](#)

### 1 In the destination screen for sending, select **[Address Book]** (.

#### NOTE

For details on the External Address Book, refer to the following:

- ➔ **Command Center RX User Guide**

### 2 Select the destinations.

Select the checkbox to select the desired destination from the list. The selected destinations are indicated by a checkmark in the check box. To use an address book on the LDAP server, select **[Selection]** > **[Address Book]** > **[Ext Address Book]**.

You can change the order in which the destinations are listed by selecting **[Name]** or **[No.]**.

**NOTE**

- To deselect, select the checkbox again and remove the checkmark.
- If **[Prohibit]** is set to “Broadcast”, multiple destinations cannot be selected. This also applies to a group in which multiple destinations are registered.

➔ [Broadcast \(page 8-29\)](#)

Destinations registered in the Address Book can be searched. Advanced search by type or by initial letter is also available.

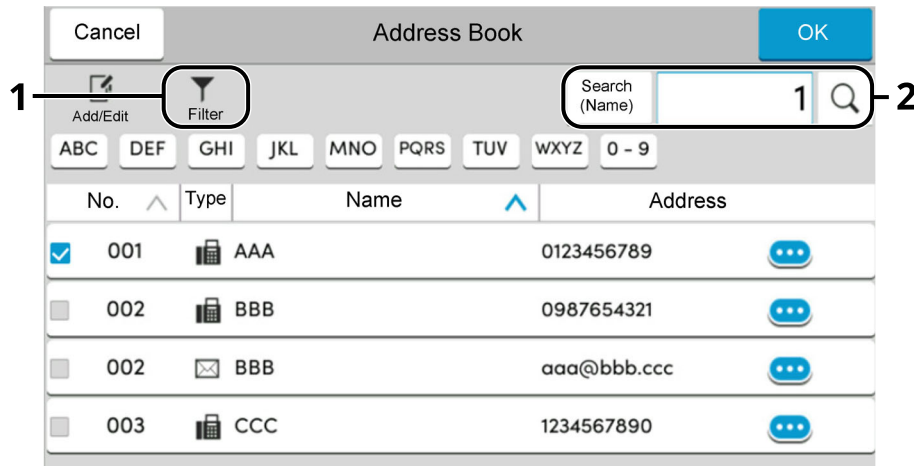

Keys used	Search type	Subjects searched
1	Filter	Advanced search by type of registered destination (Email, Folder, Fax or Group). You can set this function up so that destination types are selected when the address book is displayed. For details, refer to the following: ➔ <a href="#">Narrow Down (page 8-32)</a>
2	Search (No.)	Search by registered address number or name. Select either [ <b>Search (No.)</b> ] or [ <b>Search (Name)</b> ] to switch between [ <b>Search (No.)</b> ] and [ <b>Search (Name)</b> ].
	Search (Name)	

### 3 Accept the destination > [OK]

Destinations can be changed later.

➔ [Checking and Editing Destinations \(page 5-39\)](#)

**NOTE**

- To delete the destination, select [✓] > [🗑️] (delete icon) for the destination you want to delete > **[Delete]**
- You can set the default sort setting of the address for the address book.

➔ [Sort \(page 8-32\)](#)

## Choosing from the One Touch Key

In the destination screen for sending, select the One Touch Keys where the destination is registered.

### NOTE

If the One Touch Keys for the desired destination is hidden on the touch panel, select [▲] or [▼] to display all One Touch Keys. This procedure assumes that One Touch Keys have already been registered.

For more information on adding One Touch keys, refer to the following:

➔ [Adding a Destination on One Touch Key \(One Touch Key\) \(page 3-41\)](#)

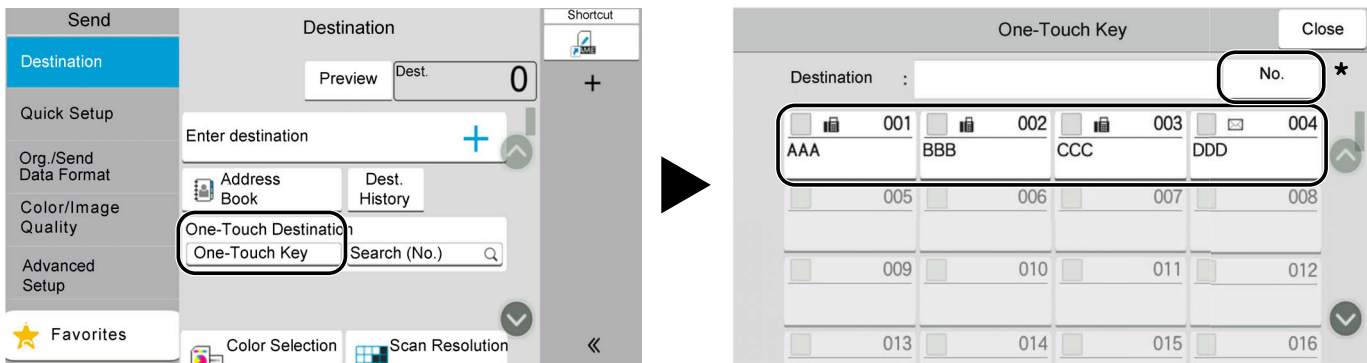

\* The **[No.]** key has the same function as **[Search (No.)]** displayed on the touch panel. Use to directly enter a number with the numeric keys, such as specifying a transmission address using a one-touch key number, or calling up a stored program using the program number. For information on one-touch key numbers, refer to the following:

## Choosing from the Search (No.)

Access the destination by specifying the 4-digit (0001 to 1000) One Touch Key number.

In the destination screen for sending, select **[Search (No.)]** to display the numeric entry screen. Select the entry field, and use the numeric keys to enter the speed dial number.

### NOTE

If you entered the One Touch Key in 1 to 3-digit, select **[OK]**.

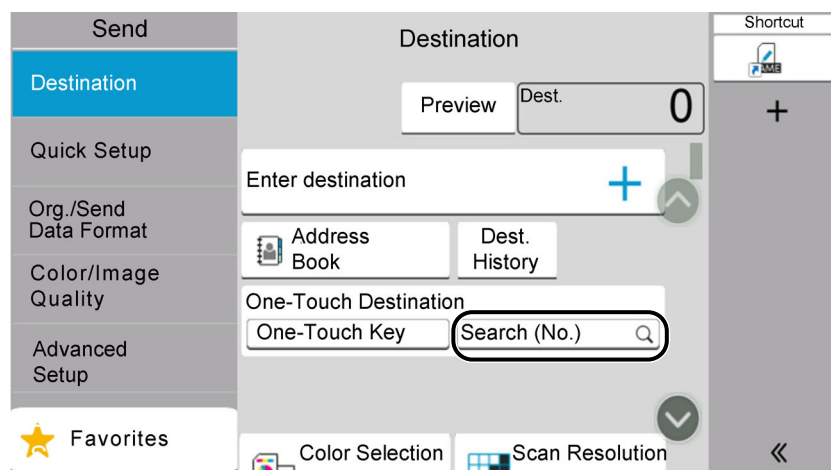

## Checking and Editing Destinations

### 1 Display the screen.

Specify the destination.

➔ [Specifying Destination \(page 5-36\)](#)

### 2 Check and edit the destination.

Select [ √ ] to display a destination list.

- Select [ ⓘ ] (information icon) to check the destination.
- Select [ 🗑 ] (delete icon) to remove the destination from the list.

#### NOTE

- When selecting [**On**] for Entry Check for New Destination, the confirmation screen appears. Enter the same destination again, and select [**OK**].
  - ➔ [Entry Check for New Dest. \(page 8-29\)](#)
- When selecting [**On**] for Destination Check before Send, the confirmation screen appears after pressing the [**Start**] key.
  - ➔ [Destination Check before Send \(page 8-29\)](#)
  - ➔ [Confirmation Screen of Destinations \(page 5-40\)](#)

## Confirmation Screen of Destinations

When selecting [**On**] for Destination Check before Send, the confirmation screen of destinations appears after pressing the [**Start**] key.

➔ [Destination Check before Send \(page 8-29\)](#)

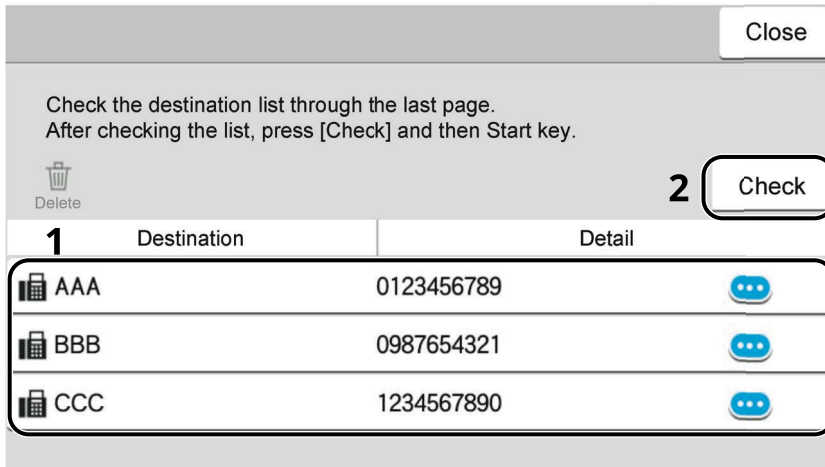

- 1 Move the screen to the bottom and confirm all destinations.

Selecting [] (information icon) shows the detailed information of the destination.

To delete the destination, select the destination you want to delete > [**Delete**] > [**Delete**]

To add the destination, select [**Close**] and then return to the destination screen.

- 2 Select [**Check**].



### NOTE

Be sure to confirm all destination by displaying them on the touch panel. You cannot select [**Check**] unless you have confirmed all destination.



## Recall

Recall is a function allowing you to send the last entered destination once again. When you want to send the image to the same destination, select **[Recall]**, and you can call the destination you sent on the destination list.

### 1 Select **[Recall]**.

The destination you sent is displayed on the destination list.



#### NOTE

When the last sending included FAX, folders and E-mail destinations, they are also displayed. If necessary, add or delete the destination.

### 2 Press the **[Start]** key.

Sending starts.



#### NOTE

- When **[On]** is selected in "Dest. Check before Send", a destination confirmation screen is displayed when you press the **[Start]** key.

➔ [Confirmation Screen of Destinations \(page 5-40\)](#)

- Recall information is canceled in the following conditions.
  - When you turn the power off
  - When you send a next image (new recall information is registered)
  - When you log out

## How to use the FAX Function

On products with a FAX function, it is possible to use the FAX function.

➔ **FAX Operation Guide**

# Using Document Boxes

Document Box is a function for saving print data from a computer and sharing it with multiple users. The following types of document boxes are available:

- Custom Box
- Job Box
- USB Drive Box
- Fax Memory RX Box
- Subaddress Box
- Polling Box

## What is Custom Box?

Custom Box is a component box which you can create within the Document Box and store data for later retrieval. You can create or delete a Custom Box.

The following operations are possible:

- Creating a new Custom Box
- Printing Document in a Custom Box
- Saving scanned documents to a Custom Box
- Sending Documents in a Custom Box
- Editing Documents in a Custom Box
- Deleting Documents in a Custom Box



### NOTE

- An optional SSD is required to use a Custom Box.  
➔ [HD-17/HD-18 "SSD" on page 11-5](#)
- The operation on Custom Box you perform from operation panel can also be made using Command Center RX.  
➔ **Command Center RX User Guide**

## What is Job Box?

Job Box is a generic name for the "Private Print/Stored Job Box", "Quick Copy/Proof and Hold Box", and "PIN Print Box". These Job Boxes cannot be created or deleted by a user.

### NOTE

- You can set up the machine so that temporary documents in job boxes are automatically deleted.
  - ➔ [Deletion of Job Retention \(page 8-36\)](#)
- For details on operating the "Private Print/Stored Job Box", "Quick Copy/Proof and Hold Box" and "PIN Print Box", refer to the following:
  - ➔ [Printing Data Saved on the Printer \(page 4-19\)](#)

## What is USB Drive Box?

A USB drive can be connected to the USB memory slot on the machine to print a saved file. You can print data directly from the USB drive without a PC. Image files scanned using this machine can also be saved to USB drive in the PDF, TIFF, JPEG, XPS, OpenXPS, high compression PDF, Word, Excel or PowerPoint format (Scan to USB).

### NOTE

Word, Excel and PowerPoint will be saved in a Microsoft Office 2007 or later file format.

## Fax Box

Fax Box store the fax data.

➔ **FAX Operation Guide**

## Basic Operation for Document Box

This section explains basic operations for document boxes, using examples where tasks are carried out with custom boxes.

### NOTE

In the following explanation, it is assumed that user login administration is enabled. For details on User Logon privileges, refer to the following:

➔ [Editing Custom Box \(page 5-51\)](#)

## Box List

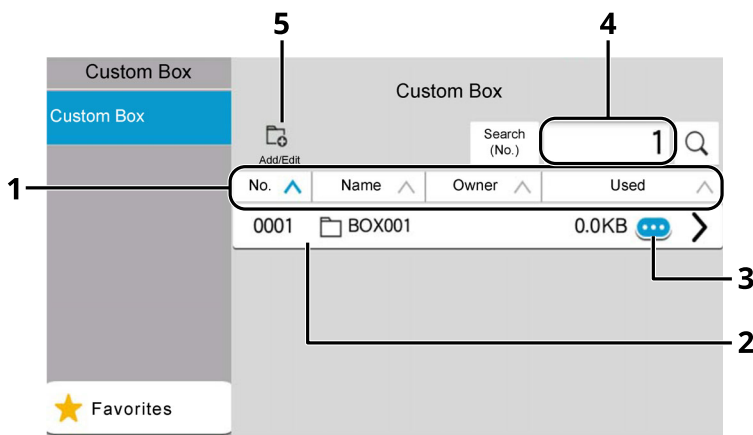

- 1 Sorts the box number, box name, owner name and size of data saved in the box in ascending/descending order.
- 2 This is a custom box. Select it to open it.
- 3 Displays the details for the selected box.
- 4 A box can be searched for by Box No. or Box Name. Select either [**Search (No.)**] or [**Search (Name)**] to switch between [**Search (No.)**] and [**Search (Name)**].
- 5 Registers new boxes and checks, modifies or deletes box information.

## Document List

The document list is a list of the documents stored in the custom box. Documents can be listed either by name or as thumbnails. The list can be used as shown below.

### List

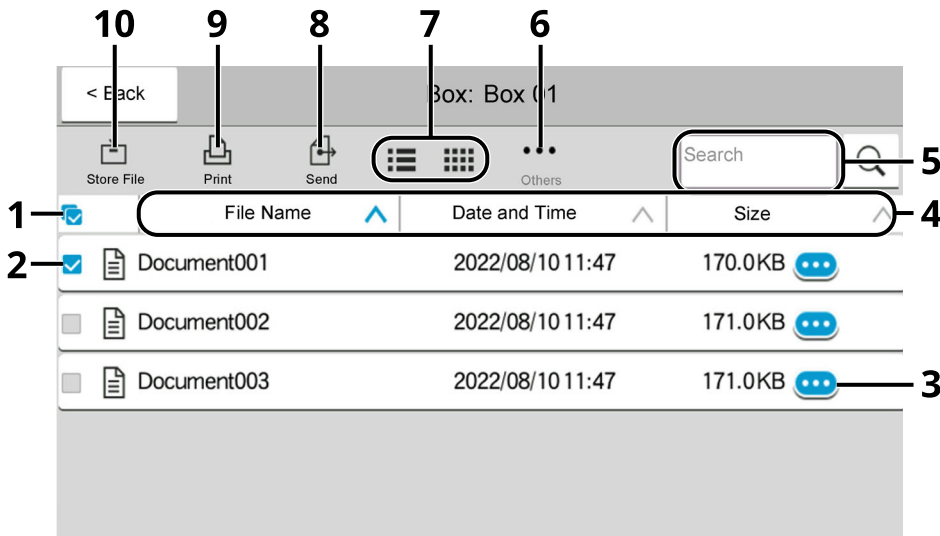

### Thumbnail

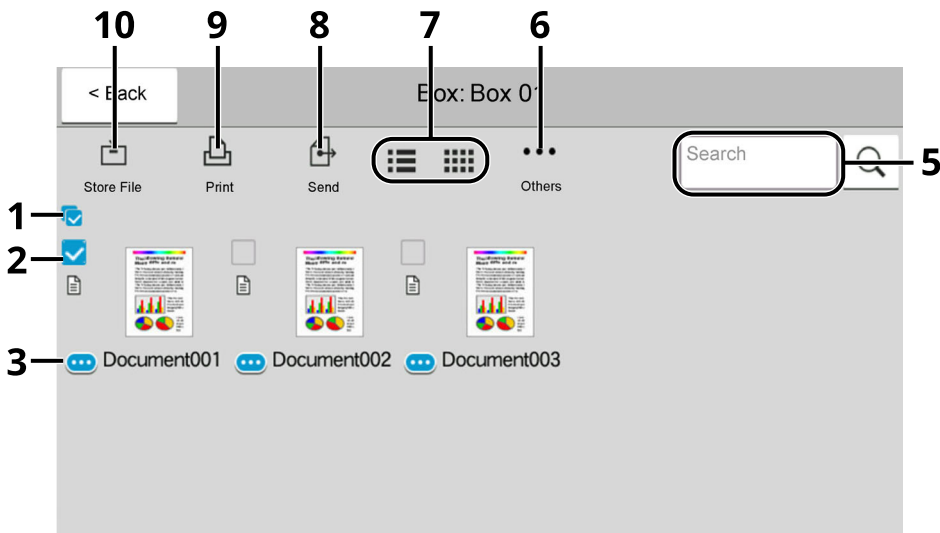

- 1 Selecting more than one document at a time.
- 2 Selecting documents by checking checkboxes.
- 3 Display the details for the selected document.
- 4 Sorts the file name, date and time and size of data in ascending/descending order.
- 5 A document can be searched for by Name.
- 6 The menu for document operations will be displayed.
- 7 Switches between list display and thumbnail display.
- 8 Sends the selected documents.
- 9 Prints the selected documents.
- 10 Saves the document in the open box.

#### NOTE

You can select multiple documents by pressing the respective document checkboxes. However, note that you cannot select multiple documents when you are sending documents.

## Viewing Box Details

- 1 Select [] (information icon) for the box whose details you wish to check in the box list screen.



### NOTE

If a custom box is protected by a password, enter the correct password.

- 2 Check the box details.

- 3 Select [Close].

The display returns to the default Document Box screen.

## Editing Box Details

- 1 Select [Add/Edit] in the box list screen.

- 2 Select the box whose details you wish to edit and select [Edit].



### NOTE

If a custom box is protected by a password, enter the correct password.

- 3 Edit the box details.

Enter new details.

- 4 If you have changed the details, select [OK] and then select [OK] in the confirmation screen.

If you do not change the details, select [Cancel].

- 5 Select [Close].

The display returns to the default Document Box screen.

## Previewing Documents/Checking Document Details

**1** Select a document to preview and then select [Others] > [Preview].

**2** Preview the document or check the document details.

The operations available in the preview screen are shown below.

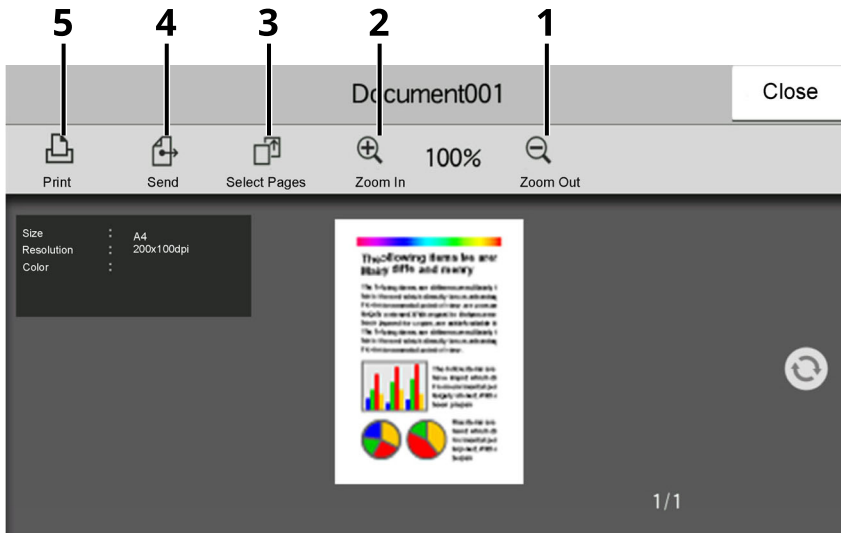

1 Zoom out.

2 Zoom in.

3 Select to select any page of the open document and print, send or copy to USB Drive.

➔ [Selecting a Page \(page 5-49\)](#)

4 Sends the selected documents.

5 Prints the selected documents.



### NOTE

The preview display can be controlled by moving your finger(s) on the touch panel.

➔ [Original Preview \(page 2-27\)](#)

**3** Confirm the document and select [Close].



## Selecting a Page

When printing, sending, or copying a document within a Custom Box, you can specify any pages at will.

- 1 Select [Others] > [Page Selection] in the document list screen of the Custom Box, or [Page Selection] in the Preview screen.**

The page selection screen is displayed.

- 2 Select the pages you want to work with, and select [Print], [Send], or [Copy to USB].**

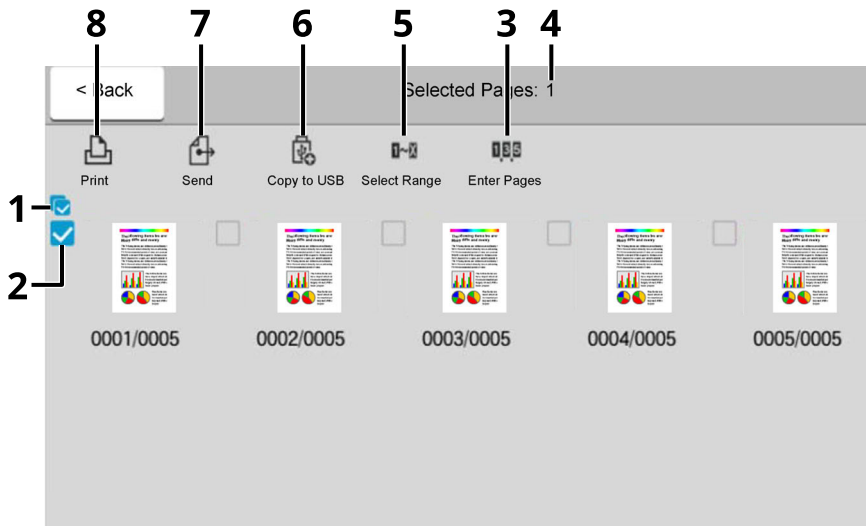

- 1 Selecting more than one document at a time.
- 2 Selecting documents by checking checkboxes.
- 3 Use a “,” (comma) to separate numbers when specifying pages that are not consecutive.
- 4 Specify a continuous page range.
- 5 Displaying the number of pages selected.
- 6 Selected pages can be copied to USB drive.
- 7 Selected pages can be sent.
- 8 Selected pages can be printed.

- ➔ [Printing Documents in Custom Box \(page 5-53\)](#)
- ➔ [Sending Documents in Custom Box \(page 5-55\)](#)
- ➔ [Moving Documents in Custom Box \(page 5-56\)](#)

# Creating a New Custom Box

 **NOTE**

- An optional SSD is required to use the Custom box.
- If the User Authentication screen appears, log in with a user who has the privilege to configure this setting. If you do not know your login User Name or Password, please contact your Administrator.
- If user login administration is enabled, log in with administrator privileges to perform the following operations. They cannot be performed with user privileges.
  - Creating a box
  - Deleting a box of which owner is another user.

## 1 Display the screen.

[Home] key > [Custom Box] > [Add/Edit]

## 2 Register the Custom Box.

1 [Add] > Enter the information for each item

The table below lists the items to be set.

Item	Description
<b>Box Name</b>	Enter a box name consisting of up to 32 characters.  ➔ <a href="#">Character Entry Method (page 11-10)</a>
<b>Box No.</b>	Enter the box number by selecting [+], [-] or number keys. The box number can be from 0001 to 1000. A Custom Box should have a unique number. If you select [ <b>Auto</b> ] (0000), the smallest number available will be automatically assigned.
<b>Owner*1</b>	Set the owner of the box. Select the owner from the user list that appears.
<b>Permission*2</b>	Select whether to share the box.
<b>Box Password</b>	User access to the box can be restricted by specifying a password to protect the box. Entering a password is not mandatory. Enter the same password of up to 16 characters in both "Box Password" and "Confirmation".  This can be set if [ <b>Shared</b> ] is selected in Permission.
<b>Usage Restriction</b>	The usage for a box can be restricted. To enable a capacity restriction enter a value for the storage capacity of the Custom Box in megabytes by selecting [-], [+] or number keys. You can enter a limit between 1 and 30,000 (MB).
<b>Auto File Deletion</b>	Automatically deletes stored documents after a set period of time. Select [ <b>On</b> ] to enable automatic deletion and then use [+] and [-] or the numeric keys to enter the number of days for which documents are stored. You can enter any number between 1 and 31 (day(s)). To disable automatic file deletion, select [ <b>Off</b> ].

Item	Description
<b>Free Space</b>	Displays the free space on the box.
<b>Overwrite Setting</b>	Specifies whether or not old stored documents are overwritten when new documents are stored. To overwrite old documents, select <b>[Permit]</b> . To retain old documents, select <b>[Prohibit]</b> .
<b>Delete after Printed</b>	Automatically delete a document from the box once printing is complete. To delete the document, select <b>[On]</b> . To retain the document, select <b>[Off]</b> .

\*1 Displayed when the user login administration is enabled.

\*2 Not displayed when "Owner" is set to **[No Owner]**.

2 Select **[OK]**.

The Custom Box is created.

## Editing Custom Box

1 **Display the screen.**

**[Home]** key > **[Custom Box]** > **[Add/Edit]**

2 **Edit the custom box.**

Select the box > **[Edit]** > Enter the information for each item > **[OK]**



### NOTE

- When you have logged in as a user, you can only edit a box whose owner is set to that user.
- When you have logged in as administrator, you can edit all boxes.

When user login administration is enabled, the settings that can be changed varies depending on the privileges of the logged in user.

Privileges	Settings that can be changed
Administrator	Box Name
	Box No.
	Owner
	Permission
	Usage Restriction
	Auto File Deletion
	Free Space
	Overwrite Setting
	Delete after Printed
User	Box Name
	Box Password
	Usage Restriction
	Auto File Deletion
	Overwrite Setting
	Delete after Printed

For details on each items, refer to the following:

➔ [Creating a New Custom Box \(page 5-50\)](#)

### 3 [OK] > [Close]

The display returns to the default Document Box screen.

## Deleting Custom Box

### 1 Display the screen.

[Home] key > [Custom Box] > [Add/Edit]

### 2 Delete the custom box.

Select the box > [Delete] > [Delete]



#### NOTE

- When you have logged in as a user, you can only delete a box whose owner is set to that user.
- When you have logged in as administrator, you can edit all boxes.

## Storing Documents to a Custom Box

Custom box stores the print data which is sent from a PC. For the operation of the printing from the PC, refer to the following:

➔ **Printer Driver User Guide**

## Printing Documents in Custom Box

### 1 Display the screen.

- 1 **[Home]** key > **[Custom Box]**
- 2 Select the box containing the document you want to print.



#### NOTE

If a custom box is protected by a password, enter the correct password.

### 2 Print the document.

- 1 Select the document in the list that you want to print by selecting the checkbox.  
The document is marked with a checkmark.



#### NOTE

To deselect, select the checkbox again and remove the checkmark.

- 2 Select **[Print]**.
- 3 Set the paper selection, duplex printing, etc., as desired.  
For the features that can be selected, refer to the following:

➔ [Custom Box \(Store File\) \(page 6-7\)](#)



#### NOTE

Select **[Favorites]** when registering or recalling favorites.

➔ [Registering Favorites \(page 5-8\)](#)

➔ [Recalling Favorites \(page 5-8\)](#)

If a document stored from a computer is selected, the print settings selection screen appears.

To use the settings used at the time of printing (when the document was saved), select **[Print As Is]**. Select **[Start Print]** to start printing.

To change the print settings, select **[Print after Change Settings (Use File Settings)]** or **[Print after Change Settings (Do Not Use File Settings)]** and change the print settings.

After a document saved in the machine is selected, **[Use File Settings]** may appear in the setting screen for the feature to be used.

To use the settings saved with the document, select **[Use File Settings]**.

If you need to change the print settings, select the desired feature.

- 4 Press the **[Start]** key.  
Printing of the selected document begins.

## Saving Scanned Documents to a Custom Box

### 1 Display the screen.

[Home] key > [Custom Box]

### 2 Place the originals.

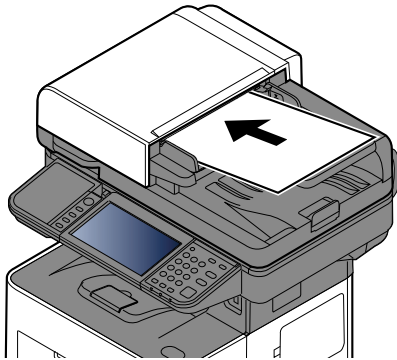

➔ [Loading Originals \(page 5-2\)](#)



### 3 Store the document.

1 Select the box > [Store File]

2 Set the type of original, file format, etc., as desired.

For the features that can be selected, refer to the following:

➔ [Custom Box \(Store File\) \(page 6-7\)](#)

#### NOTE

- Enter up to 32 characters as the file name.
- Select [**Favorites**] when registering or recalling favorites.

➔ [Registering Favorites \(page 5-8\)](#)

➔ [Recalling Favorites \(page 5-8\)](#)

3 Press the [**Start**] key.

The original is scanned and the data is stored in the specified Custom Box.

## Sending Documents in Custom Box

### NOTE

When transmitting using wireless LAN, select the interface dedicated to the send function in advance.

➔ [Primary Network \(Client\) \(page 8-55\)](#)

## 1 Display the screen.

[Home] key > [Custom Box] > Select the box

### NOTE

If a custom box is protected by a password, enter the correct password.

## 2 Send the document.

- 1 Select the document you wish to send by checking the checkbox.

The document is marked with a checkmark.

### NOTE

- You cannot select and send multiple documents.
- To deselect, select the checkbox again and remove the checkmark.

- 2 Select [Send].

### NOTE

Depending on the settings, the address book screen may appear.

- 3 Set the destination.

For more information on selecting destinations, refer to the following:

➔ [Specifying Destination \(page 5-36\)](#)

### IMPORTANT

**Only when specifying the E-mail addresses which have encryption certificate from the address book, [Email Encrypted TX] and [Digital Signature to Email] can be used. When entering E-mail address from the operation panel, you can not use these functions.**

- 4 Set the sending size, original image, etc., as desired.

For the features that can be set, refer to the following:

➔ [Custom Box \(Store File\) \(page 6-7\)](#)

### NOTE

Select [Favorites] when registering or recalling favorites.

➔ [Registering Favorites \(page 5-8\)](#)

➔ [Recalling Favorites \(page 5-8\)](#)

- 5 Press the [Start] key.

Sending of the selected document begins.

## Sending Documents in Custom Box to E-mail Address of Logged in User

When user login is enabled, documents in the custom box are sent to the E-mail address of the logged in user.

### 1 Configure the settings.

Before using this function, the following are necessary.

- The function icon must be displayed in the home screen.
  - ➔ [Editing the Home Screen \(page 2-19\)](#)
- An E-mail address must be set in user login for the user who logs in.
  - ➔ [Adding a User \(Local User List\) \(page 9-6\)](#)

### 2 Select the [Home] key.

### 3 Select [Send to Me(Email)].



#### NOTE

When this function is used, functions other than transmission cannot be used.

## Moving Documents in Custom Box

### 1 Display the screen.

[Home] key > [Custom Box] > Select the box



#### NOTE

If a custom box is protected by a password, enter the correct password.

### 2 Move the documents.

- 1 Select the document in the list that you want to move by selecting the checkbox.

The document is marked with a checkmark.



#### NOTE

To deselect, select the checkbox again and remove the checkmark.

- 2 [Others] > [Move/Copy] > [Move to Custom Box] > select the destination of move > [Move] > [Move]

The selected document is moved.



#### NOTE

If the box to which the document is to be moved is protected by a password, enter the correct password.



## Copying Documents in Custom Box into Other Boxes

### 1 Display the screen.

[Home] key > [Custom Box] > Select the box



#### NOTE

If a custom box is protected by a password, enter the correct password.

### 2 Copy the documents.

- 1 Select the document in the list that you want to copy by selecting the checkbox.

The document is marked with a checkmark.



#### NOTE

To deselect, select the checkbox again and remove the checkmark.

- 2 [Others] > [Move/Copy] > [Copy to Custom Box] > select the destination of copy > [Copy] > [Copy]

The selected document is copied.



#### NOTE

If the box to which the document is to copied is protected by a password, enter the correct password.

## Copying Documents in Custom Box to USB Drive

### 1 Display the screen.

[Home] key > [Custom Box] > Select the box



#### NOTE

If a custom box is protected by a password, enter the correct password.

### 2 Copy the documents.

- 1 Select the document in the list that you want to copy by selecting the checkbox.

The document is marked with a checkmark.



#### NOTE

To deselect, select the checkbox again and remove the checkmark.

- 2 [Others] > [Move/Copy] > [Copy to USB Drive] > select the destination of copy > [Next] > [Copy] > [Copy]

The selected document is copied.

## Joining Documents in Custom Box

You can join documents within a custom box into one file.

### NOTE

You can only join a document to other documents in the same custom box. If necessary, move the documents to be joined beforehand.

## 1 Display the screen.

[Home] key > [Custom Box] > Select the box

### NOTE

If a custom box is protected by a password, enter the correct password.

## 2 Join the document.

- 1 Select the documents in the list that you wish to join by selecting the checkbox.

The document is marked with a checkmark.

You can join up to 10 documents.

### NOTE

To deselect, select the checkbox again and remove the checkmark.

- 2 [Others] > [Join].

- 3 Arrange the documents into the order in which they are to be joined.

Select the document you want to rearrange and select [Up] or [Down] to move it to the correct place in the sequence.

- 4 [Next] > Enter the file name for the joined document

### NOTE

Enter up to 64 characters as the file name.

- 5 [Join] > [Join]

The documents are joined.

### NOTE

After joining, the original documents are left unchanged. Delete the documents if they are no longer needed.

## Deleting Documents in Custom Box

### 1 Display the screen.

- 1 [Home] key > [Custom Box]
- 2 Select the box containing the document.



#### NOTE

If a custom box is protected by a password, enter the correct password.

### 2 Delete the document.

- 1 Select the document in the list that you want to delete by selecting the checkbox.  
The document is marked with a checkmark.



#### NOTE

- [Delete] is disabled until a document is selected.
- To deselect, select the checkbox again and remove the checkmark.

- 2 [Others] > [Delete] > [Delete]

The document is deleted.

## Operating using Removable USB Drive

Plugging USB drive directly into the machine enables you to quickly and easily print the files stored in the USB drive without having to use a computer.

The following file types can be printed:

- PDF file (Version 1.7 or older)
- TIFF file (TIFF V6/TTN2 format)
- JPEG file
- XPS file
- OpenXPS file
- Encrypted PDF file

In addition, you can store scanned image files in USB drive connected to the machine.

The following file types can be stored:

- PDF file format
- TIFF file format
- JPEG file format
- XPS file format
- OpenXPS file format
- High-compression PDF file format
- Word file format
- Excel file format
- PowerPoint file format



### NOTE

Word, Excel and PowerPoint will be saved in a Microsoft Office 2007 or later file format.

## Printing Documents Stored in Removable USB Drive



### NOTE

- PDF files you wish to print should have an extension (.pdf).
- Use USB drive properly formatted by this machine.
- Plug the USB drive directly into the USB Memory Slot.

### 1 Plug the USB drive.

- 1 Plug the USB drive into the USB Memory Slot.

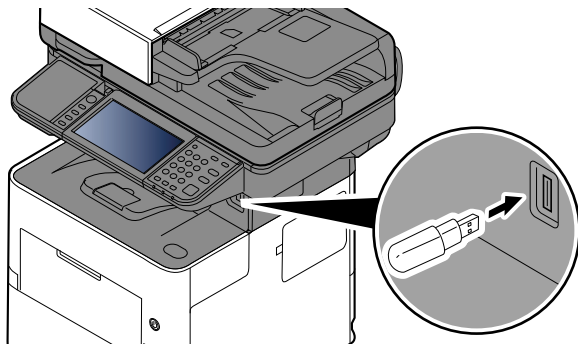

When the machine reads the USB drive, "USB Drive is recognized. Displaying files." may appear.

- 2 Select **[Continue]**.

Displays the USB Drive screen.



**NOTE**

If the message does not appear, select **[USB Drive]** on the Home screen.

## 2 Print the document.

- 1 Select the folder containing the file to be printed.



**NOTE**

- 1,000 documents can be displayed.
- To return to a higher level folder, select **[UP]**.

- 2 Select the file to be printed > **[Print]**
- 3 Change the number of copies, duplex printing, etc. as desired.

For the features that can be selected, refer to the following:

➔ [USB Drive \(Store File\) \(page 6-11\)](#)



**NOTE**

After a document saved in the machine is selected, **[Use File Settings]** may appear in the setting screen for the feature to be used.

- To use the settings saved with the document, select **[Use File Settings]**.
- If you need to change the print settings, select the desired feature.

- 4 Press the **[Start]** key.

Printing of the selected file begins.

## Saving Documents to USB Drive (Scan to USB)

You can store scanned documents to a removal USB drive.

### NOTE

The maximum number of the storable files is 1,000.

### 1 Place the originals.

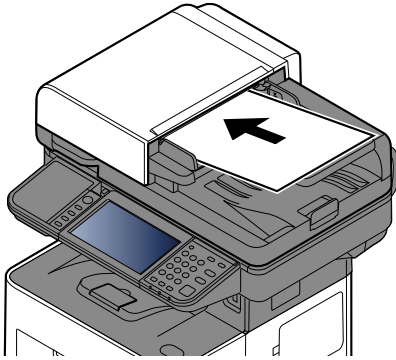

➔ [Loading Originals \(page 5-2\)](#)

### 2 Plug the USB Drive.

- 1 Plug the USB drive into the USB Memory Slot.

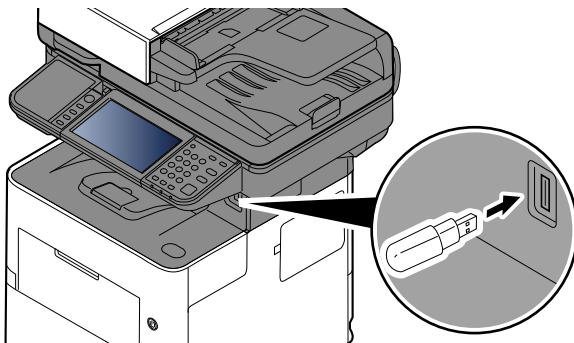

- 2 When the machine reads the USB memory, "USB Drive is recognized. Displaying files." may appear. Select [**Continue**].

Displays the USB Drive screen.

### NOTE

If the message does not appear, select [**USB Drive**] on the Home screen.

### 3 Store the document.

- 1 Select the folder where the file will be stored.
- 2 Select [**Store File**].
- 3 Set the type of original, file format, etc., as desired.

For the features that can be set, refer to the following:

➔ [USB Drive \(Store File\) \(page 6-11\)](#)

- 4 Check the storing image.
- 5 Press the [**Start**] key.

The original is scanned and the data is stored in the USB drive.

## Check the USB Drive Information

- 1 In the USB Drive screen, select [USB Info].
- 2 Once you confirm the information, select [Close].

## Removing USB Drive

 **IMPORTANT**

Be sure to follow the proper procedure to avoid damaging the data or USB drive.

- 1 **Display the screen.**  
[Home] key > [USB Drive]
- 2 **Select [Remove USB].**  
Select [OK], and remove the USB Drive after "USB Drive can be safely removed." is displayed.

 **NOTE**

USB drive can also be removed after checking the Device Information.

➔ [Device Information \(page 7-12\)](#)

Tapping the USB drive icon shown at the top of the touch panel and selecting [**Remove USB**] allows you to safely remove the USB drive.

➔ [Home Screen \(page 2-17\)](#)

# Using the Manual Stapler (ECOSYS MA6000ifx/ECOSYS MA5500ifx only)

You can staple copied paper manually without any print operation.



## NOTE

If the machine is out of staples, add more staples.

➔ [Replacing Staples \(ECOSYS MA6000ifx/ECOSYS MA5500ifx only\) \(page 10-13\)](#)

## Maximum number of sheets available for manual stapling

Paper weight	Number of stapled sheets
80 g/m <sup>2</sup>	20 sheets maximum <sup>*1</sup>
90 g/m <sup>2</sup> or less	15 sheets maximum <sup>*1</sup>

\*1 Paper stack up to 2 mm thick.

- 1 Straighten the edges of the stack of paper, and with the front side facing up, insert the paper into the manual stapler.

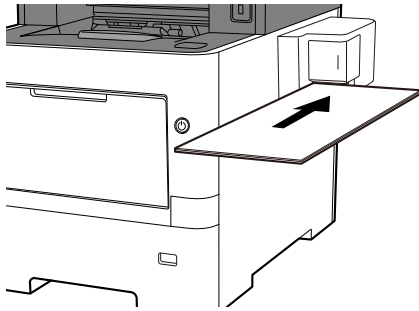

When the paper is inserted all the way in, stapling takes place.



## NOTE

Manual stapling cannot be used while the machine is in sleep mode.

To use manual stapling, select the **[Energy Saver]** key.



# 6 Using Various Functions

This chapter explains the following topics:

About Functions Available on the Machine .....	6-2	FTP Encrypted TX .....	6-45
Copy .....	6-2	Email Encrypted TX .....	6-46
Send .....	6-4	Digital Signature Email .....	6-46
Custom Box (Store File) .....	6-7	Delete after Printed .....	6-47
Custom Box (Print) .....	6-9	Delete after Transmitted .....	6-47
Custom Box (Send) .....	6-10	Storing Size .....	6-48
USB Drive (Store File) .....	6-11	Encrypted PDF Password .....	6-48
USB Drive (Printing Documents) .....	6-13	JPEG/TIFF Print .....	6-49
Functions .....	6-14	XPS Fit to Page .....	6-49
Original Size .....	6-14		
Paper Selection .....	6-15		
Mixed Size Originals .....	6-16		
Original Orientation .....	6-18		
Collate .....	6-19		
ID Card Copy .....	6-19		
Zoom .....	6-19		
Combine .....	6-21		
Border Erase, Border Erase/Full Scan .....	6-23		
Duplex .....	6-25		
Density .....	6-27		
Original Image .....	6-28		
EcoPrint .....	6-29		
Color Selection .....	6-29		
Sharpness .....	6-30		
Background Density Adj. (Background Density Adjustment) .....	6-30		
Prevent Bleed-thru .....	6-31		
Contrast .....	6-31		
Erase Colors .....	6-32		
Continuous Scan .....	6-32		
Job Finish Notice .....	6-33		
File Name Entry .....	6-33		
Priority Override .....	6-34		
Detect Multi-fed Originals .....	6-34		
Detect Bent Corner Originals .....	6-34		
Skip Blank Page .....	6-35		
Quiet Mode .....	6-35		
2-sided .....	6-35		
Sending Size .....	6-36		
Long Original .....	6-37		
File Format .....	6-37		
File Separation .....	6-44		
Scan Resolution .....	6-44		
Clarify Text (Noise Removal) .....	6-45		
Email Subject/Body .....	6-45		

# About Functions Available on the Machine

This machine provides the various functions available.

## Copy

Each function is displayed in the Body when Global Navigation is selected.

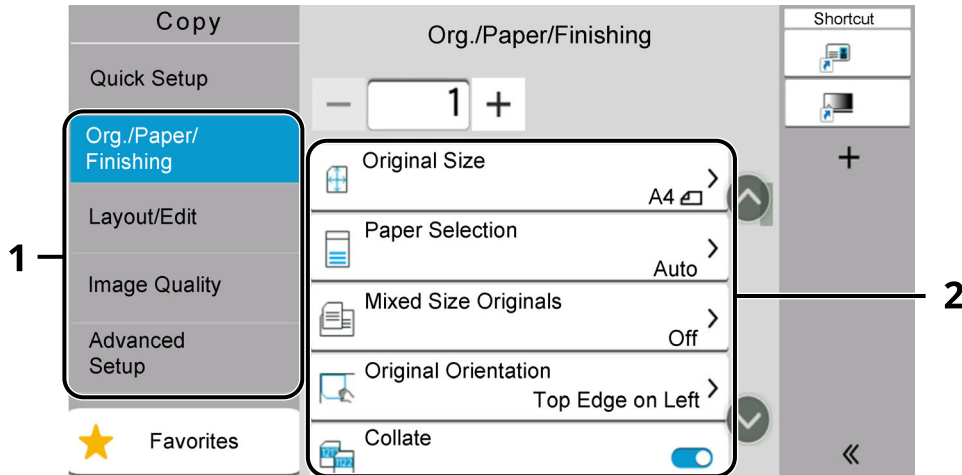

1 Global Navigation

2 Body

For details on each function, see the table below.

Global Navigation	Function	Description	Reference page
<b>Org./Paper/Finishing</b> Configure the settings for originals, paper, and finishing such as collate and staple.	<b>Original Size</b>	Specify the original size to be scanned.	<a href="#">page 6-14</a>
	<b>Paper Selection</b>	Select the cassette or multipurpose tray that contains the required paper size.	<a href="#">page 6-15</a>
	<b>Mixed Size Originals</b>	Scan the documents of different sizes that are set in the document processor all at once.	<a href="#">page 6-16</a>
	<b>Original Orientation</b>	Select the orientation of the original document top edge to scan correct direction.	<a href="#">page 6-18</a>
	<b>Collate</b>	Prints ordered sets of the copies.	<a href="#">page 6-19</a>
	<b>ID Card Copy</b>	Use this when you want to copy a driver's license or an insurance card. When you scan the front and back of the card, both sides will be combined and copied onto a single sheet.	<a href="#">page 6-19</a>
<b>Layout/Edit</b> Configure the settings for duplex printing and stamp.	<b>Zoom</b>	Adjust the zoom to reduce or enlarge the image.	<a href="#">page 6-19</a>
	<b>Combine</b>	Combines 2 or 4 original sheets into 1 printed page.	<a href="#">page 6-21</a>
	<b>Border Erase</b>	Erases the black border that forms around the image.	<a href="#">page 6-23</a>
	<b>Duplex</b>	Produces two-sided copies. You can also create single-sided copies from two-sided originals.	<a href="#">page 6-25</a>

Global Navigation	Function	Description	Reference page
<p><b>Image Quality</b> Configure the settings for density, quality of copies, and color balance.</p>	<b>Density</b>	Adjust density.	<a href="#">page 6-27</a>
	<b>Original Image</b>	Select original image type for best results.	<a href="#">page 6-28</a>
	<b>EcoPrint</b>	EcoPrint saves toner when printing.	<a href="#">page 6-29</a>
	<b>Sharpness</b>	Adjusts the sharpness of image outlines.	<a href="#">page 6-30</a>
	<b>Background Density Adj.</b>	Removes dark background from originals, such as newspapers.	<a href="#">page 6-30</a>
	<b>Prevent Bleed-thru</b>	Hides background colors and image bleed-through when scanning thin original.	<a href="#">page 6-31</a>
	<b>Contrast</b>	You can adjust the contrast between light and dark areas of the image.	<a href="#">page 6-31</a>
	<b>Erase Colors</b>	Erases colors in the source document.	<a href="#">page 6-32</a>
<p><b>Advanced Setup</b> Configure the settings for continuous scanning, mirror image copies, and Skip Blank Page function.</p>	<b>Continuous Scan</b>	Scans a large number of originals in separate batches and then produce as one job.	<a href="#">page 6-32</a>
	<b>Job Finish Notice</b>	Sends E-mail notice when a job is complete.	<a href="#">page 6-33</a>
	<b>File Name Entry</b>	Adds a file name.	<a href="#">page 6-33</a>
	<b>Priority Override</b>	Suspends the current job and gives a new job top priority.	<a href="#">page 6-34</a>
	<b>Detect Multi-fed Originals</b>	When reading a document from the document processor, if the multiple feeding of documents is detected, then the reading stops automatically.	<a href="#">page 6-34</a>
	<b>Detect Bent Corner Originals</b>	When reading a document from the document processor, if a bent corner is detected, then the reading stops automatically.	<a href="#">page 6-34</a>
	<b>Skip Blank Page</b>	When there are blank pages in a scanned document, this function skips the blank pages and prints only pages that are not blank.	<a href="#">page 6-35</a>
	<b>Quiet Mode</b>	The operating sound of the machine can be suppressed.	<a href="#">page 6-35</a>

## Send

Each function is displayed in the Body when Global Navigation is selected.

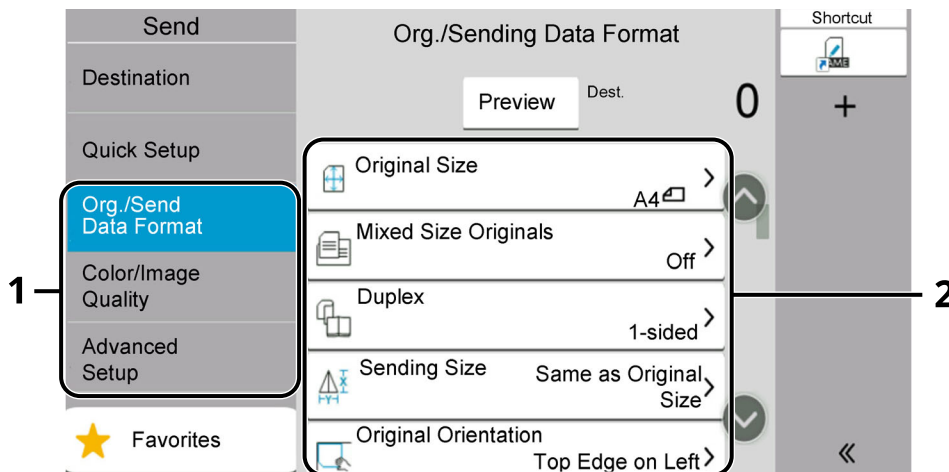

For details on each function, see the table below.

Global Navigation	Function	Description	Reference page
<b>Org./Sending Data Format</b> Configure the settings for original type and file format.	<b>Original Size</b>	Specify the original size to be scanned.	<a href="#">page 6-14</a>
	<b>Mixed Size Originals</b>	Scan the documents of different sizes that are set in the document processor all at once.	<a href="#">page 6-16</a>
	<b>2-sided</b>	Select the type and orientation of the binding based on the original.	<a href="#">page 6-35</a>
	<b>Sending Size</b>	Select size of image to be sent.	<a href="#">page 6-36</a>
	<b>Original Orientation</b>	Select the orientation of the original document top edge to scan correct direction.	<a href="#">page 6-18</a>
	<b>Long Original</b>	Reads long-sized original documents using a document processor.	<a href="#">page 6-37</a>
	<b>File Format</b>	Specify the image file format. Image quality level can also be adjusted.	<a href="#">page 6-37</a>
	<b>File Separation</b>	Creates several files by dividing scanned original data page by specified number of pages, and sends the files.	<a href="#">page 6-44</a>

Global Navigation	Function	Description	Reference page
<p><b>Color/Image Quality</b></p> <p>Configure the settings for density, quality of copies, and color balance.</p>	<b>Density</b>	Adjust density.	<a href="#">page 6-27</a>
	<b>Original Image</b>	Select original image type for best results.	<a href="#">page 6-28</a>
	<b>Scan Resolution</b>	Select fineness of scanning resolution.	<a href="#">page 6-44</a>
	<b>Fax TX Resolution</b>	Select fineness of images when sending FAX.	Refer to <b>FAX Operation Guide</b> .
	<b>Color Selection</b>	Select the color setting.	<a href="#">page 6-29</a>
	<b>Sharpness</b>	Adjusts the sharpness of image outlines.	<a href="#">page 6-30</a>
	<b>Clarify Text (Noise Removal)</b>	When scanning and sending a document in black and white, it eliminates background noise and improves the legibility of the text.	<a href="#">page 6-45</a>
	<b>Background Density Adj.</b>	Removes dark background from originals, such as newspapers.	<a href="#">page 6-30</a>
	<b>Prevent Bleed-thru</b>	Hides background colors and image bleed-through when scanning thin original.	<a href="#">page 6-31</a>
	<b>Contrast</b>	You can adjust the contrast between light and dark areas of the image.	<a href="#">page 6-31</a>
	<b>Erase Colors</b>	Erases colors in the source document.	<a href="#">page 6-32</a>
<p><b>Advanced Setup</b></p> <p>Configure the settings for transmission copy, encrypted transmission, and file size confirmation.</p>	<b>Border Erase/Full Scan</b>	Erases the black border that forms around the image.	<a href="#">page 6-23</a>
	<b>Zoom</b>	Adjust the zoom to reduce or enlarge the image.	<a href="#">page 6-19</a>
	<b>Job Finish Notice</b>	Sends E-mail notice when a job is complete.	<a href="#">page 6-33</a>
	<b>Fax Delayed Transmission</b>	Set a send time.	Refer to <b>FAX Operation Guide</b> .
	<b>File Name Entry</b>	Adds a file name.	<a href="#">page 6-33</a>
	<b>Continuous Scan</b>	Scans a large number of originals in separate batches and then produce as one job.	<a href="#">page 6-32</a>
	<b>Email Subject/Body</b>	Adds subject and body when sending a document.	<a href="#">page 6-45</a>
	<b>Fax Direct Transmission</b>	Sends FAX directly without reading original data into memory.	Refer to <b>FAX Operation Guide</b> .
	<b>Fax Polling RX</b>	Dial the destination and receive documents for Polling Transmission stored in the polling box.	Refer to <b>FAX Operation Guide</b> .
	<b>FTP Encrypted TX</b>	Encrypts images when sending via FTP.	<a href="#">page 6-45</a>
	<b>Email Encrypted TX</b>	Sends encrypted E-mail using the electronic certificate.	<a href="#">page 6-46</a>
	<b>Digital Signature Email</b>	Add a digital signature to the email, using the electronic certificate.	<a href="#">page 6-46</a>
	<b>Fax TX Report</b>	Print a report of fax transmission results.	Refer to <b>FAX Operation Guide</b> .

Global Navigation	Function	Description	Reference page
<p><b>Advanced Setup</b> Configure the settings for transmission copy, encrypted transmission, and file size confirmation.</p>	<b>Detect Multi-fed Originals</b>	When reading a document from the document processor, if the multiple feeding of documents is detected, then the reading stops automatically.	<a href="#">page 6-34</a>
	<b>Detect Bent Corner Originals</b>	When reading a document from the document processor, if a bent corner is detected, then the reading stops automatically.	<a href="#">page 6-34</a>
	<b>Skip Blank Page</b>	When there are blank pages in a scanned document, this function skips the blank pages and sends only pages that are not blank.	<a href="#">page 6-35</a>
	<b>Quiet Mode</b>	The operating sound of the machine can be suppressed.	<a href="#">page 6-35</a>

## Custom Box (Store File)

Each function is displayed in the Body when Global Navigation is selected.

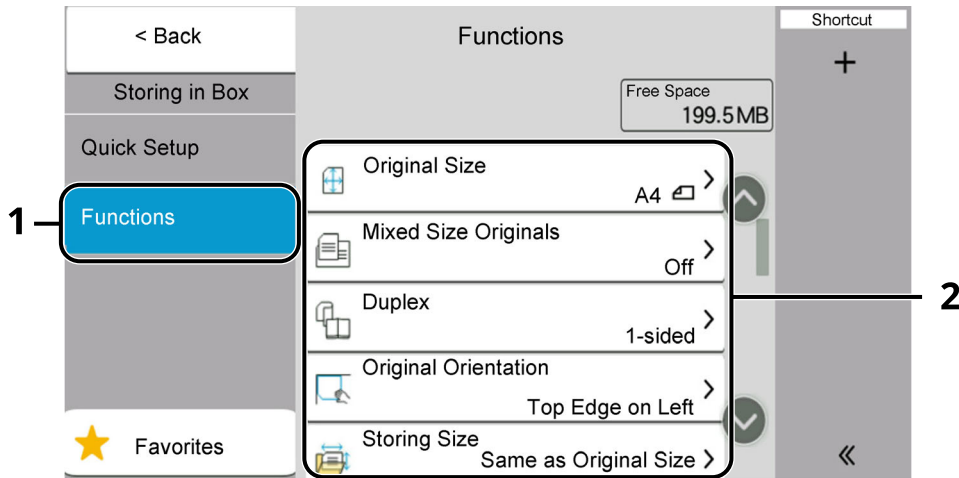

1 Global Navigation

2 Body

For details on each function, see the table below.

Global Navigation	Function	Description	Reference page
<b>Functions</b> Configure the settings when storing the document in the Custom Box.	<b>Original Size</b>	Specify the original size to be scanned.	<a href="#">page 6-14</a>
	<b>Mixed Size Originals</b>	Scan the documents of different sizes that are set in the document processor all at once.	<a href="#">page 6-16</a>
	<b>2-sided</b>	Select the type and orientation of the binding based on the original.	<a href="#">page 6-35</a>
	<b>Original Orientation</b>	Select the orientation of the original document top edge to scan correct direction.	<a href="#">page 6-18</a>
	<b>Storing Size</b>	Select size of image to be stored.	<a href="#">page 6-48</a>
	<b>Prevent Bleed-thru</b>	Hides background colors and image bleed-through when scanning thin original.	<a href="#">page 6-31</a>
	<b>Density</b>	Adjust density.	<a href="#">page 6-27</a>
	<b>Original Image</b>	Select original image type for best results.	<a href="#">page 6-28</a>
	<b>Scan Resolution</b>	Select fineness of scanning resolution.	<a href="#">page 6-44</a>
	<b>Color Selection</b>	Select the color setting.	<a href="#">page 6-29</a>
	<b>Erase Colors</b>	Erases colors in the source document.	<a href="#">page 6-32</a>
	<b>Sharpness</b>	Adjusts the sharpness of image outlines.	<a href="#">page 6-30</a>
	<b>Background Density Adj.</b>	Removes dark background from originals, such as newspapers.	<a href="#">page 6-30</a>
	<b>Zoom</b>	Adjust the zoom to reduce or enlarge the image.	<a href="#">page 6-19</a>
	<b>Border Erase, Border Erase/Full Scan</b>	Erases the black border that forms around the image.	<a href="#">page 6-23</a>

Global Navigation	Function	Description	Reference page
<b>Functions</b> Configure the settings when storing the document in the Custom Box.	<b>Continuous Scan</b>	Scans a large number of originals in separate batches and then produce as one job.	<a href="#">page 6-32</a>
	<b>Job Finish Notice</b>	Sends E-mail notice when a job is complete.	<a href="#">page 6-33</a>
	<b>File Name Entry</b>	Adds a file name.	<a href="#">page 6-33</a>
	<b>Detect Multi-fed Originals</b>	When reading a document from the document processor, if the multiple feeding of documents is detected, then the reading stops automatically.	<a href="#">page 6-34</a>
	<b>Detect Bent Corner Originals</b>	When reading a document from the document processor, if a bent corner is detected, then the reading stops automatically.	<a href="#">page 6-34</a>
	<b>Skip Blank Page</b>	When there are blank pages in a scanned document, this function skips the blank pages and stores only pages that are not blank.	<a href="#">page 6-35</a>
	<b>Quiet Mode</b>	The operating sound of the machine can be suppressed.	<a href="#">page 6-35</a>
	<b>Contrast</b>	You can adjust the contrast between light and dark areas of the image.	<a href="#">page 6-31</a>



## Custom Box (Print)

Each function is displayed in the Body when Global Navigation is selected.

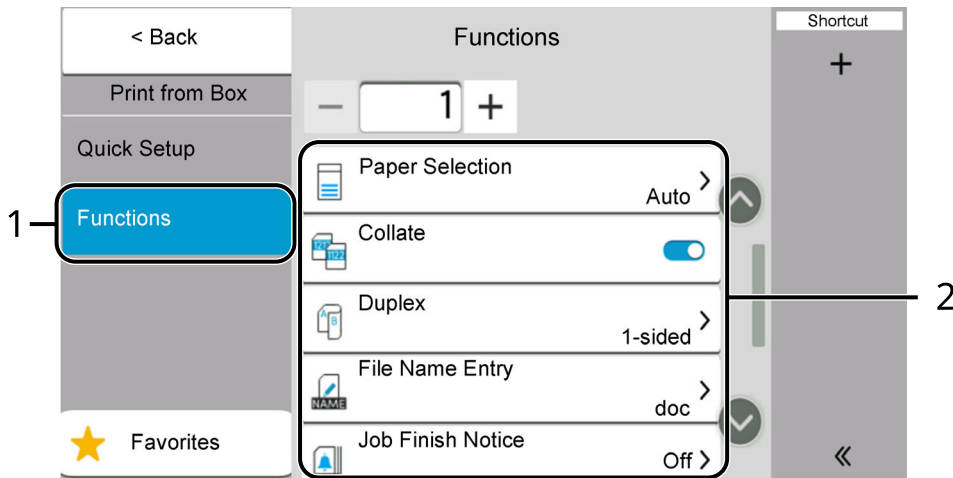

1 Global Navigation

2 Body

For details on each function, see the table below.

Global Navigation	Function	Description	Reference page
<b>Functions</b> Configure the settings for paper selection and duplex printing when printing from the Custom Box.	<b>Paper Selection</b>	Select the cassette or multipurpose tray that contains the required paper size.	<a href="#">page 6-15</a>
	<b>Collate</b>	Prints ordered sets of the copies.	<a href="#">page 6-19</a>
	<b>Duplex</b>	Prints 1-sided or open book originals to 2-sided, or 2-sided or open book originals to 1-sided.	<a href="#">page 6-25</a>
	<b>File Name Entry</b>	Adds a file name.	<a href="#">page 6-33</a>
	<b>Job Finish Notice</b>	Sends E-mail notice when a job is complete.	<a href="#">page 6-33</a>
	<b>EcoPrint</b>	EcoPrint saves toner when printing.	<a href="#">page 6-29</a>
	<b>Priority Override</b>	Suspends the current job and gives a new job top priority.	<a href="#">page 6-34</a>
	<b>Delete after Printed</b>	Automatically deletes a document from the box once printing is complete.	<a href="#">page 6-47</a>
	<b>Quiet Mode</b>	The operating sound of the machine can be suppressed.	<a href="#">page 6-35</a>

## Custom Box (Send)

Each function is displayed in the Body when Global Navigation is selected.

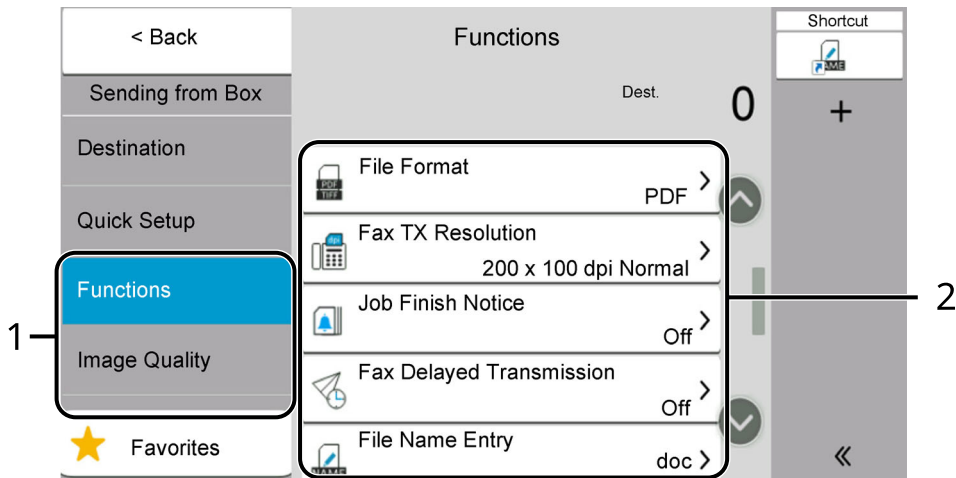

1 Global Navigation

2 Body

For details on each function, see the table below.

Global Navigation	Function	Description	Reference page
<b>Functions</b> Configure the settings for file format and FAX transmission when sending from the Custom Box.	<b>File Format</b>	Specify the image file format. Image quality level can also be adjusted.	<a href="#">page 6-37</a>
	<b>Fax TX Resolution</b>	Select fineness of images when sending FAX.	Refer to <b>FAX Operation Guide</b> .
	<b>Job Finish Notice</b>	Sends E-mail notice when a job is complete.	<a href="#">page 6-33</a>
	<b>Fax Delayed Transmission</b>	Set a send time.	Refer to <b>FAX Operation Guide</b> .
	<b>File Name Entry</b>	Adds a file name.	<a href="#">page 6-33</a>
	<b>Delete after Transmitted</b>	Automatically deletes a document from the box once transmission is complete.	<a href="#">page 6-47</a>
	<b>FTP Encrypted TX</b>	Encrypts images when sending via FTP.	<a href="#">page 6-45</a>
	<b>Email Encrypted TX</b>	Sends encrypted E-mail using the electronic certificate.	<a href="#">page 6-46</a>
	<b>Digital Signature Email</b>	Add a digital signature to the email, using the electronic certificate.	<a href="#">page 6-46</a>
	<b>File Separation</b>	Creates several files by dividing scanned original data page by specified number of pages, and sends the files.	<a href="#">page 6-44</a>
	<b>Fax TX Report</b>	Print a report of fax transmission results.	Refer to <b>FAX Operation Guide</b> .
<b>Image Quality</b> Configure the settings for density, quality of copies, and color balance.	<b>Resolution</b>	Select fineness of scanning resolution.	<a href="#">page 6-44</a>

## USB Drive (Store File)

Each function is displayed in the Body when Global Navigation is selected.

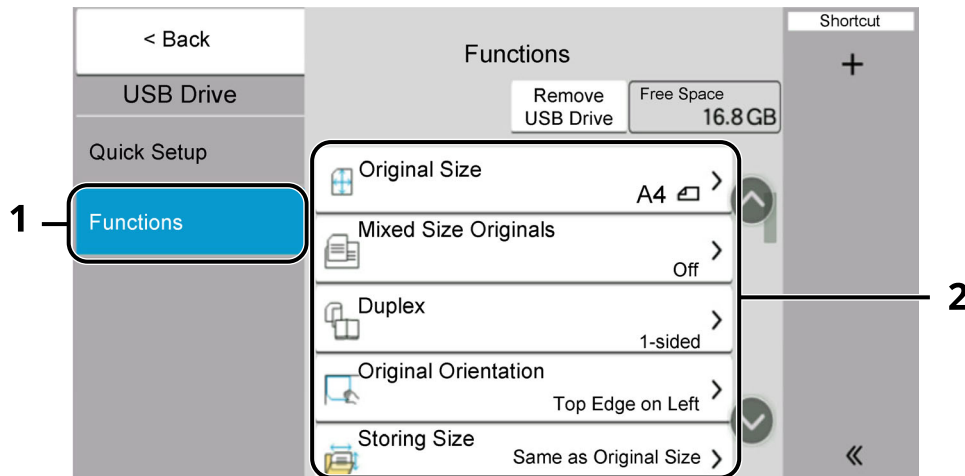

1 Global Navigation

2 Body

For details on each function, see the table below.

Global Navigation	Function	Description	Reference page
<p><b>Functions</b> Configure the settings for color selection and document name when storing the document in the USB drive.</p>	<b>Original Size</b>	Specify the original size to be scanned.	<a href="#">page 6-14</a>
	<b>Mixed Size Originals</b>	Scan the documents of different sizes that are set in the document processor all at once.	<a href="#">page 6-16</a>
	<b>2-sided</b>	Select the type and orientation of the binding based on the original.	<a href="#">page 6-35</a>
	<b>Original Orientation</b>	Select the orientation of the original document top edge to scan correct direction.	<a href="#">page 6-18</a>
	<b>Storing Size</b>	Select size of image to be stored.	<a href="#">page 6-48</a>
	<b>Prevent Bleed-thru</b>	Hides background colors and image bleed-through when scanning thin original.	<a href="#">page 6-31</a>
	<b>Density</b>	Adjust density.	<a href="#">page 6-27</a>
	<b>Original Image</b>	Select original image type for best results.	<a href="#">page 6-28</a>
	<b>Scan Resolution</b>	Select fineness of scanning resolution.	<a href="#">page 6-44</a>
	<b>Color Selection</b>	Select the color setting.	<a href="#">page 6-29</a>
	<b>Erase Colors</b>	Erases colors in the source document.	<a href="#">page 6-32</a>
	<b>Sharpness</b>	Adjusts the sharpness of image outlines.	<a href="#">page 6-30</a>
	<b>Clarify Text (Noise Removal)</b>	When scanning and sending a document in black and white, it eliminates background noise and improves the legibility of the text.	<a href="#">page 6-45</a>
	<b>Background Density Adj.</b>	Removes dark background from originals, such as newspapers.	<a href="#">page 6-30</a>
	<b>Zoom</b>	Adjust the zoom to reduce or enlarge the image.	<a href="#">page 6-19</a>
<b>Border Erase, Border Erase/Full Scan</b>	Erases the black border that forms around the image.	<a href="#">page 6-23</a>	

Global Navigation	Function	Description	Reference page
<p><b>Functions</b></p> <p>Configure the settings for color selection and document name when storing the document in the USB drive.</p>	<b>Continuous Scan</b>	Scans a large number of originals in separate batches and then produce as one job.	<a href="#">page 6-32</a>
	<b>File Name Entry</b>	Adds a file name.	<a href="#">page 6-33</a>
	<b>File Format</b>	Specify the image file format. Image quality level can also be adjusted.	<a href="#">page 6-37</a>
	<b>Job Finish Notice</b>	Sends E-mail notice when a job is complete.	<a href="#">page 6-33</a>
	<b>File Separation</b>	Creates several files by dividing scanned original data page by specified number of pages, and sends the files.	<a href="#">page 6-44</a>
	<b>Detect Multi-fed Originals</b>	When reading a document from the document processor, if the multiple feeding of documents is detected, then the reading stops automatically.	<a href="#">page 6-34</a>
	<b>Detect Bent Corner Originals</b>	When reading a document from the document processor, if a bent corner is detected, then the reading stops automatically.	<a href="#">page 6-34</a>
	<b>Skip Blank Page</b>	When there are blank pages in a scanned document, this function skips the blank pages and stores only pages that are not blank.	<a href="#">page 6-35</a>
	<b>Contrast</b>	You can adjust the contrast between light and dark areas of the image.	<a href="#">page 6-31</a>
	<b>Quiet Mode</b>	The operating sound of the machine can be suppressed.	<a href="#">page 6-35</a>
	<b>Long Original</b>	Reads long-sized original documents using a document processor.	<a href="#">page 6-37</a>

## USB Drive (Printing Documents)

Each function is displayed in the Body when Global Navigation is selected.

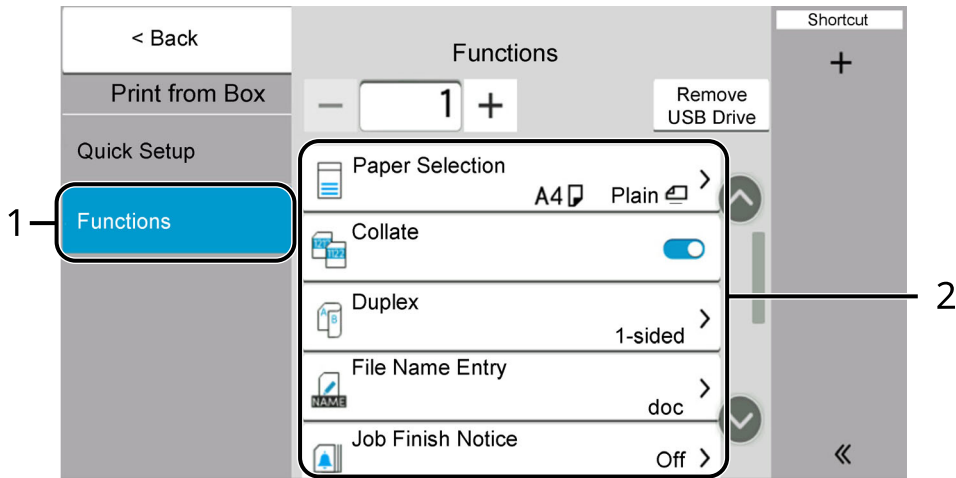

1 Global Navigation





2 Body

For details on each function, see the table below.





Global Navigation	Function key	Description	Reference page
<b>Functions</b> Configure the settings for paper selection and duplex printing when printing from the USB drive.	<b>Paper Selection</b>	Select the cassette or multipurpose tray that contains the required paper size.	<a href="#">page 6-15</a>
	<b>Collate</b>	Prints ordered sets of the copies.	<a href="#">page 6-19</a>
	<b>Duplex</b>	Print a document to 1-sided or 2-sided sheets.	<a href="#">page 6-25</a>
	<b>File Name Entry</b>	Adds a file name.	<a href="#">page 6-33</a>
	<b>Job Finish Notice</b>	Sends E-mail notice when a job is complete.	<a href="#">page 6-33</a>
	<b>EcoPrint</b>	EcoPrint saves toner when printing.	<a href="#">page 6-29</a>
	<b>Priority Override</b>	Suspends the current job and gives a new job top priority.	<a href="#">page 6-34</a>
	<b>Encrypted PDF Password</b>	Enter the preassigned password to print the PDF data.	<a href="#">page 6-48</a>
	<b>JPEG/TIFF Print</b>	Select the image size when printing JPEG or TIFF files.	<a href="#">page 6-49</a>
	<b>XPS Fit to Page</b>	Reduces or enlarges the image size to fit to the selected paper size when printing XPS file.	<a href="#">page 6-49</a>
	<b>Quiet Mode</b>	The operating sound of the machine can be suppressed.	<a href="#">page 6-35</a>

# Functions

On pages that explain a convenient function, the modes in which that function can be used are indicated by icons.

Icon	Description
 Org./Paper /Finishing	Access to the function is indicated by icons. Example: Select [ <b>Org./Paper/Finishing</b> ] in the Copy screen to use the function.
 Org./Sending Data Format	Access to the function is indicated by icons. Example: Select [ <b>Org./Sending Data Format</b> ] in the Send screen to use the function.
 Functions	Access to the function is indicated by icons. Example: Select [ <b>Functions</b> ] in the Custom Box screen to use the function.
 Functions	Access to the function is indicated by icons. Example: Select [ <b>Functions</b> ] in the USB Drive screen to use the function.

## Original Size

 Org./Paper /Finishing    
  Org./Sending Data Format    
  Functions    
  Functions

Specify the original size to be scanned.

Select [**Auto (Document Processor)**], [**Metric**], [**Inch**], [**Others**] or [**Size Entry**] to select the original size.

Item	Value	Description
<b>Auto (Standard Size)<sup>*1</sup></b>	—	Have the size of original detected automatically.
<b>Auto (Non-Standard Size)</b>	—	Scans non-standard size originals, and automatically measures and sets the original size.
<b>Metric</b>	A4, A5, A6, B5, B6, Folio, 216 × 340 mm	Select from the Metric series standard sizes.
<b>Inch</b>	Letter, Legal, Statement, Oficio II, Executive	Select from the Inch series standard sizes.
<b>Others</b>	16K, ISO B5, Envelope #10, Envelope #9, Envelope #6, Envelope Monarch, Envelope DL, Envelope C5, Hagaki, Oufuku Hagaki, Youkei 4, Youkei 2, Youcho 3, Nagagata 3, Nagagata No.4, Custom <sup>*2</sup>	Select from special standard sizes and custom sizes.

\*1 Displayed if "Auto (standard size)" is set to [**On**] in the System menu.

\*2 For instructions on how to specify the custom original size, refer to the following:

➔ [Custom Original Size \(page 8-12\)](#)



### NOTE

Be sure to always specify the original size when using custom size original.

## Paper Selection

Org./Paper  
/Finishing

Functions



Functions

Select the cassette or multipurpose tray that contains the required paper size.

If **[Auto]** is selected, the paper matching the size of the original is selected automatically.



### NOTE

- Specify in advance the size and type of the paper loaded in the cassette.
- ➔ [Paper Feeding \(page 8-13\)](#)
- Cassettes after Cassette 2 are displayed when the optional paper feeder is installed.

In case of changing the paper size and the media type of the multi purpose tray, select **[Change Multipurpose Tray Settings]** and change Paper Size and Media Type. The available paper sizes and media types are shown in the table below.

Item		Value	Description
Paper Size	Metric	A4, A5-R, A5, A6, B5, B6, Folio, 216 × 340 mm	Select from the Metric standard size.
	Inch	Letter, Legal, Statement, Statement-R, Executive, Oficio II	Select from the Inch standard size.
	Others	16K, ISO5, Envelope#10, Envelope#9, Envelope#6, Envelope Monarch, Envelope DL, Envelope C5, Hagaki (Cardstock) <sup>*2</sup> , Oufukuhagaki (Return postcard), Youkei 4, Youkei 2, Younaga 3, Nagagata 3, Nagagata 4, Custom <sup>*1</sup>	Select from special standard sizes and custom sizes.
	Size Entry	Metric X: 70 to 216 mm (in 1 mm increments) Y: 140 to 356 mm (in 1 mm increments)	Enter the size not included in the standard size. <sup>*2</sup> When you have selected <b>[Size Entry]</b> , use <b>[+]</b> / <b>[-]</b> or the numeric keys to set the sizes of "X" (horizontal) and "Y" (vertical). Select the entry field to use the numeric keys for entry.
Inch X: 2.76 to 8.5" (in 0.01" increments) Y: 5.51 to 14.02" (in 0.01" increments)			
Media type		Plain, Transparency, Rough, Vellum, Labels, Recycled, Preprinted <sup>*3</sup> , Bond, Cardstock, Color, Prepunched <sup>*3</sup> , Letterhead <sup>*3</sup> , Thick, Envelope, High Quality, Custom 1-8 <sup>*4</sup>	

\*1 For instructions on how to specify the custom paper size, refer to the following:

➔ [Cassette 1 Size \(page 8-15\)](#)

\*2 The input units can be changed in System Menu. For details, refer to the following:

➔ [Measurement \(page 8-7\)](#)

\*3 To print on preprinted or prepunched paper or on letterhead, refer to the following:

➔ [Special Paper Action \(page 8-18\)](#)

\*4 For instructions on how to specify the custom paper types 1 to 8, refer to the following:

➔ [Media Type Setting \(page 8-17\)](#)

**NOTE**

- You can conveniently select in advance the size and type of paper that will be used often and set them as default.
- [MP Tray Settings \(page 8-14\)](#)
- If the specified size of paper is not loaded in the paper source cassette or multipurpose tray, a confirmation screen appears. When set to **[Auto]**, if the detected size of paper is not loaded, a confirmation screen appears. Load the required paper in the multipurpose tray and select **[Continue]** to start copying.

## Mixed Size Originals



Org./Paper /Finishing



Org./Sending Data Format



Functions



Functions

Scan the documents of different sizes that are set in the document processor all at once.

This function cannot be used if platen is used. Different Width is not displayed in inch models.

Item	Value	Description
Mixed Size Originals	Off	
	Same Width	Scans and sends/stores multiple sheets of the same width using the document processor.
	Different Width	Scans and sends/stores multiple sheets of different width using the document processor.

### Supported Combinations of Originals

#### Same Width

When the original widths are the same, the combinations of originals that can be placed are as follows.

- A4 and Folio (Legal and Letter)

#### Example: Folio and A4

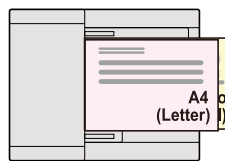
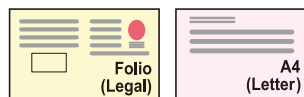

#### Different Width (Available for metric models only)

The supported combinations of originals are as follows.

- Letter-R, A4-R, Folio, Legal

#### Example: A4-R, Legal







**NOTE**

Number of sheet that can be placed in the document processor: up to 30 sheets



**IMPORTANT**

**When placing originals of different width, arrange the originals so that their left sides and top sides are aligned, and place the originals in alignment with the far width guide. If the originals are not aligned in this way, they may not be scanned correctly, and skewing or original jams may result.**

### Selecting How to Copy Originals

Originals are detected individually for size and copied to the same size paper as originals.



# Original Orientation



Org./Paper /Finishing



Org./Sending Data Format



Functions



Functions

Select the orientation of the original document top edge to scan correct direction.

To use any of the following functions, the document's original orientation must be set.

- Zoom
- Duplex
- Border Erase, Border Erase/Full Scan
- Combine
- 2-sided

**NOTE**

If [On] is selected in the setting for Original Orientation in System Menu, the selection screen for original orientation appears when you select any of the above functions.

➔ [Orientation Confirmation \(page 8-19\)](#)

Select original orientation from [Top Edge on Top], [Top Edge on Left] or [Auto].

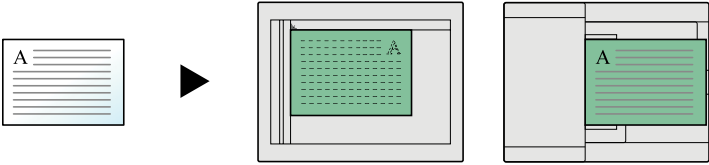
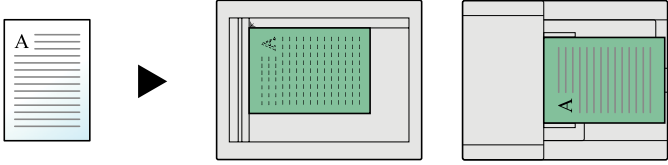
Item	Image
<p><b>Top Edge on Top</b></p>	 <p style="text-align: center;">Original                      Original orientation</p>
<p><b>Top Edge on Left</b></p>	 <p style="text-align: center;">Original                      Original orientation</p>
<p><b>Auto*1</b></p>	

\*1 This function can only be used when the optional OCR Scan Activation Kit is installed.

**NOTE**

The default setting for Original Orientation can be changed.

➔ [Original Orientation \(Copy\) \(page 8-26\)](#)

## Collate

**Copy** Org./Paper /Finishing

**Send** Functions

**USB Drive** Functions

Prints ordered sets of the copies.

(Value: [Off] / [On])

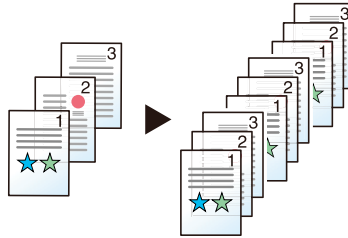

## ID Card Copy

**Copy** Org./Paper /Finishing

Use this when you want to copy a driver's license or an insurance card. When you scan the front and back of the card, both sides will be combined and copied onto a single sheet.

(Value: [Off] / [On])

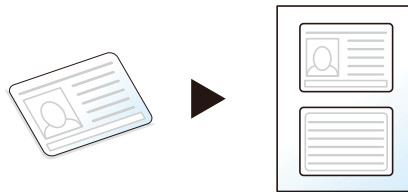

## Zoom

**Copy** Layout/Edit

**Send** Advanced Setup

**Custom Box** Functions

**USB Drive** Functions

Adjust the zoom to reduce or enlarge the image.

### Copying

The following zoom options are available.

#### Auto

Adjusts the image to match the paper size.

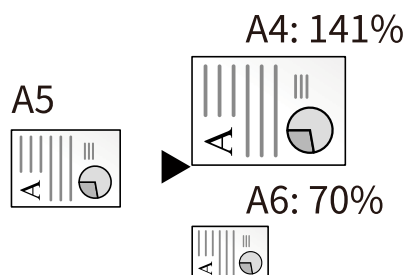

**Standard Zoom**

Reduces or enlarges at preset magnifications.

400%	Maximum	100%	—	50%	—
200%	—	90%	Folio>>A4	64%	Letter>>Statement
141%	A5>>A4	86%	A4>>B5	25%	Minimum
129%	STMT>>Letter	78%	Legal >> Letter		
115%	B5>>A4	70%	A4>>A5		

**Zoom Entry**

Manually reduces or enlarges the original image in 1% increments between 25% and 400%. Use the numeric keys or select [+] or [-] to enter the any magnification.

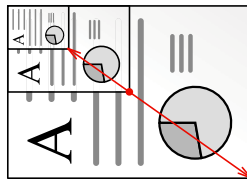
**Printing/Sending/Storing**

Item	Description
<b>100%</b>	Reproduces the original size.
<b>Auto</b>	Reduces or enlarges original to sending/storing size.

 **NOTE**

To reduce or enlarge the image, select the paper size, sending size, or storing size.

- ➔ [Paper Selection \(page 6-15\)](#)
- ➔ [Sending Size \(page 6-36\)](#)
- ➔ [Storing Size \(page 6-48\)](#)

## Combine



Layout/Edit



Functions

Combines 2 or 4 original sheets into 1 printed page.

You can select the page layout and the type of boundary lines around the pages.

The following types of the boundary lines are available.



None

Solid Line

Dotted Line

Positioning Mark

Item	Value	Description	
<b>Off</b>			
<b>2 in 1</b>	<b>Layout</b>	Left to Right/Top to Bottom, Right to Left/Bottom to Top	Select the page layout of scanned originals.
	<b>Border Line</b>	None, Solid Line, Dotted Line, Positioning Mark	Select the boundary line type. Select [ <b>Border Line</b> ] to select the page boundary line.
	<b>Original Orientation</b>	Top Edge on Top, Top Edge on Left, Auto <sup>*1</sup>	Select the orientation of the original document top edge to scan correct direction. Select [ <b>Original Orientation</b> ] to choose orientation of the originals, either [ <b>Top Edge on Top</b> ] or [ <b>Top Edge on Left</b> ].
<b>4 in 1</b>	<b>Layout</b>	Right then Down, Left then Down, Down then Right, Down then Left	Select the page layout of scanned originals.
	<b>Border Line</b>	None, Solid Line, Dotted Line, Positioning Mark	Select the boundary line type. Select [ <b>Border Line</b> ] to select the page boundary line.
	<b>Original Orientation</b>	Top Edge on Top, Top Edge on Left, Auto <sup>*1</sup>	Select the orientation of the original document top edge to scan correct direction. Select [ <b>Original Orientation</b> ] to choose orientation of the originals, either [ <b>Top Edge on Top</b> ] or [ <b>Top Edge on Left</b> ].

\*1 This function can only be used when the optional OCR Scan Activation Kit is installed.

## Layout image

Item		Image
2 in 1	L to R/T to B	
	R to L/B to T	
4 in 1	Right then Down	
	Left then Down	
	Down then Right	
	Down then Left	

### NOTE

- The paper sizes supported in Combine mode are A4, A5, B5, Folio, 216 × 340 mm, Letter, Legal, Statement, Oficio II, and 16K.
- When placing the original on the platen, be sure to copy the originals in page order.

## Border Erase, Border Erase/Full Scan



Erases the black border that forms around the image.

### Standard

Erase the black frame created in the original. Erasing width is fixed.

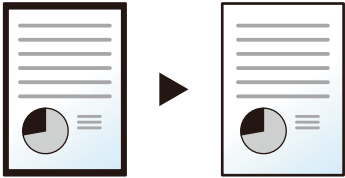

Original

Finishing

### Full Scan

Scan originals without white margins. No border erase.

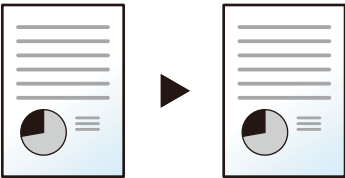

Original

Finishing

### Border Erase Sheet

Erase the black frame created in the original. Erasing width can be adjusted.



Original

Finishing

### Border Erase Book

Erases black borders around the edges and in the middle of the original such as a thick book. You can specify the widths individually to erase the borders around the edges and in the center of the book.

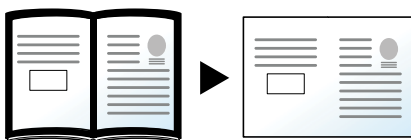

Original

Finishing

## Individual Border Erase

You can specify border erase widths individually for all edges.



### NOTE

- **[Full Scan]** is not displayed when copying.
- The default setting for border erase width can be changed.
  - ➔ [Border Erase Default \(page 8-25\)](#)
- The default width for back page can be changed.
  - ➔ [Border Erase to Back Page \(page 8-25\)](#)

Item		Value	Description
<b>Standard</b>		Scan originals with Standard Mode.	
<b>Full Scan</b> <sup>*1</sup>		Scan originals without white margins.	
<b>Border Erase Sheet</b>	<b>Border</b>	Metric: 0 mm to 50 mm (in 1 mm increments) Inch: 0.00 to 2.00" (in 0.01" increments)	Set the border erase width. <sup>*2</sup> Use [+], [-] or the numeric keys to set the value.
	<b>Back Page</b>	Same as Front Page, Do Not Erase	For 2-sided originals, select <b>[Back Page]</b> and then select <b>[Same as Front Page]</b> or <b>[Do Not Erase]</b> .
<b>Border Erase Book</b>	<b>Border</b>	Metric: 0 mm to 50 mm (in 1 mm increments) Inch: 0.00 to 2.00" (in 0.01" increments)	Set the border erase width around the edges and in the center of the book. <sup>*2</sup> Use [+], [-] or the numeric keys to set the value.
	<b>Back Page</b>	Same as Front Page, Do Not Erase	For 2-sided originals, select <b>[Back Page]</b> and then select <b>[Same as Front Page]</b> or <b>[Do Not Erase]</b> .
<b>Individual Border Erase</b>	<b>Border</b>	Metric: 0 mm to 50 mm (in 1 mm increments) Inch: 0.00 to 2.00" (in 0.01" increments)	Set the border erase width individually for all edges. <sup>*2</sup> Use [+], [-] or the numeric keys to set the value.
	<b>Back Page</b>	Same as Front Page, Do Not Erase	For 2-sided originals, select <b>[Back Page]</b> and then select <b>[Same as Front Page]</b> or <b>[Do Not Erase]</b> .
	<b>Original Orientation</b>	Top Edge on Top, Top Edge on Left, Auto <sup>*3</sup>	Select the orientation of the original document top edge to scan correct direction. Select <b>[Original Orientation]</b> to choose orientation of the originals, either <b>[Top Edge on Top]</b> or <b>[Top Edge on Left]</b> .

\*1 Not displayed when copying.

\*2 The input units can be changed in System Menu.

➔ [Measurement \(page 8-7\)](#)

\*3 This function can only be used when the optional OCR Scan Activation Kit is installed.



# Duplex



Layout/Edit



Functions



Functions

Produces two-sided copies. You can also create single-sided copies from two-sided originals.

The following modes are available.

## One-sided to Two-sided

Produces two-sided copies from one-sided originals. In case of an odd number of originals, the back side of the last copy will be blank.

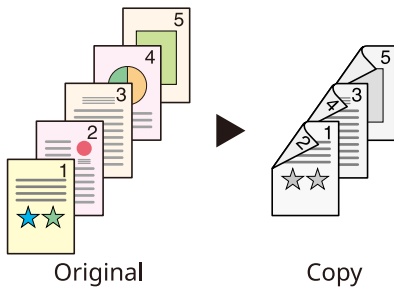

Original

Copy

The following binding options are available.

- A Binding Left/Right: Images on the second sides are not rotated.
- B Binding Top: Images on the second sides are rotated 180 degrees. Copies can be bound on the top edge, facing the same orientation when turning the pages.

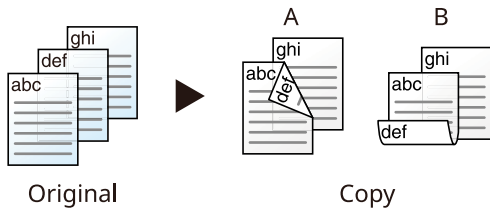

Original

Copy

## Two-sided to One-sided

Copies each side of a two-sided original onto two individual sheets. Place originals in the document processor.

The following binding options are available.

- Binding Left/Right: Images on the second sides are not rotated.
- Binding Top: Images on the second sides are rotated 180 degrees.

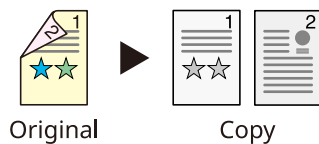



Original

Copy

## Two-sided to Two-sided

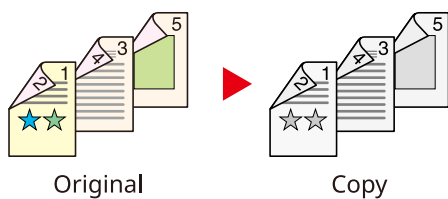
Produces two-sided copies from two-sided originals. Place originals in the document processor.



 **NOTE**  
The paper sizes supported in Duplex mode: A4, A5-R, A5, A6, B5, B6-R, Letter, Legal, Statement-R, Executive, Oficio II, Folio, 16K, ISO B5

## Copying

Prints 1-sided originals to 2-sided, or 2-sided originals to 1-sided. Select the binding orientation for original and finished documents.

Item		Value	Description
1-sided>>1-sided		—	Disables the function.
1-sided>>2-sided	Finishing	Left/Right, Top	Select the binding orientation of copies.
	Original Orientation	Top Edge on Top, Top Edge on Left, Auto <sup>*1</sup>	Select the orientation of the original document top edge to scan correct direction. Select [ <b>Original Orientation</b> ] to choose orientation of the originals, either [ <b>Top Edge on Top</b> ] or [ <b>Top Edge on Left</b> ].
2-sided>>1-sided	Original	Left/Right, Top	Select the binding orientation of originals.
	Original Orientation	Top Edge on Top, Top Edge on Left, Auto <sup>*1</sup>	Select the orientation of the original document top edge to scan correct direction. Select [ <b>Original Orientation</b> ] to choose orientation of the originals, either [ <b>Top Edge on Top</b> ] or [ <b>Top Edge on Left</b> ].
2-sided>>2-sided	Original	Left/Right, Top	Select the binding direction of originals.
	Finishing	Left/Right, Top	Select the binding orientation of copies.
	Original Orientation	Top Edge on Top, Top Edge on Left, Auto <sup>*1</sup>	Select the orientation of the original document top edge to scan correct direction. Select [ <b>Original Orientation</b> ] to choose orientation of the originals, either [ <b>Top Edge on Top</b> ] or [ <b>Top Edge on Left</b> ].

\*1 This function can only be used when the optional OCR Scan Activation Kit is installed.

When placing the original on the platen, consecutively replace each original and press the [**Start**] key. After scanning all originals, select [**Finish Scan**] to start copying.

## Printing

Print a document to 1-sided or 2-sided sheets.

Item		Value	Description
1-sided		—	Disables the function.
2-sided	Finishing	Left/Right	Prints a 2-sided document so that the sheets are aligned properly for binding on the left or right.
		Top	Prints a 2-sided document so that the sheets are aligned properly for binding on the top.

## Density

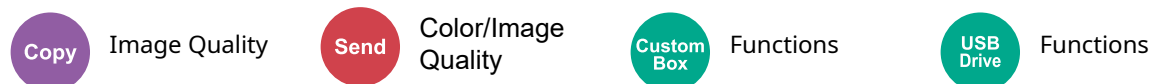

Adjust density.

Adjust density selecting [-4] (Lighter) to [+4] (Darker).



## Original Image



Image Quality

Color/Image  
Quality

Functions



Functions

Select original image type for best results.

### Copying

Item		Value	Description
<b>Text+Photo</b> <sup>*1</sup>	<b>Highlighter Enhancement</b>	Off, On (Normal), On (Bright)	Select [ <b>On (Normal)</b> ] to reproduce the color of the text and markings made with highlighter pen. If the colors are not bright enough, select [ <b>On (Bright)</b> ].
<b>Photo</b>		-	Best for photos taken with a camera.
<b>Text</b>	<b>Highlighter Enhancement</b>	Off, On (Normal), On (Bright)	Select [ <b>On (Normal)</b> ] to reproduce the color of the text and markings made with highlighter pen. If the colors are not bright enough, select [ <b>On (Bright)</b> ].
<b>Graphic/Map</b>	<b>Highlighter Enhancement</b>	Off, On (Normal), On (Bright)	Select [ <b>On (Normal)</b> ] to reproduce the color of the text and markings made with highlighter pen. If the colors are not bright enough, select [ <b>On (Bright)</b> ].

\*1 If gray text is not printed completely using [**Text + Photo**], selecting [**Text**] may improve the result.

### Sending/Printing/Storing

Item		Value	Description
<b>Text+Photo</b>			Best for mixed text and photo documents.
	<b>Highlighter Enhancement</b>	<b>Off, On (Normal), On (Bright)</b>	Select [ <b>On (Normal)</b> ] to reproduce the color of the text and markings made with highlighter pen. If the colors are not bright enough, select [ <b>On (Bright)</b> ].
<b>Photo</b>			Best for photos taken with a camera.
<b>Text</b>	<b>Light Text/Fine Line</b>	Off	Best for documents that are mostly text and were originally printed on this machine.
		On	Sharply renders pencil text and fine lines.
	<b>Highlighter Enhancement</b>	Off, On (Normal), On (Bright)	Select [ <b>On (Normal)</b> ] to reproduce the color of the text and markings made with highlighter pen. If the colors are not bright enough, select [ <b>On (Bright)</b> ].
<b>Text (for OCR)</b>			Scanning produces an image that is suitable for OCR. This function is only available when Color Selection is set to Black and White. ➔ <a href="#">Color Selection (page 6-29)</a>

## EcoPrint

**Copy** Image Quality

**Custom Box** Functions

**USB Drive** Functions

EcoPrint saves toner when printing.

Use this function for test prints or any other occasion when high quality print is not required.

(Value: [Off] / [On])

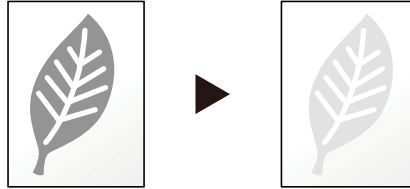

## Color Selection

Select the color setting.

**Send** Color/Image Quality

**Custom Box** Functions

**USB Drive** Functions

Item	Description
<b>Auto (Color/Grayscale)</b>	Automatically recognizes whether the document is color or black and white, and scan color documents in Full Color and black and white documents in Grayscale.
<b>Auto (Color/B &amp; W)</b>	Automatically recognizes whether the document is color or black and white, and scan color documents in Full Color and black and white documents in Black and White.
<b>Full Color</b>	Scans the document in full color.
<b>Grayscale</b>	Scans the document in grayscale. Produces a smooth, detailed image.
<b>Black &amp; White</b>	Scans the document in black and white.

## Sharpness



Image Quality



Color/Image Quality



Functions



Functions

Adjusts the sharpness of image outlines.

When copying penciled originals with rough or broken lines, clear copies can be taken by adjusting sharpness toward "Sharpen". When copying images made up of patterned dots such as magazine photos, in which moire<sup>\*1</sup> patterns appear, edge softening and weakening of the moire effect can be obtained by setting the sharpness toward "Blur".

When [**All**] is selected, select [-3] to [3] (Blur - Sharpen) to adjust the sharpness.

When [**Text/Fine Line**] is selected, select [0] to [3] (Normal - Sharpen) to adjust the sharpness.

Less Sharp



Original



More Sharp

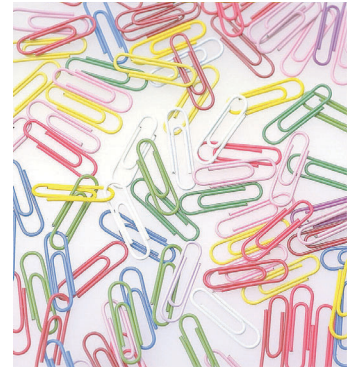

Value	Description
[+1] to [+3] (Sharpen)	Emphasizes the image outline.
[-1] to [-3] (Blur)	Blurs the image outline. Can weaken a Moire <sup>*1</sup> effect.

\*1 Patterns that are created by irregular distribution of halftone dots.

## Background Density Adj. (Background Density Adjustment)



Image Quality



Color/Image Quality



Functions



Functions

Removes dark background from originals, such as newspapers.

If the ground color is obtrusive, select [**Auto**]. If [**Auto**] does not remove the ground color, select [**Manual**] and adjust the density of the ground color.

Item	Description
<b>Off</b>	Does not adjust the ground color.
<b>Auto</b>	Automatically adjusts the background density based on the original.
<b>Manual</b>	Select [1] to [7] (Lighter - Darker) to adjust the background density manually.

## Prevent Bleed-thru



Image Quality



Color/Image Quality



Functions



Functions

Hides background colors and image bleed-through when scanning thin original.

(Value: [Off] / [On])

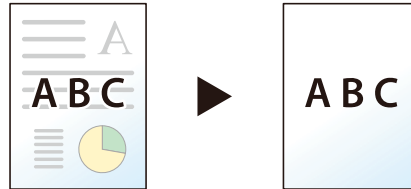

## Contrast



Image Quality



Color/Image Quality



Functions



Functions

You can adjust the contrast between light and dark areas of the image.

Lower

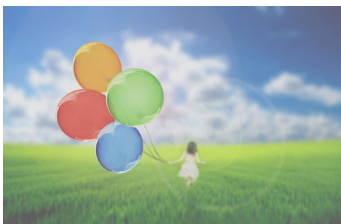

Original

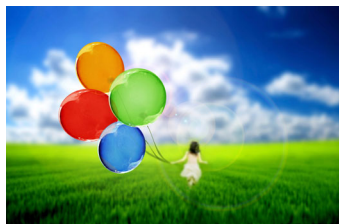

Higher



Item	Description
[+1] to [+4] (Higher)	Increases the sharpness of colors.
[-1] to [-4] (Lower)	Creates smoother colors.

## Erase Colors



Image Quality



Color/Image Quality



Functions



Functions

Erases colors in the source document.

Item	Value	Description
<b>Off</b>		
<b>On</b>	Yellow, Red, Cyan, Magenta, Green, Blue, Black	Select the colors to erase. You can select up to 6 colors.
<b>Color Range</b>	1 (Narrower) to 5 (Wider)	Choose a range of colors to erase. For example, if you specify yellow and select [ <b>5 (Wider)</b> ] from the color range, greens and reds close to yellow will be erased.

**NOTE**If you select only [**Black**], you cannot set the Color Range.

## Continuous Scan



Advanced Setup



Advanced Setup



Functions



Functions

Scans a large number of originals in separate batches and then produce as one job.

(Value: [Off] / [On] / [Job Build])

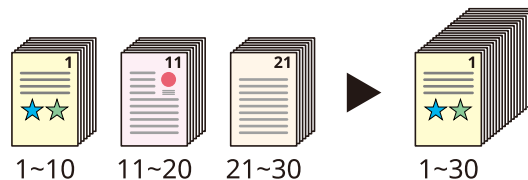



## Job Finish Notice



Advanced Setup



Advanced Setup



Functions



Functions

Sends E-mail notice when a job is complete.

It is also available that send a notice when a job is interrupted.

Users can be notified of the completion of a job while working at a remote desk, saving the time spent waiting beside the machine to finish.

### NOTE

- PC should be configured in advance so that E-mail can be used.

➔ [Command Center RX \(page 2-71\)](#)

- E-mail can be sent to a single destination.
- It will be possible to download the scan data in PC from the stored URL described in the text of the notice E-mail of Job Finish Notice for "Send to Folder (SMB/FTP)" or "Storing Documents to a Custom Box". This is a useful function in case if it is not possible to send/receive a large amount of scan data due to the restriction of the mail attachment file size.

Item	Description
<b>Off</b>	
<b>Address Book</b>	Select the notification destination from the address book.
<b>Address Book</b>	Select the notification destination on the address book screen, then select <b>[OK]</b> .
<b>[... ] (information icon)</b>	Information on the selected destination can be viewed.
<b>Notify when interrupted</b>	Select <b>[On]</b> if you require an e-mail notification when a job is interrupted.
<b>Address Entry</b>	Enter E-mail address directly. Select the entry field, enter the address (up to 256 characters) and select <b>[OK]</b> .
<b>Notify when interrupted</b>	Select <b>[On]</b> if you require an e-mail notification when a job is interrupted.

## File Name Entry



Advanced Setup



Advanced Setup



Functions



Functions

Adds a file name.

Additional information such as job number and date and time can also be set. You can check a job history or job status using the file name, date and time, or job number specified here.

Enter the file name (up to 32 characters).

To add date and time, select **[Date and Time]**. To add job number, select **[Job No.]**. To add both, select **[Job No.] & [Date and Time]** or **[Date and Time] & [Job No.]**.

## Priority Override



Advanced  
Setup



Functions



Functions

Suspends the current job and gives a new job top priority.  
The suspended job resumes after the other job is finished.

(Value: [Off] / [On])



### NOTE

This function is not available if current job was an override.

## Detect Multi-fed Originals



Advanced  
Setup



Advanced  
Setup



Functions



Functions

When reading a document from the document processor, if the multiple feeding of documents is detected, then the reading stops automatically.

Item	Description
On	In case of detecting that multiple sheets of original are fed at the same time, the message is displayed and stop scanning the original.
Off	It does not detect.



### NOTE

This function is displayed when you are using the ECOSYS MA6000ifx/ECOSYS MA5500ifx.

## Detect Bent Corner Originals



Advanced  
Setup



Advanced  
Setup



Functions



Functions

When reading a document from the document processor, if a bent corner is detected, then the reading stops automatically.

Item	Description
On	If a bent corner is detected, a message is displayed to stop reading the original.
Off	It does not detect.

## Skip Blank Page



Advanced  
Setup



Advanced  
Setup



Functions



Functions

When there are blank pages in a scanned document, this function skips the blank pages and prints only pages that are not blank.

Blank pages can be set as pages that include ruled lines and a small number of characters.

The machine detects blank pages, saving unnecessary printing without the need to check for blank pages in the document.

Select **[On]** > **[Detect Item to Skip]**, and select **[Blank Pages + Ruled Lines]**, **[Blank Pages Only]** or **[Blank Pages + Some Text]**.



### NOTE

The originals with punched holes or originals printed on a colored substrate may not be recognized as blank pages.

## Quiet Mode



Advanced  
Setup



Advanced  
Setup



Functions



Functions

Lower print and scan speed for quiet processing.

Select this mode when the running noise is uncomfortable.

It is possible to set the use of Quiet Mode for each function, such as copying and sending.

(Value: **[Off]** / **[On]**)



### NOTE

- The processing speed will be slower than normal when in Quiet Mode.
- This cannot be used when **[Prohibit]** is set for "Specify for Each Job".

➔ [Specify Each Job \(page 8-26\)](#)

## 2-sided



Org./Sending  
Data Format



Functions





Functions

Select the type and orientation of the binding based on the original.

Item		Value	Description
<b>1-sided</b>		—	"2-sided/Book Original" is not set.
<b>2-sided</b>	<b>Binding</b>	Left/Right, Top	Select the binding orientation of originals.
	<b>Original Orientation</b>	Top Edge on Top, Top Edge on Left, Auto <sup>*1</sup>	Select the orientation of the original document top edge to scan correct direction. Select <b>[Original Orientation]</b> to choose orientation of the originals, either <b>[Top Edge on Top]</b> or <b>[Top Edge on Left]</b> .

\*1 This function can only be used when the optional OCR Scan Activation Kit is installed.

## Sample image

Value		Image
2-sided	Binding Left/Right	
	Binding Top	

## Sending Size



Org./Sending  
Data Format



Functions

Select size of image to be sent.

Select [**Same as Original Size**], [**Metric**], [**Inch**], or [**Others**] to select the sending size.

Item	Value	Description
<b>Same as Original Size</b>	—	Automatically sends the same size as the original.
<b>Metric</b>	A4, A5, A6, B5, B6, Folio, 216 × 340 mm	Select from the Metric series standard sizes.
<b>Inch</b>	Letter, Legal, Statement, Executive, Oficio II	Select from the Inch series standard sizes.
<b>Others</b>	16K, ISO B5, Envelope #10, Envelope #9, Envelope #6, Envelope Monarch, Envelope DL, Envelope C5, Hagaki (Cardstock), Oufukuhagaki (Return postcard), Youkei 4, Youkei 2, Youcho 3, Nagagata 3, Nagagata 4	Select from special standard sizes.

### Relationship between Original Size, Sending Size, and Zoom

Original Size, Sending Size, and Zoom are related to each other. For details, see the table below.

Original size and sending size are	the same	different
<a href="#">Original Size (page 6-14)</a>	Specify as necessary.	Specify as necessary.
<b>Sending Size</b>	Select [ <b>Same as Original Size</b> ].	Select the desired size.
<a href="#">Zoom (page 6-19)</a>	Select [ <b>100%</b> ] (or [ <b>Auto</b> ]).	Select [ <b>Auto</b> ].



#### NOTE

When you specify the sending size that is different from the original size, and select the zoom of [**100%**], you can send the image as the actual size (No Zoom).

## Long Original



Org./Sending  
Data Format



Functions

Reads long-sized original documents using a document processor.

(Value: [Off] / [On])



### NOTE

- Long originals are sent in black and white.
- Only a single side of a long original can be scanned. Originals of up to 915 mm / 74.8" long can be scanned.
- A resolution of 300 × 300 dpi or smaller can be selected.

## File Format



Org./Sending  
Data Format



Functions



Functions

Specify the image file format. Image quality level can also be adjusted.

Select the file format from [PDF], [TIFF], [XPS], [JPEG], [OpenXPS], [High Comp. PDF], [Word], [Excel], and [PowerPoint].

When the color mode in scanning has been selected for Grayscale or Full Color, set the image quality.

If you selected [PDF] or [High Comp. PDF], you can specify encryption or PDF/A settings.

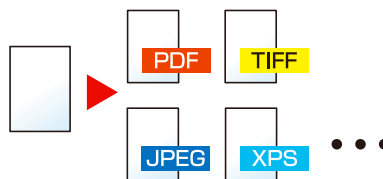

Item	Value	Color mode
PDF <sup>*1*2*3*4</sup>	1 Low Quality (High Comp.) to 5 High Quality (Low Comp.)	Auto Color (Color/Grayscale), Auto Color (Color/Black and White), Full Color, Grayscale, Black and White
TIFF		
XPS		Auto Color (Color/Grayscale), Full Color, Grayscale
JPEG		Auto Color (Color/Grayscale), Auto Color (Color/Black and White), Full Color, Grayscale, Black and White
OpenXPS		
High Comp. PDF <sup>*1*2*3*4</sup>	Compression Ratio Priority, Standard, Quality Priority	Auto Color (Color/Grayscale), Auto Color (Color/Black and White), Full Color, Grayscale
Word <sup>*5</sup>	1 Low Quality (High Comp.) to 5 High Quality (Low Comp.)	Auto Color (Color/Grayscale), Full Color, Grayscale
Excel <sup>*5</sup>		
PowerPoint <sup>*5</sup>		

\*1 You can create Searchable PDF file by running OCR on the scanned document.

➔ [OCR Text Recognition \(Option\) \(page 6-38\)](#)

\*2 Set the PDF/A. (Value: [Off] / [PDF/A-1a] / [PDF/A-1b] / [PDF/A-2a] / [PDF/A-2b] / [PDF/A-2u]).

\*3 Set PDF encryption.

➔ [PDF Encryption Functions \(page 6-39\)](#)

\*4 Set Digital Signature to File.

➔ [PDF Electronic Signature \(page 6-42\)](#)

\*5 Word, Excel and PowerPoint will be saved in a Microsoft Office 2007 or later file format.

➔ [Scan to Office Function \(page 6-41\)](#)

## OCR Text Recognition (Option)

When [PDF], [High Comp. PDF], [Word], [Excel], or [PowerPoint] is selected for the file format, you can create Searchable file by running OCR on the scanned document. Select [OCR Text Recognition], and then [On], select the language of the document, and select [OK].

Item	Description
Off	Do not create Searchable file.
On	Create Searchable file. Select the language to extract from the languages that appear on the touch panel.



### NOTE

- This function can only be used when the optional OCR Scan Activation Kit is installed.
- ➔ [Scan extension kit\(A\) "OCR Scan Activation Kit" \(page 11-7\)](#)
- This function cannot be set when you send from the Custom Box.
- If the proper language is not selected, file creation may take a long time or the creation may fail. The default language can be changed in System Menu.
- ➔ [Primary OCR Language\\*1 \(page 8-28\)](#)
- If you do not set an original in the correct orientation, the text of the document may not be recognized as characters. In addition, it may take some time to create the file. Check the following:
  - The original orientation is correct.
- The accuracy of the text recognition depends on the original condition. The following condition may result in decreasing the recognition accuracy.
  - Repeatedly copied documents (as copied copy)
  - Received faxes (with low resolution)
  - Originals with the character space too narrow or wide
  - Originals with the lines on the text
  - Originals with the special fonts
  - Binding part of the book
  - A handwritten texts

## PDF Encryption Functions

If you have selected PDF or High Comp. PDF for file format, you can restrict the access level for displaying, printing, and editing PDF's by assigning a secure password.

Select **[PDF]** or **[High Comp. PDF]** in **[File Format]**, and select **[Encryption]**.

Items that can be set vary depending on the setting selected in **[Compatibility]**.

### When **[Acrobat 3.0 and later]** is selected

Item	Value	Description
<b>Password to Open Document</b>	Off, On	Enter the password to open the PDF file. Select <b>[On]</b> , enter a password (up to 256 characters). Enter the password again for confirmation.
<b>Password to Edit/Print Document</b>	Off, On	Enter the password to edit the PDF file. Select <b>[On]</b> , enter a password (up to 256 characters). Enter the password again for confirmation. When you have entered the password to edit/print document, you can specifically limit the operation.
<b>Printing Allowed</b>	Not Allowed, Allowed	Restricts printing of the PDF file.
<b>Changes Allowed</b>	Not Allowed	Disables the change to the PDF file.
	Commenting	Can only add commenting.
	Page Layout except extracting Pages	Can change the page layout except extracting the pages of the PDF file.
	Any except extracting Pages	Can conduct all operations except extracting the pages of the PDF file.
<b>Copying of Text/Images/Others</b>	Disable, Enable	Restricts the copying of text and objects on the PDF file.

**When [Acrobat 5.0 and later] is selected**

Item	Value	Description
<b>Password to Open Document</b>	Off, On	Enter the password to open the PDF file. Select [ <b>On</b> ], enter a password (up to 256 characters). Enter the password again for confirmation.
<b>Password to Edit/Print Document</b>	Off, On	Enter the password to edit the PDF file. Select [ <b>On</b> ], enter a password (up to 256 characters). Enter the password again for confirmation. When you have entered the password to edit/print document, you can specifically limit the operation.
<b>Printing Allowed</b>	Not Allowed	Disables the printing of PDF file.
	Allowed (Low Resolution only)	Can print the PDF file only in low resolution.
	Allowed	Can print the PDF file in original resolution.
<b>Changes Allowed</b>	Not Allowed	Disables the change to the PDF file.
	Inserting/Deleting/Rotating Pages	Can only insert, delete, and rotate the pages of the PDF file.
	Commenting	Can only add commenting.
	Any except extracting Pages	Can conduct all operations except extracting the pages of the PDF file.
<b>Copying of Text/Images/Others</b>	Disable, Enable	Restricts the copying of text and objects on the PDF file.



## Scan to Office Function

This machine provides the function which converts scanned documents including text, figures and pictures into searchable and editable Microsoft Office (Word, Excel and PowerPoint) 2007 or later data format, via OCR processing.

### NOTE

- This function can only be used when the optional OCR Scan Activation Kit is installed.
- ➔ [Scan extension kit\(A\) "OCR Scan Activation Kit" \(page 11-7\)](#)
- The scanned result may not be realized perfectly according to condition of the documents.

## 1 Display the screen.

- 1 **[Home]** key > **[Send]** > **[Org./Sending Data Format]** > **[File Format]**

## 2 Configure the settings.

- 1 Select **[Word]**, **[Excel]** or **[PowerPoint]** as a file format.
- 2 Select **[OCR Text Recognition]** > **[On]**.

### NOTE

When you select **[Off]**, the documents are converted into the Microsoft Office data (scanned image).

- 3 Select the language of the document which you wish to scan > **[OK]**.
- 4 Select **[OCR Output Format]** and select an OCR output mode from the table below > **[OK]**.

Item	Description
<b>Text + Graphics</b>	Converts the scanned documents into the editable and searchable Microsoft Office data format.
<b>Text + Graphics with Scanned Image</b>	Converts the scanned documents into two types of data: one is the editable and searchable Microsoft Office data format and the other one is the Microsoft Office data format with scanned image. You can edit text and layout of the editable data by referring the scanned image.
<b>Scanned Image with Searchable Text</b>	Converts the scanned documents into the searchable Microsoft Office data format (scanned image).

## 3 Press the **[Start]** key.

## PDF Electronic Signature

If [PDF] or [High Comp. PDF] is selected as a file format, electronic signature can be added to the PDF to be sent. Electronic signature can certify a sender of document and prevent falsification. To use this function, it is required to register a signing certificate from Command Center RX or KYOCERA Net Viewer and enable digital signature to files from the system menu. In this manual, a procedure to register a signing certificate from Command Center RX is described as an example.

### NOTE

- This function appears when [Specify Each Job] is selected for "Digital Signature to File" in the system menu.
- ➔ [Digital Signature \(page 8-30\)](#)
- This function can be configured when [OFF], [PDF/A-2a], [PDF/A-2b], or [PDF/A-2u] is selected in PDF/A.
- To register a signing certificate from KYOCERA Net Viewer, refer to the following.
- ➔ [KYOCERA Net Viewer User Guide](#)

## 1 Access Command Center RX.

- ➔ [Accessing Command Center RX \(page 2-72\)](#)

## 2 Register a signing certificate to be used in the electronic signature addition setting.

- 1 Click [Common/Job Default] in the [Function Settings] menu.
- 2 Click [Settings] from [File Default Settings] > [Signing Certificate] to create, import, or acquire a device certificate.

- ➔ [Command Center RX User Guide](#)

- 3 Click [Restart/Reset] > [Restart Device] to restart the device.

## 3 Configure the digital signature settings.



- 1 [Home] key > [...] > [System Menu] > [Function Settings] > [Send/Store] > [Digital Signature to File]

### NOTE

If the User Authentication screen appears, log in with a user who has the privilege to configure this setting. If you do not know your login User Name or Password, please contact your Administrator.

## 2 Configure the digital signature addition settings.

Configurable items are as follows.

Item	Description
<b>Digital Signature</b>	Select whether to add a digital signature. <b>Value:</b> <b>Off:</b> Does not add a digital signature. <b>Specify Each Job:</b> Whether to add a digital signature is selected each time of sending. <b>On:</b> Always adds a digital signature when sending.
<b>Digital Signature Format</b>	Select an algorithm used for encryption of digital signature. <b>Value:</b> SHA1, SHA-256, SHA-384, SHA-512  <b>NOTE</b> This function is displayed when "Digital Signature" is set to <b>[Specify Each Job]</b> or <b>[On]</b> .
<b>Password Confirmation on Signature Permission</b>	Select whether to confirm password when setting digital signature. <b>Value:</b> On, Off  <b>NOTE</b> This function is displayed when "Digital Signature" is set to <b>[Specify Each Job]</b> .
<b>Password</b>	Set a password required for setting digital signature. Enter a new security password 6 to 16 alphanumeric characters and symbols.  <b>NOTE</b> This function is displayed when "Password Confirmation on Signature Permission" is set to <b>[On]</b> .

## 4 Navigate to display the screen.

[Home] key > [Send] > [Org./Sending Data Format] > [File Format]

## 5 Enable the function.

- 1 Select [PDF] or [High Comp. PDF] as a file format.
- 2 From "Digital Signature", select [On] > [OK] in order.



### NOTE

If "Password Confirmation on Signature Permission" is set to **[On]**, a password input screen appears. Enter a password set in the system menu.

➔ [Password \(page 8-30\)](#)

## 6 Press the [Start] key.

## File Separation



Org./Sending  
Data Format



Functions



Functions

Creates several files by dividing scanned original data page by specified number of pages, and sends the files.  
(Value: [Off] / [Each Page])



### NOTE

A three-digit serial number such as "abc\_001.pdf, abc\_002.pdf.." is attached to the end of the file name.

## Scan Resolution



Color/Image  
Quality



Functions



Functions

Select fineness of scanning resolution.

(Value: [600 × 600dpi] / [400 × 400dpi Ultra fine] / [300 × 300dpi] / [200 × 400dpi Super fine] / [200 × 200dpi Fine] / [200 × 100dpi Normal])

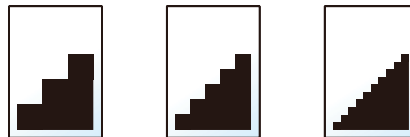

### NOTE

The larger the number, the better the image resolution. However, better resolution also means larger file sizes and longer send times.

## Clarify Text (Noise Removal)



Color/Image  
Quality



Functions

When scanning and sending a document in black and white, it eliminates background noise and improves the legibility of the text.

Value: [Off] / [On]

## Email Subject/Body



Advanced  
Setup



Functions

Adds subject and body when sending a document.

Select [**Subject**] / [**Body**] to enter the Email subject/body.

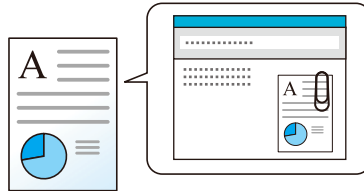

### NOTE

- The subject can include up to 256 characters, and the body can include up to 500 characters.
- Set the subject and body automatically entered (default subject and body) when sending the scanned originals by E-mail.

➔ [Email Subject/Body \(page 8-28\)](#)

## FTP Encrypted TX



Advanced  
Setup



Functions

Encrypts images when sending via FTP.

Encryption secures the document transmission.

(Value: [Off] / [On])

### NOTE

Click [**Security Settings**], and then [**Network Security**] in the Command Center RX. Be sure that "SSL" of Secure Protocol Settings is "On" and one or more effective encryption are selected in Client side settings.

➔ **Command Center RX User Guide**

## Email Encrypted TX



Advanced  
Setup



Functions

Sends encrypted E-mail using the electronic certificate.

Encryption secures the document transmission.

(Value: [Off] / [On])



### NOTE

To use this function, configure the certificate, protocol and email function in the Command Center RX.

➔ [Configuring S/MIME settings in the Command Center RX \(page 6-46\)](#)

## Digital Signature Email



Advanced  
Setup



Functions

Add a digital signature to the email, using the electronic certificate.

By adding a digital signature to an email, you can confirm the identity of the destination and detect tampering during transmission.

(Value: [Off] / [On])



### NOTE

To use this function, configure the certificate, protocol and email function in the Command Center RX.

➔ [Configuring S/MIME settings in the Command Center RX \(page 6-46\)](#)

### Configuring S/MIME settings in the Command Center RX

#### 1 Access to the Command Center RX

➔ [Accessing Command Center RX \(page 2-72\)](#)

#### 2 Register the device certificate which is used for S/MIME.

- 1 From the [Security Settings] menu, click [Certificates].
- 2 Click [Settings] of [Device Certificate] (1 to 5) to create or import the device certificate.
  - ➔ **Command Center RX User Guide**
- 3 Click [Restart/Reset] and then [Restart Device] to restart the machine.

#### 3 Configure the protocol settings

- 1 From the [Network Settings] menu, click [Protocol].
- 2 Set [SMTP (E-mail TX)] and [S/MIME] to [On] in Send Protocols.
- 3 Click [Submit].

## 4 Configure the E-mail function.

- 1 From the [**Function Settings**] menu, click [**E-mail**].
- 2 Configure the settings in "S/MIME" as necessary.
  - ▶ **Command Center RX User Guide**
- 3 Click [**Submit**].

## 5 Link the E-mail address with S/MIME certificates

- 1 From the [**Address Book**] menu, click [**Machine Address Book**].
- 2 Click the contact's [**Number**] or [**Name**] you want to edit.
- 3 Click [**Settings**] on "S/MIME Certificate".
- 4 Click [**Import**] on the required certificate to register it, and then click [**Submit**].
- 5 Click [**OK**].

## Delete after Printed



Functions

Automatically deletes a document from the box once printing is complete.

(Value: [Off] / [On])

## Delete after Transmitted



Functions

Automatically deletes a document from the box once transmission is complete.

(Value: [Off] / [On])

## Storing Size



Select size of image to be stored.

Select [**Same as Original Size**], [**Metric**], [**Inch**], or [**Others**] to select the storing size.

Item	Value	Description
<b>Same as Original Size</b>	—	Automatically sends the same size as the original.
<b>Metric</b>	A4, A5, A6, B5, B6, Folio, 216 × 340 mm	Select from the Metric series standard sizes.
<b>Inch</b>	Letter, Legal, Statement, Executive, Oficio II	Select from the Inch series standard sizes.
<b>Others</b>	16K, ISO B5, Envelope #10, Envelope #9, Envelope #6, Envelope Monarch, Envelope DL, Envelope C5, Hagaki (Cardstock), Oufukuhagaki (Return postcard), Youkei 4, Youkei 2, Youcho 3, Nagagata 3, Nagagata 4	Select from special standard sizes.

### Relationship between Original Size, Storing Size, and Zoom

Original Size, Storing Size, and Zoom are related to each other. For details, see the table below.

Original Size and the size you wish to store as are	the same	different
<a href="#">Original Size (page 6-14)</a>	Specify as necessary.	Specify as necessary.
<b>Storing Size</b>	Select [ <b>Same as Original</b> ].	Select the desired size.
<a href="#">Zoom (page 6-19)</a>	Select [ <b>100%</b> ] (or [ <b>Auto</b> ]).	Select [ <b>Auto</b> ].

#### NOTE

When you select Storing Size that is different from Original Size, and select the Zoom [100%], you can store the image as the actual size (No Zoom).

## Encrypted PDF Password



Enter the preassigned password to print the PDF data.

Enter the Password, and select [**OK**].

#### NOTE

For details on entering the password, refer to the following:

➔ [Character Entry Method \(page 11-10\)](#)



## JPEG/TIFF Print



Select the image size when printing JPEG or TIFF files.

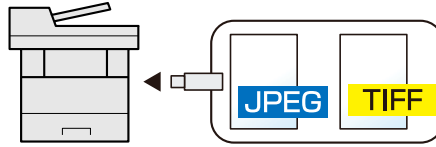

Item	Description
<b>Paper Size</b>	Fits the image size to the selected paper size.
<b>Image Resolution</b>	Prints at resolution of the actual image.
<b>Print Resolution</b>	Fits the image size to the print resolution.

## XPS Fit to Page



Reduces or enlarges the image size to fit to the selected paper size when printing XPS file.

(Value: [Off] / [On])

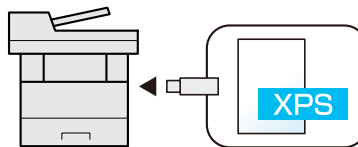

# 7 Status/Job Cancel

This chapter explains the following topics:

Checking Job Status .....	7-2
Details of the Status Screens .....	7-3
Checking Detailed Information of Jobs .....	7-8
Checking Job History .....	7-9
Checking the Detailed Information of Histories .....	7-10
Sending the Log History .....	7-10
Job Operation .....	7-11
Pause and Resumption of Jobs .....	7-11
Canceling of Jobs .....	7-11
Device Information .....	7-12
Check the remaining amount of toner and paper, and the condition of the unit .....	7-14

# Checking Job Status

Check the status of jobs being processed or waiting to be printed.

## Available Status Screens

The processing and waiting statuses of jobs are displayed as a list on the touch panel in four different screens - Printing Jobs, Sending Jobs, Storing Jobs, and Scheduled Jobs.

The following job statuses are available.

Status Display	Job status to be displayed
Print Job Status	<ul style="list-style-type: none"> <li>• Copy</li> <li>• Printer</li> <li>• Printing from Document Box</li> <li>• Fax reception</li> <li>• Email reception</li> <li>• Printing data from USB Drive</li> <li>• Application</li> <li>• Job Report/List</li> </ul>
Send Job Status	<ul style="list-style-type: none"> <li>• Email</li> <li>• Folder transmission</li> <li>• Fax transmission</li> <li>• Sending Job - Fax Server</li> <li>• Application</li> <li>• Multiple destination</li> </ul>
Store Job Status	<ul style="list-style-type: none"> <li>• Scan</li> <li>• Fax</li> <li>• Printer</li> <li>• Join Box Document</li> <li>• Copy Box Document</li> </ul>
Scheduled Job	<ul style="list-style-type: none"> <li>• Sending Job FAX using Delayed transmission</li> </ul>

## Displaying Status Screens

### 1 Display the screen.

Select the **[Status/Job Cancel]** key.

### 2 Select the job you want to check.

Select either of **[Print Jobs]**, **[Send Jobs]**, or **[Store Jobs]** to check the status.

Select **[Send Jobs]** > **[Scheduled Job]** to check delayed transmission.

- ➔ [Print Jobs Screen \(page 7-3\)](#)
- [Send Jobs screen \(page 7-5\)](#)
- [Store Jobs screen \(page 7-6\)](#)
- [Scheduled Job Screen \(page 7-7\)](#)







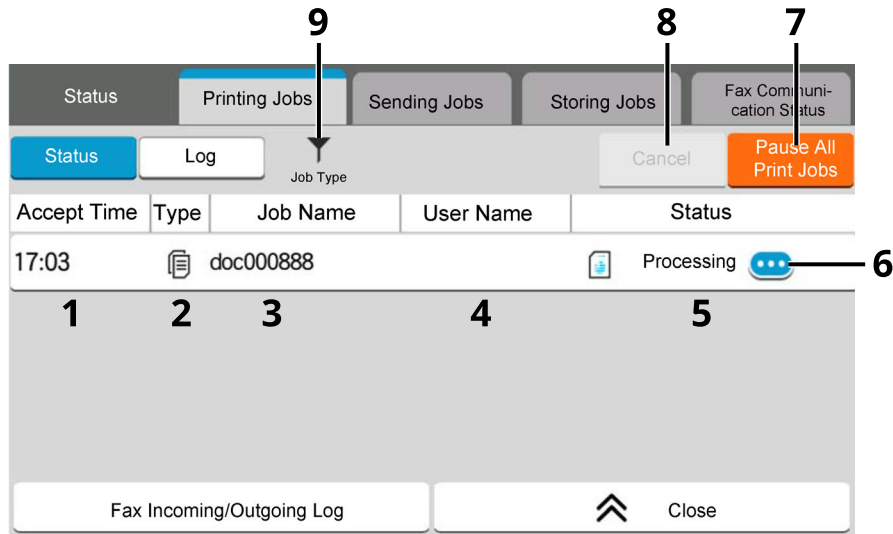

## Details of the Status Screens



 **NOTE**

- You can show the job statuses of all users, or only the statuses of your own jobs.
- ➔ [Job Status/Job Logs Settings \(page 8-37\)](#)
- This setting can also be changed from Command Center RX.
- ➔ **Command Center RX User Guide**

### Print Jobs Screen



No.	Item	Description
1	Accepted Time	Accepted Time of job
2	Type	Icons that indicate the job type  Copy job  Printer job  Job from Document Box  Fax reception  Email reception  Data from USB Drive  Application  Report/List
3	Job Name	Job Name or file name
4	User Name	User Name for the executed job

No.	Item	Description
5	Status	Status of job InProcess: The status before starting to print. Printing: Printing Waiting: Print Waiting Pause: Pausing print job or error Canceling: Canceling the job
6	[  ] (information icon)	Select the icon of the job whose detailed information you want to display. ➔ <a href="#">Checking Detailed Information of Jobs (page 7-8)</a> You can select [  ] (information icon) in “Copies” in the detailed information screen to change the number of copies that are printed.
7	[Pause All Print Jobs]	Pauses all the printing jobs. By pressing this key again, the printing jobs will be resumed.
8	[Cancel]	Select the job you want to cancel from the list, and select this key.
9	[Job Type]	Only selected type of jobs is displayed.



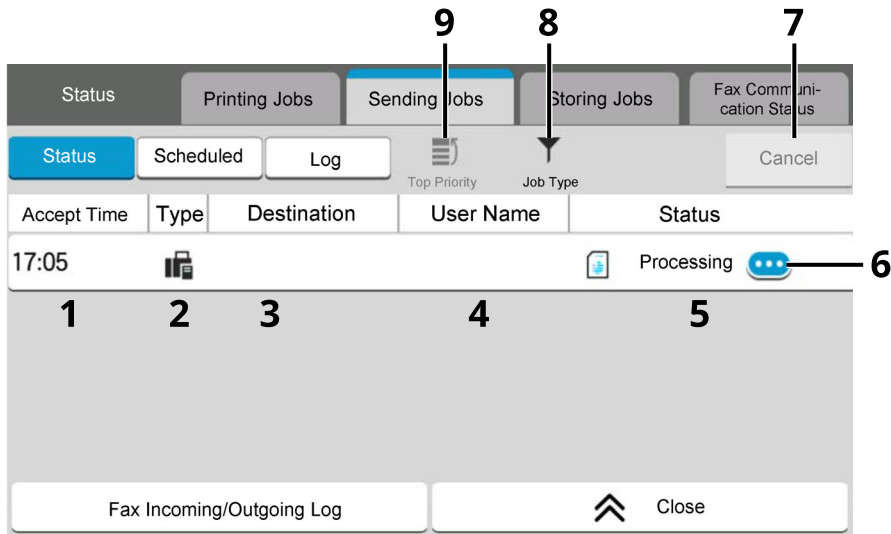



## Send Jobs screen

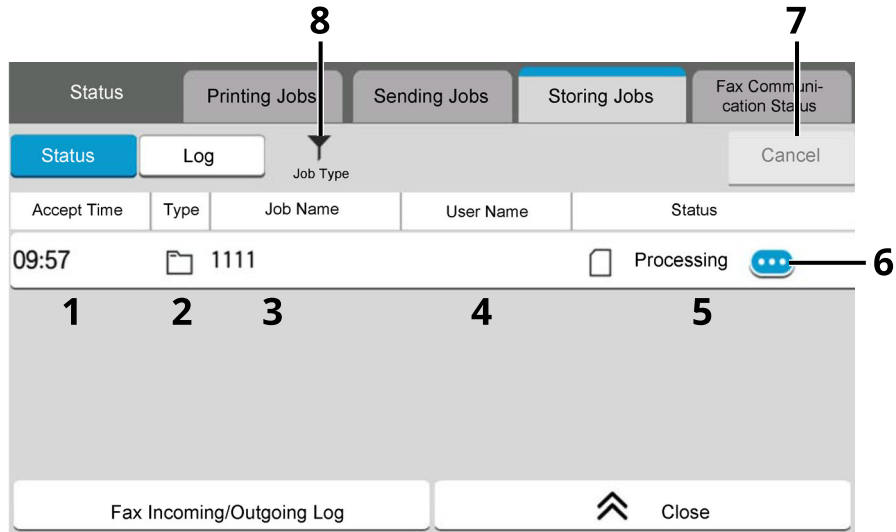

No.	Item	Description
1	Accepted Time	Accepted Time of job
2	Type	Icons that indicate the job type Sending Job Email Sending Job Folder Sending Job Fax Sending Job iFax Sending Job - Fax Server Sending Job Application Multi Sending
3	Destination	Destination (Either destination name, Fax number, Email address, or server name)
4	User Name	User Name for the executed job
5	Status	Status of job InProcess: The status before starting sending such as during scanning originals Sending: Sending Waiting: Waiting Sending Canceling: Canceling the job Pause: Pausing the job
6	[] (information icon)	Select the icon of the job whose detailed information you want to display. <a href="#">▶ Checking Detailed Information of Jobs (page 7-8)</a>
7	[Cancel]	Select the job you want to cancel from the list, and select this key.
8	[Job Type]	Only selected type of jobs is displayed.
9	[TOP Priority]	Select the job to be overridden, and select this key. Only displayed when the optional fax kit is installed.



## Store Jobs screen

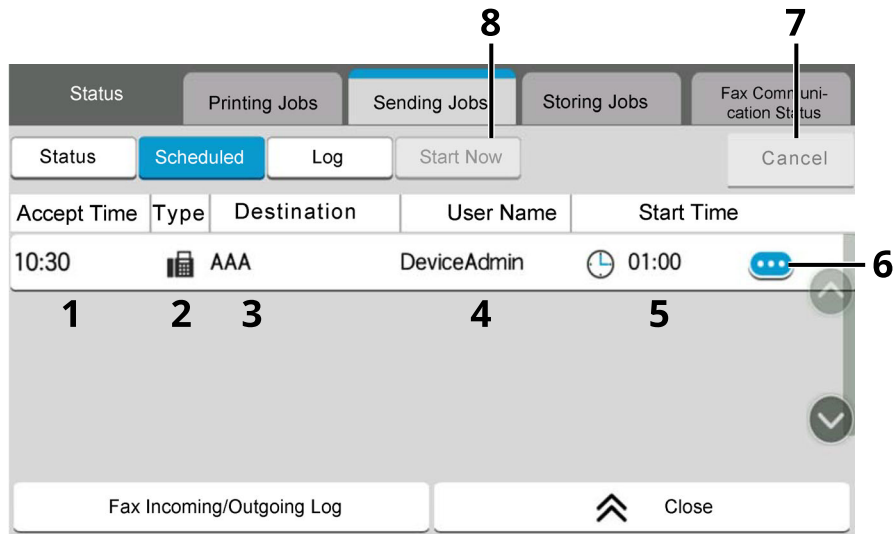

No.	Item	Description
1	Accepted Time	Accepted Time of job
2	Type	Icons that indicate the job type  Storing Job Scan  Storing Job Fax  Storing Job Printer  Join Box Document  Copy Box Document
3	Job Name	Job name or file name is displayed.
4	User Name	User Name for the executed job
5	Status	Status of job InProcess: The status before starting to save such as during scanning originals Storing: Storing Data Canceling: Canceling the job Pause: Pausing the job
6	[  ] (information icon)	Select the icon of the job whose detailed information you want to display. <a href="#">▶ Checking Detailed Information of Jobs (page 7-8)</a>
7	[Cancel]	Select the job you want to cancel from the list, and select this key.
8	[Job Type]	Only selected type of jobs is displayed.

## Scheduled Job Screen



No.	Item	Description
1	Accepted Time	Accepted Time of job
2	Type	Icons that indicate the job type  Scheduling Job Fax
3	Destination	Destination (Either destination name, FAX number, or No. of broadcast items)
4	User Name	User Name for the executed job
5	Start Time	Time to start the scheduled job
6	[  ] (information icon)	Select the icon of the job whose detailed information you want to display. <a href="#">➔ Checking Detailed Information of Jobs (page 7-8)</a>
7	[Cancel]	Select the job you want to cancel from the list, and select this key.
8	[Start Now]	Select the job you want to send immediately from the list, and select this key.



## Checking Detailed Information of Jobs

### 1 Display the screen.



➔ [Details of the Status Screens \(page 7-3\)](#)

### 2 Check the information.

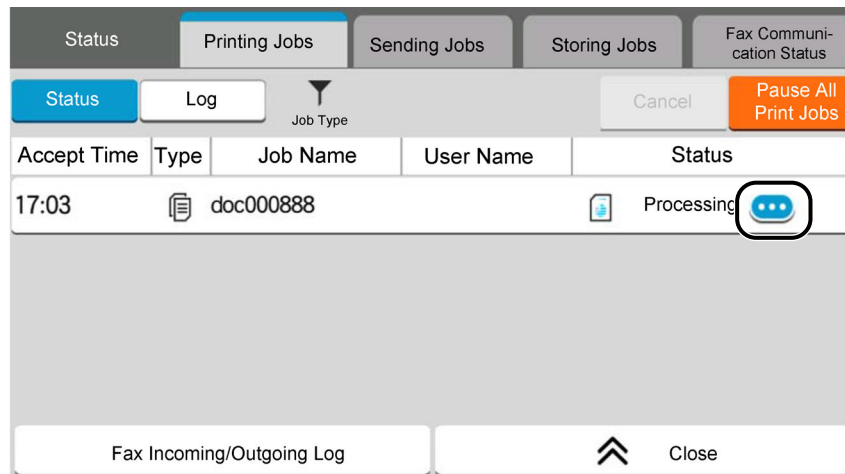
1 Select [  ] (information icon) for the job for which you wish to display detailed information.



Detailed information of the selected job is displayed.

In Sending Jobs, you can check the destination by selecting [  ] (information icon) in "Result/Destination". Select [  ] (information icon) for the destination to display detailed information.

2 To exit from the detailed information, select [**Close**].

# Checking Job History

 **NOTE**

- Job history is also available by Command Center RX or KYOCERA Net Viewer from the computer.
- ➔ **Command Center RX User Guide**
- ➔ **KYOCERA Net Viewer User Guide**
- You can show the job log of all users, or only your own job log.
- ➔ [Job Status/Job Logs Settings \(page 8-37\)](#)
- This setting can also be changed from Command Center RX.
- ➔ **Command Center RX User Guide**

## Available Job History Screens

The job histories are displayed separately in three screens - Printing Jobs, Sending Jobs, and Storing Jobs. The following job histories are available.

Screen	Job histories to be displayed
Print Job Log	<ul style="list-style-type: none"> <li>• Copy</li> <li>• Printer</li> <li>• Printing from Document Box</li> <li>• Fax reception</li> <li>• Email reception</li> <li>• Printing data from USB Drive</li> <li>• Application</li> <li>• Job Report/List</li> </ul>
Send Job Log	<ul style="list-style-type: none"> <li>• Email</li> <li>• Folder</li> <li>• Fax</li> <li>• Fax Server</li> <li>• Application</li> <li>• Multiple destination</li> </ul>
Store Job Log	<ul style="list-style-type: none"> <li>• Scan</li> <li>• Fax</li> <li>• Printer</li> <li>• Join Box Document</li> <li>• Copy Box Document</li> </ul>

## Displaying Job History Screen

### 1 Display the screen.

Select the [Status/Job Cancel] key.

### 2 Select the job to check details.

Select the [Log] tab, and select the job to check details from the list.

## Checking the Detailed Information of Histories

### 1 Display the screen.

➔ [Displaying Job History Screen \(page 7-10\)](#)

### 2 Check the information.

1 Select [⋮] (information icon) for the job you want to check.

Status		Printing Jobs	Sending Jobs	Storing Jobs	Fax Communication Status
Status	Log	Job Type			
End Date	Type	Job Name	User Name	Result	
11/02 15:20	📄	doc0000052021110 2151930		!	Error
11/02 15:17	📄	doc0000042021110 2151658		OK	Completed
11/02 11:12	📄	doc0000022021110 2111201	DeviceAdmin	OK	Completed
11/02 11:06	📄	doc0000012021110 2110551	DeviceAdmin	OK	Completed

Fax Incoming/Outgoing Log ⏪ Close

Detailed information of the selected job is displayed.

2 To exit from the detailed information, select [Close].

## Sending the Log History

You can send the log history by E-mail. You can either send it manually as needed or have it sent automatically whenever a set number of jobs is reached.

➔ [Send Log History \(page 8-24\)](#)

# Job Operation

## Pause and Resumption of Jobs

Pause/resume all printing jobs in printing/waiting.

### 1 Display the screen.

Select the [Status/Job Cancel] key.

### 2 Select [Pause All Print Jobs] on the printing jobs status screen.

Printing is paused.

When resuming the printing of jobs that have been paused, select [Resume All Print Jobs].

## Canceling of Jobs

A job in printing/waiting status can be canceled.

### 1 Display the screen.

Select the [Status/Job Cancel] key.

### 2 Select the job to be canceled from the list, and select [Cancel].

### 3 Select [Yes] in the confirmation screen.

# Device Information

Configure the devices/lines installed or connected to this machine or check their status.

## 1 Display the screen.

1 Select the [**Home**] key.

2 Select [**Device Information**].

The screen to check the status or configure the devices is displayed.

## 2 Check the Information.

The items you can check are described below.

### Identification/Wired Network

You can check ID information such as the model name, serial number, host name and location, and the IP address of the wired network.

### Wi-Fi

You can check the status of Wi-Fi connection, such as the device name, network name and IP address.



#### NOTE

Displayed when the optional Wireless Network Interface Kit is installed.

### Supplies/Unit Status

You can check the remaining amount of toner, and paper.

➔ [Check the remaining amount of toner and paper, and the condition of the unit \(page 7-14\)](#)

### Fax

You can check the local fax number, local fax name, local fax ID and other fax information.

➔ **FAX Operation Guide**



#### NOTE

Displayed only on products with the fax function installed.

### USB/Bluetooth

You can check the connection status of USB drive and Bluetooth keyboard.

- Select [**Format**] for "USB Drive" to format external media.



#### IMPORTANT

**When [Format] is selected, all data in the USB drive is erased.**

- Select [**Remove**] for "USB Drive" to safely remove the external media.
- Select "Bluetooth" [**Connect**] to set the Bluetooth keyboard connection.

### Option/Application

You can check information on the options and applications that are used.

### Capability/Software Version

You can check the software version and performance.

### Security

You can check the security information on the machine.

**Report**

You can print various reports and lists.

**Remote Operation Status**

You can check the situation of remote operation.

# Check the remaining amount of toner and paper, and the condition of the unit

On the touch panel, you can check the presence of toner and paper, as well as the remaining life of the unit.

## 1 Display the screen.

- 1 Select the **[Home]** key.
- 2 Select **[Device Information]**.
- 3 Select **[Supplies/Unit Status]**.

## 2 Check the Information.

The items you can check are described below.

### **Toner Information**

The amount of toner remaining is shown in levels. And you can check the status of waste toner box.

### **Paper Status**

You can check the size, orientation, type, and remaining amount of paper in each paper source. The amount of paper remaining is shown in levels.

### **Condition of the unit**

Displays the time remaining on the Developer Unit, the Document Processor, and the Cassette.

# 8 Setup and Registration (System Menu)

This chapter explains the following topics:

System Menu .....	8-2
Operation Method .....	8-2
System Menu Settings .....	8-4
Device Settings .....	8-7
Notification/Report .....	8-21
Function Settings .....	8-25
Network Settings .....	8-39
Security Settings .....	8-55
Job Accounting/Authentication .....	8-61
Add/Delete Application .....	8-61
Adjustment/Maintenance .....	8-62



# System Menu

Configure settings related to overall machine operation.

## Operation Method

System Menu is operated as follows:

### 1 Display the screen.

Select the [Home] key > [...] > [System Menu].

### 2 Select a function.

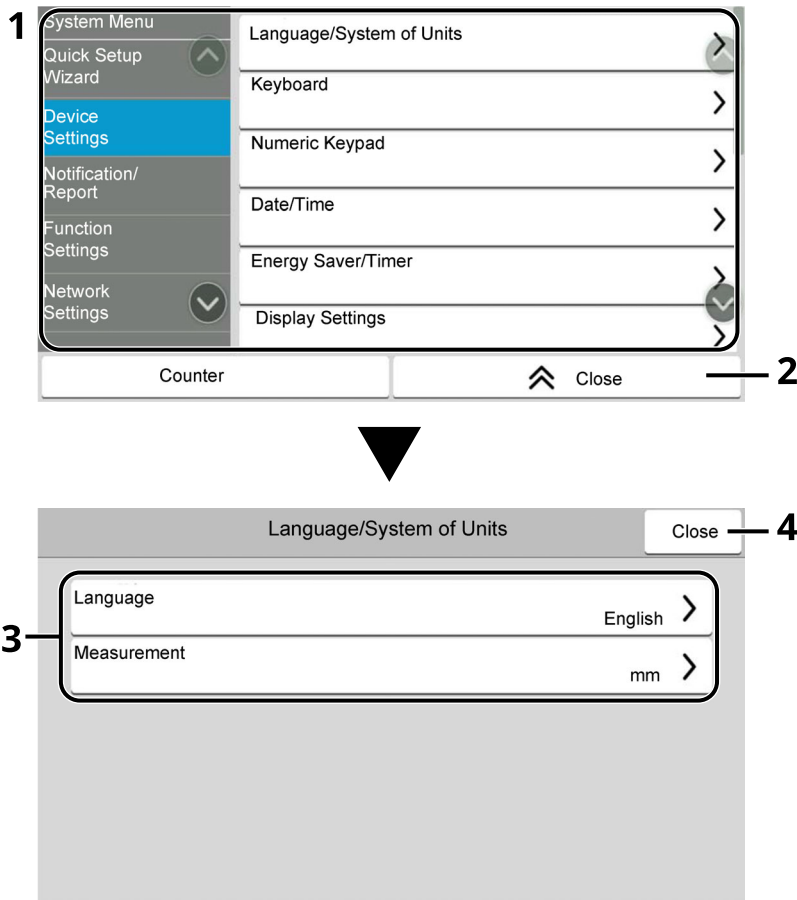

- 1 Displays the System Menu items. Items that are not displayed can be displayed by swiping the screen up and down.
- 2 Returns to the previous screen.
- 3 Displays setting items.  
Select the key of a function to display the setting screen.
- 4 Returns to the previous screen.

### 3 Configure the function.

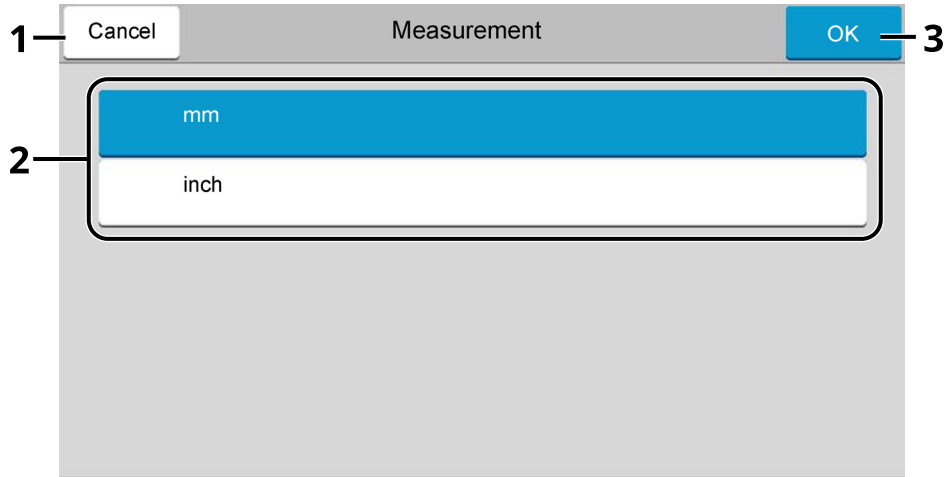

- 1 Returns to the previous screen without making any changes.
- 2 Returns to the previous screen without making any changes.
- 3 Accepts the settings and exits.

#### NOTE

- If the User Authentication screen appears, log in with a user who has the privilege to configure this setting. If you do not know your login User Name or Password, please contact your Administrator.
- If function default settings have been changed, the **[Reset]** key can be selected in each function screen to immediately change the settings.

## System Menu Settings

This section explains the functions that can be configured in System Menu. To configure the settings, select the item in System Menu and select the setting item. For details on each function, see the table below.

Item	Description	Reference Page
<b>Quick Setup Wizard</b>	The Quick Setup Wizard configures Fax, Energy Saver, Network, E-mail and Security Setup.	<a href="#">page 2-49</a>
<b>Device Settings</b>	Configure overall machine operation.	<a href="#">page 8-7</a>
<b>Language/System of Units</b>	Set the language to use for the touch panel display, and select inch or metric for the unit for paper dimensions.	<a href="#">page 8-7</a>
<b>Keyboard</b>	Change the layout of the touch panel keyboard used to enter characters.	<a href="#">page 8-7</a>
<b>Numeric Keypad</b>	Select whether or not to display the numeric keypad.	<a href="#">page 8-7</a>
<b>Date/Time</b>	Configures settings related to the date and time.	<a href="#">page 8-7</a>
<b>Energy Saver/Timer</b>	Configure the Energy Saver settings.	<a href="#">page 8-8</a>
<b>Display Settings</b>	Configure the touch panel display settings.	<a href="#">page 8-10</a>
<b>Sound</b>	Set options for buzzer sound during the machine operations.	<a href="#">page 8-11</a>
<b>Original/Scan Settings</b>	Configure settings for originals.	<a href="#">page 8-11</a>
<b>Paper Feeding</b>	Configure the paper and paper source settings.	<a href="#">page 8-13</a>
<b>Function Key Assignment</b>	Assign a function to each function key.	<a href="#">page 8-19</a>
<b>Operation Assist</b>	It is possible to configure the settings for the Orientation Selection screen display and the Preset Limit on the number of copies that can be made at one time.	<a href="#">page 8-19</a>
<b>Error Handling</b>	Select whether to cancel or continue the job when error has occurred.	<a href="#">page 8-19</a>
<b>Toner Settings</b>	Configure the toner settings.	<a href="#">page 8-20</a>
<b>Notification/Report</b>	Print reports to check the machine settings, status, and history. Settings for printing reports can also be configured.	<a href="#">page 8-21</a>
<b>Printing Report/List</b>	Print various reports and lists.	<a href="#">page 8-21</a>
<b>Result Report Setting</b>	Configure settings for notices for sending and receiving.	<a href="#">page 8-22</a>
<b>Device Status Notification</b>	Configure settings for toner notices.	<a href="#">page 8-23</a>
<b>Fax Communication Report</b>	Configure settings for FAX notices.	<a href="#">page 8-23</a>
<b>History Settings</b>	Configure settings for printing the history of the machine use.	<a href="#">page 8-24</a>

Item	Description	Reference Page
<b>Function Settings</b>	Configures settings for copying, sending and Document Box functions.	<a href="#">page 8-25</a>
<b>Function Defaults</b>	Defaults are the values automatically set after the warm-up is completed or the <b>[Reset]</b> key is selected. Set the defaults for available settings such as copying and sending. Setting the frequently-used values as defaults makes subsequent jobs easier.	<a href="#">page 8-25</a>
<b>Copy/Print</b>	Configures settings for copying and printing functions.	<a href="#">page 8-28</a>
<b>Send/Store</b>	Configures settings for sending and storing functions.	<a href="#">page 8-29</a>
<b>Email</b>	Configure settings for email transmission and receipt.	<a href="#">page 8-31</a>
<b>Sending Job - Folder</b>	Configures settings for Sending Job Folder functions.	<a href="#">page 8-31</a>
<b>Fax</b>	Configures settings for fax functions. ➔ <b>FAX Operation Guide</b>	—
<b>WSD</b>	Configure settings for WSD Scan and WSD Print.	<a href="#">page 8-32</a>
<b>Address Book</b>	Configures Address Book settings.	<a href="#">page 8-32</a>
<b>One-Touch Key</b>	Configures One Touch Key settings.	<a href="#">page 8-32</a>
<b>Send and Forward</b>	Select whether to forward the original to another destination when sending images.	<a href="#">page 8-33</a>
<b>Transfer Settings</b>	Configures settings for RX/Forward rules and Fax Box.	<a href="#">page 8-33</a>
<b>Printer</b>	Printing from computers, settings are generally made on the application software screen. However, the following settings are available for configuring the defaults to customize the machine.	<a href="#">page 8-33</a>
<b>Document Box</b>	Configure settings for Custom Box.	<a href="#">page 8-36</a>
<b>Job Box</b>	Configure settings for Job Box.	<a href="#">page 8-36</a>
<b>Subaddress Box</b>	Displays the Fax Box screen. For details, refer to the following: ➔ <b>FAX Operation Guide</b>	—
<b>Fax Memory RX Box</b>	Set whether to perform Print Immediately for the fax documents received or to save them in the Fax Memory RX Box. ➔ <b>FAX Operation Guide</b>	—
<b>Home</b>	Configure settings for Home screen.	<a href="#">page 8-37</a>
<b>Status</b>	Configure settings for Status.	<a href="#">page 8-37</a>
<b>Remote Services</b>	Configures remote services settings.	<a href="#">page 8-37</a>
<b>TWAIN/WIA</b>	Configures TWAIN/WIA settings.	<a href="#">page 8-38</a>

Item	Description	Reference Page
<b>Network Settings</b>	Configures network settings.	<a href="#">page 8-39</a>
<b>Network Settings</b>	Configure the wired network and Wi-Fi settings.	<a href="#">page 8-39</a>
<b>Optional Network</b>	Configure settings for the optional Network Interface Kit or Wireless Network Interface Kit.	<a href="#">page 8-51</a>
<b>Connectivity</b>	Configure the Connectivity settings of this machine to other devices.	<a href="#">page 8-54</a>
<b>Others</b>	Configure other network related settings.	<a href="#">page 8-55</a>
<b>Security Settings</b>	Configures security settings.	<a href="#">page 8-55</a>
<b>Security Quick Setup</b>	The Security Level setting is primarily a menu option used by service personnel for maintenance work. There is no need for customers to use this menu.	<a href="#">page 8-57</a>
<b>Interface Block Setting</b>	This allows you to protect this machine by blocking the interface with external devices such as USB hosts or optional interfaces.	<a href="#">page 8-56</a>
<b>Device Security Settings</b>	Configures the device security settings.	<a href="#">page 8-57</a>
<b>Authentication Security</b>	Configure security settings for User Authentication.	<a href="#">page 8-60</a>
<b>Unknown User Settings</b>	This specifies the behavior for handling the jobs sent with unknown or unsent login user names or User ID.	<a href="#">page 8-60</a>
<b>Network</b>	Configure security settings on the network.	<a href="#">page 8-61</a>
<b>Job Accounting/Authentication</b>	Configures settings related to machine management. User Login: ➔ <a href="#">Overview of User Login Administration (page 9-2)</a> Job Accounting: ➔ <a href="#">Overview of Job Accounting (page 9-33)</a>	<a href="#">page 8-61</a>
<b>Add/Delete Application</b>	Configure settings for Application.	<a href="#">page 8-61</a>
<b>Application</b>	Configure settings for applications that help you perform your daily more efficiently such as a scan feature and an authentication feature.	<a href="#">page 5-10</a>
<b>Optional Function</b>	You can use the optional applications installed on this machine.	<a href="#">page 11-8</a>
<b>Adjustment/Maintenance</b>	Adjust printing quality and conduct machine maintenance.	<a href="#">page 8-62</a>
<b>Image Adjustment</b>	Perform Image Adjustment.	<a href="#">page 8-62</a>
<b>Others</b>	Adjust Others.	<a href="#">page 8-64</a>

## Device Settings

Configures overall machine operation.

### Language/System of Units

[Home] key > [...] > [System Menu] > [Device Settings] > [Language/System of Units]

Item	Description
Language	Set the language to use for the touch panel display.
Measurement	Select inch or metric for the unit for paper dimensions. <b>Value:</b> mm, inch

### Keyboard

[Home] key > [...] > [System Menu] > [Device Settings] > [Keyboard]

Item	Description
Keyboard Layout	Change the layout of the touch panel keyboard used to enter characters. <b>Value:</b> QWERTY, QWERTZ, AZERTY
Optional Keyboard Type	Select the type of optional keyboard that you want to use. <b>Value:</b> US-English, US-English with Euro, French, German, UK-English

### Numeric Keypad

[Home] key > [...] > [System Menu] > [Device Settings] > [Numeric Keypad]

Item	Description
Default Display	Select whether or not to display the numeric keypad. <b>Value:</b> Off, On
Copy/Print from Box	
HyPAS Application	
Layout (HyPAS Application)	Select the HyPAS numeric keypad layout to display upon startup. <b>Value:</b> Floating, Horizontal, On the Right

### Date/Time





[Home] key > [...] > [System Menu] > [Device Settings] > [Date/Time]



Item	Description
Date and Time	Set the date and time for the location where you use the machine. If you perform Send as E-mail, the date and time set here will be displayed on the header. <b>Value:</b> Year (2000 to 2035), Month (1 to 12), Day (1 to 31), Hour (0 to 23), Minute (0 to 59), Second (0 to 59)
	 <b>NOTE</b> If you change the date/time while using the trial version of an application, you will no longer be able to use the application.

Item	Description
<b>Date Format</b>	Select the display format of year, month, and date. The year is displayed in Western notation. <b>Value: MM/DD/YYYY, DD/MM/YYYY, YYYY/MM/DD</b>
<b>Time Zone</b>	Set the time difference from GMT. Choose the nearest listed location from the list. If you select a region that utilizes summer time, configure settings for summer time. ➔ <a href="#">Setting Date and Time (page 2-35)</a>

## Energy Saver/Timer

[Home] key > [...] > [System Menu] > [Device Settings] > [Energy Saver/Timer]

Item	Description
<b>Auto Panel Reset</b>	If no jobs are run for a certain period of time, automatically reset settings and return to the default setting. Select to use Auto Panel Reset or not. <b>Value: Off, On</b>  <b>NOTE</b> For setting the time until the panel is automatically reset, refer to the following: ➔ <a href="#">Panel Reset Timer (page 8-8)</a>
<b>Panel Reset Timer</b>	If you select [On] for Auto Panel Reset, set the amount of time to wait before Auto Panel Reset. <b>Value: 5 to 495 seconds (in 5 second increments)</b>  <b>NOTE</b> This function is displayed when [Auto Panel Reset] is set to [On].
<b>Low Power Timer</b>	Set amount of time before entering the Low Power mode. <b>Value: 1 to 120 minutes (1 minute increments)</b> ➔ <a href="#">Low Power Mode (page 2-46)</a>
<b>Sleep Timer</b>	Set amount of time before entering Sleep. <b>Value: 1 to 120 minutes (10 minutes increments)</b>
<b>Sleep Rules (models for Europe)*<sup>1</sup></b>	Select whether to use the Sleep mode for the following functions individually: <ul style="list-style-type: none"> <li>• Card reader*<sup>2</sup></li> <li>• Application</li> </ul> <b>Value: Off, On</b>  <b>NOTE</b> If the sleep condition is not turned off, the ID card cannot be recognized.
<b>Sleep Level (models except for Europe)*<sup>1</sup></b>	Select the sleep level. Set the Energy Saver mode to reduce power consumption even more than normal Sleep mode. <b>Value: Quick Recovery, Energy Saver</b>
<b>Sleep Rules</b>	Select whether to use the Energy Saver mode for the following functions individually: <ul style="list-style-type: none"> <li>• Card reader*<sup>2</sup></li> <li>• Application</li> </ul> <b>Value: Off, On</b>  <b>NOTE</b> When the machine has entered sleep mode with Energy Saver setting, the ID card cannot be recognized.

Item	Description
<b>Weekly Timer Settings</b>	Configure settings for switching the machine into Sleep mode and waking it automatically at a specified time for each day of the week.
<b>Weekly Timer</b>	Select whether to use Weekly Timer. <b>Value: Off, On</b>
<b>Schedule</b>	Specify the time for each day of the week at which the machine enters Sleep mode and recovers.
<b>Retry</b>	Set the number of retry to switch the machine into Sleep mode. <b>Value: Limited Retries, Unlimited Retries</b>  <b>NOTE</b> <ul style="list-style-type: none"> <li>If [<b>Limited Retries</b>] is selected, set the number of retry. The setting range is 0 to 10.</li> <li>If [<b>Unlimited Retries</b>] is selected, retry is performed until the machine enters Sleep mode.</li> </ul>
<b>Retry Interval</b>	Set the retry interval. Use [-] / [+] to enter a number. <b>Value: 10 to 60 seconds (increments of 10 seconds)</b>
<b>Power Off Timer (models for Europe)</b>	Select whether to turn off the power automatically after a period of inactivity. <b>Value: 1 hour, 2 hours, 3 hours, 4 hours, 5 hours, 6 hours, 9 hours, 12 hours, 1 day, 2 days, 3 days, 4 days, 5 days, 6 days, 1 week</b>
<b>Power Off Rule (models for Europe)</b>	Select whether or not the machine enters Power Off mode for the following function. Select [ <b>On</b> ] to set the Power Off mode. <ul style="list-style-type: none"> <li>Network</li> <li>Fax</li> <li>USB Cable</li> <li>USB Host</li> <li>Application</li> <li>NIC</li> <li>Remote Diagnostics</li> </ul> <b>Value: Off, On</b>  <b>NOTE</b> <ul style="list-style-type: none"> <li>Even when any of the functions is set to [<b>On</b>], if either [<b>Fax</b>] or [<b>NIC</b>] is set to [<b>Off</b>], the machine does not enter Power Off Mode.</li> <li>Even when [<b>Network</b>] or [<b>USB Cable</b>] is set to [<b>Off</b>], if the machine does not communicate with the other devices, the machine will enter Power Off Mode.</li> <li>[<b>Fax</b>] is Displayed only when the optional FAX Kit is installed.</li> <li>[<b>NIC</b>] is displayed when the optional Network Interface Kit or Wireless Network Interface Kit is installed.</li> </ul>
<b>Energy Saver Recovery Level</b>	Select the method of recovery from energy saver. <b>Value:</b> <b>Full Recovery:</b> This mode enables the use of all functions immediately. However, this mode saves less energy. <b>Normal Recovery:</b> In this mode, you can select the method from the following: enabling the use of all functions immediately or enabling the use of desired functions only. If you want to use all functions immediately, select the [Energy Saver] key to execute recovery.
<b>Ping Timeout</b>	Set the time until timeout occurs when [ <b>Ping</b> ] is executed in "System/Network". <b>Value: 1 to 30 seconds (in 1 second increments)</b>

\*1 This function will not be displayed when the optional Network Interface Kit or Fiery controller is installed.

\*2 Displayed when the optional Card Authentication Kit is activated.



## Display Settings

[Home] key > [...] > [System Menu] > [Device Settings] > [Display Settings]

Item	Description
<b>Display Brightness</b>	Set the brightness of the touch panel. <b>Value:</b> 1 (Darker), 2, 3, 4, 5 (Lighter)
<b>Default Screen</b>	Select the screen appearing right after start-up (default screen). <b>Value:</b> Home, Copy, Send, Fax, Status, Custom Box, Job Box, USB Drive, Polling Box, Subaddress Box, Fax, Memory RX Box, Favorite, Home (Accessibility), Accessibility Copy, Accessibility Send, Accessibility Fax, Application Name <sup>*1</sup>
<b>Wallpaper</b>	➔ <a href="#">Editing the Home Screen (page 2-19)</a>
<b>Show Power Off Message</b>	Set the mode whether display a confirmation message in power supply off. <b>Value:</b> Off, On
<b>Quick Setup Registration (Copy)</b>	Select the functions to be registered for Quick Setup. Six keys of the Quick Setup screen are allocated to typical functions but can be changed as necessary. Six items in the following options are available. <b>Value:</b> Off, Paper Selection, Zoom, Density, Duplex, Combine, Collate, Original Image, Original Size, Original Orientation, Continuous Scan, Background Density Adj, Quiet Mode
<b>Quick Setup Registration (Send)</b>	Select the functions to be registered for Quick Setup. Six keys of the Quick Setup screen are allocated to typical functions but can be changed as necessary. Six items in the following options are available. <b>Value:</b> Off, Original Size, 2-sided, Sending Size, Original Orientation, File Format, Density, Original Image, Scan Resolution, Fax TX Resolution, Color Selection, Zoom, Continuous Scan, Background Density Adj, Quiet Mode
<b>Quick Setup Registration (Fax)</b>	➔ <b>FAX Operation Guide</b>
<b>Quick Setup Registration (Storing in Box)</b>	Select the functions to be registered for Quick Setup. Six keys of the Quick Setup screen are allocated to typical functions but can be changed as necessary. Six items in the following options are available. <b>Value:</b> Off, Color Selection, Storing Size, Density, 2-sided, Scan Resolution, Zoom, Original Orientation, Original Size, Original Image, Continuous Scan, Background Density Adj, Quiet Mode
<b>Quick Setup Registration (Box Print)</b>	Select the functions to be registered for Quick Setup. Six keys of the Quick Setup screen are allocated to typical functions but can be changed as necessary. Six items in the following options are available. <b>Value:</b> Off, Paper Selection, Collate, Duplex, Delete after Printed, Quiet Mode
<b>Quick Setup Registration (Sending from Box)</b>	Select the functions to be registered for Quick Setup. Six keys of the Quick Setup screen are allocated to typical functions but can be changed as necessary. Six items in the following options are available. <b>Value:</b> Off, Fax TX Resolution, File Format, Delete after Transmitted

\*1 The running application will be displayed.

➔ [Application \(page 5-10\)](#)

## Sound



[Home] key > [...] > [System Menu] > [Device Settings] > [Sound]

Item	Description
<b>Buzzer</b>	Set options for buzzer sound during the machine operations.
<b>Key Confirmation</b>	Emit a sound when the operation panel and touch panel keys are selected. <b>Value: Off, On</b>
<b>Job Finish</b>	Emit a sound when a print job is normally completed. <b>Value: Off, On, FAX Reception Only</b>
<b>Ready</b>	Emit a sound when the warm-up is completed. <b>Value: Off, On</b>
<b>Warning</b>	Emit a sound when errors occur. <b>Value: Off, On</b>
<b>Optional Keyboard</b>	Emit a sound to confirm key presses with a sound. <b>Value: Off, On</b>
<b>Fax Speaker Volume</b>	➔ <b>FAX Operation Guide</b>
<b>Fax Monitor Volume</b>	

## Original/Scan Settings

[Home] key > [...] > [System Menu] > [Device Settings] > [Original/Scan Settings]

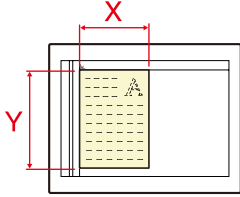
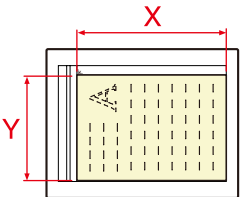
Item	Description
<b>Auto Detect Original Size (DP)</b>	Select whether to automatically detect originals of special or non-standard size.
<b>Auto (Standard Size)</b>	Select whether to enable automatic detection of the Standard Size. The size that can be detected is A6, B6, A5, B5, A4, and Folio in the case of centimeter size. For inch size, Statement, Letter, and only one of Legal, Oficio II, or 216mm x 340mm. <b>Value: Off, On</b>
<b>Non-Standard Size Detection (Copy)</b>	Set whether to detect non-standard size documents in the copy function. This setting takes precedence over the automatic (standard size) setting. <b>Value: Off, On</b>
<b>Non-Standard Size Detection (Send/Save)</b>	Set whether to detect non-standard size documents in the send or save function. This setting takes precedence over the automatic (standard size) setting. <b>Value: Off, On</b>
<b>System of Units</b>	Select [ <b>Metric</b> ] when automatically detecting the originals in centimeter sizes. Select [ <b>Inch</b> ] when detecting the originals in inch sizes. <b>Value: Metric, Inch</b>
<b>Legal/Oficio II/216×340 mm<sup>*1</sup></b>	Set the original sizes for the device to detect automatically. <b>Value: Legal, Oficio II, 216×340 mm</b>

Item	Description
<p><b>Custom Original Size</b></p>	<p>Set up frequently-used custom original size.                      The custom size option is displayed on the screen to select original size.                      Select <b>[On]</b> for "Custom 1 (to 4)" and enter the desired size.  <b>Value:</b>  <b>Metric</b>  <b>X: 50 to 356 mm (in 1 mm increments)</b>  <b>Y: 50 to 216 mm (in 1 mm increments)</b>  <b>Inch</b>  <b>X: 2.00 to 14.02" (in 0.01" increments)</b>  <b>Y: 2.00 to 8.50" (in 0.01" increments)</b>  <b>X=Length, Y=Width</b></p> <div style="display: flex; justify-content: space-around; align-items: center;"> <div style="text-align: center;"> <p>Vertical</p>  </div> <div style="text-align: center;"> <p>Horizontal</p>  </div> </div>
<p><b>Default Original Size</b></p>	<p>Set the default value for the original size.  <b>Value:</b>  <b>A/B: A4, A5, A5-R, A6, B5, B6, Folio, 216 x 340 mm</b>  <b>Inch: Letter, Legal, Statement, Executive, Oficio II</b>  <b>Others: 16K, ISO B5, Envelope #10, Envelope #9, Envelope #6, Envelope Monarch, Envelope DL, Envelope C5, Hagaki (Cardstock), Oufuku Hagaki (Return postcard), Youkei 4, Youkei 2, Younaga 3, Nagagata 3, Nagagata 4</b></p>
<p><b>Default Original Size (Platen)</b></p>	<p>Set the default value for the original size set on the platen. Select <b>[Off]</b> to display a confirmation screen before execution of a job.  <b>Value:</b>  <b>A/B : A4, A5, A5-R, A6, B5, B6, Folio, 216 x 340 mm</b>  <b>Inch : Letter, Legal, Statement, Executive, Oficio II</b>  <b>Others : 16K, ISO B5, Envelope #10, Envelope #9, Envelope #6, Envelope Monarch, Envelope DL, Envelope C5, Hagaki (Cardstock), Oufuku Hagaki (Return postcard), Youkei 4, Youkei 2, Younaga 3, Nagagata 3, Nagagata 4, Custom</b></p> <p> <b>NOTE</b>                      Not displayed when <b>[Auto (Standard Size)]</b> in <b>[Auto Detect Original Size]</b> is off.</p>

\*1 This function is displayed when "System of Units" is set to **[Inch]**.

## Paper Feeding

[Home] key > [...] > [System Menu] > [Device Settings] > [Paper Feeding]

Configure the paper and paper source settings.

### Cassette 1 (to 5) Settings

[Home] key > [...] > [System Menu] > [Device Settings] > [Paper Feeding] > [Cassette 1 (to 5) Settings]

#### NOTE

[Cassette 2] and [Cassette 5] are displayed when the following optional paper feeder is installed.

[Cassette 2]: When a paper feeder (500-sheet)

[Cassette 3]: When a paper feeder (500-sheet)

[Cassette 4]: When a paper feeder (500-sheet)

[Cassette 5]: When a paper feeder (500-sheet)

Item	Description
<b>Paper Size</b> <sup>*1</sup>	Select paper size. <b>Value:</b> <b>Cassette 1:</b> A4 <sup>*2</sup> , A5-R <sup>*2</sup> , A5 <sup>*3</sup> , A6 <sup>*2*3</sup> , B5 <sup>*2</sup> , B6 <sup>*3</sup> , Folio, 216.0mm×340.0mm, Letter <sup>*2</sup> , Legal <sup>*2</sup> , Statement, Statement-R <sup>*3</sup> , Executive, Oficio II, 16K, ISO B5, Envelope DL <sup>*3</sup> , Envelope C5, Oufuku Hagaki <sup>*2</sup> , Custom <sup>*4</sup> <b>Cassette 2 to 5:</b> A4 <sup>*2</sup> , A5 <sup>*2</sup> , B5 <sup>*2</sup> , B6, Folio, 216.0mm×340.0mm, Letter <sup>*2</sup> , Legal <sup>*2</sup> , Statement, Executive, Oficio II, 16K, ISO B5, Envelope #10, Envelope #9, Envelope #6, Envelope Monarch, Envelope DL, Envelope C5, Oufuku Hagaki, Youkei 4, Youkei 2, Nagagata 3, Custom <sup>*4</sup>
<b>Media Type</b> <sup>*5</sup>	Select the media type. <b>Value:</b> <b>Cassette 1:</b> plain paper, recycled paper, pre-printed <sup>*6</sup> , bond paper, color paper, pre-punched paper <sup>*6</sup> , letterhead <sup>*6</sup> , high-quality paper, custom 1-8 <b>Cassettes 2-5:</b> plain paper, recycled paper, pre-printed <sup>*6</sup> , bond paper, color paper, pre-punched paper <sup>*6</sup> , letterhead <sup>*6</sup> , envelope, fine paper, custom 1-8

\*1 Used when the size dial of the cassette is set to "Other".

\*2 Paper size automatically detected in the cassette.

\*3 ECOSYS MA6000ifx/ECOSYS MA5500ifx models only.

\*4 Custom paper sizes are set per cassette.

➔ [Custom Paper Settings \(page 8-15\)](#)

\*5 To change to a media type other than "Plain".

➔ [Media Type Setting \(page 8-17\)](#)

When a paper weight that cannot be loaded in the cassette is set for a media type, that media type does not appear.

\*6 To print on preprinted or prepunched paper or on letterhead, refer to the following:

➔ [Special Paper Action \(page 8-18\)](#)

## MP Tray Settings

[Home] key > [...] > [System Menu] > [Device Settings] > [Paper Feeding] > [MP Tray Settings]

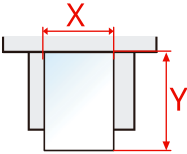
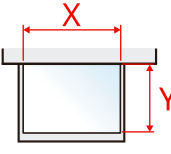
Item	Description
<p><b>Paper Size</b></p>	<p>Select paper size.</p> <p><b>Value:</b>  <b>A4, A5-R, A5, A6, B5, B6, Folio, 216 × 340 mm, Letter, Legal, Statement-R, Statement, Executive, Oficio II, 16K, ISO B5, Envelope #10, Envelope #9, Envelope #6, Envelope Monarch, Envelope DL, Envelope C5, Hagaki, Oufukuhagaki, Youkei 4, Youkei 2, Younaga 3, Nagagata 3, Nagagata 4, Custom</b></p> <div style="display: flex; justify-content: space-around; align-items: center;"> <div style="text-align: center;"> <p>Vertical</p>  </div> <div style="text-align: center;"> <p>Horizontal</p>  </div> </div>
<p><b>Media Type*1</b></p>	<p>Select the media type.</p> <p><b>Value:</b>  <b>Plain , Transparency, Rough, Vellum, Labels, Recycled, Preprinted*2, Bond, Cardstock, Color, Prepunched*2, Letterhead*2, Envelope, Thick, High Quality, Custom 1 - 8</b></p>

\*1 To change to a media type other than "Plain".

➔ [Media Type Setting \(page 8-17\)](#)

\*2 To print on preprinted or prepunched paper or on letterhead.

➔ [Special Paper Action \(page 8-18\)](#)

 **NOTE**

The available media types for printing received faxes are as shown below.

Plain, Rough, Vellum, Labels, Recycled, Bond, Cardstock, Color, Envelope, Thick, High Quality and Custom1-8

### Custom Paper Settings

[Home] key > [...] > [System Menu] > [Device Settings] > [Paper Feeding] > [Custom Paper Settings]

Set up frequently-used custom paper size. Register one custom size for each paper source. The registered size is displayed when the paper size is selected.

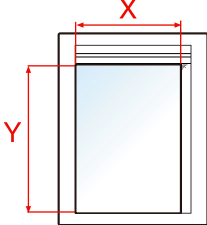
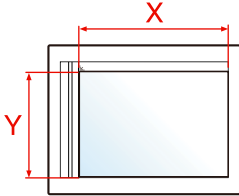
Item	Description
<p><b>Cassette 1 Size<sup>*1</sup></b></p>	<p>Register the custom size to be used in Cassette 1.</p> <p><b>Value</b></p> <p><b>Metric</b></p> <p><b>ECOSYS MA4500ifx/ECOSYS MA4500ix</b>            X: 140 to 216 mm (in 1 mm increments)            Y: 210 to 356 mm (in 1 mm increments)</p> <p><b>ECOSYS MA6000ifx/ECOSYS MA5500ifx</b>            X: 105 to 216 mm (in 1 mm increments)            Y: 148 to 356 mm (in 1 mm increments)</p> <p><b>Inch</b></p> <p><b>ECOSYS MA4500ifx/ECOSYS MA4500ix</b>            X: 5.50 to 8.50" (in 0.01" increments)            Y: 8.25 to 14.02" (in 0.01" increments)</p> <p><b>ECOSYS MA6000ifx/ECOSYS MA5500ifx</b>            X: 4.13 to 8.50" (in 0.01" increments)            Y: 5.83 to 14.02" (in 0.01" increments)</p> <p>X=Length, Y=Width</p> <div style="display: flex; justify-content: space-around; align-items: center;"> <div style="text-align: center;"> <p><b>Vertical</b></p>  </div> <div style="text-align: center;"> <p><b>Horizontal</b></p>  </div> </div>

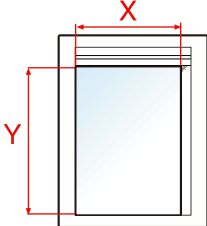
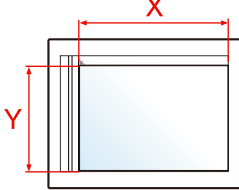
Item	Description
<b>Cassette 2 to Cassette 5 size<sup>*1</sup></b>	<p>Set up custom sizes to use with cassette 2 to 5.</p> <p><b>Value</b></p> <p><b>Metric</b>                      X: 92 to 216 mm (in 1 mm increments)                      Y: 162 to 356 mm (in 1 mm increments)</p> <p><b>Inch</b>                      X: 3.62 to 8.50" (in 0.01" increments)                      Y: 6.83 to 14.02" (in 0.01" increments)</p> <p>X=Length, Y=Width</p>
<b>Multi Purpose Tray Size</b>	<p>Register the custom size used for Multipurpose Tray.</p> <p><b>Value</b></p> <p><b>Metric</b>                      X: 70 to 216 mm (in 1 mm increments)                      Y: 140 to 356 mm (in 1 mm increments)</p> <p><b>Inch</b>                      X: 2.76 to 8.50" (in 0.01" increments)                      Y: 5.51 to 14.02" (in 0.01" increments)</p> <p>X=Length, Y=Width</p> <div style="display: flex; justify-content: space-around; align-items: center;"> <div style="text-align: center;"> <p><b>Vertical</b></p>  </div> <div style="text-align: center;"> <p><b>Horizontal</b></p>  </div> </div>

\*1 Used when the size dial of the cassette is set to " Other" .

**Media Type Setting**

[Home] key > [...] > [System Menu] > [Device Settings] > [Paper Feeding] > [Media Type Setting]

Select weight for each media type.

The following media type and paper weight combinations are available.

Paper Weight	Weight (g/m <sup>2</sup> )	Paper Weight	Weight (g/m <sup>2</sup> )
Light	52 g/m <sup>2</sup> to 59 g/m <sup>2</sup>	Heavy 1	106 g/m <sup>2</sup> to 135 g/m <sup>2</sup>
Normal 1	60 g/m <sup>2</sup> to 74 g/m <sup>2</sup>	Heavy 2	136 g/m <sup>2</sup> to 163 g/m <sup>2</sup>
Normal 2	75 g/m <sup>2</sup> to 90 g/m <sup>2</sup>	Heavy 3	164 g/m <sup>2</sup> to 256 g/m <sup>2</sup>
Normal 3	91 g/m <sup>2</sup> to 105 g/m <sup>2</sup>	Extra Heavy	Transparencies

Each media type's default weight is indicated.

Media Type	Default	Media Type	Default
Plain	Normal 2	Color	Normal 2
Rough	Normal 2	Prepunched	Normal 2
Vellum	Light	Letterhead	Normal 2
Labels	Heavy 1	Envelope	Heavy 3
Recycled	Normal 2	Thick	Heavy 3
Preprinted	Normal 2	High Quality	Normal 2
Bond	Normal 3	Custom 1 - 8	Normal 2
Cardstock	Heavy 3		

For Custom 1-8, settings for duplex printing and media type name can be changed.

Item	Description
Duplex Print	Prohibit Duplex printing allowed.
	Permit Duplex printing not allowed.
Name	Change names for Custom 1-8. Names should be not more than 16 characters. Selecting media type at multipurpose tray, the name after change will be displayed. ➔ <a href="#">Character Entry Method (page 11-10)</a>

**Show Paper Setup Message**









[Home] key > [...] > [System Menu] > [Device Settings] > [Paper Feeding] > [Show Paper Setup Message]

Item	Description
Show Paper Setup Message	Set whether to display the confirmation screen for the paper setting when a new paper is set for each cassette. <b>Value: Off, On</b>
Cassette 1 to 5	 <b>NOTE</b> [Cassette 2] and [Cassette 5] are displayed when the following optional paper feeder is installed.
Multipurpose Tray	[Cassette 2]: When a paper feeder (500-sheet) is installed. [Cassette 3]: When a paper feeder (500-sheet) is installed. [Cassette 4]: When a paper feeder (500-sheet) is installed. [Cassette 5]: When a paper feeder (500-sheet) is installed.

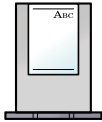
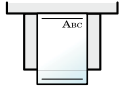

## Paper Feed Settings

[Home] key > [...] > [System Menu] > [Device Settings] > [Paper Feeding] > [Paper Feed Settings]

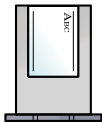
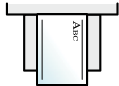
Item	Description
<b>Default Paper Source</b>	<p>Select the default paper source.  <b>Value: Cassette 1 (to 5), MP Tray</b></p> <p> <b>NOTE</b>  [Cassette 2] and [Cassette 5] are displayed when the following optional paper feeder is installed.  [Cassette 2]: When a paper feeder (500-sheet) is installed.  [Cassette 3]: When a paper feeder (500-sheet) is installed.  [Cassette 4]: When a paper feeder (500-sheet) is installed.  [Cassette 5]: When a paper feeder (500-sheet) is installed.</p>
<b>Paper Selection</b>	<p>Set the default paper selection.  <b>Value: Auto, Default Paper Source</b></p>
<b>Auto Paper Selection</b>	<p>If [Auto] is selected for Paper Selection, set the paper size selection method when the zoom changes.  <b>Value</b>  <b>Most Suitable Size: Selects paper size based on the current zoom and the size of the original.</b>  <b>Same as Original Size: Selects paper that matches the size of the original, regardless the zoom.</b></p>
<b>Media for Auto (B &amp; W)</b>	<p>Select a default media type for auto paper selection when [Auto] is selected of Paper Selection. If [Plain] is selected, the paper source with plain paper loaded in the specific size is selected. Select [All Media Types] for the paper source with any kind of paper loaded in the specific size.  <b>Value: All Media Types, Plain, Transparency, Rough, Vellum, Labels, Recycled, Preprinted, Bond, Cardstock, Color, Prepunched, Letterhead, Envelope, Thick, High Quality, Custom 1 to 8</b></p>
<b>Special Paper Action</b>	<p>When printing on Prepunched, Preprint, and Letterhead, punch-holes might not be aligned or the print direction might be upside-down depending on how originals are set and the combination of copying functions. In such a case, select [Adjust Print Direction] to adjust the print direction. When paper orientation is not important, select [Speed Priority].  If [Adjust Print Direction] is selected, load paper according to the steps below.  Example: copying on Letterhead</p> <div style="display: flex; justify-content: space-around; align-items: center;"> <div style="text-align: center;">   Original </div> <div style="text-align: center;">   Paper </div> <div style="text-align: center;">   Finished </div> <div style="text-align: center;">   Cassette </div> <div style="text-align: center;">   Multipurpose Tray </div> </div> <div style="display: flex; justify-content: space-around; align-items: center; margin-top: 10px;"> <div style="text-align: center;">   Original </div> <div style="text-align: center;">   Paper </div> <div style="text-align: center;">   Finished </div> <div style="text-align: center;">   Cassette </div> <div style="text-align: center;">   Multipurpose Tray </div> </div> <p><b>Value: Adjust Print Direction, Speed Priority</b></p>

## Function Key Assignment

[Home] key > [...] > [System Menu] > [Device Settings] > [Function Key Assignment]

Item	Description
Function Key 1	Assign a function to each function key. <b>Value:</b> None, Copy, Send, Fax Server, Fax <sup>*1</sup> , Custom Box, Job Box, USB Drive, Subaddress Box <sup>*1</sup> , Polling Box <sup>*1</sup> , Fax Memory RX Box <sup>*1</sup> , Send to Me (Email), Send to Me from Box (Email), Favorites <sup>*2</sup> , Application <sup>*3</sup>
Function Key 2	
Function Key 3	
	 <b>NOTE</b> Select [Filter] to narrow down for [All], [Application], [Favorites] and [Others].

\*1 Displayed only on products with the fax function installed.

\*2 The registered favorite will be displayed.

\*3 The running application will be displayed.

## Operation Assist



[Home] key > [...] > [System Menu] > [Device Settings] > [Operation Assist]

Item	Description
Orientation Confirmation	Select whether to display a screen for selecting the orientation of the originals to be placed on the platen when using the following functions. <a href="#">▶ Original Orientation (page 6-18)</a> <ul style="list-style-type: none"> <li>Duplex</li> <li>Combine</li> <li>2-sided</li> </ul> <b>Value:</b> Off, On
Preset Limit	Restrict the number of copies that can be made at one time. <b>Value:</b> 1 to 999 copies
Clear Settings after Job Started	Set whether to reset function settings to their defaults after the job starts. <b>Value:</b> Clear, Do Not Clear

## Error Handling

[Home] key > [...] > [System Menu] > [Device Settings] > [Error Handling]

Item	Description
Duplexing Error	Set what to do when duplex printing is not possible for the selected paper sizes and media types. <b>Value</b> <b>1-sided: Printed in 1-sided</b> <b>Display Error: Message to cancel printing is displayed.</b>
Paper Mismatch Error	Set what to do when the selected paper size or type does not match paper size or type loaded in the specified paper source while printing from the computer by specifying the cassette or multipurpose tray. <b>Value</b> <b>Ignore: The setting is ignored and the job is printed.</b> <b>Display Error: Message to cancel printing is displayed.</b>

Item	Description
<b>Wrong Size Paper Loaded</b>	<p>Set what to do when it is detected that the multipurpose tray paper size setting does not match the actual paper size that is fed.</p> <p><b>Value</b></p> <p><b>Ignore: The setting is ignored and the job is printed.</b></p> <p><b>Display Error: Message to cancel printing is displayed.</b></p>
<b>Auto Error Clear</b>	<p>If an error occurs during processing, processing stops to wait for the next step to be taken by the user. In the Auto Error Clear mode, automatically clear the error after a set amount of time elapses.</p> <p><b>Value: Off, On</b></p> <p> <b>NOTE</b></p> <p>If you select [<b>On</b>] for Auto Error Clear, set the amount of time to wait before automatically clearing errors. The setting range is 5 to 495 seconds (in 5 second increments).</p>
<b>Continue or Cancel Error Job</b>	<p>Set which users can cancel or continue operations for jobs which were paused due to an error.</p> <p><b>Value: All Users, Job Owner Only</b></p> <p> <b>NOTE</b></p> <p>Administrator can cancel all jobs regardless of this setting.</p>

## Toner Settings

[Home] key > [...] > [System Menu] > [Device Settings] > [Toner Settings]



Item	Description
<b>Notify via Operation Panel</b>	<p>Set whether to display the alert on the operation panel when the toner is low.</p> <p><b>Value: Off, On</b></p>
<b>Low Toner Alert</b>	<p>Set the amount of remaining toner to notify the administrator when to order a toner when the toner is running low.</p> <p>This notification is used for event report, Status Monitor, SNMP Trap. (such as Printing Equipment Management Systems)</p> <p><b>Value: Off, On</b></p> <p> <b>NOTE</b></p> <p>If [<b>On</b>] is selected, set the amount of remaining toner to alert. The setting range is 5 to 100% (in 1% increments).</p>

## Notification/Report

Print reports to check the machine settings, status, and history. Settings for printing reports can also be configured.

### Printing Report/List

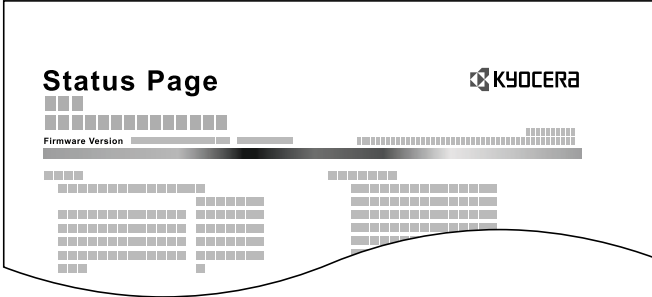
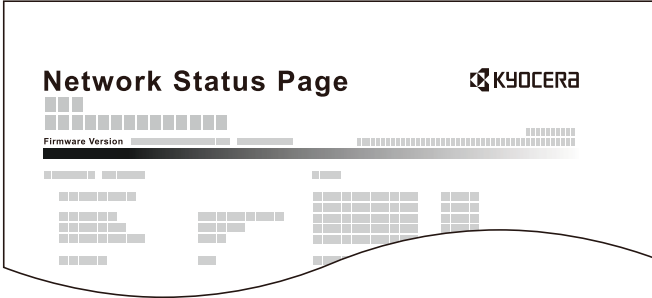
[Home] key > [...] > [System Menu] > [Notification/Report] > "Printing Report/List" [Printing Report/List]

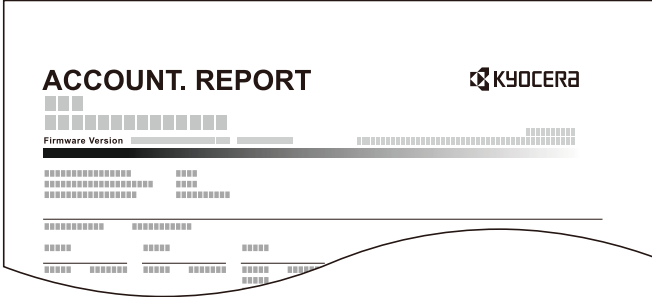
Item	Description
<p><b>Status Page</b></p>	<p>Prints the status page, allowing you to check the information including current settings, available memory space, and optional equipment installed.</p> 
<p><b>Service Status</b></p>	<p>Prints the service status. More detailed information is available than on the Status Page. Service personnel usually print the service status pages for maintenance purpose.</p>
<p><b>Network Status</b></p>	<p>Prints the network status, allowing you to check the information including network interface firmware version, network address and protocol.</p> 
<p><b>Optional Network Status</b></p>	<p>Prints the optional network status, allowing you to check the information including optional network interface firmware version, network address and protocol.</p> <p> <b>NOTE</b> This function is displayed when the optional Network Interface Kit or Wireless Network Interface Kit is installed.</p>
<p><b>Print Accounting Report</b></p>	<p>If job accounting is enabled, the total pages counted of all relevant accounts can be printed as an accounting report.</p>  <p>➔ <a href="#">Print Accounting Report (page 9-47)</a></p>

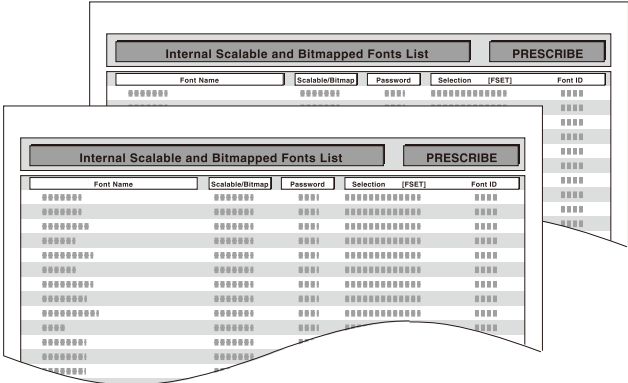
Item	Description
Font List	Prints the font list, allowing you to check the font samples installed in the machine. 
Outgoing Fax Report	➔ FAX Operation Guide
Incoming Fax Report	➔ FAX Operation Guide
Fax List (Index)	➔ FAX Operation Guide
Fax List (No.)	➔ FAX Operation Guide
One Touch List (ALL)	Prints One Touch List, allowing you to check the destinations that have been registered on the One Touch Keys.
One Touch List (Fax)	➔ FAX Operation Guide
Subaddress Box List	➔ FAX Operation Guide
Application Status	Prints Application Status, allowing you to check the information on the application installed in the machine.
Configuration List	Print the system settings as the list.
Data Sanitization Report	Prints the data sanitization report.

## Result Report Setting

[Home] key > [...] > [System Menu] > [Notification/Report] > "Result Report Setting"

Item	Description
<b>Send Result Report</b>	Automatically print a report of transmission result when a transmission is complete.
<b>Email/Folder</b>	Automatically print a report of transmission result when Email or SMB/FTP transmission is complete. <b>Value: Off, On, Error Only</b>
<b>Fax<sup>*1</sup></b>	➔ FAX Operation Guide
<b>Canceled before Sending<sup>*2</sup></b>	Print a send result report if the job is canceled before being sent. <b>Value: Off, On</b>
<b>Recipient Format<sup>*2</sup></b>	Select the Recipient Format for the send result report. <b>Value: Name or Destination, Name and Destination</b>
<b>RX Result</b>	➔ FAX Operation Guide
<b>Job Finish Notice Setting</b>	

\*1 Displayed only on products with the fax function installed.

\*2 When "Email/Folder" and "Fax" are set to [Off], this function will not be displayed.

## Device Status Notification

[Home] key > [...] > [System Menu] > [Notification/Report] > "Device Status Notification"

Item		Description
<b>Low Toner Alert</b>		➔ <a href="#">Low Toner Alert (page 8-20)</a>
<b>Periodic Inspection Notification</b>	<b>Notify via Operation Panel</b>	Set whether or not to display on the operation panel when a periodic inspection is near. <b>Value</b> <b>Off, Status Display, Status and Error Display</b>
	<b>Notify Externally (for admin. use)</b>	Set the timing at which the administrator will be notified of the period remaining before the upcoming scheduled inspection when it is near. This notification is used for Event Reports, Status Monitors, and SNMPTraps (such as Printing Equipment Management Systems) . <b>Value</b> <b>Off, On</b>  <b>NOTE</b> If [On] is selected, set the alert timing. The setting range is 5 to 100% (in 1% increments) .

## Fax Communication Report

[Home] key > [...] > [System Menu] > [Notification/Report] > "Fax Communication Report"

Configure settings for Outgoing Fax report and Incoming Fax report.

➔ **FAX Operation Guide**

## History Settings

[Home] key > [...] > [System Menu] > [Notification/Report] > "History Settings"

### NOTE

For details on the Log History, refer to the following:

➔ [History Management \(page 8-24\)](#)

Item		Description
Sending Log History	<b>Auto Sending</b>	This function automatically sends the log history to the specified destinations whenever a set number of jobs has been logged. <b>Value: Off, On</b>   <b>NOTE</b> If [On] is selected, specify the number of job histories. The setting range is 1 to 16.
	<b>Destination</b>	Set the destination to which log histories are sent. Only E-mail address can be set.
	<b>Subject</b>	Set the subject automatically entered when sending log histories by E-mail. <b>Value: Up to 256 characters</b>
	<b>SSFC</b>	Enter the subject of the printed job history with ID card authentication. <b>Value: Up to 256 characters</b>
	<b>Personal Information</b>	Select whether to include personal information in the job log. <b>Value: Include, Exclude</b>
	<b>Send Log History</b>	You can also send the log history to the specified destinations manually.

## History Management

It is possible to perform Log Management for the following logs on this machine.

Item	Log subject	Log information
Jobs Log	Copy/Fax/Scan/Send/Print job completion	<ul style="list-style-type: none"> <li>• Event occurrence date and time</li> <li>• Event type</li> <li>• Information on users logged in (or users who attempted to log in)</li> <li>• Event results (Success/Failure)</li> </ul>
	Checking job status/Changing of jobs/Canceling of jobs	

### NOTE

If the User Authentication screen appears, log in with a user who has the privilege to configure this setting. If you do not know your login User Name or Password, please contact your Administrator.

## Function Settings



Configures settings for copying, sending and Document Box functions.

### Function Defaults

[Home] key > [...] > [System Menu] > [Function Settings] > [Function Defaults]

#### Common

[Home] key > [...] > [System Menu] > [Function Settings] > [Function Defaults] > [Common]

Item	Description
<b>Clear Settings after Job Started</b>	➔ <a href="#">Clear Settings after Job Started (page 8-19)</a>
<b>File Name Entry</b>	Set an automatically entered name (default) for jobs. Additional information such as Date and Time and Job No. can also be set. <b>Value</b> <b>File Name: Up to 32 characters can be entered.</b> <b>Additional Info: None, Job No., Date and Time, Job No. &amp; Date and Time, Date and Time &amp; Job No.</b>
<b>Border Erase Default</b>	Set the default width to be erased as a border. <b>Value</b> <b>Metric: 0 to 50 mm (in 1 mm increments)</b> <b>Inch: 0 to 2" (in 0.01" increments)</b>  <b>NOTE</b> To specify border erase widths around original, set the value in "Border". To specify border erase widths in the middle of original, set the value in "Gutter".
<b>Border Erase to Back Page</b>	Select the Border Erase Method for Back Page of a sheet. <b>Value: Same as Front Page, Do Not Erase</b>
<b>Zoom</b>	Select the enlarged/reduced default when paper size/sending size changed after the originals set. <b>Value: 100%, Auto</b>
<b>DP Read Action</b>	Set the operation when a document is scanned from the document processor. <b>Value: Speed Priority, Quality Priority</b>
<b>Detect Multi-fed Originals</b>	When reading a document from the document processor, if the multiple feeding of documents is detected, then the reading stops automatically. <b>Value:</b> <b>On:</b> In case of detecting that multiple sheets of original are fed at the same time, the message is displayed and stop scanning the original. <b>Off:</b> It does not detect.  <b>NOTE</b> This function is displayed when you are using the ECOSYS MA6000ifx/ECOSYS MA5500ifx.
<b>Detection of Bent Corner of the Original</b>	When scanning a document from the document processor, scanning is automatically stopped when a document with a folded corner is detected. <b>Value:</b> <b>On:</b> In case of detecting that the original is folded corner, the message is displayed and stop scanning the original. <b>Off:</b> It does not detect.



Item		Description
Quiet Mode	Quiet Mode	Set the quiet mode Set this when the operating noise is disturbing. <b>Value: Off, On</b>
	Specify Each Job	You can set the quiet mode for each job, such as copy and send. Here, set whether to allow the setting for each job. <b>Value: Allowed, Not Allowed</b>

### Copy/Print

[Home] key > [...] > [System Menu] > [Function Settings] > [Function Defaults] > [Copy/Print]

Item	Description
Original Size	Set the default value for the original size. When Standard Size Detection is OFF, the size set in the default original size is displayed as an option. These settings are in the Original/Scan settings. Standard Size Detection: On <b>Value:</b> <b>Auto</b> (standard size), <b>Auto</b> (non-standard size) Standard Size Detection: Off <b>Value:</b> <b>Auto</b> (non-standard size), <b>Original Size</b> (default size)
Original Orientation (Copy)	Set the original orientation defaults. <b>Value: Top Edge on Top, Top Edge on Left, Auto *1</b>
Original Image (Copy)	Set the default original document type for copying. <b>Value: Text+Photo (Printer), Text+Photo (Magazine), Photo (Printer), Photo (Magazine), Photo (Photo Paper), Text, Text (Fine Line), Graphic/Map (Printer), Graphic/Map (Magazine)</b>
Background Density Adj. (Copy)	Set the default Background Density (Copy). <b>Value: Off, Auto, Manual (Darker 5)</b>
Continuous Scan (Copy)	Select the default Continuous Scan (Copy) setting. <b>Value: Off, On</b>
Prevent Bleed-through (Copy)	Set the default value for preventing bleed-through (Copy). <b>Value: Off, On</b>
Skip Blank Page (Copy)	Select the default Skip Blank Page (Copy) settings. <b>Value: Off, On</b>
EcoPrint	Select the EcoPrint default. <b>Value: Off, On</b>
Border Erase (Copy)	Set the defaults for Border Erase (Copy). <b>Value: Standard, Border Erase Sheet, Border Erase Book, Individual Border Erase</b>
Collate	Set the defaults for Collate. <b>Value: Off, On</b>
JPEG/TIFF Print	Select the image size (resolution) when printing JPEG or TIFF file. <b>Value: Fit to Paper Size, Image Resolution, Fit to Print Resolution</b>
XPS Fit to Page	Set the default value for the XPS fit to page function. <b>Value: Off, On</b>
Reserve Next Priority	Specify whether the default screen appears when a subsequent copy job is reserved while printing is in progress. To have the default screen appear, select [On]. <b>Value: Off, On</b>

Item	Description
<b>Auto % Priority</b>	When a paper source of different size from the original is selected, select whether automatic zoom (reduce/zoom) is performed. <b>Value: Off, On</b>
<b>ID Card Copy</b>	Select the ID Card Copy default. <b>Card Position on the Glass platen</b> No card position specified or set it to top left. <b>Value: Free, Top Left</b> <b>Finished Layout</b> Sets the copy position on the paper to center or top right. <b>Value: Align to Center, Align to Top Right</b>

\*1 This function can only be used when the optional OCR Scan Activation Kit is installed.

➔ [Scan extension kit\(A\) "OCR Scan Activation Kit" \(page 11-7\)](#)

### Send/Store

[Home] key > [...] > [System Menu] > [Function Settings] > [Function Defaults] > [Send/Store]

Item	Description
<b>Original Size</b>	Set the default value for the original size. When Standard Size Detection is OFF, the size set in the default original size is displayed as an option. These settings are in the Original/Scan settings. Standard Size Detection: On <b>Value: Auto</b> (standard size), <b>Auto</b> (non-standard size) Standard Size Detection: Off <b>Value: Auto</b> (non-standard size), <b>Original Size</b> (default size)
<b>Original Orientation (Send/Store)</b>	Set the original orientation defaults. <b>Value: Top Edge on Top, Top Edge on Left, Auto</b> <sup>*1</sup>
<b>Color Selection (Send/Store)</b>	Select the default color mode for scanning documents. <b>Value: Auto Color (Color/Gray), Auto Color (Color/B &amp; W), Full Color, Grayscale, Black &amp; White</b>
<b>Scan Resolution</b>	Select the default scanning resolution. <b>Value: 600×600dpi, 400×400dpi Ultrafine, 300×300dpi, 200×400dpi Superfine, 200×200dpi Fine, 200×100dpi Normal</b>
<b>Fax TX Resolution</b>	➔ <b>FAX Operation Guide</b>
<b>Org. Image (Send/Store)</b>	Set the default original document type for sending/storing. <b>Value: Text+Photo, Photo, Text, Text (Fine Line), Text (for OCR)</b>
<b>Clarify Text (noise removal)</b>	When scanning and sending a document in black and white, it eliminates background noise and improves the legibility of the text. <b>Value: Off, On</b>
<b>Background Density Adj. (Send/Store)</b>	Set the default Background Density (Send/Store). <b>Value: Off, Auto, Manual (Darker 5)</b>
<b>Continuous Scan (Send/Store)</b>	Select the default Continuous Scan (Send/Store) setting. <b>Value: Off, On</b>
<b>Continuous Scan (Fax)</b>	➔ <b>FAX Operation Guide</b>
<b>Prevent Bleed-through (Send/Store)</b>	Set the default Prevent Bleed (Send/Store). <b>Value: Off, On</b>

Item	Description
<b>Border Erase/Full Scan (Send/Store)</b>	Set the defaults for Border Erase/Full Scan (Send/Store). <b>Value: Standard, Full Scan, Border Erase Sheet, Border Erase Book, Individual Border Erase</b>
<b>Border Erase/Full Scan (Fax)</b>	➔ <b>FAX Operation Guide</b>
<b>Skip Blank Page (Send/Store)</b>	Select the default Skip Blank Page (Send/Store) settings. <b>Value: Off, On</b>
<b>File Format</b>	Set the default type of the files. <b>Value: PDF, TIFF, JPEG, XPS, OpenXPS, High Comp. PDF, Word, Excel, PowerPoint</b>
<b>Image Quality (File Format)</b>	Select the default PDF/TIFF/JPEG/XPS/OpenXPS/Word/Excel/PowerPoint file quality. <b>Value: 1 Low Quality (High Comp.) to 5 High Quality (Low Comp.)</b>
<b>High Comp. PDF Image</b>	Select the default quality setting for high compressed PDF files. <b>Value: Compression Ratio Priority, Standard, Quality Priority</b>
<b>Color TIFF Compression</b>	Select the compression method for sending the color documents in the TIFF format. <b>Value: TIFF V6, TTN2</b>
<b>PDF/A</b>	Select the default PDF/A setting. <b>Value: Off, PDF/A-1a, PDF/A-1b, PDF/A-2a, PDF/A-2b, PDF/A-2u</b>   <b>NOTE</b> If [On] is selected in "Digital Signature", [PDF/A-1a] and [PDF/A-1b] cannot be selected. ➔ <b>Digital Signature to File (page 8-30)</b>
<b>OCR Text Recognition Action*1</b>	Configure settings for OCR Text Recognition Action. <b>Value: Speed Priority, Quality Priority</b>
<b>OCR Text Recognition*1</b>	Set the default OCR Text Recognition. <b>Value: Off, On</b>
<b>Primary OCR Language*1</b>	Set the default language of the text to be extracted. ([English] is selected as a default.) Select the language to extract from the options displayed on the touch panel.
<b>OCR Output Format*1</b>	Set the default OCR output format. <b>Value: Text + Graphics, Text + Graphics with Scanned Image, Scanned Image with Searchable Text</b>
<b>File Separation</b>	Select the default file separation setting. <b>Value: Off, Each Page</b>
<b>Email Subject/Body</b>	Set the subject and body automatically entered (default subject and body) when sending the scanned originals by E-mail. <b>Value</b> <b>Subject: Up to 256 characters can be entered.</b> <b>Body: Up to 500 characters can be entered.</b>

\*1 This function can only be used when the optional OCR Scan Activation Kit is installed.

➔ [Scan extension kit\(A\) "OCR Scan Activation Kit" \(page 11-7\)](#)

## Copy/Print





[Home] key > [...] > [System Menu] > [Function Settings] > [Copy/Print]

Item	Description
<b>Quick Setup Registration (Copy)</b>	➔ <a href="#">Quick Setup Registration (Copy) (page 8-10)</a>

**Send/Store**



[Home] key &gt; [...] &gt; [System Menu] &gt; [Function Settings] &gt; [Send/Store]

Item		Description
<b>Default Screen</b>		Set the default screen displayed when you select the [Send] key. <b>Value: Destination, Address Book, One touch Key</b>
<b>Prevent Mis-sending Settings</b>	<b>Destination Check before Send</b>	Select whether to display the confirmation screen of destinations after pressing the [Start] key when performing sending jobs. <b>Value: Off, On</b>
	<b>Entry Check for New Dest.</b>	When adding new destination, select whether to display the entry check screen to check the entered destination. <b>Value: Off, On</b>
	<b>New Destination Entry</b>	Select whether to permit direct entry of destination. <b>Value: Prohibit, Permit</b>
	<b>Recall Destination</b>	Select whether to permit usage of [Recall] on the Send screen. <b>Value: Prohibit, Permit</b>
	<b>Broadcast</b>	Set whether to enable broadcast. <b>Value: Prohibit, Permit</b>
	<b>Destination History Usage</b>	Allow to use the destination history. <b>Value: Prohibit, Permit</b>
	<b>Delete Destination History</b>	Delete the destination history.
<b>Quick Setup Registration (Send)</b>		➔ <a href="#">Quick Setup Registration (Send) (page 8-10)</a>

Item		Description
Digital Signature to File	Digital Signature	<p>Select whether to add a digital signature.</p> <p><b>Value:</b></p> <p><b>Off:</b> Does not add a digital signature.</p> <p><b>Specify Each Job:</b> Whether to add a digital signature is selected each time of sending.</p> <p><b>On:</b> Always adds a digital signature when sending.</p> <p> <b>NOTE</b></p> <p>If [On] is selected in "Digital Signature", [PDF/A-1a] and [PDF/A-1b] cannot be selected.</p> <p>➔ <a href="#">PDF/A (page 8-28)</a></p>
	Digital Signature Format	<p>Select an algorithm used for encryption of digital signature.</p> <p><b>Value:</b> SHA1, SHA-256, SHA-384, SHA-512</p> <p> <b>NOTE</b></p> <p>This function is displayed when "Digital Signature" is set to [Specify Each Job] or [On].</p>
	Password Confirmation on Signature Permission	<p>Select whether to confirm password when setting digital signature.</p> <p><b>Value:</b> On, Off</p> <p> <b>NOTE</b></p> <p>This function is displayed when "Digital Signature" is set to [Specify Each Job].</p>
	Password	<p>Set a password required for setting digital signature. Enter a new security password 6 to 16 alphanumeric characters and symbols.</p> <p> <b>NOTE</b></p> <p>This function is displayed when "Password Confirmation on Signature Permission" is set to [On].</p>

## Email

[Home] key > [...] > [System Menu] > [Function Settings] > [Email]

Item		Description
Email Settings	SMTP (Email TX)	Select whether to send E-mail using SMTP. <b>Value: Off, On</b>
	SMTP Server Name	Enter the host name or IP address of the SMTP server.  <b>NOTE</b> Up to 256 characters can be entered.
	SMTP Port Number	Specify the port number to be used for SMTP. The default port number is 25. <b>Value: 1 to 65535 (Port Number)</b>
	Sender Address	Specify the sender address for when the machine sends E-mails, such as the machine administrator, so that a reply or non-delivery report will go to a person rather than to the machine. The sender address must be entered correctly for SMTP authentication. The maximum length of the sender address is 256 characters.
	SMTP Auth and Sender Address	When the user login is set to ON, login user name, password and E-mail address of login user are used for SMTP authentication and e-mail sender address. <b>Value</b> <b>Use System Settings:</b> Information set with [Sender Address] is used for SMTP authentication and E-mail sender address information. <b>Use Login User Information:</b> Login User information is used for SMTP authentication and E-mail sender address information.  <b>NOTE</b> If there is no e-mail address set for the user who logged in, the Sender Address set with [Sender Address] is used for E-mail sender address information.
POP3	POP3	Select whether to receive E-mail using POP3. <b>Value: Off, On</b>
	Remote Printing	 <a href="#">Remote Printing (page 8-35)</a>

## Sending Job - Folder

[Home] key > [...] > [System Menu] > [Function Settings] > [Sending Job - Folder]

Item	Description
FTP Settings	Select whether to send documents using FTP. To use the FTP Client, set the protocol to [On] for "Protocol Settings". The default port number is 21. <b>Value: Off, On, 1 to 65535 (Port Number)</b>
SMB Settings	Select whether to send documents using SMB. To use the SMB Client, set the protocol to [On] for "Protocol Settings". The default port number is 445. <b>Value: Off, On, 1 to 65535 (Port Number)</b>

## Fax

[Home] key > [...] > [System Menu] > [Function Settings] > [Fax/iFax]

Configure settings for FAX.

 **FAX Operation Guide**

## WSD

[Home] key &gt; [...] &gt; [System Menu] &gt; [Function Settings] &gt; [WSD]

Item		Description
WSD Scan	Protocol Settings	Select whether to use WSD Scan. <sup>*1</sup> <b>Value: Off, On</b>
	Available Network	Set whether to enable this function for each network of Wi-Fi Direct, Wi-Fi and wired. <b>Value: Disable, Enable</b>
WSD Print	Protocol Settings	Select whether to use WSD Print. <sup>*1</sup> <b>Value: Off, On</b>
	Available Network	Set whether to enable this function for each network of Wi-Fi Direct, Wi-Fi and wired. <b>Value: Disable, Enable</b>

\*1 The setting will be changed after restarting the device or network.

## Address Book

[Home] key &gt; [...] &gt; [System Menu] &gt; [Function Settings] &gt; [Address Book]

Item		Description
Add/Edit Machine Address Book		Configure settings for address book. ➔ <a href="#">Adding a Destination (Address Book) (page 3-33)</a>
Machine Address Book	Sort	Select the default sort setting of the address for the address book. <b>Value: No., Name</b>
	Narrow Down	This procedure can be used to filter (narrow down) the types of destination listed when the address book is displayed. <b>Value: Off, Email, Folder, Fax, Group</b>
	Edit Restriction	Restrict editing of the address book. If you selected [Administrator Only], you can only edit the Address Book by logging in with administrator privileges. <b>Value: Off, Administrator Only</b>
External Address Book		➔ <b>Command Center RX User Guide</b>
Address Book Type <sup>*1</sup>		Select whether the machine's address book or the External Address Book appears when the address book is displayed. <b>Value: Machine Address Book, Ext Address Book</b>

\*1 This display appears only if the external address book is available.

## One-Touch Key

[Home] key &gt; [...] &gt; [System Menu] &gt; [Function Settings] &gt; [One-Touch Key]

Item	Description
Add/Edit One Touch Key	Configure settings for One Touch Key. ➔ <a href="#">Adding a Destination on One Touch Key (One Touch Key) (page 3-41)</a>
Edit Restriction	Restrict editing of the One Touch Key. If you selected [Administrator Only], you can only edit the One Touch Key by logging in with administrator privileges. <b>Value: Off, Administrator Only</b>

## Send and Forward

[Home] key > [...] > [System Menu] > [Function Settings] > [Send and Forward]

Item		Description
<b>Forward Settings</b>		Select whether to forward the original. <b>Value: Off, On</b>  <b>NOTE</b> When selecting [ <b>On</b> ], select rules to forward from [ <b>Email</b> ], [ <b>Folder (SMB)</b> ], [ <b>Folder (FTP)</b> ] and [ <b>Fax</b> ] <sup>*1</sup> .
<b>Destination</b>	<b>Add</b>	Set the destination to which the original is forwarded. One destination can be set. Follow the steps below to register the destination. <ul style="list-style-type: none"> <li>• Addr. Book</li> <li>• Email</li> <li>• SMB</li> <li>• FTP</li> </ul> <a href="#">➔ Specifying Destination (page 5-36)</a>

\*1 Displayed only on products with the fax function installed.

## Transfer Settings

[Home] key > [...] > [System Menu] > [Function Settings] > [Transfer Settings]

Configures settings for Transfer Settings.

➔ **FAX Operation Guide**



## Printer

[Home] key > [...] > [System Menu] > [Function Settings] > [Printer]

Item		Description
<b>Emulation</b>		Select the emulation for operating this machine by commands oriented to other types of printers. <b>Value: PCL6, IBM Proprinter, KPDL (Auto)</b>  <b>NOTE</b> <ul style="list-style-type: none"> <li>• When you have selected [<b>KPDL (Auto)</b>], set "Alt Emulation", too.</li> <li>• When you have selected [<b>KPDL</b>] or [<b>KPDL (Auto)</b>], set "KPDL Error Report", too.</li> </ul>
	<b>KPDL Error Report</b>	When an error has occurred during printing in KPDL emulation mode, set whether or not the error report is output. <b>Value: Off, On</b>
	<b>Alt Emulation</b>	When you have selected [ <b>KPDL (Auto)</b> ] as emulation mode, you can switch between KPDL and another emulation mode (alternative emulation) automatically according to the data to print. <b>Value: PCL6</b>
<b>EcoPrint</b>		EcoPrint conserves toner when printing. This is recommended for test copies where faded printing is not a problem. <b>Value: Off, On</b>



Item	Description
<b>Override A4/Letter</b>	<p>Select whether to treat A4 size and Letter, which are similar in size, as the same size when printing.</p> <p><b>Value</b></p> <p><b>Off:</b> A4 and Letter are not regarded as the same in size.</p> <p><b>On:</b> A4 and Letter are regarded as the same in size. The machine will use whichever size is in the paper source.</p>
<b>Duplex</b>	<p>Select binding orientation for duplex mode.</p> <p><b>Value:</b> 1-sided, 2-sided (Bind Long Edge), 2-sided (Bind Short Edge)</p>
<b>Copies</b>	<p>Set the default number of copies, from 1 to 999.</p> <p><b>Value:</b> 1 to 999 copies</p>
<b>Orientation</b>	<p>Set the default orientation, [Portrait] or [Landscape].</p> <p><b>Value:</b> Portrait, Landscape</p>
<b>Form Feed TimeOut</b>	<p>Receiving print data from the computer, the machine may sometimes wait if there is no information signaling that the last page does not have any more data to be printed. When the preset timeout passes, the machine automatically prints paper. The options are between 5 and 495 seconds.</p> <p><b>Value:</b> 5 to 495 seconds (in 5 second increments)</p>
<b>LF Action</b>	<p>Set the line feed action when the machine receives the line feed code (character code 0AH).</p> <p><b>Value:</b> LF Only, LF and CR, Ignore LF</p>
<b>CR Action</b>	<p>Set the character return action when the machine receives the character return code (character code 0DH).</p> <p><b>Value:</b> CR Only, LF and CR, Ignore CR</p>
<b>Job Name</b>	<p>Set whether the job name set in the printer driver is displayed.</p> <p><b>Value:</b> Off, On</p> <p> <b>NOTE</b></p> <p>When selecting [On], select the job name to be displayed from [Job Name], [Job No. &amp; Job Name], or [Job Name &amp; Job No.].</p>
<b>User Name</b>	<p>Set whether the user name set in the printer driver is displayed.</p> <p><b>Value:</b> Off, On</p>
<b>Paper Feed Mode</b>	<p>While printing from the computer, select how to feed paper when the paper source and type are specified.</p> <p><b>Value</b></p> <p><b>Auto:</b> Search the paper source that matches the selected paper size and type.</p> <p><b>Fixed:</b> Print on paper loaded in the specified paper source.</p>
<b>MP Tray Priority</b>	<p>If paper is set in the MP Tray then it is possible for priority to be given to that MP tray in the paper feed.</p> <p><b>Value</b></p> <p><b>Off:</b> The printer driver settings are followed.</p> <p><b>Auto Feed:</b> If Auto is selected in the printer driver and there is paper in the MP tray then the paper feed will be from the MP tray.</p> <p><b>Always:</b> If there is paper in the MP tray then the paper feed will be from the MP tray regardless of what is set in the printer driver.</p>

Item	Description
<b>Auto Cassette Change</b>	<p>Select the following actions when the paper runs out in the paper source while printing.  <b>Value: Off, On</b></p> <p> <b>NOTE</b></p> <ul style="list-style-type: none"> <li>• When selecting [<b>Off</b>], the machine displays "Add the following paper in cassette #." (# is a cassette number) or "Add the following paper in the multipurpose tray.", and stops printing.</li> <li>• Load the paper according to the paper source displayed to resume printing.</li> <li>• To print from the other paper cassette, select [<b>Paper Selection</b>]. Select the desired paper source.</li> <li>• When selecting [<b>On</b>], the machine continues printing automatically when the other cassette contains the same paper as the currently-used cassette.</li> </ul>
<b>Message Banner Print</b>	<p>Set whether the confirmation screen appears before each sheet is printed when printing multiple banner sheets.  <b>Value: Off, On</b></p>
<b>Wide A4</b>	<p>Turn this to on to increase the maximum number of characters that can be printed in a line for an A4 page (78 characters at 10 pitch) and Letter size page (80 characters at 10 pitch). This setting is only effective in PCL6 emulation.  <b>Value: Off, On</b></p>
<b>Resolution</b>	<p>Set the resolution used for printing.  <b>Value: 600 dpi, 1200 dpi</b></p> <p> <b>NOTE</b></p> <p>Settings that are received from the printer driver have priority over the operation panel settings.</p>
<b>KIR</b>	<p>Select the default KIR (smoothing) setting.  <b>Value: Off, On</b></p>
<b>Printing Job Terminator</b>	<p>You can select the condition which regarded as a job termination if the print job could not be processed until the end due to your environment and the other reason.  <b>Value:</b></p> <p><b>EOJ (End of Job):</b> The command recognized as a termination of the job data is regarded as one job until it is detected.</p> <p><b>End of Network Session:</b> The data included in a network session at network connection is regarded as one job.</p> <p><b>UEL (Universal Exit Language):</b> The UEL included in the termination of the job data is regarded as one job until it is detected.</p>
<b>Remote Printing</b>	<p>Select whether to prohibit printing that is performed without operating the machine. When [<b>Prohibit</b>] is selected, a document that has been stored in the document box from the printer driver can be printed from the machine. This prevents another person from seeing that document.  <b>Value: Prohibit, Permit</b></p> <p> <b>NOTE</b></p> <p>If [<b>Prohibit</b>] is selected, printing and storing using Quick Copy and Proof and Hold functions are disabled. Printing a received FAX (optional) is not prohibited.</p>
<b>Direct Printing from Web</b>	<p>Set whether to allow Direct Printing from Command Center RX.  <b>Value: Not Allowed, Allowed</b></p> <p>➔ <b>Command Center RX User Guide</b></p>



## Document Box

[Home] key > [...] > [System Menu] > [Function Settings] > [Document Box]

Item	Description
Custom Box - Add/Edit	➔ <a href="#">Creating a New Custom Box (page 5-50)</a>
Auto File Deletion Time	Set the time to automatically delete stored documents.
Quick Setup Registration (Storing in Box)	➔ <a href="#">Quick Setup Registration (Storing in Box) (page 8-10)</a>
Quick Setup Registration (Box Print)	➔ <a href="#">Quick Setup Registration (Box Print) (page 8-10)</a>
Quick Setup Registration (Sending from Box)	➔ <a href="#">Quick Setup Registration (Sending from Box) (page 8-10)</a>

## Job Box

[Home] key > [...] > [System Menu] > [Function Settings] > [Job Box]

Item	Description
Quick Copy Job Retention	To maintain free space on the hard disk, you can set the maximum number of stored jobs. <b>Value: number between 0 and 300</b>  <b>NOTE</b> When 0 is set, Quick Copy cannot be used.
Deletion of Job Retention	This setting specifies that documents, such as Private Printing, Quick Copying, or Proof and Hold Printing, saved temporarily in the job box are automatically deleted after they have been saved for a set time. <b>Value: Off, 1 hour, 4 hours, 1 day, 1 week</b>  <b>NOTE</b> This function is valid for documents saved after the function is set. Regardless of this function setting, temporary documents are deleted when the power switch is turned off.
Deletion of PIN Print at Power Off	Configures whether to delete the jobs retained in the PIN Print box when the power is turned off. <b>Value: Off, On</b>

## Subaddress Box Box

[Home] key > [...] > [System Menu] > [Function Settings] > [Subaddress Box Box]

Registers a fax box to be received by Subaddress Box communication.

➔ [FAX Operation Guide](#)

## Fax Memory RX Box

[Home] key > [...] > [System Menu] > [Function Settings] > [Fax Memory RX Box]

Set whether to perform print immediately for the FAX documents received or to save them in the Fax Memory RX Box.

➔ [FAX Operation Guide](#)

## Home

[Home] key > [...] > [System Menu] > [Function Settings] > [Home]

Configure settings for Home screen.

➔ [Editing the Home Screen \(page 2-19\)](#)

## Status

[Home] key > [...] > [System Menu] > [Function Settings] > [Status]

Item	Description
<b>Job Status/Job Logs Settings</b>	Set the display method of the Status/Log.
Display Jobs Detail Status	<b>Value:</b> Show All, My Jobs Only, Hide All
Display Jobs Log	<b>Value:</b> Show All, My Jobs Only, Hide All
Display Fax Log	<b>Value:</b> Show All, Hide All
Pause/Resume of All Print Jobs	<b>Value:</b> Prohibit, Permit

## Remote Services

[Home] key > [...] > [System Menu] > [Function Settings] > [Remote Services]

When the trouble occurs on this product, it is possible to explain the operational procedure and the troubleshooting method through the internet from our sales office by accessing the operation panel screen of this product while operating the screen.





### NOTE

When using the remote service settings, it is necessary to make a contract with our company. Please contact our sales office or our authorized dealer (purchase source) for the details.

**TWAIN/WIA**

[Home] key &gt; [...] &gt; [System Menu] &gt; [Function Settings] &gt; [TWAIN/WIA]

Item		Description
<b>Enhanced WSD</b>	<b>Protocol Settings</b>	Set whether to use our proprietary web services. <sup>*1</sup> <b>Value: Off, On</b>  <b>NOTE</b> Selecting [ <b>Off</b> ] will disable the functionality of WIA, TWAIN, and Network FAX driver.
	<b>Available Network</b>	Set whether to enable this function for each network of Wi-Fi Direct, Wi-Fi and wired. <b>Value: Disable, Enable</b>
<b>Enhanced WSD over TLS</b>	<b>Protocol Settings</b>	Set whether to use our proprietary web services over TLS. <sup>*1*2</sup> <b>Value: Off, On</b>  <b>NOTE</b> Selecting [ <b>Off</b> ] will disable the functionality of WIA, TWAIN and Network FAX drivers.
	<b>Available Network</b>	Set whether to enable this function for each network of Wi-Fi Direct, Wi-Fi and wired. <b>Value: Disable, Enable</b>

\*1 The setting will be changed after restarting the device or network.

\*2 Set "TLS" to [**On**] in Security Settings.➔ [TLS \(page 8-61\)](#) **IMPORTANT****Depending on the protocol, there are models where you need to restart the network or turn the machine OFF and then ON after changing the setting.**

## Network Settings

Configures network settings.

### Host Name

[Home] key > [...] > [System Menu] > [Network Settings] > "Network Settings" [Host Name]

Item	Description
Host Name	Check the host name of the machine. Host name can be changed from Command Center RX. <a href="#">➔ Changing Device Information (page 2-74)</a>

### Proxy

[Home] key > [...] > [System Menu] > [Network Settings] > "Network Settings" [Proxy]

Item	Description
Proxy	Set the proxy for connection to the Internet from an application. <b>Value: Off, Use Different Proxy Server, Use the Same Proxy Server for All Protocols</b>
Proxy Server (HTTP)	Set a proxy server (HTTP). <b>Value:</b> (Enter the proxy address and port number.)
Proxy Server (HTTPS)	Set a proxy server (HTTPS). This setup is available when "Proxy" is set to [Use Different Proxy Server]. <b>Value:</b> (Enter the proxy address and port number.)
Do Not Use Proxy for Following Domains	Set domains for which no proxy is used. <b>Value:</b> (Enter the domain name.)

### Wi-Fi Direct Settings

[Home] key > [...] > [System Menu] > [Network Settings] > "Network Settings" [Wi-Fi Direct Settings]





Set Wi-Fi Direct.

#### NOTE

This function is displayed when the Wireless Network Interface Kit (IB-37 or IB-38) is installed. The Wireless Network Interface Kit is an option for some models. Contact your dealer or our sales or service representatives for detail.

➔ [IB-37/IB-38 "Wireless Network Interface Kit" \(page 11-7\)](#)

Item	Description
Wi-Fi Direct	Select whether to use Wi-Fi Direct. <b>Value: Off, On</b>
Device Name	Specify the device name.  <b>NOTE</b> <ul style="list-style-type: none"> <li>Up to 32 characters can be entered.</li> <li>This function is displayed when [Wi-Fi Direct] is set to [On].</li> </ul>

Item	Description
<b>IP Address</b>	<p>Check the IP address of the machine.</p> <p>➔ <a href="#">TCP/IP Setting (page 8-44)</a></p> <p> <b>NOTE</b> This function is displayed when <b>[Wi-Fi Direct]</b> is set to <b>[On]</b>.</p>
<b>Auto Disconnect</b>	<p>Automatically disconnect devices connected through Wi-Fi Direct.</p> <p><b>Value: Off, On</b></p> <p> <b>NOTE</b></p> <ul style="list-style-type: none"> <li>• If you select <b>[ON]</b>, set the waiting time for automatic disconnection.</li> <li>• This function is displayed when <b>[Wi-Fi Direct]</b> is set to <b>[On]</b>.</li> </ul>
<b>Persistent Group</b>	<p>Set whether Wi-Fi Direct connection as Persistent Group (information for the connection is kept even if the power is turned off).</p> <p><b>Value: Off, On</b></p> <p> <b>NOTE</b> This function is displayed when <b>[Wi-Fi Direct]</b> is set to <b>[On]</b>.</p>
<b>Password</b>	<p>Select whether the Wi-Fi Direct password is automatically generated or created manually. When <b>[Off]</b> is selected, the Persistent Group setting changes to <b>[On]</b>.</p> <p><b>Value: Off, On</b></p> <p> <b>NOTE</b> If you selected <b>[On]</b>, set a password (8 or more characters).</p>
<b>Frequency band</b>	<p>Set the frequency band to be used.</p> <p><b>Value: 2.4GHz, 5Ghz</b></p>

## Wi-Fi Settings

[Home] key > [...] > [System Menu] > [Network Settings] > "Network Settings" [Wi-Fi Settings]

Set Wi-Fi.

### NOTE

This function is displayed when the Wireless Network Interface Kit (IB-37 or IB-38) is installed. The Wireless Network Interface Kit is an option for some models. Contact your dealer or our sales or service representatives for detail.



➔ [IB-37/IB-38 "Wireless Network Interface Kit" \(page 11-7\)](#)

## Wi-Fi

Item	Description
<b>Wi-Fi</b>	<p>Select whether to use Wi-Fi.</p> <p><b>Value: Off, On</b></p>





## Setup

Item	Description
<b>Available Network</b>	Displays access points to which the machine can connect.
<b>Index</b>	<p>Select the key index of the access point.</p> <p><b>Value: 0 to 3</b></p>

Item	Description
<b>Push Button Method</b>	If the access point supports the push button method, wireless settings can be configured using the push button. This setting executes push button, and the connection is started by pressing the push button on the access point.   <b>NOTE</b> The push button method supports only the WPS.
<b>PIN Code Method (Device)</b>	Starts connection using the machine's PIN code. Enter the PIN code into the access point. The PIN code of the machine is automatically generated.
<b>Custom Setup</b>	The detailed settings for wireless LAN can be changed.
<b>Network Name (SSID)</b>	Set the SSID (Service Set Identifier) of the wireless LAN to which the machine connects.   <b>NOTE</b> Up to 32 characters can be entered.
<b>Network Authentication</b>	Select network authentication type. <b>Value:</b> Open, WPA2/WPA-PSK, WPA2-PSK, WPA2/WPA-EAP, WPA2-EAP, WPA3-SAE/WPA2-PSK, WPA3-SAE, WPA3/WPA2-EAP, WPA3-EAP
<b>Encryption</b>	Select encryption method. The setting values vary depending on the Network Authentication setting. <b>Value</b> <b>WPA2/WPA-PSK</b> <b>AES, Auto, Preshared Key</b> (Up to 64 characters) <b>WPA2-PSK</b> <b>Preshared Key</b> (Up to 64 characters) <b>WPA2/WPA-EAP</b> <b>AES, Auto</b> <b>WPA2-EAP</b> — <b>WPA3-SAE/WPA2-PSK</b> <b>Preshared Key</b> <b>WPA3-SAE</b> <b>Preshared Key</b> <b>WPA3/WPA2-EAP</b> — <b>WPA3-EAP</b> —







## TCP/IP Setting

Item	Description
<b>TCP/IP</b>	Select whether to use TCP/IP Protocol. <b>Value: Off, On</b>
<b>IPv4 Settings</b>	Set up TCP/IP (IPv4) to connect to the network. This setting is available when [TCP/IP] is set to [On].
<b>DHCP</b>	Select whether to use the DHCP (IPv4) server. <b>Value: Off, On</b>
<b>Auto-IP</b>	Select whether to use Auto-IP. <b>Value: Off, On</b>
<b>IP Address</b>	Set the IP address. <b>Value: ###.###.###.###</b>  <b>NOTE</b> When DHCP is set to [On], the value cannot be entered.
<b>Subnet Mask</b>	Set the IP subnet mask. <b>Value: ###.###.###.###</b>  <b>NOTE</b> When DHCP is set to [On], the value cannot be entered.
<b>Default Gateway</b>	Set the IP gateway address. <b>Value: ###.###.###.###</b>  <b>NOTE</b> When DHCP is set to [On], the value cannot be entered.
<b>DNS Server Address</b>	Set the IP address of DNS (Domain Name System) server. <b>Value: Use DNS Server from DHCP, Use following DNS Server</b>  <b>NOTE</b> When [Use following DNS Server] is selected, you can enter static DNS server information in the Primary and Secondary fields provided.
<b>DNS over TLS</b>	Set whether to connect to a DNS server during communication protected by TLS. <b>Value: Off, On, Auto</b>

 **IMPORTANT**

- When setting the Auto-IP, enter "0.0.0.0" in [IP Address].
- After changing the setting, restart the network or turn the machine OFF and then ON.

Item	Description
<b>IPv6 Settings</b>	Set up TCP/IP (IPv6) to connect to the network. This setting is available when [TCP/IP] is [On].
<b>IPv6</b>	Select whether to use IPv6. <b>Value:</b> Off, On  <b>NOTE</b> Selecting [On] displays IP address in [IP Addr. (Link Local)] after restarting the network.
<b>Manual Setting</b>	Manually specify the IP address, prefix length, and gateway address of TCP/IP (IPv6). <b>Value</b> <b>IP Address (Manual):</b> 128-bits address is expressed in eight groups consisting of four-digit hexadecimal digits. The groups are separated by colon (:). <b>Prefix Length:</b> 0 to 128 <b>Default Gateway:</b> 128-bits address is expressed in eight groups consisting of four-digit hexadecimal digits. The groups are separated by colon (:).  <b>NOTE</b> This function is displayed when [IPv6] is set to [On]. To enter "Default Gateway", set [RA (Stateless)] to [Off].
<b>RA (Stateless)</b>	Select whether to use RA (Stateless). <b>Value:</b> Off, On  <b>NOTE</b> This function is displayed when [IPv6] is set to [On]. Selecting [On] displays IP address in [IP Address (Stateless)] after restarting the network.
<b>DHCP</b>	Select whether to use the DHCP (IPv6) server. <b>Value:</b> Off, On  <b>NOTE</b> This function is displayed when [IPv6] is set to [On]. Selecting [On] displays IP address in [IP Address (Stateful)] after restarting the network.
<b>DNS Server Address</b>	Set the IP address of DNS (Domain Name System) server. <b>Value:</b> Use DNS Server from DHCP, Use following DNS Server  <b>NOTE</b> When [Use following DNS Server] is selected, you can enter static DNS server information in the Primary and Secondary fields provided.
<b>DNS over TLS</b>	Set whether to connect to a DNS server during communication protected by TLS. <b>Value:</b> Off, On, Auto

 **IMPORTANT**





After changing the setting, restart the network or turn the machine OFF and then ON.

## Wired Network Settings

[Home] key > [...] > [System Menu] > [Network Settings] > "Network Settings" [Wired Network Settings]







Configure wired network settings.

### TCP/IP Setting

Item	Description
<b>TCP/IP</b>	Select whether to use TCP/IP Protocol. <b>Value:</b> Off, On
<b>IPv4 Settings</b>	Set up TCP/IP (IPv4) to connect to the network. This setting is available when [TCP/IP] is set to [On].
<b>DHCP</b>	Select whether to use the DHCP (IPv4) server. <b>Value:</b> Off, On
<b>Auto-IP</b>	Select whether to use Auto-IP. <b>Value:</b> Off, On
<b>IP Address</b>	Set the IP address. <b>Value:</b> ###.###.###.###  <b>NOTE</b> When DHCP is set to [On], the value cannot be entered.
<b>Subnet Mask</b>	Set the IP subnet mask. <b>Value:</b> ###.###.###.###  <b>NOTE</b> When DHCP is set to [On], the value cannot be entered.
<b>Default Gateway</b>	Set the IP gateway address. <b>Value:</b> ###.###.###.###  <b>NOTE</b> When DHCP is set to [On], the value cannot be entered.
<b>Domain Name</b>	Enter the domain name.  <b>NOTE</b> When DHCP is set to [On], the value cannot be entered.
<b>DNS Server Address</b>	Set the IP address of DNS (Domain Name System) server. <b>Value:</b> Use DNS Server from DHCP, Use following DNS Server  <b>NOTE</b> When [Use following DNS Server] is selected, you can enter static DNS server information in the Primary and Secondary fields provided.
<b>DNS over TLS</b>	Set whether to connect to a DNS server during communication protected by TLS. <b>Value:</b> Off, On, Auto

#### IMPORTANT

- When setting the Auto-IP, enter "0.0.0.0" in [IP Address].
- After changing the setting, restart the network or turn the machine OFF and then ON.

Item	Description
<b>IPv6 Settings</b>	Set up TCP/IP (IPv6) to connect to the network. This setting is available when [TCP/IP] is [On].
<b>IPv6</b>	Select whether to use IPv6. <b>Value:</b> Off, On  <b>NOTE</b> Selecting [On] displays IP address in [IP Addr. (Link Local)] after restarting the network.
<b>Manual Setting</b>	Manually specify the IP address, prefix length, and gateway address of TCP/IP (IPv6). <b>Value</b> <b>IP Address (Manual):</b> 128-bits address is expressed in eight groups consisting of four-digit hexadecimal digits. The groups are separated by colon (:). <b>Prefix Length:</b> 0 to 128 <b>Default Gateway:</b> 128-bits address is expressed in eight groups consisting of four-digit hexadecimal digits. The groups are separated by colon (:).  <b>NOTE</b> This function is displayed when [IPv6] is set to [On]. To enter "Default Gateway", set [RA (Stateless)] to [Off].
<b>RA (Stateless)</b>	Select whether to use RA (Stateless). <b>Value:</b> Off, On  <b>NOTE</b> This function is displayed when [IPv6] is set to [On]. Selecting [On] displays IP address in [IP Address 1 to 5 (Stateless)] after restarting the network.
<b>DHCP</b>	Select whether to use the DHCP (IPv6) server. <b>Value:</b> Off, On  <b>NOTE</b> This function is displayed when [IPv6] is set to [On]. Selecting [On] displays IP address in [IP Address (Stateful)] after restarting the network.
<b>Domain Name</b>	Enter the domain name.  <b>NOTE</b> When DHCP is set to [On], the value cannot be entered.
<b>DNS Server Address</b>	Set the IP address of DNS (Domain Name System) server. <b>Value:</b> Use DNS Server from DHCP, Use following DNS Server  <b>NOTE</b> When [Use following DNS Server] is selected, you can enter static DNS server information in the Primary and Secondary fields provided.
<b>DNS over TLS</b>	Set whether to connect to a DNS server during communication protected by TLS. <b>Value:</b> Off, On, Auto

 **IMPORTANT****After changing the setting, restart the network or turn the machine OFF and then ON.**

## Others

Item	Description
<b>LAN Interface</b>	Specify the settings for the LAN interface to be used. <b>Value:</b> Auto, 10BASE-T Half, 10BASE-T Full, 100BASE-TX Half, 100BASE-TX Full, 1000BASE-T

 **IMPORTANT**



After changing the setting, restart the network or turn the machine OFF and then ON.



## Protocol Settings





[Home] key > [...] > [System Menu] > [Network Settings] > "Network Settings" [Protocol Settings]

Configure protocol settings.

Item	Description
<b>SMTP (Email TX)</b>	➔ <a href="#">Email Settings (page 8-31)</a>
<b>POP3 (Email RX)</b>	➔ <a href="#">POP3 (page 8-31)</a>
<b>FTP Client (Transmission)</b>	➔ <a href="#">FTP Settings (page 8-31)</a>
<b>FTP Server (Reception)</b>	<b>Protocol Settings</b> Select whether to receive documents using FTP.* <sup>1</sup> <b>Value:</b> Off, On
	<b>Available Network</b> Set whether to enable this function for each network of Wi-Fi Direct, Wi-Fi and wired. <b>Value:</b> Disable, Enable
<b>SMB Client (Transmission)</b>	➔ <a href="#">SMB Settings (page 8-31)</a>
<b>NetBEUI</b>	<b>Protocol Settings</b> Selects whether to receive documents using NetBEUI.* <sup>1</sup> <b>Value:</b> Off, On
	<b>Available Network</b> Set whether to enable this function for each network of Wi-Fi Direct, Wi-Fi and wired. <b>Value:</b> Disable, Enable
<b>WSD Scan</b>	➔ <a href="#">WSD Scan (page 8-32)</a>
<b>WSD Print</b>	➔ <a href="#">WSD Print (page 8-32)</a>

Item		Description
ThinPrint	Protocol Settings	Select whether to use ThinPrint. To use the Thin Print protocol, set the protocol to [On]. The default port number is 4000.*1*2 <b>Value: Off, On</b>  <b>NOTE</b> This function is displayed only when the optional ThinPrint Option is activated.
	Thin Print over TLS	To use the Thin Print over TLS protocol, set [Thin Print Over TLS] and [TLS] to [On]. <b>Value: Off, On</b>  <b>NOTE</b> When selecting [On], it also requires a certificate for TLS. The default certificate is the self-certificate of the machine. <a href="#">▶ Command Center RX User Guide</a>
	Available Network	Set whether to enable this function for each network of Wi-Fi Direct, Wi-Fi and wired. <b>Value: Disable, Enable</b>
LPD	Protocol Settings	Selects whether to receive documents using LPD.*1 <b>Value: Off, On</b>
	Available Network	Set whether to enable this function for each network of Wi-Fi Direct, Wi-Fi and wired. <b>Value: Disable, Enable</b>
Raw	Protocol Settings	Select whether to receive documents using Raw Port.*1 <b>Value: Off, On</b>
	Available Network	Set whether to enable this function for each network of Wi-Fi Direct, Wi-Fi and wired. <b>Value: Disable, Enable</b>
IPP	Protocol Settings	Selects whether to receive documents using IPP. To use the IPP protocol, set [IPP] to [On], and set [TLS] to [Off]. In addition, select [Not Secure (IPP&IPPS)] on IPP Security under Security Settings from the Command Center RX. The default port number is 631.*1 <b>Value: Off, On, 1 to 32767 (Port Number)</b>
	Available Network	Set whether to enable this function for each network of Wi-Fi Direct, Wi-Fi and wired. <b>Value: Disable, Enable</b>
IPP over TLS	Protocol Settings	To use the IPP protocol, set [IPP] and [TLS] to [On]. The default port number is 443.*1*2 <b>Value: Off, On, 1 to 32767 (Port Number)</b>  <b>NOTE</b> When selecting [On], it also requires a certificate for TLS. the default certificate is the self-certificate of the machine. <a href="#">▶ Command Center RX User Guide</a>
	Available Network	Set whether to enable this function for each network of Wi-Fi Direct, Wi-Fi and wired. <b>Value: Disable, Enable</b>

Item		Description
HTTP	Protocol Settings	Select whether to communicate using HTTP.* <sup>1</sup> <b>Value: Off, On</b>
	Available Network	Set whether to enable this function for each network of Wi-Fi Direct, Wi-Fi and wired. <b>Value: Disable, Enable</b>
HTTPS	Protocol Settings	Select whether to communicate using HTTPS.* <sup>1*2</sup> <b>Value: Off, On</b>
	Available Network	Set whether to enable this function for each network of Wi-Fi Direct, Wi-Fi and wired. <b>Value: Disable, Enable</b>
LDAP		Select whether to use LDAP. <b>Value: Off, On</b>
SNMPv1/v2c	Protocol Settings	Select whether to communicate using SNMP.* <sup>1</sup> <b>Value: Off, On</b>
	Available Network	Set whether to enable this function for each network of Wi-Fi Direct, Wi-Fi and wired. <b>Value: Disable, Enable</b>
SNMPv3	Protocol Settings	Select whether to communicate using SNMPv3.* <sup>1</sup> <b>Value: Off, On</b>
	Available Network	Set whether to enable this function for each network of Wi-Fi Direct, Wi-Fi and wired. <b>Value: Disable, Enable</b>
Enhanced WSD	Protocol Settings	Set whether to use our proprietary web services.* <sup>1</sup> <b>Value: Off, On</b>  <b>NOTE</b> Selecting [ <b>Off</b> ] will disable the functionality of WIA, TWAIN, and Network FAX driver.
	Available Network	Set whether to enable this function for each network of Wi-Fi Direct, Wi-Fi and wired. <b>Value: Disable, Enable</b>
Enhanced WSD over TLS	Protocol Settings	Set whether to use our proprietary web services over TLS.* <sup>1*2</sup> <b>Value: Off, On</b>  <b>NOTE</b> Selecting [ <b>Off</b> ] will disable the functionality of WIA, TWAIN and Network FAX drivers.
	Available Network	Set whether to enable this function for each network of Wi-Fi Direct, Wi-Fi and wired. <b>Value: Disable, Enable</b>
eSCL	Protocol Settings	Selects whether to receive scanned documents using eSCL.* <sup>1</sup> <b>Value: Off, On</b>
	Available Network	Set whether to enable this function for each network of Wi-Fi Direct, Wi-Fi and wired. <b>Value: Disable, Enable</b>

Item		Description
eSCL over TLS	Protocol Settings	Selects whether to receive scanned documents using eSCL over TLS. <sup>*1*2</sup> <b>Value: Off, On</b>
	Available Network	Set whether to enable this function for each network of Wi-Fi Direct, Wi-Fi and wired. <b>Value: Disable, Enable</b>
VNC (RFB)	Protocol Settings	This is set when starting up a VNC Viewer (E.g. RealVNC) to use the Remote Operation. <sup>*1</sup> The default port number is 9062. <b>Value: Off, On, 1 to 32767 (Port Number)</b>
	Available Network	Set whether to enable this function for each network of Wi-Fi Direct, Wi-Fi and wired. <b>Value: Disable, Enable</b>
VNC (RFB) over TLS	Protocol Settings	This is set when starting up a VNC Viewer (E.g. RealVNC) to use Remote Operation protected by TLS. <sup>*1*2</sup> The default port number is 9063. <b>Value: Off, On, 1 to 32767 (Port Number)</b>   <b>NOTE</b> When selecting [On], it also requires a certificate for TLS. The default certificate is the self-certificate of the machine.   <b>Command Center RX User Guide</b>
	Available Network	Set whether to enable this function for each network of Wi-Fi Direct, Wi-Fi and wired. <b>Value: Disable, Enable</b>
Enhanced VNC over TLS	Protocol Settings	This is set when starting up Command Center RX to use Remote Operation protected by TLS. <sup>*1*2</sup> The default port number is 9061. <b>Value: Off, On, 1 to 32767 (Port Number)</b>   <b>NOTE</b> <ul style="list-style-type: none"> <li>The default setting is [On].</li> <li>When selecting [On], it also requires a certificate for TLS. The default certificate is the self-certificate of the machine.</li> </ul>  <b>Command Center RX User Guide</b>
	Available Network	Set whether to enable this function for each network of Wi-Fi Direct, Wi-Fi and wired. <b>Value: Disable, Enable</b>

\*1 The setting will be changed after restarting the device or network.

\*2 Set "TLS" to [On] in Security Settings.

 [TLS \(page 8-61\)](#)

### IMPORTANT

Depending on the protocol, there are models where you need to restart the network or turn the machine OFF and then ON after changing the setting.



## Ping

[Home] key > [...] > [System Menu] > [Network Settings] > "Network Settings" [Ping]

Item	Description
<b>Ping</b>	<p>Checks if communication with the destination by entering the host name or IP address of the destination is possible.</p> <p> <b>NOTE</b> If [Primary Network (Client)] is set to [Others], this item is not displayed.</p> <p>➔ <a href="#">Primary Network (Client) (page 8-55)</a></p>
<b>Ping Timeout</b>	➔ <a href="#">Ping Timeout (page 8-9)</a>

## Bonjour

[Home] key > [...] > [System Menu] > [Network Settings] > "Network Settings" [Bonjour]

Item	Description
<b>Bonjour</b>	<p><b>Protocol Settings</b></p> <p>Select whether to use Bonjour. <b>Value: Off, On</b></p>
	<p><b>Available Network</b></p> <p>Set whether to enable this function for each network of Wi-Fi Direct, Wi-Fi and wired. <b>Value: Disable, Enable</b></p>

## IP Filter (IPv4)

[Home] key > [...] > [System Menu] > [Network Settings] > "Network Settings" [IP Filter (IPv4)]

Item	Description
<b>IP Filter (IPv4)</b>	<p>Configure IP filters. IP filters restrict access to the machine based on the IP addresses and protocols.</p> <p>Specify the IP addresses or network addresses of the hosts to which access is granted from Command Center RX. If nothing is specified on this page, access from all hosts is allowed.</p> <p><b>Value: Off, On</b></p> <p>➔ <b>Command Center RX User Guide</b></p>

## IP Filter (IPv6)

[Home] key > [...] > [System Menu] > [Network Settings] > "Network Settings" [IP Filter (IPv6)]

Item	Description
<b>IP Filter (IPv6)</b>	<p>Configure IP filters. IP filters restrict access to the machine based on the IP addresses and protocols.</p> <p>Specify the IP addresses or network addresses of the hosts to which access is granted from Command Center RX. If nothing is specified on this page, access from all hosts is allowed.</p> <p><b>Value: Off, On</b></p> <p>➔ <b>Command Center RX User Guide</b></p>

## IPSec

[Home] key > [...] > [System Menu] > [Network Settings] > "Network Settings" [IPSec]

Item	Description
<b>IPSec</b>	Select whether to use IPSec. <b>Value:</b> Off, On

## Restart Network

[Home] key > [...] > [System Menu] > [Network Settings] > "Network Settings" [Restart Network]

Item	Description
<b>Restart Network</b>	Restarts the network.

## Optional Network

[Home] key > [...] > [System Menu] > [Network Settings] > "Optional Network"

Configure settings for the optional Network Interface Kit.

 **NOTE**  
This menu is displayed when the optional Network Interface Kit or Wireless Network Interface Kit is installed.

## Host Name



Item	Description
<b>Host Name</b>	Check the host name of the machine. Host name can be changed from Command Center RX. <a href="#">➔ Changing Device Information (page 2-74)</a>

## Wireless Network

Configure settings for the optional Wireless Network Interface Kit.

 **NOTE**  
This function is displayed when the Wireless Network Interface Kit (IB-51) is installed.

Item	Description	
<b>Connection Status</b>	You can check the wireless LAN status.	
<b>Setup</b>	<b>Available Network</b>	Select access points to which the machine can be connected, enter the Preshared Key and start a connection.
	<b>Push Button Method</b>	If the access point supports the push button method, wireless settings can be configured using the push button. This setting executes push button, and the connection is started by pressing the push button on the access point.  <b>NOTE</b> The push button method supports only the WPS.
	<b>PIN Code Method (Device)</b>	Starts connection using the machine's PIN code. Enter the PIN code into the access point. The PIN code of the machine is automatically generated.
	<b>PIN Code Method (Terminal)</b>	Starts connection using the PIN code of the access point. Enter the PIN code of the access point.

Item		Description
<b>Setup</b>	<b>Custom Setup</b>	The detailed settings for wireless LAN can be changed.
	<b>Network Name (SSID)</b>	Set the SSID (Service Set Identifier) of the wireless LAN to which the machine connects.  <b>NOTE</b> Up to 32 characters can be entered.
	<b>Connection Mode</b>	Set the connection mode. <b>Value: Ad Hoc, Infrastructure</b>  <b>NOTE</b> <ul style="list-style-type: none"> <li>• <b>Ad Hoc:</b> Directly communicates with the device without going through an access point. This method cannot be used to connect to two or more devices.</li> <li>• <b>Infrastructure:</b> Performs communication through an access point.</li> </ul>
	<b>Channel</b>	Set channel. Use [-] / [+] or the numeric keys to enter a number. <b>Value: 1 to 11</b>
	<b>Network Authentication</b>	Select network authentication type. To select other options, open the device home page from a computer. <b>Value: Open, Shared, WPA-PSK*1, WPA2-PSK*1</b>
	<b>Encryption</b>	Select encryption method. If the option other than <b>[Disable]</b> is selected, enter the WEP key or the Preshared key. The setting values vary depending on the Network Authentication setting. Select <b>[Data Encryption]</b> . <b>When Network Authentication is set to [Open] or [Shared]:</b> <b>Value: Disable, WEP</b> <b>When Network Authentication is set to [WPA-PSK] or [WPA2-PSK]:</b> <b>Value: TKIP*2, AES, Auto*2, Preshared Key</b>  <b>NOTE</b> <ul style="list-style-type: none"> <li>• If <b>[WEP]</b> is selected, enter the WEP key. Up to 26 characters can be entered.</li> <li>• If <b>[TKIP]</b>, <b>[AES]</b> or <b>[Auto]</b> is selected, enter the Preshared key. Enter the value in 8 to 64 characters.</li> </ul>
<b>TCP/IP Setting</b>		For details on setting value. ➔ <a href="#">TCP/IP Setting (page 8-44)</a> ➔ <a href="#">Bonjour (page 8-50)</a> ➔ <a href="#">IPSec (page 8-51)</a>
<b>Others</b>		For details on setting value. ➔ <a href="#">NetWare (page 8-53)</a> ➔ <a href="#">AppleTalk (page 8-53)</a> ➔ <a href="#">MAC Address Filter (page 8-53)</a>

\*1 Not displayed if you selected **[Ad Hoc]** for "Connection Mode".

\*2 Not displayed if you selected **[WPA2-PSK]** for "Network Authentication".

## Wired Network Settings



### NOTE

This menu is displayed when the optional Network Interface Kit (IB-50) is installed.

Item		Description
<b>TCP/IP Setting</b>		For details on setting value. ➔ <a href="#">TCP/IP Setting (page 8-44)</a> ➔ <a href="#">Bonjour (page 8-50)</a> ➔ <a href="#">IPSec (page 8-51)</a>
<b>Others</b>	<b>NetWare</b>	Use NetWare to receive documents. ➔ <b>Operation Guide</b> for the optional Network Interface Kit <b>Value: Off, On</b>
	<b>AppleTalk</b>	Selects whether to receive documents using AppleTalk. <sup>*1</sup> <b>Value: Off, On</b>
	<b>LAN Interface</b>	Select the LAN Interface type. <sup>*1</sup> <b>Value: Auto, 10Base-Half, 10Base-Full, 100Base-Half, 100Base-Full, 1000BASE-T</b> <b>NOTE</b> This function is displayed when the optional Network Interface Kit is installed.
	<b>MAC Address Filter</b>	Select whether to use MAC Address Filter. ➔ <b>Operation Guide</b> for the optional Network Interface Kit <b>Value: Off, On</b>



\*1 The setting will be changed after restarting the device or network.

## Restart Network

Item	Description
<b>Restart Network</b>	Restarts the network.

## Connectivity

[Home] key > [...] > [System Menu] > [Network Settings] > "Connectivity"

Item		Description
<b>Bluetooth Settings</b>	<b>Bluetooth Keyboard</b>	Use Bluetooth keyboard. <b>Value: Off, On</b>
	<b>Device</b>	Select a keyboard.
<b>Fax Server</b>	<b>Fax Server</b>	Select whether to use FAX Server. <b>Value: On, Off</b>
	<b>Address Settings</b>	This specifies a prefix, suffix, and domain name to be attached to a destination.  <b>NOTE</b> For information about the fax server, contact the fax server administrator.
	<b>File Format</b>	Set the default type of the files. <b>Value: PDF, TIFF, XPS</b>
	<b>Address Book Type</b>	This specifies the External Address Book to be used.  <b>NOTE</b> <ul style="list-style-type: none"> <li>• This setting is available when [FAX Server] is set to [On].</li> <li>• This is not displayed if the External Address Book setting is not configured.</li> </ul> <p>➔ <b>Command Center RX User Guide</b></p>
<b>Remote Operation</b>		Configure settings for remote operation. <b>Value: Off, On</b> When you set it to [On], set the Use Restriction. <b>Value: Off, Use Password, Administrator Only</b> When selecting [Off], users without administrator privileges can also execute remote operation. When selecting [Use Password], enter the password, then re-enter it to confirm. When selecting [Administrator Only], only administrator can execute remote operation.  <b>NOTE</b> When selecting [Administrator Only], the remote operation using VNC software is unavailable.

## Others

[Home] key > [...] > [System Menu] > [Network Settings] > "Others"

### NOTE

This function is displayed when the optional Network Interface Kit (IB-50) or Wireless Network Interface Kit (IB-37, IB-38 or IB-51) is installed.

The Wireless Network Interface Kit (IB-37 or IB-38) is an option for some models. Contact your dealer or our sales or service representatives for detail.

➔ [IB-37/IB-38 "Wireless Network Interface Kit" \(page 11-7\)](#)

Item	Description
<b>Primary Network (Client)</b>	Select the network interface to be used for the send function that this machine functions as a client, the network authentication and connecting to external address book. <b>Value: Wi-Fi, Wired Network, Optional Network</b> <ul style="list-style-type: none"> <li>• [Wi-Fi] is displayed when the Wireless Network Interface Kit (IB-37 or IB-38) is installed.</li> <li>• [Optional Network] is displayed when the optional Network Interface Kit (IB-50) or Wireless Network Interface Kit (IB-51) is installed.</li> <li>• You can set and use "[Wired Network] or [Wi-Fi]", and "[Optional Network] (IB-50 or IB-51)" individually for the e-mail send connection.</li> </ul>
<b>Restart Entire Device</b>	Restart the machine without turning the power switch off. Use this to deal with any unstable operation by the machine. (Same as the computer restart.)

## Security Settings

Configures security settings.

### Security Quick Setup

[Home] key > [...] > [System Menu] > [Security Settings] > [Security Quick Setup]

Item	Description
<b>Security Quick Setup</b>	Select a security level close to the your operating environment, and customize the security functions as necessary. <b>Value</b> <b>Level 1: This is the factory default.</b> <b>Level 2: The security functions of network are changed.</b> <b>Level 3: All functions that protect the machine are enabled, and functions that are not protected are disabled.</b>   <b>NOTE</b> <ul style="list-style-type: none"> <li>• This function is available when you have logged in as administrator.</li> <li>➔ <a href="#">Log in as Machine Administrator or Administrator (page 2-68)</a></li> <li>• The settings will be enabled when the device or network is restarted after selecting the level.</li> <li>➔ <a href="#">Restart Entire Device (page 8-64)</a></li> <li>➔ <a href="#">Restart Network (page 8-53)</a></li> <li>• If you change any security settings after selecting the security level, "Custom" is displayed on Security Quick Setup.</li> <li>• For more information on each security level setting, refer to the following:</li> <li>➔ <a href="#">Functions List of Security Quick Setup (page 11-30)</a></li> </ul>

The configuration methods are as follows:

## 1 Display the screen.

[Home] key > [...] > [System Menu] > [Security Settings] > [Security Quick Setup]



### NOTE

If the User Authentication screen appears, log in with a user who has the privilege to configure this setting. If you do not know your login User Name or Password, please contact your Administrator.

## 2 Select a security level according to your operating environment.

## 3 Configure the security function as necessary.



### NOTE

Refer to the following for the settings of each security level.

➔ [Security Level on page 8-57](#)

## 4 Restart the device or network.

➔ [Restart Entire Device \(page 8-64\)](#)

➔ [Restart Network \(page 8-53\)](#)

## Interface Block Setting



[Home] key > [...] > [System Menu] > [Security Settings] > "Interface Block Setting"

This allows you to protect this machine by blocking the interface with external devices such as USB hosts or optional interfaces.

Item	Description
<b>USB Host</b>	This locks and protects the USB port (USB host). <b>Value: Unblock, Block</b>
<b>USB Device</b>	This locks and protects the USB interface connector (USB Device). <b>Value: Unblock, Block</b>
<b>USB Drive</b>	This locks and protects the USB memory slot. <b>Value: Unblock, Block</b> <b>NOTE</b> This function is available when USB Host is set to [ <b>Unblock</b> ].
<b>Optional Interface</b>	This locks and protects the optional interface slots. <b>Value: Unblock, Block</b> <b>NOTE</b> You can set this feature for each slot.
<b>Restart Entire Device</b>	Restart the machine without turning the power switch off. <b>IMPORTANT</b> <b>After changing "Interface Block Setting", restart the network or turn the machine OFF and then ON.</b>

## Device Security Settings

[Home] key > [...] > [System Menu] > [Security Settings] > "Device Security Settings"

Item	Description
<b>Unusable Time</b> *1	Set a time period during which the machine will not print received faxes. ➔ <b>FAX Operation Guide</b>
<b>Job Status/Job Logs Settings</b>	➔ <a href="#">Job Status/Job Logs Settings (page 8-37)</a>
<b>Security Level</b>	Specify the security level. <b>Value</b> <b>Low:</b> This mode is used during maintenance. Do not use normally. <b>High:</b> This is the security setting we recommend. Use this setting normally. <b>Very High:</b> In addition to [ <b>High</b> ] setting, this setting disables the machine settings to be changed from external command.  <b>NOTE</b> This function is available when you have logged in as machine administrator. ➔ <a href="#">Adding a User (Local User List) (page 9-6)</a>
<b>Remote Printing</b>	➔ <a href="#">Remote Printing (page 8-35)</a>
<b>RAM Disk Settings</b>	Create a RAM disk and set its capacity. You can print print data from the job box by creating a RAM disk. <b>Value</b> <b>RAM Disk Settings : Off , On</b> <b>RAM Disk Size :</b> Setting range varies depending on size of onboard memory and optional memory usage.  <b>IMPORTANT</b> After changing the setting, restart the system or turn the machine OFF and then ON.
<b>Software Verification</b>	Verify the installed software. Select [ <b>Start Verification</b> ] to start verification. If an error occurs during software verification, contact your dealer or service representative.
<b>Administrator Authentication on Firm Update</b>	Request administrator to approve when updating firmware. <b>Value: Off, On</b>
<b>Secure Boot</b>	Secure Boot is a function that detects tampering with firmware when the machine boots. It verifies the digital signature assigned to the firmware, and prevents the firmware from running if it detects tampering. <b>Value: BIOS, BIOS+Firmware</b>  <b>IMPORTANT</b> When tampering is detected and Secure Boot fails, the panel screen turns white after one minute.







Item	Description
<b>Allowlisting</b>	<p>In case if the unauthorized program or the program that has tampered are installed, the stored data or the contents of the communication in this program might be stolen.</p> <p>Once this function is activated, execution of the unauthorized software or the tampering of the software can be prevented, and possible to maintain the reliability of the system.</p> <p><b>Value: Off, On</b></p> <p> <b>NOTE</b></p> <ul style="list-style-type: none"> <li>• After setting to [On], it is necessary to turn the power off and on.</li> <li>• Once this function is activated, the start up of this product will be slowed.</li> <li>• When detecting the unauthorized program, in order to grasp the contents easier, we recommend to enable the setting of;</li> </ul> <p>Command Center RX &gt; [Management Settings: History settings] &gt; [Device Log History] and [Management Settings: Notification/Report] &gt; [Notify when Malicious Program is Detected] should be [On].</p> <p>➔ <b>Command Center RX User Guide</b></p> <ul style="list-style-type: none"> <li>• In case of setting [Security Quick Setup screen] to [Level 3], [Device Log History] in the [Management Settings: History Settings] will be set to [On].</li> </ul> <p>➔ <a href="#">Security Quick Setup (page 8-55)</a></p>
<b>Administrator Authentication for Data Import/Export</b>	<p>Request approval from the administrator when importing/exporting data.</p> <p><b>Value: Off, On</b></p>

\*1 Displayed only on products with the fax function installed.

## Data Security

[Home] key > [...] > [System Menu] > [Security Settings] > "Device Security Settings" [Data Security]

Configure settings for data stored in the SSD, hard disk, and machine's memory.

Item	Description
<b>SSD Initialization</b>	<p>Change security functions.</p> <p> <b>NOTE</b></p> <ul style="list-style-type: none"> <li>• This function is displayed when the Data Security Function is active.</li> <li>• Enter the security password to change security functions. The default setting is "000000".</li> </ul> <p><b>Security Password</b></p> <p>Customize the security password so that only the administrator can use the Data Encryption/Overwrite.</p> <p>Enter a new security password 6 to 16 alphanumeric characters and symbols.</p> <p>Enter the password again for confirmation.</p> <p> <b>IMPORTANT</b></p> <p><b>Avoid any easy-to-guess numbers for the security password (e.g. 11111111 or 12345678).</b></p> <p><b>System Initialization</b></p> <p>Overwrite all the data stored in the SSD when disposing of the machine.</p> <p> <b>IMPORTANT</b></p> <p><b>If you accidentally turn the power switch off during initialization, the hard disk/SSD might possibly crash or initialization might fail.</b></p> <p> <b>NOTE</b></p> <p>If you accidentally turn the power switch off during initialization, turn the power switch on again. Initialization automatically restarts.</p>

Item	Description
<b>Data Sanitization</b>	<p>Return the following information registered in the machine to the factory defaults.</p> <ul style="list-style-type: none"> <li>• Address Book</li> <li>• Favorites</li> <li>• System settings</li> <li>• Fax transmission and reception / forwarding data</li> <li>• Transmission histories</li> <li>• Local FAX Name</li> <li>• Local FAX Number</li> <li>• Data saved in Custom Box</li> <li>• Optional applications</li> </ul> <p> <b>NOTE</b></p> <ul style="list-style-type: none"> <li>• Print the data sanitization report and then confirm that security data is deleted.</li> </ul> <p>➔ <a href="#">Data Sanitization Report (page 8-22)</a></p> <ul style="list-style-type: none"> <li>• Once in progress, the processing cannot canceled.</li> <li>• Before performing this function, disconnect modular, network, and other cables.</li> <li>• Before performing this function, set all interface block settings to [<b>Unblock</b>].</li> </ul> <p>➔ <a href="#">Interface Block Setting (page 8-56)</a></p> <ul style="list-style-type: none"> <li>• Do not turn the power off while sanitizing the data. If the power is turned off during data erasing, erasing will be executed automatically when the power is restored, however, complete erasure cannot be guaranteed.</li> </ul>
<b>Run Immediately</b>	Data Sanitization will be performed.
<b>Reserve a Sanitization Time</b>	<p>Completely erase address and image data saved in the device at the scheduled time.</p> <p><b>Value: Off, On</b></p> <p>If [<b>On</b>] is selected, set the date and time that sanitization is to be performed. The setting range is Year (2000 to 2035), Month (1 to 12), Day (1 to 31), Hour (0 to 23).</p>
<b>Device Use After Sanitization</b>	<p>The device use restriction after the data sanitization is completed.</p> <p>The device cannot be used if [<b>Prohibit</b>] is selected.</p> <p><b>Value: Permit, Prohibit</b></p>
<b>Data Sanitization Report</b>	Print the data sanitization report.

**Information erased**

Category	Data erased
<b>Devices/jobs</b>	<ul style="list-style-type: none"> <li>• Job settings configured by users</li> <li>• Network settings</li> <li>• Image data saved in Document Box, etc.</li> <li>• Data registered in One Touch keys</li> <li>• Job histories</li> <li>• User information (user list, address book, Document Box registered by the user, etc.)</li> <li>• Account information of job accounting</li> <li>• Network certificates</li> <li>• Initial screen on machine changed by service representative</li> </ul>
<b>FAX</b>	<ul style="list-style-type: none"> <li>• Fax settings configured by users</li> <li>• Communication restriction settings</li> <li>• Encryption key settings</li> <li>• Transmission histories</li> <li>• Scheduled jobs</li> <li>• Conditional reception/forwarding settings</li> </ul>
<b>Application/favorite</b>	<ul style="list-style-type: none"> <li>• Application/favorite added by a user or service representative</li> <li>• Trial functions</li> </ul>

**Installation of OCR Dictionary**

[Home] key > [...] > [System Menu] > "Security Settings" > [Device Security Settings] "Installation of OCR Dictionary"

Item	Description
<b>OCR Dictionary Installation</b>	<p>Install the OCR Dictionary.</p> <p> <b>NOTE</b></p> <ul style="list-style-type: none"> <li>• For information on dictionary data, consult your Service Representative.</li> <li>• To install the OCR dictionary, an SSD or SD/SDHC memory card must be inserted.</li> <li>• If both an SSD and an SD/SDHC memory card are inserted, the OCR dictionary will be installed on the SSD.</li> <li>• If you will use an SD/SDHC memory card, a 32 GB SD/SDHC memory card is recommended.</li> </ul>

**Authentication Security**

[Home] key > [...] > [System Menu] > [Security Settings] > "Authentication Security"

If user authentication is enabled, configure the user authentication settings.

➔ [Authentication Security \(page 9-4\)](#)

**Unknown User Settings**

[Home] key > [...] > [System Menu] > [Security Settings] > "Unknown User Settings"

This specifies the behavior for handling the jobs sent with unknown or unsend login user names or User ID.

**NOTE**

This function is displayed in case if User login administration or Job accounting is enabled.

➔ [Unknown ID Job \(page 9-51\)](#)

## Network

[Home] key > [...] > [System Menu] > [Security Settings] > "Network"

Item	Description
<b>TLS</b>	Select whether to use TLS for communication. <b>Value: Off, On</b>
<b>Network Access</b>	Select whether to communicate using SNMP and IPSec. <ul style="list-style-type: none"> <li>➔ <a href="#">SNMPv1/v2c (page 8-48)</a></li> <li>➔ <a href="#">SNMPv3 (page 8-48)</a></li> <li>➔ <a href="#">IPSec (page 8-51)</a></li> </ul>

## Job Accounting/Authentication

[Home] key > [...] > [System Menu] > [Job Accounting/Authentication]

Configure settings related to machine management.

- ➔ [Overview of User Login Administration \(page 9-2\)](#)
- ➔ [Overview of Job Accounting \(page 9-33\)](#)
- ➔ [Unknown User Settings \(page 9-51\)](#)

## Add/Delete Application

[Home] key > [...] > [System Menu] > [Add/Delete Application]

Configure settings for Application.

- ➔ [Application \(page 5-10\)](#)
- ➔ [Optional Applications \(page 11-8\)](#)



## Adjustment/Maintenance

Adjust printing quality and conduct machine maintenance.

### Image Adjustment

[Home] key > [...] > [System Menu] > [Adjustment/Maintenance] > "Image Adjustment"

Item	Description
<b>Density Adjustment</b>	Adjust density.
<b>Copy</b>	Adjust copy density. Adjustment can be made in 7 levels. <b>Value: -3 (Lighter), -2, -1, 0 (Normal), +1, +2, +3 (Darker)</b>
<b>Send/Box</b>	Adjust scan density when sending or storing the data in Document Box. Adjustment can be made in 7 levels. <b>Value: -3 (Lighter), -2, -1, 0 (Normal), +1, +2, +3 (Darker)</b>
<b>Fax*1</b>	➔ <b>FAX Operation Guide</b>
<b>Clarify Text (Noise Removal) Settings</b>	Adjust the legibility of characters.
<b>Text Reproducing Level</b>	<b>Value:</b> 1 (low) , 2 (normal) , 3, (high)
<b>Noise Removal Level</b>	<b>Value:</b> <b>Off</b> <b>On :</b> 1 (low) , 2 (normal) , 3 (high)
<b>Background Density Adj.</b>	Darkens or lightens overall background density adjustment.
<b>Copy (Auto)</b>	Darkens or lightens overall background density adjustment during copying. Adjustment can be made in 7 levels. <b>Value: -3 (Lighter), -2, -1, 0 (Normal), +1, +2, +3 (Darker)</b>
<b>Send/Box (Auto)</b>	Darkens or lightens overall background density when sending images or storing them in the Document Box. Adjustment can be made in 7 levels. <b>Value: -3 (Lighter), -2, -1, 0 (Normal), +1, +2, +3 (Darker)</b>
<b>Sharpness Adjustment</b>	Adjust the sharpness of the image outline.
<b>Copy</b>	Sharpen or blur overall image outlines during copying. Adjustment can be made in 7 levels. <b>Value: -3 (Blur), -2, -1, 0, +1, +2, +3 (Sharpen)</b>
<b>Send/Box</b>	Sharpen or blur overall image outlines when sending or storing them in the Document Box. Adjustment can be made in 7 levels. <b>Value: -3 (Blur), -2, -1, 0, +1, +2, +3 (Sharpen)</b>
<b>Contrast</b>	You can increase or decrease the overall contrast.
<b>Copy</b>	Increases or decreases the overall contrast of copies. <b>Value: -3 (Lower), -2, -1, 0 (Normal), +1, +2, +3 (Higher)</b>
<b>Send/Box</b>	Increases or decreases the overall contrast when documents are sent or saved in a document box. <b>Value: -3 (Lower), -2, -1, 0 (Normal), +1, +2, +3 (Higher)</b>

Item	Description
<b>Toner Save Level (EcoPrint)</b>	
<b>Copy</b>	Select the default Toner Save Level (EcoPrint) . <b>Value: 1 to 5</b> Raising the level reduces toner consumption, but image quality falls.
<b>Printer</b>	Select the default Toner Save Level (EcoPrint) . <b>Value: 1 to 5</b> Raising the level reduces toner consumption, but image quality falls.
<b>Print Density</b>	Adjust print density. Adjustment can be made in 5 levels. <b>Value: 1 to 5</b>
<b>Auto Color Correction</b>	This setting allows you to adjust the detection level used by the machine to determine whether the original is color or black and white in Auto Color Selection Mode. Setting a lower value will result in more originals being identified as color, while a larger value will tend to increase the number of originals being identified as black and white. <b>Value: 1 (Color), 2, 3, 4, 5 (B &amp; W)</b>
<b>Correcting Black Lines</b>	Correct fine lines (streaks caused by contamination), which may appear on the image, when the document processor is used. <b>Value: Off, On</b>
<b>Auto Drum Refresh</b>	This specifies the Auto Drum Refresh execution time. <b>Value:</b> <b>Off:</b> Auto Drum Refresh not performed. <b>Short:</b> Short Auto Drum Refresh execution time. <b>Standard:</b> Standard Auto Drum Refresh execution time. <b>Long:</b> Long Auto Drum Refresh execution time.
<b>Drum Refresh</b>	Remove image blur from the printout. It takes about 1 minute. The time required may vary depending on the operating environment. <a href="#">➔ Drum Refresh (page 10-40)</a>  <b>NOTE</b> Drum Refresh cannot be performed while printing. Execute Drum Refresh after the printing is done.
<b>Drum Refresh 2</b>	Remove white dots from the printout. It takes about 80 seconds. To use [ <b>Drum Refresh 2</b> ], load Ledger or A3 size paper into the Multipurpose tray. When you run [ <b>Drum Refresh 2</b> ], the machine sometimes makes a vibrating sound for about 80 seconds until drum refreshing is completed. The toner soiling on the ejected paper is normal and does not indicate a fault. <a href="#">➔ Drum Refresh 2 (page 10-41)</a>  <b>NOTE</b> Drum Refresh 2 cannot be performed while printing. Execute Drum Refresh after the printing is done.

\*1 Displayed only when the optional FAX Kit is installed.

## Others

[Home] key > [...] > [System Menu] > [Adjustment/Maintenance] > "Others"

Item		Description
<b>Amount of Optional Memory Used</b>		<p>When the optional memory is installed, select the memory distribution pattern according to the application.</p> <p><b>Value:</b> Printer Priority, Standard, Copy Priority</p> <p> <b>IMPORTANT</b></p> <p>After changing the setting, restart the system or turn the machine OFF and then ON.</p>
<b>Altitude Adjustment</b>		<p>Adjust the height.</p> <p><b>Value:</b> Normal, 1001-2000mm, 2001-3000mm, 3001-3500mm</p>
<b>MC</b>		<p>Set MC.</p> <p><b>Value:</b> 1 to 7</p>
<b>Diagnostics</b>	<b>Memory Diagnostics</b>	Perform this function to check the machine memory.
	<b>Software Verification</b>	➔ <a href="#">Software Verification (page 8-57)</a>
<b>Test Page</b>		Output the test page for identifying the cause of the image defects.
<b>Restart/ Initialization</b>	<b>Restart Network</b>	➔ <a href="#">Restart Network (page 8-51)</a>
	<b>Restart Network (Optional Network)</b>	➔ <a href="#">Restart Network (page 8-53)</a>
	<b>Restart Entire Device</b>	➔ <a href="#">Restart Entire Device (page 8-55)</a>
	<b>Format SSD</b>	Format the SSD.
	<b>Format SD Card</b>	<p>Format the SD card. To use an SD card, it is necessary to format the SD card on this machine first.</p> <p>When the formatting is complete, data can be written to the SD card.</p>
<b>Service Settings</b>		Perform the maintenance and inspection of the machine. This menu is primarily used by service personnel for maintenance work.

# 9 User Authentication and Accounting (User Login, Job Accounting)

This chapter explains the following topics:

Overview of User Login Administration .....	9-2	Counting the Number of Pages Printed ...	9-45
Enabling User Login Administration .....	9-3	Counting the Number of Pages for All	Accounts .....
Setting User Login Administration .....	9-4	Counting the Number of Pages for Each	Account .....
Authentication Security .....	9-4	Print Accounting Report .....	9-47
Adding a User (Local User List) .....	9-6	Using Job Accounting .....	9-48
Changing User Properties .....	9-9	Login/Logout .....	9-48
Delete a user .....	9-10	Apply Limit .....	9-49
User Login Administration for Printing ...	9-11	Copier/Printer Count .....	9-50
To Manage the Users to Scan Using		Unknown User Settings .....	9-51
TWAIN .....	9-13	Unknown ID Job .....	9-51
To Manage the Users to Scan Using		Unknown ID Job .....	9-51
WIA .....	9-14	Registering Information for a User	
To Manage the Users that Send Faxes from a		whose ID is Unknown .....	9-52
PC .....	9-15		
Local Authorization .....	9-16		
Server Settings .....	9-17		
Configuring Network User Privileges .....	9-18		
Group Authorization Settings .....	9-19		
Guest Authorization Set. ....	9-21		
Obtain NW User Property .....	9-24		
Simple Login Settings .....	9-26		
ID Card Settings .....	9-29		
PIN Code Authorization .....	9-31		
Using User Login Administration .....	9-32		
Login/Logout .....	9-32		
Overview of Job Accounting .....	9-33		
Enabling Job Accounting .....	9-35		
Adding an Account .....	9-36		
Job Accounting (Local) .....	9-36		
Adding an Account .....	9-36		
Restricting the Use of the Machine .....	9-37		
Editing an Account .....	9-38		
Deleting an Account .....	9-39		
Job Accounting for Printing .....	9-40		
Job Accounting for Scan Using TWAIN .....	9-41		
Job Accounting for Scan Using WIA .....	9-42		
Job Accounting for the FAX			
Transmitted from a Computer .....	9-43		
Configuring Job Accounting .....	9-44		
Default Counter Limit .....	9-44		



# Overview of User Login Administration

User login administration specifies how the user access is administered on this machine. Enter a correct login user name and password for user authentication to login.

- 1 Enable User Login Administration
  - ➔ [Enabling User Login Administration \(page 9-3\)](#)
- 2 Set the user
  - ➔ [Adding a User \(Local User List\) \(page 9-6\)](#)
- 3 Enter the login user name and password and execute the job
  - ➔ [Using User Login Administration \(page 9-32\)](#)

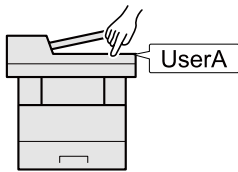

Access are in three levels - "User", "Administrator", and "Machine Administrator". The security levels can be modified only by the "Machine Administrator".

## To manage the job account from PC

In addition to the above settings, the following are necessary to manage the job account from PC.

### To Manage the Users to Print from PCs

Printer driver settings are necessary to manage the users that print on the machine from PCs.

- ➔ [User Login Administration for Printing \(page 9-11\)](#)

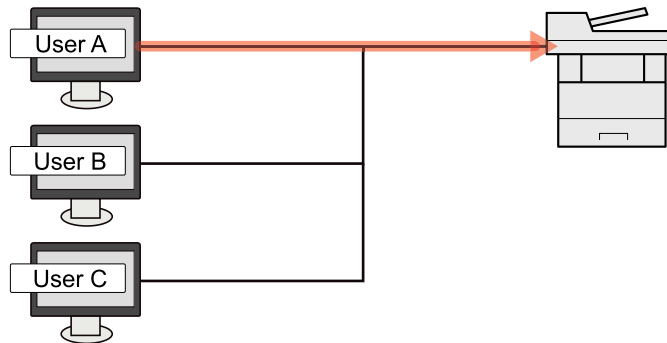

### To Manage the Users to Use TWAIN for Scanning

TWAIN driver settings on the PC are necessary to manage the users that use TWAIN for scanning.

- ➔ [To Manage the Users to Scan Using TWAIN \(page 9-13\)](#)

### To Manage the Users to Use WIA for Scanning

WIA driver settings on the PC are necessary to manage the users that use WIA for scanning.

- ➔ [To Manage the Users to Scan Using WIA \(page 9-14\)](#)

### To Manage the Users to Send Faxes from a PC\*1

FAX driver settings on the PC are necessary to manage the users that send faxes from a PC.

- ➔ [To Manage the Users that Send Faxes from a PC \(page 9-15\)](#)

\*1 Only on products with the fax function installed.

# Enabling User Login Administration

This enables user login administration. Select one of the following authentication methods:

Item	Descriptions
<b>Local Authentication</b>	User authentication based on user properties on the local user list stored in the machine.
<b>Network Authentication</b>	User authentication based on Authentication Server. Use a user property stored in Authentication Server to access the network authentication login page.

## 1 Display the screen.

- 1 [Home] key > [...] > [System Menu] > [Job Accounting/Authentication]

### NOTE

If the User Authentication screen appears, log in with a user who has the privilege to configure this setting. If you do not know your login User Name or Password, please contact your Administrator.

- 2 Select " User Login Setting" [**User Login**].

## 2 Configure the settings.

- 1 Select [**Local Authentication**] or [**Network Authentication**].

Select [**Off**] to disable user login administration.

If you select [**Local Authentication**], set [**Local Authorization**].

➔ [Local Authorization \(page 9-16\)](#)

If you select [**Network Authentication**], set [**Server Settings**].

➔ [Server Settings \(page 9-17\)](#)

### NOTE

If you cannot login because of the setting of the machine, login with any administrator registered in the local user list and correct the settings.

➔ [Server Settings \(page 9-17\)](#)

# Setting User Login Administration

This registers, alters and deletes users and configures the settings for User Login Administration.

## Authentication Security

If user authentication is enabled, configure the user authentication settings.

### User Account Lockout Setting

You can prohibit the use of a user account if an incorrect password is entered repeatedly to login with that account.

#### 1 Display the screen.

[Home] key > [...] > [System Menu] > [Job Accounting/Authentication] > "Authentication Security" [User Account Lockout Settings]



#### NOTE

If the User Authentication screen appears, log in with a user who has the privilege to configure this setting. If you do not know your login User Name or Password, please contact your Administrator.

#### 2 Configure the settings.

The following settings can be selected.

Item	Descriptions
<b>Lockout</b>	Select whether or not account lockout policy is enabled. <b>Value:</b> Off, On
<b>Lockout Policy</b>	Specify the conditions and the extent to which the account lockout is applied. <b>Value</b> <b>Number of Retries until Locked:</b> Specify how many login retries are allowed until the account is locked out. (1 to 10 times) <b>Lockout Duration:</b> Specify how long the account is to be locked out until it is unlocked. (1 to 60 minutes) <b>Lockout Target</b> Specify the extent to which the account lockout is applied. You can select from [All] or [Remote Login Only]. Remote Login Only locks out all operations from outside the operation panel.
<b>Locked out Users List</b>	Displays a list of locked out users. You can unlock a user by selecting the user in the list, and selecting [Unlock]. <b>NOTE</b> This function is displayed when account lockout policy is enabled.

## Password Policy Settings

You can prohibit the setting and use of passwords that do not comply with the password policy.

Setting the Password Policy makes it more difficult to break the password.

### 1 Display the screen.

[Home] key > [...] > [System Menu] > [Job Accounting/Authentication] > " AuthenticationSecurity"  
[Password Policy Settings]



#### NOTE

If the User Authentication screen appears, log in with a user who has the privilege to configure this setting. If you do not know your login User Name or Password, please contact your Administrator.

### 2 Configure the settings.

The following settings can be selected.

Item	Descriptions
<b>Password Policy</b>	Select whether or not password policy is enabled. <b>Value: Off, On</b>
<b>Minimum Password Length</b>	Set the minimum password length of characters for password. <b>Value: Off, On (1 to 64 characters)</b>
<b>Password Complexity</b>	Set the password complexity. <b>Value</b> <b>No more than three consecutive identical char: Off, On</b> <b>At least one uppercase letter (A-Z): Off, On</b> <b>At least one lowercase letter (a-z): Off, On</b> <b>At least one number (0-9): Off, On</b> <b>At least one symbol: Off, On</b>
<b>Maximum Password Age</b>	Set the maximum password age. <b>Value: Off, On (1 to 180 days)</b>
<b>Policy Violated User List</b>	List of users do not meet password policy requirements.

## Adding a User (Local User List)

This adds a new user. You can add up to 100 users (including the default login user name).

### 1 Display the screen.

- 1 [Home] key > [...] > [System Menu] > [Job Accounting/Authentication]

#### NOTE

If the User Authentication screen appears, log in with a user who has the privilege to configure this setting. If you do not know your login User Name or Password, please contact your Administrator.

- 2 Select " User Login Setting" [Add/Edit Local User].

### 2 Enter the user information.

[Add] > Enter the user information

Item	Descriptions
User Name <sup>*1</sup>	Enter the name displayed on the user list (up to 32 characters).
Login User Name <sup>*1</sup>	Enter the login user name to login (up to 64 characters). The same login user name cannot be registered.
Login Password	Enter the password to login (up to 64 characters). Reenter the same password for confirmation and select the [OK] key.
Access Level Settings <sup>*1</sup>	Select "Administrator" or "User" for user access privileges.
Access Level	Select [Administrator] or [User] for user access privileges.
System Admin Permission	If the user privileges set in the [Access Level] are [User], select the privileges that can be set from the following. <ul style="list-style-type: none"> <li>• Original/Paper Settings</li> <li>• Address Book</li> <li>• User/Job Account Information</li> <li>• Basic Network Settings</li> <li>• Basic Device Settings</li> <li>• Advanced Device/Network Settings</li> </ul>
Account Name	Add an account where the user belongs. The user, who registered his/her account name, can login without entering the account ID. <a href="#">➔ Overview of Job Accounting (page 9-33)</a>  <b>NOTE</b> Select [Menu] > [Search (Name)] or [Search (ID)] to search by account name or account ID. Select [Menu] > [Sort (Name)] or [Sort (ID)] to sort the account list.
E-mail Address	The user can register his/her E-mail address. The registered address will be automatically selected for subsequent operations that need any E-mail function.

Item	Descriptions
<b>ID Card Information</b>	<p>Register ID card information. Place the ID card on the Card reader, and select <b>[Read]</b>.</p> <p> <b>NOTE</b> This function is displayed when the optional ID Card Authentication Kit is activated. ➔ <a href="#">Card reader (page 11-7)</a></p>
<b>Local Authorization</b> <sup>*2</sup>	Set usage authority for each user.
<b>Print Restriction</b>	<p>Select whether or not use of the print function of the printer is prohibited. Applicable print functions are as follows:</p> <ul style="list-style-type: none"> <li>• Print from Box</li> <li>• Print from USB Drive</li> <li>• Print Report</li> <li>• Print from PC</li> </ul>
<b>Copy Restriction</b>	Select whether or not use of the copy print function is prohibited.
<b>Duplex Restriction</b>	Select whether only duplex printing is allowed.
<b>Combine Restriction</b>	Specify whether only Combine is allowed.
<b>EcoPrint Restriction</b>	Specify whether only EcoPrint is allowed.
<b>Send Restriction</b>	Select whether or not use of the send function is prohibited.
<b>Fax TX Restriction</b> <sup>*3</sup>	Select whether or not use of the fax send function is prohibited.
<b>Storing Restriction in Box</b>	Select whether or not use of the box store function is prohibited.
<b>Storing Restr. in USB</b>	Select whether or not use of the USB Drive store function is prohibited.
<b>My Panel</b>	You can register the language selection, initial screen, and shortcut settings for each user. Settings registered here can be applied simply by logging in.

\*1 Mandatory at user registration.

\*2 Displayed when Local Authorization is enabled.

➔ [Local Authorization \(page 9-16\)](#)

\*3 Displayed only on products with the fax function installed.

 **NOTE**

• For details on entering characters, refer to the the following:

➔ [Character Entry Method \(page 11-10\)](#)

• If you selected **[Send]** or **[Fax]** in the Default Screen for "My Panel", select the screen to display from **[Destination]**, **[Machine Address Book]**, or **[Ext Address Book]**.

### 3 Select [Save].

A new user is added on the local user list.



#### NOTE

If simple login is enabled, a confirmation screen appears when new registration is finished asking if you will configure simple login settings. To configure simple login settings, select **[Yes]**. If you select **[No]**, you will return to the user list screen.

For the procedure for configuring simple login settings, refer to the following:

➔ [Simple Login Settings \(page 9-26\)](#)

## Changing User Properties

User properties can be changed. Types of user properties that could be changed may be different depending on user access privilege.

### 1 Display the screen.

- 1 [Home] key > [...] > [System Menu] > [Job Accounting/Authentication]



#### NOTE

If the User Authentication screen appears, log in with a user who has the privilege to configure this setting. If you do not know your login User Name or Password, please contact your Administrator.

- 2 [User Login Setting] > [Local User List]

### 2 Change the user properties.

- 1 Select [⋮] for the user to edit.



#### NOTE

- Select [User Name] or [Login User ID] to sort the user list.
- Search by name or login user name. Select either [Search (Login)] or [Search (Name)] to switch between [Search (Login)] and [Search (Name)].

- 2 Enter the user information.

Item
User Name
Login User Name <sup>*1</sup>
Domain Name <sup>*2</sup>
Login Password
Access Level Settings <sup>*1</sup>
Account Name <sup>*1</sup>
Email Address
ID Card Information <sup>*1</sup>
Local Authorization <sup>*1*3</sup>
My Panel

\*1 You can change only when you log in with machine administrator authority.

\*2 The domain name will be displayed for network users granted with local user privileges

➔ [Configuring Network User Privileges \(page 9-18\)](#)

\*3 Displayed when Local Authorization is enabled.

➔ [Local Authorization \(page 9-16\)](#)

For details on each items, refer to step 3 of "Adding a User (Local User List)" to change a user property.

➔ [Adding a User \(Local User List\) \(page 9-6\)](#)

- 3 Select [Save].

The user information is changed.



## Delete a user

### 1 Display the screen.

- 1 [Home] key > [...] > [System Menu] > [Job Accounting/Authentication]



#### NOTE

If the User Authentication screen appears, log in with a user who has the privilege to configure this setting. If you do not know your login User Name or Password, please contact your Administrator.

- 2 Select " User Login Setting" [Add/Edit Local User].

### 2 Delete a user

- 1 Select the user to delete.

- 2 [Delete] > [Delete]

The selected user will be deleted.



#### NOTE

The default user with machine administrator rights cannot be deleted.

➔ [Administrator Privileges Overview \(page 2-68\)](#)

# User Login Administration for Printing

It is possible to manage the users that print on this machine from a PC.

## Setting Printer Driver

To manage the users that print on this machine from a PC, the following settings are necessary in the printer driver. Instructions are based on interface elements as they appear in Windows 10.

### 1 Display the screen.

- 1 Click **[Start]** button on the Windows, and then select **[Windows System]**, **[Control Panel]**, and **[View devices and printers]**.



#### NOTE

In Windows 8.1, select **[Settings]** in charms on Desktop, and select **[Control Panel]**, and then **[Devices and Printers]**.

- 2 Right-click the printer driver icon of the machine, and click the **[Printer properties]** menu of the printer driver.
- 3 Click **[Administrator]** on the **[Device Settings]** tab.

### 2 Configure the settings.

- 1 Select **[User Login]** on the **[User Login]** tab.

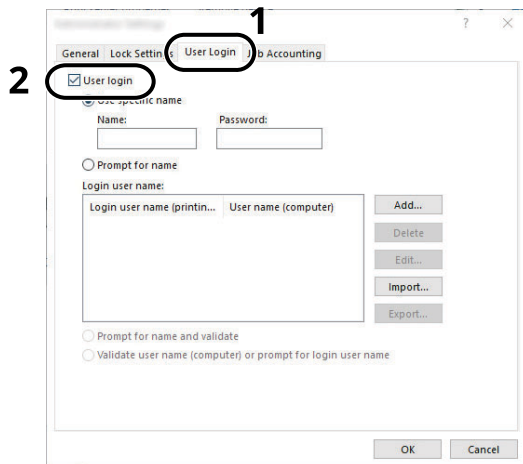

- 2 Set the User Login Administration.

**[Use specific name]:** This option can be used to specify a user name and password to use the same User login for every print job. If this option is selected, the user does not have to type the name and password for each print job.

**[Prompt for name]:** A screen for entering the user name and password will be displayed when attempting a printing. The user name and password must be entered each time a printing is attempted.

**[Prompt for name and validate]:** A screen for entering the user name and password will be displayed when attempting a printing. The user name and password stored in the Login user name list needs to be entered. The user name and password must be entered each time a printing is attempted.

**[Validate user name (computer) or prompt for login user name]:** When printing, the Windows user name is searched in the "Login user names" and printing is possible if the name is registered. If the name is not registered, the printing will be canceled for users with only user authority. If the user has administrator privileges, the screen to enter the user name and password will appear.

- 3 Click **[OK]**.



**NOTE**

For other settings of job accounting, refer to the following:

➔ **Printer Driver User Guide**

## To Manage the Users to Scan Using TWAIN

It is possible to manage the users that scan using TWAIN.

### Setting TWAIN Driver

To manage the users that scan using TWAIN, the following settings are necessary in the TWAIN driver. Instructions are based on interface elements as they appear in Windows 10.

#### 1 Display the screen.

- 1 Click the search box in the taskbar, and type "TWAIN Driver Setting" in there. Select **[TWAIN Driver Setting]** in the search list. TWAIN Driver screen is displayed.



#### NOTE

In Windows 8.1, select **[Search]** in charms, and enter "TWAIN Driver Setting" in the search box. Click **[TWAIN Driver Setting]** in the search list then the TWAIN Driver Setting screen appears.

- 2 Select the machine, and click **[Edit]**.

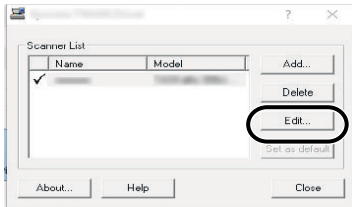

#### 2 Configure the settings.

- 1 Click **[User Authentication Settings]**.
- 2 Select the checkbox beside **[Authentication]**, and enter Login User Name and Password.

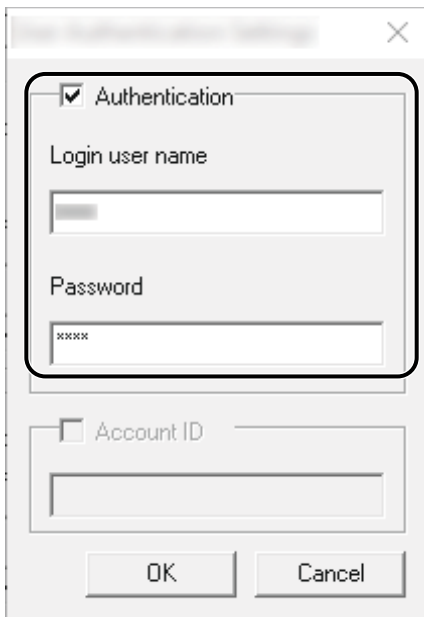

- 3 Click **[OK]**.

## To Manage the Users to Scan Using WIA

It is possible to manage the users that scan using WIA.

### Setting WIA Driver

To manage the users that scan using WIA, the following settings are necessary in the WIA driver. Instructions are based on interface elements as they appear in Windows 10.

#### 1 Display the screen.

- 1 Click **[Start]** button on the Windows, and then select **[Windows System]**, **[Control Panel]**. Click the search box in the Control Panel, and type "Scanner" in there. Select **[View scanners and cameras]** in the search list. The Scanners and Cameras screen is displayed.



#### NOTE

In Windows 8.1, click **[Search]** in charms, and enter "Scanner" in the search box. Click **[View scanners and cameras]** in the search list then the Scanners and Cameras screen appears.

- 2 Select the same name as this machine from WIA Drivers, and press **[Properties]**.

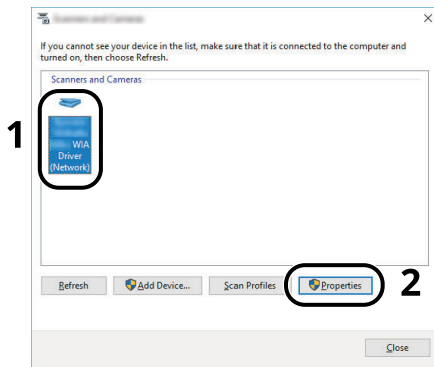

#### 2 Configure the settings.

- 1 Select the checkbox beside **[Authentication]** on the **[Settings]** tab, and enter Login User Name and Password.

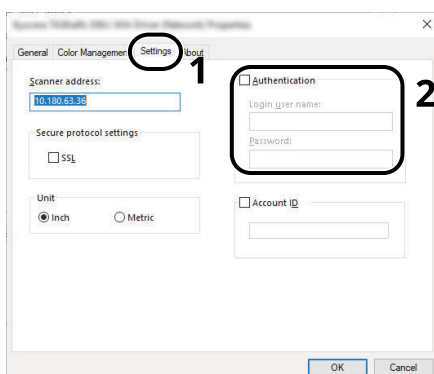

- 2 Click **[OK]**.

## To Manage the Users that Send Faxes from a PC

It is possible to manage the users that send faxes from a PC.

### Setting FAX Driver

To manage the users that send faxes from a PC, the following settings are necessary in the FAX driver. Instructions are based on interface elements as they appear in Windows 10.

#### 1 Display the screen.

- 1 Click **[Start]** button on the Windows, and then select **[Windows System]**, **[Control Panel]**, and **[View devices and printers]**.



#### NOTE

In Windows 8.1, select **[Settings]** in charms on Desktop, and select **[Control Panel]**, and then **[Devices and Printers]**.

- 2 Right-click the printer driver icon of the machine, and click the **[Printer properties]** menu of the printer driver.
- 3 Click **[FAX TX Setting]** on the **[Printing Preferences]** window.

#### 2 Configure the settings.

- 1 Select **[User Login]** on the **[Authentication]** tab.

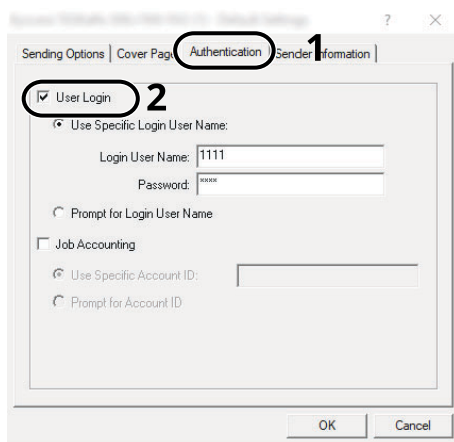

- 2 Set the User Login Administration.

**[Use Specific Login User Name]:** This option can be used to specify a user name and password to use the same User login for every FAX job. If this option is selected, the user does not have to type the name and password for each FAX job.

**[Prompt for Login User Name]:** A screen for entering the user name and password will be displayed when attempting a transmission. The user name and password must be entered each time a transmission is attempted.

- 3 Click **[OK]**.

## Local Authorization

Select whether or not to use Local Authorization.

### NOTE

When using Local Authorization, the user authentication type must be set to **[Local Authentication]**.

➔ [Enabling User Login Administration \(page 9-3\)](#)

## 1 Display the screen.

- 1 **[Home]** key > [...] > **[System Menu]** > **[Job Accounting/Authentication]**

### NOTE

If the User Authentication screen appears, log in with a user who has the privilege to configure this setting. If you do not know your login User Name or Password, please contact your Administrator.

- 2 Select " User Login Setting" **[Local Authorization]**.

## 2 Configure the settings

Select **[Off]** or **[On]**.

## Server Settings

Set the server type when network authentication is enabled.

### 1 Display the screen.

- 1 [Home] key > [...] > [System Menu] > [Job Accounting/Authentication]



#### NOTE

If the User Authentication screen appears, log in with a user who has the privilege to configure this setting. If you do not know your login User Name or Password, please contact your Administrator.

- 2 Select "User Login Setting" [User Login] > [Network Authentication]

### 2 Configure the settings.

- 1 Select [NTLM], [Kerberos] or [Ext.] as the server type and enter the host name (256 characters or less) for the Authentication Server.  
When selecting [Ext.] as the server type, enter the port number.



#### NOTE

- Selecting [Add/Edit/Delete Domain] displays the domain registration list. In the domain registration list screen, select [Add/Edit], and enter the domain name. Up to 10 domain names can be registered.
- If two or more domains are registered, select [Default Domain] and select the default domain.

- 2 Select [OK].



#### NOTE

If the login user name and password are rejected, check the following settings.

- Network Authentication setting of the machine
- User property of the Authentication Server
- Date and time setting of the machine and the Authentication Server



## Configuring Network User Privileges

Sets whether to grant local user privileges to network users.

By configuring this, the information of a network user who logs in will be registered as that of a local user.

By setting a department name to the registered local user information, network users can collaborate with the department management.

The domain name will be displayed in the user information of local users granted with privileges.

### NOTE

Please refer to the following regarding local user information.

➔ [Adding a User \(Local User List\) \(page 9-6\)](#)

## 1 Display the screen.

- 1 [Home] key > [...] > [System Menu] > [Job Accounting/Authentication]

### NOTE

If the User Authentication screen appears, log in with a user who has the privilege to configure this setting. If you do not know your login User Name or Password, please contact your Administrator.

- 2 Select "User Login Setting" [Network User Authority].

## 2 Configure the settings.

You can configure various settings by setting "Give Local User Authority" to "On."

Item	Descriptions
<b>User Full Action</b>	This is set when granting local user privileges to configure the actions that will be taken when the number of users exceeds the limit. <b>Value: Off, On</b>
<b>Authority When Offline</b>	Sets the expiration date of the granted local user privileges when network authentication is not used. <b>Value: Always Enabled, Specify Enabled Period (1~180)</b>
<b>Local Authorization Defaults</b>	Sets the allowed initial values of the local user privileges to be granted.

## Group Authorization Settings

Set restrictions of the machine usage by each individual group registered in the authentication server.

### NOTE

To use the group authorization settings, **[Network Authentication]** must be selected for the authentication method in "Enabling User Login Administration". Select "On" for "LDAP" in "Protocol Settings".

- ➔ [Enabling User Login Administration \(page 9-3\)](#)  
[Protocol Settings \(page 8-46\)](#)

## Group Authorization

### 1 Display the screen.

- 1 [Home] key > [...] > [System Menu] > [Job Accounting/Authentication]

### NOTE

If the User Authentication screen appears, log in with a user who has the privilege to configure this setting. If you do not know your login User Name or Password, please contact your Administrator.

- 2 Select [User Login Setting] [Group Authorization].

### 2 Configure the settings.

Select [Off] or [On].

## Group List (Up to 20)

Register the groups that are restricted the machine usage. Other users and groups belong to "Others".

### 1 Display the screen.

- 1 [Home] key > [...] > [System Menu] > [Job Accounting/Authentication]



#### NOTE

If the User Authentication screen appears, log in with a user who has the privilege to configure this setting. If you do not know your login User Name or Password, please contact your Administrator.

- 2 Select [User Login Setting] [Group List].

### 2 Configure the settings.

[Add] > Add information on each item.

Item	Descriptions
<b>Group Name</b>	Enter the name displayed on the group list (up to 32 characters).
<b>Group ID*1</b>	Enter the ID displayed on the group list (between 1 and 4294967295).
<b>Access Level</b>	Select [Administrator] or [User] for group access privileges.
<b>Printer</b>	Select whether or not to reject usage of print functions for the printer. Applicable print functions are as follows: <ul style="list-style-type: none"> <li>• Print from Box</li> <li>• Print from USB Drive</li> <li>• Print Report</li> <li>• Print from PC</li> </ul>
<b>Copy</b>	Select whether or not to reject usage of copy functions.
<b>Duplex Restriction</b>	Select whether only duplex printing is allowed.
<b>Combine Restrict.</b>	Specify whether only Combine is allowed.
<b>EcoPrint Restriction</b>	Specify whether only EcoPrint is allowed.
<b>Send</b>	Select whether or not to reject usage of the send functions.
<b>FAX Transmission *2</b>	Select whether or not to reject usage of the FAX transmissions.
<b>Storing in Box</b>	Select whether or not to reject usage of storing in the document boxes.
<b>Storing in USB Drive</b>	Select whether or not to reject usage of storing in the USB Drive.

\*1 For " Group ID" , specify PrimaryGroupID assigned by Active Directory of Windows.

\*2 Only on products with the fax function installed.



#### NOTE

For details on entering characters, refer to the the following:

➔ [Character Entry Method \(page 11-10\)](#)

### 3 Register the group.

Select [Save].

A new group is added on the group list.

## Guest Authorization Set.

When User Login Administration is enabled, set the functions that guest users who cannot log in to the machine are allowed to use.

### NOTE

To use Guest Authorization Set., User Login Administration must be enabled in "Enabling User Login Administration".

➔ [Enabling User Login Administration \(page 9-3\)](#)

## Guest Authorization

### 1 Display the screen.

- 1 [Home] key > [...] > [System Menu] > [Job Accounting/Authentication]

### NOTE

If the User Authentication screen appears, log in with a user who has the privilege to configure this setting. If you do not know your login User Name or Password, please contact your Administrator.

- 2 Select "User Login Setting" [**Guest Authorization Set.**].  
Select [**Off**] or [**On**].

### 2 Configure the settings.

Select [**Off**] or [**On**].

### NOTE

If the guest authorization setting is enabled, the [**Logout**] key must be selected when logging in.

In the guest user default settings, only monochrome copying can be used. If you wish to use a different function, log in as a user who can use that function, or change the settings in the guest properties.

## Guest Property

Register guest user information and functions that are restricted.

### 1 Display the screen.

- 1 [Home] key > [...] > [System Menu] > [Job Accounting/Authentication]



#### NOTE

If the User Authentication screen appears, log in with a user who has the privilege to configure this setting. If you do not know your login User Name or Password, please contact your Administrator.

- 2 Select "User Login Setting" [Guest Property].

### 2 Configure the settings.

Check the settings and change or add information as needed.

Item	Descriptions
<b>User Name</b>	Enter the name displayed on the user list (up to 32 characters). The default setting is "GuestUser".
<b>Access Level</b>	The authority of the user appears. This cannot be changed.
<b>Account Name</b>	Add an account where the user belongs. If the user does not belong to any account, select [Other].
<b>Authorization Rules</b>	<p>Set usage authority for each user. The items you can restrict the access level with are as follows.</p> <p><b>Printer:</b> Select whether or not use of the print function of the printer is prohibited. Applicable print functions are as follows:</p> <ul style="list-style-type: none"> <li>•Print from Box</li> <li>•Print from USB Drive</li> <li>•Print Report</li> </ul> <p><b>Copy:</b> Select whether or not use of the copy print function is prohibited.</p> <p><b>Duplex Restriction:</b> Select whether only duplex printing is allowed.</p> <p><b>Combine Restrict.:</b> Specify whether only Combine is allowed.</p> <p><b>EcoPrint Restriction:</b> Specify whether only EcoPrint is allowed.</p> <p><b>Send:</b> Select whether or not use of the send function is prohibited.</p> <p><b>FAX TX Restriction *1:</b> Select whether or not use of the fax send function is prohibited.</p> <p><b>Storing in Box:</b> Select whether or not use of the box store function is prohibited.</p> <p><b>Storing in USB Drive:</b> Select whether or not use of the USB Drive store function is prohibited.</p>

\*1 Only on products with the fax function installed.

### **3 Register the guest user information.**

Select **[OK]**.

## Obtain NW User Property

Set the required information to obtain the network user property from the LDAP server. The user name and E-mail address obtained with this setting is shown in the user information, the status confirmation screen, and the header of E-mail.

### NOTE

To obtain the network user property from the LDAP server, [**Network Authentication**] must be selected for the authentication method in "Enabling User Login Administration". Select "On" for "LDAP" in "Protocol Settings".

➔ [Enabling User Login Administration \(page 9-3\)](#)  
[Protocol Settings \(page 8-46\)](#)

## 1 Display the screen.

1 [Home] key > [...] > [System Menu] > [Job Accounting/Authentication]

### NOTE

If the User Authentication screen appears, log in with a user who has the privilege to configure this setting. If you do not know your login User Name or Password, please contact your Administrator.

2 Select " User Login Setting" [**Obtain NW User Property**].

## 2 Configure the settings.

Select [**On**] for "Obtain NW User Property" and add information on each item

Item	Descriptions
<b>LDAP Server Information</b>	
<b>Server Name</b> <sup>*1</sup>	Enter the LDAP server name or the IP address (up to 64 characters). If a server name is not entered, user information will be acquired from the server set for Network Authentication.
<b>Port</b>	Port number for LDAP server. The default port number is 389.
<b>Acquisition of User Information</b>	
<b>Name 1</b> <sup>*2</sup>	Enter the LDAP Attribute to obtain the user name to be displayed from the LDAP server (up to 32 characters).
<b>Name 2</b> <sup>*3</sup>	Enter the LDAP Attribute to obtain the user name to be displayed from the LDAP server (up to 32 characters).
<b>Email Address</b> <sup>*4</sup>	Enter the LDAP Attribute to obtain the E-mail address from the LDAP server (up to 256 characters).
<b>Authentic at Type</b> <sup>*5</sup>	Set the authentication method. Select [ <b>Simple</b> ] or [ <b>SASL</b> ]. After changing the setting, restart the system or turn the power off and then on.
<b>Search Timeout</b>	Set the amount of time to wait before time-out in seconds (from 5 to 255 seconds).
<b>LDAP Security</b>	Select the type of encryption according to the type of security employed by the LDAP server. The value is [ <b>Off</b> ], [ <b>SSL/TLS</b> ] or [ <b>STARTTLS</b> ].

\*1 If using Active Directory of Windows, the server name may be the same as the server name entered in the network authentication.

\*2 If using Active Directory of Windows, display Name of Attribute may be used as "Name 1".

- \*3 "Name 2" can be left out. When you assign display Name in "Name 1" and department in "Name 2", and if the value of displayName is "Mike Smith" and the value of department is "Sales" in Active Directory of Windows, the user name appears as "Mike Smith Sales".
- \*4 If using Active Directory of Windows, mail of Attribute may be used as E-mail Address.
- \*5 Appears when the server type is set to "Kerberos" in "Network Authentication".

### **3** Select [OK].



## Simple Login Settings

The simple login function allows users to log in simply by selecting a user name. Users must be registered in advance to use this functionality.

### NOTE

- For user registration, refer to the following:
  - ➔ [Adding a User \(Local User List\) \(page 9-6\)](#)
- To use Simple Login, User Login Administration must be enabled in "Enabling User Login Administration".
  - ➔ [Enabling User Login Administration \(page 9-3\)](#)
- When the guest authorization setting is enabled, the Simple Login screen is not displayed.

## Simple Login

### 1 Display the screen.

- 1 [Home] key > [...] > [System Menu] > [Job Accounting/Authentication]

### NOTE

If the User Authentication screen appears, log in with a user who has the privilege to configure this setting. If you do not know your login User Name or Password, please contact your Administrator.

- 2 Select " User Login Setting" [Simple Login].

### 2 Configure the settings

- 1 Select [Off] or [On].

## Simple Login Setup

Register users to use simple login. You can add up to 20 users.

### 1 Display the screen.

- 1 [Home] key > [...] > [System Menu] > [Job Accounting/Authentication]



#### NOTE

If the User Authentication screen appears, log in with a user who has the privilege to configure this setting. If you do not know your login User Name or Password, please contact your Administrator.

- 2 Select " User Login Setting" [Simple Login Key].

### 2 Enter the user information.

- 1 Select the key to which you want to register a user.
- 2 Enter the user name to be displayed.



#### NOTE

For details on entering characters, refer to the following:

➔ [Character Entry Method \(page 11-10\)](#)

- 3 Select [Select user].
- 4 To specify the user from local users, select [Local User]. To specify from network users, select [Network User].

The procedure differs depending on the transmission method selected.

#### Specifying the user from local users

Select the user to be set for simple login.



#### NOTE

- Search by login user name or name. Select either [Search (Login)] or [Search (Name)] to switch between [Search (Login)] and [Search (Name)].
- Select [User Name] or [Login User Name] to sort the user list.

### Specifying the user from network users

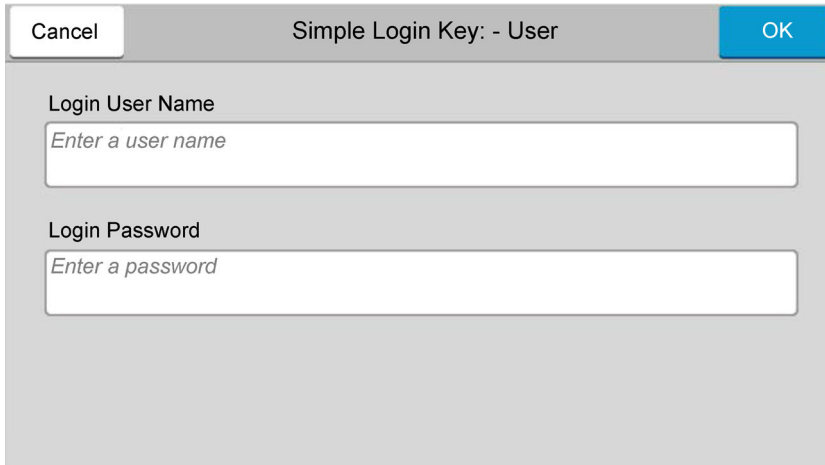

Select the entry field for "Login User Name" and "Login Password", enter the information of the user to be registered, and select **[OK]**.

If you are specifying a user for whom a domain is set in network authentication, select the "Domain" and select the domain where the user is registered.



#### **NOTE**

For details on entering characters, refer to the following:

➔ [Character Entry Method \(page 11-10\)](#)

- 5 Select **[On]** or **[Off]** for "Password".
- 6 Select the user icon to be displayed.

### **3 Register the user.**

Select **[Save]**.

## ID Card Settings

If ID card authentication is enabled, select the authentication type.

### NOTE

This functions appears when the Card Authentication kit is activated.

➔ [Card reader \(page 11-7\)](#)

## Keyboard Login

When ID card authentication is enabled, select whether or not login by keyboard is allowed.

### 1 Display the screen.

- 1 [Home] key > [...] > [System Menu] > [Job Accounting/Authentication]

### NOTE

If the User Authentication screen appears, log in with a user who has the privilege to configure this setting. If you do not know your login User Name or Password, please contact your Administrator.

- 2 Select "ID Card Settings" [**Keyboard Login**].

### 2 Configure the settings.

Select [**Permit**] or [**Prohibit**].

## Additional Authentication

Select whether or not to require password entry after authenticating by ID card.

### NOTE

This function does not appear when the server type is set to [NTLM] or [Kerberos] in "Network Authentication".

### 1 Display the screen.

- 1 [Home] key > [...] > [System Menu] > [Job Accounting/Authentication]

### NOTE

If the User Authentication screen appears, log in with a user who has the privilege to configure this setting. If you do not know your login User Name or Password, please contact your Administrator.

- 2 Select "ID Card Settings" [**Additional Authentication**].

### 2 Configure the settings.

Select [**Off**], [**Use Password**] or [**Use PIN Code**].

### NOTE

[Use PIN Code] is displayed only when using PIN Code Authorization.

➔ [PIN Code Authorization \(page 9-31\)](#)

## Quick Job Printing

When a user logs in using an ID card, it displays a list of user-controlled print jobs that were saved in the job-holding box.

### NOTE

For details about the quick job printing, please refer to the following.

➔ [Printing Document from Stored Job Box \(page 4-22\)](#)

## 1 Display the screen.

- 1 [Home] key > [...] > [System Menu] > [Job Accounting/Authentication]

### NOTE

If the User Authentication screen appears, log in with a user who has the privilege to configure this setting. If you do not know your login User Name or Password, please contact your Administrator.

- 2 Select "User Login Setting" [Quick Job Printing]

## 2 Configure the settings.

Configure various settings by setting "Display List on Login" to "ON."

Item	Descriptions
<b>Logout after Printing</b>	Sets whether to automatically logout after printing.
<b>Skip PIN and Copies Confirmation</b>	Sets whether or not to skip PIN code entry and verify the number of copies when printing. <sup>*1</sup>

\*1 When a PIN codes is configured

## PIN Code Authorization

### NOTE

When using PIN Code Authorization, the network authentication must be enabled and **[Ext.]** must be selected for server type.

➔ [Enabling User Login Administration \(page 9-3\)](#)

### 1 Display the screen.

- 1 **[Home]** key > [...] > **[System Menu]** > **[Job Accounting/Authentication]**

### NOTE

If the User Authentication screen appears, log in with a user who has the privilege to configure this setting. If you do not know your login User Name or Password, please contact your Administrator.

- 2 Select "User Login Setting" **[PIN Login]**.

### 2 Configure the settings.

- 1 Select **[Off]** or **[On]**.

# Using User Login Administration

This section explains procedures while setting job accounting.

## Login/Logout

If user login administration is enabled, the login user name and login password entry screen appears each time you use this machine.

Use the procedure below to login and logout.

### Login

If the login user name entry screen appears during operations, log in by referring to the following:

➔ [Login \(page 2-33\)](#)

### Logout

When the operations are complete, select the **[Logout]** key to return to the login user name and login password entry screen.

# Overview of Job Accounting

Job accounting manages the copy/print/scan/FAX count accumulated by individual accounts by assigning an ID to each account.

- 1 Enable job accounting.
  - ➔ [Enabling Job Accounting \(page 9-35\)](#)
- 2 Setting an account.
  - ➔ [Job Accounting \(Local\) \(page 9-36\)](#)
- 3 Enter the assigned account ID when performing the job.
  - ➔ [Using User Login Administration \(page 9-32\)](#)
- 4 Count the number of pages copied, printed, scanned and faxed.

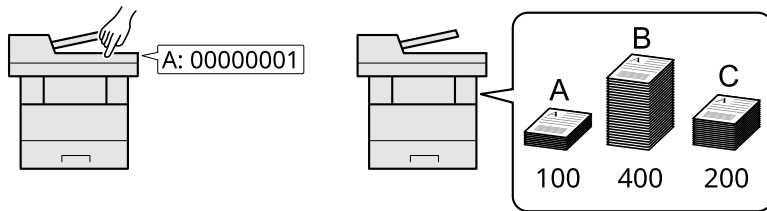

## To manage the job account from PC

In addition to the above settings, the following are necessary to manage the job account from PC.

### To Manage the Number of Sheets Used on Jobs Printed from a PC

To manage the number of jobs to be printed from the PC on the network, you need to configure settings by using the printer driver on the PC.

- 1 Set Job Accounting for the PC on the network by using the printer driver.
  - ➔ [Job Accounting for Printing \(page 9-40\)](#)
- 2 Execute printing.
- 3 Count the number of pages printed.

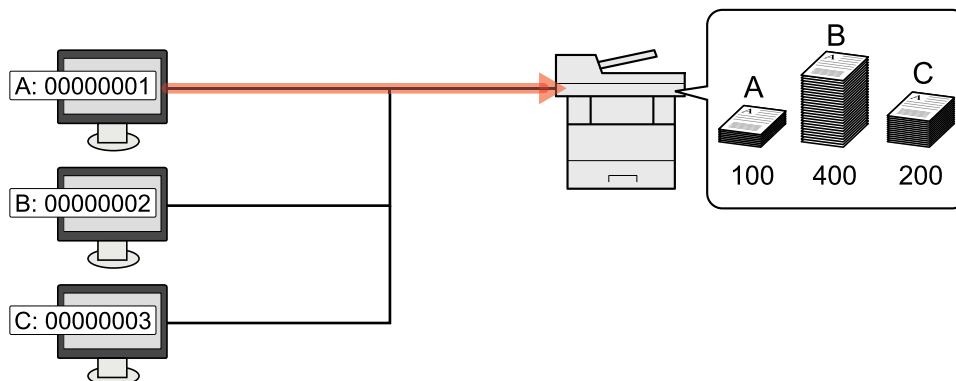

### To Manage the Scan Job Account by Using TWAIN

To manage the scan job account by using TWAIN, you need to configure the TWAIN driver settings on the computer connected to the machine.

- ➔ [Job Accounting for Scan Using TWAIN \(page 9-41\)](#)

### To Manage the Scan Job Account by Using WIA

To manage the scan job account by using WIA, you need to configure the WIA driver settings on the computer connected to the machine.

- ➔ [Job Accounting for Scan Using WIA \(page 9-42\)](#)



**To Manage the FAX Job Transmitted from a PC \*1**

To manage the number of FAX jobs transmitted from the PC, you need to configure the settings by using the FAX Driver on the PC.

➔ [Job Accounting for the FAX Transmitted from a Computer \(page 9-43\)](#)

\*1 Only on products with the fax function installed.

# Enabling Job Accounting

## 1 Display the screen.

- 1 [Home] key > [...] > [System Menu] > [Job Accounting/Authentication]

### NOTE

If the User Authentication screen appears, log in with a user who has the privilege to configure this setting. If you do not know your login User Name or Password, please contact your Administrator.

- 2 Select "Job Accounting Setting" [Job Accounting].

## 2 Configure the settings

Select [Local] or [Network].

Select [Off] to disable job accounting.

### NOTE

When the display returns to System Menu default screen, logout is automatically executed and the screen to enter the Account ID appears. To continue the operation, enter the Account ID.

# Job Accounting (Local)

You can add, change and delete an account and set the restriction for each account.

## Adding an Account

Up to 100 individual accounts can be added. The following entries are required.

### 1 Display the screen.

- 1 [Home] key > [...] > [System Menu] > [Job Accounting/Authentication]



#### NOTE

If the User Authentication screen appears, log in with a user who has the privilege to configure this setting. If you do not know your login User Name or Password, please contact your Administrator.

- 2 Select "Job Accounting Setting" [Add/Edit Job Accounting].

### 2 Enter the account information.

- 1 [Add] > Add information on each item

Item	Descriptions
<b>Account Name</b>	Enter the account name (up to 32 characters).
<b>Account ID</b>	Enter the account ID as many as eight digits (between 0 and 99999999).
<b>Restriction</b>	This prohibits printing/scanning or restricts the number of sheets to load. ➔ <a href="#">Restricting the Use of the Machine (page 9-37)</a>



#### NOTE

For details on entering characters, refer to the the following:

➔ [Character Entry Method \(page 11-10\)](#)

Any "Account ID" that has already registered cannot be used. Enter any other account ID.

- 2 Select [Save].

A new account is added on the Account List.

## Restricting the Use of the Machine

This section explains how to restrict the use of the machine by account or the number of sheets available.

The items that can be restricted differ depending on whether "Individual" or "Total" is selected for "Copy/Print Count".

➔ [Copier/Printer Count \(page 9-50\)](#)

### Restriction Items

"Individual" selected for Copy/Printer Count "Split" selected for Copy/Printer Count

Item	Descriptions
<b>Copy Restriction (Total)</b>	Limits the number of sheets used for copying.
<b>Print Restriction (Total)</b>	Limits the number of sheets used for printing. Applicable print functions are as follows: <ul style="list-style-type: none"> <li>• Print from Box</li> <li>• Print from USB Drive</li> <li>• Print Report</li> <li>• Print from PC</li> </ul>
<b>Scan (Others)</b>	Limits the number of sheets scanned (excludes copying).
<b>FAX Transmission <sup>*1</sup></b>	Limits the number of sheets sent by fax. This is displayed only on products with the fax function installed.

\*1 Only on products with the fax function installed.

"Total" selected for Copy/Printer Count

Item	Descriptions
<b>Print (Total)</b>	Limits the total number of sheets used for copying and printing.
<b>Print (Full Color)</b>	Limits the number of pages used for full-color printing.
<b>Scan (Others)</b>	Limits the number of sheets scanned (excludes copying).
<b>FAX Transmission <sup>*1</sup></b>	Limits the number of sheets sent by fax. This is displayed only on products with the fax function installed.

\*1 Only on products with the fax function installed.

### Applying Restriction

Restriction can be applied in the following modes:

Item	Descriptions
<b>Off</b>	No restriction is applied.
<b>Counter Limit</b>	Restricts the print counter in one-page increments up to 9,999,999 copies.
<b>Reject Usage</b>	Restriction is applied.

## Editing an Account

This changes the registered account information.

### 1 Display the screen.

- 1 [Home] key > [...] > [System Menu] > [Job Accounting/Authentication]



#### NOTE

If the User Authentication screen appears, log in with a user who has the privilege to configure this setting. If you do not know your login User Name or Password, please contact your Administrator.

- 2 Select " Job Accounting Setting" [Add/Edit Job Accounting].

### 2 Edit an account.

- 1 Select [⋮] (information icon) for the account name you wish to edit.



#### NOTE

- Search by account ID or account name. Select either [Search (ID)] or [Search (Name)] to switch between [Search (ID)] and [Search (Name)].
- Select [Account Name] or [ Account ID] to sort the account list.

- 2 Change the account information.

- 3 Select [Save].

The account information is changed.

## Deleting an Account

This deletes the account.

### 1 Display the screen.

- 1 [Home] key > [...] > [System Menu] > [Job Accounting/Authentication]



#### NOTE

If the User Authentication screen appears, log in with a user who has the privilege to configure this setting. If you do not know your login User Name or Password, please contact your Administrator.

- 2 Select " Job Accounting Setting" [Add/Edit Job Accounting].

### 2 Delete an account.

- 1 Select the account name you wish to delete.



#### NOTE

- Search by account ID or account name. Select either [Search (ID)] or [Search (Name)] to switch between [Search (ID)] and [Search (Name)].
- Select [Account Name] or [ Account ID] to sort the account list.

- 2 [Delete] > [Delete]

The account is deleted.

# Job Accounting for Printing

The number of jobs to be printed from the computer can be managed by Job Accounting.

## Setting Printer Driver

To manage the number of jobs to be printed from the PC on the network, you need configure the following settings by using the printer driver on the PC. Instructions are based on interface elements as they appear in Windows 10.

### 1 Display the screen.

- 1 Click **[Start]** button on the Windows, and then select **[Windows System]**, **[Control Panel]**, and **[View devices and printers]**.



#### NOTE

In Windows 8.1, select **[Settings]** in charms on Desktop, and select **[Control Panel]**, and then **[Devices and Printers]**.

- 2 Right-click the printer driver icon of the machine, and click the **[Printer properties]** menu of the printer driver.
- 3 Click **[Administrator]** on the **[Device Settings]** tab.

### 2 Configure the settings.

- 1 Select **[Job accounting]** on the **[Job Accounting]** tab.

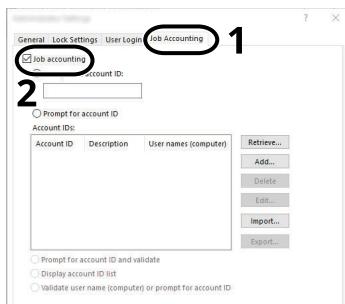

- 2 Set the Account ID.

**[Use specific account ID]:** Enter the Account ID. Printing will be performed using the entered Account ID. If this option is selected, the user does not have to enter the Account ID for each print job.

**[Prompt for account ID]:** A screen for entering the Account ID will be displayed when attempting a printing. The Account ID must be entered each time a printing is attempted.

**[Prompt for account ID and validate]:** A screen for entering the Account ID will be displayed when attempting a printing. The Account ID stored in the Account ID list needs to be entered. The Account ID must be entered each time a printing is attempted.

**[Display account ID list]:** The Account ID list is displayed when printing. The Account ID to be used needs to be selected from the list.

**[Validate user name (computer) or prompt for account ID]:** When printing, the Windows user name is searched in the "Account IDs" and printing is possible if the name is registered. If the Account ID is not registered, the screen for entering the Account ID will appear.

- 3 Click **[OK]**.



**NOTE**

For other settings of job accounting, refer to the following:

- ➔ **Printer Driver User Guide**

## Job Accounting for Scan Using TWAIN

The number of jobs scanned by using TWAIN can be managed by Job Accounting.

### Setting TWAIN Driver

To manage the number of jobs scanned by using TWAIN, you need to configure the following settings by using the TWAIN Driver on the computer. Instructions are based on interface elements as they appear in Windows 10.

#### 1 Display the screen.

- 1 Click the search box in the taskbar, and type "TWAIN Driver Setting" in there. Select **[TWAIN Driver Setting]** in the search list. TWAIN Driver screen is displayed.



**NOTE**

In Windows 8.1, select **[Search]** in charms, and enter "TWAIN Driver Setting" in the search box. Click **[TWAIN Driver Setting]** in the search list then the TWAIN Driver Setting screen appears.

- 2 Select the machine, click **[Edit]**.

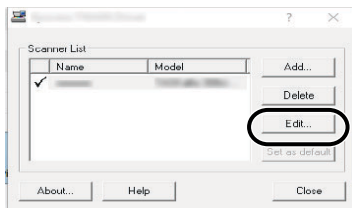

#### 2 Configure the settings.

- 1 Click **[User Authentication Settings]**.
- 2 Select the checkbox beside **[Account]**, and enter the account ID.
- 3 Click **[OK]**.

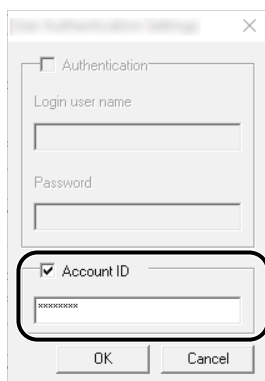



## Job Accounting for Scan Using WIA

The number of jobs scanned by using WIA can be managed by Job Accounting.

### Setting WIA Driver

To manage the number of jobs scanned by using WIA, you need to configure the following settings by using the WIA Driver on the computer. Instructions are based on interface elements as they appear in Windows 10.

#### 1 Display the screen.

- 1 Click [Start] button on the Windows, and then select [**Windows System**], [**Control Panel**]. Click the search box in the Control Panel, and type "Scanner" in there. Select [**View scanners and cameras**] in the search list. The Scanners and Cameras screen is displayed.



#### NOTE

In Windows 8.1, click [**Search**] in charms, and enter "Scanner" in the search box. Click [**View scanners and cameras**] in the search list then the Scanners and Cameras screen appears.

- 2 Select the same name as this machine from WIA Drivers, and press [**Properties**].

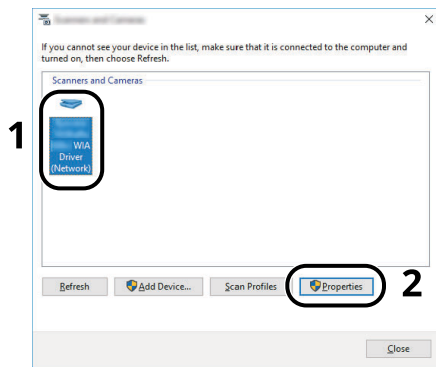

#### 2 Configure WIA Driver.

- 1 Select the checkbox beside [**Account ID**] on the [**Settings**] tab, and enter the Account ID.

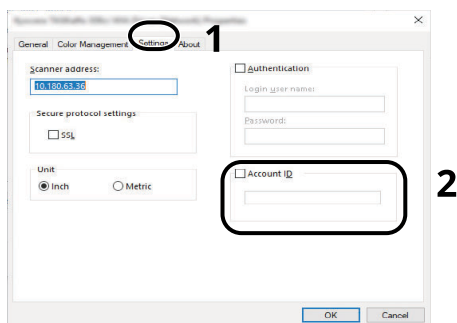

- 2 Click [**OK**].

# Job Accounting for the FAX Transmitted from a Computer

The number of FAX jobs transmitted from the computer can be managed by Job Accounting.



## NOTE

FAX functions are available only on products with the fax function installed.

## Setting FAX Driver

To manage the number of FAX jobs transmitted from the computer, you need to configure the following settings by using the FAX Driver on the computer. Instructions are based on interface elements as they appear in Windows 10.

### 1 Display the screen.

- 1 Click **[Start]** button on the Windows, and then select **[Windows System]**, **[Control Panel]**, and **[View devices and printers]**.



## NOTE

In Windows 8.1, select **[Settings]** in charms on Desktop, and select **[Control Panel]**, and then **[Devices and Printers]**.

- 2 Right click the name of the machine to be used as the FAX Driver and select **[Printing preferences]** from the resulting pull-down menu.
- 3 Click **[FAX TX Setting]** in the **[Printing Preferences]** window.

### 2 Configure the settings.

- 1 Select **[Job Accounting]** on the **[Authentication]** tab.

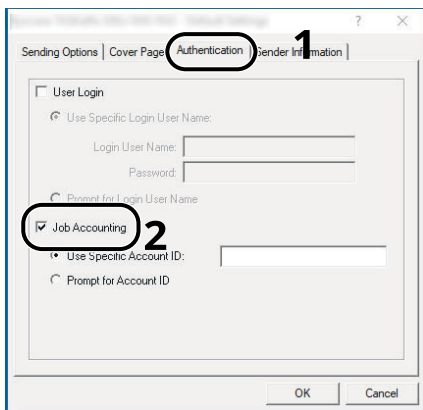

- 2 Set the Job Accounting.

**[Use Specific Account ID]:** This option can be used to specify an account ID to use the same Account ID for every FAX job. If this option is selected, the user does not have to enter the Account ID for each FAX job.

**[Prompt for Account ID]:** A screen for entering the Account ID will be displayed when attempting a transmission. The Account ID must be entered each time a transmission is attempted.

- 3 Click **[OK]**.

# Configuring Job Accounting

## Default Counter Limit

When you add a new account, you can change the default restrictions on the number of sheets used. You can set any number from 1 to 9,999,999.

The items that can be set differ depending on whether **[Individual]** or **[Total]** is selected for "Copy/Printer Count".

➔ [Copier/Printer Count \(page 9-50\)](#)

### 1 Display the screen.

- 1 **[Home]** key > [...] > **[System Menu]** > **[Job Accounting/Authentication]**



#### NOTE

If the User Authentication screen appears, log in with a user who has the privilege to configure this setting. If you do not know your login User Name or Password, please contact your Administrator.

- 2 Select "Job Accounting Setting" **[Job Accounting Setting]**.

### 2 Configure the settings.

Select the item for "Default Counter Limit" > use **[+]**, **[-]** or the numeric keys to enter the default restriction on the number of sheets > **[OK]**

**[Individual]** selected for "Copy/Printer Count"

Item	Description
<b>Copy Restriction (Total)</b>	Sets the default restriction on the number of sheets used for copying.
<b>Print Restriction (Total)</b>	Sets the default restriction on the number of sheets used for printing. Applicable print functions are as follows: <ul style="list-style-type: none"> <li>• Print from Box</li> <li>• Print from USB Drive</li> <li>• Print Report</li> <li>• Print from PC</li> </ul>
<b>Scan Restriction (Others)</b>	Sets the default restriction on the number of sheets used for scanning (excludes copying).
<b>Fax TX Restriction*<sup>1</sup></b>	Sets the default restriction on the number of sheets used for sending faxes.

\*1 Only on products with the fax function installed.

**[Total]** selected for "Copy/Printer Count"

Item	Description
<b>Print Restriction (Total)</b>	Sets the default restriction on the total number of sheets used for copying and printing.
<b>Scan Restriction (Others)</b>	Sets the default restriction on the number of sheets used for scanning (excludes copying).
<b>Fax TX Restriction*<sup>1</sup></b>	Sets the default restriction on the number of sheets used for sending faxes.

\*1 Only on products with the fax function installed.

## Counting the Number of Pages Printed

This counts the number of pages printed. Counts are classified into Total Job Accounting and Each Job Accounting. A new count can also be started after resetting the count data which was stored for a certain period of time.

The items you can view are as follows.

Item	Descriptions
<b>Printed Pages</b>	Displays the number of pages used in printing for each of the following item.
<b>Count by Function</b>	Displays the number of pages used to copy, print, FAX and their total, for each color mode.
<b>by Duplex</b>	Displays the number of pages used in Duplex (1-sided) mode, Duplex (2-sided) mode and the total for both.
<b>by Combine</b>	Displays the number of pages used in Combine (None) mode, Combine (2 in 1) mode, Combine (4 in 1) mode and the total for all three.
<b>Scanned Pages</b>	Displays the number of pages scanned for copying, faxing and other functions, as well as the total number of pages scanned.
<b>FAX TX Pages</b>	Displays the number of pages faxed.
<b>FAX TX Time</b>	Displays the total duration of FAX transmissions.
<b>Counter Reset</b>	Resets the counter. Select <b>[Reset]</b> in the confirmation screen.

### Counting the Number of Pages for All Accounts

This counts the number of pages for each account. In addition, you can reset the counts for all accounts at the same time.

#### 1 Display the screen.

- 1 **[Home]** key > [...] > **[System Menu]** > **[Job Accounting/Authentication]**



#### NOTE

If the User Authentication screen appears, log in with a user who has the privilege to configure this setting. If you do not know your login User Name or Password, please contact your Administrator.

- 2 Select " Job Accounting Setting" **[Job Accounting Counter]**.

#### 2 Check the number of pages.

- 1 Select **[Total]** to check the count.  
Select **[Counter Reset]** to reset the counter.
- 2 Confirm the count and select **[Close]**.

## Counting the Number of Pages for Each Account

This counts the number of pages for each account and resets the counts by account.

### 1 Display the screen.

- 1 [Home] key > [...] > [System Menu] > [Job Accounting/Authentication]



#### NOTE

If the User Authentication screen appears, log in with a user who has the privilege to configure this setting. If you do not know your login User Name or Password, please contact your Administrator.

- 2 Select "Job Accounting Setting" [Job Accounting Counter].

### 2 Check the number of pages.

- 1 Select the account.



#### NOTE

- Search by account ID or account name. Select either [Search (ID)] or [Search (Name)] to switch between [Search (ID)] and [Search (Name)].
- Select [Account Name] or [Account ID] to sort the account list.
- To display an account other than your own account, select [Other Account].

- 2 Check the count.

Select [Counter Reset] to reset the counter.

- 3 Confirm the count and select [Close].

## Print Accounting Report

The total pages counted of all relevant accounts can be printed as an accounting report.

Reports have different formats depending on how the count of copiers and printers is administered.

**When "Individual" is selected for Managing the Copy/Printer Count.**

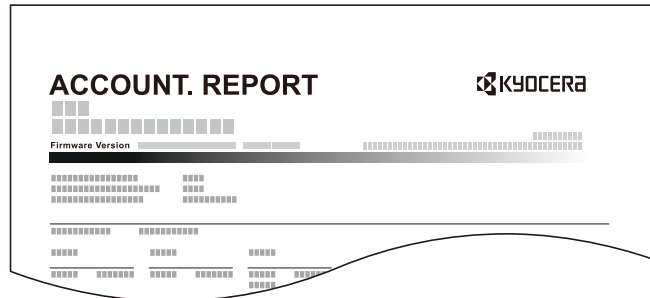

Use the procedure below to print a job accounting report.

### 1 Prepare paper.

Check that A4 or Letter paper is loaded in the cassette.

### 2 Display the screen.

1 [Home] key > [...] > [System Menu] > [Job Accounting/Authentication]



#### NOTE

If the User Authentication screen appears, log in with a user who has the privilege to configure this setting. If you do not know your login User Name or Password, please contact your Administrator.

### 3 Print the report.

"Job Accounting Setting" [Print Accounting Report] > [Print]

Accounting report is printed.

# Using Job Accounting

This section explains procedures while setting job accounting.

## Login/Logout

If job accounting is enabled, an account ID entry screen appears each time you use this machine.

Use the procedure below to login and logout.

### Login

If job accounting is enabled, an account ID entry screen appears each time you use this machine.

#### 1 Enter the account ID using the numeric keys > Select [Login]

##### NOTE

- If you entered a wrong character, select the [**Clear**] key and enter the account ID again.
- If the entered account ID does not match the registered ID, a warning beep will sound and login will fail. Enter the correct account ID.
- By selecting [**Check Counter**], you can refer to the number of pages printed and the number of pages scanned.

##### When the screen to enter the login user name and password appears

If user login administration is enabled, the screen to enter the login user name and password appears. Enter a login user name and password to login. If the user has already registered the account information, the account ID entry would be skipped.

➔ [Adding a User \(Local User List\) \(page 9-6\)](#)

#### 2 Proceed to complete the rest of the steps.

### Logout

When the operations are complete, select the [**Authentication/Logout**] key to return to the account ID entry screen.

## Apply Limit

This specifies how the machine behaves when the counter has reached the limit of restriction. The table below describes the action taken.

Item	Descriptions
<b>Immediately</b> *1	Job stops when the counter reaches its limit.
<b>Subsequently</b>	Printing/scanning of the job continues but the subsequent job will be rejected.
<b>Alert Only</b>	Job continues while displaying an alert message.

\*1 The next job will be prohibited in sending or in storing in the box.

### 1 Display the screen.

- 1 [Home] key > [...] > [System Menu] > [Job Accounting/Authentication]



#### NOTE

If the User Authentication screen appears, log in with a user who has the privilege to configure this setting. If you do not know your login User Name or Password, please contact your Administrator.

- 2 "Job Accounting Setting" [Job Accounting Setting] > "Default Setting" [Apply Limit]

### 2 Configure the settings.

Select [Immediately], [Subsequently], or [Alert Only].



## Copier/Printer Count

You can select how the copying and printing page counts are shown - either the total of both or each of copying and printing individually. The selection may influence restriction on the count and count method. For details, refer to the following:

- ➔ [Restricting the Use of the Machine \(page 9-37\)](#)
- ➔ [Counting the Number of Pages Printed \(page 9-45\)](#)
- ➔ [Print Accounting Report \(page 9-47\)](#)

### 1 Display the screen.

- 1 [Home] key > [...] > [System Menu] > [Job Accounting/Authentication]



#### NOTE

If the User Authentication screen appears, log in with a user who has the privilege to configure this setting. If you do not know your login User Name or Password, please contact your Administrator.

- 2 "Job Accounting Setting" [Job Accounting Setting] > "Default Setting" [Copy/Printer Count]

### 2 Configure the settings.

Select [Total] or [Individual].

# Unknown User Settings

## Unknown ID Job

This specifies the behavior for handling the jobs sent with unknown or unsend login user names or User ID. If the User Login is set to invalid and Job Accounting is set to valid, follow the procedure when the Account ID is unknown.

The setting items are as follows.

Item	Descriptions
Permit	The job is permitted to be printed.
Reject	The job is rejected (not printed).

### 1 Display the screen.

- 1 [Home] key > [...] > [System Menu] > [Job Accounting/Authentication]



#### NOTE

If the User Authentication screen appears, log in with a user who has the privilege to configure this setting. If you do not know your login User Name or Password, please contact your Administrator.

- 2 Select "Unknown User Settings" [**Unknown ID Job**].

### 2 Configure the settings.

- Select [**Permit**] or [**Reject**].

## Registering Information for a User whose ID is Unknown

If you register user information for a user whose ID is unknown, you can check information on the Job Status or Job History screens. In addition, you can restrict available functions.

### NOTE

This function is displayed when [**Unknown ID Job**] is set to [**Permit**].

## 1 Display the screen.

- 1 [Home] key > [...] > [System Menu] > [Job Accounting/Authentication]

### NOTE

If the User Authentication screen appears, log in with a user who has the privilege to configure this setting. If you do not know your login User Name or Password, please contact your Administrator.

- 2 Select "Unknown User Settings" [**User Property**].

## 2 Enter the user information.

Enter the user information > [OK]

Item	Descriptions
<b>User Name</b>	Enter the name displayed on the user list (up to 32 characters).
<b>Account Name</b>	<p>Register an account for a user whose ID is unknown.</p> <p>➔ <a href="#">Overview of Job Accounting (page 9-33)</a></p> <p> <b>NOTE</b></p> <ul style="list-style-type: none"> <li>• Search by account ID or account name. Select either [<b>Search (ID)</b>] or [<b>Search (Name)</b>] to switch between [<b>Search (ID)</b>] and [<b>Search (Name)</b>].</li> <li>• Select [<b>Account Name</b>] or [<b>Account ID</b>] to sort the account list.</li> </ul>
<b>Authorization Rules</b>	<p>Set usage authority for each user.</p> <p>The following restriction items are available:</p> <p><b>Print:</b></p> <p>Select whether or not to reject usage of print functions for the printer.</p> <p>Applicable print functions are as follows</p> <ul style="list-style-type: none"> <li>• Print from PC</li> </ul>

# 10 Troubleshooting

This chapter explains the following topics:

Regular Maintenance .....	10-2
Cleaning .....	10-2
Replacing the Toner Container .....	10-6
Replacing the Waste Toner Box .....	10-11
Replacing Staples (ECOSYS MA6000ifx/ECOSYS MA5500ifx only) .....	10-13
Troubleshooting .....	10-14
Solving Malfunctions .....	10-14
Remote Operation .....	10-21
Responding to Messages .....	10-23
Adjustment/Maintenance .....	10-40
Overview of Adjustment/Maintenance .....	10-40
Drum Refresh .....	10-40
Drum Refresh 2 .....	10-41
Clearing Paper Jams .....	10-42
Remove any jammed paper in the Multipurpose Tray .....	10-44
Remove any jammed paper in Cassette 1 - Cassette 5 .....	10-45
Remove any jammed paper in Duplex Unit .....	10-46
Remove any jammed paper Inside the Machine .....	10-47
Remove any jammed paper in Inner Tray / Inside Rear Cover .....	10-49
Remove any jammed paper in Document Processor .....	10-51
Clearing a Staple Jam (ECOSYS MA6000ifx/ECOSYS MA5500ifx only) .....	10-54

# Regular Maintenance

## Cleaning

Clean the machine regularly to ensure optimum printing quality.



### CAUTION

For safety, always unplug the power cord before cleaning the machine.

### Glass Platen

Wipe the inside of the document processor and the glass platen with a soft cloth dampened with alcohol or mild detergent.



### IMPORTANT

Do not use thinner or other organic solvents.

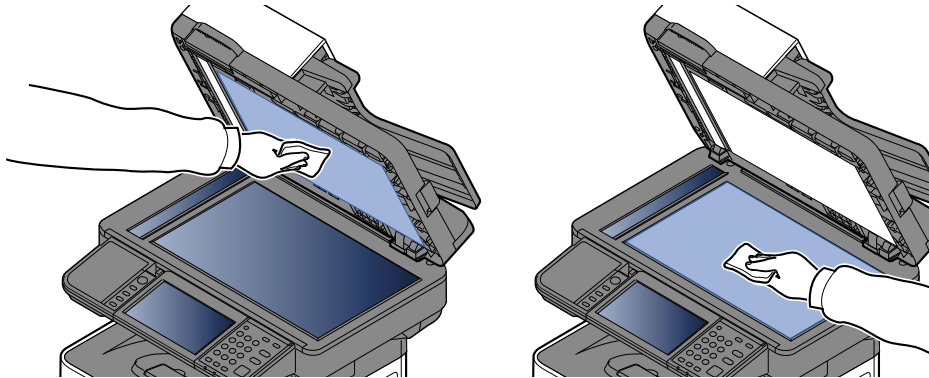

## Slit Glass

When using the document processor, clean the slit glass surface and the reading guide with the dry cloth.

✔ **IMPORTANT**

**Do not use water, soap or solvents for cleaning.**

🔍 **NOTE**

Dirt on the slit glass or the reading guide may cause black streaks to appear in the output.

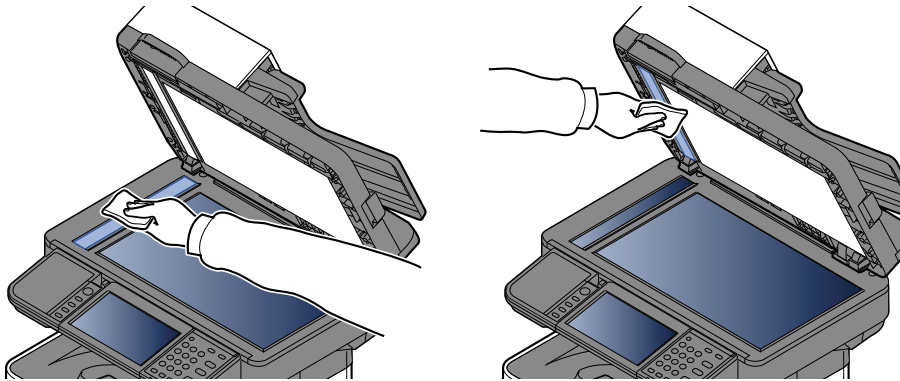

**ECOSYS MA6000ifx/ECOSYS MA5500ifx only**

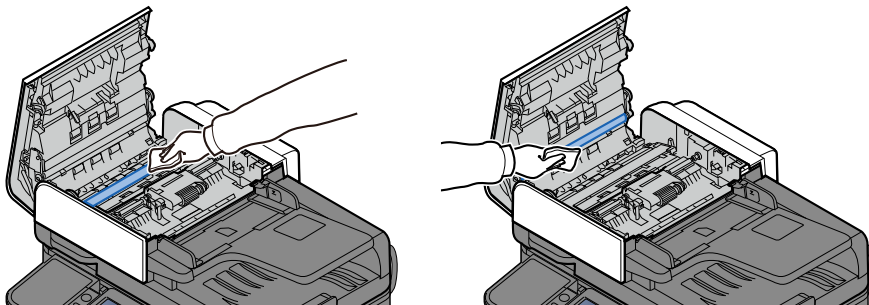

## Registration Roller

1

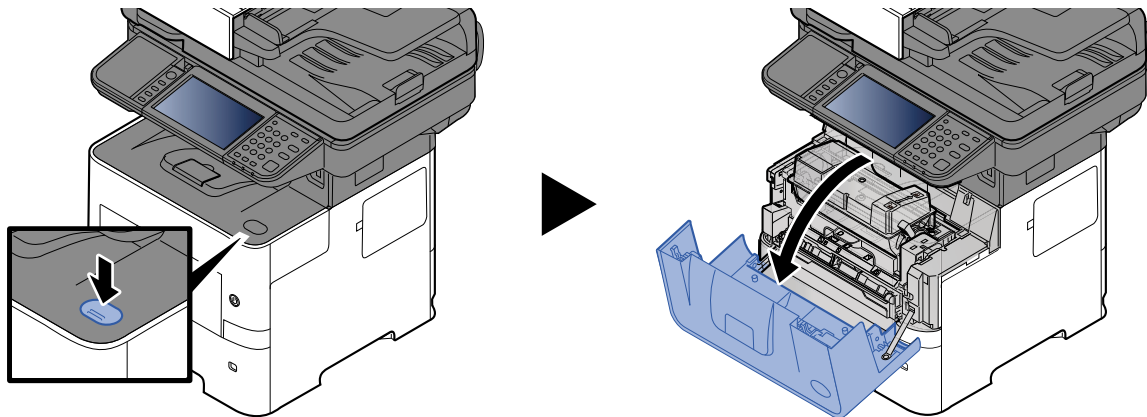

2

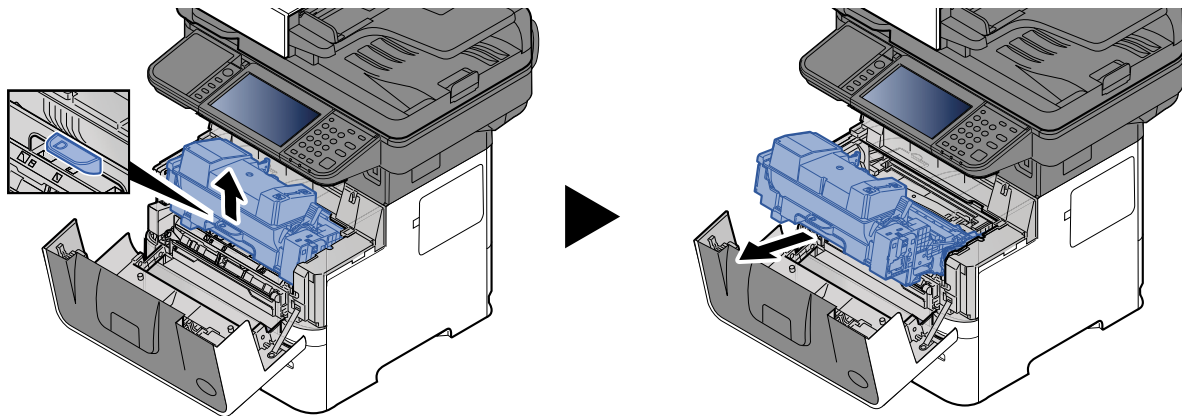

3

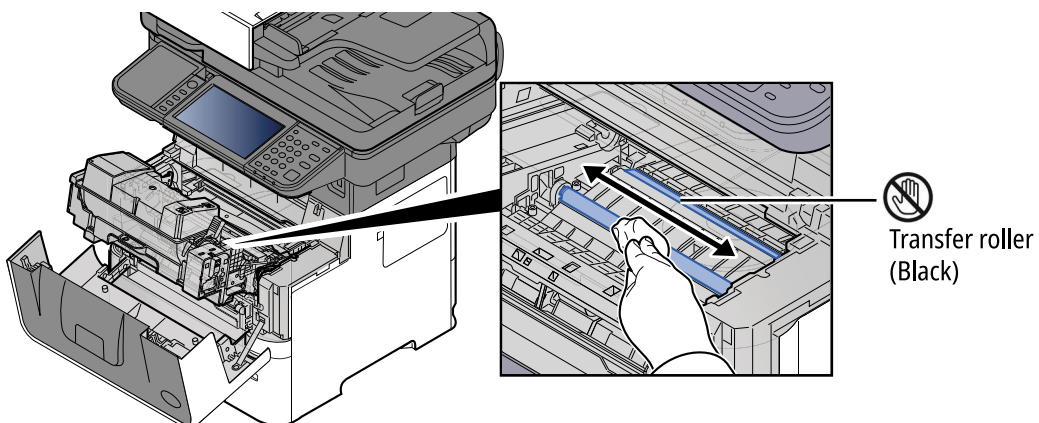

✔ **IMPORTANT**

Be careful not to touch the black transfer roller and brown transfer belt during cleaning as this may adversely affect print quality.

4

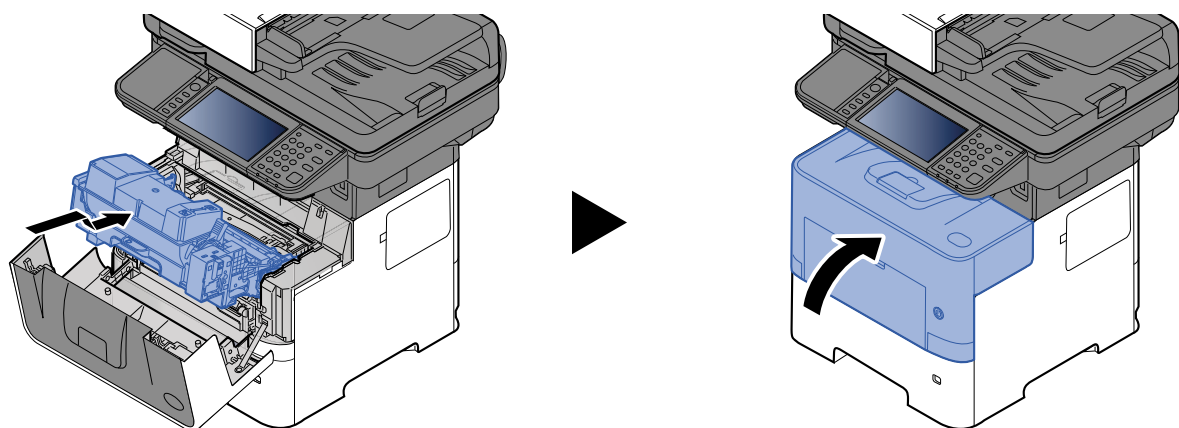

### Vents

Use a lint free cloth to clean dust and dirt away from the vents.

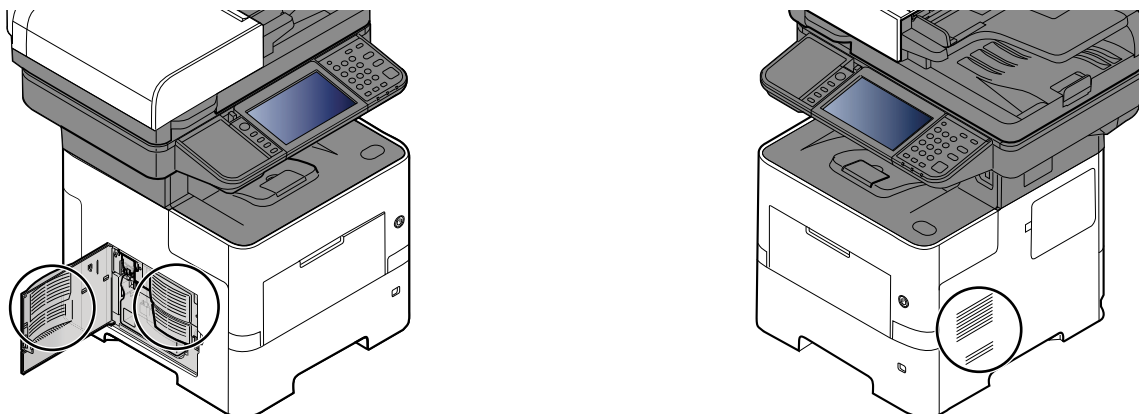



## Replacing the Toner Container

When toner runs low, "Toner is low. (Replace when empty.)" appears in the touch panel. Make sure you have a new toner container available for replacement.

When the touch panel displays " Toner is empty." , replace the toner.

### Frequency of Toner Container Replacement

The life of the toner containers depends on the amount of toner required to accomplish your printing jobs. According to ISO/IEC 19798 and EcoPrint switched off the toner container can print as follows (A4/Letter paper is assumed):

Models	Life of the Toner Container (Printable pages)
ECOSYS MA6000ifx	40,000 images
ECOSYS MA5500ifx (for North America and Latin America model)	21,000 images
ECOSYS MA5500ifx (except for North America and Latin America model)	25,000 images
ECOSYS MA4500ifx/ECOSYS MA4500ix (for Europe model)	14,500 images
ECOSYS MA4500ifx/ECOSYS MA4500ix (except for Europe model)	12,500 images

#### NOTE

- The average number of pages that can be printed by the toner containers included with the machine are as follows.  
ECOSYS MA6000ifx: 11,000 images. ECOSYS MA5500ifx: 10,000 images.  
ECOSYS MA4500ifx/ECOSYS MA4500ix: 6,000 images.
- For the toner container, always use a genuine toner container. Using a toner container that is not genuine may cause image defects and product failure.
- The memory chip in the toner container of this product stores information necessary for improving customer convenience, operation of the recycling system for used toner containers, and planning and development of new products. The stored information does not include information that makes it possible to identify individuals, and is only used anonymously for the above purposes.

#### CAUTION

**Do not attempt to incinerate parts which contain toner. Dangerous sparks may cause burns.**

## Replacing the Toner Container

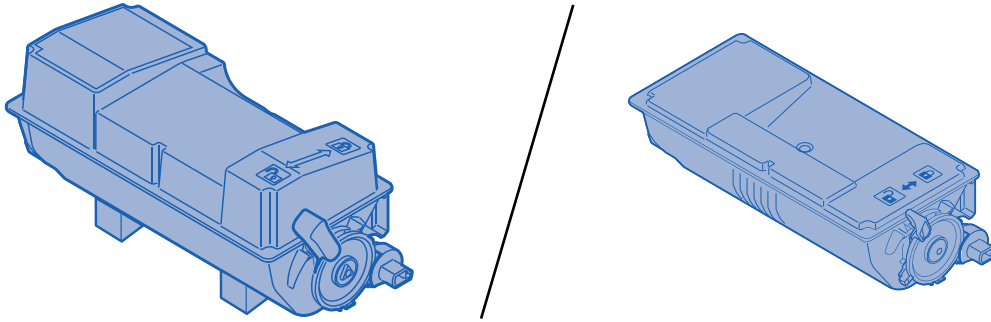

1

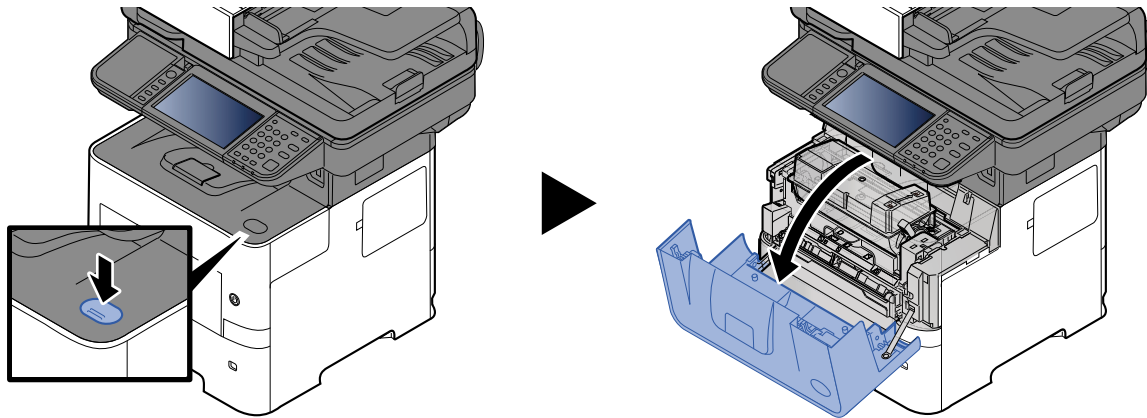

2

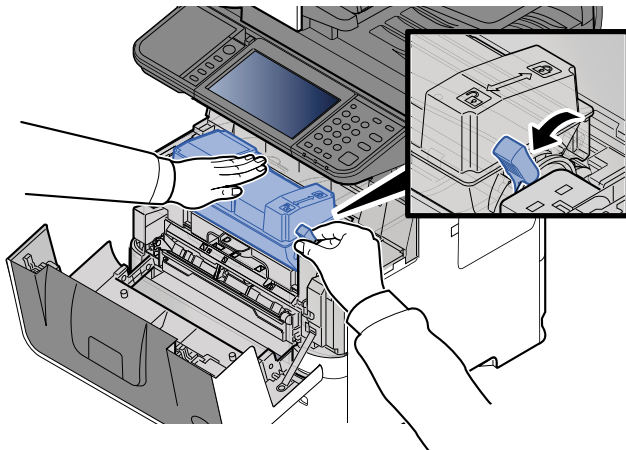

3

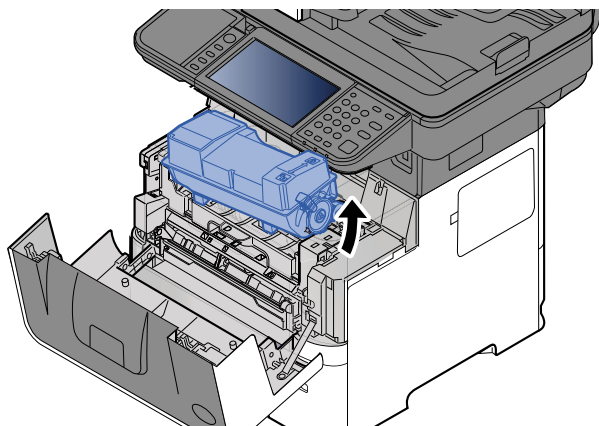

 **NOTE**

When removing the toner container from the machine, lift up the right hand side first.

4

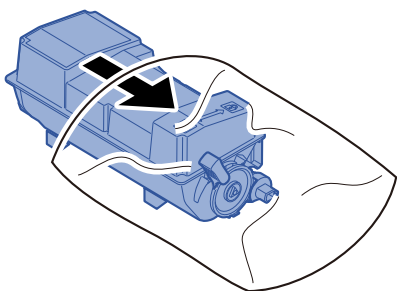

5

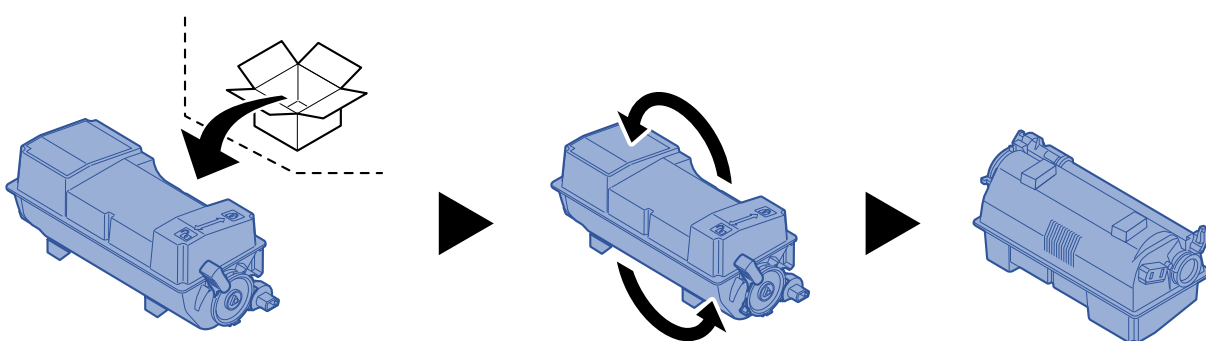

 **IMPORTANT**

Do not touch the points shown below.

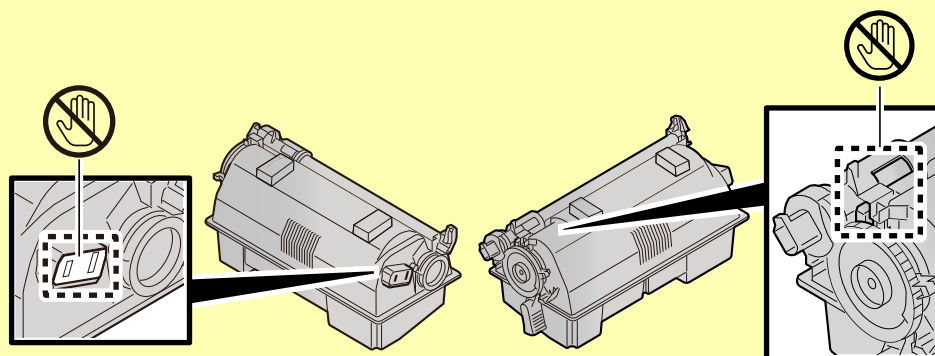

6

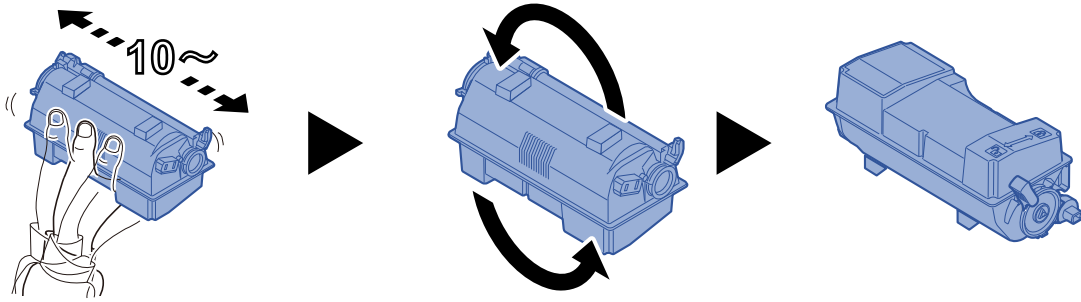

7

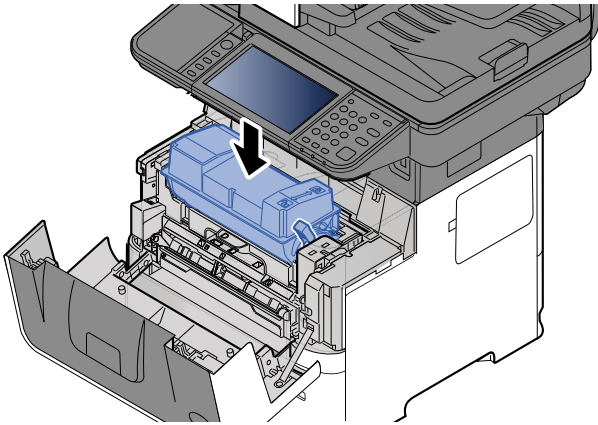

8

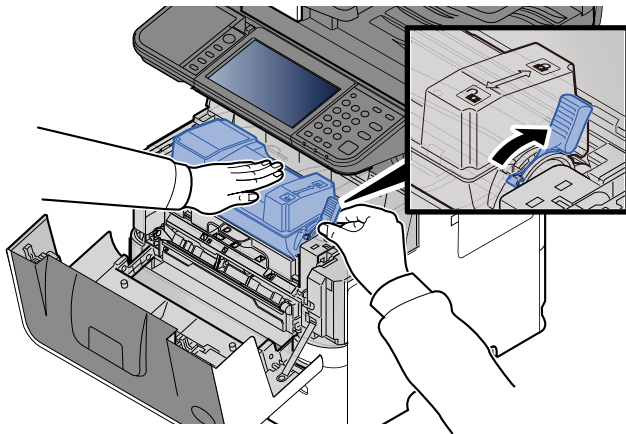

# 9

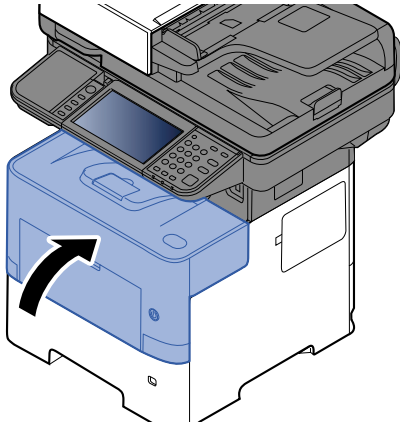

## NOTE

- If the front cover does not close, check that the new toner container is installed correctly (in step 7).
- Return the exhausted toner container to your dealer or service representative. The collected toner container will be recycled or disposed in accordance with the relevant regulations.

## Replacing the Waste Toner Box

When the waste toner box is full, the following message will be displayed.

"Replace the waste toner box."



### CAUTION

Do not attempt to incinerate parts which contain toner. Dangerous sparks may cause burns.

1

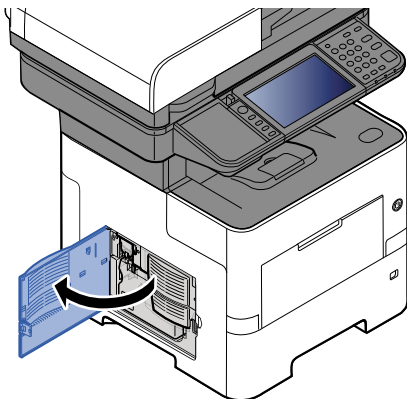

2

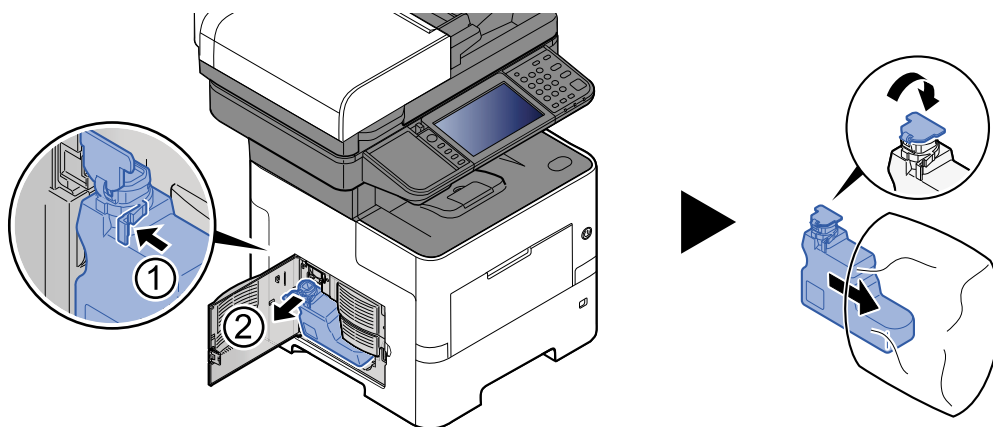

3

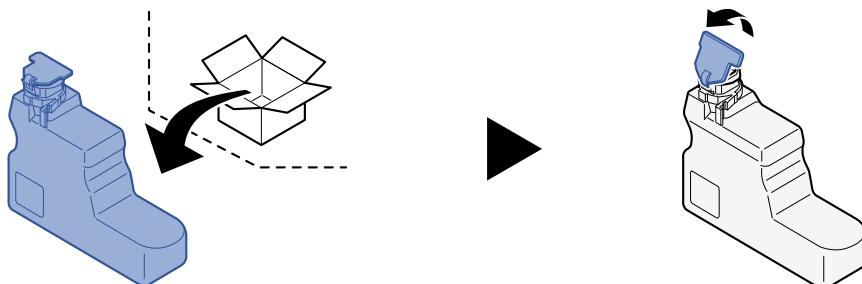

4

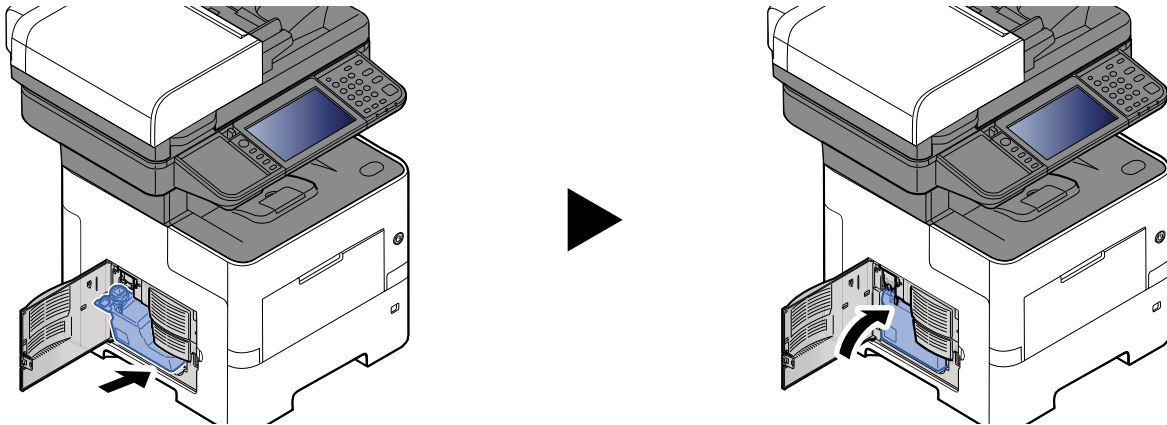

5

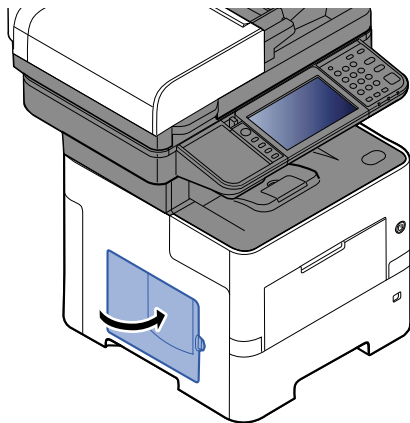

**NOTE**

Return the exhausted waste toner box to your dealer or service representative. The collected waste toner box will be recycled or disposed in accordance with the relevant regulations.

## Replacing Staples (ECOSYS MA6000ifx/ECOSYS MA5500ifx only)

Add staples to the optional manual stapler.



### NOTE

If the Staple Unit runs out of staples, contact your dealer or service representative.

1

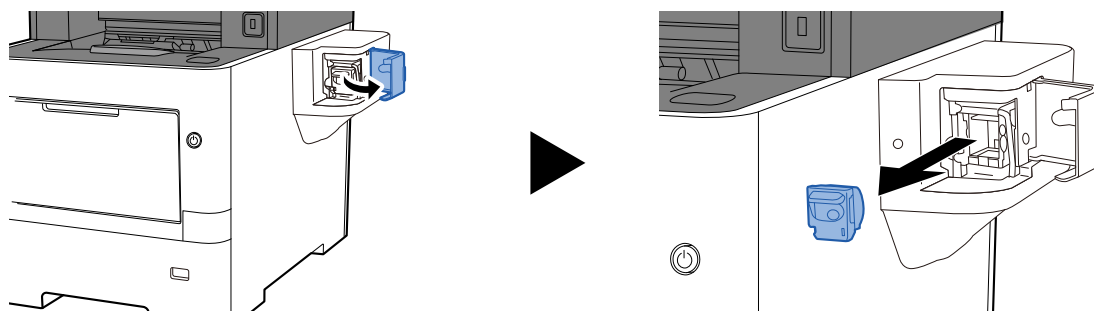

2

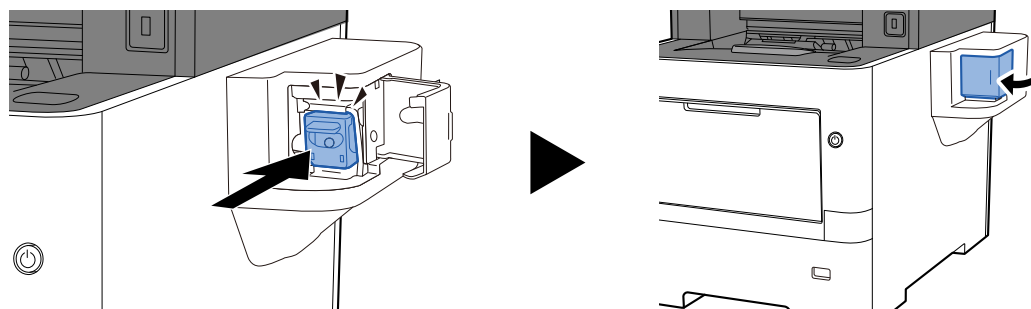



# Troubleshooting

## Solving Malfunctions

The table below provides general guidelines for problem solving.

If a problem occurs with your machine, look into the checkpoints and perform procedures indicated on the following pages. If the problem persists, contact your Service Representative.

 **NOTE**



When contacting us, the serial number will be necessary. To check the serial number, refer to the following:

➔ [Checking the Equipment's Serial Number \(page i\)](#)

## Machine Operation Trouble

When the following machine operation troubles occur, implement appropriate procedures.

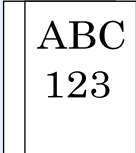
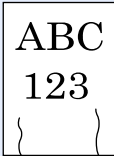
Symptom	Checkpoints	Corrective Actions	Reference Page
An application does not start.	Is the Auto Panel Reset time short?	Set the Auto Panel Reset time to 30 seconds or more.	<a href="#">page 8-8</a>
The screen does not respond when the power switch is turned on.	Is the machine plugged in?	Plug the power cord into an AC outlet.	—
The touch panel is not responsive or malfunctions.	Is the touch panel operated with wet hands?	Dry your hands to operate the touch panel.	—
	Are you operating with gloves on?	Use your bare hands or a stylus pen to operate the touch panel.	—
	Is the machine installed near a device that generates electrical noise (generator, air conditioner, etc.)?	Install the machine away from devices that generate electrical noise.	—
Pressing the <b>[Start]</b> key does not produce copies.	Is there a message on the screen?	Determine the appropriate response to the message and respond accordingly.	<a href="#">page 10-23</a>
	Is the machine in Sleep mode?	Select any key on the operation panel to recover the machine from Sleep mode.	<a href="#">page 2-46</a>
Blank sheets are ejected. 	Are the originals loaded correctly?	When placing originals on the platen, place them face-down and align them with the original size indicator plates.	<a href="#">page 5-2</a>
		When placing originals in the document processor, place them face-up.	<a href="#">page 5-2</a>
	—	—	Check that the settings of the application software.

Symptom	Checkpoints	Corrective Actions	Reference Page
Paper often jams.	Is the paper loaded correctly?	Load the paper correctly.	<a href="#">page 3-2</a>
	—	Turn the orientation 180 degrees around in which the paper is positioned.	<a href="#">page 3-2</a>
	Is the paper of the supported type? Is it in good condition?	Remove the paper, turn it over, and reload it.	<a href="#">page 3-3</a>
	Is the paper curled, folded or wrinkled?	Replace the paper with new paper.	<a href="#">page 3-2</a>
	Are there any loose scraps or jammed paper in the machine?	Remove any jammed paper.	<a href="#">page 10-42</a>
2 or more sheets are overlaps when ejected. (multi feed) 	—	Load the paper correctly.	<a href="#">page 3-2</a>
Printouts are wrinkled. 	Is the paper loaded correctly?	Load the paper correctly.	<a href="#">page 3-2</a>
	—	Turn the orientation 180 degrees around in which the paper is positioned.	<a href="#">page 3-2</a>
	Is the paper damp?	Replace the paper with new paper.	<a href="#">page 3-2</a>
Printouts are curled. 	—	Turn the orientation 180 degrees around in which the paper is positioned.	<a href="#">page 3-2</a>
	Is the paper damp?	Replace the paper with new paper.	<a href="#">page 3-2</a>
Printer driver cannot be installed.	Is the driver installed with the host name while Wi-Fi or Wi-Fi Direct function is available?	Specify the IP address instead of the host name.	<a href="#">page 2-53</a>

Symptom	Checkpoints	Corrective Actions	Reference Page
Cannot print.	Is the machine plugged in?	Plug the power cord into an AC outlet.	—
	Is the machine powered on?	Turn on the power switch.	<a href="#">page 2-11</a>
	Are the USB cable and network cable connected?	Connect the correct USB cable and network cable securely.	<a href="#">page 2-9</a>
	Is the print job paused?	Resume printing.	<a href="#">page 7-2</a>
	When the wired or Wi-Fi network is configured using the name resolution, does the IP address (private address) of the other network which can not access coexists?	The number of host name and domain name which can be used with the machine is one respectively. Configure the network under this restriction.	—
		Change the settings of name resolution such as NetBEUI and DNS, or network environment settings.	<b>Command Center RX User Guide</b>
Select Wi-Fi, Wired Network or Optional Network as an unlimited-use network on Primary Network (Client).		<a href="#">page 8-55</a>	
	Set to <b>[Wired Network]</b> or <b>[Wi-Fi]</b> either one of <b>[On]</b> , and set the other setting to <b>[Off]</b> .	<a href="#">page 8-55</a>	
Cannot print with USB drive. USB drive not recognized.	Is the USB host blocked?	Select <b>[Unblock]</b> in the USB host settings.	<a href="#">page 8-56</a>
	—	Check that the USB drive is securely plugged into the machine.	—
While "Auto-IP" is already set to <b>[On]</b> , the IP address is not assigned automatically.	Is a value other than "0.0.0.0" entered for the link local address of TCP/IP(v4)?	Enter "0.0.0.0" for the IP address of TCP/IP(v4).	<a href="#">page 2-36</a>

Symptom	Checkpoints	Corrective Actions	Reference Page
Cannot send via SMB.	Is the network cable connected?	Connect the correct network cable securely.	<a href="#">page 2-9</a>
	Have the network settings for the equipment been configured properly?	Configure the TCP/IP settings properly.	<a href="#">page 8-42</a>
	Have the folder sharing settings been configured properly?	Check sharing settings and access privileges under the folder properties.	<a href="#">page 3-28</a>
	Is the selected interface selected as the Primary Network?	Specify the host name or IP address of the interface selected as the Primary Network, or set the interface to be used again.	<a href="#">page 8-55</a>
	Has the SMB protocol been set to <b>[On]</b> ?	Set the SMB protocol setting to <b>[On]</b> .	<a href="#">page 8-31</a>
	Has <b>[Host Name]</b> been entered properly? *1	Check the name of the computer to which data is being sent.	<a href="#">page 5-17</a>
	Has <b>[Path]</b> been entered properly?	Check the share name for the shared folder.	<a href="#">page 5-17</a>
	Has <b>[Login User Name]</b> been entered properly? *1 *2	Check the domain name and login user name.	<a href="#">page 5-17</a>
	Has the same domain name been used for <b>[Host Name]</b> and <b>[Login User Name]</b> ?	Delete the domain name and backslash ("") from <b>[Login User Name]</b> .	<a href="#">page 5-17</a>
	Has <b>[Login Password]</b> been entered properly?	Check the login password.	<a href="#">page 5-50</a>
	Have exceptions for Windows Firewall been configured properly?	Configure exceptions for Windows Firewall properly.	<a href="#">page 3-23</a>
	Do the time settings for the equipment, domain server, and data destination computer differ?	Set the equipment, domain server, and data destination computer to the same time.	—
	Is the screen displaying Send error?	Refer to <a href="#">Responding to Send Error</a> .	<a href="#">page 10-36</a>
Cannot send via the e-mail.	Is the E-mail send size limit set in the SMTP server registered on the machine?	Check the limit value is entered to "E-mail Size Limit" of <b>[E-mail]</b> setting in Command Center RX and change the value as necessary.	<a href="#">page 2-75</a>
The machine is emitting steam in the area around the paper ejection slot.	Check the room temperature to see if it is low, or if damp paper was used.	Depending on the printing environment and the paper's condition, the heat generated during printing will cause the moisture in the paper to evaporate, and the steam emitted may look like smoke. This is not a problem, and you can continue printing. If the steam concerns you, raise the room temperature, or replace the paper with a newer, dryer paper.	—



Symptom	Checkpoints	Corrective Actions	Reference Page
Cannot create Searchable PDF file.	Is the proper language selected?	Check the language to extract.	<a href="#">page 6-38</a>
	Can the texts on the original not be recognized as texts, or is the PDF creation time taken?	The original orientation is correct.	<a href="#">page 6-38</a>
Cannot search a text that you want to search on the PDF file.	Have you set [ <b>OCR Text Recognition</b> ] in [ <b>File Format</b> ]?	Set [ <b>OCR Text Recognition</b> ] in [ <b>File Format</b> ].	<a href="#">page 6-38</a>
	Are the texts of the scanned original faded or too light?	Set [ <b>Density</b> ] to darker level.	<a href="#">page 6-30</a>
	Is the background of the scanned original too dark and the texts are difficult to recognize?	Set [ <b>Background Density Adj.</b> ] to [ <b>Auto</b> ] or [ <b>Manual</b> ] and manually adjust the density lighter. Otherwise, set [ <b>Density</b> ] to darker level.	<a href="#">page 6-27</a> <a href="#">page 6-30</a>
	Is the text or image on the back of the original visible on the front?	Set [ <b>Prevent Bleed-through</b> ] to [ <b>On</b> ].	<a href="#">page 6-31</a>
Cannot find the machine with WSD.	Did you search by specifying the machine's IP address or host name?	For security reasons, [ <b>HTTP</b> ] protocol is set to [ <b>Off</b> ], and therefore you cannot search by IP address or host name.	—



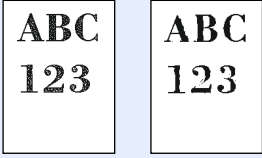
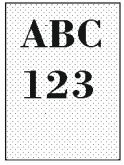
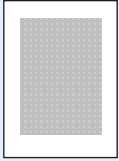

\*1 You can also enter a full computer name as the host name (for example, pc001.abcdnet.com).

\*2 You can also enter login user names in the following formats:  
 Domain\_name/user\_name (for example, abcdnet/james.smith)  
 User\_name@domain\_name (for example, james.smith@abcdnet)

## Printed Image Trouble

When the following printed image trouble occurs, implement appropriate procedures.

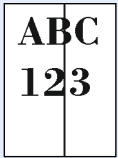
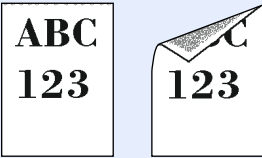
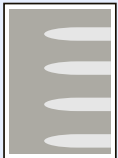
Symptom	Checkpoints	Corrective Actions	Reference Page
<p>Printouts are totally too light.</p> 	Is the paper damp?	Replace the paper with new paper.	<a href="#">page 3-2</a>
	Have you changed the density?	Select appropriate density level.	<a href="#">page 6-27</a> <a href="#">page 8-62</a>
	Is the toner distributed evenly within the toner container?	Shake the toner container from side to side several times.	<a href="#">page 10-6</a>
	Is EcoPrint mode enabled?	Disable <b>[EcoPrint]</b> mode.	<a href="#">page 8-26</a>
	—	Run <b>[Drum Refresh]</b> .	<a href="#">page 10-40</a>
	—	Make sure the paper type setting is correct for the paper being used.	<a href="#">page 8-17</a>
<p>White background parts of the image appear to have a slight overall coloration.</p> 	Have you changed the density?	Select appropriate density level.	<a href="#">page 6-27</a> <a href="#">page 8-62</a>
	—	Run <b>[Drum Refresh]</b> .	<a href="#">page 10-40</a>
<p>Copies have a moire pattern (dots grouped together in patterns and not aligned uniformly).</p> 	Is the original a printed photograph?	<b>When making copies</b> Set the original image to <b>[Printer Output]</b> or <b>[Book/Magazine]</b> in <b>[Photo]</b> .	<a href="#">page 6-28</a>
<p>Texts are not clearly printed.</p> 	Did you choose appropriate image quality for the original?	Select appropriate image quality.	<a href="#">page 6-28</a>
<p>Black or color dots appear on the white background.</p> 	Is the original holder or the glass platen dirty?	Clean the original holder or the glass platen.	<a href="#">page 10-2</a>
	—	Run <b>[Drum Refresh]</b> .	<a href="#">page 10-40</a>

Symptom	Checkpoints	Corrective Actions	Reference Page
Printed images are fuzzy. Printed images are cut off. 	Is the device used in an environment with high humidity or where the temperature or humidity changes suddenly?	Use in an environment that has suitable humidity.	—
	—	Run [ <b>Drum Refresh</b> ].	<a href="#">page 10-40</a>
Printed images are skewed. 	Are the originals placed correctly?	When placing originals on the platen, align them with the original size indicator plates.	<a href="#">page 5-2</a>
	—	When placing originals in the document processor, align the original width guides securely before placing the originals.	<a href="#">page 5-4</a>
	Is the paper loaded correctly?	Check the position of the paper width guides.	<a href="#">page 3-3</a>
Printed images have vertical lines. 	Is the slit glass dirty?	Clean the slit glass.	<a href="#">page 10-3</a>
Dirt on the top edge or back of the paper. 	Is the interior of the machine dirty?	Open the right cover. If the machine interior is dirty with toner, clean it using soft, dry, lint-free cloth.	<a href="#">page 10-2</a>
Part of the image is periodically faint or shows white lines. 	—	Run [ <b>Drum Refresh</b> ].	<a href="#">page 10-40</a>
Print on the back of the sheet is visible on the front. 	—	Set [ <b>Prevent Bleed-through</b> ] to [ <b>On</b> ].	<a href="#">page 6-31</a> <a href="#">page 8-26</a>

## Remote Operation

This function enables the system administrator to explain how to operate the panel and troubleshoot to user, by accessing operation panel of the machine at remote using browser and VNC software.

### Executing Remote Operation from Browser

The supported Browser is as follows. We recommend the latest version of browser to use Remote Operation.

- Google Chrome (Version 21.0 or later)
- Microsoft Edge
- Mozilla Firefox (Version 14.0 or later)
- Safari (Version 5.0 or later)

This procedure explains how to execute Remote Operation from Command Center RX using Google Chrome.

#### NOTE

To execute Remote Operation using other browsers, refer to the following:

➔ [Command Center RX User Guide](#)

### 1 Display the screen.

[Home] key > [...] > [System Menu] > [Network Settings] > "Network Settings" [Protocol Settings]

### 2 Set "Enhanced VNC over SSL" to [On].

➔ [Protocol Settings \(page 8-46\)](#)

#### NOTE

You can configure the protocol settings using Command Center RX.

➔ [Command Center RX User Guide](#)

### 3 Configure settings for remote operation.

1 [Home] key > [...] > [System Menu] > [Network Settings] > "Connectivity" [Remote Operation] > [On]

2 Select [Off], [Use Password], or [Administrator Only].

When you select [Use Password], enter the password in "Password" and "Confirm Password", then select [OK].

➔ [Remote Operation \(page 8-54\)](#)

#### NOTE

You can configure settings for remote operation using Command Center RX

➔ [Command Center RX User Guide](#)

### 4 Restart the machine.

➔ [Restart Entire Device \(page 8-55\)](#)

### 5 Start up the browser.

Enter "https://" and host name of the machine to access the Command Center RX

➔ [Command Center RX \(page 2-71\)](#)



## 6 Select [Device Information/Remote Operation] > [Remote Operation].

## 7 Click [Start] button.

### NOTE

- If the user is logged in to the device, the permission confirmation screen will be displayed on the operation panel. Select **[Yes]**.
- If pop-up blocking of the browser occurs during connection of the Remote Operation, select Always allow pop-ups from https:// [host name], and click Done. Perform Remote Operation after waiting 1 minute or more.

When the Remote Operation is started up, the operation panel screen will be displayed on the system administrator's or user's PC screen.

## Executing Remote Operation from VNC Software

### 1 Display the screen.

[Home] key > [...] > [System Menu] > [Network Settings] > "Network Settings" [Protocol Settings]

### 2 Set "Enhanced VNC (RFB)" to [On].

➔ [Protocol Settings \(page 8-46\)](#)

### NOTE

- When setting "VNC (RFB) over TLS" to **[On]**, the communication is encrypted.
- You can configure the protocol settings using Command Center RX.

➔ [Command Center RX User Guide](#)

### 3 Startup the remote operation.

1 Start up the VNC software.

2 Enter the following format separated by a colon to start up the remote operation.

"IP address: port number"

### NOTE

When setting "VNC (RFB)" to **[On]** in step 2, the default port number is 9062. When setting "VNC (RFB) over SSL " to **[On]**, the default port number is 9063.

➔ [Protocol Settings \(page 8-46\)](#)

## Responding to Messages

If the touch panel or the computer displays any of these messages, follow the corresponding procedure.

 **NOTE**

When contacting us, the serial number will be necessary. To check the serial number, refer to the following:

➔ [Checking the Equipment's Serial Number \(page i\)](#)

**A**

Message	Checkpoints	Corrective Actions	Reference Page
<b>Abnormalities were detected.</b>	—	The error was detected. The execution of the program is stopped. Please contact to the service representatives	—
<b>Access point was not detected.</b>	—	Check if the access point has been set correctly.	—
<b>Add paper in cassette #.</b>	Is the indicated cassette out of paper?	Load paper. Select the available paper. Select <b>[Continue]</b> to print.	<a href="#">page 3-2</a>
	Are five or less envelopes loaded in the cassette?	Pull the cassette and loosen the paper length and width guides slightly.	—
<b>Add paper in Multipurpose tray.</b>	Is the paper of the selected size loaded in the multipurpose tray?	Load paper. Select the available paper. Select <b>[Continue]</b> to print.	<a href="#">page 3-11</a>
<b>Adjusting Scanner.</b>	—	The machine is under the adjustment to maintain its quality. Please wait.	—

**B**

Message	Checkpoints	Corrective Actions	Reference Page
<b>Box is not found.</b>	—	The specified box cannot be found. Job is canceled. Select <b>[End]</b> .	—
<b>Box limit exceeded.</b> <sup>*1</sup>	Is <b>[End]</b> displayed on the screen?	The specified box is full, and no further storage is available. Job is canceled. Select <b>[End]</b> . Try to perform the job again after printing or deleting data from the box.	—
	—	Repeat Copy box is full, and no further repeat copy is available. Select <b>[Continue]</b> to print scanned pages. Select <b>[Cancel]</b> to cancel the job.	—
<b>Broadcast error</b>	—	An error has occurred during broadcast transmission. The job is canceled. Select <b>[End]</b> .	—

\*1 When Auto Error Clear is set to **[On]**, processing resumes automatically after a set amount of time elapses.

➔ [Auto Error Clear \(page 8-20\)](#)

**C**

Message	Checkpoints	Corrective Actions	Reference Page
<b>Cannot connect to Authentication Server.</b> <sup>*1</sup>	—	Set machine time to match the server's time.	<a href="#">page 2-35</a>
	—	Check the domain name.	<a href="#">page 9-18</a>
	—	Check the host name.	<a href="#">page 9-17</a>
	—	Check the connection status with the server.	—
<b>Cannot connect to Server.</b>	—	Check the connection status with the server.	—
<b>Cannot connect.</b>	—	This appears when the Wi-Fi or Wi-Fi Direct connection did not complete. Check the settings, and check the signal conditions.	<a href="#">page 8-39</a> <a href="#">page 8-40</a>
<b>Cannot duplex print on this paper.</b> <sup>*1</sup>	Did you select a paper size/type that cannot be duplex printed?	If the selected paper is not changed and <b>[Continue]</b> is selected, duplex is released. Select the available paper. Select <b>[Continue]</b> to print.	—
<b>Cannot duplex print on this paper size.</b> <sup>*1</sup>			
<b>Cannot duplex print on this paper type.</b> <sup>*1</sup>			

Message	Checkpoints	Corrective Actions	Reference Page
<b>Cannot output this paper to the tray.</b>	Is the cassette you selected correct?	Select the available paper. Select <b>[Continue]</b> to print.	—
<b>Cannot perform remote printing.</b>	—	Remote printing is prohibited. The job is canceled. Select <b>[End]</b> .	<a href="#">page 8-35</a>
<b>Cannot print the specified number of copies.*<sup>1</sup></b>	—	Only one copy is available. Select <b>[Continue]</b> to continue printing. Select <b>[Cancel]</b> to cancel the job.	—
<b>Cannot process this job.*<sup>1</sup></b>	—	Restricted by Authorization settings. The job is canceled. Select <b>[End]</b> .	—
	—	Restricted by Job Accounting. The job is canceled. Select <b>[End]</b> .	—
<b>Cannot read data in this ID card.</b>	—	In registration process, the ID card information was not read correctly. Hold again the ID card over the ID card reading part. If the same message still appears, the ID card may not be compatible with this product. Change it to another ID card.	—
<b>Cannot recognize.</b>	—	Make sure your ID card has been registered.	—
<b>Cannot use ##### due to a failure.</b>	—	Call service.	—
<b>Cannot use following functions due to scanner failure. &gt;&gt; Copy, Send, Fax, Storing in Box</b>	—	Scanner of this machine has failed. Contact your service representative. You can use the print function.	—
<b>Check Document Processor.</b>	Is the top cover of the document processor open?	Close the document processor cover.	—
	Is the document processor open?	Close the document processor.	—
<b>Check the paper in Multipurpose Tray.</b>	—	The paper size is different. Set selected size paper and select <b>[Continue]</b> .	—

Message	Checkpoints	Corrective Actions	Reference Page
<b>Check the toner container.</b>	—	<p>Open the main unit front cover and remove the toner container. Shake carefully and replace.</p> <p> <b>NOTE</b> If you select [<b>Open Toner Container Cover</b>], you can open the Toner Container Cover that you closed accidentally.</p>	—
<b>Confidential document was detected.</b>	—	The machine detects the document guard pattern. Job is canceled. Select [ <b>End</b> ].	—

\*1 When Auto Error Clear is set to [**On**], processing resumes automatically after a set amount of time elapses.

➔ [Auto Error Clear \(page 8-20\)](#)

**D**

Message	Checkpoints	Corrective Actions	Reference Page
<b>Drum unit is not install.</b>	—	The drum unit is improperly installed or not installed. Open the front cover and set the drum unit correctly.	<a href="#">page 10-40</a>

**E**

Message	Checkpoints	Corrective Actions	Reference Page
<b>Encrypted PDF Password error.</b>	Is the password you input correct?	Password is not entered or is incorrect.	—
<b>Error occurred at cassette #.</b>	—	Open the cassette. Check inside the machine and remove the paper.	—

**F**

Message	Checkpoints	Corrective Actions	Reference Page
<b>Failed to activate.</b>	—	Failed to activate the application. Contact administrator.	—
	—	Expansion Authentication is disabled. Turn the power switch off and on. If the error exists, contact administrator.	—

Message	Checkpoints	Corrective Actions	Reference Page
<b>Failed to send via SMB.</b>	Is the machine and the PC to which the scanned image is to be sent connected to the network?	<p>Check the network and SMB settings.</p> <ul style="list-style-type: none"> <li>The network cable is connected.</li> <li>The hub is not operating properly.</li> <li>The server is not operating properly.</li> <li>Host name and IP address</li> <li>Port number</li> </ul>	<a href="#">page 2-8</a>
	Is the account information (user ID, password) used to access the shared folder to which the scanned image is to be sent incorrect?	<p>Check the following settings of the PC to which the scanned image is to be sent.</p> <ul style="list-style-type: none"> <li>Host name</li> <li>Path</li> <li>Login user name</li> </ul> <p> <b>NOTE</b> If the sender is a domain user, specify the domain name. [Login User ID]@[Domain Name] Example: sa720XXXX@km</p> <ul style="list-style-type: none"> <li>Login password</li> <li>Folder share permissions of the recipient</li> </ul>	—
<b>Failed to specify Job Accounting.*1</b>	—	Failed to specify Job Accounting when processing the job externally. The job is canceled. Select <b>[End]</b> .	—
<b>Failed to store job retention data.</b>	—	The job is canceled. Select <b>[End]</b> .	—

\*1 When Auto Error Clear is set to **[On]**, processing resumes automatically after a set amount of time elapses.

➔ [Auto Error Clear \(page 8-20\)](#)

I

Message	Checkpoints	Corrective Actions	Reference Page
<b>Incorrect account ID.*1</b>	—	The account ID was incorrect when processing the job externally. The job is canceled. Select <b>[End]</b> .	—
<b>Incorrect box password.</b>	—	The box password was incorrect when processing the job externally. The job is canceled. Select <b>[End]</b> .	—

Message	Checkpoints	Corrective Actions	Reference Page
<b>Incorrect Login User Name or Password.*<sup>1</sup></b>	—	The login user name or password was incorrect when processing the job externally. The job is canceled. Select <b>[End]</b> .	—
<b>Install Waste Toner Box.</b>	—	The waste toner box is not installed correctly. Set it correctly.	<a href="#">page 10-11</a>

\*1 When Auto Error Clear is set to **[On]**, processing resumes automatically after a set amount of time elapses.

➔ [Auto Error Clear \(page 8-20\)](#)

**J**

Message	Checkpoints	Corrective Actions	Reference Page
<b>Job Accounting restriction exceeded.*<sup>1</sup></b>	Is the acceptable printing count restricted by Job Accounting exceeded?	The printing count exceeded the acceptable count restricted by Job Accounting. Cannot print any more. The job is canceled. Select <b>[End]</b> .	—

\*1 When Auto Error Clear is set to **[On]**, processing resumes automatically after a set amount of time elapses.

➔ [Auto Error Clear \(page 8-20\)](#)

**K**

Message	Checkpoints	Corrective Actions	Reference Page
<b>KPDL error.*<sup>1</sup></b>	—	PostScript error has occurred. The job is canceled. Select <b>[End]</b> .	—

\*1 When Auto Error Clear is set to **[On]**, processing resumes automatically after a set amount of time elapses.

➔ [Auto Error Clear \(page 8-20\)](#)

**M**

Message	Checkpoints	Corrective Actions	Reference Page
<b>Machine failure.</b>	—	Internal error has occurred. Make a note of the error code displayed on the screen. Call service.	—
<b>Malicious program was detected.</b>	—	There might be the unauthorized program. The execution is stopped. Please contact to the administrator.	—



Message	Checkpoints	Corrective Actions	Reference Page
<b>Maximum number of scanned pages.</b>	Is the acceptable scanning count exceeded?	Cannot scan pages any more. Follow the instructions on the screen.	—
<b>Memory is full.*1</b>	—	The memory is full and the job cannot be continued. Select <b>[Continue]</b> to print the scanned pages. The print job cannot be processed completely. Select <b>[Cancel]</b> to cancel the job.	—
	—	The process cannot be performed due to insufficient memory. If only <b>[End]</b> is available, select <b>[End]</b> . The job will be canceled.  When insufficient memory occurred frequently, contact your dealer or service representative.	—

\*1 When Auto Error Clear is set to **[On]**, processing resumes automatically after a set amount of time elapses.

➔ [Auto Error Clear \(page 8-20\)](#)

**P**

Message	Checkpoints	Corrective Actions	Reference Page
<b>Paper jam.</b>	—	If a paper jam occurs, the machine will stop and the location of the jam will be indicated on the screen. Leave the machine on and follow the instructions to remove the jammed paper.	<a href="#">page 10-42</a>
<b>Paper left.</b>	—	Remove paper from the finisher tray.	—
	—	Remove paper from the document finisher.	—
<b>Performing Drum Refresh...</b>	—	The machine is under the adjustment to maintain its quality. Please wait.	—
<b>Preparing to print.</b>	—	The machine is under the adjustment to maintain its quality. Please wait.	—

**R**

Message	Checkpoints	Corrective Actions	Reference Page
<b>Regulating the temperature...</b>	—	The machine is under the adjustment to maintain its quality. Please wait.	—
<b>Remove originals in the document processor.</b>	Are there any originals left in the document processor?	Remove originals from the document processor.	—
<b>Replace all originals and press [Continue].</b>	—	Remove originals from the document processor, put them back in their original order, and place them again. Select <b>[Continue]</b> to resume printing. Select <b>[Cancel]</b> to cancel the job.	—
<b>Running security function...</b>	—	Running security function. Please wait.	—

**S**

Message	Checkpoints	Corrective Actions	Reference Page
<b>Scanner memory is full.*1</b>	—	Scanning cannot be performed due to insufficient memory of the scanner. Follow the instructions on the screen.	—
<b>Scheduled sending jobs exceeded.</b>	—	The number of jobs has exceeded the limit set for delayed transmission. Select <b>[End]</b> . The job is canceled. Wait until the delayed transmission is executed, or cancel the delayed transmission and then perform the job again.	—
<b>Select another cassette.</b>	Is the cassette you selected correct?	The specified cassette is a fax special stage. Select another valid cassette. Select <b>[Continue]</b> to print.	—
<b>Send Error.*1</b>	—	An error has occurred during transmission. The job is canceled. Select <b>[End]</b> . Refer to Responding to Send Error for the error code and corrective actions.	<a href="#">page 10-36</a>
<b>Skewed originals or multi originals fed at once.</b>	—	See the caution attached on the document processor and check the originals. If the originals are jammed, follow the instructions on the screen to remove the originals.	<a href="#">page 10-44</a>

Message	Checkpoints	Corrective Actions	Reference Page
<b>SSD error.</b>	—	<p>An error has occurred on the SSD. Job is canceled. Select <b>[End]</b>.</p> <p>The error cords are as follows.</p> <p>01: The amount of data that can be saved at once has been exceeded. Restart the system or turn the power OFF/ON. If the error still occurs, divide the file into smaller files. If the error occurs after the file is divided, the SSD is damaged. Execute <b>[System Initialization]</b>.</p> <p>04: Insufficient space on the SSD to complete this operation. Move data or delete unneeded data.</p> <p> <b>NOTE</b></p> <p>Please be aware that when you carry out initialization of the system, the data saved in SSD will be erased.</p>	—
<b>Subaddress box limit exceeded.</b>	—	<p>Follow the instructions on the screen and delete documents from the Subaddress to make room for FAX reception.</p> <p>To check the canceled job, select the <b>[Status/Job Cancel]</b> key and then <b>[Printing Jobs]</b> to check receipt result.</p>	<b>FAX Operation Guide</b>
<b>System error.</b>	—	<p>System error has occurred. Follow the instructions on the screen.</p>	—

\*1 When Auto Error Clear is set to **[On]**, processing resumes automatically after a set amount of time elapses.

➔ [Auto Error Clear \(page 8-20\)](#)

**T**

Message	Checkpoints	Corrective Actions	Reference Page
<b>The cover is open.</b>	Is there any cover which is open?	Close the cover indicated on the screen.	—
<b>The device cannot be connected because allowed connections would be exceeded.</b>	Are ten handheld devices connected simultaneously?	Cancel a connection to a portable device that is not being used, or set the machine's auto disconnect time to break portable device connections.	<a href="#">page 8-40</a>

Message	Checkpoints	Corrective Actions	Reference Page
<b>The password does not meet password policy.</b>	Is the password expired?	Change the login password. The job is canceled. Select <b>[End]</b> .	<a href="#">page 9-5</a>
	Is the password policy requirement (such as password length or required characters) changed?	Confirm the password policy requirements and change the login password. The job is canceled. Select <b>[End]</b> .	<a href="#">page 9-5</a>
<b>The phone receiver is off the hook.</b>	—	Put down the receiver.	—
<b>The slit glass requires cleaning.</b>	—	Clean the slit glass using the cleaning cloth supplied with the document processor.	<a href="#">page 10-3</a>
<b>The toner container is improperly installed.</b>	—	The toner container is improperly installed or not installed. Open the front cover and set the toner container correctly.	<a href="#">page 10-7</a>
<b>The USB Drive is not formatted.</b>	Is the USB drive formatted by this machine?	Perform <b>[Format]</b> on this machine.	—
<b>This ID card is already registered to another user.</b>	—	Your ID card has already been registered. Change it to another ID card.	—
<b>This user account is locked out.</b>	—	Contact administrator. The job is canceled. Select <b>[End]</b> .	—
<b>Time for maintenance soon. #####</b>	—	Call service.	—
<b>Toner is empty.</b>	—	Replace the toner container to our specified toner container.	<a href="#">page 10-6</a>
<b>Toner is low. (Replace when empty.)</b>	—	It is almost time to replace the toner container. Obtain a new toner container.	—
<b>Toner type mismatch.</b>	Does the type of toner you have match the model?	Please install correct toner.	—
<b>Tray # is full of paper.</b>	Is the acceptable storage capacity exceeded?	Remove the paper. Printing then resumes.	—
	Is the paper curled?	Replace the paper with new paper.	<a href="#">page 3-2</a>

**U**

Message	Checkpoints	Corrective Actions	Reference Page
<b>USB Drive error.*<sup>1</sup></b>	Is writing to a USB drive prohibited?	An error occurred in the USB drive. The job stopped. Select <b>[End]</b> . The error cord is as follows. 01: Connect a USB drive that can be written to.	—
	—	An error occurred in the USB drive. The job stopped. Select <b>[End]</b> . The error cord is as follows. 01: The amount of data that can be saved at once has been exceeded. Restart the system or turn the power OFF/ON. If the error still occurs, the USB drive is not compatible with the machine. Use the USB drive formatted by this machine. If the USB drive cannot be formatted, it is damaged. Connect a compatible USB drive.	<a href="#">page 5-57</a>
<b>USB Drive is full.*<sup>1</sup></b>	—	The job is canceled. Select <b>[End]</b> . Insufficient free space in the USB drive. Delete unneeded files.	—

\*1 When Auto Error Clear is set to **[On]**, processing resumes automatically after a set amount of time elapses.

➔ [Auto Error Clear \(page 8-20\)](#)





**W**

Message	Checkpoints	Corrective Actions	Reference Page
<b>Warning for high temperature. Adjust the room temperature.</b>	—	Print quality may be deteriorated. Adjust the temperature and the humidity of your room.	—
<b>Warning for low temperature. Adjust the room temperature.</b>	—	Print quality may be deteriorated. Adjust the temperature and the humidity of your room.	—
<b>Warning low memory.</b>	—	Cannot start the job. Try again later.	—
<b>Waste toner box is full.</b>	Is the waste toner box full?	Replace the waste toner box.	<a href="#">page 10-11</a>

**Y**

Message	Checkpoints	Corrective Actions	Reference Page
<p><b>You cannot use this box.</b></p>	<p>—</p>	<p>You cannot use the specified box. Job is canceled. Select <b>[End]</b>.</p>	<p>—</p>

## Responding to Send Error

Error Code	Message	Corrective Actions	Reference Page
1101	Failed to send the e-mail.	Check the host name of the SMTP server on the Command Center RX.	<a href="#">page 2-75</a>
	Failed to send via FTP.	Check the host name of FTP.	<a href="#">page 5-18</a>
	Failed to send via SMB.	Check the host name of SMB.	<a href="#">page 5-18</a>
1102	Failed to send via SMB.	Check the SMB settings. <ul style="list-style-type: none"> <li>Login user name and login password</li> </ul>  <b>NOTE</b> If the sender is a domain user, specify the domain name. <ul style="list-style-type: none"> <li>Host name</li> <li>Path</li> </ul>	<a href="#">page 5-18</a>
	Failed to send the e-mail.	Check the following on the Command Center RX. <ul style="list-style-type: none"> <li>SMTP login user name and login password</li> <li>POP3 login user name and login password</li> <li>E-mail size limit</li> </ul>	<a href="#">page 2-75</a>
	Failed to send via FTP.	Check the FTP settings. <ul style="list-style-type: none"> <li>Login user name and login password</li> </ul>  <b>NOTE</b> If the sender is a domain user, specify the domain name. <ul style="list-style-type: none"> <li>Path</li> <li>Folder share permissions of the recipient</li> </ul>	<a href="#">page 5-18</a>
1103	Failed to send via SMB.	Check the SMB settings. <ul style="list-style-type: none"> <li>Login user name and login password</li> </ul>  <b>NOTE</b> If the sender is a domain user, specify the domain name. <ul style="list-style-type: none"> <li>Path</li> <li>Folder share permissions of the recipient</li> </ul>	<a href="#">page 5-18</a>
	Failed to send via FTP.	Check the FTP settings. <ul style="list-style-type: none"> <li>Path</li> <li>Folder share permissions of the recipient</li> </ul>	<a href="#">page 5-18</a>
1104	Failed to send the e-mail.	Check the e-mail address.  <b>NOTE</b> If the address is rejected by the domain, you cannot send the email.	<a href="#">page 5-18</a>

Error Code	Message	Corrective Actions	Reference Page
1105	Failed to send via SMB.	Check the following settings. [Home] key > [...] > [System Menu] > [Network Settings] > " Network Settings" [Protocol Settings] > [SMB Client (Send)]	<a href="#">page 8-46</a>
	Failed to send the e-mail.	Select [On] of the SMTP settings on the Command Center RX.	<a href="#">page 2-75</a>
	Failed to send via FTP.	Check the following settings. [Home] key > [...] > [System Menu] > [Network Settings] > " Network Settings" [Protocol Settings] > [FTP Client (Send)]	<a href="#">page 8-46</a>
1106	Failed to send the e-mail.	Check the sender address of SMTP on the Command Center RX.	<a href="#">page 2-75</a>
1131	Failed to send via FTP.	Enable the SSL. [Home] key > [...] > [System Menu] > [Network Settings] > " Network Settings" [Protocol Settings] > [FTP Client (Send)]	<a href="#">page 8-46</a>
1132	Failed to send the e-mail.	Check the following of the SMTP server. <ul style="list-style-type: none"> <li>• Is SMTP over SSL available?</li> <li>• Is the encryption available?</li> </ul>	Refer to the <b>Command Center RX User Guide.</b>
	Failed to send via FTP.	Check the following of the FTP server. <ul style="list-style-type: none"> <li>• Is FTPS available?</li> <li>• Is the encryption available?</li> </ul>	—
1133	Job is canceled. Press [End].	Server certificate has expired. Check the network and FTP settings. <ul style="list-style-type: none"> <li>• Check time/date setting of the machine.</li> <li>• Make sure server is using a valid certificate.</li> </ul>	—
1134	Job is canceled. Press [End].	Check the network and Command Center RX. <ul style="list-style-type: none"> <li>• Network Settings : Protocol, FTP Client(Transimssion):Hash</li> </ul>	—



Error Code	Message	Corrective Actions	Reference Page
2101	Failed to send via SMB.	Check the network and SMB settings. <ul style="list-style-type: none"> <li>• The network cable is connected.</li> <li>• The hub is not operating properly.</li> <li>• The server is not operating properly.</li> <li>• Host name and IP address</li> <li>• Port number</li> </ul>	—
	Failed to send via FTP.	Check the network and FTP settings. <ul style="list-style-type: none"> <li>• The network cable is connected.</li> <li>• The hub is not operating properly.</li> <li>• The server is not operating properly.</li> <li>• Host name and IP address</li> <li>• Port number</li> </ul>	—
	Failed to send the e-mail.	Check the network and Command Center RX. <ul style="list-style-type: none"> <li>• The network cable is connected.</li> <li>• The hub is not operating properly.</li> <li>• The server is not operating properly.</li> <li>• POP3 server name of the POP3 user</li> <li>• SMTP server name</li> </ul>	<a href="#">page 2-75</a>
2102 2103	Failed to send via FTP.	Check the network. <ul style="list-style-type: none"> <li>• The network cable is connected.</li> <li>• The hub is not operating properly.</li> <li>• The server is not operating properly.</li> </ul>	—
		Check the following of the FTP server. <ul style="list-style-type: none"> <li>• Is FTP available?</li> <li>• The server is not operating properly.</li> </ul>	—
	Failed to send the e-mail.	Check the network. <ul style="list-style-type: none"> <li>• The network cable is connected.</li> <li>• The hub is not operating properly.</li> <li>• The server is not operating properly.</li> </ul>	—
2201 2202 2203 2231	Failed to send the e-mail. Failed to send via FTP. Failed to send via SMB.	Check the network. <ul style="list-style-type: none"> <li>• The network cable is connected.</li> <li>• The hub is not operating properly.</li> <li>• The server is not operating properly.</li> </ul>	—
2204	Failed to send the e-mail.	Check the e-mail size limit of the SMTP settings on the Command Center RX.	<a href="#">page 2-75</a>
3101	Failed to send the e-mail.	Check the authentication methods of both the sender and the recipient.	—
	Failed to send via FTP.	Check the network. <ul style="list-style-type: none"> <li>• The network cable is connected.</li> <li>• The hub is not operating properly.</li> <li>• The server is not operating properly.</li> </ul>	—
3201	Failed to send the e-mail.	Check the SMTP user authentication method of the recipient.	—

Error Code	Message	Corrective Actions	Reference Page
4802	Failed to send the email. Check the encryption certificate of each destination by the Command Center RX. Job is canceled. Press <b>[End]</b> .	Turn the power switch off and back on. If this error occurs several times, make a note of the displayed error code and contact your service representative.	—
4803	Job is canceled. Press <b>[End]</b> .	Server certificate has expired. Check the network and SMTP settings. <ul style="list-style-type: none"> <li>• Check time/date setting of the machine.</li> <li>• Make sure server is using a valid certificate.</li> </ul>	—
Other Error Code	—	Turn the main power switch off and back on. If this error occurs several times, make a note of the displayed error code and contact your service representative.	<a href="#">page 2-11</a>

# Adjustment/Maintenance

## Overview of Adjustment/Maintenance

If there is an image problem and the message to run adjustment or maintenance menu appears, run Adjustment/Maintenance in the system menu.

The table below lists the item you can carry out.

Item	Description	Reference Page
<b>Drum Refresh 1</b>	Remove image blur from the printout.	<a href="#">page 10-40</a>
<b>Drum Refresh 2</b>	Remove white spots from the printout.	<a href="#">page 10-41</a>

## Drum Refresh

Remove image blur from the printout.



### NOTE

Drum Refresh 1 cannot be performed while printing. Execute Drum Refresh after the printing is done.

- 1 Display the screen.**  
[Home] key > [...] > [System Menu] > [Adjustment/Maintenance]
- 2 Perform the drum refresh.**  
"Image Adjustment" > [Drum Refresh] > [Execute]  
"Drum Refresh 1" begins.

## Drum Refresh 2

Remove white dots from the printout.

### NOTE

Drum Refresh 2 cannot be performed while printing. Execute Drum Refresh after the printing is done.

### 1 Load paper.

Load A4 or Letter size paper into the Multipurpose tray.

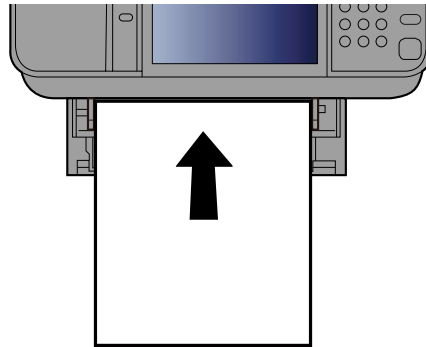

### 2 Display the screen.

[Home] key > [...] > [System Menu] > [Adjustment/Maintenance] > [Image Adjustment]

### 3 Perform the drum refresh.

"Image Adjustment" > [Drum Refresh 2] > [Execute]

"Drum Refresh 2" begins..

### NOTE

When you run [Drum Refresh 2], the machine sometimes makes a vibrating sound for about 80 seconds until drum refreshing is completed. The toner soiling on the ejected paper is normal and does not indicate a fault.

# Clearing Paper Jams

If a paper jam occurs, the touch panel will display " Paper Jam." and the machine will stop.

## Jam Location Indicators

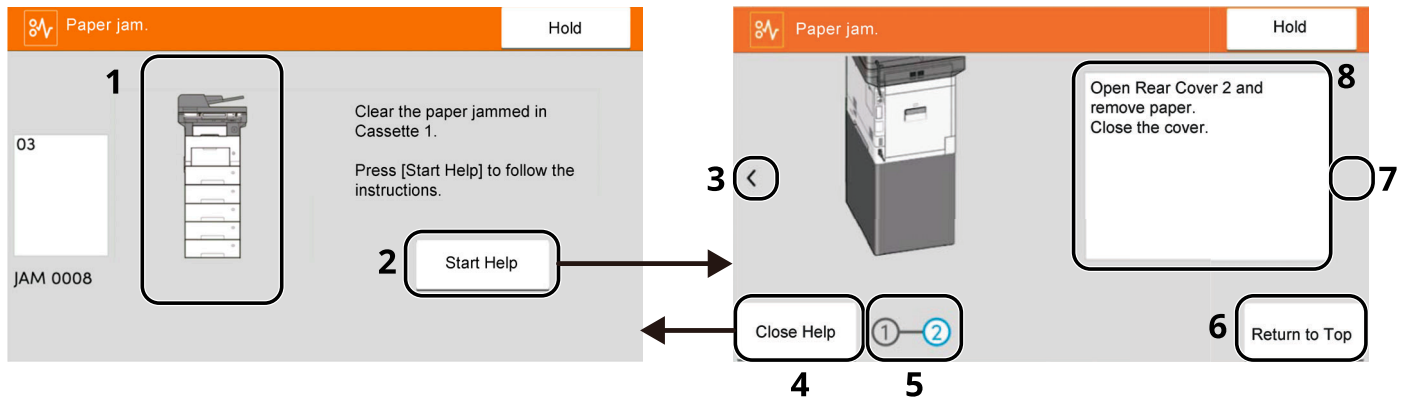

- 1 Shows the location of a paper jam.
- 2 Shows the Help screen. The Help screen shows the procedure to clear the jam.
- 3 Returns to the previous step.
- 4 Closes the Help screen and returns to the original screen.
- 5 Shows the selected step.
- 6 Returns to step 1.
- 7 Advances to the next step.
- 8 Shows the removal procedure.

If a paper jam occurs, the location of the jam will be displayed on the touch panel as well as the clearing instructions.

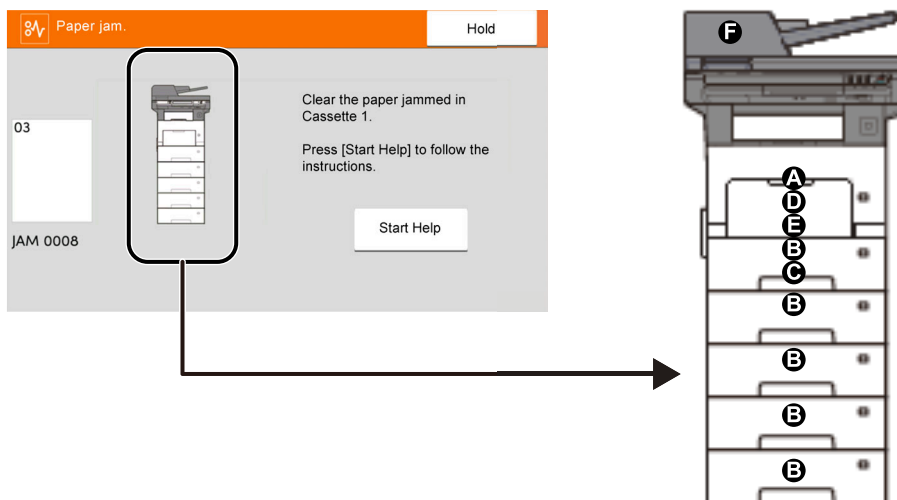

Paper Jam Location Indicator	Paper Jam Location	Reference Page
<b>A</b>	Multi Purpose Tray	<a href="#">page 10-44</a>
<b>B</b>	Cassettes 1 to 5	<a href="#">page 10-45</a>
<b>C</b>	Duplex Unit	<a href="#">page 10-46</a>
<b>D</b>	Inside the Machine	<a href="#">page 10-47</a>
<b>E</b>	Inner Tray / Inside Rear Cover	<a href="#">page 10-49</a>
<b>F</b>	Document Processor	<a href="#">page 10-51</a>

After you remove the jam, the machine will warm up again and the error message will be cleared. The machine resumes with the page that was printing when the jam occurred.

## Precautions with Paper Jams

- Do not reuse jammed papers.
- If the paper tears during removal, be sure to remove any loose scraps of paper from inside the machine. Scraps of paper left in the machine could cause subsequent jamming.



### CAUTION

The fixing unit is extremely hot. Take sufficient care when working in this area, as there is a danger of getting burned.

## Remove any jammed paper in the Multipurpose Tray

1

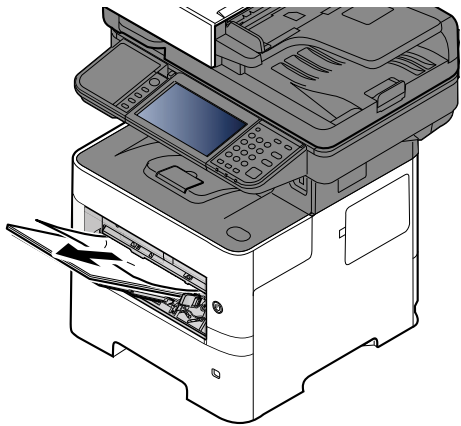

2

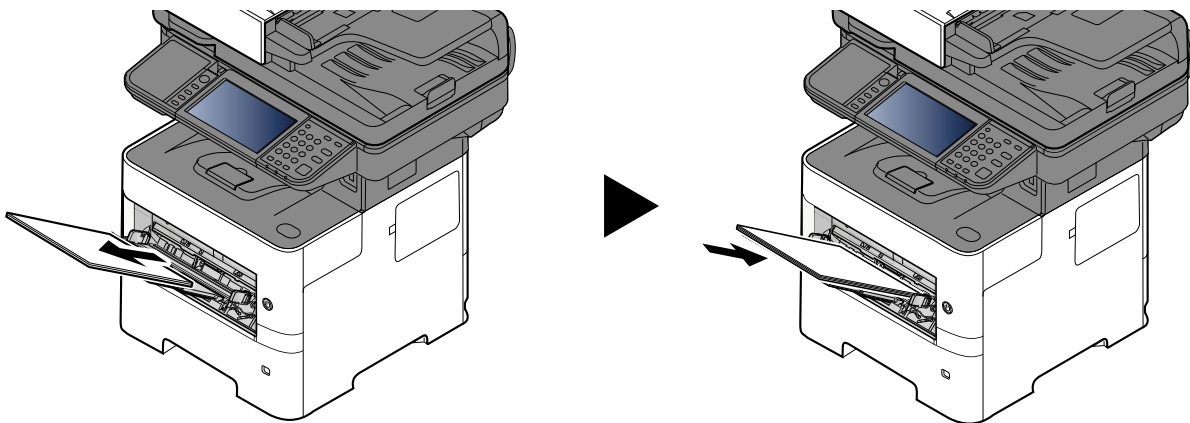

## Remove any jammed paper in Cassette 1 - Cassette 5

Procedures for handling a paper jam in Cassettes 1 to 5 are all the same. This section explains procedures using Cassette 1 as an example.

1

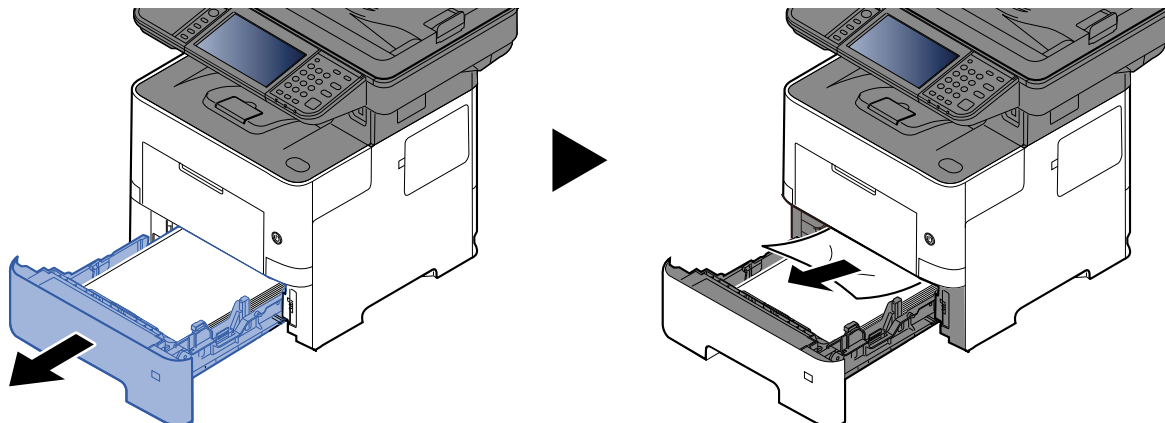

2

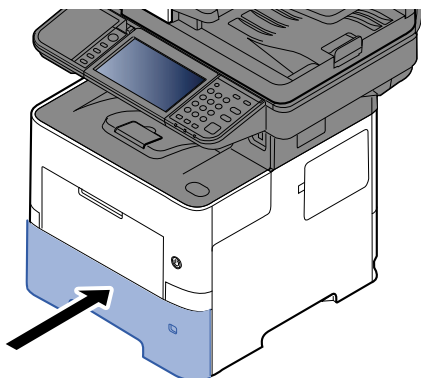



## Remove any jammed paper in Duplex Unit

1

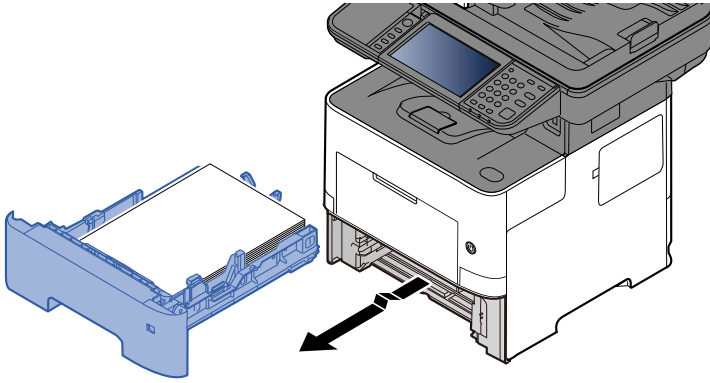

2

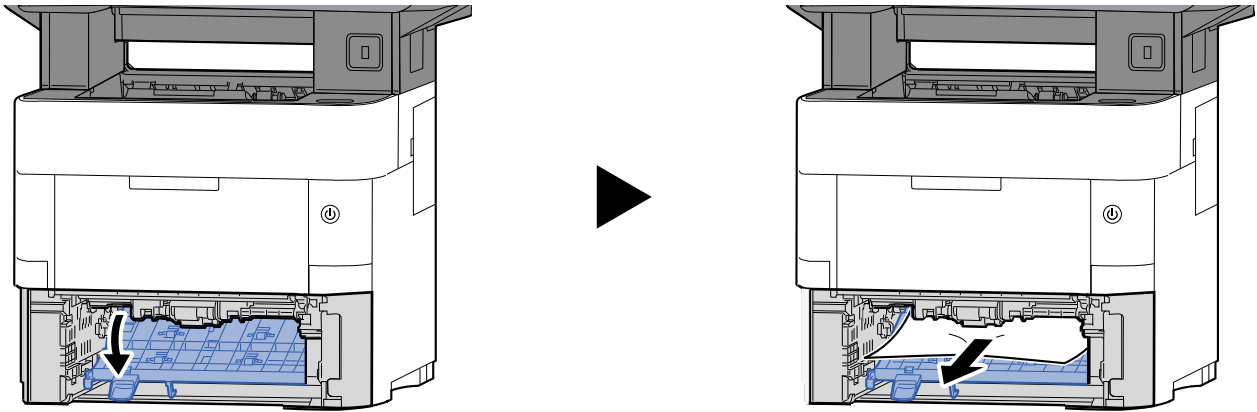

3

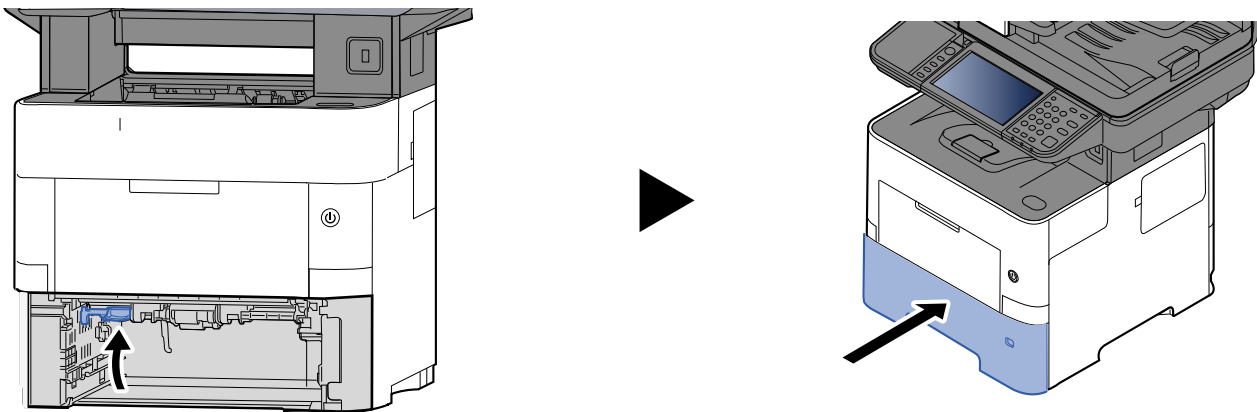

## Remove any jammed paper Inside the Machine

1

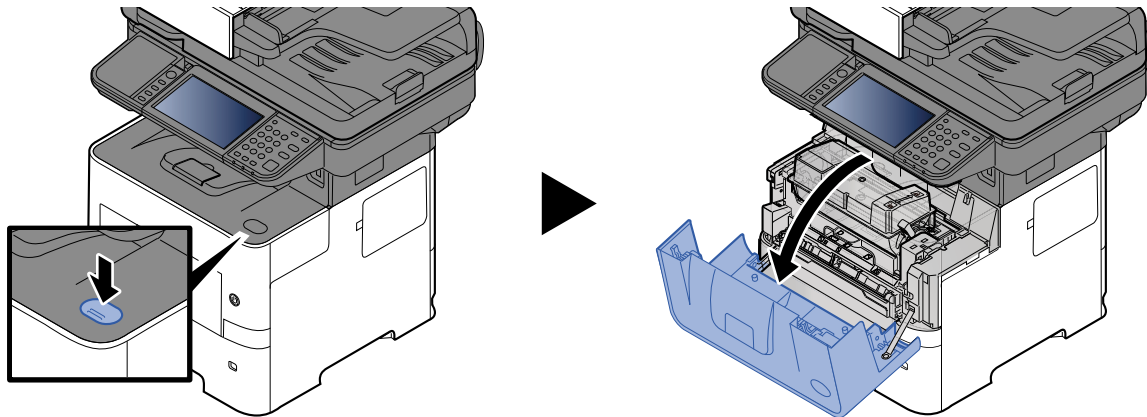

2

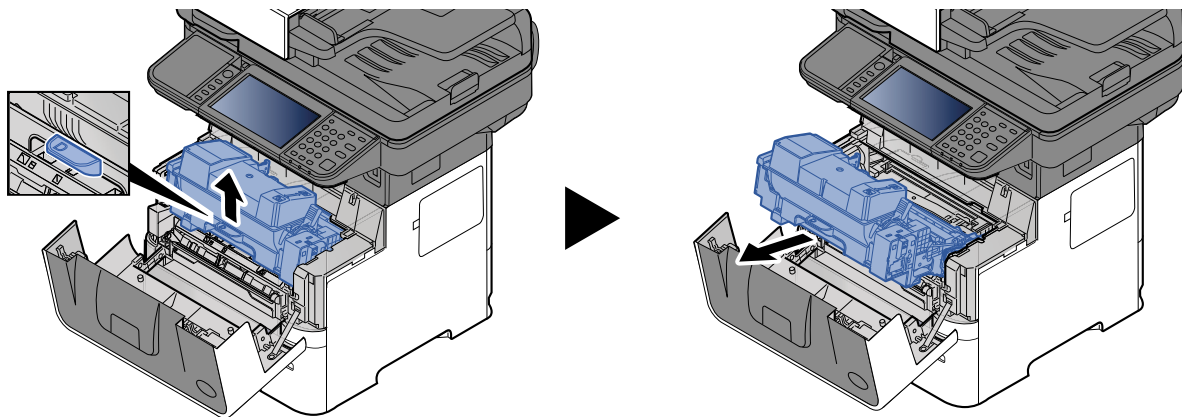

3

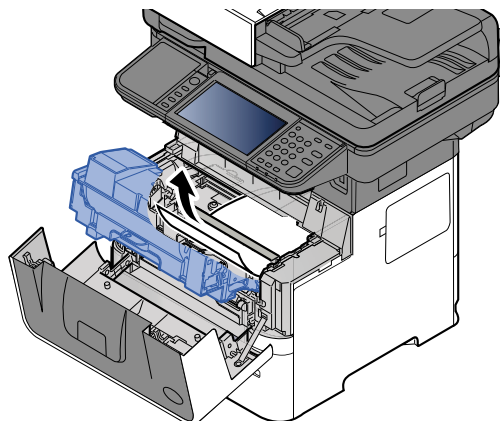

If the jammed paper appears to be pinched by rollers, pull it along the normal running direction of the paper.

If you cannot find a paper jam, try checking inside the rear of the printer.

➔ [Remove any jammed paper in Inner Tray / Inside Rear Cover \(page 10-49\)](#)

4

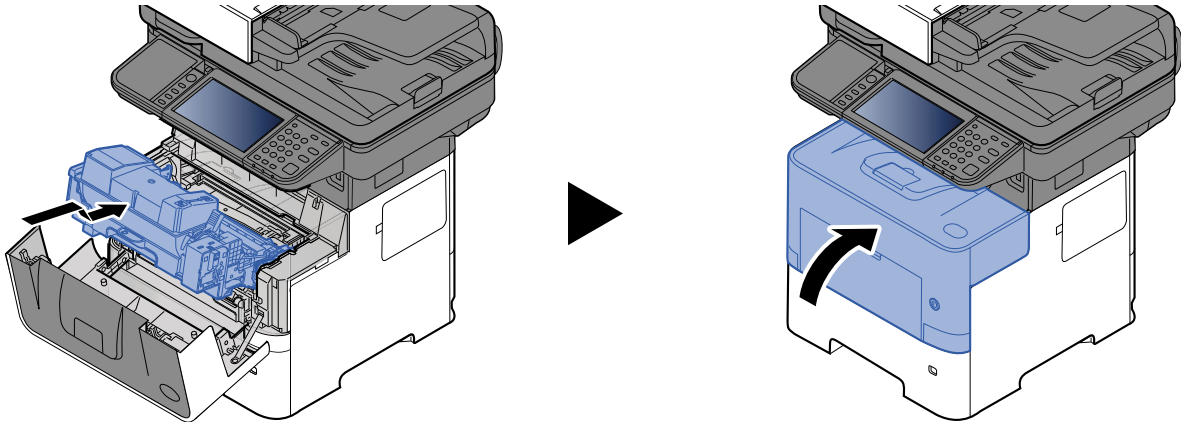

## Remove any jammed paper in Inner Tray / Inside Rear Cover

1

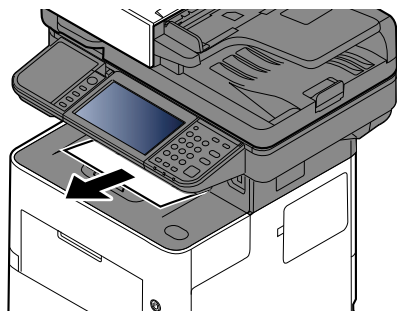

2

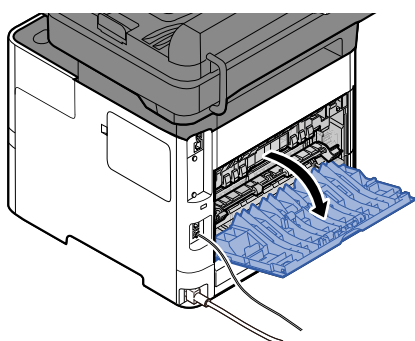

3

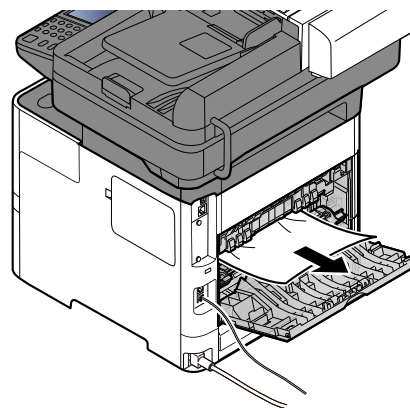
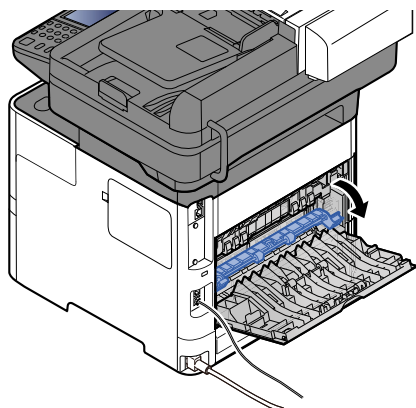

If you cannot find a paper jam, try checking inside the rear of the machine.



### CAUTION

The fixing unit is extremely hot. Take sufficient care when working in this area, as there is a danger of getting burned.

4

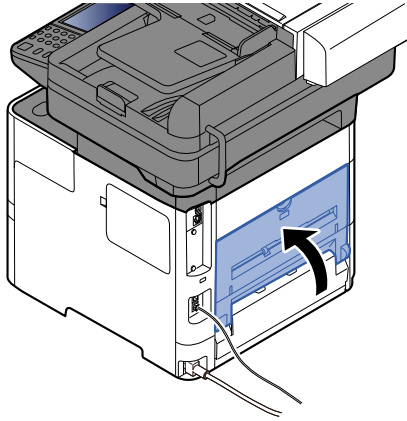

## Remove any jammed paper in Document Processor

ECOSYS MA6000ifx/ECOSYS MA5500ifx

1

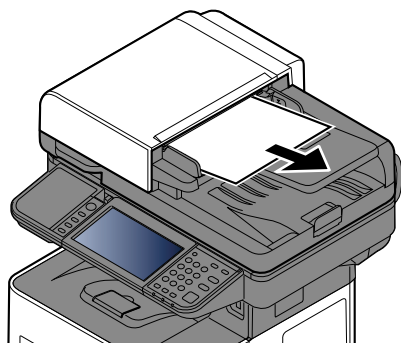

2

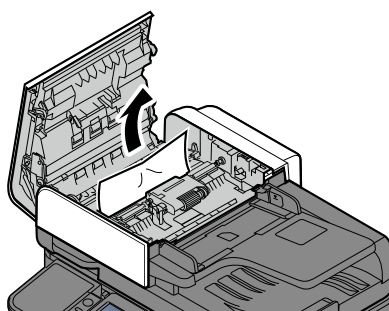
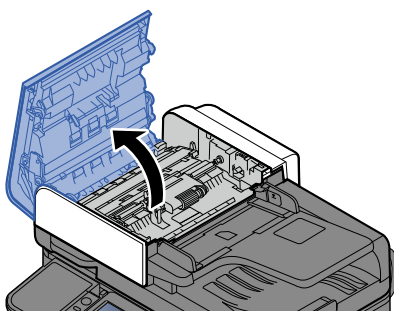

3

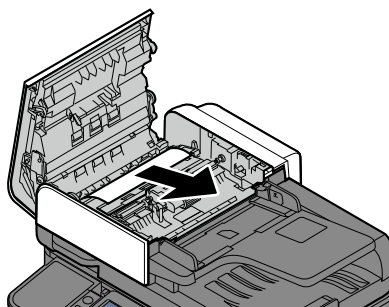
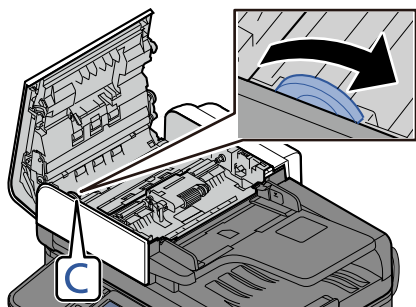

4

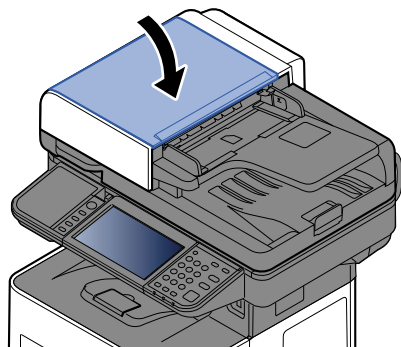

ECOSYS MA4500ifx/ECOSYS MA4500ix

1

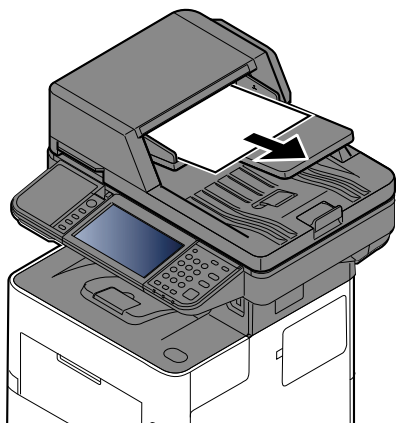

2

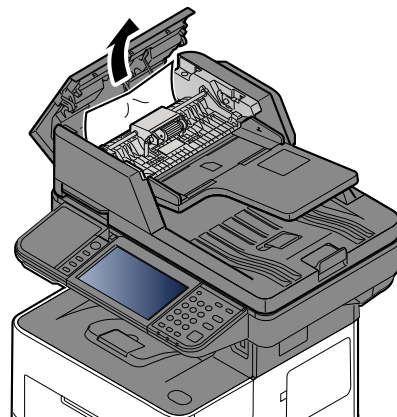
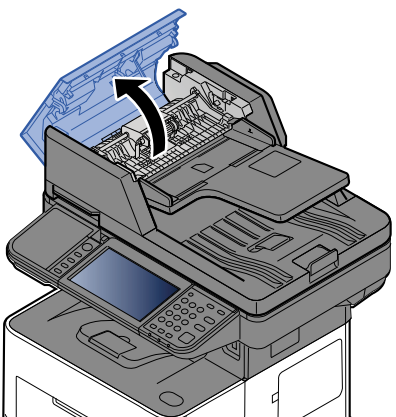

3

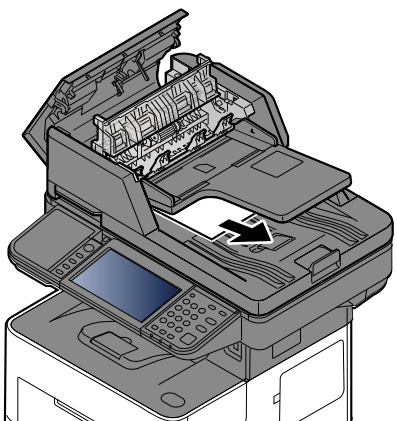
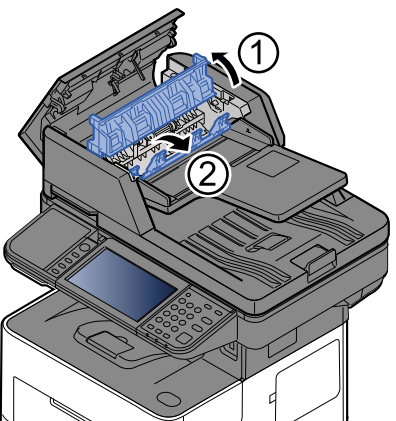

4

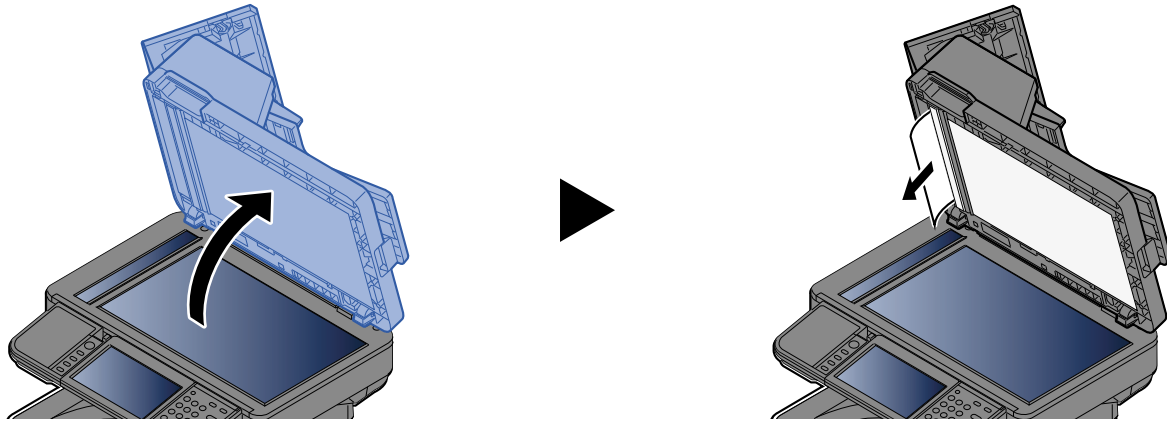

5

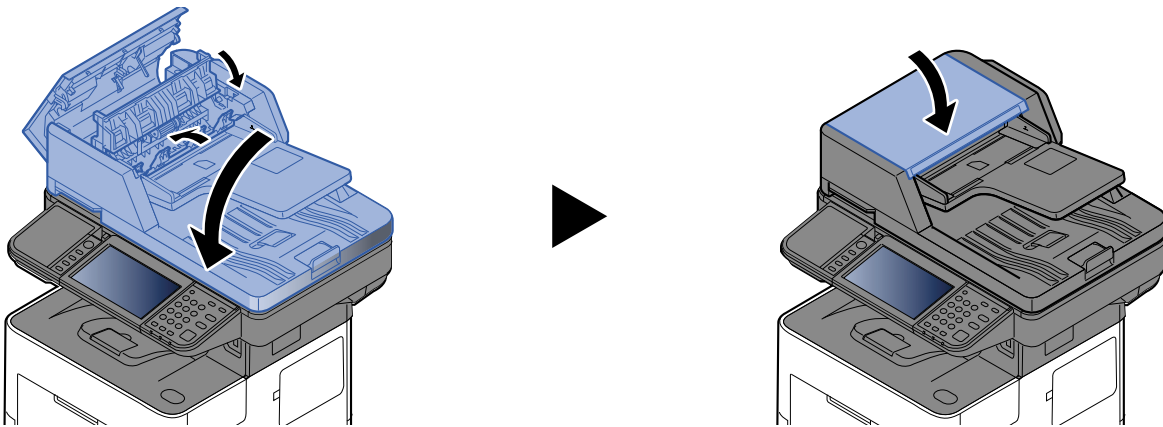



## Clearing a Staple Jam (ECOSYS MA6000ifx/ECOSYS MA5500ifx only)

1

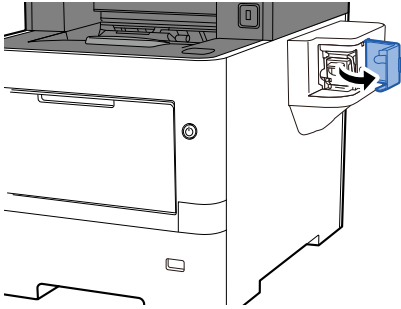

2

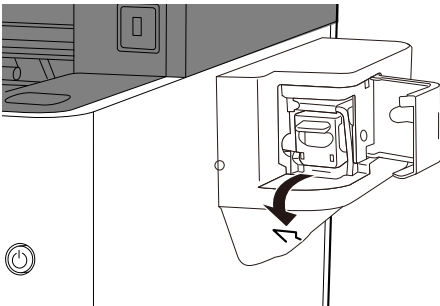

3

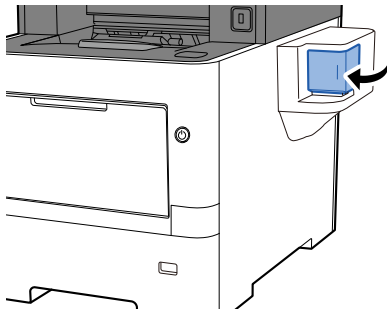

# 11 Appendix

This chapter explains the following topics:

Optional Equipment .....	11-2	Interface Block Setting .....	11-39
Overview of Optional Equipment .....	11-2	Energy Saver/Timer .....	11-39
Optional Applications .....	11-8	Authentication Security Settings .....	11-39
Character Entry Method .....	11-10	Job Status/Job History Settings .....	11-39
Entry Screens .....	11-10	Edit Restriction .....	11-40
Entering Characters .....	11-12	Prevent Mis-sending Settings .....	11-40
Paper .....	11-13	History Settings .....	11-41
Basic Paper Specifications .....	11-13	Glossary .....	11-42
Choosing the Appropriate Paper .....	11-14		
Special Paper .....	11-17		
Specifications .....	11-21		
Machine .....	11-21		
Copy Functions .....	11-23		
Printer Functions .....	11-24		
Scanner Functions .....	11-25		
Document Processor .....	11-26		
Paper Feeder (500-sheet) (Option) .....	11-26		
Manual Stapler (ECOSYS MA6000ifx/ ECOSYS MA5500ifx only) .....	11-27		
Back up Data .....	11-28		
Data backup using KYOCERA Net Viewer ...	11-28		
Data backup using Command Center RX ...	11-28		
Back up Data Using USB Drive .....	11-29		
Functions List of Security Quick Setup .....	11-30		
TLS .....	11-30		
Settings for Server Function .....	11-30		
Settings for Client Function .....	11-31		
IPv4 Settings (Wired Network) .....	11-31		
IPv4 Settings (Wireless Network) .....	11-31		
IPv6 Settings (Wired Network) .....	11-32		
IPv6 Settings (Wireless Network) .....	11-33		
Transmission protocol: FTP Client (Transmission) .....	11-33		
Other Protocols: HTTP (Client) .....	11-33		
Other Protocols: SOAP .....	11-34		
Other Protocols: LDAP .....	11-34		
Transmission Protocols: SMTP (Sending Emails) .....	11-34		
Email: POP3 User Settings .....	11-35		
Print protocols .....	11-35		
Transmission Protocol .....	11-36		
Other Protocols .....	11-37		
TCP/IP: Bonjour Settings .....	11-38		
Network Settings .....	11-38		
Connectivity .....	11-38		

# Optional Equipment

## Overview of Optional Equipment

The following optional equipment is available for the machine.

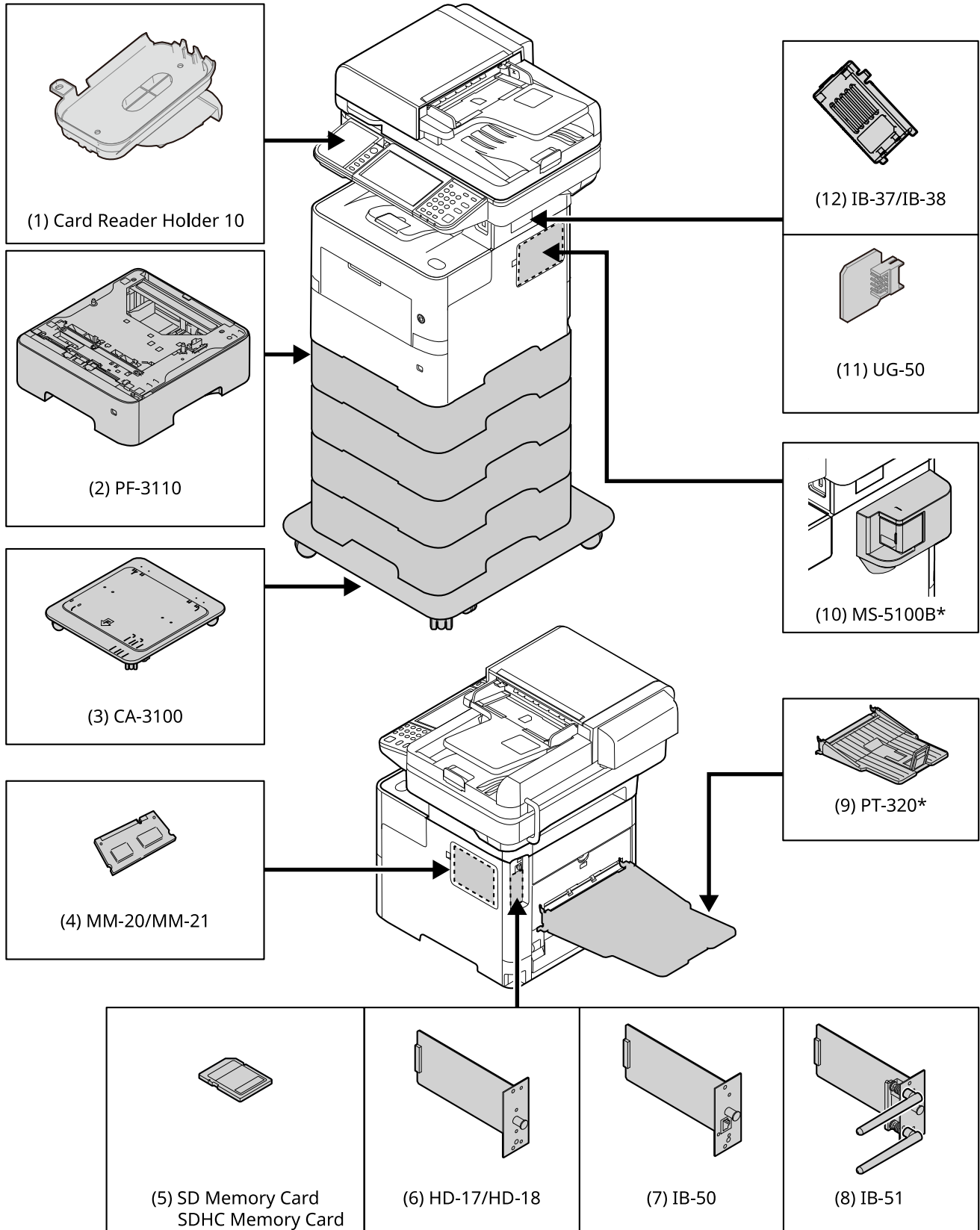

\* ECOSYS MA6000ifx/ECOSYS MA5500ifx Only

### (1) Card Reader Holder 10 "Card Reader Holder"

Please use it when installing an Card reader.

### (2) PF-3110 "Paper Feeder (500-sheet x1)"

Up to four additional cassettes identical to the machine's cassettes can be installed in the machine. Loading method are the same as the standard cassettes.

➔ [Loading in the Cassettes \(page 3-4\)](#)

### (3) CA-3100 "Castor kit"

If you are attaching Paper Feeder (500-sheet x1) to the printer and installing it on the floor, you can use the castor kit to maintain the machine's stability.

### (4) MM-20/MM-21 "Expansion Memory"

The machine can perform the more multiple jobs simultaneously by adding more memories. You can increase the machine's memory up to 3,072 MB by plugging in the optional memory modules.

#### Precautions for Handling the Memory Modules

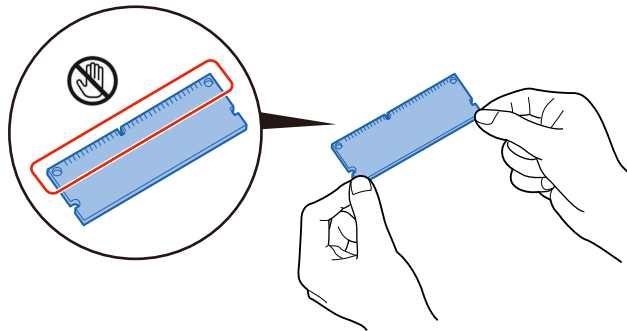

To protect electronic parts, discharge static electricity from your body by touching a water pipe (faucet) or other large metal object before handling the memory modules. Or, wear an antistatic wrist strap, if possible, when you install the memory modules.

#### Installing the Memory Modules

- 1 Turn off the machine and disconnect the power cord and interface cable.



#### NOTE

If the optional IB-50/51 or HD-17/HD-18 is installed, remove it.

- 2 Remove the covers.

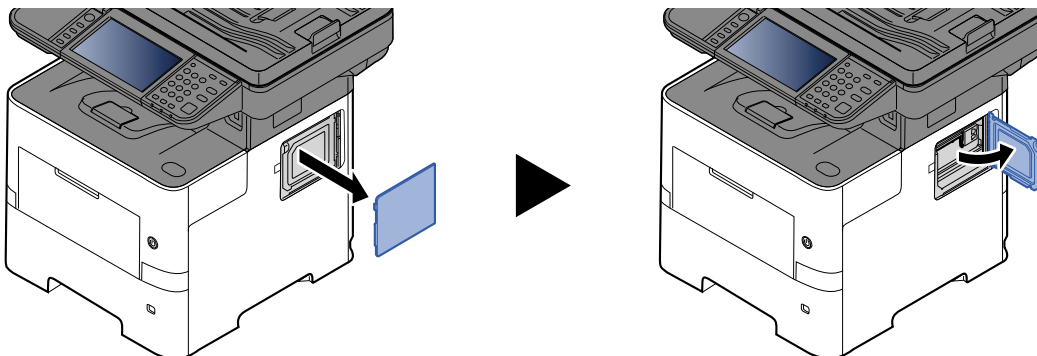

- 3 Remove the memory module from its package.

- 4 With the memory connection terminal pointing toward the socket, align the cut-out part with the socket terminal and insert directly in at an angle.

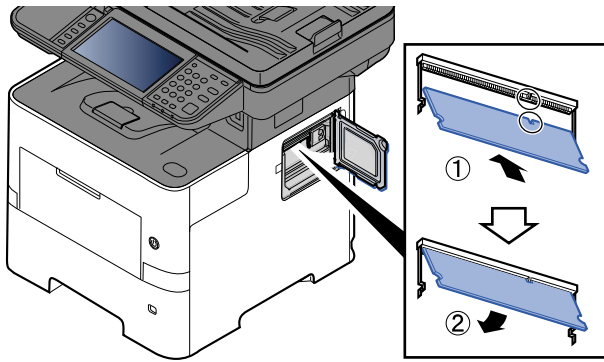

- 5 Carefully press the inserted memory down and into the machine.
- 6 Reinstall the covers.

### Removing the Memory Module

To remove a memory module, remove the right cover and the memory slot cover from the machine. Then, carefully push out the two socket clamps. Ease the memory module out of the socket to remove.

### Verifying the Expanded Memory

To verify that the memory module is working properly, test it by printing a status page.

➔ [Notification/Report \(page 8-21\)](#)

## (5) "SD/SDHC Memory Card"

An SD/SDHC memory card is useful for storing fonts, macros, and overlays. The machine is equipped with a slot for an SDHC memory card with a maximum size of 32 GB, and an SD memory card with a maximum size of 2 GB.

### Reading the SD/SDHC Memory Card

Once inserted in the machine's slot, the contents of the SD/SDHC memory card can be read from the operation panel or automatically when you power on or reset the machine.

### Installing and Formatting the SD/SDHC Memory Card

To use an unused SD/SDHC memory card, you must first use the machine to format the SD/SDHC memory card. For information on formatting an SD/SDHC memory card, consult your Service Representative.

- 1 Power off the machine and unplug the power cord.

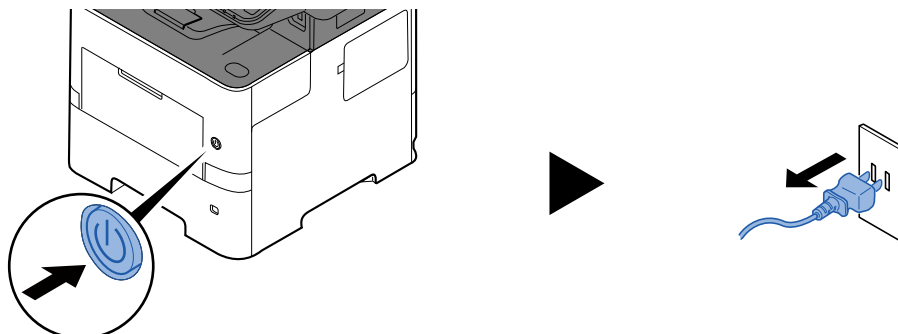

- 2 Remove the cover.

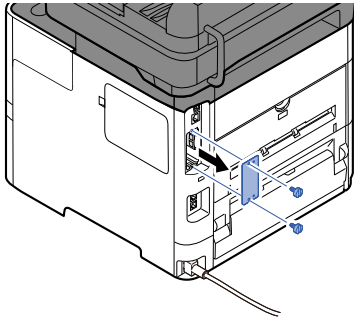

- 3 Insert the SD/SDHC memory card into the SD/SDHC memory card slot.

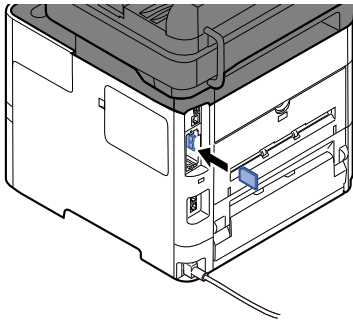

- 4 Replace the covers.

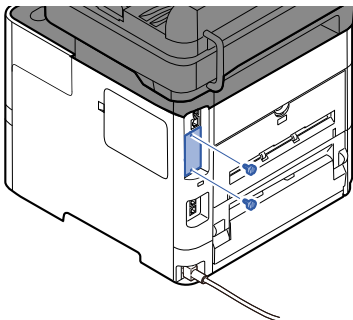

- 5 Insert the power cord into the socket and turn on the power switch.

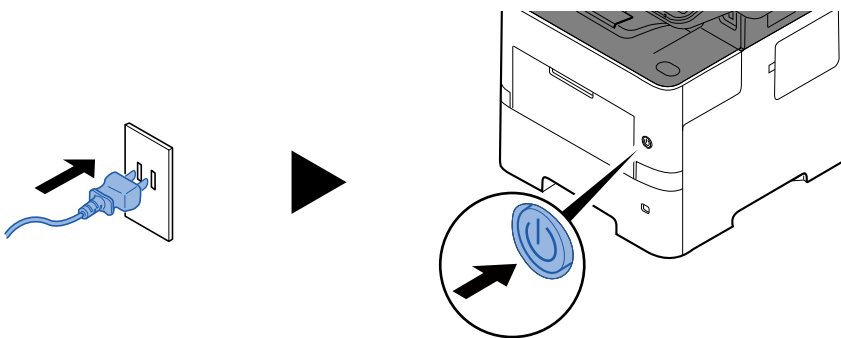

## (6) HD-17/HD-18 "SSD"

With SSD installed in the machine, received data can be rasterized and stored on this SSD. This enables high-speed printing of multiple copies using an electric sort function. Also, you can use the Document Box functions.

- ➔ [Using Document Boxes \(page 5-43\)](#)

The security function can be used by installing the SSD.

- ➔ [Data Security \(page 8-58\)](#)

- ➔ **Data Encryption/Overwrite OPERATION GUIDE**

## (7) IB-50 "Network Interface Kit"

The Network Interface Kit provides a high-speed connection for the Gigabit-per-second interface. Settings are possible for a variety of OS and network protocols.

### ➔ IB-50 User's Manual

The security function can be used by installing the SSD.

### ➔ [Data Security \(page 8-58\)](#)

### ➔ Data Encryption/Overwrite OPERATION GUIDE

## (8) IB-51 "Wireless Network Interface Kit"

This is a wireless LAN interface card which supports the wireless LAN specifications IEEE802.11n (Max 300 Mbps) and 11 g/b.

With the utilities supplied, settings are possible for a variety of OS and network protocols.

### ➔ IB-51 User's Manual

## (9) PT-320 "Rear Tray" (ECOSYS MA6000ifx/ECOSYS MA5500ifx only)

Use the faceup output tray when you wish paper to be stacked with the printed side facing up (reverse order). The rear tray can only be used for printing from a PC.

### Installing the Rear Tray

- 1 Install the paper stopper according to the size of paper to be used.

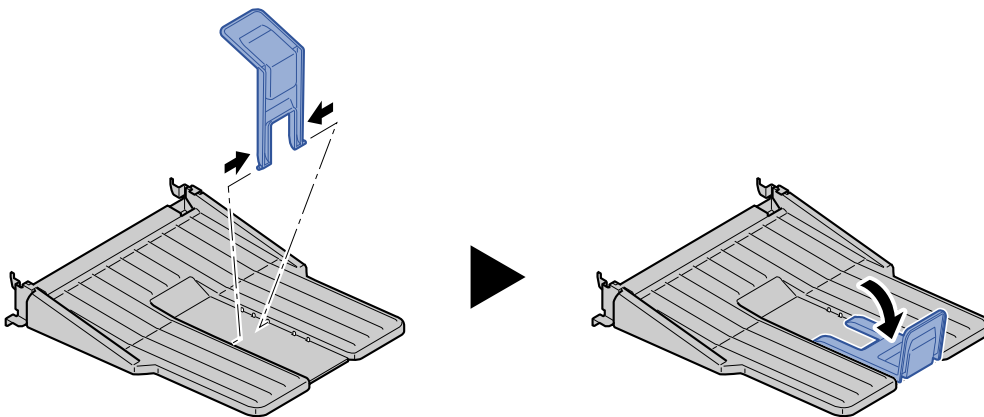

- 2 Install the rear tray on the rear of the machine.

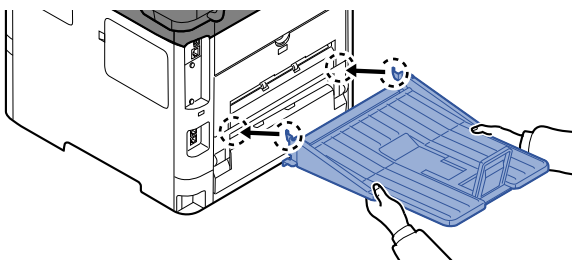

## (10) MS-5100B "Manual stapler" (ECOSYS MA6000ifx/ECOSYS MA5500ifx only)

It can staple the originals or the printouts. The number of sheets that can be stapled together is 20 sheets (80 g/m<sup>2</sup>).

### **(11) UG-50 "Trusted Platform Module"**

You can secure sensitive information with this option. The encryption key used to encrypt confidential information on this machine is stored in a dedicated storage area on the TPM chip. Since this storage area cannot be read from outside the TPM, confidential information can be safely protected. If this option is installed, it cannot be used at the same time as SSD.

### **(12) IB-37/IB-38 "Wireless Network Interface Kit"**

These are wireless LAN Interface cards which support the following wireless LAN specifications.

IB-37: IEEE802.11 a/b/g/n/ac; IB-38: IEEE802.11 b/g/n

In addition, network printing is possible without using the wireless LAN router because Wi-Fi Direct is supported.

### **(13) UG-33 "ThinPrint Option"**

This application allows print data to be printed directly without a print driver.

### **(14) Scan extension kit(A) "OCR Scan Activation Kit"**

This option enables the use of the OCR function in the applications of the machine.

To use this function, an SSD or SD/SDHC memory card must be inserted.

➔ [HD-17/HD-18 "SSD" \(page 11-5\)](#)

➔ ["SD/SDHC Memory Card" \(page 11-4\)](#)

To use this function, the application and OCR dictionary must be installed.

➔ [Optional Applications \(page 11-8\)](#)

➔ [Installation of OCR Dictionary \(page 8-60\)](#)

### **(15) USB Keyboard "USB Keyboard"**

A USB keyboard can be used to enter information into the text fields on the operation panel. A special mount is also available to install the keyboard on the machine. Please contact your dealer or service representative for information on keyboards that are compatible with your machine before you purchase one.

### **(16) Card reader**

A USB keyboard can be used to enter information into the text fields on the operation panel. A special mount is also available to install the keyboard on the machine. Please contact your dealer or service representative for information on keyboards that are compatible with your machine before you purchase one.



# Optional Applications

## Overview of the Applications

The applications listed below are installed on this machine.

Item	Application
Data Encryption/Overwrite	Data Encryption/Overwrite
CARD AUTHENTICATIONKIT(B)	Card Authentication Kit <sup>*1</sup>
UG-33	ThinPrint Option <sup>*1</sup>
Scan extension kit(A)	OCR Scan Activation Kit <sup>*1</sup>

\*1 This can be used on a trial basis for a limited time.

### NOTE

- Restrictions such as the number of times the application can be used during the trial period differ depending on the application.
- If you change the date/time while using the trial version of an application, you will no longer be able to use the application.

## Starting Application Use

Use the procedure below to start using an application.

### 1 [Home] key > [...] > [System Menu] > [Add/Delete Application] > "Optional Function"[Optional Function List]

#### NOTE

If the User Authentication screen appears, log in with a user who has the privilege to configure this setting. If you do not know your login User Name or Password, please contact your Administrator.

### 2 Select the desired application and select [Activate].

You can view detailed information on the selected application by selecting [].

### 3 Enter the license key > [Official]

Some applications do not require you to enter a license key. If the license key entry screen does not appear, go to Step 4.

To use the application as a trial, select [Trial] without entering the license key.

### 4 Select [Yes] in the confirmation screen.

#### NOTE

- If you started the Data Encryption/Overwrite or ThinPrint Option and entered the license key, turn the power OFF/ON.
- Icons of activated application are displayed in the Home screen.

## Checking Details of Application

Use the procedure below to check the details of application.

### 1 [Home] key > [...] > [System Menu] > [Add/Delete Application] > "Optional Function"[Optional Function List]



#### NOTE

If the User Authentication screen appears, log in with a user who has the privilege to configure this setting. If you do not know your login User Name or Password, please contact your Administrator.

### 2 Select the desired application and select [⋮].

You can view detailed information on the selected application.

The table below lists the item you can view.

Item
Function Name
License
Remaining Counts
Expiration Date
Status

To extend the trial period, select [**Extend**]

# Character Entry Method

To enter characters for a name, use the on-display keyboard in the touch panel following the steps as explained below.

## NOTE

### Keyboard Layout

"QWERTY", "QWERTZ" and "AZERTY" are available as keyboard layouts the same as a PC keyboard. Select the [System Menu/Counter] key, [Common Settings] and then [Keyboard Layout] to choose the desired layout. "QWERTY" layout is used here as an example. You may use another layout following the same steps.

## Entry Screens

### Lower-case Letter Entry Screen

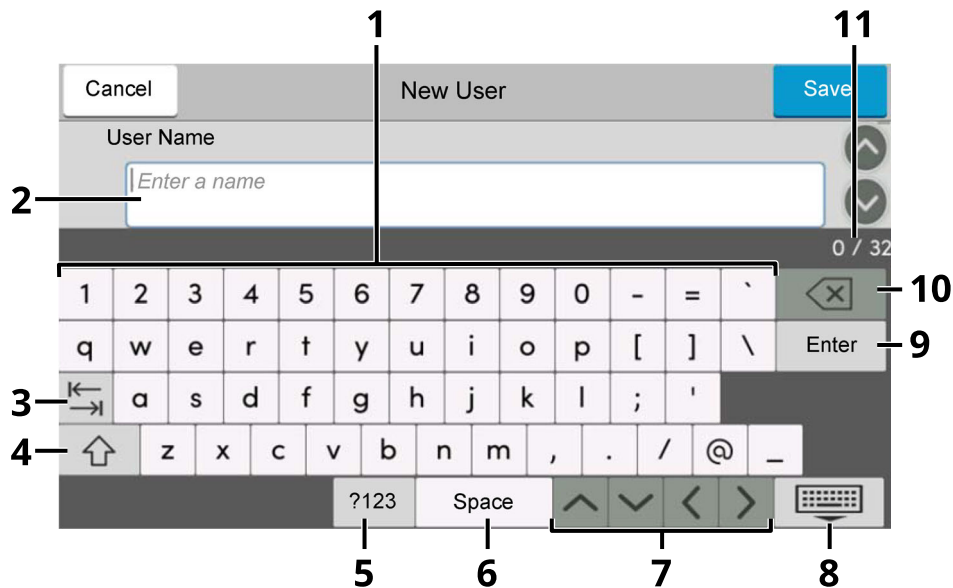

No.	Display/Key	Description
1	Keyboard	Select the character to enter.
2	Input box	Enter characters in the selected box.
3	Tab key	Select to move to the next input box.
4	Shift key	Select to switch between upper case and lower case.
5	[?123] / [Character]	Select the characters that are entered.
6	Space key	Select to insert a space.
7	Cursor key	Select to move the cursor on the display.
8	Close key	Select to close the entry screen.
9	Enter key	Select to finalize entry and return to the screen before the entry.
10	Backspace key	Select to delete a character to the left of the cursor.
11	Input / Limit display	Displays maximum number of characters and the number of characters entered.

## Upper-case Letter Entry Screen

Select the Shift key.

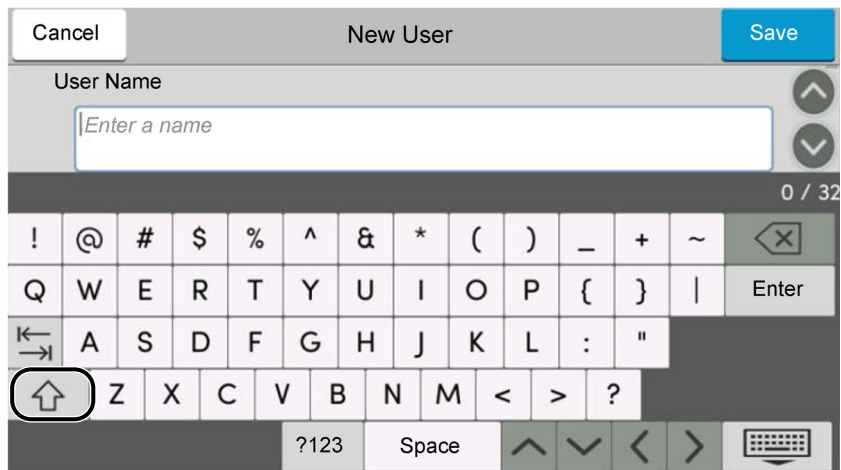

## Number/Symbol Entry Screen

Select [?123].

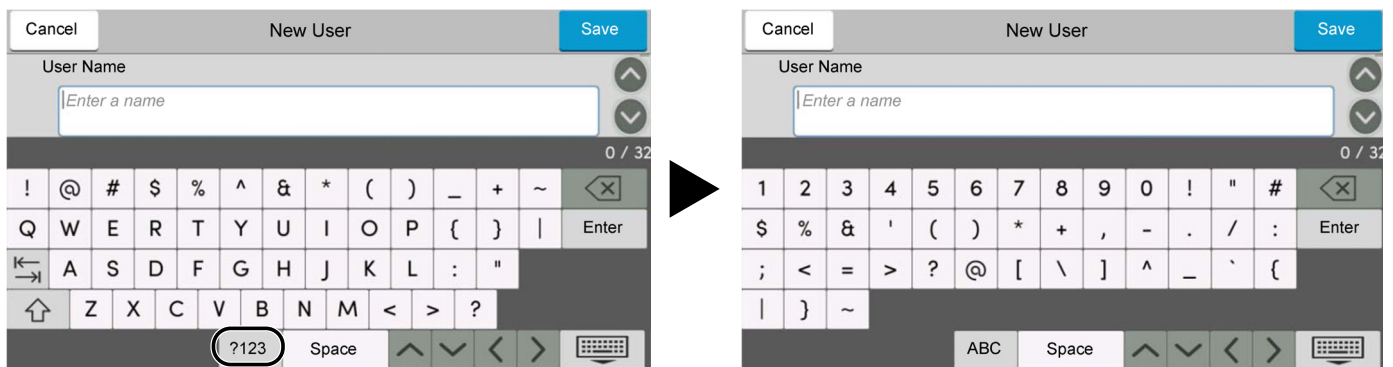

## Entering Characters

Follow the steps below to enter 'List A-1' for an example.

### 1 Enter 'List', (space).

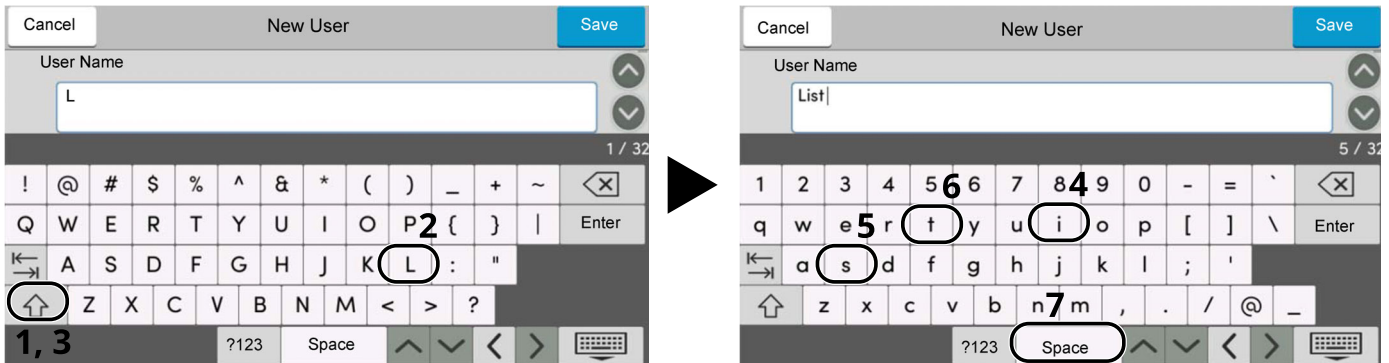

To switch between upper case and lower case, select the Shift key.

### 2 Enter '#' and '1'.

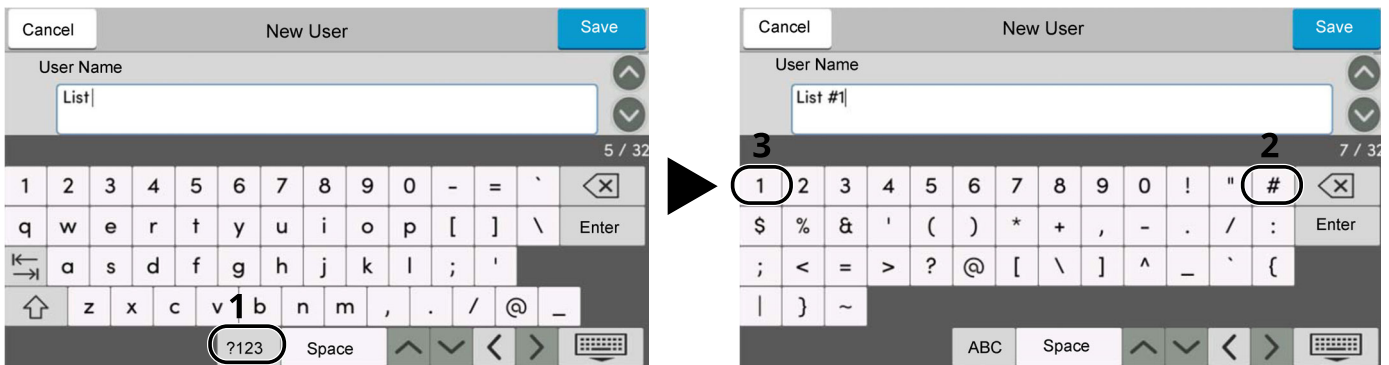

To enter numbers or symbols, select [#123].

### 3 Check that the entry is correct.

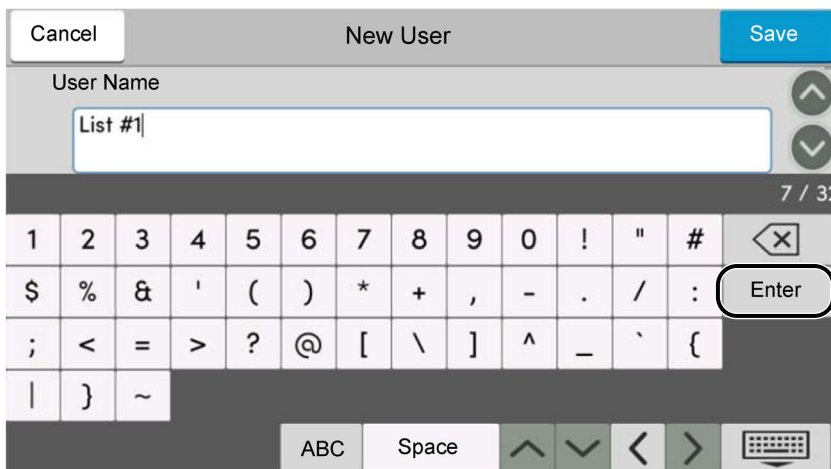

Check that the entry is correct. Select [Enter].

# Paper

This section explains the paper sizes and types that can be used in the paper source.

For details on the sizes, types, and number of sheets of paper that can be loaded in each paper tray, refer to the following:

➔ [Specifications \(page 11-21\)](#)

## Basic Paper Specifications

This machine is designed to print on standard copy paper as used in regular ('dry') copiers and page printers such as laser printers. It also supports a variety of other types of paper that conform to the specifications given in this appendix.

Be careful when choosing paper. Paper unsuitable for the machine may cause jams or may be wrinkled.

### Supported Paper

Use standard copy paper for regular copiers or laser printers. The printing quality will be affected by the quality of paper. Poor quality paper may result in unsatisfactory output.

### Basic Paper Specifications

The following table lists the specifications of paper that is supported with this machine. Refer to the subsequent sections for further details.

Criteria	Specifications
Weight	Cassettes: 60 to 120 g/m <sup>2</sup>
	Multi purpose tray: 60 to 220 g/m <sup>2</sup>
Dimensional accuracy	±0.7 mm
Squareness of corners	90° ±0.2°
Moisture content	4 to 6%
Pulp content	80% or more

#### NOTE

Some recycled paper does not meet requirements for use with this machine as listed in the Basic Paper Specifications shown below, such as moisture or pulp content. For this reason, we recommend purchasing a small amount of recycled paper as a sample for testing prior to use. Choose recycled paper that gives the best printing results and contains low levels of paper dust.

We are not responsible for the problems occurred from the use of paper that does not conform to our specifications.

## Choosing the Appropriate Paper

This section describes guidelines for choosing paper.

### Condition

Avoid using paper with bent corners or that is curled, dirty, or torn. Do not use paper that has a rough surface or paper fiber lint, or that is especially delicate. Use of paper in any of these conditions will not only deliver poor copies but may also cause jams and shorten the useful life of the machine. Choose paper with a smooth and even surface; however, avoid coated paper or paper with a treated surface as it may damage the drum or fusing unit.

### Ingredients

Do not use paper such as paper that has been coated or surface-treated or paper that contains plastic or carbon. Those types of paper may produce harmful fumes from the heat of printing and may damage the drum.

Be sure to use the standard paper that contains at least 80% pulp, i.e., not more than 20% of the total paper content consists of cotton or other fibers.

### Supported Paper Sizes

Paper of the following sizes is supported by the machine.

Measurements in the table take into account a  $\pm 0.7$  mm dimensional accuracy for length and width. Corner angles must be  $90^\circ \pm 0.2^\circ$ .

Paper Size	Cassette 1	Cassettes 2 to 5	Multi Purpose Tray
Envelope Monarch (3-7/8 × 7-1/2")	×	○	○
Envelope #10 (4-1/8 × 9-1/2")	×	○	○
Envelope DL (110 × 220 mm)	○ <sup>*1</sup>	○	○
Envelope C5 (162 × 229 mm)	○	○	○
Executive (7-1/4 × 10-1/2")	○	○	○
Letter	○	○	○
Legal	○	○	○
A4 (297 × 210 mm)	○	○	○
B5 (257 × 182 mm)	○	○	○
A5 (210 × 148 mm)	○	○	○
A6 (148 × 105 mm)	○ <sup>*1</sup>	×	○
B6 (182 × 128 mm)	○ <sup>*1</sup>	○	○
Envelope #9 (3-7/8 × 8-7/8")	×	○	○
Envelope #6 (3-5/8 × 6-1/2")	×	○	○
ISO B5 (176 × 250 mm)	○	○	○
Hagaki (Cardstock) (100 × 148 mm)	×	×	○
Oufuku hagaki (Return postcard) (148 × 200 mm)	○ <sup>*1</sup>	○	○
Oficio II	○	○	○
216 × 340 mm	○	○	○
16K (273 × 197 mm)	○	○	○

Paper Size	Cassette 1	Cassettes 2 to 5	Multi Purpose Tray
Statement	○	○	○
Folio (210 × 330 mm)	○	○	○
Nagagata 3 (120 × 235 mm)	×	○	○
Youkei 4 (105 × 235 mm)	×	○	○
Youkei 2 (114 × 162 mm)	×	○	○
Custom	Cassette 1: ECOSYS MA6000ifx/ECOSYS MA5500ifx 105 × 140 to 216 × 356 mm ECOSYS MA4500ifx/ECOSYS MA4500ix 140 × 210 to 216 × 356 mm Cassettes 2 to 5: 92 × 162 to 216 × 356 mm Multi Purpose Tray: 70 × 148 to 216 × 356 mm		

\*1 ECOSYS MA6000ifx/ECOSYS MA5500ifx only

## Smoothness

The paper surface should be smooth, but it must be uncoated. With paper that is too smooth and slippery, several sheets may accidentally be supplied at once, causing jams.

## Basis Weight

In countries that use the metric system, basis weight is the weight in grams of one sheet of paper one square meter in area. In the United States, basis weight is the weight in pounds of one ream (500 sheets) of paper cut to the standard size (or trade size) for a specific grade of paper. Paper that is too heavy or too light may be supplied incorrectly or cause paper jams, which may cause excessive wear of the machine. Mixed paper weight (i.e., thickness) may cause several sheets to be supplied at once accidentally and may also cause blurring or other printing problems if the toner fails to adhere correctly.

## Moisture Content

Paper moisture content is the ratio of moisture to dryness expressed as a percentage. Moisture affects how the paper is supplied, the electrostatic chargeability of the paper, and how the toner adheres.

Paper moisture content varies depending on the relative humidity in the room. High relative humidity causes paper to become damp, making the edges expand so it appears wavy. Low relative humidity causes paper to lose moisture, making the edges tighten and weakening print contrast.

Wavy or tight edges may cause the paper to slip when it is supplied. Try to keep the moisture content between 4 to 6%.

To maintain the right level of moisture content, bear in mind the following considerations.

- Store paper in a cool, well-ventilated place.
- Store paper flat and unopened in the package. Once the package is opened, reseal it if the paper is not to be used for a while.
- Store paper sealed in the original package and box. Put a pallet under the carton to keep it raised above the floor. Especially during rainy seasons keep the paper a sufficient distance away from wooden or concrete floors.
- Before using paper that has been stored, keep it at the proper moisture level for at least 48 hours.
- Do not store paper where it is exposed to heat, sunlight, or dampness.



## Other Paper Specifications

**Porosity:** The density of the paper fibers.

**Stiffness:** Paper must be stiff enough or it may buckle in the machine, causing jams.

**Curl:** Most paper naturally tends to curl after the package is opened. When paper passes through the fixing unit, it curls upward slightly. To deliver flat printouts, load the paper so that the curl faces towards the bottom of the paper tray.

**Static electricity:** During printing, paper is electrostatically charged so that the toner adheres. Choose paper that can be discharged quickly so that copies do not cling together.

**Whiteness:** Paper whiteness affects print contrast. Use whiter paper for sharper, brighter copies.

**Quality:** Machine problems may occur if sheet sizes are not uniform or if corners are not square, edges are rough, sheets are uncut, or edges or corners are crushed. In order to prevent these problems, be especially careful when you cut the paper yourself.

**Packaging:** Choose paper that is properly packaged and stacked in boxes. Ideally, the packaging itself should have been treated with a coating to inhibit moisture.

**Specially treated paper:** We do not recommend printing onto the following types of paper, even if it conforms to the basic specifications. When you use these kinds of paper, purchase a small amount first as a sample to test.

- Glossy paper
- Watermarked paper
- Paper with an uneven surface
- Perforated paper

## Special Paper

This section describes printing onto special paper and print media.

The following paper and media can be used.

- Transparencies
- Preprinted paper
- Bond paper
- Recycled paper
- Thin paper
- Letterhead
- Colored paper
- Prepunched paper
- Envelopes
- Hagaki (Cardstock)
- Thick paper
- Labels
- High-quality paper

When using these paper and media, choose those that are designed specifically for copiers or page printers (such as laser printers). Use the multi purpose tray for transparencies, thick paper, envelopes, cardstocks, and label paper.

### Choosing Special Paper

Although special paper that meets the following requirements can be used with the machine, print quality will vary considerably due to differences in the construction and quality of special paper. Thus, special paper is more likely than regular paper to cause printing problems. Before purchasing special paper in volume, try testing a sample to ensure the print quality is satisfactory. General precautions when printing onto special paper are given below. Note that we are not responsible for any harm to the user or damage to the machine caused by moisture or specifications of special paper.

Select a cassette or multi purpose tray for special paper.

### Transparencies

Transparencies must be able to withstand the heat of printing. Transparencies must meet the following conditions.

<b>Heat resistance</b>	Must withstand at least 190°C
<b>Thickness</b>	0.100 to 0.110 mm
<b>Material</b>	Polyester
<b>Dimensional accuracy</b>	±0.7 mm
<b>Squareness of corners</b>	90° ±0.2°

To avoid problems, use the multi purpose tray for transparencies and load transparencies with the long side facing the machine.

If transparencies jam frequently at output, try pulling the leading edge of sheets gently as they are ejected.

## Label

Be sure to feed labels from the multi purpose tray.

For selecting labels, use extreme care so that the adhesive may not come in direct contact with any part of the machine and that the labels are not easily peeled from the carrier sheet. Adhesives that stick to the drum or rollers and peeled labels remaining in the machine may cause a failure.

When printing onto labels, you must be liable for the print quality and possible trouble.

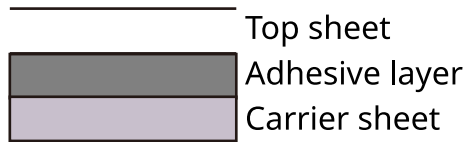

Labels consist of three layers as shown in the illustration. The adhesive layer contains materials that are easily affected by the force applied in the machine. The carrier sheet bears the top sheet until the label is used. This composition of labels may cause more problems.

The label surface must be covered completely with the top sheet. Gaps between labels may cause peeling of labels, resulting in a serious failure.

Some label paper has large margins on the top sheet. When using such paper, do not peel these margins from the carrier sheet before completing output.

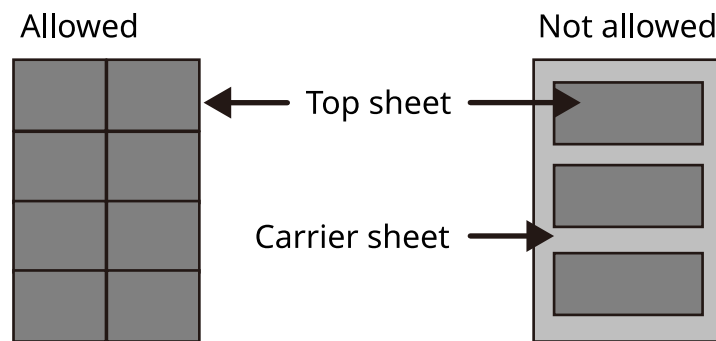

Use label paper that conforms to the following specifications.

<b>Top sheet weight</b>	44 to 74 g/m <sup>2</sup>
<b>Basis weight (overall paper weight)</b>	104 to 151 g/m <sup>2</sup>
<b>Top sheet thickness</b>	0.086 to 0.107 mm
<b>Overall paper thickness</b>	0.115 to 0.145 mm
<b>Moisture content</b>	4 to 6 % (composite)

## Hagaki (Cardstock)

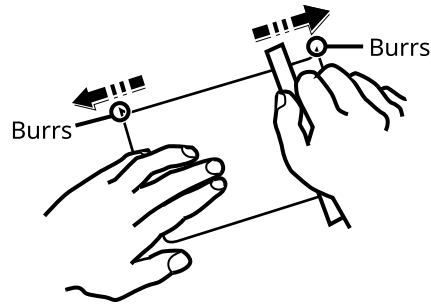

Before loading Hagaki (Cardstock) into the multi purpose tray, fan them and align the edges. If the Hagaki (Cardstock) paper is curled, straighten it before loading. Printing onto curled Hagaki (Cardstock) may cause jams.

Use unfolded Oufuku hagaki (Return postcard) (available at post offices). Some Hagaki (Cardstock) may still have rough edges developed by a paper cutter on the back side. Remove any such rough edges by placing the Hagaki (Cardstock) on a flat surface and rubbing the edges gently a few times with a ruler.

## Envelopes

Envelopes should be fed from the MP tray with the print-side up or the optional paper feeder with the print-side up.

### NOTE

Do not load paper above the load limits located on the paper width guide of the optional paper feeder.

Due to the structure of envelopes, printing evenly over the entire surface may not be possible in some cases. Thin envelopes in particular may be wrinkled by the machine in some cases as they pass through. Before purchasing envelopes in volume, try testing a sample to ensure the print quality.

Storing envelopes for a long period may cause them to become wrinkled. Thus, keep the package sealed until you are ready to use them.

Keep the following points in mind.

- Do not use envelopes with exposed adhesive. In addition, do not use the type of envelope in which the adhesive is exposed after the top layer is peeled off. Serious damage may be caused if the paper covering the adhesive comes off in the machine.
- Do not use envelopes with certain special features. For example, do not use envelopes with a grommet for winding a string to close the flap or envelopes with an open or film-covered window.
- If paper jams occur, load fewer envelopes at once.

## Thick Paper

Before loading thick paper in the multi purpose tray, fan it and align the edges. Some thick paper may still have rough edges developed by a paper cutter on the back side. Remove any such rough edges just as with Hagaki (Cardstock) by placing the paper on a flat surface and rubbing the edges gently a few times with a ruler. Printing onto paper with rough edges may cause jams.

### NOTE

If the paper is not supplied correctly even after it is smoothed, load the paper in the multi purpose tray with the leading edge raised a few millimeters.

## Colored Paper

Colored paper must conform to the specifications.

➔ [Basic Paper Specifications \(page 11-13\)](#)

In addition, the pigments in the paper must be able to withstand the heat of printing (up to 200°C or 392°F).

## Preprinted Paper

Preprinted paper must conform to the specifications.

➔ [Basic Paper Specifications \(page 11-13\)](#)

The colored ink must be able to withstand the heat of printing. It must be resistant to silicone oil as well. Do not use paper with a treated surface such as glossy paper used for calendars.

## Recycled Paper

Recycled paper must conform to the specifications; however, its whiteness may be considered separately.

➔ [Basic Paper Specifications \(page 11-13\)](#)



### NOTE

Before purchasing recycled paper in volume, try testing a sample to ensure satisfactory print quality.

# Specifications

## ✔ IMPORTANT

Specifications are subject to change without notice.

## NOTE

For more information on using the FAX, refer to the following:

➔ [FAX Operation Guide](#)

## Machine

Item		Description
<b>Type</b>		Desktop
<b>Printing Method</b>		Electrophotography by semiconductor laser
<b>Paper Weight</b>	<b>Cassette</b>	60 to 120 g/m <sup>2</sup>
	<b>Multi Purpose Tray</b>	60 to 220 g/m <sup>2</sup> , 136 to 163 g/m <sup>2</sup> (Banner sheet)
<b>Paper Type</b>	<b>Cassette</b>	Plain, Rough, Recycled, Preprinted, Bond, Color (Colour), Prepunched, Letterhead, High Quality, Custom 1 to 8 (Duplex: Same as Simplex)
	<b>Multi Purpose Tray</b>	Plain, Transparency (OHP film), Rough, Vellum, Labels, Recycled, Preprinted, Bond, Cardstock, Color (Colour), Prepunched, Letterhead, Envelope, Thick, High Quality, Custom 1 to 8
<b>Paper Size</b>	<b>Cassette</b>	A4, A5, A6 <sup>*1</sup> , B5, B6 <sup>*1</sup> , Letter, Legal, Statement, Statement (Landscape), Executive, Oficio II, Folio, 216 × 340 mm, 16K, B5 (ISO), Envelope DL <sup>*1</sup> , Envelope C5, Oufuku Hagaki (Return postcard) <sup>*1</sup> , Custom (ECOSYS MA6000ifx/ECOSYS MA5500ifx: 105 × 148 to 216 × 356 mm ECOSYS MA4500ifx/ECOSYS MA4500ix: 140 × 210 to 216 × 356 mm, )
	<b>Multi Purpose Tray</b>	A4, A5, A5 (Landscape), A6, B5, B6, Folio, 216 × 340 mm, Letter, Legal, Statement, Executive, Oficio II, 16K, B5 (ISO), Envelope #10, Envelope #9, Envelope #6 3/4, Envelope Monarch, Envelope DL, Envelope C5, Hagaki (Cardstock), Oufuku Hagaki (Return postcard), Nagagata 3, Youkei 4, Youkei 2, Custom (70 × 140 mm to 216 × 356 mm), Banner sheet (216 × 470.1 mm to 216 × 915 mm)
<b>Warm-up Time (22°C/71.6°F, 60%)</b>	<b>Power on</b>	ECOSYS MA6000ifx/ECOSYS MA5500ifx: 25 seconds or less ECOSYS MA4500ifx/ECOSYS MA4500ix: 23 seconds or less
	<b>Low Power Mode</b>	10 seconds or less
	<b>Sleep</b>	ECOSYS MA6000ifx/ECOSYS MA5500ifx: 25 seconds or less ECOSYS MA4500ifx/ECOSYS MA4500ix: 21 seconds or less
<b>Paper Capacity</b>	<b>Cassette</b>	500 sheets (80 g/m <sup>2</sup> )* <sup>2</sup>
	<b>Multi Purpose Tray</b>	100 sheets (80 g/m <sup>2</sup> )

\*1 ECOSYS MA6000ifx/ECOSYS MA5500ifx only

\*2 Up to upper limit height line in the cassette.

Item		Description
<b>Output Tray Capacity</b>	<b>Inner tray</b>	ECOSYS MA6000ifx/ECOSYS MA5500ifx: 500 sheets (80 g/m <sup>2</sup> ) ECOSYS MA4500ifx/ECOSYS MA4500ix: 250 sheets (80 g/m <sup>2</sup> )
<b>Image Write System</b>		Semiconductor laser and electrophotography
<b>Memory</b>		1.5GB
<b>Interface</b>	<b>Standard</b>	USB Interface Connector: 1 (Hi-Speed USB) Network interface: 1 (10 BASE-T/100 BASE-TX/1000 BASE-T) USB Port: 2 (Hi-Speed USB) Fax: 1 (ECOSYS MA6000ifx/ECOSYS MA5500ifx/ECOSYS MA4500ifx only)
	<b>Option</b>	eKUIO: 1 Wireless LAN: 1
<b>Operating Environment</b>	<b>Temperature</b>	10 to 32.5°C/50 to 90.5°F
	<b>Humidity</b>	15 to 80 %
	<b>Altitude</b>	3,500 m/11,482 ft maximum
	<b>Brightness</b>	1,500 lux maximum
<b>Dimension (W × D × H)</b>	<b>ECOSYS MA4500ifx/ ECOSYS MA4500ix</b>	18.71" × 18.74" × 22.64" 475 × 476 × 575 mm
	<b>ECOSYS MA5500ifx</b>	18.9" × 19.49" × 23.24" 480 × 495 × 590 mm
	<b>ECOSYS MA6000ifx</b>	18.9" × 19.49" × 24.02" 480 × 495 × 610 mm
<b>Weight (without toner container)</b>	<b>ECOSYS MA4500ifx/ ECOSYS MA4500ix</b>	Approx. 48.5 lb/Approx. 22.5 kg
	<b>ECOSYS MA5500ifx</b>	Approx. 51.4 lb/Approx. 24.1 kg
	<b>ECOSYS MA6000ifx</b>	Approx. 54.1 lb/Approx. 24.5 kg
<b>Space Required (W × D) (Using multi purpose tray)</b>	<b>ECOSYS MA4500ifx/ ECOSYS MA4500ix</b>	18.71" × 26.23" 475 × 666 mm
	<b>ECOSYS MA5500ifx/ ECOSYS MA6000ifx</b>	18.9" × 26.97" 480 × 685 mm
<b>Power Source</b>		120 V Specification Model: 120 V ~ 60 Hz 10.0 A 230 V Specification Model: 220 to 240 V ~ 50/60 Hz 5.6 A
<b>The power consumption of the product in networked standby (If all network ports are connected.)</b>		The information is available at the website below. <a href="https://www.kyoceradocumentsolutions.eu/en/about-us/our-brand/environmental-policy.html">https://www.kyoceradocumentsolutions.eu/en/about-us/our-brand/environmental-policy.html</a>
<b>Options</b>		➔ <a href="#">Optional Equipment (page 11-2)</a>

## Copy Functions

Item		Description	
<b>Copy Speed (Standard cassette)</b>	<b>ECOSYS MA4500ifx/ ECOSYS MA4500ix</b>	A4	45 sheets/min
		Letter	47 sheets/min
		Legal	38 sheets/min
		B5	36 sheets/min
		A5	23 sheets/min
		Statement	23 sheets/min
	<b>ECOSYS MA5500ifx</b>	A4	55 sheets/min
		Letter	57 sheets/min
		Legal	46 sheets/min
B5		44 sheets/min	
A5		29 sheets/min	
A5 (Landscape)		82 sheets/min	
Statement		29 sheets/min	
Statement (Landscape)		84 sheets/min	
<b>ECOSYS MA6000ifx</b>	A4	60 sheets/min	
	Letter	62 sheets/min	
	Legal	50 sheets/min	
	B5	48 sheets/min	
	A5	32 sheets/min	
	A5 (Landscape)	90 sheets/min	
	Statement	32 sheets/min	
	Statement (Landscape)	92 sheets/min	
	A6	32 sheets/min	
<b>First Copy Time (A4, place on the platen, feed from Cassette)</b>		7 seconds or less	
<b>Zoom Level</b>		Manual mode: 25 to 400%, 1% increments Auto mode: Preset Zoom	
<b>Continuous Copying</b>		1 to 999 sheets	
<b>Resolution</b>		600 × 600 dpi	
<b>Supported Original Types</b>		Sheet, Book, 3-dimensional objects (maximum original size: Legal/Folio)	
<b>Original Feed System</b>		Fixed	



## Printer Functions

Item	Description
<b>Printing Speed</b>	Same as Copying Speed.
<b>First Print Time (A4, feed from Cassette)</b>	ECOSYS MA4500ifx/ECOSYS MA4500ix: 5.3 seconds or less ECOSYS MA6000ifx/ECOSYS MA5500ifx: 4.5 seconds or less
<b>Resolution</b>	Fast 1200, Fine 1200, 600 dpi
<b>Operating System</b>	Windows 8.1, Windows 10, Windows 11 Windows Server 2012/R2, Windows Server 2016, Windows Server 2019 Mac OS 10.9 or later
<b>Interface</b>	USB Interface Connector: 1 (Hi-Speed USB) Network interface: 1 (10 BASE-T/100 BASE-TX/1000 BASE-T) Optional Interface (Option): 1 (For IB-50/IB-51 mounting) Wireless LAN (Option): 1 (For IB-37/IB-38 mounting)
<b>Page Description Language</b>	PRESCRIBE
<b>Emulations</b>	PCL6 (PCL-XL, PCL5c), KPDL3, PDF, XPS, Open XPS, TIFF/JPEG, URF, PWG Raster, PCLm

## Scanner Functions

Item		Description
<b>Resolution</b>		600 dpi, 400 dpi, 300 dpi, 200×400 dpi, 200 dpi, 200×100 dpi
<b>File Format</b>		TIFF (MMR/JPEG compression), JPEG, PDF (MMR/JPEG compression), XPS, PDF/A, High compressive PDF, Encrypted PDF, OPEN XPS, MS Office <sup>*1</sup> , Searchable PDF <sup>*1*2</sup>
<b>Scanning Speed<sup>*3</sup></b>	<b>(A4 landscape, 200 dpi, Image quality: Text/ Photo original)</b>	<b>ECOSYS MA4500ifx/ECOSYS MA4500ix</b> 1-sided    B/W 60 Images/min Color 40 Images/min 2-sided    B/W 26 Images/min Color 17 Images/min <b>ECOSYS MA6000ifx/ECOSYS MA5500ifx</b> 1-sided    B/W 60 Images/min Color 45 Images/min 2-sided    B/W 120 Images/min Color 90 Images/min
	<b>(A4 landscape, 300 dpi, Image quality: Text/ Photo original)</b>	<b>ECOSYS MA4500ifx/ECOSYS MA4500ix</b> 1-sided    B/W 60 Images/min Color 40 Images/min 2-sided    B/W 26 Images/min Color 17 Images/min <b>ECOSYS MA6000ifx/ECOSYS MA5500ifx</b> 1-sided    B/W 60 Images/min Color 40 Images/min 2-sided    B/W 120 Images/min Color 80 Images/min
<b>Interface</b>		Ethernet (10 BASE-T/100 BASE-TX/1000 BASE-T), USB
<b>Transmission System</b>		SMB, SMTP, FTP, FTP over SSL, USB, TWAIN <sup>*4</sup> , WIA <sup>*4</sup> , WSD

\*1 When the optional OCR Scan Activation Kit is installed.

\*2 Microsoft Office 2007 or later

\*3 When using the document processor (except TWAIN and WIA scanning)

\*4 Available Operating System: Windows 8/Windows 8.1/Windows 10/Windows 11/Windows Server 2012/Windows Server 2012 R2/Windows Server 2016/Windows Server 2019

## Document Processor

Item		Description
<b>Supported Original Types</b>		Sheet originals
<b>Paper Size</b>	<b>Maximum</b>	8.5" × 14" 216 × 355.6 mm (Long-sized 216 × 915 mm)
	<b>Minimum</b>	4.13" × 5.82" 105 mm × 148 mm
<b>Paper Weight</b>		1-sided: 50 to 120 g/m <sup>2</sup> 2-sided: 50 to 120 g/m <sup>2</sup>
<b>Loading Capacity</b>	<b>ECOSYS MA4500ifx/ ECOSYS MA4500ix</b>	75 sheets (50 to 80 g/m <sup>2</sup> ) maximum* <sup>1</sup>
	<b>ECOSYS MA6000ifx/ ECOSYS MA5500ifx</b>	100 sheets (50 to 80 g/m <sup>2</sup> ) maximum

\*1 Up to upper limit height line in the document processor

## Paper Feeder (500-sheet) (Option)

Item	Description
<b>Paper Supply Method</b>	Friction roller feeder (No. Sheets: 500, 80 g/m <sup>2</sup> )
<b>Paper Size</b>	A4, A5, B5, B6, Folio, 216.0mm×340.0mm, Letter, Legal, Statement, Executive, Oficio II, 16K, B5 (ISO), Envelope #10, Envelope #9, Envelope #6 3/4, Envelope Monarch, Envelope DL, Envelope C5, Oufuku Hagaki (Return postcard), Nagagata 3, Youkei 4, Youkei 2, Custom (92 × 162 to 216 × 356 mm)
<b>Supported Paper</b>	Paper weight: 60 to 120 g/m <sup>2</sup> Media types: Plain, Rough, Recycled, Preprinted, Bond, Color (Colour), Prepunched, Letterhead, Envelope, High Quality, Custom 1 to 8
<b>Dimensions (W) × (D) × (H)</b>	14.97" × 16.16" × 4.77" 380 × 410 × 121 mm
<b>Weight</b>	8.4 lbs. or less/ 3.8 kg or less



### NOTE

Consult your dealer or service representative for recommended paper types.

## Manual Stapler (ECOSYS MA6000ifx/ECOSYS MA5500ifx only)

Item	Description
<b>Paper Weight</b>	90 g/m <sup>2</sup> or less
<b>Number of stapled sheets<sup>*1</sup></b>	20 sheets (80 g/m <sup>2</sup> ) maximum, 15 sheets (90 g/m <sup>2</sup> or less) maximum
<b>Dimensions (W) × (D) × (H)</b>	2.64" × 6.5" × 5.32" 67 × 165 × 135 mm
<b>Weight</b>	1.4 lbs. or less/ 0.6 kg or less

\*1 Paper stack up to 2mm thick.

**NOTE**

Consult your dealer or service representative for recommended paper types.

# Back up Data

If the SSD, HDD or this machine's memory mounted on the main unit fails for some reason, the box files, fax reception data and various settings saved will be erased and cannot be restored. To prevent data erasure, make regular backups as follows:

- Take a backup using KYOCERA Net Viewer
  - ➔ [Data backup using KYOCERA Net Viewer \(page 11-28\)](#)
- Take a backup using Command Center RX
  - ➔ [Data backup using Command Center RX \(page 11-28\)](#)
- Back up your data using a USB drive.
  - ➔ [Back up Data Using USB Drive \(page 11-29\)](#)

## Data backup using KYOCERA Net Viewer

Use KYOCERA Net Viewer to regularly back up the data below that is saved on the machine.

- System Settings
  - Network Settings
  - User List
  - Address Book
  - Document Box Settings (excluding files in the document box)
- ➔ [Migrating the Address Book \(page 2-81\)](#)

## Data backup using Command Center RX

Use Command Center RX to regularly back up data saved in the Document Box and Fax Box to your PC. This section describes the procedure for backing up the data in the document box. Fax boxes can be backed up using the same procedure.

### 1 Display the screen.

- 1 Launch a web browser
- 2 In the address or location bar, enter the machine's IP address or the host name.  
Click in the following order to check the machine's IP address and the host name.  
[Device Information] in the home screen > [Identification/Wired Network]  
Click the number or name of the Custom Box in which the document is stored.

### 2 Download Document

- 1 Select the document data you want to download to your PC.  
Only the data of one document can be downloaded at a time.
- 2 Click the [Download] icon. The selected document is displayed in [Print Settings].
- 3 Specify the [Image Quality] and [File Format] as needed.
- 4 Click [Download].

## Back up Data Using USB Drive

The data saved in the Custom Box and fax box can be saved to the USB drive. The data of multiple documents can be saved at once.

➔ [Copying Documents in Custom Box to USB Drive \(page 5-57\)](#)

# Functions List of Security Quick Setup

The functions set at each level of Security Quick Setup are as follows: After selecting the level, set it individually according to your environment.

## TLS

Level 1	Level 2	Level 3
On	On	On

## Settings for Server Function

Can only be set with Command Center RX.

### TLS Version

Level 1	Level 2	Level 3
TLS1.2, TLS1.3	TLS1.2, TLS1.3	TLS1.2, TLS1.3

### Valid Cryptography

Level 1	Level 2	Level 3
3DES, AES, AES-GCM, AES, CHACHA20/POLY1305	AES-GCM, AES, CHACHA20/POLY1305	AES-GCM, AES, CHACHA20/POLY1305

### Hash

Level 1	Level 2	Level 3
SHA1, SHA-2(256/384)	SHA-2(256/384)	SHA-2(256/384)

### IPP Security

Level 1	Level 2	Level 3
Secure (IPPS)	Secure (IPPS)	Secure (IPPS)

### HTTPS Security

Level 1	Level 2	Level 3
Secure (HTTPS)	Secure (HTTPS)	Secure (HTTPS)

### Enhanced WSD Security

Level 1	Level 2	Level 3
Secure (Enhanced WSD over TLS)	Secure (Enhanced WSD over TLS)	Secure (Enhanced WSD over TLS)

## eSCL Security

Level 1	Level 2	Level 3
Non-secure (eSCL over TLS and eSCL)	Secure (eSCL over TLS)	Secure (eSCL over TLS)

## Settings for Client Function

Can only be set with Command Center RX.

### TLS Version

Level 1	Level 2	Level 3
TLS1.2, TLS1.3	TLS1.2, TLS1.3	TLS1.2, TLS1.3

### Valid Cryptography

Level 1	Level 2	Level 3
3DES, AES, AES-GCM, AES, CHACHA20/POLY1305	AES-GCM, AES, CHACHA20/POLY1305	AES-GCM, AES, CHACHA20/POLY1305

### Hash

Level 1	Level 2	Level 3
SHA1, SHA-2(256/384)	SHA-2(256/384)	SHA-2(256/384)

## IPv4 Settings (Wired Network)

Can only be set with Command Center RX.

### DNS over TLS

Level 1	Level 2	Level 3
Off	Auto	On

### Automatic Certificate Verification

Level 1	Level 2	Level 3
Expiration Date	Expiration Date	Expiration Date

### Hash

Level 1	Level 2	Level 3
SHA-2(256/384)	SHA-2(256/384)	SHA-2(256/384)

## IPv4 Settings (Wireless Network)

Can only be set with Command Center RX.



**DNS over TLS**

Level 1	Level 2	Level 3
Off	Auto	On

**Automatic Certificate Verification**

Level 1	Level 2	Level 3
Expiration Date	Expiration Date	Expiration Date

**Hash**

Level 1	Level 2	Level 3
SHA-2(256/384)	SHA-2(256/384)	SHA-2(256/384)

**IPv6 Settings (Wired Network)**

Can only be set with Command Center RX.

**DNS over TLS**

Level 1	Level 2	Level 3
Off	Auto	On

**Automatic Certificate Verification**

Level 1	Level 2	Level 3
Expiration Date	Expiration Date	Expiration Date

**Hash**

Level 1	Level 2	Level 3
SHA-2(256/384)	SHA-2(256/384)	SHA-2(256/384)

## IPv6 Settings (Wireless Network)

Can only be set with Command Center RX.

### DNS over TLS

Level 1	Level 2	Level 3
Off	Auto	On

### Automatic Certificate Verification

Level 1	Level 2	Level 3
Expiration Date	Expiration Date	Expiration Date

### Hash

Level 1	Level 2	Level 3
SHA-2(256/384)	SHA-2(256/384)	SHA-2(256/384)

## Transmission protocol: FTP Client (Transmission)

Can only be set with Command Center RX.

### Automatic Certificate Verification

Level 1	Level 2	Level 3
Expiration Date	Expiration Date	Expiration Date

### Hash

Level 1	Level 2	Level 3
SHA-2(256/384)	SHA-2(256/384)	SHA-2(256/384)

## Other Protocols: HTTP (Client)

Can only be set with Command Center RX.

### Automatic Certificate Verification

Level 1	Level 2	Level 3
Expiration Date	Expiration Date	Expiration Date

### Hash

Level 1	Level 2	Level 3
SHA-2(256/384)	SHA-2(256/384)	SHA-2(256/384)

## Other Protocols: SOAP

Can only be set with Command Center RX.

### Automatic Certificate Verification

Level 1	Level 2	Level 3
Expiration Date	Expiration Date	Expiration Date

### Hash

Level 1	Level 2	Level 3
SHA-2(256/384)	SHA-2(256/384)	SHA-2(256/384)

## Other Protocols: LDAP

Can only be set with Command Center RX.

### Automatic Certificate Verification

Level 1	Level 2	Level 3
Expiration Date	Expiration Date	Expiration Date

### Hash

Level 1	Level 2	Level 3
SHA-2(256/384)	SHA-2(256/384)	SHA-2(256/384)

## Transmission Protocols: SMTP (Sending Emails)

Can only be set with Command Center RX.

### Automatic Certificate Verification

Level 1	Level 2	Level 3
Expiration Date	Expiration Date	Expiration Date

### Hash

Level 1	Level 2	Level 3
SHA-2(256/384)	SHA-2(256/384)	SHA-2(256/384)

## Email: POP3 User Settings

Can only be set with Command Center RX.

### Automatic Certificate Verification

Level 1	Level 2	Level 3
Expiration Date	Expiration Date	Expiration Date

### Hash

Level 1	Level 2	Level 3
SHA-2(256/384)	SHA-2(256/384)	SHA-2(256/384)

## Print protocols

### NetBEUI

Level 1	Level 2	Level 3
On	Off	Off

### LPD

Level 1	Level 2	Level 3
On	On	Off

### FTP (Receiving)

Level 1	Level 2	Level 3
On	Off	Off

### IPP

Level 1	Level 2	Level 3
On	Off	Off

### IPP over TLS

Level 1	Level 2	Level 3
On	On	On

### Raw

Level 1	Level 2	Level 3
On	On	Off

**ThinPrint**

Level 1	Level 2	Level 3
On	Off	Off

**ThinPrint over TLS**

Level 1	Level 2	Level 3
On	Off	Off

**WSD Print**

Level 1	Level 2	Level 3
On	Off	Off

**POP (Receiving Emails)**

Level 1	Level 2	Level 3
Off	Off	Off

**Transmission Protocol****FTP Client (Transmission)**

Level 1	Level 2	Level 3
On	Off	Off

**SMB**

Level 1	Level 2	Level 3
On	On	Off

**WSD Scan**

Level 1	Level 2	Level 3
On	Off	Off

**DSM Scan**

Level 1	Level 2	Level 3
Off	Off	Off

**eSCL**

Level 1	Level 2	Level 3
Off	Off	Off

**eSCL over TLS**

Level 1	Level 2	Level 3
On	On	Off

**Other Protocols****SNMPv1/v2c**

Level 1	Level 2	Level 3
On	On	Off

**SNMPv3**

Level 1	Level 2	Level 3
On	On	Off

**HTTP**

Level 1	Level 2	Level 3
On	Off	Off

**HTTPS**

Level 1	Level 2	Level 3
On	On	On

**Enhanced WSD**

Level 1	Level 2	Level 3
On	Off	Off

**Enhanced WSD (TLS)**

Level 1	Level 2	Level 3
On	On	On

**LDAP**

Level 1	Level 2	Level 3
Off	Off	Off

**LLTD**

Level 1	Level 2	Level 3
Off	Off	Off

**VNC (RFB)**

Level 1	Level 2	Level 3
Off	Off	Off

**VNC (RFB) over TLS**

Level 1	Level 2	Level 3
Off	Off	Off

**Enhanced VNC (RFB) over TLS**

Level 1	Level 2	Level 3
On	Off	Off

**TCP/IP: Bonjour Settings****Bonjour**

Level 1	Level 2	Level 3
On	On	Off

**Network Settings****Wi-Fi Direct Settings**

Level 1	Level 2	Level 3
Off	Off	Off

**Connectivity****Bluetooth Settings**

Level 1	Level 2	Level 3
Off	Off	Off

## Interface Block Setting

### USB Device

Level 1	Level 2	Level 3
No block	No block	Block

### USB Host

Level 1	Level 2	Level 3
No block	No block	Block

### USB Drive

Level 1	Level 2	Level 3
No block	No block	Block

### Optional Interface

Level 1	Level 2	Level 3
No block	No block	Block

## Energy Saver/Timer

### Auto Panel Reset

Level 1	Level 2	Level 3
On	On	On

## Authentication Security Settings

### Lockout

Level 1	Level 2	Level 3
Off	Off	On

## Job Status/Job History Settings

### Display of Job Status Details

Level 1	Level 2	Level 3
Display all	Display all	Do not display (display only for system administrators)



## Display of Job History

Level 1	Level 2	Level 3
Display all	Display all	Do not display (display only for system administrators)

## Display of Fax Communication History

Level 1	Level 2	Level 3
Display all	Display all	Do not display (display only for system administrators)

## Edit Restriction

### Address Book

Level 1	Level 2	Level 3
No restriction	No restriction	Administrator only

### One-Touch Key

Level 1	Level 2	Level 3
No restriction	No restriction	Administrator only

## Prevent Mis-sending Settings

### Destination Check before Send

Level 1	Level 2	Level 3
Off	On	On

### Entry Check for New Dest.

Level 1	Level 2	Level 3
Off	On	On

### New Destination Entry

Level 1	Level 2	Level 3
Permit	Permit	Prohibit

### New destination entry (fax)

Level 1	Level 2	Level 3
Permit	Permit	Prohibit

### Recall Destination

Level 1	Level 2	Level 3
Permit	Permit	Prohibit

## Broadcast

Level 1	Level 2	Level 3
Permit	Permit	Prohibit

## Destination History

Level 1	Level 2	Level 3
Permit	Permit	Prohibit

## History Settings

### Security Communication Error History

Level 1	Level 2	Level 3
Off	On	On

# Glossary

## Accessibility

The machine is designed featuring good accessibility even for the elderly and those who are physically challenged or visually impaired. Touch panel is adjustable in two angles.

## Apple Talk

AppleTalk offers file sharing and printer sharing and it also enables you to utilize application software that is on another computer on the same AppleTalk network.

## Auto Form Feed Timeout

During data transmission, the machine may sometimes have to wait until receiving the next data. This is the auto form feed timeout. When the preset timeout passes, the machine automatically prints output. However, no output is performed if the last page has no data to be printed.

## Auto-IP

Auto-IP is a module that enables dynamic IPv4 addresses to be assigned to a device on startup. However, DHCP requires a DHCP server. Auto-IP is a server-less method of choosing an IP address. IP addresses between 169.254.0.0 to 169.254.255.255 are reserved for Auto-IP and assigned automatically.

## Auto Paper Selection

A function to automatically select paper in the same size as originals when printing.

## Auto Sleep

A mode designed for electrical power saving, activated when the machine is left unused or there is no data transfer for a specific period. In Sleep mode, power consumption is kept to a minimum.

## Bonjour

Bonjour, also known as zero-configuration networking, is a service that automatically detects computers, devices and services on an IP network. Bonjour, because an industry-standard IP protocol is used, allows devices to automatically recognize each other without an IP address being specified or DNS server being set. Bonjour also sends and receives network packets by UDP port 5353. If a firewall is enabled, the user must check that UDP port 5353 is left open so that Bonjour will run correctly. Some firewalls are set up so as to reject only certain Bonjour packets. If Bonjour does not run stably, check the firewall settings and ensure that Bonjour is registered on the exceptions list and that Bonjour packets are accepted. If you install Bonjour on Windows OS, the Windows firewall will be set up correctly for Bonjour.

## Custom Box

The Custom Box function stores print data for each individual user on the printer and allows the user to print single or multiple copies of the stored data later using the printer's operation panel.

## Default Gateway

This indicates the device, such as a computer or router, that serves as the entrance/exit (gateway) for accessing computers outside the network that you are on. When no specific gateway is designated for a destination IP address, data is sent to the host designated as the Default Gateway.

## **DHCP (Dynamic Host Configuration Protocol)**

Dynamic Host Configuration Protocol (DHCP) that automatically resolves IP addresses, subnet masks, and gateway addresses on a TCP/IP network. DHCP minimizes the load of network management employing a large number of client computers because it relieves individual clients including printers from the IP address being assigned.

## **DHCP (IPv6)**

DHCP (IPv6) is the next-generation of the Internet's Dynamic Host Configuration Protocol and supports IPv6. It extends the BOOTP startup protocol that defines the protocols used for transferring configuration information to hosts on the network. DHCP (IPv6) permits the DHCP server to use its expanded functionality to send configuration parameters to an IPv6 node. Because the network addresses that can be used are allocated automatically, the IPv6 node management workload is reduced in systems where the administrator has to exercise close control over IP address allocation.

## **dpi (dots per inch)**

A unit for resolution, representing the number of dots printed per inch (25.4 mm).

## **EcoPrint Mode**

A printing mode that helps save toner. Copies made in this mode are thus lighter than normal.

## **Emulation**

The function to interpret and execute other printers' page description languages. The machine emulates operation of PCL6, KPDL3 (PostScript 3 compatible).

## **Enhanced WSD**

Kyocera's proprietary web services.

## **FTP (File Transfer Protocol)**

A protocol to transfer files on the TCP/IP network, whether the Internet or an intranet. Along with HTTP and SMTP/POP, FTP is now frequently used on the Internet.

## **Grayscale**

A computer color expression. Displayed images of this sort are typically composed of shades of gray, varying from black at the weakest intensity to white at the strongest, without any other colors. Gray levels are displayed in numerical levels: that is, white and black only for 1 bit; 256 gray levels (including white and black) for 8 bits; and 65,536 gray levels for 16 bits.

## **Help**

A ? (Help) key is provided on this machine's operation panel. If you are unsure of how to operate the machine, would like more information on its functions or are having problems getting the machine to work properly, press the ? (Help) key to view a detailed explanation on the touch panel.

## **IP Address**

An Internet protocol address is a unique number that represents a specific computer or related device on the network. The format of an IP address is four sets of numbers separated by dots, e.g. 192.168.110.171. Each number should be between 0 and 255.

## **IPP**

IPP (Internet Printing Protocol) is a standard that uses TCP/IP networks such as the Internet to enable print jobs to be sent between remote computers and printers. IPP is an extension of the HTTP protocol used to view websites and enables printing to be carried out via routers on printers in remote locations. It also supports the HTTP authentication mechanisms along with SSL server and client authentication as well as encryption.

## **Job Box**

The Job Box function stores print data on the printer and allows users to print single or multiple copies of the stored data later using the printer's operation panel.

## **KPDL (Kyocera Page Description Language)**

Kyocera's PostScript page description language compatible with Adobe PostScript Level 3.

## **Multi Purpose (MP) Tray**

The paper supply tray on the front side of the machine. Use this tray instead of the cassettes when printing onto envelopes, Hagaki (Cardstock), transparencies, or labels.

## **NetBEUI (NetBIOS Extended User Interface)**

An interface, developed by IBM in 1985, as an update from NetBIOS. It enables more advanced functions on smaller networks than other protocols such as TCP/IP, etc. It is not suitable for larger networks due to lack of routing capabilities to choose the most appropriate routes. NetBEUI has been adopted by IBM for its OS/2 and Microsoft for its Windows as a standard protocol for file sharing and printing services.

## **Outline font**

With outline fonts, character outlines are represented with numerical expressions and fonts can be enlarged or reduced in different ways by changing the numeric values of those expressions. Printing remains clear even if you enlarge fonts, since the characters are defined with outlines represented with numerical expressions. You can specify the font size in steps of 0.25 points up to 999.75 points.

## **PDF/A**

This is "ISO 19005-1. Document management - Electronic document file format for long-term preservation - Part 1: Use of PDF (PDF/A)", and is a file format based on PDF 1.4. It has been standardized as ISO 19005-1, and is a specialization of PDF, which has been mainly used for printing, for long-term storage. A new part, ISO 19005-2 (PDF/A-2), is currently being prepared.

## **POP3 (Post Office Protocol 3)**

A standard protocol to receive E-mail from the server in which the mail is stored on the Internet or an intranet.

## **PostScript**

A page description language developed by Adobe Systems. It enables flexible font functions and highly-functional graphics, allowing higher quality printing. The first version called Level 1 was launched in 1985, followed by Level 2 that enabled color printing and two-byte languages (e.g. Japanese) in 1990. In 1996, Level 3 was released as an update for the Internet access and PDF format as well as gradual improvements in implementation technologies.

## **PPM (prints per minute)**

This indicates the number of A4 size printouts made in one minute.

## **Printer Driver**

The software to enable you to print data created on any application software. Install the printer driver on the computer connected to the machine.

## **RA(Stateless)**

The IPv6 router communicates (transmits) information such as the global address prefix using ICMPv6. This information is the Router Advertisement (RA).

ICMPv6 stands for Internet Control Message Protocol, and is a IPv6 standard defined in the RFC 2463 "Internet Control Message Protocol (ICMPv6) for the Internet Protocol Version 6 (IPv6) Specification".

## **RAM Disk**

Using part of the printer's memory as a virtual disk, you can set any amount of memory from overall printer memory as a RAM disk in order to use features such as electronic sorting (shortening print time).

## **Send as E-mail**

A function to send the image data stored in the machine as an E-mail attachment. E-mail addresses can be selected from the list or entered at each time.

## **SMTP (Simple Mail Transfer Protocol)**

A protocol for E-mail transmission over the Internet or an intranet. It is used for transferring mail between mail servers as well as for sending mail from clients to their servers.

## **Status Page**

The page lists machine conditions, such as the memory capacity, total number of prints and scans, and paper source settings.

## **Subnet Mask**

The subnet mask is a way of augmenting the network address section of an IP address.

A subnet mask represents all network address sections as 1 and all host address sections as 0. The number of bits in the prefix indicates the length of the network address. The term "prefix" refers to something added to the beginning and, in this context, indicates the first section of the IP address. When an IP address is written, the length of the network address is indicated by the prefix length after a forward slash (/). For example, "24" in the address "133.210.2.0/24". In this way, "133.210.2.0/24" denotes the IP address "133.210.2.0" with a 24-bit prefix (network section). This new network address section (originally part of the host address) made possible by the subnet mask is referred to as the subnet address. When you enter the subnet mask, be sure to set the "DHCP" setting to "Off".

## **TCP/IP (Transmission Control Protocol/Internet Protocol)**

TCP/IP is a suite of protocols designed to define the way computers and other devices communicate with each other over a network.

## **TCP/IP (IPv6)**

TCP/IP (IPv6) is based on the current Internet protocol, TCP/IP (IPv4). IPv6 is the next-generation Internet protocol and expands the available address space, which resolves the problem of the lack of addresses under IPv4, while also introducing other improvements such as additional security functionality and the capacity to prioritize data transmission.

### **TWAIN (Technology Without An Interesting Name)**

A technical specification for connecting scanners, digital cameras, and other image equipment to computers. The TWAIN compatible devices enable you to process image data on any relevant application software. TWAIN is adopted on a large amount of graphic software (e.g. Adobe Photoshop) and OCR software.

### **USB (Universal Serial Bus) 2.0**

A USB interface standard for Hi-Speed USB 2.0. The maximum transfer rate is 480 Mbps. This machine is equipped with USB 2.0 for high-speed data transfer.

### **WIA (Windows Imaging Acquisition)**

A function to import images supported after Windows Me/XP from digital cameras and other peripheral devices. This function replaces what TWAIN used to do. The feature is provided as a part of Windows functions and improves ease of operation, so that you import images directly to My Computer without using any application.

### **WPS (Wi-Fi Protected Setup)**

WPS is a network security standard created by Wi-Fi Alliance, to make it easy to connect with the wireless devices and set up the Wi-Fi Protected Access. The WPS-supported services can connect to the wireless access points by pushing a button or entering passphrases.

---

# Index

## Numerics

2-sided/Book Original 6-35

## A

Accessibility 11-42  
Accessibility Functions 2-32  
Address Book 3-33  
    Adding 3-33  
    Contact 3-33  
    Editing and Deleting 3-39  
Adjustment/Maintenance 8-62  
    Image Adjustment 8-62  
    Others 8-64  
AirPrint 4-18  
Anti-theft Lock Slot 2-3  
Apple Talk 11-42  
Application 5-10  
Auto Detect Original Size 8-11  
Auto Drum Refresh 8-63  
Auto Error Clear 8-20  
Auto Form Feed Timeout 11-42  
Auto Panel Reset 8-8  
Auto Paper Selection 11-42  
Auto Sleep 2-47, 11-42  
Auto-IP 11-42  
    Settings 8-42, 8-44  
Automatic 2-Sided Print Function 1-13

## B

Background Density Adjustment 6-30, 8-62  
    Default 8-26, 8-27  
Bluetooth Settings 8-54  
Bonjour 11-42  
    Settings 8-50  
Border Erase 6-23  
Border Erase (Copy) 8-26  
Border Erase/Full Scan (Fax) 8-28  
Border Erase/Full Scan (Send/Store) 8-28

## C

Cables 2-8  
Canceled before Sending 8-22  
Card Reader 2-7  
Card reader 11-7  
Card Reader Holder 11-3  
Cassette  
    Loading Paper 3-4, 3-8  
    Paper Size and Media Type 3-15  
Cassette 1 2-2  
Cassette 1 (to 4) Settings 8-13  
Cassette Settings 3-15  
Cassettes 2 to 5 2-7  
Castor kit 11-3  
Character Entry Method 11-10  
Checking the Counter 2-67  
Checking the Remaining Amount of Toner 7-14

Cleaning 10-2  
    Glass Platen 10-2  
    Registration Roller 10-4  
    Slit Glass 10-3  
Clear Set. after Job Started 8-25  
Clear Settings after Job Started 8-19  
Collate/Offset 6-19  
    Default 8-26  
Color  
    Color Balance 6-30  
Color Balance 6-30  
Color Selection 6-29  
    Default 8-27  
Combine 6-21  
Command Center RX 2-71  
Connecting  
    LAN Cable 2-9  
    Power Cable 2-10  
    USB cable 2-10  
Connection Method 2-8  
Connectivity 8-54  
Continuous Scan 6-32  
    Default 8-26, 8-27  
Contrast 6-31, 8-62  
Conventions Used in This Guide **xxi**  
Copy 5-15  
Copy Speed 11-23  
Counting the Number of Pages Printed  
    Counter 2-67  
    Print Accounting Report 9-47  
    Unknown ID Job 9-51  
Custom Box 11-42  
    Deleting Documents 5-59  
    Editing and Deleting Custom Box 5-51  
    Printing Documents 5-53  
    Send 5-55  
    Storing Documents 5-52, 5-54  
Custom Original Size 8-12  
Custom Paper Settings 8-15

## D

Data Sanitization 8-59  
Data Security 8-58  
Date Format 8-8  
Date/Time 8-7  
    Date Format 8-8  
    Date/Time 8-7  
    Time Zone 8-8



## Default

- Auto % Priority [8-27](#)
- Background Density Adj. (Copy) [8-26](#)
- Background Density Adj. (Send/Store) [8-27](#)
- Border Erase Default [8-25](#)
- Border Erase to Back Page [8-25](#)
- Clear Settings after Job Started [8-25](#)
- Collate/Offset [8-26](#)
- Color Selection [8-27](#)
- Color TIFF Compression [8-28](#)
- Continuous Scan (Copy) [8-26](#)
- Continuous Scan (Fax) [8-27](#)
- Continuous Scan (Send/Store) [8-27](#)
- DP Read Action [8-25](#)
- EcoPrint [8-26](#)
- Email Subject/Body [8-28](#)
- Fax TX Resolution [8-27](#)
- File Format [8-28](#)
- File Name Entry [8-25](#)
- File Separation [8-28](#)
- High Comp. PDF Image [8-28](#)
- Image Quality (File Format) [8-28](#)
- JPEG/TIFF Print [8-26](#)
- OCR Output Format [8-28](#)
- OCR Text Recognition [8-28](#)
- OCR Text Recognition Action [8-28](#)
- Org. Image (Send/Store) [8-27](#)
- Original Image (Copy) [8-26](#)
- Original Orientation (Copy) [8-26](#)
- Original Orientation(Send/Store) [8-27](#)
- PDF/A [8-28](#)
- Prevent Bleed-through (Copy) [8-26](#)
- Prevent Bleed-through (Send/Store) [8-27](#)
- Primary OCR Language [8-28](#)
- Reserve Next Priority [8-26](#)
- Scan Resolution [8-27](#)
- Skip Blank Page (Copy) [8-26](#)
- Skip Blank Page (Send/Store) [8-28](#)
- XPS Fit to Page [8-26](#)
- Zoom [8-25](#)

Default Gateway [11-42](#)

- Settings [8-42](#), [8-44](#)

Default Screen [8-10](#)

Delete after Printed [6-47](#)

Delete after Transmitted [6-47](#)

Delete Destination History [8-29](#)

Density [6-27](#), [8-62](#)

Destination

- Adding a Destination [3-33](#)
- Address Book [5-36](#)
- Address Book Type [8-32](#)
- Check before Send [8-29](#)
- Checking and Editing [5-40](#)
- Confirmation Screen of Destinations [5-40](#)
- Entry Check for New Dest. [8-29](#)
- Multi Sending [5-31](#)
- Narrow Down [8-32](#)
- One Touch Key [3-41](#)
- Sort [8-32](#)

Destination History Usage [8-29](#)

Device Information [7-12](#)

Device Security Settings [8-57](#)

- Administrator Authentication on Firm Update [8-57](#)
- Job Status/Job Logs Settings [8-57](#)
- Remote Printing [8-57](#)
- Security Level [8-57](#)
- Software Verification [8-57](#)
- Unusable Time [8-57](#)

Device Settings [8-7](#)

- Error Handling [8-19](#)
- Function Key Assignment [8-19](#)
- Keyboard [8-7](#)
- Language/System of Units [8-7](#)
- Numeric Keypad [8-7](#)
- Operation Assist [8-19](#)
- Original/Scan Settings [8-11](#)
- Paper Feeding [8-13](#)
- Sound [8-11](#)
- Toner Settings [8-20](#)

Device Status Notification [8-23](#)

- Low Toner Alert Level [8-23](#)

DHCP [11-43](#)

- Settings [8-42](#), [8-44](#)

DHCP (IPv6) [11-43](#)

- Settings [8-43](#), [8-45](#)

Digital Signature Email [6-46](#)

Direct Printing from Web [8-35](#)

Display Brightness [8-10](#)

Display Settings [8-10](#)

- Default Screen [8-10](#)
- Display Brightness [8-10](#)
- Quick Setup Registration (Box Print) [8-10](#)
- Quick Setup Registration (Copy) [8-10](#)
- Quick Setup Registration (Send) [8-10](#)
- Quick Setup Registration (Sending from Box) [8-10](#)
- Quick Setup Registration (Storing in Box) [8-10](#)
- Show Power Off Message [8-10](#)
- Wallpaper [8-10](#)

DNS over TLS [8-42](#), [8-43](#), [8-44](#), [8-45](#)

DNS Server Address

- Settings [8-42](#), [8-43](#), [8-44](#), [8-45](#)

Document Box

- Basic Operation [5-44](#)
- Custom Box [5-43](#)
- Job Box [4-19](#), [5-44](#)
- What is Document Box? [5-43](#)

Document Processor

- How to Load Originals [5-4](#)
- Loading Originals [5-4](#)
- Originals Not Supported by the Document Processor [5-4](#)
- Originals Supported by the Document Processor [5-4](#)
- Part Names [2-2](#)

Domain Name

- Settings [8-44](#), [8-45](#)

DP Read Action [8-25](#)

dpi [11-43](#)

- Duplex [6-25](#)
- Duplex Cover [2-5](#)
- E**
- EcoPrint [6-29](#), [11-43](#)
  - Default [8-26](#)
  - Printer [8-33](#)
- Edit Destination
  - Address Book [3-33](#)
  - Contact [3-33](#)
  - One Touch Key [3-41](#)
- E-mail
  - POP3 [8-31](#)
  - SMTP (E-mail TX) [8-31](#)
- Email [8-22](#)
- Email Encrypted TX [6-46](#)
- E-mail Settings [2-75](#)
- E-mail Subject/Body [6-45](#)
- Email Subject/Body
  - Default [8-28](#)
- Email/Folder [8-22](#)
- Emulation [11-43](#)
  - Selection [8-33](#)
- Encrypted PDF Password [6-48](#)
- Energy Saver Recovery Level [2-48](#), [8-9](#)
- Energy Saver/Timer [8-8](#)
  - Auto Panel Reset [8-8](#)
  - EnergySaver RecoveryLevel [8-9](#)
  - Low Power Timer [8-8](#)
  - Panel Reset Timer [8-8](#)
  - Ping Timeout [8-9](#)
  - Power Off Rule [8-9](#)
  - Power Off Timer [8-9](#)
  - Sleep Level [8-8](#)
  - Sleep Rules [8-8](#)
  - Sleep Timer [8-8](#)
  - Weekly Timer Settings [8-9](#)
- Energy Saving Control Function [1-13](#)
- Energy Star (ENERGY STAR®) Program [1-13](#)
- Enhanced VNC over SSL
  - Protocol Settings [8-49](#)
- Enhanced WSD [11-43](#)
  - Protocol Settings [8-48](#)
  - TWAIN/WIA [8-38](#)
- Enhanced WSD over SSL
  - TWAIN/WIA [8-38](#)
- Enhanced WSD over TLS
  - Protocol Settings [8-48](#)
- Enlarged Display [2-32](#)
- Entering Numbers [2-29](#)
- Entry
  - File Name [6-33](#)
  - Subject [6-45](#)
- Environment [1-3](#)
- Erase Colors [6-32](#)
- Error Handling [8-19](#)
  - Auto Error Clear [8-20](#)
  - Continue or Cancel Error Job [8-20](#)
  - Duplexing Error [8-19](#)
  - Inserted Paper Mismatch [8-20](#)
  - Paper Mismatch Error [8-19](#)
- eSCL
  - Protocol Settings [8-48](#)
- eSCL over SSL
  - Protocol Settings [8-49](#)
- Expansion Memory [11-3](#)
- F**
- Favorites [5-7](#)
  - Deleting [5-9](#)
  - Editing [5-9](#)
  - Recalling [5-8](#)
  - Registering [5-8](#)
- Fax [8-22](#)
- Fax Communication Report [8-23](#)
- Fax Server [8-54](#)
- FAX Server Send [5-33](#)
- File
  - Format [6-37](#)
  - PDF [6-39](#)
  - Separation [6-44](#)
- File Format [6-37](#)
  - Default [8-28](#)
- File Management Utility Connection [5-30](#)
- File Name Entry [6-33](#)
  - Default [8-25](#)
- File Separation [6-44](#)
  - Default [8-28](#)
- First Copy Time [11-23](#)
- First Print Time [11-24](#)
- Front Cover [2-2](#)
- Front Cover Open Button [2-2](#)
- FTP [11-43](#)
  - FTP Client (Transmission)
    - Protocol Settings [8-31](#), [8-46](#)
  - FTP Encrypted TX [6-45](#)
  - FTP Server (Reception)
    - Protocol Settings [8-46](#)
- Function Key Assignment [2-22](#), [8-19](#)

- Function Settings [8-25](#)
  - Address Book [8-32](#)
  - Copy/Print [8-28](#)
  - Document Box [8-36](#)
  - Email [8-31](#)
  - Fax Memory RX Box [8-36](#)
  - Fax/iFax [8-31](#)
  - Function Defaults [8-25](#)
  - Home [8-37](#)
  - Job Box [8-36](#)
  - One-Touch Key [8-32](#)
  - Printer [8-33](#)
  - RX/Forward Rules/Fax Box [8-33](#)
  - Send and Forward [8-33](#)
  - Send/Store [8-29](#)
  - Sending Job - Folder [8-31](#)
  - Status [8-37](#)
  - TWAIN/WIA [8-38](#)
  - WSD [8-32](#)
- Fuser Cover [2-4](#)

## G

- Glossary [11-42](#)
- Grayscale [11-43](#)
- Group Authorization Set. [9-19](#)
  - Group Authorization [9-19](#)
  - Group List [9-20](#)
- Group Authorization Settings [9-19](#)
- Guest Authorization Set. [9-21](#)
  - Guest Authorization [9-21](#)
  - Guest Property [9-22](#)
- Guides Provided with the Machine [xix](#)

## H

- Handle [2-2](#)
- Hard Disk/SSD Initialization [8-58](#)
- Help [11-43](#)
- Help Screen [2-31](#)
- History Settings [8-24](#)
  - Sending Log History [8-24](#)
- Home
  - Customize Desktop [2-19](#)
  - Customize Taskbar [2-19](#)
  - Wallpaper [2-19](#)
- Home Screen [2-17](#)
- Host Name [8-39](#), [8-51](#)
- HTTP
  - Protocol Settings [8-48](#)
- HTTPS
  - Protocol Settings [8-48](#)

## I

- ID Card Copy [6-19](#)
- ID Card Settings
  - Additional Authentication [9-29](#)
  - Keyboard Login [9-29](#)

- Image Adjustment
  - Auto Color Correction [8-63](#)
  - Auto Drum Refresh [8-63](#)
  - Background Density Adjustment [8-62](#)
  - Contrast [8-62](#)
  - Correcting Black Lines [8-63](#)
  - Density [8-62](#)
  - Drum Refresh 1 [10-40](#)
  - Drum Refresh 2 [10-41](#)
  - Print Density [8-63](#)
  - Sharpness Adjustment [8-62](#)

- Inner Tray [2-2](#)

- Install

- Macintosh [2-60](#)
- Software [2-52](#)
- Windows [2-53](#)

- Interface Block Setting [8-56](#)

- IP Address [11-43](#)
  - Settings [8-42](#), [8-44](#)

- IP Filter (IPv4)
  - Settings [8-50](#)

- IP Filter (IPv6)
  - Settings [8-50](#)

- IPP [11-44](#)
  - Protocol Settings [8-47](#)

- IPP over SSL
  - Protocol Settings [8-47](#)

- IPSec [8-51](#)

## J

- Job

- Available Status [7-2](#)
- Canceling [7-11](#)
- Checking History [7-9](#)
- Checking Status [7-2](#)
- Detailed Information [7-8](#)
- Detailed Information of Histories [7-10](#)
- Details of the Status Screens [7-3](#)
- Displaying History Screen [7-10](#)
- Displaying Status Screens [7-2](#)
- Pause and Resumption [7-11](#)
- Sending the Log History [7-10](#), [8-24](#)

- Job Accounting [9-33](#)

- Adding an Account [9-36](#)
- Apply Limit [9-49](#)
- Copy/Printer Count [9-50](#)
- Counting the Number of Pages Printed [9-45](#)
- Default Counter Limit [9-44](#)
- Deleting an Account [9-39](#)
- Editing an Account [9-38](#)
- Enabling Job Accounting [9-35](#)
- FAX Driver [9-43](#)
- Login [9-48](#)
- Logout [9-48](#)
- Overview of Job Accounting [9-33](#)
- Print Accounting Report [9-47](#)
- Printing [9-40](#)
- Restricting the Use of the Machine [9-37](#)
- TWAIN [9-41](#)
- WIA [9-42](#)

Job Box [11-44](#)  
Deletion of Job Retention [8-36](#)  
Private Print Box [4-20](#)  
Proof and Hold Box [4-26](#)  
Quick Copy Box [4-24](#)  
Quick Copy Job Retention [8-36](#)  
Specifying the Job Box from a Computer and Storing the Job [4-19](#)  
Stored Job Box [4-22](#)  
Universal Print [4-29](#)  
Job Finish Notice [6-33](#)  
Job Finish Notice Setting [8-22](#)  
JPEG/TIFF Print [6-49](#)  
Default [8-26](#)

**K**  
Keyboard [8-7](#)  
Keyboard Layout [8-7](#)  
Knopflerfish License [1-12](#)  
KPD L [11-44](#)

**L**  
Label [11-18](#)  
LAN Cable [2-8](#)  
Connecting [2-9](#)  
LAN Interface [8-46](#)  
Language/System of Units [8-7](#)  
LDAP  
Protocol Settings [8-48](#)  
Left Cover [2-6](#)  
Legal Information [1-11](#)  
Legal Restriction on Copying [1-9](#)  
Legal Restriction on Scanning [1-9](#)  
Limited Use of This Product [1-10](#)  
LINE Connector [2-4](#)  
Loading Originals [5-2](#)  
Loading Originals in the Document Processor [5-4](#)  
Placing Originals on the Platen [5-2](#)  
Local Authorization [9-16](#)  
Login [2-33](#)  
Logout [2-34](#)  
Low Power Mode [2-46](#)  
Low Power Timer [8-8](#)  
Low Toner Alert [8-20](#)  
LPD  
Protocol Settings [8-47](#)

**M**  
Management [9-1](#)  
Manual Setting (IPv6) [8-43](#), [8-45](#)  
Manual Stapler [2-7](#)  
Manual stapler [11-7](#)  
Media Type Setting [8-17](#)  
Memory Diagnostics [8-64](#)  
Mixed Size Originals [6-16](#)  
Combinations [6-16](#)  
Copy Size [6-17](#)  
Monotype Imaging License Agreement [1-12](#)  
Mopria [4-18](#)

MP Tray Settings [8-14](#)  
Multi Purpose Tray [2-5](#), [11-44](#)  
Paper Size and Media Type [3-16](#)  
Multi Sending [5-31](#)

## N

NetBEUI [11-44](#)  
Protocol Settings [8-46](#)  
NetWare  
Settings [8-53](#)  
Network  
Preparation [2-36](#)  
Network Interface [2-8](#)  
Network Interface Connector [2-4](#)  
Network Interface Kit [11-6](#)  
Network Settings [8-39](#)  
Bonjour [8-50](#)  
IP Filter (IPv4) [8-50](#)  
IP Filter (IPv6) [8-50](#)  
IPSec [8-51](#)  
Ping [8-50](#)  
Protocol Settings [8-46](#)  
Proxy [8-39](#)  
Restart Network [8-51](#)  
Wi-Fi Direct [8-39](#)  
Wi-Fi Settings [8-40](#)  
Wired Network Settings [8-44](#)  
Network Setup  
Wi-Fi Direct Settings [2-44](#)  
Wired Network [2-36](#)  
Wireless Network [2-38](#)  
Notice [1-2](#)  
Notification/Report [8-21](#)  
Device Status Notification [8-23](#)  
Fax Communication Report [8-23](#)  
History Settings [8-24](#)  
Printing Report/List [8-21](#)  
Result Report Settings [8-22](#)  
Numeric Keypad [8-7](#)

**O**  
One Touch Key  
Adding [3-41](#)  
Editing and Deleting [3-42](#)  
Operation Assist [8-19](#)  
Clear Settings after Job Started [8-19](#)  
Orientation Confirmation [8-19](#)  
Preset Limit [8-19](#)  
Operation Panel [2-2](#)

## Option

- Card reader 11-7
- Card Reader Holder 11-3
- Castor kit 11-3
- Expansion Memory 11-3
- Manual stapler 11-7
- Network Interface Kit 11-6
- Overview 11-2
- Paper Feeder 11-3
- SD Card 11-4
- SSD 11-5
- ThinPrint Option 11-7
- Trusted Platform Module 11-7
- USB Keyboard 11-7
- Wireless Network Interface Kit 11-6

## Option Interface Slot 2-4

## Optional Applications 11-8

## Optional Keyboard Type 8-7

## Optional Network 8-51

- Host Name 8-51
- Restart Network 8-53
- Wired Network Settings 8-53
- Wireless Network 8-51

## Org. Image

- Default 8-27

## Orientation Confirmation 8-19

## Original

- Auto Detect 8-11
- Custom Original Size 8-12

## Original eject table 2-2

## Original Image 6-28

- Default 8-26

## Original Orientation 6-18

- Default 8-26, 8-27

## Original Size 6-14

## Original Size Indicator Plates 2-2

## Original Stopper 2-2, 5-6

## Original Table 2-2

## Original Width Guides 2-2

## Original/Scan Settings 8-11

- Auto Detect Original Size 8-11
- Custom Original Size 8-12
- Prevent Light Reflection 8-12

## Outline font 11-44

## P

## Panel Reset Timer 8-8

## Paper

### Appropriate Paper 11-14

### Auto Paper Selection 8-18

### Checking the Remaining Amount of Paper 7-14

### Custom Paper Size 8-15

### Default Paper Source 8-18

### Loading Cardstock 3-14

### Loading Envelopes 3-14

### Loading Paper 3-2

### Loading Paper in the Cassettes 3-4

### Loading Paper in the Multi Purpose Tray 3-11

### Loading Statement in the Cassettes 3-8

### Paper Selection 8-18

### Precaution for Loading Paper 3-3

### Show Paper Setup Message 8-17

### Size and Media Type 3-15, 11-13

### Special Paper 11-17

### Special Paper Action 8-18

### Specifications 11-13

## Paper Feed Mode 8-34

## Paper Feed Settings 8-18

## Paper Feeder 11-3

## Paper Feeding 8-13

### Cassette 1 (to 4) Settings 8-13

### Custom Paper Settings 8-15

### Media Type Setting 8-17

### MP Tray Settings 8-14

### Paper Feed Settings 8-18

### Show Paper Setup Message 8-17

## Paper Jams 10-42

### Cassettes 1 to 5 10-45

### Document Processor 10-51

### Duplex Unit 10-46

### Inner Tray 10-49

### Inside Rear Cover 10-49

### Inside the Machine 10-47

### Jam Location Indicators 10-42

### Multi Purpose Tray 10-44

## Paper Length Guide 2-5, 3-5, 3-8

## Paper Selection 6-15

## Paper Stopper 2-2, 2-7, 3-16

## Paper Width Guides 2-5, 3-5, 3-8

## Part Names 2-2

## Password 8-40

## PDF/A 11-44

## PIN Code Authorization 9-31

## Ping 8-50

## Platen 2-2

## POP3 11-44

## PostScript 11-44

## Power Cable

### Connecting 2-10

## Power Management 1-13

## Power Off 2-11

## Power Off Rule 8-9

## Power Off Timer 2-48, 8-9

## Power On 2-11

## Power Switch 2-2

## PPM 11-44

## Precaution for Loading Paper 3-3

- 
- Precautions for Use [1-4](#)
  - Preset Limit [8-19](#)
  - Prevent Bleed-thru [6-31](#)
    - Default [8-26](#), [8-27](#)
  - Prevent Light Reflection [8-12](#)
  - Primary Network (Client) [8-55](#)
  - Print Report
    - Data Sanitization Report [8-22](#)
  - Printer
    - Copies [8-34](#)
    - CR Action [8-34](#)
    - Duplex [8-34](#)
    - EcoPrint [8-33](#)
    - Emulation [8-33](#)
    - Form Feed TimeOut [8-34](#)
    - Job Name [8-34](#)
    - KIR [8-35](#)
    - LF Action [8-34](#)
    - MP Tray Priority [8-34](#)
    - Orientation [8-34](#)
    - Override A4/Letter [8-34](#)
    - Paper Feed Mode [8-34](#)
    - Printing Job Terminator [8-35](#)
    - Resolution [8-35](#)
    - User Name [8-34](#)
    - Wide A4 [8-35](#)
  - Printer Driver [11-45](#)
    - Help [4-3](#)
  - Printing Documents Stored in Removable USB Memory [5-60](#)
  - Printing from PC [4-4](#)
  - Printing Report/List [8-21](#)
    - Font List [8-22](#)
    - Network Status [8-21](#)
    - Optional Network Status [8-21](#)
    - Print Accounting Report [8-21](#)
    - Service Status [8-21](#)
    - Status Page [8-21](#)
  - Printing Speed [11-24](#)
  - Priority Override [6-34](#)
  - Protocol Settings [8-46](#)
- Q**
- Quick Setup Registration (Box Print) [8-10](#)
  - Quick Setup Registration (Copy) [8-10](#)
  - Quick Setup Registration (Send) [8-10](#)
  - Quick Setup Registration (Sending from Box) [8-10](#)
  - Quick Setup Registration (Storing in Box) [8-10](#)
  - Quick Setup Wizard [2-49](#)
- R**
- RA (Stateless) [11-45](#)
    - Settings [8-43](#), [8-45](#)
  - RAM Disk [11-45](#)
  - Raw
    - Protocol Settings [8-47](#)
  - Rear Cover 1 [2-3](#)
  - Rear Tray [2-7](#)
  - Recipient Format [8-22](#)
  - Recycled Paper [11-20](#)
  - Regarding Trade Names [1-11](#)
  - Registration Roller [2-6](#)
  - Regular Maintenance [10-2](#)
    - Toner Container Replacement [10-6](#)
    - Waste Toner Box Replacement [10-11](#)
  - Remote Operation [10-21](#)
  - Remote Printing [8-35](#)
  - Reserve Next Priority [8-26](#)
  - Resolution [6-44](#), [8-35](#), [11-23](#), [11-24](#)
  - Resource Saving - Paper [1-13](#)
  - Responding to Messages [10-23](#)
  - Restart Entire Device [8-55](#), [8-56](#)
  - Restart Network [8-51](#), [8-53](#)
  - Result Report Settings [8-22](#)
- S**
- Safety Conventions in This Guide [1-2](#)
  - Saving Documents to USB Memory [5-62](#)
  - Scan Resolution [6-44](#)
    - Default [8-27](#)
  - Scan to Folder Setup Tool for SMB [3-28](#)
  - SD Card [11-4](#)
  - Security Level [8-55](#)
  - Security Precautions when Using Wireless LAN [1-9](#)
  - Security Quick Setup [8-55](#)
  - Security Settings [8-55](#)
    - Authentication Security [8-60](#)
    - Data Security [8-58](#)
    - Device Security Settings [8-57](#)
    - Interface Block Setting [8-56](#)
    - Network [8-61](#)
    - Unknown User Settings [8-60](#)
  - Send and Print [6-45](#)
    - Printing [6-45](#)
  - Send as E-mail [5-17](#)
  - Send Result Report [8-22](#)
  - Send to Folder (FTP) [5-17](#)
  - Send to Folder (SMB) [5-17](#)
  - Send/Store
    - Broadcast [8-29](#)
    - Default Screen [8-29](#)
    - Destination Check before Send [8-29](#)
    - Entry Check for New Dest. [8-29](#)
    - New Destination Entry [8-29](#)
    - Recall Destination [8-29](#)
  - Sending [5-17](#)
    - Preparation for Sending a Document to a PC [3-17](#)
  - Sending Size [6-36](#)
  - Setting Date and Time [2-35](#)
  - Sharpness [6-30](#)
  - Sharpness Adjustment [8-62](#)
  - Shortcuts [5-13](#)
    - Adding [5-13](#)
    - Editing and Deleting Shortcuts [5-14](#)
  - Show Paper Setup Message [8-17](#)
  - Show Power Off Message [8-10](#)
  - Simple Login [2-34](#)

- 
- Simple Login Settings
    - Simple Login 9-26
    - Simple Login Setup 9-27
  - Size Dial 2-5
  - Skip Blank Page 6-35
    - Default 8-26, 8-28
  - Sleep 2-46
  - Sleep Level 2-47, 8-8
    - Energy Saver 8-8
    - Quick Recovery 8-8
  - Sleep Rules 2-47, 8-8
  - Sleep Timer 8-8
  - Slit Glass 2-2
  - SMB Client (Transmission)
    - Protocol Settings 8-31, 8-46
  - SMTP 11-45
  - SMTP Auth and Sender Address 8-31
  - SNMPv1/v2c
    - Protocol Settings 8-48
  - SNMPv3
    - Protocol Settings 8-48
  - Solving Malfunctions 10-14
  - Sound 8-11
  - Specifications 11-21
    - Copy Functions 11-23
    - Document Processor 11-26
    - Machine 11-21
    - Manual Stapler 11-27
    - Paper Feeder (500-sheet) (Option) 11-26
    - Scanner Functions 11-25
  - Specifying Destination 5-36
  - SSD 11-5
  - Status Page 11-45
  - Status/Job Cancel 7-1
  - Storing Size 6-48
  - Subnet Mask 11-45
    - Settings 8-42, 8-44
  - Supplies
    - Checking the Remaining Amount 7-14
  - Symbols 1-2
  - System Menu 8-2
    - Add/Delete Application 8-61
    - Adjustment/Maintenance 8-62
    - Date/Time 8-7
    - Device Settings 8-7
    - Display Settings 8-10
    - Energy Saver/Timer 8-8
    - Function Settings 8-25
    - Home 2-17
    - Job Accounting/Authentication 8-61
    - Network Settings 8-39
    - Notification/Report 8-21
    - Operation Method 8-2
    - Quick Setup Wizard 2-49
    - Security Settings 8-55
  - System/Network
    - Security Level 8-55
  - T**
    - TCP/IP 11-45
      - Settings 8-42, 8-44
    - TCP/IP (IPv4)
      - Settings 2-36, 8-42, 8-44
    - TCP/IP (IPv6) 11-43
      - Settings 8-43, 8-45
    - TEL Connector 2-4
    - Thin Print over TLS
      - Protocol Settings 8-47
    - ThinPrint
      - Protocol Settings 8-47
    - ThinPrint Option 11-7
    - Time Zone 8-8
    - Toner Container 2-6
    - Toner Container Lock Lever 2-6
    - Toner Container Replacement 10-6
    - Toner Settings 8-20
      - Low Toner Alert 8-20
    - Touch Panel 2-14
    - Tray Extension 2-5
    - Troubleshooting 10-14
    - Trusted Platform Module 11-7
    - TWAIN 11-46
      - Setting TWAIN Driver 2-64
  - U**
    - Universal Print 4-10
    - USB 11-46
    - USB Cable
      - Connecting 2-10
    - USB Drive
      - Printing 5-60
      - Remove 5-63
    - USB Drive Slot 2-2
    - USB Interface 2-8
    - USB Interface Connector 2-4
    - USB Keyboard 11-7
    - USB Memory
      - Save 5-62

---

- User Login Administration [9-2](#)
  - Adding a User [9-6](#)
  - Changing User Properties [9-9](#)
  - Enabling User Login Administration [9-3](#)
  - FAX Driver [9-15](#)
  - Group Authorization Settings [9-19](#)
  - Guest Authorization Set. [9-21](#)
  - ID Card Settings [9-29](#)
  - Local Authentication [9-16](#)
  - Login [2-33](#)
  - Logout [2-34](#)
  - Obtain NW User Property [9-24](#)
  - Overview of User Login Administration [9-2](#)
  - Password Policy Settings [9-5](#)
  - PIN Code Authentication [9-31](#)
  - Printing [9-11](#)
  - Server Settings [9-17](#)
  - Simple Login Settings [9-26](#)
  - TWAIN [9-13](#)
  - User Account Lockout Setting [9-4](#)
  - WIA [9-14](#)
- User Login/Job Accounting
  - Job Accounting [9-33](#)
  - Unknown ID Job [9-51](#)
  - Unknown User Settings [9-51](#)
  - User Login [9-2](#)

- Z**
- Zoom [6-19](#)
- Default [8-25](#)

## V

- VNC (RFB)
  - Protocol Settings [8-49](#)
- VNC (RFB) over TLS
  - Protocol Settings [8-49](#)

## W

- Waste Toner Box [2-6](#)
- Waste Toner Box Replacement [10-11](#)
- Weekly Timer Settings [2-48](#), [8-9](#)
- WIA [11-46](#)
  - Setting WIA Driver [2-66](#)
- Wide A4 [8-35](#)
- Wi-Fi
  - Settings [2-38](#), [8-40](#)
- Wi-Fi Direct
  - Printing [4-18](#)
  - Settings [2-44](#), [8-39](#)
- Wireless Connection [1-9](#)
- Wireless Network
  - Settings [2-38](#), [8-51](#)
- Wireless Network Interface Kit [11-6](#)
- WSD Print
  - Protocol Settings [8-32](#), [8-46](#)
- WSD Scan [5-28](#)
  - Protocol Settings [8-32](#), [8-46](#)

## X

- XPS Fit to Page [6-49](#)
  - Default [8-26](#)



**QUALITY  
CERTIFICATE**

This machine has passed  
all quality controls and  
final inspection.

**KYOCERA Document Solutions America, Inc.**  
**Headquarters**  
225 Sand Road, Fairfield, New Jersey 07004-0008, U.S.A.  
Phone: +1-973-808-8444  
Fax: +1-973-882-6000

**Latin America**  
8240 NW 52nd Terrace, Suite 301  
Miami, Florida 33166, U.S.A.  
Phone: +1-305-421-6640

**KYOCERA Document Solutions  
Canada, Ltd.**  
6120 Kestrel Rd., Mississauga, ON L5T 1S8, Canada  
Phone: +1-905-670-4425  
Fax: +1-905-670-8116

**KYOCERA Document Solutions  
Mexico, S.A. de C.V.**  
Calle Arquimedes No. 130, 4 Piso, Colonia Polanco  
Chapultepec, Delegacion Miguel Hidalgo, Ciudad de  
Mexico, C.P.11560, Mexico  
Phone: +52-555-383-2741  
Fax: +52-555-383-7804

**KYOCERA Document Solutions  
Brazil, Ltda.**  
Al. Mamoré, 503, 4º andar, salas 41, 42 e 43, do Ed. Icon  
Alphaville, Alphaville, Barueri, SP, CEP 06454-040, Brazil  
Phone: +55-11-2424-5353  
Fax: +55-11-2424-5304

**KYOCERA Document Solutions  
Chile SpA**  
Andrés Bello 2299, Providencia Santiago,  
Region Metropolitana, Chile  
Phone: +56-2-2670-1900  
Fax: +56-2-2350-7150

**KYOCERA Document Solutions  
Australia Pty. Ltd.**  
Level 3, Quarter One, 1 Epping Road, North Ryde NSW  
2113, Australia  
Phone: +61-2-9888-9999  
Fax: +61-2-9888-9588

**KYOCERA Document Solutions  
New Zealand Ltd.**  
Ground Floor. 19 Byron Avenue, Takapuna, Auckland,  
New Zealand  
Phone: +64-9-415-4517  
Fax: +64-9-415-4597

**KYOCERA Document Solutions Asia Limited**  
13/F., Mita Centre, 552-566, Castle Peak Road, Tsuen  
Wan, New Territories, Hong Kong, China  
Phone: +852-2496-5678  
Fax: +852-2610-2063

**KYOCERA Document Solutions  
(China) Corporation**  
8F, No. 288 Nanjing Road West, Huangpu District,  
Shanghai, 200003, China  
Phone: +86-21-5301-1777  
Fax: +86-21-5302-8300

**KYOCERA Document Solutions  
Europe B.V.**

Bloemlaan 4, 2132 NP Hoofddorp, The Netherlands  
Phone: +31(0)20-654-0000  
Fax: +31(0)20-653-1256

**KYOCERA Document Solutions  
Nederland B.V.**

Beechavenue 25, 1119 RA Schiphol-Rijk, The Netherlands  
Phone: +31-20-5877200  
Fax: +31-20-5877260

**KYOCERA Document Solutions  
(U.K.) Limited**

Eldon Court 75-77 London Road, Reading, Berkshire RG1  
5BS, United Kingdom  
Phone: +44-118-931-1500  
Fax: +44-118-931-1108

**KYOCERA Document Solutions  
Italia S.p.A.**

Via Monfalcone 15, 20132, Milano, Italy  
Phone: +39-02-921791  
Fax: +39-02-92179-600

**KYOCERA Document Solutions  
Belgium N.V.**

Sint-Martinusweg 199-201 1930 Zaventem, Belgium  
Phone: +32-2-7209270  
Fax: +32-2-7208748

**KYOCERA Document Solutions  
France S.A.S.**

Espace Technologique de Saint-Aubin, Route de l'Orme,  
91190 Gif-sur-Yvette, France  
Phone: +33-1-69852600  
Fax: +33-1-69853409

**KYOCERA Document Solutions  
Espana, S.A.**

Calle Manacor, 2, Las Rozas, Madrid, 28290 Las Rozas  
de Madrid, Madrid, Spain  
Phone: +34-91-6318392  
Fax: +34-91-6318219

**KYOCERA Document Solutions  
Finland Oy**

Plaza Business Park Pilke, Äyritie 16, Vantaa, Finland  
Phone: +358-9-47805200  
Fax: +358-9-47805212

**KYOCERA Document Solutions  
Europe B.V. Amsterdam (NL) Zürich Branch**

Hohlstrasse 614, 8048 Zürich, Switzerland  
Phone: +41-44-9084949  
Fax: +41-44-9084950

**KYOCERA Bilgitas Document Solutions  
Turkey A.S.**

Altunizade Mah. Prof. Fahrettin Kerim Gökay Cad. No:45  
34662 ÜSKÜDAR İSTANBUL TURKEY  
Phone: +90-216-339-0020  
Fax: +90-216-339-0070

**KYOCERA Document Solutions  
Deutschland GmbH**

Otto-Hahn-Strasse 12, 40670 Meerbusch, Germany  
Phone: +49-2159-9180  
Fax: +49-2159-918100

**KYOCERA Document Solutions  
Austria GmbH**

Wienerbergstraße 11, Turm A, 18. OG, 1100 Wien, Austria  
Phone: +43-1-863380  
Fax: +43-1-86338-400

**KYOCERA Document Solutions  
Nordic AB**

Borgarfjordsgatan 11, 164 40 Kista, Sweden  
Phone: +46-8-546-550-00  
Fax: +46-8-546-550-10

**KYOCERA Document Solutions  
Norge Nuf**

Olaf Helsetsv. 6, 0619 Oslo, Norway  
Phone: +47-22-62-73-00  
Fax: +47-22-62-72-00

**KYOCERA Document Solutions  
Danmark A/S**

Ejby Industrivej 60, DK-2600 Glostrup, Denmark  
Phone: +45-70223880  
Fax: +45-45765850

**KYOCERA Document Solutions  
Portugal Lda.**

Rua do Centro Cultural, 41 (Alvalade) 1700-249 Lisboa,  
Portugal  
Phone: +351-21-843-6780  
Fax: +351-21-849-3312

**KYOCERA Document Solutions  
South Africa (Pty) Ltd.**

KYOCERA House, Hertford Office Park, 90 Bekker Road  
(Cnr. Allandale), Midrand, South Africa  
Phone: +27-11-540-2600  
Fax: +27-11-466-3050

**KYOCERA Document Solutions  
Russia LLC**

Building 2, 51/4, Schepkina St., 129110, Moscow, Russia  
Phone: +7(495)741-0004  
Fax: +7(495)741-0018

**KYOCERA Document Solutions Middle East**

Dubai Internet City, Bldg. 17,  
Office 157 P.O. Box 500817, Dubai, United Arab Emirates  
Phone: +971-4-4330412

**KYOCERA Document Solutions  
Czech, s.r.o.**

Harfa Office Park, Českomoravská 2420/15, Praha 9  
Czech Republic  
Phone: +420-222-562-246

**KYOCERA Document Solutions Inc.**

1-2-28 Tamatsukuri Chuo-ku Osaka 540-8585 Japan  
Phone: +81-6-6764-3555  
<https://www.kyoceradocumentsolutions.com>

