

KÄRCHER

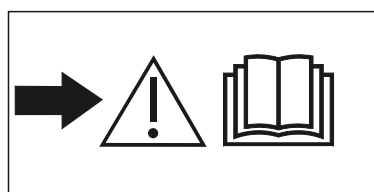

WV 6 Plus

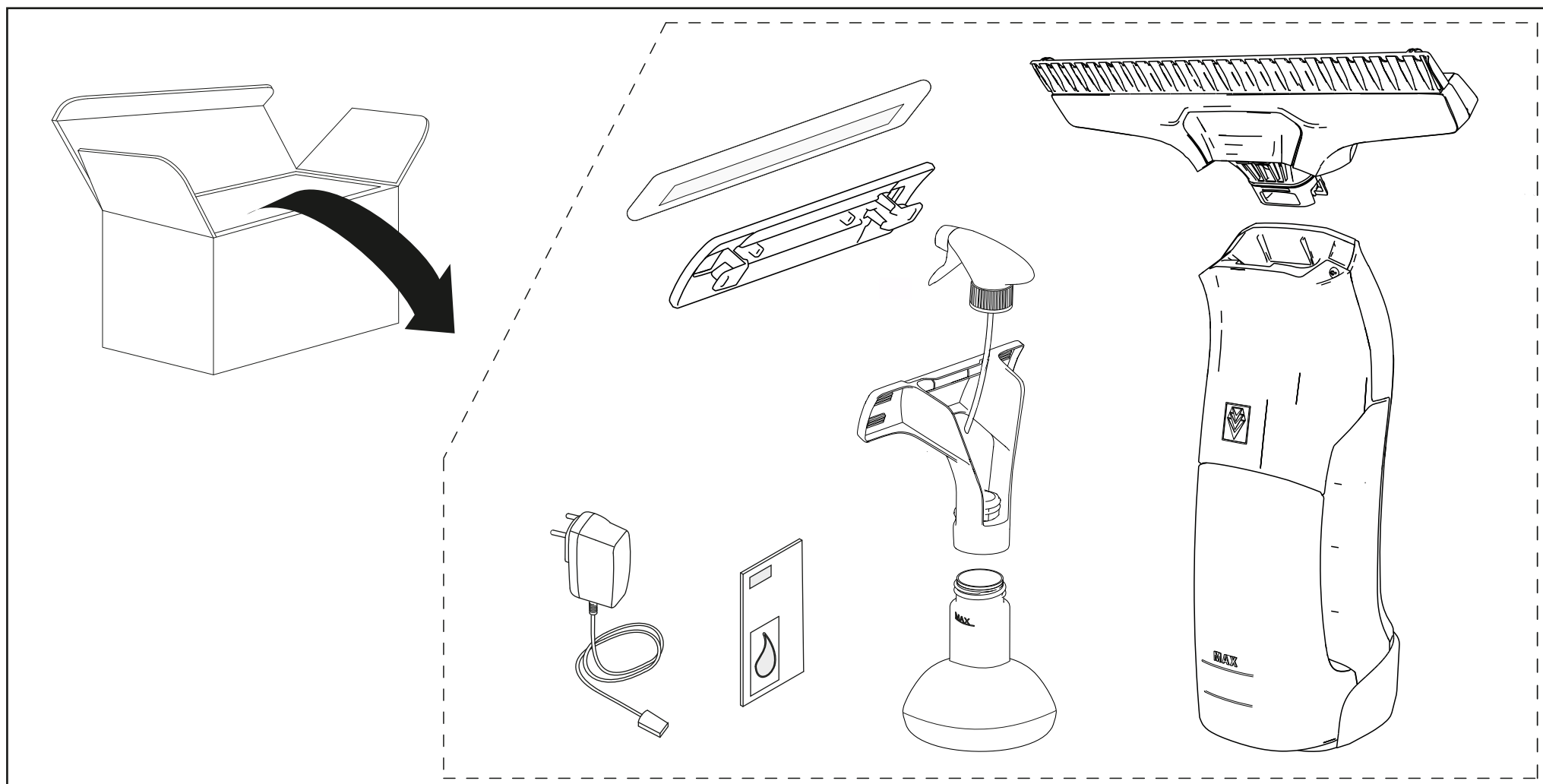
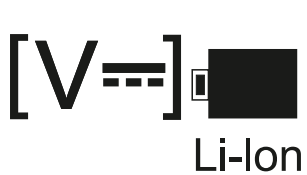
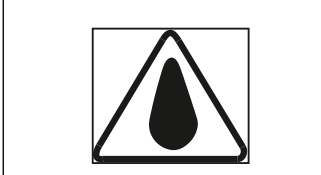
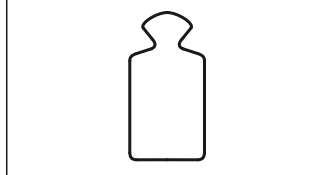
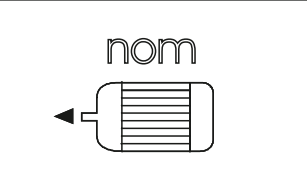
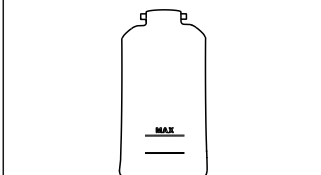
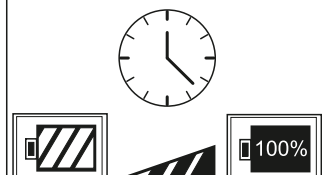
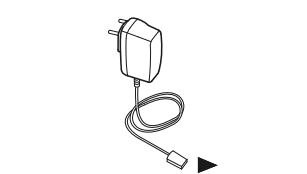
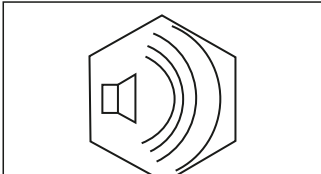
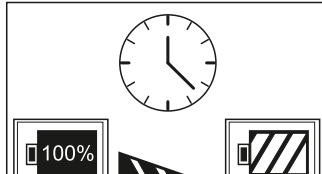

| | | | | | |
|---|--------------|--|----------|---|---------|
|  Li-Ion | 3,65 V |  | IPX4 |  | 0,8 kg |
|  nom | 10 W |  | 150 ml |  | 170 min |
|  | V 5,5 A 2 |  | 52 db(A) |  | 100 min |

