

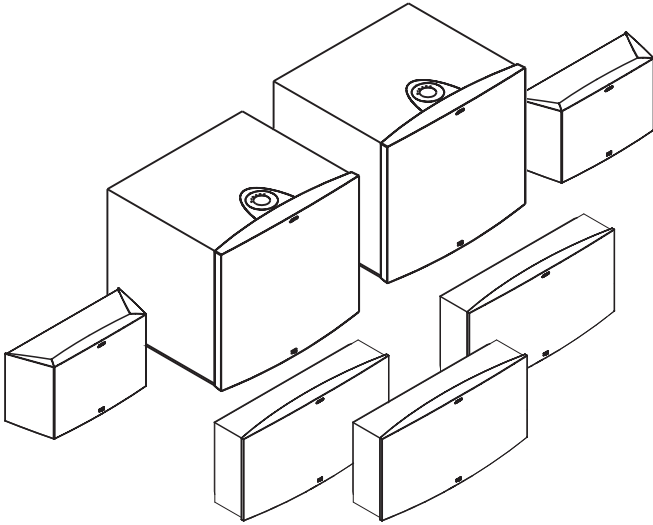



**THX**  
ULTRA 2.



	Note! Bemærk! Achtung!	A noter Attentie! Obs!	¡Atención! Attenzione! Atenção!	Huomaa! 注意! Προσοχή!	Внимание! Megjegyzés! Uwaga!	Dikkat! Upozornění! Pozor!	Opomba! 注意! ملاحظة!
	Wrong Forkert Falsch!	Faux Fout! Fehl!	¡Incorrecto! Sbagliato! Errado!	Väärin! 错误! Λάθος!	Неправильно! Hibás! Nieprawidłowo!	Yanlış! Špatně! Nesprávne!	Napačno! 間違い! خطأ!
	Correct Korrekt Richtig!	Vrai Goed! Rätt!	¡Correcto! Giusto! Correto!	Oikein! 正确! Σωστό!	Правильно! Megfelelő! Prawidłowo!	Doğru! Správně! Správne!	Pravilno! 正しい! صحيح!
	Listen Lyt Hören!	Ecoutez! Luister! Lyssna!	¡Escuche! Ascoltare! Ouça!	Kuuntele! 倾听! Ακούστε!	Слушайте! Hallgassa meg! Sluchaj!	Dinle! Poslouchejte! Počúvajte!	Poslušajte! 聽取! استمع!

THX and the THX logo are trademarks of THX Ltd.  
which may be registered in some jurisdictions. All rights reserved.

# 1

## D 600 LCR / D 600 SUR Left / D 600 SUR Right

### THX 5.1

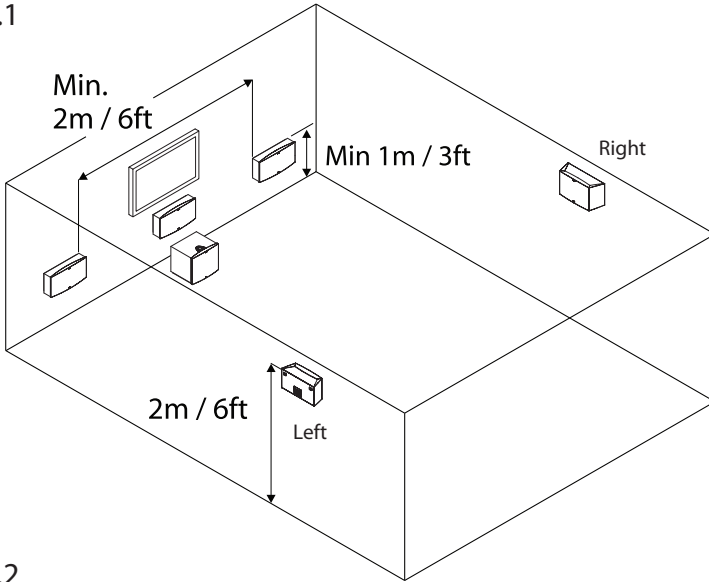

### THX 5.2

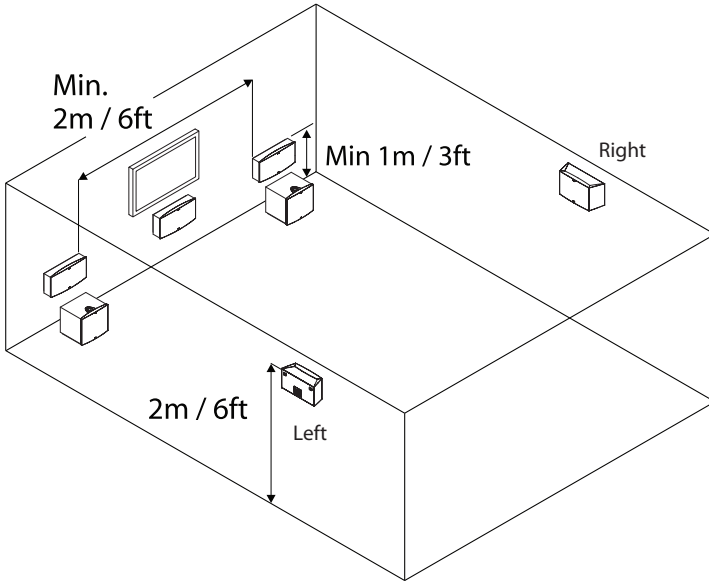

## THX Surround EX 6.1

Surround back / 1 x D 600 LCR

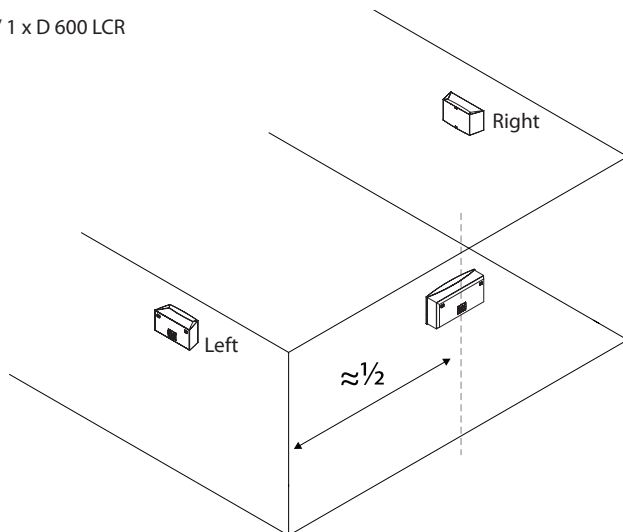

## THX Surround EX 7.1

Surround back / 2 x D 600 LCR

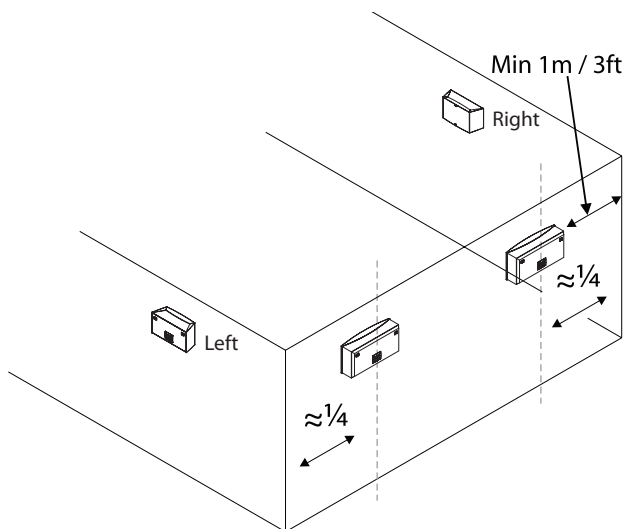

# D 600 SUB

1 x D 600 SUB

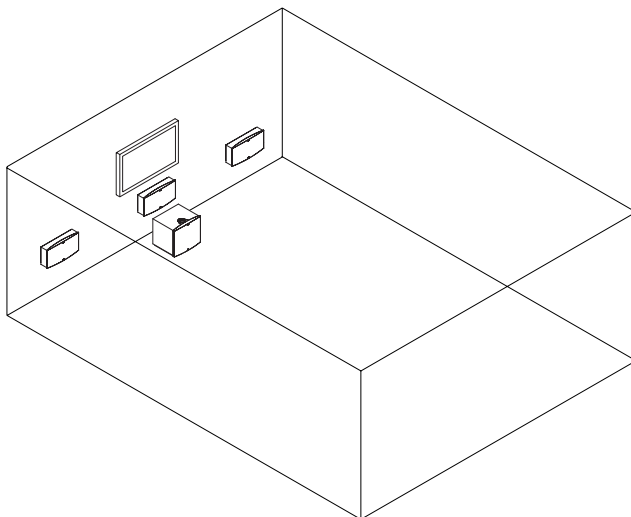

2 x D 600 SUB

A

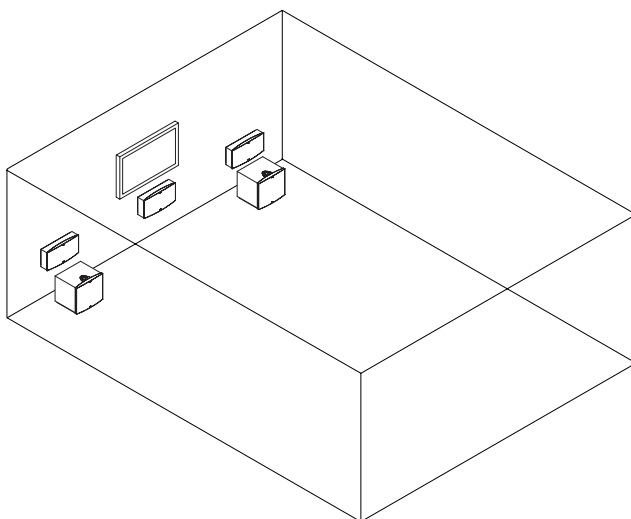

2 x D 600 SUB

B

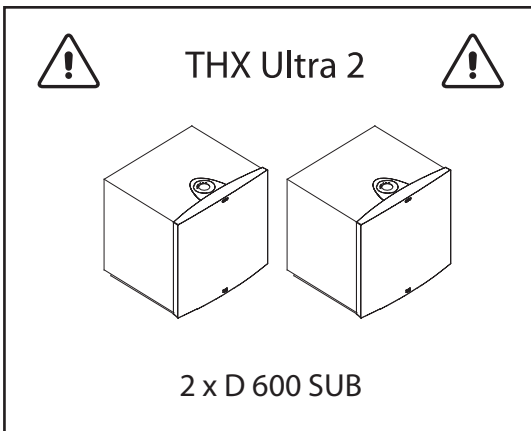
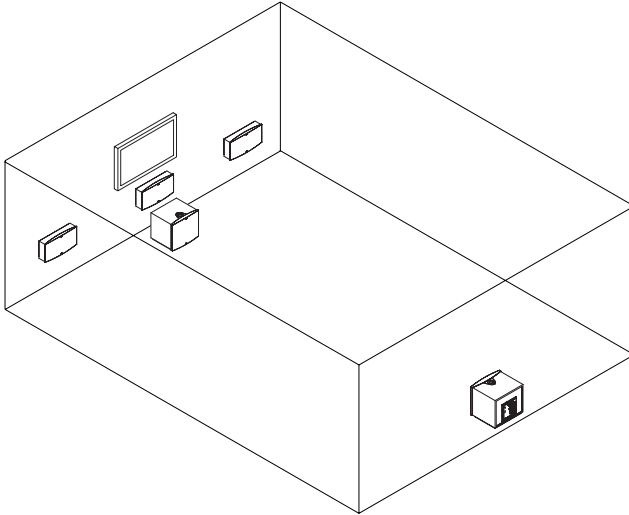

**THX**  
ULTRA 2.

RECOMMENDED USE

All Home Theaters or Living Rooms

THX CERTIFICATION FEATURES

**Frequency Response:** Low Frequency Extension 25Hz at -3dB

**High Output, Low Distortion Design**

**THX Settings and Inputs Conform to THX Bass Management System**

THX PERFORMANCE

Capable of THX Reference Level up to 3000 cubic feet (85 cubic meters) with two subwoofers.

Visit [www.thx.com](http://www.thx.com) for further technical details.

# 2



## D 600 SUB

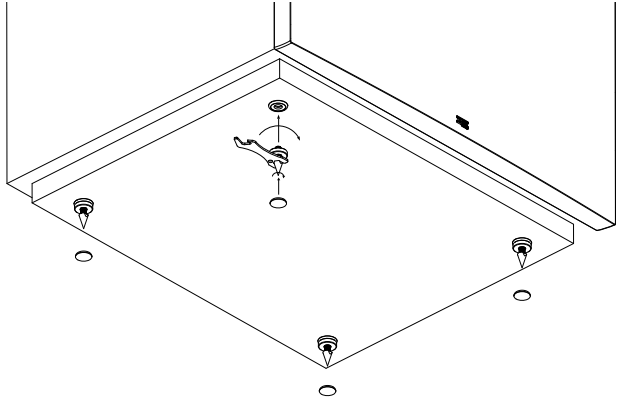
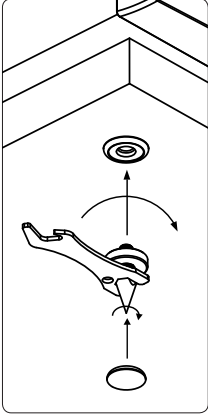

## D 600 LCR



This speaker should not be placed close to a CRT display



4 mm  
0.2 in

Min.  
26 Kg

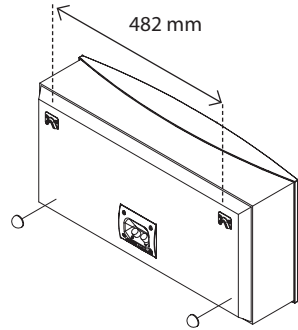
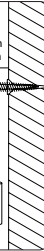

## D 600 SUR



This speaker should not be placed close to a CRT display



4 mm  
0.2 in

Min.  
18 Kg

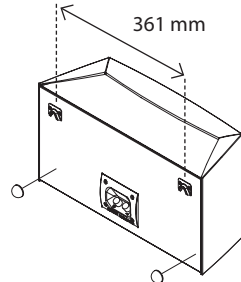
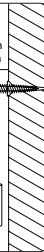

# 3

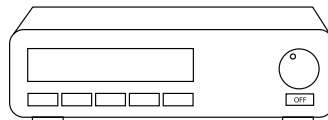
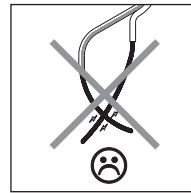
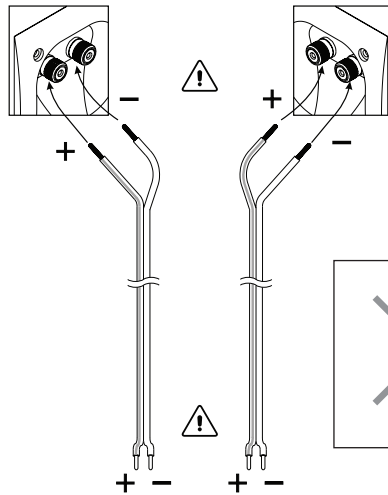
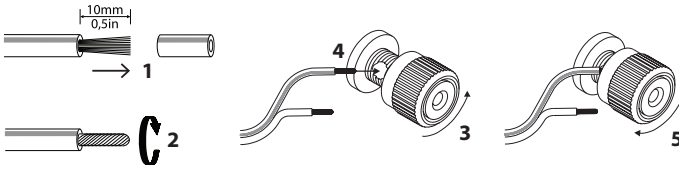
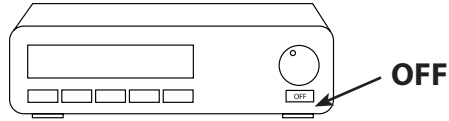

# 4 D 600 SUB

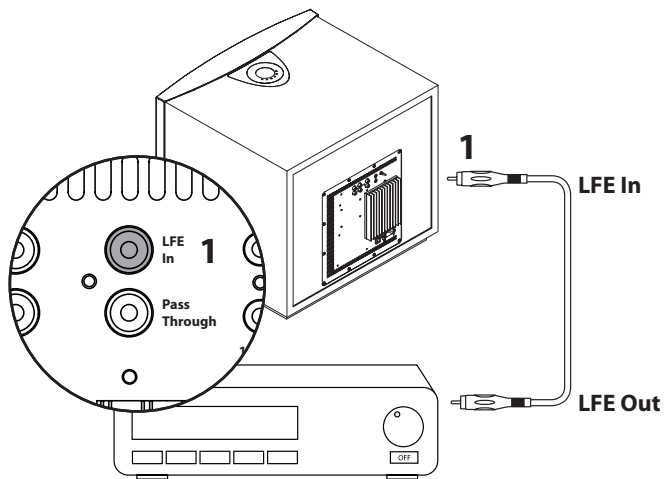
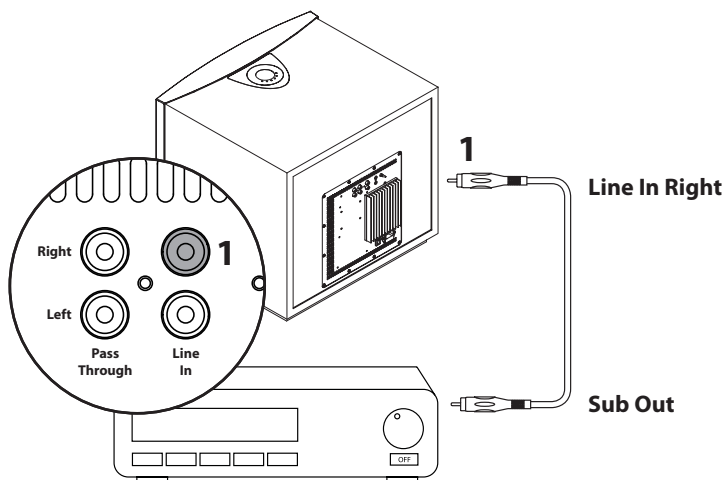



Sub Out

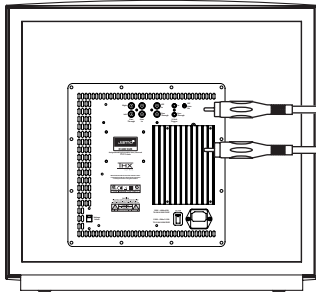
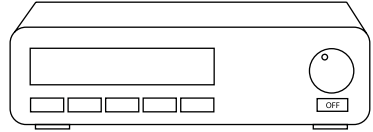

1  
Line In Right  
Pass Through  
Right  
2

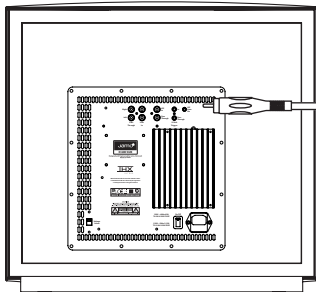
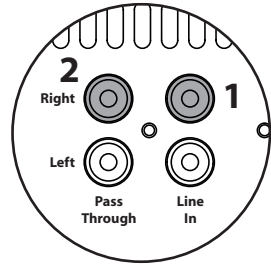

Line In Right  
3

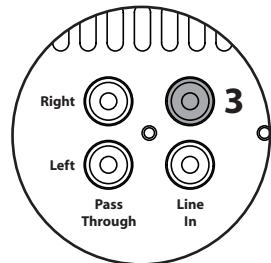

# 5 System Connection

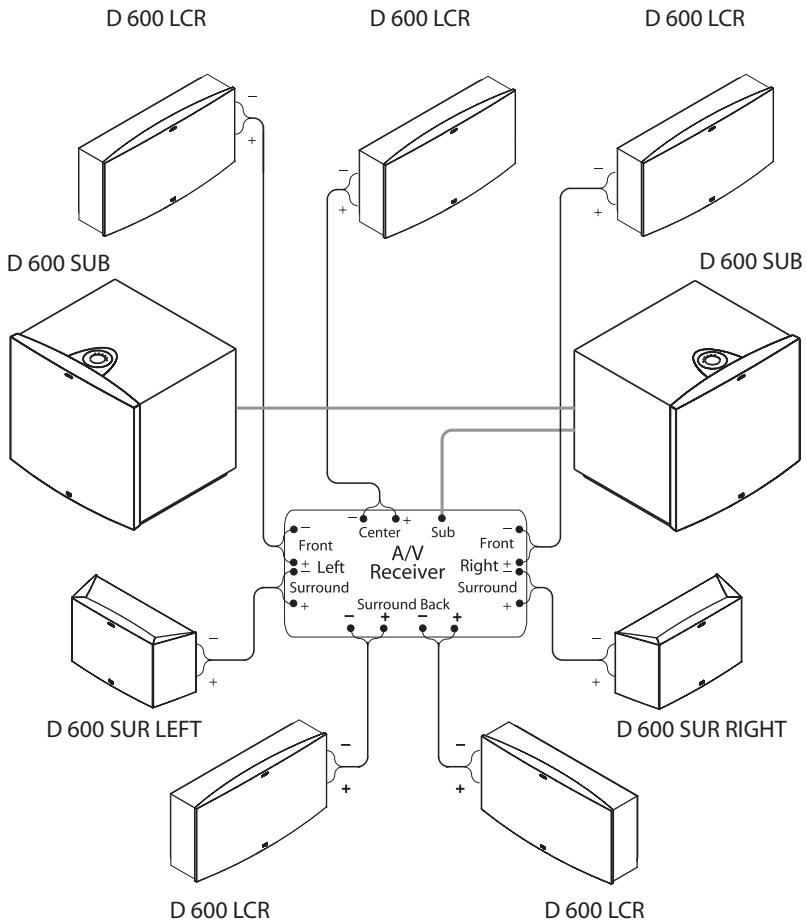

# 6

## D 600 SUB

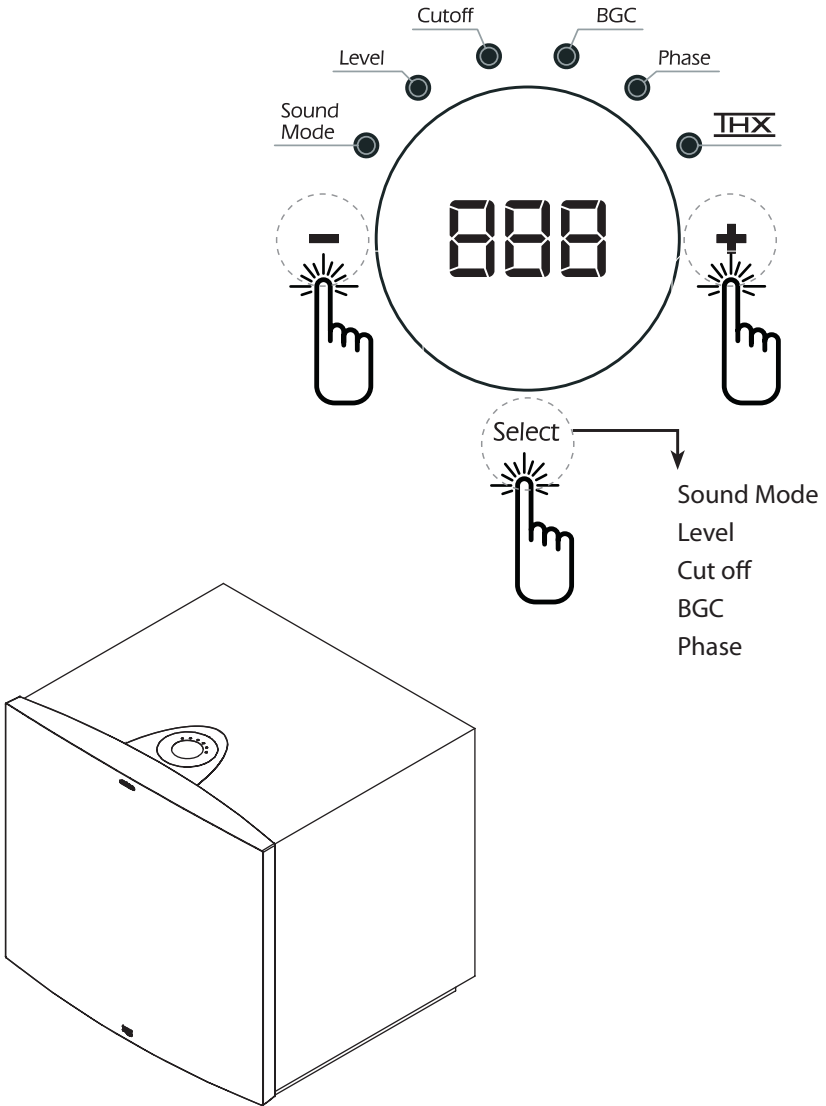

## D 600 SUB: Sound Mode

### Default (DEF)

Level	2
Cut off	80
BGC	OFF
Phase	0

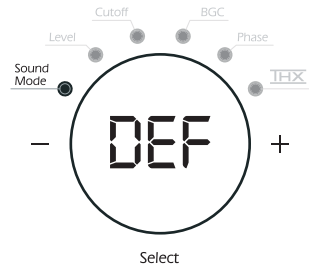

### Personal (PER)

Level	-20 → 16
Cut off	40 → 200
BGC	OFF → MAX
Phase	0 → -180

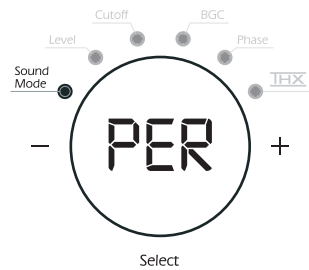

### THX

Level	0
Cut off	200
BGC	0 → MAX
Phase	0 → -180

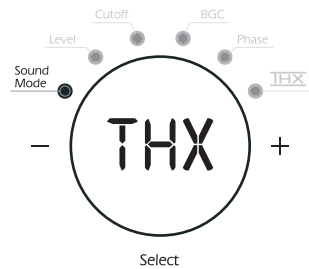

# D 600 SUB: Sound Mode **PER**

1

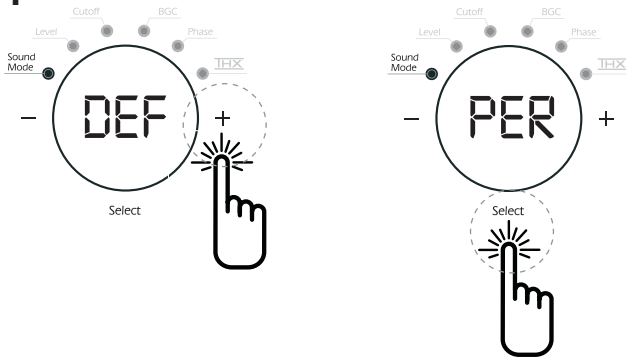

2

Adjust:

Level	Page 15
Cut off	Page 16
BGC	Page 17
Phase	Page 18

3

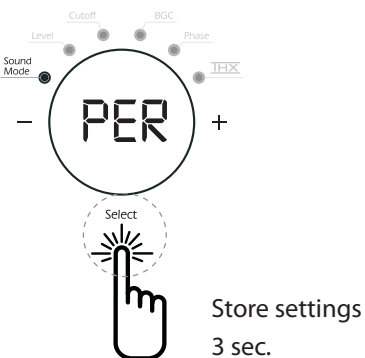

# D 600 SUB: Sound Mode THX

1

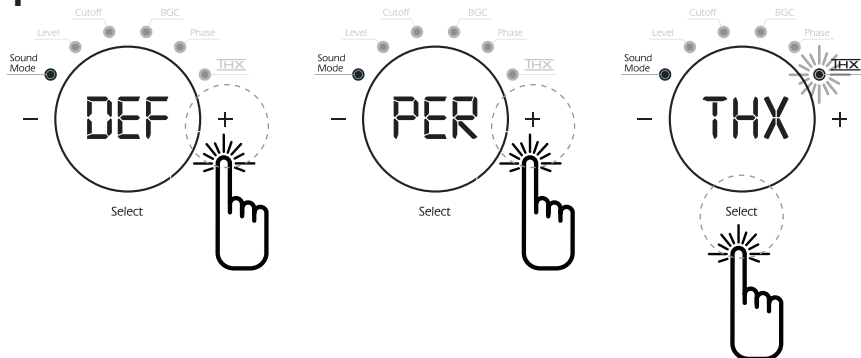

2

Adjust:

BGC Page 17

Phase Page 18

3

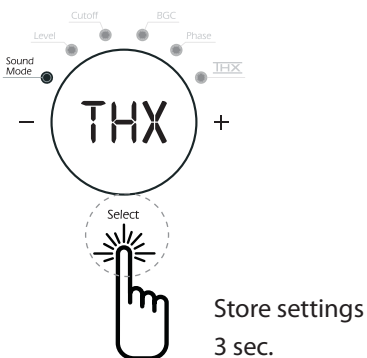

# D 600 SUB: Level

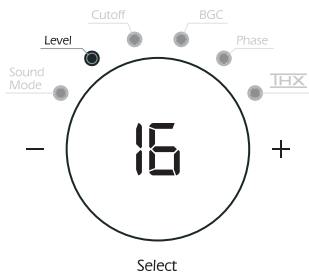
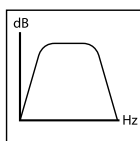
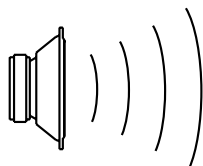
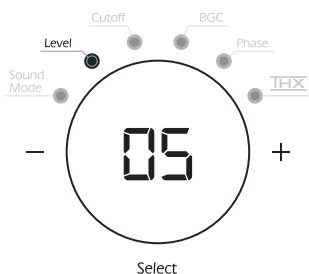
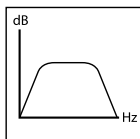
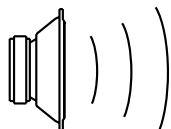
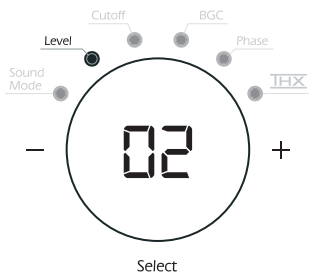
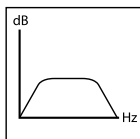
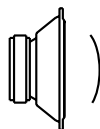
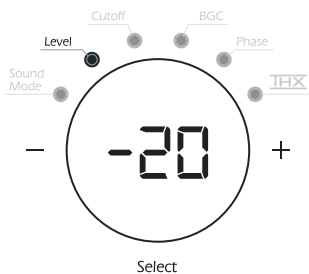

# D 600 SUB: Cut off

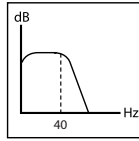
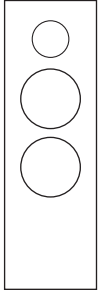
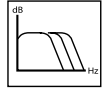

Cutoff BGC Phase  
Level  
Sound Mode  
- 40 +  
Select

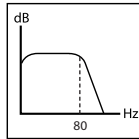
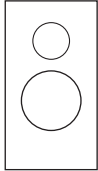

Cutoff BGC Phase  
Level  
Sound Mode  
- 80 +  
Select

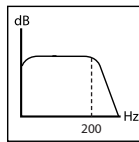
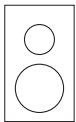

Cutoff BGC Phase  
Level  
Sound Mode  
- 200 +  
Select



# D 600 SUB: BGC

(Boundary Gain Compensation)

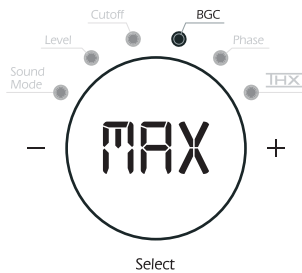
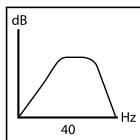
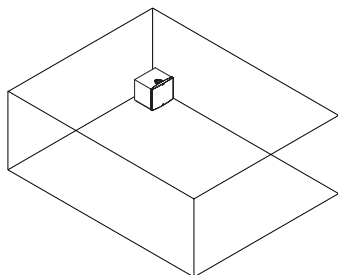
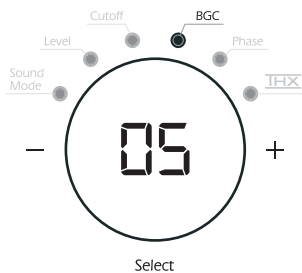
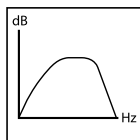
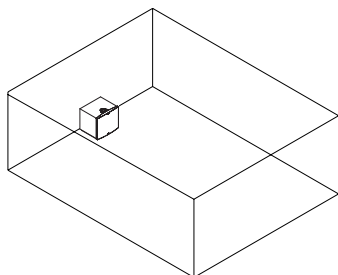
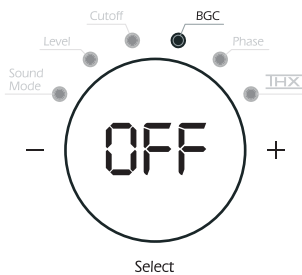
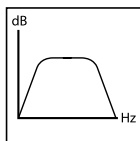
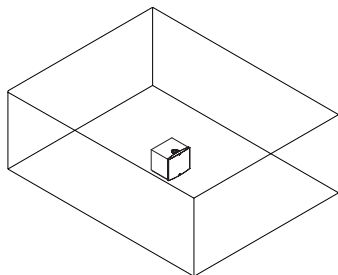

# D 600 SUB: Phase

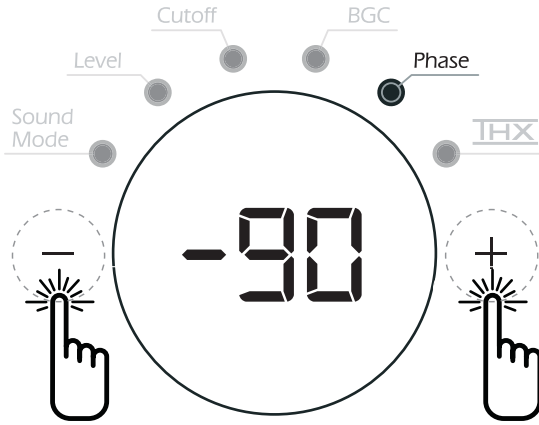
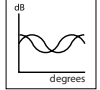

Select

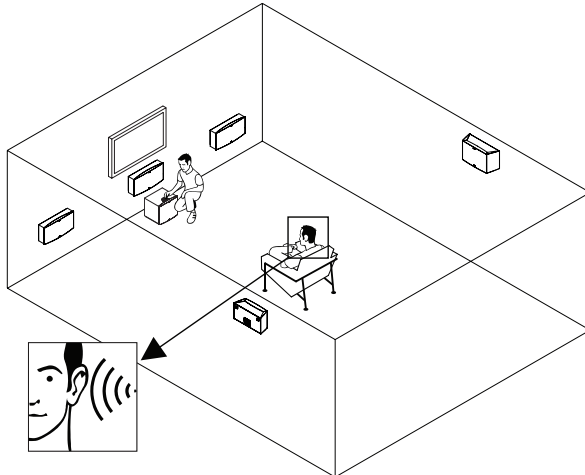

# 7 D 600 specifications

<b>Specifications</b> .....	<b>D 600 SUB</b>
System .....	Active DSP based subwoofer, sealed enclosure. Motional feedback
User interface.....	Touch panel with backlight
Woofers (mm / in).....	380 / 15
Rated power (Wrms) .....	600 @4ΩTHD+N <1%
Dynamic power (Wrms) .....	800 @4Ω
Peak power (Wpk).....	1600 @4Ω
Maximum SPL (dB).....	109
Frequency range (Hz).....	20 - 200
Variable cut off (Hz) .....	40 - 200
Phase (deg.) .....	0 to -180
BGC.....	Variable
Line input .....	Yes, stereo pass through for daisy chain
LFE input.....	Yes, pass through for daisy chain
Speaker level input .....	Yes
Sensitivity (mVrms).....	100
Sound modes.....	Default. Personal. THX
12V trigger .....	Yes, pass through for daisy chain.
Mains switch.....	On / Off
Voltage switch (fuse).....	115V/60Hz (6.3A) / 230V/50Hz (3.15 A)
Auto enable switch .....	Off / Auto / On
Dimension (mm / in) .....	557 x 587 x 501 / 21.9 x 23.1 x 19.7
Weight (kg / lb).....	32 / 70.5
Finish.....	Stone Grey

<b>Specifications</b> .....	<b>D 600 LCR</b>
System .....	3 Way closed
Woofers (mm / in).....	2 x 165 / 6½
Midrange (mm / in).....	2 x 76 / 3
Tweeter (mm / in) .....	25 / 1 DTT
Power (W, long / short term).....	200 / 300
Sensitivity (dB/2,8V/1m) .....	89
Frequency Range (Hz).....	80 - 20.000
Cross-over Frequency (Hz).....	400 / 2.500
Impedance (Ohm) .....	4
Weight (Kg / lb) .....	13 / 28.6
Dimension HxWxD (mm / in) .....	315 x 600 x 170 / 12.4 x 23.6 x 6.7
Finish.....	Stone Grey

<b>Specifications</b> .....	<b>D 600 SUR</b>
System .....	3 Way closed dipole
Woofers (mm / in).....	1 x 165 / 6½
Midrange (mm / in).....	2 x 76 / 3
Tweeter (mm / in) .....	2 x 25 / 1 DTT
Power (W, long / short term) .....	150 / 200
Sensitivity (dB/2,8V/1m) .....	87
Frequency Range (Hz).....	80 - 20.000
Cross-over Frequency (Hz).....	250 / 2.500
Impedance (Ohm) .....	4
Weight (Kg / lb) .....	9 / 19.8
Dimension HxWxD (mm / in) .....	255 x 454 x 170 / 10 x 17.8 x 6.7
Finish.....	Stone Grey

Two D 600 SUB will meet THX Ultra2 output levels. THX and theTHX logo are trademarks of THX Ltd. which may be registered in some jurisdictions. All rights reserved.

We Klipsch Group, Inc.  
 Of 3502 Woodview Trace, Suite 200  
 Indianapolis, IN 46268 USA

Declare that

Equipment: Passive Home Audio Speakers  
 Model Name: Jamo D 600 LCR, Jamo D 600 SUR

In accordance with the following Directives:

89/336/EEC & The Electromagnetic Compatibility Directive  
 2004/108/EC and its amending Directives

has been designed and manufactured to comply with the following specifications:

EN55013: 2001 Sound and television broadcast receivers and associated equipment  
 – Radio disturbance characteristics – Limits and methods of  
 measurements

EN55020: 2002 Sound and television broadcast receivers and associated equipment  
 –Immunity Characteristics – Limits and methods of measurements

I hereby declare that the equipment named above has been designed to comply with the relative sections of the above reference specifications. The unit complies with all essential requirements of the Directives.

Signature: *Kerry Geist*

Name: Kerry Geist

Position: Vice President of Engineering

Klipsch Group, Inc.  
 3502 Woodview Trace, Suite 200  
 Done At: Indianapolis, IN 46268 USA

On date: 6/19/09

CE09

KLIPSCH AUDIO TECHNOLOGIES  
 3502 WOODVIEW TRACE, SUITE 200  
 INDIANAPOLIS, IN 46268 USA

KLIPSCH EUROPEBV  
 40 CHEVENING ROAD  
 LONDON, NW6, 6DE ENGLAND

We Klipsch Group, Inc.  
Of 3502 Woodview Trace, Suite 200  
Indianapolis, IN 46268 USA

Declare that

Equipment: Powered Subwoofer - Speaker /Audio Amplifier

Model Name: Jamo D 600 SUB

In accordance with the following Directives:

2004/108/EC The Low Voltage Directive  
and its amending Directives

2004/108/EC The Electromagnetic Compatibility Directive  
and its amending Directives

has been designed and manufactured to comply with the following specifications:

EN60065: 2002 Audio, Video and Similar Electronic Apparatus – Safety requirements

EN55013: 2001 Sound and television broadcast receivers and associated equipment – Radio  
disturbance characteristics – Limits and methods of measurements

EN55020: 2002 Sound and television broadcast receivers and associated equipment –Immunity  
Characteristics – Limits and methods of measurements

EN61000-3-2: 2000 Electromagnetic Compatibility Part 3. Limits Section 2. Limits for harmonic current  
emissions (equipment input current #16A per phase)

EN61000-3-3: 1995 Electromagnetic Compatibility Part 3. Limits Section 3. Limits for voltage fluctuations  
and flicker in low-voltage supply systems for equipment with rated current #16A

I hereby declare that the equipment named above has been designed to comply with the relative sections  
of the above reference specifications. The unit complies with all essential requirements of the Directives.

Signature: *Kerry Geist*

Name: Kerry Geist

Position: Vice President of Engineering

Klipsch Group, Inc.  
3502 Woodview Trace, Suite 200  
Indianapolis, IN 46268 USA

Revised: 6/19/09



KLIPSCH AUDIO TECHNOLOGIES  
3502 WOODVIEW TRACE, SUITE 200  
INDIANAPOLIS, IN 46268 USA

KLIPSCH EUROPEBV  
INDUSTRIESTRAAT 1  
7041 GD 's-HEERENBERG, NETHERLANDS

**FCC AND CANADA EMC COMPLIANCE INFORMATION:**

NOTE: This equipment has been tested and found to comply with the limits for a Class B digital device, pursuant to part 15 of the FCC Rules. These limits are designed to provide reasonable protection against harmful interference in a residential installation. This equipment generates, uses and can radiate radio frequency energy and, if not in-stalled and used in accordance with the instructions, may cause harmful interference to radio communications. However, there is no guarantee that interference will not occur in a particular installation. If this equipment does cause harmful interference to radio or television reception, which can be determined by turning the equipment off and on, the user is encouraged to try to correct the interference by one or more of the following measures:

- Reorient or relocate the receiving antenna.
- Increase the separation between the equipment and receiver.
- Connect the equipment into an outlet on a circuit different from that to which the receiver is connected.
- Consult the dealer or an experienced radio/TV technician for help.

Approved under the verification provision of FCC Part 15 as a Class B Digital Device.

Caution: Changes or modifications not expressly approved by the manufacturer could void the user's authority to operate this device.

This Class B digital apparatus complies with Canadian ICES-003.  
Cet appareil numérique de la classe B est conforme à la norme NMB-003 du Canada.

# English

## The scope of the warranty

**Service.** In case of warranty enquiries, please contact your dealer/installer. In case of request for service under warranty, please enclose your original receipt and make sure that the serial number on the product is readable. *Important:* Never send the product to be repaired without the prior agreement of your dealer. The product must always be packed properly. If the product is NOT UNDER WARRANTY, all costs including without limit costs of repair and freight must be paid for by the customer.

### Terms of Warranty

1. Nothing in this warranty shall limit your statutory rights.
2. The warranty is only valid on presentation of the original sales receipt or other valid proof of purchase, and provided that the serial number on the product is fully legible.
3. Warranty repairs must be carried out by an authorised Jamo dealer, or an authorised service centre. No payment will be made for repairs performed by unauthorised persons. This warranty does not extend to products which have been repaired or otherwise altered by unauthorised persons, and any damage to the product caused by work by unauthorised persons is not covered by this warranty.
4. This product will not be considered defective, either in materials or in manufacture, to the extent that faults are caused by adaptation to national, local, technical or safety related requirements in countries other than the specific country where the product was purchased.
5. Jamo shall at its option during the relevant warranty period either repair or replace defective components. If the component repair or replacement cannot be performed, the product will be replaced.
6. In no circumstances shall Jamo be liable in contract, tort (including negligence) or breach of statutory duty or otherwise for loss of profits, loss of revenue, loss of data, loss of business or loss of anticipated savings or for any consequential loss whatever.
7. The warranty does not cover the following:
  - a) Periodic inspection, maintenance and repair or replacement of parts resulting from normal wear and tear.
  - b) Costs connected to delivery to the dealer, disassembly or re-installation of the product.
  - c) Misuse, including use for purposes other than was intended, or faulty installation.
  - d) Damage caused by lightning, water, fire, natural catastrophes, war, insurrection, incorrect line voltage, insufficient ventilation, transport or other causes outside of the control of Jamo.
8. This warranty applies to every legal owner of the product during the warranty period.

# Français

## Couverture de la garantie

**Service.** Veuillez contacter votre fournisseur/installateur pour toute question relative à la garantie. Si vous souhaitez faire appel à la garantie, veuillez joindre à votre demande l'original de votre récépissé et vous assurer que le numéro de série figurant sur le produit soit bien lisible. *Important:* N'envoyez jamais votre produit en réparation sans l'accord préalable de votre fournisseur. Le produit doit toujours être correctement emballé. Si le produit N'EST PAS SOUS GARANTIE, tous les frais d'envoi et de réparation seront à la charge du consommateur, sans aucune limite de somme.

### Conditions de garantie

1. Rien dans cette garantie ne saurait limiter vos droits en tant que consommateur.
2. La garantie n'est valable que sur présentation du récépissé de vente original ou sur présentation de toute autre preuve d'achat et sous réserve que le numéro de série figurant sur le produit soit parfaitement lisible.
3. Les réparations couvertes par la garantie doivent être effectuées par un fournisseur agréé de Jamo ou par un centre de service agréé. Les réparations effectuées par des personnes non agréées ne seront pas remboursées. La garantie ne s'étend pas aux produits qui ont été réparés ou altérés d'une quelconque manière par des personnes non agréées et ne couvre aucune détérioration du produit causée par le fait de personnes non agréées.
4. Ce produit ne sera pas considéré comme défectueux sur le plan matériel ou de la fabrication si les défauts sont consécutifs à leur adaptation à des normes nationales, locales, techniques ou de sécurité en vigueur dans des pays autres que celui où le produit a été vendu.
5. Jamo pourra, à son appréciation, réparer ou remplacer les pièces défectueuses durant la période couverte par la garantie. En cas d'impossibilité de réparation ou de remplacement de la pièce défectueuse, le produit sera échangé.
6. Jamo ne saurait être en aucun cas responsable des manques à gagner, des pertes de chiffre d'affaires, de données, d'épargne ou de toute autre préjudice indirect découlant d'une violation des stipulations contractuelles, des dispositions légales ou d'un délit (négligences incluses).
7. La garantie ne couvre pas les cas suivants :
  - a) Révisions périodiques, maintenance, réparation ou remplacement de pièces liées à l'usure normale du produit.
  - b) Coûts relatifs à la livraison au fournisseur, au démontage ou à la réinstallation du produit.
  - c) Mauvaise utilisation du produit, y compris à des fins autres que l'utilisation prévue, ou mauvaise installation.
  - d) Dégâts causés par la lumière, l'eau, le feu, les catastrophes naturelles, la guerre, une insurrection, une surtension, une ventilation insuffisante, le transport ou d'autres causes indépendantes de la volonté de Jamo.
8. Cette garantie s'applique à tout propriétaire légal du produit durant la période de garantie.



# Deutsch

## Garantieumfang

**Service.** Wenden Sie sich bei Garantie-Anfragen bitte an Ihren Händler/Installationsfachmann. Bei Service-Anfragen im Rahmen der Garantie legen Sie bitte Ihre Originalquittung bei und sorgen Sie dafür, dass die Seriennummer auf dem Produkt lesbar ist. *Wichtig:* Senden Sie auf keinen Fall ohne die Zustimmung Ihres Händlers ein Produkt zur Reparatur ein. Das Produkt muss immer ordnungsgemäß verpackt sein. Wenn sich das Produkt NICHT MEHR INNERHALB DES GARANTIEZEITRAUMS befindet, sind sämtliche Kosten einschließlich Reparaturkosten und Fracht (ohne Begrenzung) vom Kunden zu zahlen.

### Garantiebedingungen

1. Keine der Bestimmungen dieser Garantiebedingungen stellt eine Einschränkung Ihrer Ihnen nach dem Gesetz verliehenen Rechte dar.
2. Die Garantie ist nur bei Vorlage der Original-Kaufquittung oder eines anderen gültigen Kaufbelegs gültig sowie unter der Voraussetzung, dass die Seriennummer auf dem Produkt vollständig lesbar ist.
3. Reparaturen im Rahmen der Garantie müssen von einem autorisierten Jamo Händler oder einem autorisierten Kundendienst-Center durchgeführt werden. Es werden keine Zahlungen für Reparaturen geleistet, die von nichtautorisierten Personen durchgeführt wurden. Diese Garantie erstreckt sich nicht auf Produkte, die von nichtautorisierten Personen repariert oder anderweitig verändert worden sind und jedwede Beschädigung des Produkts, die durch die Arbeiten nichtautorisierter Personen hervorgerufen wird, wird von dieser Garantie nicht abgedeckt.
4. Dieses Produkt wird insofern als nicht fehlerhaft betrachtet, sowohl im Hinblick auf Material- wie auch auf Verarbeitungsfehler, als die Fehler durch die Anpassung an nationale, lokale, technische oder sicherheitsbezogene Anforderungen in anderen Ländern als in dem Land, in dem das Produkt gekauft wurde, verursacht wurden.
5. Jamo wird die schadhafte(n) Komponente(n) nach eigenem Ermessen während des jeweiligen Garantiezeitraums entweder reparieren oder austauschen. Wenn die Reparatur bzw. der Austausch der Komponente nicht durchgeführt werden kann, wird das Produkt ersetzt.
6. Unter keinen Umständen wird Jamo vertraglich oder im Fall einer unerlaubten Handlung (einschließlich Fahrlässigkeit) oder bei Verletzung einer gesetzlichen Verpflichtung oder anderweitig für den Verlust von Gewinnen, Einkünften, Daten, Geschäftsmöglichkeiten oder den Verlust erwarteter Einsparungen oder jedweden Folgeverlust haftbar sein.
7. Diese Garantie erstreckt sich nicht auf folgende Punkte:
  - a) Regelmäßige Inspektion, Wartung und Reparatur oder Austausch von Teilen aufgrund von normalem Verschleiß.
  - b) Kosten im Zusammenhang mit der Lieferung an den Händler, der Demontage oder dem Wiedereinbau des Produktes.
  - c) Missbräuchliche Verwendung einschließlich der Verwendung für andere als die beabsichtigten Zwecke oder fehlerhafte Installation.
  - d) Schäden infolge von Blitzschlag, Wasser, Feuer, Naturkatastrophen, Krieg, Aufständen, nicht korrekter Netzspannung, unzureichender Belüftung, Transport oder anderen Ursachen, auf die Jamo keinen Einfluss hat.
8. Diese Garantie gilt für jeden rechtmäßigen Eigentümer des Produktes während des Garantiezeitraums.

# Dansk

## Garantiens omfang

**Service.** I tilfælde af spørgsmål vedr. garantien kontaktes forhandleren/installatøren. I tilfælde af anmodning om service i henhold til garantien skal den originale kvittering vedlægges, og man skal sikre, at produktets serienummer er læseligt. *Vigtigt:* Send aldrig produktet til reparation uden forudgående aftale med forhandleren. Produktet skal altid være korrekt emballeret. Hvis produktet IKKE ER DÆKKET AF GARANTI, betaler kunden alle omkostninger, inklusive uden begrænsning omkostningerne i forbindelse med reparation og forsendelse.

### Garantibetingelser

1. Intet i denne garanti påvirker dine lovbestemte rettigheder.
2. Garantien er kun gyldig ved fremlæggelse af den originale salgskvittering eller andet gyldigt bevis på købet, og forudsat at produktets serienummer er fuldt ud læseligt.
3. Garantireparationer skal udføres af en autoriseret Jamo-forhandler eller et autoriseret servicecenter. Der betales ikke for reparationer, der udføres af uautoriserede personer. Denne garanti gælder ikke for produkter, der er repareret eller på anden måde ændret af uautoriserede personer, og evt. beskadigelse af produktet som følge af arbejde udført af uautoriserede personer dækkes ikke af denne garanti.
4. Dette produkt anses ikke for at være fejlbehæftet hverken med hensyn til materialer eller produktion, såfremt fejlen skyldes tilpasning til nationale, lokale, tekniske eller sikkerhedsrelaterede krav i andre lande end det specifikke land, hvor produktet er købt.
5. Jamo vil efter eget valg i den pågældende garantiperiode enten reparere eller udskifte fejlbehæftede komponenter. Hvis komponenten ikke kan repareres eller udskiftes, vil produktet blive uskiftet.
6. Jamo er under ingen omstændigheder erstatningspligtig inden for kontrakt, uden for kontrakt (herunder forsømmelse) eller for misligholdelse af lovbefæstet pligt eller på anden måde med hensyn til nogen form for driftstab, tab af indtægt, tab af data, omsætningstab eller tab af forventet opsparing eller for evt. tab af fortjeneste.
7. Garantien dækker ikke følgende:
  - a) Periodisk inspektion, vedligeholdelse og reparation eller udskiftning af dele som følge af almindelig slitage.
  - b) Omkostninger i forbindelse med levering til forhandleren, demontering eller geninstallering af produktet.
  - c) Forkert anvendelse, herunder til andre formål end det tiltænkte, og forkert installation.
  - d) Skader, der skyldes lynnedslag, vand, brand, naturkatastrofer, krig, oprør, forkert netspænding, utilstrækkelig ventilation, transport eller andet, som Jamo ikke er herre over.
8. Denne garanti gælder for alle lovlige ejere af produktet under garantiperioden.

# Svenska

## Garantins omfattning

**Service.** Vid frågor gällande garantin, kontakta din återförsäljare/installatör. Vid servicebegäran under garantitiden, bifoga ditt originalkvitto och se till att serienumret på produkten går att läsa. *Viktigt:* Skicka aldrig den produkt som ska repareras utan föregående överenskommelse med din återförsäljare. Produkten måste alltid förpackas korrekt. Om produktgarantin HAR UPPHÖRT ATT GÄLLA betalar kunden själv samtliga kostnader i samband med reparation och frakt.

### Garantivillkor

1. Ingenting i dessa garantivillkor påverkar de rättigheter du har enligt tvingande lag.
2. Garantin gäller endast mot uppvisande av originalkvitto eller annat giltigt köpbevis, samt förutsatt att produktens serienummer är fullt läsbart.
3. Garantireparationer måste utföras av en auktoriserad Jamo-återförsäljare eller ett auktoriserat servicecenter. Ingen ersättning utgår för reparationer som utförts av ej auktoriserade personer. Denna garanti täcker inte produkter som har reparerats eller på annat sätt ändrats av ej auktoriserade personer. Skador på produkten till följd av arbete utfört av ej auktoriserade personer omfattas inte av denna garanti.
4. Produkten anses inte defekt, i material eller tillverkning, i den mån felet orsakats av anpassning till nationella, lokala, tekniska eller säkerhetsrelaterade krav i andra länder än det land där produkten köptes.
5. Jamo kommer efter fritt val att antingen reparera eller ersätta defekta komponenter under den aktuella garantiperioden. Produkten ersätts i sin helhet om komponenten inte kan repareras eller ersättas.
6. Under inga omständigheter, oavsett om det grundar sig på avtal, kränkning (inklusive försumlighet) eller brott mot tvingande förpliktelser, ansvarar Jamo för förlust av vinst eller intäkt, förlust av information, uteblivna affärsmöjligheter eller förlust av förväntade besparingar eller för någon form av följdförlust över huvudtaget.
7. Garantin täcker inte:
  - a) Regelbunden inspektion, underhåll och reparation eller ersättning av delar till följd av normalt slitage.
  - b) Kostnader i samband med leverans till återförsäljaren, isärmontering eller återinstallation av produkten.
  - c) Felaktig användning, inklusive användning för ändamål andra än de avsedda, eller felaktig installation.
  - d) Skador orsakade av åska, vatten, brand, naturkatastrofer, krig, uppror, felaktig linjespänning, otillräcklig ventilation, transport eller andra omständigheter utanför Jamos kontroll.
8. Denna garanti gäller varje laglig ägare av denna produkt under garantiperioden.

# Suomi

## Takuuehdot

**Huoltopalvelu.** Ota takuuasioissa yhteys laitteen myyjään tai asennusliikkeeseen. Huoltotilaukseen pitää liittää laitteen alkuperäinen ostokuitti ja sarjanumero. *Tärkeää:* Älä lähetä laitetta huollettavaksi ennenkuin olet sopinut asiasta myyjän kanssa. Laite pitää pakata asianmukaisesti kuljetuksia varten. Jos TAKUU EI OLE VOIMASSA, asiakas vastaa kaikista huolto- ja rahtikustannuksista.

### Takuuehdot

1. Tämä takuu ei rajoita asiakkaan lakisääteisiä oikeuksia.
2. Takuun voimassaolo edellyttää alkuperäisen ostokuitin tai muun pätevän hankintatodistuksen esittämistä. Myös laitteen sarjanumeron tulee olla asianmukaisesti tarkastettavissa.
3. Takuukorjaukset saa tehdä vain valtuutettu Jamo-kauppias tai -huoltopalvelu. Takuu ei korvaa valtuuttamattoman tahon tekemiä korjauksia. Takuu ei ole voimassa, jos valtuuttamaton taho on korjannut, muuttanut tai viottanut laitetta.
4. Eri maiden yleiset, paikalliset, tekniset ja turvallisuuteen liittyvät vaatimukset saattavat erota toisistaan. Jos laitetta käytetään muussa kuin hankintamaassa, vaatimusten eroista johtuvat puutteet eivät ole materiaali- tai valmistusvikoja.
5. Takuuaikana Jamo korjaa tai vaihtaa viallisen osan oman harkintansa mukaan. Jos osaa ei voi korjata eikä vaihtaa, asiakas saa uuden laitteen.
6. Jamo ei ole vastuussa voiton, tulojen tai ennakoitujen säästöjen menetyksestä, tiedon häviämisestä, liiketoiminnan estymisestä tai muista välillisistä vahingoista.
7. Takuu ei korvaa seuraavia asioita:
  - a) Määräaikaistarkastukset tai normaalista kulumisesta aiheutuvat huollot, korjaukset tai osien vaihdot.
  - b) Asiakkaan ja myyjän välisen rahdin sekä laitteen irrottamisen tai asentamisen aiheuttamat kustannukset.
  - c) Epäasiallisesta käytöstä, väärästä käyttötarkoituksesta tai virheellisestä asennuksesta aiheutuvat ongelmat.
  - d) Salamasta, vedestä, tulesta, luonnononnettomuudesta, sodasta, kapinasta, väärästä jännitteestä, riittämättömästä ilmankierrosta, kuljetuksesta tai muusta asiasta aiheutuvat ongelmat, joihin Jamo ei voi vaikuttaa.
8. Takuuta voi hyödyntää takuuajana laitteen laillinen omistaja.

# Español

## Alcance de la garantía

**Servicio.** Para cualquier consulta sobre la garantía, póngase en contacto con su distribuidor o instalador. En caso de solicitar intervenciones de servicio en garantía, sírvase incluir la factura o comprobante original de compra. *Importante:* no envíe nunca el producto a reparar sin haberlo acordado previamente. El producto deberá ir siempre bien embalado; de lo contrario, la garantía quedará sin efecto. Si el producto NO ESTÁ EN PERIODO DE GARANTÍA, todos los costes correrán a cargo del cliente.

### Condiciones de la garantía

1. Ningún punto de esta garantía limitará sus derechos legales.
2. La garantía únicamente será válida si se presenta la factura u otro comprobante original de la compra y el número de serie del producto es perfectamente legible.
3. Las reparaciones en garantía deben ser efectuadas por un distribuidor autorizado de Jamo o por un centro de servicio autorizado. No se proporcionará remuneración alguna en concepto de reparaciones efectuadas por personas o talleres no autorizados. Esta garantía no cubre ningún tipo de reparación, desperfecto o alteración del producto producidos por intervenciones de personas o talleres no autorizados.
4. Este producto no será considerado defectuoso, ya sea en materiales o en fabricación, si fuera necesario adaptarlo a la normativa nacional, local, técnica o de seguridad vigente en países distintos del país donde el producto fue adquirido.
5. Durante el período de garantía, las obligaciones de Jamo se limitan a la reparación o sustitución de los componentes defectuosos. La elección entre reparación o sustitución de dichos componentes defectuosos queda a discreción de Jamo. Únicamente se sustituirá un equipo por otro en el caso en que no sea posible la reparación.
6. Jamo no será, bajo ninguna circunstancia, responsable contractual (incluida la negligencia) del incumplimiento de las normativas o de cualesquiera pérdidas de beneficios, lucro cesante, pérdidas de datos, pérdidas de contratos, ni de daños de cualquier clase, ni de sus perjuicios consiguientes.
7. La garantía no cubre:
  - a) Revisiones periódicas, mantenimiento y reparación o sustitución de componentes como consecuencia del normal uso y desgaste.
  - b) Costes relativos al transporte, desmontaje o reinstalación del producto.
  - c) Uso indebido, incluidos el uso para fines distintos a los previstos y la instalación incorrecta.
  - d) Daños producidos por rayos, inundaciones, incendios, catástrofes naturales, guerras, insurrecciones, tensión eléctrica incorrecta, ventilación insuficiente, transporte u otras causas que escapen al control de Jamo.
8. Esta garantía es aplicable a cualquier propietario legal del producto durante el periodo de vigencia de la garantía.

# Italiano

## Garanzia

**Assistenza** Per informazioni sulla garanzia, contattare il rivenditore/installatore. In caso di richiesta di assistenza in garanzia, allegare alla domanda lo scontrino fiscale comprovante l'acquisto e assicurarsi che il numero di matricola presente sul prodotto sia leggibile. *Importante:* Non spedire mai il prodotto da riparare senza aver prima preso accordi con il rivenditore. Il prodotto deve essere imballato adeguatamente. Se il prodotto NON è più in garanzia, tutti i costi, incluso, senza limitazioni, i costi di riparazione e trasporto, sono a carico del cliente.

### **Termini e condizioni della garanzia**

1. La presente garanzia non limita in alcun modo i diritti del consumatore stabiliti dalla legge.
2. La garanzia è valida soltanto dietro presentazione dello scontrino o di ogni altra valida prova d'acquisto e se il numero di matricola presente sul prodotto è perfettamente leggibile.
3. Le riparazioni coperte dalla garanzia devono essere effettuate esclusivamente da un rivenditore o da un centro di assistenza autorizzato Jamo. Le riparazioni effettuate da personale non autorizzato non verranno rimborsate. La presente garanzia non si estende ai prodotti riparati o in qualunque modo alterati da personale non autorizzato, né copre alcun danno originato dall'intervento di personale non autorizzato.
4. Il prodotto non sarà considerato difettoso, né per materiali né per fabbricazione, se tali difetti derivano dall'adattamento del prodotto ai requisiti tecnici o di sicurezza nazionali o locali in paesi diversi da quello in cui il prodotto è stato acquistato.
5. Nel periodo di validità della garanzia, Jamo deciderà a sua discrezione se riparare o sostituire i componenti difettosi. Se non sarà possibile riparare o sostituire il componente difettoso, il prodotto verrà sostituito.
6. In nessun caso Jamo potrà essere ritenuta responsabile per inadempimento contrattuale, atto illecito (negligenza inclusa) o violazione di un obbligo imposto dalla legge, né per perdite di profitto, di reddito, di dati, di affari, di risparmi attesi o di una qualsiasi perdita indiretta di qualsivoglia natura.
7. La garanzia non copre:
  - a) Controlli periodici, manutenzione, riparazione o sostituzione di componenti danneggiati dalla normale usura.
  - b) Spese per la restituzione del prodotto difettoso al rivenditore oppure per lo smontaggio o la reinstallazione del prodotto.
  - c) Uso errato, incluso l'uso per scopi diversi da quello a cui il prodotto è destinato, o errata installazione.
  - d) Danni indotti da fulmini, acqua, incendi, catastrofi naturali, guerra, insurrezioni, errata tensione di linea, ventilazione insufficiente, trasporto o altre cause che esulano dal controllo di Jamo.
8. La presente garanzia si intende valida per tutti i legittimi proprietari del prodotto durante il periodo di garanzia.

# Nederlands

## Garantievoorwaarden

**Service.** Neem voor vragen over de garantie contact op met uw dealer/installateur. Stuur bij serviceverzoeken volgens de garantie altijd uw originele bon mee en zorg ervoor dat het serienummer op het product leesbaar is. *Belangrijk:* stuur het product nooit op voor reparatie zonder voorafgaande toestemming van uw dealer. Het product moet altijd goed verpakt zijn. Als het product NIET ONDER DE GARANTIE valt, zijn alle kosten, niet beperkt tot de kosten voor reparatie en verzending, voor rekening van de klant.

### Garantiebepalingen

1. Niets in deze garantiebepalingen beperkt uw statutaire rechten.

2. De garantie is alleen geldig op vertoon van de originele aankoopbon of een ander geldig bewijs van aankoop, onder voorwaarde dat het serienummer op het product volledig leesbaar is.

3. Reparaties volgens de garantie moeten worden uitgevoerd door een geautoriseerde Jamo dealer of een geautoriseerd servicecentrum. Reparaties die zijn uitgevoerd door ongeautoriseerde personen worden niet vergoed. Deze garantie geldt niet voor producten die zijn gerepareerd of anderszins zijn aangepast door ongeautoriseerde personen en enige schade aan het product die is ontstaan als gevolg van het werk van ongeautoriseerde personen wordt niet gedekt door de garantie.

4. Dit product wordt niet beschouwd als defect, noch qua materieel noch op het gebied van fabricage, als het gaat om storingen die het gevolg zijn van aanpassingen wegens landelijke, lokale, technische of veiligheidseisen in landen anders dan het specifieke land waar het product is gekocht.

5. Jamo zal tijdens de betreffende garantieperiode naar eigen inzicht defecte onderdelen repareren of vervangen. Als reparatie of vervanging van het onderdeel niet mogelijk is, zal het product worden vervangen.

6. In geen enkel geval is Jamo aansprakelijk als gevolg van een contract, een onrechtmatige daad (waaronder nalatigheid) of een schending van statutaire plichten of anderszins, voor verlies van winst, inkomstenderving, verlies van gegevens, verlies van handel of verlies van verwachte besparingen of enige andere vorm van gevolgschade.

7. De volgende zaken worden niet gedekt door de garantie:

- a) Periodieke inspectie, onderhoud en reparatie of vervanging van onderdelen als gevolg van normale gebruiksslijtage.
- b) Kosten voor aflevering bij de dealer, demontage of herinstallatie van het product.
- c) Onoordeelkundig gebruik, waaronder gebruik voor andere doeleinden dan die waarvoor het product bestemd is of ondeugdelijke installatie.
- d) Schade die is veroorzaakt door bliksem, water, vuur, natuurrampen, oorlog, oproer, incorrecte lichtnetspanning, onvoldoende ventilatie, transport of andere oorzaken waarop Jamo geen invloed heeft.

8. Deze garantie geldt voor elke legale eigenaar van het product gedurende de garantieperiode.

# 中文

## 保修范围

### 服务

如有保修咨询，请和我们的经销商联系。如保修期内有服务要求，请保存好您的原始凭证并确保产品上的序列号清晰可见。重要：千万不要没有和经销商预定就将维修的产品送修。

用户不能自行拆机，否则不能提供保修服务。超过保修期限的产品，由用户支付全部费用。

### 保修条例：

1. 本保修条例不限制您的法定权限。
2. 只有凭有效的原始销售凭证或者其他有效的购买证明，以及产品上的序列号完全清晰可见，才可享受保修。
3. 保修必须由尊宝认证的经销商或者认证的服务中心进行执行。对于非认证工场的维修将不支付任何报酬。任何由非认证处维修或损坏的产品不在保修范围之列。
4. 如果在一些国家，由于为了国家、当地的技术或者安全方面的需求而做的改造，不同于产品原始设计和制造的特定国家的要求，这样的产品将认为不是在材料和制造上的缺陷。
5. 尊宝对于保修期内的产品的维修或者更换有缺陷组件。如果组件维修或者更换仍然不能修复，将更换产品。
6. 在任何情况下，尊宝都不承担合同，侵权（包括疏忽）或违背法律方面的责任，也不承担利润损失，营业额损失，数据丢失，业务损失或者存储内容丢失及任何有关的损失方面的责任。
7. 保修不包括以下所列：
  - a) 由于正常磨损而做的定期检查、保养和修理或者替换零件。
  - b) 相关的运输费用，产品的拆、装。
  - c) 错误使用，包括故意地或者过失的安装。
  - d) 由于闪电、水、火、自然灾害、战争、起义、电压波动、通风不良、运输或者其他在尊宝控制能力之外的损害。
8. 在保修期内，这个保证适用于每个合法的产品使用者。



# شهادة الضمان العربية

## الخدمة:

- في حالة الاستفسار عن الضمان , يرجى الاتصال بالموزع .
- في حالة طلب الخدمة تحت الضمان , يرجى إظهار الفاتورة الأصلية والتأكد من أن الرقم التسلسلي للمنتج مقروء.
- **ملاحظة هامة:** لا ترسل المنتج للإصلاح بدون موعد سابق مع الموزع ويجب أن يكون المنتج دائما مغلف بطريقة جيدة.
- إذا كان المنتج خارج الضمان فإن جميع التكاليف من إصلاح وشحن .... الخ يتحملها الزبون.

## شهادة الضمان:

- 1-لا يوجد في شهادة الضمان هذه ما يلزم قانوناً.
- 2-شهادة الضمان هذه تسري في حالة توفر الفاتورة الأصلية موضح عليها الرقم التسلسلي للجهاز بطريقة مقروءة.
- 3-يتم تصليح الأعطال من خلال الموزع المعتمد , أو عن طريق أية ورشة معتمدة , ولا يتم دفع أية مبالغ إذا تم التصليح عن طريقه أي شخص غير معتمد فهذا الضمان لا يشمل المنتج الذي تم تصليحه عن طريق شخص غير معتمد , كما أن أية أعطال أو خلل ينتج عن طريق الشخص الغير معتمد لا يشمل الضمان .
- 4-هذه المنتجات لا تتأثر من ناحية جودة التصنيع أو المواد الأولية بأية عيوب سواء تم تصنيعها في بلدها الأصلي أو في أي بلد آخر ,سواء من الناحية الفنية أو متطلبات الأمان .
- 5-جامو لها حق الاختيار خلال فترة الضمان في إصلاح الجهاز أو استبدال القطع التالف , أما في حالة عدم القدرة على إصلاح المنتج أو استبدال القطع التالف فيتم استبدال الجهاز بالكامل.
- 6-تحت أية ظروف جامو غير مسؤولة قانونياً عن أي شيء خارج بنود شهادة الضمان .
- 7-الضمان لا يشمل ما يلي :
  - أ. الفحص الدوري , وكذلك الصيانة أو أية قطع غيار بالية أو تالفة في حالة تخطي عمر الاستعمال.
  - ب. تكاليف التوصيل للزبون وإعادة تجميع المنتج.
  - ج. سوء الاستعمال , سواء كان عن قصد أو غير قصد أو ناتج عن عيوب التركيب .
  - د. إن أي تلف ناتج عن الإضاءة , أو المياه , أو الحريق , أو الكوارث الطبيعية , أو الحروب أو العصيان المسلح لا يشمل الضمان.
  - هـ. الأعطال الناتجة عن سوء استخدام الكهرباء (تذبذب التيار الكهربائي , عدم وجود تهوية , ضعف التيار الكهربائي).
  - و. الأعطال الناتجة عن النقل .
- 8-تقدم شهادة الضمان هذه للمالك المنتج خلال فترة الضمان .