

Honeywell

CT45/CT45 XP Series

Mobile Computers
powered by Android™



User Guide

Disclaimer

Honeywell International Inc. (“HII”) reserves the right to make changes in specifications and other information contained in this document without prior notice, and the reader should in all cases consult HII to determine whether any such changes have been made. HII makes no representation or warranties regarding the information provided in this publication.

HII shall not be liable for technical or editorial errors or omissions contained herein; nor for incidental or consequential damages resulting from the furnishing, performance, or use of this material. HII disclaims all responsibility for the selection and use of software and/or hardware to achieve intended results.

This document contains proprietary information that is protected by copyright. All rights are reserved. No part of this document may be photocopied, reproduced, or translated into another language without the prior written consent of HII.

Copyright © 2021-2022 Honeywell International Inc. All rights reserved.

Web Address: sps.honeywell.com

Trademarks

Google, Android, Google Play, Google Pay and other marks are trademarks of Google LLC.

Bluetooth trademarks are owned by Bluetooth SIG, Inc., U.S.A. and licensed to Honeywell.

microSD is a registered trademark of SD-3C, LLC.

Qualcomm and Snapdragon are registered trademarks or trademarks of Qualcomm Incorporated in the United States and/or other countries.

Other product names or marks mentioned in this document may be trademarks or registered trademarks of other companies and are the property of their respective owners.

Patents

For patent information, refer to www.hsmpats.com.

TABLE OF CONTENTS

Customer Support	ix
Technical Assistance	ix
Product Service and Repair	ix
Limited Warranty	ix
Chapter 1 - About the Computer Features.....	1
About the Mobile Computer.....	1
CT45 Model Overview	2
CT45 XP Model Overview	3
Mobile Computer Features	4
About the Battery	5
Battery Part Numbers	6
CT45 XP Models.....	6
Charge the Battery Before Use.....	6
Battery Replacement.....	7
Replace the Battery.....	7
About the Battery Status.....	9
About the Battery Status LED Setting.....	10
Check the Battery Level and Usage	11
About Battery Life and Conservation	11
Battery Recommendations and Safety Precautions	12
Power On the Computer	13
Welcome Screen.....	13
Unlock the Screen	13
Change the Screen Lock to Protect the Computer	14

Select a Touch Screen Profile.....	14
Configure the Screen Backlight.....	15
About the Good Read LED	15
About the Audio Features	16
Adjust Speaker Volume	16
Enable Vibrate Mode.....	16
Audio Settings	17
Insert a microSD Card.....	17
How to Transfer Files.....	19
Configure USB Connection and Transfer Files	20
Accessories for the Computer.....	20

Chapter 2 - About the User Interface and Applications..... 23

About the User Interface.....	23
Navigation and Function Buttons	24
Remap a Button	25
Restore Default Button Action	26
About Status Bar Icons	26
View and Manage Notifications	27
Open Quick Settings	27
Customize the Home Screen	28
Customize the Favorites Tray	28
Use Google™ Search.....	28
About Screen Gestures	29
Set the Time Zone.....	29
About Honeywell Applications.....	30
Applications You Can Download to the Mobile Computer	31
Unlock Developer Options	33

Chapter 3 - Use the Imager..... 35

About the Imager	35
About the Scan Wedge Feature	35
Change the Scanner Settings	36

Change the Bluetooth Scanner Settings	36
Restore Default Scan Settings	37
Default Scan Settings	37
Add a Scan Setting Profile.....	44
Delete a Scan Setting Profile	44
About the Optional Digital Scan Button	44
Enable and Configure the Digital Scan Button	44
Scan Barcodes.....	45
About Scanning Configuration Barcodes.....	46
Use the Scan Demo App	46
Change the Scan Demo Symbology Settings	46

Chapter 4 - Use the Phone.....47

About the Phone	47
About the SIM Selection App.....	47
Using Single SIM Mode	48
Using Dual SIM Dual Standby Mode	49
About Auto Carrier Config Selection.....	50
Activate the Phone.....	50
Provision a nano-SIM Card.....	51
Provision eSIM.....	52
Make a Phone Call.....	53
About Apps with Push-to-Talk Functionality.....	53
Answer the Phone	54
Switch Apps During a Phone Call.....	54
Make an Emergency Phone Call.....	54
Configure Phone Settings	54

Chapter 5 - Use the Camera57

About the Color Camera	57
How to Zoom	57
Take a Photo.....	57
Record a Video.....	58

Change Camera Settings.....	58
Use the Camera as a Flashlight.....	59

Chapter 6 - Configure the Computer..... 61

How to Configure the Computer.....	61
Start the Settings App	61
About the Structure of the Settings App	61
About Network Communications	72
Connect to a Wi-Fi Network	72
Honeywell Wi-Fi Settings	74
Connect to an Ethernet Network.....	74
How to Connect to Virtual Private Networks	74
About Wireless Security.....	76
About Certificates	76
About Bluetooth Communications	77
Connect a Bluetooth Device	77
Rename the Computer and View File History	79
Rename or Unpair a Paired Device.....	79
About the Scanner Edge App.....	79
About Ethernet and USB Communications	81
USB Troubleshooting.....	81
USB or Bluetooth Tethering for Data Connection Sharing.....	81
Minimum requirements for USB Tethering	81
Set up and Connection	82
Minimum requirements for Bluetooth Tethering	82
Set up and Connection	82
About Near Field Communication (NFC).....	82
Developer Information.....	83
About Provisioning Mode	83
Enable or Disable Provisioning Mode.....	84
About Wi-Fi Staging.....	84
Staging Devices	84
Log Files.....	88

About Voice Wedge.....	88
Define Trigger Mode.....	88
Associate Applications.....	89
Define Key Commands.....	89
Select Data Type.....	89
To Use Voice Wedge in an App.....	90

Chapter 7 - Manage and Maintain the Computer91

About Software Updates	91
Software Downloads.....	91
About Transferring Files via USB Connection.....	92
Install Software Apps with AutoInstall.....	92
Optional microSD Card Method	93
About the Honeywell Upgrader	93
Install OTA Updates	93
Restart (Reboot) the Computer.....	95
About an Enterprise Data Reset.....	95
Before You Begin.....	95
Enterprise Data Reset the Computer.....	96
About a Full Factory Reset.....	96
Before You Begin.....	96
Full Factory Reset the Computer.....	97
Repairs.....	97
Maintenance.....	97
Clean the Computer	97

Appendix A - Specifications99

Computer Agency Information	99
Label Locations.....	99
Physical and Environmental Specifications	100
Imager Specifications	100
Barcode Symbologies.....	100
S0703 Imager.....	101

S0703 Imager Field of View/Resolution	102
N6803 FlexRange Imager	103
N6803 FlexRange Imager Field of View/Resolution.....	104
N6700 Imager (CT45 XP Only).....	105
N6700 Imager	107

Customer Support

Technical Assistance

Go to sps.honeywell.com and select **Support** to search our knowledge base for a solution or to log into the Technical Support portal.

Product Service and Repair

Honeywell International Inc. provides service for all of its products through service centers throughout the world. Go to sps.honeywell.com and select **Support** to find a service center near you or to get a Return Material Authorization number (RMA #) before returning a product.

For ongoing and future product quality improvement initiatives, the mobile computer comes equipped with an embedded device lifetime counter function. Honeywell may use the lifetime counter data for future statistical reliability analysis as well as ongoing quality, repair and service purposes.

Limited Warranty

For warranty information, go to sps.honeywell.com and select **Support > Warranties**.

ABOUT THE COMPUTER FEATURES

This chapter introduces the CT45/CT45 XP mobile computer series. Use this chapter to learn about the basic computer features, functions, and accessories.

Note: *Throughout this manual, all versions of the mobile computer are referred to as the CT45/CT45 XP unless information is specific to a particular model. The device applications and settings vary by computer model and OS version. Your computer may not include all the features shown in the manual.*

About the Mobile Computer

Honeywell's CT45/CT45 XP mobile computer series, built on the newest generation Mobility Edge™ platform, delivers real-time connectivity, advanced data capture, and future-proof investment protection. All models come equipped for fast Wi-Fi connectivity with a WLAN 802.11 a/b/g/n/ac/ax* radio, Bluetooth wireless radio technology that includes Bluetooth Low Energy support, and integrated Near Field Communication (NFC) technology. The CT45/CT45 XP series also includes front and rear facing color cameras, a dedicated push-to-talk (PTT) button for common applications that support PTT, and a USB Type C connector for both charging and communication use.

Wireless WWAN radio equipped models provide additional connectivity for high speed data and quality voice support across all network technologies. In addition, the integrated global positioning satellite (GPS) receiver on WWAN models provides GPS protocol support for both L1 and L5 bands that includes Simultaneous GNSS Receiver support for GPS, GLONASS, Galileo and Beidou, Assisted GPS.

The CT45 XP offers the added benefit of a warm swap battery feature and Device Finder app compatibility when the mobile phone is registered with Operational Intelligence™. Optional CT45 XP model configurations include features such as advanced Wi-Fi 6 technology, secondary Bluetooth Low Energy wireless communication support.

To learn more about the CT45/CT45 XP series, refer to the [CT45 Model Overview](#) on page 2 and the [CT45 XP Model Overview](#) on page 3.

* WLAN 802.11 ax supported on CT45 XP WLAN only models (CT45P-XON).

CT45 Model Overview

Available Features	Model CT45-L0N	Model CT45-L1N
Android operating system*	x	x
Qualcomm® QCS4290/QCM4290 octa-core, 2.0 GHz processor	x	x
4 GB DDR4x RAM, 64 GB UFS flash memory	x	x
Choice of Honeywell high performance 2D imager	x	x
Dedicated push-to-talk button	x	x
USB Type C connector for communication/charging	x	x
High-tier rugged specifications with IP65/68 sealing	x	x
WLAN IEEE 802.11 a/b/g/n/ac radio; Wi-Fi certified	x	x
Bluetooth™ V5.1 and Bluetooth Low Energy wireless technology support	x	x
NFC technology for short-range wireless data exchange	x	x
Wireless WWAN radio for high speed data and quality voice support across all network technologies		x
Integrated GPS receiver; GPS protocol support for both L1 and L5 bands that include Simultaneous GNSS Receiver Support for GPS, GLONASS, Galileo and Beidou, Assisted GPS		x
Customer-accessible microSD™ slot for removable memory cards up to 512 GB (SDXC/SDHC/SDIO-compliant)	x	x
13-megapixel color camera with video, image stabilization and advanced software features for enhanced exposure control	x	x
8-megapixel front-facing camera	x	x
Value-added software components supporting specialized imaging and OCR functions	x	x
Large, high definition (1280 x720) resolution, bright color, outdoor-readable display with responsive multi-touch capacitive touch panel**	x	x
Integrated Ambient light sensor, proximity sensor, accelerometer, gyroscope, magnetometer, barometer (model dependent), eCompass (model dependent), hall sensor, high gravity sensor	x	x
Optional 3.5 mm audio jack (available on Wi-Fi only models)	x	
<p>* For information on supported Android OS versions, see the CT45 Data Sheet, available at sps.honeywell.com.</p> <p>** Use of a screen protector may have small effect on the capacitive touch panel performance.</p>		

Note: To learn more, see [Appendix A: Specifications](#) beginning on page 99.

CT45 XP Model Overview

Available Features	Model CT45P-XON	Model CT45P-L1N
Android operating system*	x	x
Qualcomm® QCS4290/QCM4290 octa-core, 2.0 GHz processor	x	x
6 GB DDR4x RAM, 64 GB UFS flash memory	x	x
Choice of Honeywell high performance 2D imager	x	x
Dedicated push-to-talk button	x	x
USB Type C connector for communication/charging	x	x
Warm swap battery feature	x	x
High-tier rugged specifications with IP65/68 sealing	x	x
WLAN IEEE 802.11 a/b/g/n/ac radio; Wi-Fi certified	x	x
WLAN IEEE 802.11 ax radio (Wi-Fi 6); Wi-Fi certified	x	
Bluetooth™ V5.1 wireless technology with Bluetooth Low Energy and optional secondary Bluetooth Low Energy technology support	x	x
NFC technology for short-range wireless data exchange	x	x
Wireless WWAN radio for high speed data and quality voice support across all network technologies		x
Integrated GPS receiver; GPS protocol support for both L1 and L5 bands that include Simultaneous GNSS Receiver Support for GPS, GLONASS, Galileo and Beidou, Assisted GPS		x
Customer-accessible microSD™ slot for removable memory cards up to 512 GB (SDXC/SDHC/SDIO-compliant)	x	x
13-megapixel color camera, with video image stabilization and advanced software features for enhanced exposure control	x	x
8-megapixel front-facing camera	x	x
Value-added software components supporting specialized imaging and OCR functions	x	x
Full, high definition (1920 x 1080) resolution, bright color, outdoor-readable display with responsive multi-touch capacitive touch panel**	x	x
Integrated ambient light sensor, proximity sensor, accelerometer, gyroscope, magnetometer, barometer (model dependent), eCompass (model dependent), hall sensor, high gravity sensor	x	x
Optional 3.5 mm audio jack (available on Wi-Fi only models)	x	
<p>* For information on supported Android OS versions, see the CT45 XP Data Sheet, available at sps.honeywell.com.</p> <p>** Use of a screen protector may have small effect on the capacitive touch panel performance.</p>		

Note: To learn more, see [Appendix A: Specifications](#) beginning on page 99.

Mobile Computer Features

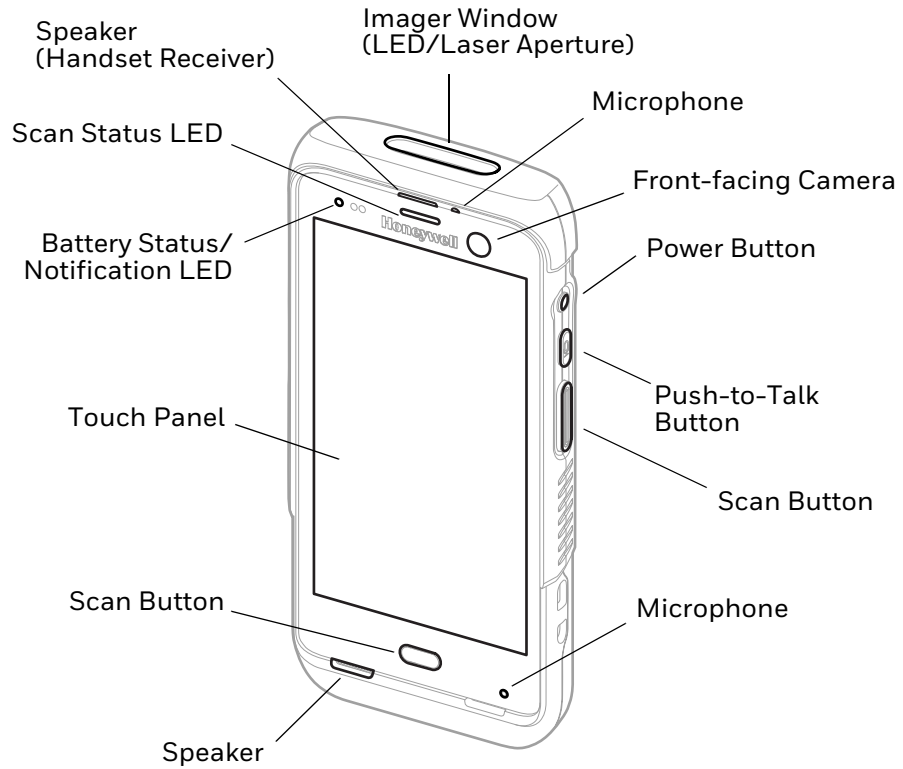

Note: Hand strap not shown.

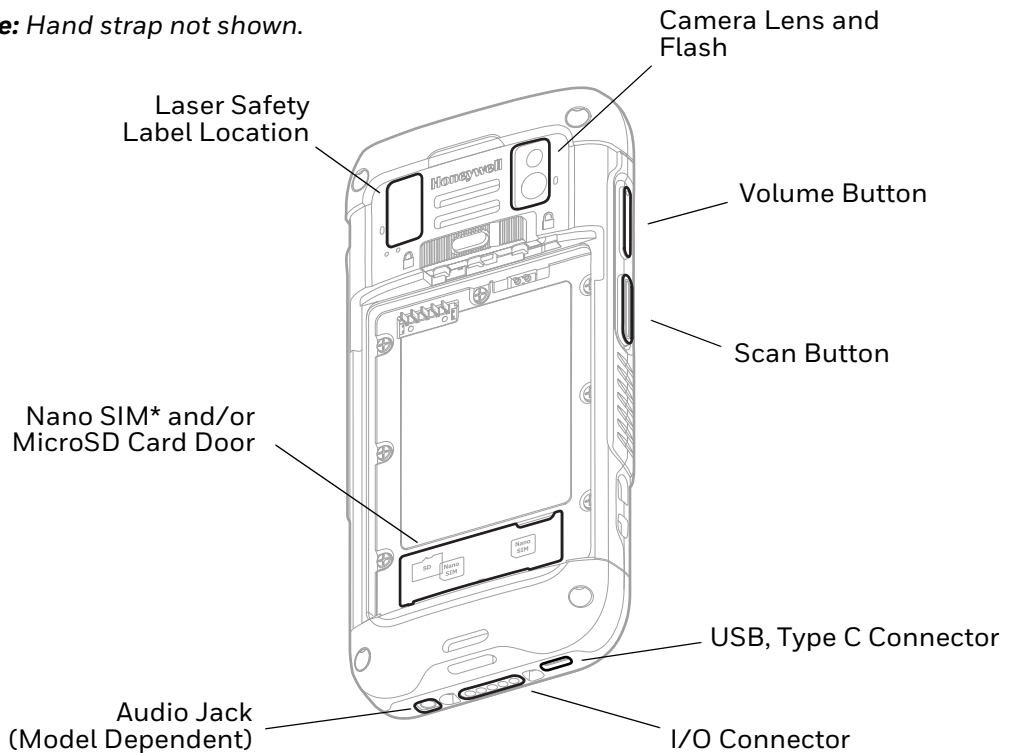

* Cellular phone feature is available only on WWAN models (CT45-L1N, CT45P-L1N). On all models, the SIM slot supports use of an UICC card for NFC Secure Element NFC link encryption.

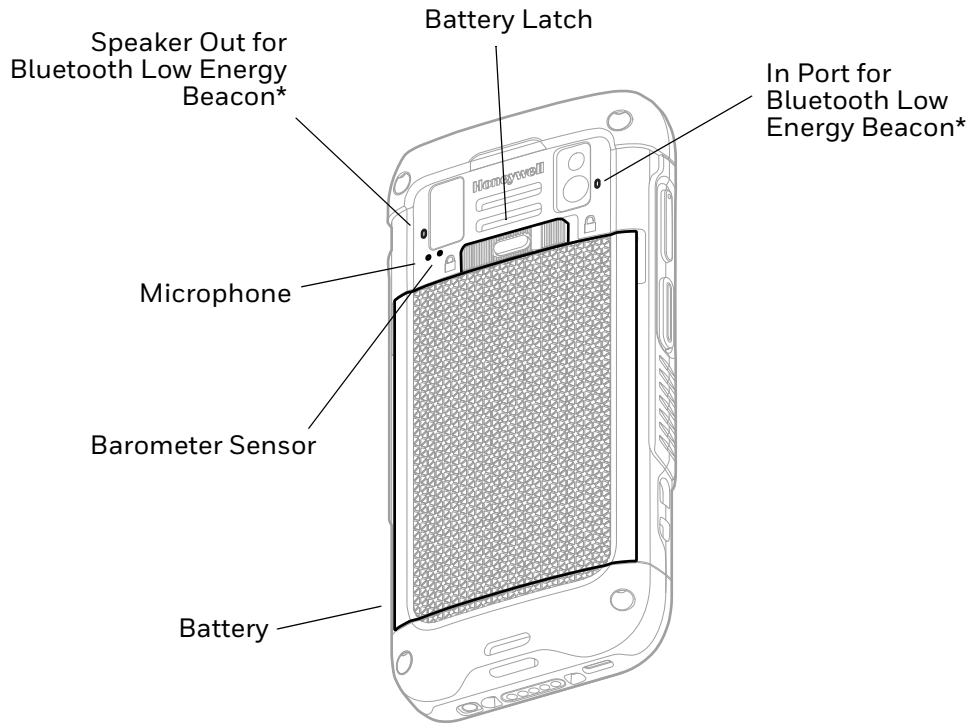

* Part of Honeywell's Device Finder solution when mobile phone is registered with Operational Intelligence.

About the Battery

The computer uses a rechargeable Li-ion battery as its main power source. Several factors determine the life of the battery, such as display brightness, display timeout, input device, extreme temperature, and battery usage. Honeywell recommends that you keep the battery charged at all times to prevent data loss.

CT45/CT45 XP computers are designed for use with battery model CT50-BTSC manufactured for Honeywell International Inc. **When ordering a replacement battery, it is important to order by part number and not only by model number.** See [Battery Part Numbers](#) on page 6 for guidance on the correct battery part number for your unit configuration.

For a list of compatible accessories, see the *CT40/CT45 Series Accessory Guide*, available for download from the product device pages at sps.honeywell.com. Contact your local sales representative for replacement battery ordering information.



Caution: Improper battery replacement or incompatible device usage may result in risk of burns, fire, explosion, or other hazard. Dispose of lithium-ion batteries according to local regulations. Risk of fire and burns if improperly handled. Do not open, crush, heat above 60°C (140°F), or incinerate.

Battery Part Numbers

CT45 Models

Model Configuration	Battery P/N
x = configuration variations	
CT45-xxx-xxxxxxx	318-055-067
Configuration number (CN) is located on the label in the battery well of the mobile computer.	

CT45 XP Models

Model Configuration	Battery P/N
x = configuration variations	
CT45P-xxx-xxxxxxx	318-055-067
Configuration number (CN) is located on the label in the battery well of the mobile computer.	



Caution: Read [Battery Recommendations and Safety Precautions](#) on page 12 and all cautionary markings on the battery, charging peripheral, and device using the battery before attempting to install, use, or charge the battery.

Charge the Battery Before Use

The mobile computer ships with a partially charged battery. Charge the battery with a CT40/CT45 series charging device for a minimum of **3 hours**.

Note: *Using the computer while charging the battery increases the time required to reach a full charge.*

About the USB Type C Connector

You can use a USB cable to charge the mobile computer from a host device (e.g., laptop or desktop computer). The connected host device must supply a minimum power output of 5V, 0.5A to the mobile computer.

Note: *If the mobile computer is drawing more current than supplied by the charging source, charging will not take place.*

Battery Replacement

If your battery power is low, you need to either charge the battery in the computer or replace it with a charged battery.

Before Attempting to Remove the Battery

Always do the following before removing the battery:

- If you have a CT45 model, power off the computer.
- If you have a CT45 XP model, place the unit in Swap Battery mode (see below).

CT45 XP Swap Battery Mode

Swap Battery mode places the computer in a lower power state so that the battery can be removed for a short time. This feature is not available on CT45 models.

To activate Swap Battery mode:

1. Press and hold the **Power** button until the options menu appears.
2. Touch **Swap Battery** and follow the on-screen instructions.
3. Once you replace the battery, press the **Power** button.

Replace the Battery



Caution: Improper battery replacement or incompatible device usage may result in risk of burns, fire, explosion, or other hazard. Dispose of lithium-ion batteries according to local regulations. Risk of fire and burns if improperly handled. Do not open, crush, heat above 60°C (140°F), or incinerate.

Remove the battery

1. Depending on the model type either power Off the computer or place it in battery swap mode. See [Before Attempting to Remove the Battery](#) on page 7.
2. Release the hand strap.

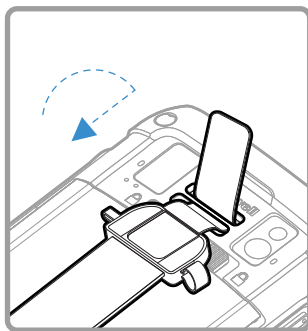

3. Unlock the battery. Press and hold down the small button on the battery latch, and then slide the latch toward the unlock icon. The battery will pop-up slightly on the edge when the latch is released.

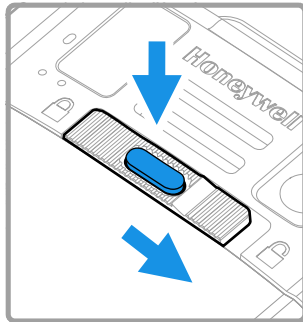

4. Lift up on the edge of the battery and remove it from the computer.

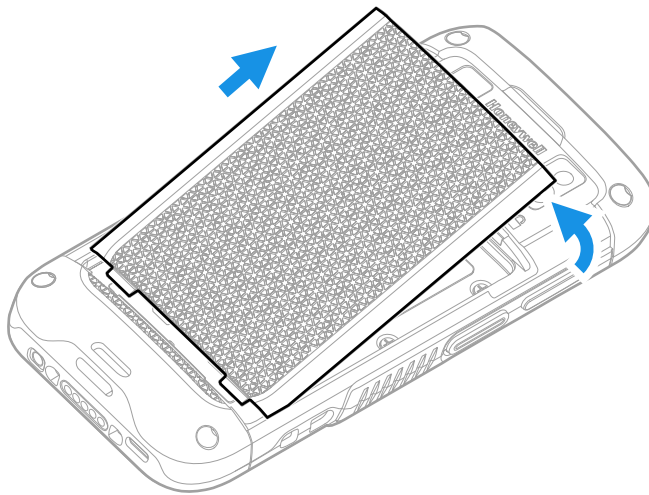

Install the Battery

1. Insert the charged battery into the computer. See [Battery Part Numbers](#) on page 6.

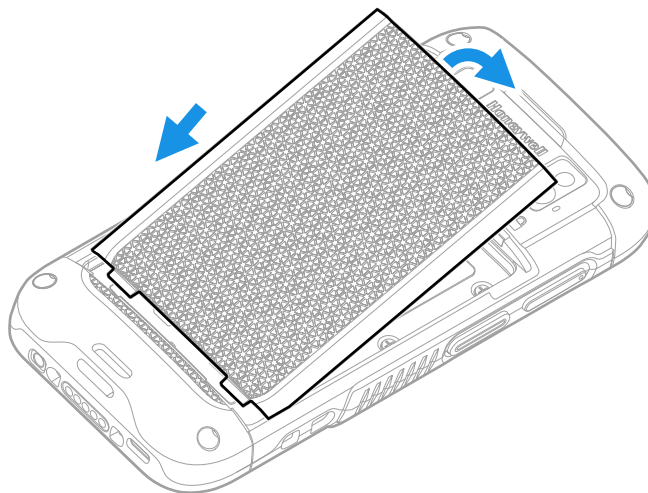

2. Attach the hand strap.

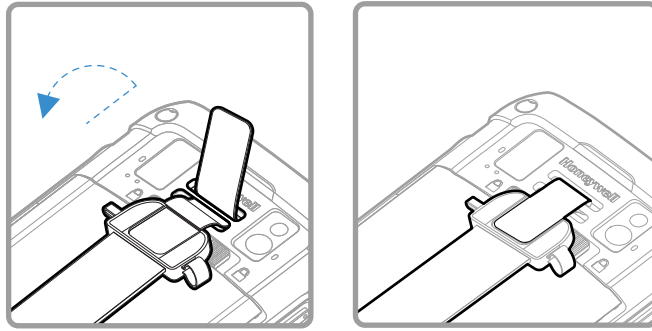







3. Press the **Power** button.

About the Battery Status

Use the battery icon in the Status bar at the top of the screen to see the charge level of your battery. If you want more detailed information on your battery, such as usage time, charge remaining on the battery, or battery health information, open the **Settings**  app and tap **Battery**.

Battery Status Icons

Icon	Status
	The battery charge is at 100%.
	The battery charge is at 50%.
	The battery charge is low. You need to charge or replace the battery soon.
	The battery is critically low. You need to replace the battery now or connect the computer to a charging accessory.
	The computer is connected to external power and the battery is charging.
	There is a battery error. Install another battery. If the problem persists, call Honeywell Technical Support.

The Battery status LED color and behavior (e.g., steady on, blinking, or off) indicates the charging status of the battery. To view status descriptions and to learn how to modify the Battery LED behavior, see [About the Battery Status LED Setting](#) on page 10.

Battery Status LED

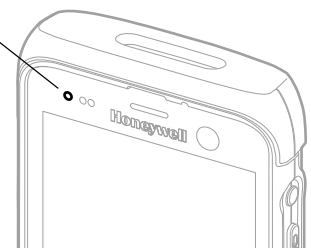

About the Battery Status LED Setting

You can change the behavior of the Battery status LED if the out-of-box behavior for a charging battery (blinking green) is not acceptable to your environment.

You can choose one of three options:

- **Default Battery LED** (optional Android OS configuration)
- **Honeywell Battery LED** (factory default, out-of-box configuration)
- **No Battery LED**

Honeywell Battery LED Behavior (Factory Default/Out-of-Box Configuration)

Connected to Power	LED State	Description
No	Blinking amber	Battery level is below 15%
No	Off	Battery level is more than 15%
Yes	Steady amber	Battery level is between 0% and 60%
Yes	Blinking green	Battery level is between 60% and 95%
Yes	Steady green	Battery level is above 95%
Either	Blinking red	Battery error

Default Battery LED Behavior (Optional Android OS Configuration)

Connected to Power	LED State	Description
No	Blinking red	Battery level is below 15%
No	Off	Battery level is 15% or more
Yes	Steady red	Battery level is below 15%
Yes	Steady amber	Battery level is between 15% and 90%
Yes	Steady green	Battery level is 90% or more

Select the No Battery LED setting if you want to use the LED as a notification LED for applications or device management solutions. For more information on how to use the LED as a notification LED, see <http://developer.android.com/guide/topics/ui/notifiers/notifications.html>.

Change the Battery Status LED Behavior

To change the battery status LED behavior:

1. Swipe up from the bottom of the Home screen to access all apps.
2. Tap **Settings**  > **Honeywell Settings** > **Battery LED**.

3. Choose one of the options:
 - **Default Battery LED** (optional Android OS configuration)
 - **Honeywell Battery LED** (factory default/out-of-box configuration)
 - **No Battery LED** (disable the battery LED)

Check the Battery Level and Usage

In addition to the Battery status icon and LED, you can monitor the battery status from the Settings app.

1. Swipe up from the bottom of the Home screen to access all apps.
2. Tap **Settings**  > **Battery**.

The current percentage of battery power remaining and the amount of usage time left on the battery appears on the screen when the computer is not connected to an external power supply. When connected to an external power source, battery charge information is provided. A list shows the battery usage for individual apps and services. For usage details, select one of the apps or services in the list. You can also access the Battery saver feature from the battery screen.

About Battery Life and Conservation

It is important to remember that the battery slowly discharges when stored over a long period of time even when the computer is turned off or the battery is stored outside the computer. Use the reference table below to learn about how to conserve battery power.

When you want to:	Do this to save battery power:
Use the computer but the low battery status icon appears or the battery light turns on.	Do one of the following: <ul style="list-style-type: none"> • Connect the computer to a charging accessory. • Replace the Battery (see page 7).
Stop using the computer for 5 minutes or more.	Make sure that the low battery status icon is not on the screen and that the battery status LED is not on. Press and release the Power button to suspend the computer.
Store the computer for more than a day.	<ul style="list-style-type: none"> • If you are storing the computer for a few days (such as over the weekend), install a fully charged battery or connect the computer to a power source. • If you are storing the computer for a longer period of time, remove and charge the battery. When the battery is done charging, store both the battery and the computer in a cool location. • If you store the battery for several months, recharge the battery periodically to keep it at peak performance.
Store the battery outside of the computer.	Store battery in charger or periodically recharge it to keep it at peak performance.

Enable Airplane Mode

If you do not need to connect to any wireless networks, you can enable Airplane mode to turn off the radios and save battery power.

1. Swipe up from the bottom of the Home screen to access all apps.
2. Tap **Settings**  > **Network & internet**.
3. Tap the toggle button next to **Airplane mode**. An airplane icon appears in the status bar to indicate Airplane mode is turned on.

Battery Recommendations and Safety Precautions



Caution: Improper battery replacement or incompatible device usage may result in risk of burns, fire, explosion, or other hazard. Dispose of lithium-ion batteries according to local regulations. Risk of fire and burns if improperly handled. Do not open, crush, heat above 60°C (140°F), or incinerate.

- To learn more about Battery Maintenance for Portable Devices, go to honeywell.com/PSS-BatteryMaintenance.
- For maximum battery life, charge the battery at 20 °C (68 °F) to 25 °C (77 °F) and store at 20 °C (68°F) with a 30%-50% charge.
- Do not store the battery at temperatures above 60 °C (140 °F). Storage above 60 °C (140 °F) may damage the battery.
- Charge the battery before use. Battery ships with only a partial charge.
- See [Charge the Battery Before Use](#) on page 6 for approved charging methods. Use of this battery in other devices could result in damage to the device or battery.
- Avoid dropping the battery or computer. If you suspect that the battery or computer is damaged, send it to Honeywell service center for inspection.
- Replace the battery only with another CT50-BTSC model battery that matches the part number noted in the [Battery Part Numbers](#) (see page 6) section of this guide. These batteries have been tested in accordance with applicable safety standards. Contact your Honeywell sales representative or distributor if this battery is no longer available.
- Discarded batteries may create a safety hazard. Before disposal, cover the battery contacts with electrical insulating tape.
- Do not modify the battery or attempt to insert foreign objects into it.
- Do not solder directly to the battery contacts.
- Do not drop the battery or apply mechanical shocks or pressure to it.
- Do not immerse batteries into, or expose them to, water or seawater.

- Do not incinerate, microwave, throw into a fire, or expose batteries to temperatures above the maximum rating.
- Do not disassemble a battery or try to open or penetrate its housing.

Power On the Computer

After you have fully charged and installed a battery, power on the computer for the first time:

- Press and hold the **Power** button for approximately 3 seconds, and then release the button.

Welcome Screen

The first time you power on the computer, a Welcome screen appears. You can either scan a configuration barcode or use the Wizard to manually set up the computer. To learn more about how to [Scan Barcodes](#), see [page 45](#). To learn more about configuring multiple devices using Wi-Fi Staging, see [page 84](#).

During the manual setup process, follow the prompts on the screen as the wizard has you:

- Set the default language.
- Set up the Wi-Fi network connections.
- Set the time, date, and time zone.
- Personalize (name) the computer.
- Set up security and privacy options.

Once you complete the initial setup, the Welcome screen no longer appears when you power on the computer and **Provisioning mode** is automatically turned Off (disabled). Scanning a barcode to install applications, certificates, configuration files, and licenses on the computer is restricted when **Provisioning mode** is turned Off. To learn more [About Provisioning Mode](#) see [page 83](#).

Unlock the Screen

The screen lock automatically activates every time the computer is turned On or when the computer wakes from Screen Timeout mode (sleep mode).

- Swipe up from the bottom of screen to open.

The level of security provided depends on the type of lock set (e.g., Swipe, Pattern, PIN, or Password). The default setting (Swipe) provides no protection against unauthorized access to your computer.

Change the Screen Lock to Protect the Computer

After you start using the computer, you should change the screen lock to prevent unauthorized persons from accessing the computer after the screen lock activates, unless they input the correct password, pin, or pattern.

The recommended setting for the Screen Lock is to enable a Password lock. Use a strong password value (e.g., include numbers, characters, special characters, and mix character case).

1. Swipe up from the bottom of the Home screen to access all apps.
2. Tap **Settings**  > **Security** > **Screen lock**.
3. Choose one of the following options:
 - **None**
 - **Swipe**
 - **Pattern**
 - **PIN**
 - **Password**
4. Follow the on-screen prompts to complete the setup.
5. Exit the Settings app.

Select a Touch Screen Profile

Optimize screen interactions by selecting a touch screen profile designed specifically for your use case. For example, if you wear gloves, set the touch screen profile to Glove use, which is enhanced for the best touch screen response.

This feature is only available on CT45 XP models.

Note: *Maximum glove thickness of 2 mm (0.08 inches) for touch screen response.*

1. Swipe up from the bottom of the Home screen to access all apps.
2. Tap **Settings**  > **Honeywell Settings** > **Touch Screen Profile**.
3. Choose one of the following options:
 - **Normal mode**
 - **Finger enhance mode**
 - **Glove enhance mode**
 - **Stylus enhance mode**
4. Exit the Settings app.

Configure the Screen Backlight

The display has an ambient light sensor that automatically adjusts the backlight intensity to conserve power and ensure the display is readable. You can also manually set the backlight intensity if you do not want to use the automated adaptive brightness feature.

1. Swipe up from the bottom of the Home screen to access all apps.
2. Tap **Settings**  > **Display**.
3. Choose one of the following options:
 - To have the computer automatically adjust the brightness for your work environment, turn On the **Adaptive brightness** setting. You can tap **Adaptive brightness** to toggle the feature On or Off.
 - To set the brightness level manually, verify the Adaptive brightness feature is turned Off, and tap **Brightness level**. Adjust the slider to set the brightness level.

About the Good Read LED

The Scan Status LED indicates the read status of the imager when scanning a barcode. When active, the LED illuminates the outer ring of the front speaker. To learn more about how to use and configure the imager for scanning, see [Chapter 3: Use the Imager](#) beginning on page 35.

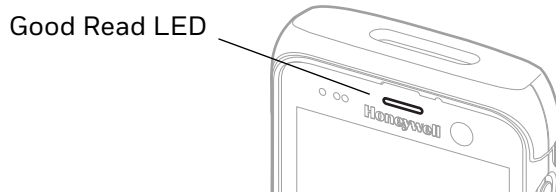

Good Read LED Descriptions

LED Color	Description
Green	Good read of a barcode.
Blinking green	The data collection imager is processing or starting up.
Red	Failure to scan barcode. Check to make sure you have the correct symbology enabled.

About the Audio Features

The CT45/CT45 XP has multiple speakers, three microphones, and several software settings to configure sound volume or enable vibration feedback.

Adjust Speaker Volume





Use the Volume button on the left side of the computer to adjust the volume of ringtones, media, notifications, and alarms.

Note: *The volume setting varies by OS version.*

To quickly change the active speaker volume level:

- Press the top of the Volume button (+) to raise the volume of the active speaker.
- Press the bottom of the Volume button (-) to lower the volume of the active speaker.

To access the volume quick set menu:

1. Press the Volume button.
2. Adjust the volume level using the on-screen menu.
 - Tap the icon at the top to toggle the media volume between Sound On , Vibrate Only , or Silent .
 - Use the slider to adjust the media volume.
 - Tap  to turn toggle media volume off.
 - Select  at the bottom to adjust Media, Call, Ring, or Alarm volume levels.

Enable Vibrate Mode

Simultaneously press the **Volume up** (+) and **Power** button to quickly enable Vibrate mode so the computer vibrates instead of emitting sound for notifications and rings.

If you need quiet time without interruptions, enable Do Not Disturb to mute sound, stop vibration, and block notifications. Under the full settings menu, you can set a schedule for when you want Do Not Disturb to automatically turn on and off.

To enable Do Not Disturb manually:

1. Swipe down from the top of the screen to view quick set menu.
2. Tap the **Do Not Disturb** icon  to toggle feature On/Off.

Audio Settings

This section describes the audio and sound settings you can configure in the Settings app.

- To change audio settings, open the **Settings**  app and then tap **Sound**.

Sound Settings

Setting	Description
Media volume	Use the sliders to set the volume for media (e.g., music, videos, and games), calls, alarms and rings (notifications and ringtones).
Call volume	
Ring & notification volume	
Alarm volume	
Vibrate for calls	Select to enable vibrate mode when the phone is ringing.
Do not disturb	Select to set which notifications to let through when you have Do Not Disturb turned On and when you want to be left alone.
Shortcut to prevent ringing	Set what happens when you simultaneously press the Power and Volume up button. Options include: Vibrate, Mute or turn the shortcut Off.
Phone ringtone	Select a default ringtone.
Advanced	
Default notification sound	Select a notification sound.
Default alarm sound	Select an alarm sound.
Other sounds and Vibrations	Turn sounds On or Off for: <ul style="list-style-type: none">• Dial pad tones• Screen locking sounds• Charging sounds and vibration• Touch sounds• Touch vibration

Insert a microSD Card

You can use a microSD card to increase file storage capacity or to install software. Honeywell recommends the use of Single Level Cell (SLC) industrial grade microSD or microSDHC memory cards with the computer for maximum performance and durability.

Note: *Format the memory card before initial use.*

1. Save your files and close any open applications.
2. Press and hold the **Power** button until the options menu appears.
3. Tap **Power off** or **Power > Power off** depending your computer model.
4. Remove the battery from the computer, refer to [page 7](#).

5. Follow the instructions provided for your model type.

**For CT45 series: CT45-L0N-xxxx0xx and
CT45 XP series: CT45P-X0N-xxxx0xx**

- a. Lift up the edge of the SD card access door.

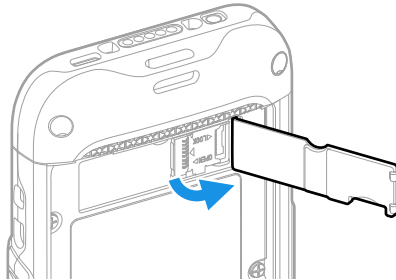

- b. Press down gently and slide the card holder away from the open access door. Lift the edge of the holder up.

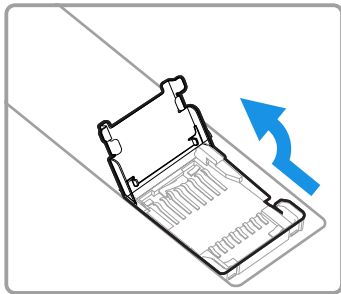

- c. Insert the microSD card into the card holder with the contacts facing out.

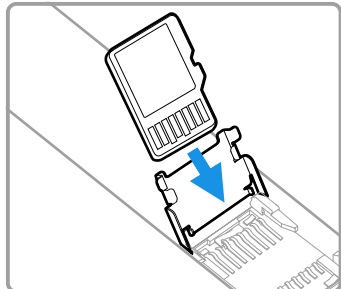

- d. Close the holder with the card inserted. Press down gently on the card holder and slide it into the locked position.

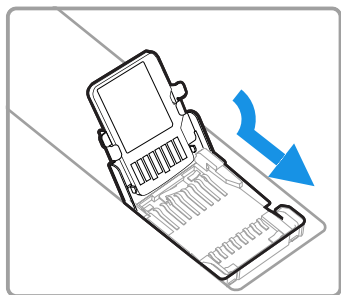

**For CT45 series: CT45-L1N-xxxx2xx and
CT45 XP series: CT45P-X0N-xxxx2xx and CT45P-X0N-xxxxExx**

- a. Lift up the edge of the SD card access door.

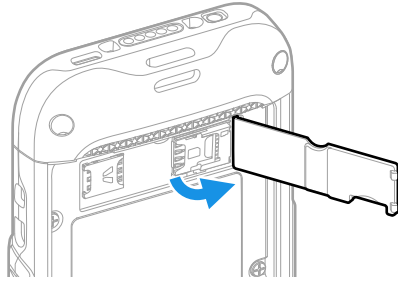

- b. Insert the microSD card into the top portion of the dual card socket.

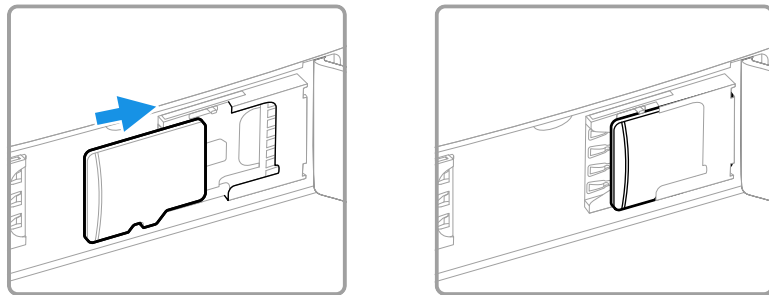

6. Close the SD card access door.
7. Install the battery. Refer to [page 8](#).

How to Transfer Files

To transfer files, you can physically connect the mobile computer to your workstation (e.g., laptop or desktop computer) through a USB connection. When the mobile computer is connected and USB is configured for file or photo transfer, use a file browser (e.g., Windows® File Explorer) on your workstation to transfer files between the two computers. If you are transferring files to and from a Mac, use the Android File Transfer application (available from www.android.com/filetransfer).

Note: File transfer through a USB connection is disabled by default. You need to configure the USB connection for transferring files or photos.

You can use these accessories to connect your mobile computer to your workstation:

- Home Base or Ethernet Home Base, and a standard USB Type B to A cable.
- Snap-On Adapter, Tethered USB Cable Client (CT45-SN-CNV).
- A standard USB communication cable with Type C connector.

Configure USB Connection and Transfer Files

Note: The CT45/CT45 XP supports Hi-Speed USB communications (USB 3.0) with theoretical maximum data transfer rate of 5Gbps. USB on-the-go (OTG) supported.

1. Connect the mobile computer to your workstation.
2. On the mobile computer, swipe down from the top of the screen to see the notifications.
3. Tap the **Android System** notification twice to open the options menu. You may need to scroll down to the bottom of your notifications to find it.
4. Select either **File Transfer** or **PTP** (picture transfer protocol).
5. Open the file browser on your workstation.
6. Browse to the mobile computer. You can now copy, delete, or move files between the CT45/CT45 XP and your workstation.

Accessories for the Computer

The CT45/CT45 XP ships with a battery and hand strap. All other accessories are ordered and shipped separately.

For a complete list of compatible accessories for your mobile computer and their part numbers, see the CT45/CT45 XP *Accessory Guide* available for download at sps.honeywell.com.

Contact your local sales representative for ordering information.

Accessory	Part Number	Use With
x = Kit variations. See Product Accessory Guide at sps.honeywell.com for additional details.		
Protective Boot	CT45-PB-x	CT45/CT45 XP
Universal Scan Handle Attaches to the mobile computer to provide handle grip and pull-trigger for barcode scanning.	CT45-SH-UVN	CT45 without boot
	CT45-SH-UVB	CT45 with boot
Universal Home Base Charge and communication base for one mobile computer and one spare battery. Base has one USB client connector (Type B).	CT40-HB-UVN-x	CT45/CT45 XP without boot
	CT40-HB-UVB-x	CT45/CT45 XP with boot

Accessory	Part Number	Use With
x = Kit variations. See Product Accessory Guide at sps.honeywell.com for additional details.		
Universal Ethernet Home Base Charge and communication base for one mobile computer and one spare battery. Base has one Ethernet connector and one USB client connector (Type B).	CT40-EB-UVN-x	CT45/CT45 XP without boot
	CT40-EB-UVB-x	CT45/CT45 XP with boot
Universal Charge Base Charges up to four mobile computers.	CT40-CB-UVN-x	CT45/CT45 XP without boot
	CT40-CB-UVB-x	CT45/CT45 XP with boot
Universal Ethernet (Net) Base Holds four mobile computers and is both a charge and communication base with two RJ45 Ethernet ports.	CT40-NB-UVN-x	CT45/CT45 XP without boot
	CT40-NB-UVB-x	CT45/CT45 XP with boot
Universal Display Dock For connecting one mobile computer to an external display. Extends I/O for HDMI, Ethernet communications and includes three USB ports.	CT40-DB-UVN-x	CT45/CT45 XP without boot
	CT40-DB-UVB-x	CT45/CT45 XP with boot
Universal Cups Replacement cups for universal bases.	CT40-UCP-N	CT45/CT45 XP without boot and Universal Base
	CT40-UCP-B	CT45/CT45 XP with boot and Universal Base
Snap-on USB Adapter Tethered USB adapter charges one mobile computer and allows data transfer via USB client connectivity. Includes non-boot adapter.	CT45-SN-CNV	CT45/CT45 XP with or without boot
Vehicle Dock With hard-wired 3-pin power cable and power adapter. Includes non-boot adapter.	CT45-VD-CNV	CT45/CT45 XP with or without boot
Vehicle Dock With integrated speaker, hard-wired 3-pin power cable and power adapter. Includes non-boot adapter.	CT45-VD-CNV-SPK	CT45/CT45 XP with or without boot

Note: The booted accessories in this manual do not accommodate rubber boot CT40-RB-00.

ABOUT THE USER INTERFACE AND APPLICATIONS

Use this chapter to learn about the user interface and how to interact with the screen. You can also use this chapter to learn about the Honeywell applications on the computer.

About the User Interface

The Android operating system provides a touch-friendly and easy-to-navigate user interface. When you turn on the mobile computer, the Home screen is the first screen that appears after language provisioning and the startup wizard is complete.

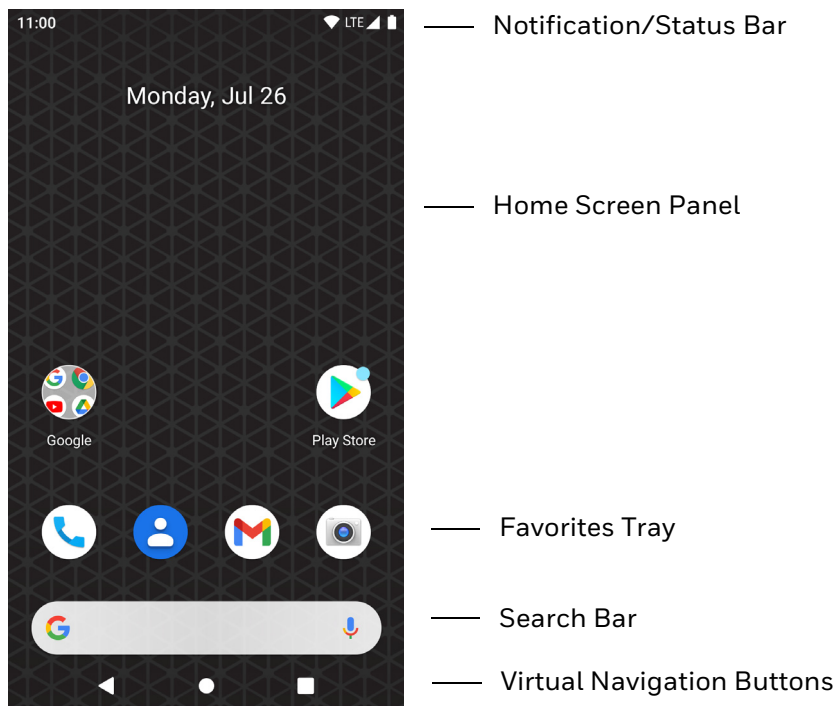

Home Screen Features

Item	Description
Notifications panel / Status bar	Status icons to the left tell you when an app has sent notifications, such as an arriving message. System icons to the right display the current wireless and network connection state and battery level.
Search bar	Search the Internet or the computer using Google™. Tap the microphone icon in the search box to initiate a voice search or command.
Home Screen Panel	You can create more than one custom Home screen panel. Swipe left or right on the Home to switch between your custom panels.
Favorites tray	App icons in the customizable tray are visible on all Home screen panels.







Navigation and Function Buttons

Your mobile computer has virtual buttons on the front panel below the Favorites tray and hardware buttons located on the sides for easy navigation and quick feature access when using the computer.

For button locations, see [Mobile Computer Features](#) on page 4.

To learn how to [Remap a Button](#), see [page 25](#).

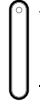
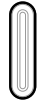
Navigation and Function Button

Button	Description	
	Back	Tap to return to the previous screen.
	Home	Tap to return to the Home screen.
	Recent Apps	Tap to view and switch between recently used apps. The Screenshot button also appears when selected.
	Scan	Tap the front (on-screen) Scan button to trigger the scanner.
	Volume	Press the top of the Volume button to raise the speaker volume. Press the bottom of Volume button to lower the speaker volume.
	Scan	Press the right or left Scan button to trigger the scanner.
	Push-to-Talk	Dedicated Push-to-Talk button on CT45 XP models only. See About Apps with Push-to-Talk Functionality on page 53.

Button	Description	
	Power	<p>Press and release the Power button to activate or exit Screen Timeout mode (see page 65).</p> <p>Press and hold the button for approximately 3 seconds, and then release to view the options menu.</p> <ul style="list-style-type: none"> • Power - select Power off or Restart • Swap Battery - CT45 XP models only, see page 7 • Emergency <p>Perform a manual restart if touchscreen is unresponsive (see page 95).</p>

Remap a Button

You can change the default function of the Left Scan, Right Scan, Volume Up and Volume Down buttons as well as the Back, Home, and Recent virtual buttons.

Note: The Push-to-Talk button cannot be remapped.

1. Swipe up from the bottom of the Home screen to access all apps.
2. Tap **Settings**  > **Honeywell Settings** > **Keyremap**.
3. Tap the plus sign (+).
4. Press the button you want to remap or select one of the virtual buttons.
5. Tap **OK**.
6. Select one of the following options:
 - Tap **Keys** to view available functions. Select the function you want assigned to the button.
 - Tap **Apps** to view available applications. Select the application you want assigned to the button.
 - Tap **Actions** to enter an Intent or Broadcast. Tap **OK** to assign the action to the button. For example, to start an Intent, type `com.android.settings/com.android.settings.wifi.WifiSettings`.
 - Tap **Command** to enter a command that will be executed when the button is pressed. This option supports all ADB shell commands. For example, if you choose a button to remap and enter the command `input keyevent 64`, pressing the selected button will open the web browser on the device.
 - Tap **Text** to type characters to display when the remapped key is pressed. Use a comma “,” to separate the characters. Tap **OK** to assign the text to the button. Examples are listed below:



Input Text	Button Press
A,A,B	aab
SHIFT_LEFT,A,SHIFT_LEFT,B or CAPS_LOCK,A,CAPS_LOCK,B	AB
SHIFT_LEFT,1	!
CTRL_LEFT,A	(Select All)
VOLUME_UP	(Volume Up)

Note: Lower case text is not supported in the **Text** field. Text must be entered in upper case. For example, “H,e,l,l,o” will display as “h”, whereas “H.E.L.L.O” will display as “hello”.

7. Tap **Keys** or **Applications** to view the available functions.
8. The function you selected now appears next to the button name.

Restore Default Button Action





To restore the button default action:

1. Swipe up from the bottom of the Home screen to access all apps.
 2. Tap **Settings**  > **Honeywell Settings** > **Keyremap**.
 3. Tap the clean icon .
 4. Choose the remapped button(s) you want restored to the default setting.
 - Tap the check box next to the button.
- OR
- Tap **All Select** to choose all the buttons.
5. Tap **Delete**.

About Status Bar Icons

Status and notification icons show you the current status of your network, the battery, notifications, and sounds. Use the table below to understand some of the most common icons.

Status and Notification Icons

Icon	Description	Icon	Description
	Pending alarm and Alarm is set.		Vibrate mode is turned on.
	New text message or multimedia message.		Airplane mode is turned on.

Icon	Description	Icon	Description
	Error with text or multimedia message delivery.		Bluetooth is turned on.
	New email		SD card is full.
	Computer is connected to a PC with a USB cable.		Wi-Fi network connected with full signal strength.
	Synchronizing data.		Wi-Fi network connected but no signal strength.
	Error with sync or sign-in.		Phone connected with full amount of bars.
	Computer is connected with Ethernet.		Phone connected with full amount of bars but no Internet connection.

View and Manage Notifications

You can view recent events on the computer, manage system notifications, change a setting or quickly respond to an app notification by opening the notifications panel.

When a notification icon appears in the status bar at the top of the screen:

1. Swipe down from the top of the screen to open the notifications panel.
2. Respond to the notification. You can take one of the following actions:
 - Tap the notification to open the associated app.
 - Tap a quick-reply or action command (e.g., Reply, Archive) if available.
 - Swipe the notification sideways, off the screen to dismiss it. Note that some notifications cannot be dismissed.
 - Slide the notification left or right to reveal the settings icon . Choose between **Stop notifications** or **Keep showing**.

To close the notification panel, swipe up from the bottom of the screen, or tap the **Back** or **Home** buttons.

Open Quick Settings

Use the Quick Settings screen to quickly access common settings. Tap an icon to toggle the feature On/Off or to open additional settings.

- To open Quick Settings swipe down once from the top of the screen. The most common settings are at the top of the screen. Swipe down again to expand Quick Settings. Once expanded, you can swipe right to left to view additional settings.
- To close Quick Settings, swipe up on the screen.

Customize the Home Screen

You can add application icons to any Home screen for easier access.

1. Swipe up from the bottom of the Home screen to access all apps.
2. Tap and hold the app you want to add, and then move it slightly. The computer switches to a smaller view of the Home screen panels.
3. Drag and drop the app icon into place.
 - If you want to add another Home screen, drag the icon to the right edge of the screen before releasing the icon.
 - If you want to create a folder, drag and drop the icon on top of another icon.

To add widgets or customize the look of the Home screen:

1. Tap and hold an empty section of the Home screen.
2. Select either **Wallpapers**, **Widgets**, or **Home Settings**.

Customize the Favorites Tray

Modify the Favorites tray to contain the apps you use the most.

1. Tap and hold the app you want to replace on the Favorites tray, and then move it slightly.
2. Drag and drop the app on “**X Remove**” at the top of the screen if you want to discard it or simply move it out of the favorites tray to an empty section on the Home screen.
3. Swipe up from the bottom of the screen to access all apps.
4. Tap and hold the icon of the app you want to add, and then move it slightly.
5. Drag and drop the icon into position on the Favorites tray.

Use Google™ Search

Use the Google Search field on the Home screen to help you find anything you need on the computer or on the web.

1. On the Home screen, tap inside the Google Search box and begin to type your search term.

As you type, suggestions from Google web search appear below the Search box, and results from the computer (such as apps or contacts) appear below the web search results.

2. Tap a suggestion to search for it immediately, or tap the arrow to add the term to the search field without starting to search.

About Screen Gestures

Use your fingers or the stylus to manipulate icons, buttons, menus, the on-screen keyboard, and other items on the screen.

- **Tap**

Tap to select something, toggle a setting on or off, or activate a field for text entry. An on-screen keyboard automatically appears for text entry.

- **Tap and hold**

Tap and hold an item but do not lift your finger or stylus until an action occurs.

- **Drag and drop**

Tap and hold an item, and then slide your stylus or finger across the screen until you reach the target position. Lift your finger or stylus off the screen to drop the item in place.

- **Swipe**

Quickly move your finger across the screen, without pausing when you first touch the screen. For example, you can swipe a Home screen left or right to view the other Home screens.

- **Slide**

Slowly move your finger across the screen, without pausing when you first touch the screen. For example, you can slide a notification to the left until the Settings gear is revealed.

- **Double-tap**

Tap quickly twice on a web page, map, or other screen to zoom in. Double-tap again to zoom out.

- **Pinch**

In some apps, you can zoom in and out by placing two fingers on the screen at once and pinching them together (to zoom out) or spreading them apart (to zoom in).

Set the Time Zone

The computer gets the current date and time from its network connection. If preferred, you can change this behavior and manually set the time zone for your location.





1. Swipe up from the bottom of the Home screen to access all apps.
2. Tap **Settings**  > **System** > **Date & Time**.
3. To change the time, tap **Use network-provided time** to turn off the feature.









- a. Tap **Date** then select a date from the calendar and click **OK**.
- b. Tap **Time** then use the clock to select a new time and click **OK**.
4. To change the time zone, tap **Use network-provided time zone** to turn off the feature.
 - a. Tap **Time zone** and choose the time zone for your location.
 - b. Press the back arrow to return to the Date & time screen.
5. The Time Format defaults to **Use locale default**. Tap **Use 24-hour format** to change the time display.

About Honeywell Applications

Honeywell applications help you troubleshoot and connect your computer to other devices and networks. Some of the applications in this table are located in the Power Tools app. To learn more about Honeywell Power Tools, go to sps.honeywell.com to download the *Power Tools User Guide*.

Honeywell Applications Available on the Computer

Icon	Application	Description
	AutoInstall Settings	Enable the AutoInstall feature, to automatically install *.zip or *.apk files containing applications saved in the Internal shared storage\honeywell\autoinstall folder and IPSP card\honeywell\autoinstall folder on the computer during the power-up boot or reboot process.
	Demos	Honeywell Demo apps demonstrate the basic capabilities of the computer and are not intended as functional business solutions. The demos included demonstrate scanning, signature capture, NFC functionality, and printing via Bluetooth technology. Information on how to create custom applications for your Honeywell mobile computer can be found in the Honeywell Software Development Kit (SDK) for Android, available from the Technical Support Downloads Portal .
	HUpgrader	Use the HUpgrader app to view the current OTA version on the computer, check for updates, or initiate an OTA upgrade from storage.
	Scanner Edge	Use the application to: <ul style="list-style-type: none"> • View connected devices. • Pair with a Bluetooth Scanner. • Disconnect a Bluetooth Scanner.
	SIM Selection	The SIM Selection app only appears on CT45-L1N-x, CT45P-L1N-x models equipped with dual SIM slots. Use the SIM Selection app to configure and switch between two SIM cards installed in the computer. See About the SIM Selection App on page 47 for more information.

Icon	Application	Description
Power Tools		
	BattMon	BattMon provides information on the charge status and health of the battery, and provides access to activate battery status notifications and battery charging history logs.
	ConfigApps	The ConfigApps Power Tool gives you the ability to enable or disable apps installed on the computer and to uninstall app updates that may be causing storage or performance issues. You can also view the total number of apps on the computer and the total number of apps currently disabled.
	Configure Autorun	Configure Autorun provides the ability to set applications to automatically run after a reboot.
	Diagnostic Information	Diagnostic Information provides access to system statistics, notifications and version information about the computer.
	EZConfig	EZConfig supports advanced customization and configuration of the hand held computer. EZConfig includes a standard XML editor and configuration barcode scanner feature.
	OBDQuickLink	Use Honeywell OBDQuickLink to write, erase, or update the NFC connection between the CT45/CT45 XP computer and the CT45/CT45 XP Vehicle Dock. This app does not receive any data from the On-Board Diagnostics (OBD) system adapter. Refer to the CT45/CT45 XP Vehicle Dock Quick Start Guide for more information.
	WiFi Diagnostic	Use the application to: <ul style="list-style-type: none"> • View Wi-Fi radio status information about a connected access point or a list of other available access points in range of the Wi-Fi radio. • Use the Route utility to view packet destination gateway information across the subnets. • Use the IPConfig utility to view IP parameters for the on-board network adapters. • Use the Ping utility to verify communication links or to make sure a specific IP address is working.
	Wireless Tether	Use to enable range tracking and customize out-of-range alerts for Bluetooth devices paired and tethered to your hand held computer.

Applications You Can Download to the Mobile Computer

You can download Honeywell applications to extend the capabilities of the computer. You may need to purchase a license to run some applications. To learn more about the applications described in this section and other Honeywell software solutions, go to sps.honeywell.com > **Products** > **Software**.

About Honeywell Enterprise Browser

Enterprise Browser for Microsoft® Internet Explorer® is a locked-down enterprise Web client application designed for Honeywell computers. It provides a controlled Web application environment that helps enterprises increase productivity and reduce IT management expenses. You can configure Enterprise Browser for your specific application requirements and design custom web applications that run through the Enterprise Browser to provide your users with an easy-to-use yet controlled experience.

If Enterprise Browser is not included on your computer model, you can download a trial version for evaluation. After the evaluation period expires, you need to purchase a license. For more information about Enterprise Browser, visit sps.honeywell.com.

About Terminal Emulators

Honeywell offers several terminal emulator solutions that allow users to manage their mobile devices by providing reliable data transfer between the host mobile device and terminal. Terminal emulators can be used for remote management and configuration of devices, data collection and analysis, and session management.

Depending on the computer model, a terminal emulator may come preinstalled on the device. If a terminal emulator is not included on your model, you can download a trial version for evaluation. After the evaluation period expires, you need to purchase a license. For more information, visit sps.honeywell.com.

About Honeywell Launcher

Launcher is a configurable locked-down menu program designed for Honeywell computers that prevents end-users from accessing the start menu and other non-authorized applications. Use Launcher to provide a platform where your mobile computer users are limited to running only company-approved applications and prevent them from initiating unauthorized configuration changes. You can also use Honeywell Launcher together with Honeywell Enterprise Browser to create a single-purpose device configuration.

If Launcher is not included on your computer model, you can download a trial version of the software for evaluation. After the evaluation period expires, you need to purchase a license. For more information about Launcher, visit sps.honeywell.com.

Honeywell UEMConnect

Honeywell UEMConnect enables customers to use the Google OEMConfig protocol to perform enterprise configuration and enhance the management of Honeywell Mobility Edge™ devices. It seamlessly integrates with EMM solutions to expose Honeywell management extensions directly on the EMM console. UEMConnect provides exclusive access to over 260 advanced Honeywell

proprietary settings and provides supplemental access to standard EMM features. EMM providers may also make use of generic Android APIs to provide standard EMM functionality.

Honeywell UEMConnect is available for download in the Google Play™ store. UEMConnect licenses are included with the purchase of applicable SOTI offerings through Honeywell or may be purchased separately for applicable EMM solutions not purchased through Honeywell.

Unlock Developer Options

Developer options only appear in the Settings app if you unlock the feature. If you are a developer working with the computer, you can easily unlock the additional settings to use for testing and debugging applications under development for the computer.

1. Swipe up from the bottom of the Home screen to access all apps.
2. Tap **Settings**  > **About phone**.
3. Tap **Build number** seven times. A message appears informing you that you are now a developer.
4. Open **Settings** > **System** and scroll to the bottom of the list.
5. Tap **Advanced**.
6. Tap **Developer options**.

USE THE IMAGER

Use this chapter to understand how to scan barcodes, configure the scan settings, and capture images using the integrated image engine in the computer.

About the Imager

The CT45/CT45 XP series offers three Honeywell high-performance imager options:

- S0703 Imager
- N6700 Imager (CT45 XP only)
- N6803 FlexRange™ Imager

You can use the imager in the computer as a scanner or camera.

Use the imager as a scanner to read 1D and 2D barcode symbologies, composite symbologies, and postal codes. It also supports omni-directional scanning for greater flexibility in real-world settings. By default, the scanner feature is enabled and uses the default scan profile. You can modify the **Default Profile** or create new profiles for custom applications from **Settings**  **> Honeywell Settings > Scanning**.

Use the imager as a camera to capture black and white images, such as signatures or pictures of damaged inventory.

Note: *Instead of using the internal imager, you can also use Bluetooth communications to connect the computer to an external scanner, such as the Granit™ 1990i and 1991i.*

About the Scan Wedge Feature

The scan wedge feature sends scanned barcode data to an active application as Android keypad input. To scan a barcode as keyboard input, open an application that accepts text input and then scan a barcode. You can use applications that are

coded to use the scanner or applications that receive data through the scan wedge feature. If an application claims the scanner through the BarcodeReader API, the scan wedge feature is temporarily disabled.

You can find information on how to create custom applications for the computer in the *Software Development Kit (SDK)* available for download from the *Technical Support Downloads Portal* at honeywell.com/PSSsoftware-downloads. Once you create an account and enter the portal, navigate to **Software > Software and Tools > Developer Library > SDKs for Android**.

Change the Scanner Settings

Changes you make to the Default profile apply to all applications with no profile assigned.

1. Swipe up from the bottom of the Home screen to access all apps.
2. Tap **Settings**  > **Honeywell Settings** > **Scanning**.
3. Tap **Internal Scanner** > **Default profile**.
4. Select from the following:
 - **Data Processing Settings,**
 - **Symbology Settings,**
 - **Decode Settings,**
 - **Imager Settings,**
 - **Trigger Settings,** or
 - **Notification Settings.**
5. Modify the settings to meet your application needs.

To learn more about the scanner settings, see [Default Scan Settings](#) on page 37.

Change the Bluetooth Scanner Settings

When the Bluetooth scanner is paired, changes can be made to the Default profile for the scanner.

1. Swipe up from the bottom of the Home screen to access all apps.
2. Tap **Settings**  > **Honeywell Settings** > **Scanning**.
3. Tap **Bluetooth Scanner** > **Default Profile** > **Data Processing Settings**.
4. Modify the settings to meet your application needs.

To learn more about the scanner settings, see [Data Processing Settings](#) on page 37.

Restore Default Scan Settings

You can easily discard all changes you made to the Default profile and restore the default values.

Note: When you choose the *Restore all defaults* option from a settings screen in a profile, all the settings in that profile return to their default values.

1. Open the **Default profile**.
2. Tap  in the upper right corner of any of the scan settings screens for the profile.
3. Tap **Restore all defaults**.

Default Scan Settings

Use the following sections to understand the scan settings available for scanner profiles. To learn how to create a new profile, see page [44](#).

Data Processing Settings

Use the Data Processing Settings to specify how barcode data is processed by the computer.

Data Processing Settings

Setting	Description	Default										
Wedge	Enable or Disable the scan wedge feature.	Enabled										
Wedge Method	Specify wedge method: Standard or Keyboard	Standard										
Charset	Select the character set to use when interpreting the barcode data into a string.	ISO-8859-1										
Prefix	Defines the string added before the decoded barcode data. Substitutions occur within the Prefix string values. <table border="1"><thead><tr><th>Substring</th><th>Replacement Character Code</th></tr></thead><tbody><tr><td>\r</td><td>13</td></tr><tr><td>\n</td><td>10</td></tr><tr><td>\t</td><td>9</td></tr><tr><td>\\</td><td>\</td></tr></tbody></table>	Substring	Replacement Character Code	\r	13	\n	10	\t	9	\\	\	None
Substring	Replacement Character Code											
\r	13											
\n	10											
\t	9											
\\	\											

Setting	Description	Default										
Suffix	<p>Defines the string added after the decoded barcode data. Substitutions occur within the Suffix string values.</p> <table border="1"> <thead> <tr> <th>Substring</th> <th>Replacement Character Code</th> </tr> </thead> <tbody> <tr> <td>\r</td> <td>13</td> </tr> <tr> <td>\n</td> <td>10</td> </tr> <tr> <td>\t</td> <td>9</td> </tr> <tr> <td>\\</td> <td>'\'</td> </tr> </tbody> </table>	Substring	Replacement Character Code	\r	13	\n	10	\t	9	\\	'\'	None
Substring	Replacement Character Code											
\r	13											
\n	10											
\t	9											
\\	'\'											
Wedge as Keys	List of character values to wedge as keys, represented as a comma-separated list of decimal values.	9,10,13										
Data Editing Plugin	Specify a Total Freedom data editing plug-in and edit plug-in settings.	None										
Symbology Prefix	<p>Specify a symbology identifier prefix to the barcode data. Options include:</p> <ul style="list-style-type: none"> • None • Honeywell • AIM 	None										
Launch Browser	<p>Enable or disable URL barcode handling. If a barcode starts with http:// or https://, the browser opens using the barcode data as a URL.</p> <p>Corresponds to BarcodeReader property: PROPERTY_DATA_PROCESSOR_LAUNCH-BROWSER</p>	Enabled										
Scan to Intent	<p>Enable or disable special handling of scan-to-intent barcodes.</p> <p>Applies to barcodes in one of the following formats: '/' ACTION '/' ACTION '\$' extra-data</p> <p>Where: ACTION and extra-data are any string of characters.</p> <p>Launches an application listening for the intent. Intent action: "com.honeywell.scantointent.intent.action." + ACTION Intent extra: "com.honeywell.scantointent.intent.extra.DATA" contains the remainder of the barcode data after the first '\$' character.</p> <p>Corresponds to BarcodeReader property: PROPERTY_DATA_PROCESSOR_SCAN_TO_INTENT</p>	Enabled										
Launch EZConfig	<p>Enable or disable special handling of EZConfig barcodes.</p> <p>Applies to EZConfig barcodes that are encoded with the Aztec symbology and contain specific header data.</p> <p>Corresponds to BarcodeReader property: PROPERTY_DATA_PROCESSOR_LAUNCH_EZ_CONFIG</p>	Enabled										

Setting	Description	Default
Data Intent	Enables the reception and processing of barcode data without using an SDK or library.	Disabled

Symbology Settings

Use the Symbology Settings to enable or disable barcode symbologies for the selected scan setting profile.

- Tap the check box next to a symbology name to enable (check mark) or disable (no check mark) decoding for that symbology.
- Tap the symbology name to view and modify additional configuration parameters for the symbology selected.

To view a list of default settings for supported symbologies, see [page 100](#).

Decode Settings

Adjust the Decode Settings when scanning barcodes that are densely packed or poor quality.

Decode Settings

Setting	Description	Default
Center Decode	<p>When enabled, the imager scans and decodes a barcode only if part of the barcode is at the center of the aimer window. This is useful in situations where several barcodes may be very close together in the imager field-of-view.</p> <ul style="list-style-type: none"> • Tap the check box to toggle the feature On or Off. • Select Center Decode to adjust the feature parameters. <p>Honeywell recommends leaving the window size settings at 50 (default) to define the “center” area for the barcode.</p> <p>Configurable parameters:</p> <ul style="list-style-type: none"> • Center Decode Timeout (ms) • Window top • Window bottom • Window left • Window Right 	Disabled
Decode Security	Use this setting to control the reading tolerance of the decoder. Lower settings are more lenient when reading low quality barcodes while higher values are more strict.	2
Decoder timeout	Set the amount of time in milliseconds that the scanner will timeout if a readable barcode is not found.	150

Setting	Description	Default
Decode Filter	<p>Use these settings to modify or reject data strings.</p> <ul style="list-style-type: none"> • Decode filter script The Decode Filter Script is used to configure a filter for decode results during scanning. For example, a filter could be used to reject barcodes that don't begin with certain characters, remove leading characters (like "00") from the beginning of a barcode, or only scan barcodes that begin with certain characters. • Decode filter timeout (ms) The decode filter timeout option can be used to disable the logic inside the filter script after a given amount of time. • Debug level Set the filter information level. The default level is 0, no information. Higher levels emit more information. Level 4 emits the most information. 	none
Poor Quality 1D Reading	Enable this setting when scanning damaged or badly printed 1-D barcodes to improve barcode read success.	Disabled
Video mode	<p>Use this setting to specify whether normal or inverse decoding for linear symbologies is enabled during the execution of Decode. By default normal video is enabled.</p> <p>Options include:</p> <ul style="list-style-type: none"> • Normal • Inverse • Normal and Inverse 	Normal
DPM mode	<p>Use this setting when scanning Direct Part Marking (DPM) barcodes that are etched or imprinted directly into the surfaces of materials including metal and plastic.</p> <p>Options include:</p> <ul style="list-style-type: none"> • No DPM optimization • Dotpeen DPM decoding • Reflective DPM decoding 	No optimization

Setting	Description	Default
Region of Interest	<p>Set the ROI for decoding. Options include:</p> <ul style="list-style-type: none"> • Disable ROI is disabled and the entire original image is sent to the decoder. • Standard Use the aimer position to weight activity. Activity calculated on the row and the column in the middle of each cell. The ROI window may not include the aimer. • Standard, aimer centered Activity calculated on the row and the column in the middle of each cell. The ROI window will always include the aimer. • DPM, aimer centered Activity calculated on 4 rows and 2 columns in each cell. The ROI window will always include the aimer. • Kiosk/presentation application Ignore aimer position, no weight activity. Activity calculated on the row and the column in the middle of each cell. The ROI window may not include the aimer. • Learning Engine When selected, the computer will receive continuous updates to improve the decoder software based on your specific environment. The Staging Hub Agent must also be enabled. 	Disabled
Multicode Scan	<p>When you enable Multicode Scan, each barcode is checked to see whether it satisfies the defined multicode rules before the results are transmitted. Options include:</p> <ul style="list-style-type: none"> • Enable or disable multicode scanning. • Set the number of barcodes. • Specify a separator to be used between barcodes. • Define up to 10 barcodes to be included in the multicode. • Set a timeout in milliseconds. If set with a non-zero value, the timeout starts after the scan button is pressed. Once the timeout occurs, scanning will return to standard (single) barcode mode. • Enable or disable the transmission of an incomplete multicode. When enabled, the incomplete multicode is transmitted when the incomplete transmission timeout expires. • Set a timeout in milliseconds to use when incomplete transmission is enabled. If set with a non-zero value, the timeout starts after the scan button is pressed. Once the timeout occurs, the results that were collected before the timeout happened will be transmitted if they satisfy the defined multicode rules. 	Disabled

Setting	Description	Default
Preferred Symbology Settings	<p>Use this setting to establish which barcode has priority if more than one barcode appears on the same label.</p> <ul style="list-style-type: none"> Tap the check box to toggle the feature On or Off. Select Preferred Symbology Settings to adjust the feature parameters. <p>Options include:</p> <ul style="list-style-type: none"> Preferred Timeout (ms) The length of time the scanner will ignore a low priority barcode while it searches for a high priority barcode. If a high priority symbology is located during this period, then that data is read immediately. If the time-out period expires before a high priority symbology is read, the scanner will read any barcode in its view. The default is 500ms. Symbology Set the priority level (High or Low) for symbology codes. This is used when you want to specify one symbology as a higher priority over other symbologies in situations where both barcode symbologies appear on the same label, but the lower priority symbology cannot be disabled. If a code is set as a High Priority, the decode of that symbology is accepted immediately. If a code is set as a Low Priority, the decode is buffered to see if a decode of a preferred High Priority symbology can be found within a given timeout period. 	Disabled

Imager Settings

You should not need to modify the Imager Settings. The **Override Recommended Values** setting is disabled by default. The recommended Imager Settings are designed to work in a wide range of environments and should only be modified if you have an advanced understanding of imagers.

Trigger Settings

Use the Trigger Settings to configure how the scan buttons work.

Trigger Settings

Setting	Description	Default
Enable Scan Trigger	Enable or Disable activating the imager by pressing the side scan buttons or the virtual Scan button in the Scan Demo app.	Enabled
Scan delay	Set the minimum amount of time in seconds before the scanner can read another barcode.	0
Decode Timeout	Set the number of seconds before the scanner automatically turns off if the scan button is pressed and nothing has successfully decoded.	20

Setting	Description	Default
Trigger Scan Mode	Set read behavior on scan button press. Options available: <ul style="list-style-type: none"> • One Shot • Continuous • Read on release • Read on second trigger press 	One Shot
Same symbol timeout	Set the minimum buffer time in seconds before the scanner reads the same barcode. This can be adjusted to prevent inadvertent scans of the same barcode if the code is left in the scan field longer than the Decode Timeout limit. The default same symbol timeout is 1000 seconds.	Disabled

Notification Settings



Use the Notification Settings to configure how your computer responds when you scan a barcode.

Notification Settings

Setting	Description	Default
Good Read Notification	Enables or disables a good read notification. The notification consists of a green blink of the Good Read LED, a short beep, and an optional short vibration.	Enabled
Bad Read Notification	Enables or disables notification of a failed scan. The notification consists of a red blink of the Good Read LED, an error beep, and an optional short vibration.	Disabled
Vibrate On Notification	Enables or disables whether the computer vibrates when there is a good or bad read.	Disabled
Package Verification	Package verification automatically stores the package images from the near sensor to determine the context in which the barcode was read. This data can be used as proof of delivery and can be uploaded to Honeywell or customer cloud using SSClient or customer-specific software. Select the check box to turn the Package Verification setting on.	Disabled
Package Verification Max Folder Size (MB)	The maximum folder size allowed for the folder that stores Package Verification images. Images are stored in honeywell\ImageCapture\PackVerf_Images.	200 MB
Pkg Verify High Quality Image Save	Enable this option to add new images and delete old images when the maximum folder size is reached. If this is not enabled, new images will not be stored until files are removed by the user.	Disabled

Add a Scan Setting Profile

To create a scan setting profile for a custom app on the computer:

1. Swipe up from the bottom of the Home screen to access all apps.
2. Tap **Settings**  > **Honeywell Settings** > **Scanning** > **Internal Scanner**.
3. Tap  in the upper right corner of the app screen.
4. Take one of the following actions:
 - Tap the **profile name** field, and then add a new name.

OR

- Tap the **select an application** option, and then choose an app from the list.

The new profile appears on the Internal Scanner profile list. You can now select and modify the scan settings for the new profile.

Delete a Scan Setting Profile

1. Swipe up from the bottom of the Home screen to access all apps.
2. Tap **Settings**  > **Honeywell Settings** > **Scanning** > **Internal Scanner**.
3. Tap and hold the profile you want to delete, select **Delete** and then click **OK**.

About the Optional Digital Scan Button

By default, the imager is enabled for scanning with the left and right Scan buttons configured to trigger the imager. If your application environment requires use of an on-screen Scan button, enable the Digital Scan Button feature in the Settings app. Once enable, you can then modify the appearance of the on-screen Scan button and select the apps the button appears in.

Enable and Configure the Digital Scan Button

1. Swipe up from the bottom of the Home screen to access all apps.
2. Tap **Settings**  > **Honeywell Settings** > **Digital Scan Button**.
3. Tap **Enable Digital Scan Button** to turn the feature on. A preview of the button appears at the bottom of the screen.

4. Configure the button appearance. As you adjust the settings, the preview of the button updates.
 - Tap **Select Button Size** and then choose Small, Medium or Large.
 - Tap **Select Button Color** and then choose from seven color options. Default color is black. Tap a dot to select the color, and then select **OK** to confirm.
 - Use the slider under **Transparency Level** to adjust how transparent the button appears on the application screen.
5. Drag the preview of the Scan button to the location where you want it to appear on the screen. Once you have positioned the button, tap the **Set Button Location** toggle button to lock it into position.
6. Tap **Choose Application**.
7. Check the box next to all the applications where you want the digital scan button to be available.
8. Select **OK**.
9. Tap the **Back** arrow to return to the Settings screen.

The digital scan button appears on the screen when you open any of the apps you selected during the button setup. Tap and hold the button to activate the imager and scan a barcode.

Scan Barcodes

By default, the integrated imager is enabled for scanning. It supports omni-directional (360°) barcode scanning and an aiming beam is provided to help assist with targeting barcodes.

Before you start scanning barcodes, go into **Settings**  > **Honeywell Settings** > **Scanning** > **Internal Scanner** and modify the scan profile to enable only the barcode symbologies that you need. By reducing the active symbology list, you can increase scan speed.

1. Point the imager window at the barcode. For optimum performance, avoid reflections by scanning the barcode at a slight angle.
2. Press and hold any **Scan** button.
3. Center the aiming beam over the barcode. Make sure the entire barcode is inside of the illumination frame.
4. Release the **Scan** button when the computer beeps, and the Good Read LED briefly turns on. The barcode information is entered into the application in use.

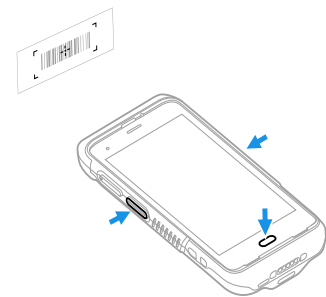

Note: *Not all barcode symbologies are enabled by default. If a barcode does not scan, the correct symbology may not be enabled.*

About Scanning Configuration Barcodes

After completing the out-of-box set up process, Provisioning mode is automatically turned off. Scanning a barcode to install applications, certificates, configuration files, and licenses on the computer is restricted unless you enable Provisioning mode in the Settings app.

To learn more [About Provisioning Mode](#), see page 83.

Use the Scan Demo App

Use the Scan Demo app to read barcodes or to test your symbology decode settings.

1. Swipe up from the bottom of the Home screen to access all apps.
2. Tap the **Demos** app.
3. Swipe left or right on the screen until **Scan Demo** appears under the turntable. Tap the center of the box image to open the app.
4. Point the imager window at the barcode.
5. Press and hold either side **Scan** button or tap **Scan** on the computer screen.
6. Center the aiming beam over the barcode. Make sure the entire barcode is inside of the illumination frame.
7. Release the **Scan** button when the computer beeps and the Good Read LED briefly turns on. Barcode information appears on the screen.

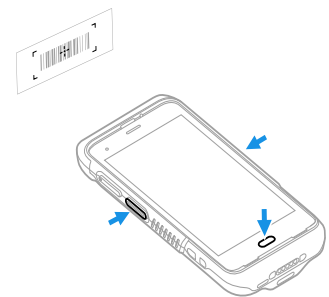

Note: In the Scan Demo app, not all barcode symbologies are enabled by default. If a barcode does not scan, the correct symbology may not be enabled.

Change the Scan Demo Symbology Settings

1. In the Scan Demo app, tap **⋮** in the upper right corner of the screen.
2. Select **Symbology Settings**.
3. Modify the symbology parameters.
 - Tap the check box next to a symbology name to enable (check mark) or disable (no check mark) decoding for that symbology.
 - Tap the symbology name to view and modify additional configuration parameters for the symbology selected.
4. Tap the **Back** arrow to return to the Scan Demo app.

USE THE PHONE

You can use the phone feature to make and receive phone calls as well as transmit data through wireless wide-area networks (WWANs).

Note: *Phone features are only supported on CT45/CT45 XP WWAN models (CT45-L1N, CT45P-L1N).*

About the Phone

Phone features on the computer include dual speakers and three microphones for noise cancellation. You can also use a hands-free kit or headset that supports Bluetooth® wireless technology.

On WWAN models, the phone feature is enabled by default. Refer to the product Data Sheet for supported cellular radio access technologies that you can use for voice and data connections.

After you turn on the phone and activate service with your wireless carrier, you can customize the phone features and network settings in the Network & internet section of the Settings app.

A dedicated PTT button on the right side of the unit is provided for use with applications that support push-to-talk (PTT) functionality.

Note: *WWAN radios support Network Information and Time Zone (NITZ) messages to automatically set the system time.*

About the SIM Selection App

Supported SIM type and activation method varies by model and model configuration. During the SIM activation process and/or after activation, you may need to utilize the SIM Selection app to provision the computer to your specific use case. This section provides information about navigating the SIM selection app and the features available. See [Activate the Phone](#) on page 50 for information on how to activate the phone.

Use the SIM Selection app to configure the SIMs on the mobile computer. You can select which SIM is being used (SIM 1 or SIM 2) by assigning a SIM to SIM Slot 1. You can also use both SIMs at the same time by enabling Dual SIM Dual Standby mode. Both SIMs can be activated by either the same or different mobile carriers.

In Dual SIM Dual Standby mode, both SIMs can connect to selected mobile networks. For example, you can have two phone lines on your mobile computer where one is your business number and one is your personal number. You can also choose which SIM to use for specific actions, such as calls or messaging. These actions are defined in **Settings > Network & internet > Mobile network**.

To access the SIM Selection app, swipe up from the bottom of the Home screen to access all apps then tap **SIM Selection** .

The app home screen shows the current SIM configuration.

Using Single SIM Mode

In Single SIM mode, the SIM assigned to SIM Slot 1 in the **Current Configs** section is the only active SIM.

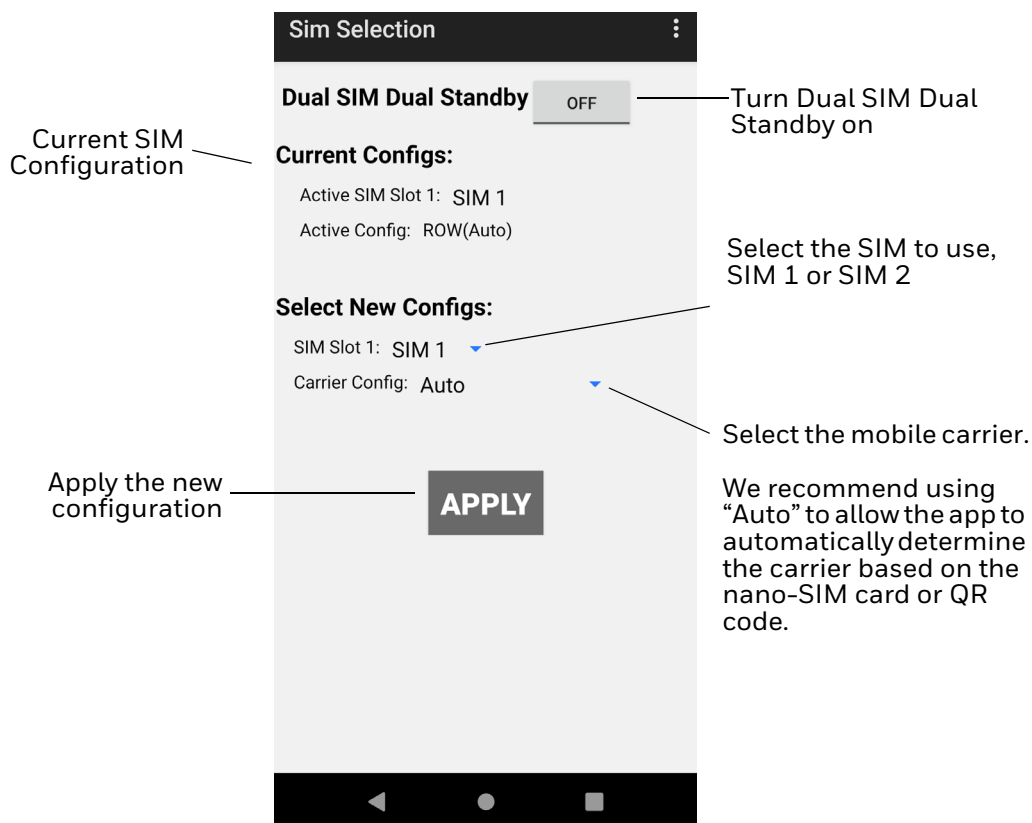

Assigning a SIM to SIM Slot 1

To assign a SIM to SIM Slot 1:

1. Swipe up from the bottom of the Home screen to access all apps.
2. Tap **SIM Selection** .
3. Under **Select New Configs**, tap the arrow ▼ next to SIM Slot 1.
4. Select the SIM from the drop-down list.
5. Click **APPLY**.
6. A prompt verifies that you want to apply the new configuration. Tap **OK**.
7. The system indicates that the settings have been saved. Tap **OK**.

Using Dual SIM Dual Standby Mode

The CT45/CT45 XP allows you to enable a Dual SIM Dual Standby (DSDS) setup where both SIMs are provisioned with separate mobile plans. In DSDS, both SIMs are active but only one SIM can handle data at a time.

When DSDS mode is turned ON, both SIM Slots are shown. In this mode, SIM Slot 1 and SIM Slot 2 cannot be modified.

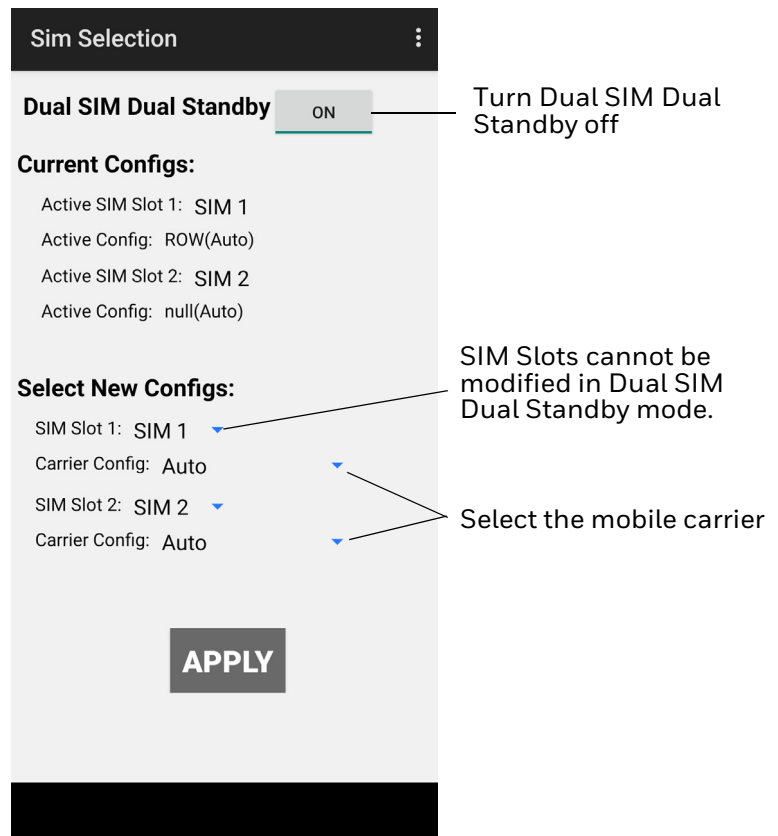

Enabling Dual SIM Dual Standby

To enable Dual SIM Dual Standby:

1. Swipe up from the bottom of the Home screen to access all apps.
2. Tap **SIM Selection** .
3. The button next to **Dual SIM Dual Standby** indicates if it is on or off. To enable DSDS, tap the **OFF** button.
4. A pop-up indicates that the device must reboot to enable DSDS mode. Click **OK**. The device reboots. After the device has restarted, the button next to **Dual SIM Dual Standby** will display **ON**, and SIM Slot 1 and SIM Slot 2 will be displayed in the app.

About Auto Carrier Config Selection

The SIM Selection app provides the ability to manually select the carrier configuration you want to use; however, we do not recommend manually selecting the carrier unless there is an issue with connecting to the WWAN network. When Carrier Config is set to “Auto,” the carrier will be selected automatically based on the carrier-provided nano-SIM card or the QR code scanned for the eSIM. If you need to change the carrier manually, select your carrier’s name from the Carrier Config drop-down list. If there is not an appropriate option, select “ROW” (Rest of World).

Activate the Phone

You can use either a nano-SIM card or eSIM (on supported CT45 XP models) to activate the phone and connect to a mobile network. Available SIM options are model and mobile carrier dependent. Contact your mobile service provider to obtain a nano-SIM card, QR code for eSIM provisioning, or for additional details on phone network activation.

Available Configurations:

- CT45 WWAN models include two nano-SIM card sockets.
- CT45 XP WWAN models include either two nano-SIM card sockets (agency model CT45P-L1N-2) or one nano-SIM card socket and eSIM (agency model CT45P-L1N-E).

On agency model CT45P-L1N-E, the SIMs are identified as:

- SIM 1 = Removable nano-SIM card
- SIM 2 = eSIM

Depending on your model configuration and use case, refer to one of the following setups to provision your mobile computer.

- [Provision a nano-SIM Card](#) on page 51
- [Provision eSIM](#) on page 52
- **Using Dual SIM Dual Standby Mode** on page 49

Provision a nano-SIM Card

Follow these steps if you are using a removable nano-SIM card to provision the mobile device.

Note: On CT45 XP WWAN models with an eSIM, you do not need to install a nano-SIM card unless you want a dual carrier setup.

1. Press and hold the **Power** button until the options menu appears.
2. Tap **Power off** or **Power > Power off**, depending on your computer model.
3. Remove the battery from the computer. Refer to [Remove the battery](#) on page 7.
4. Lift up the edge of the SIM card access door.

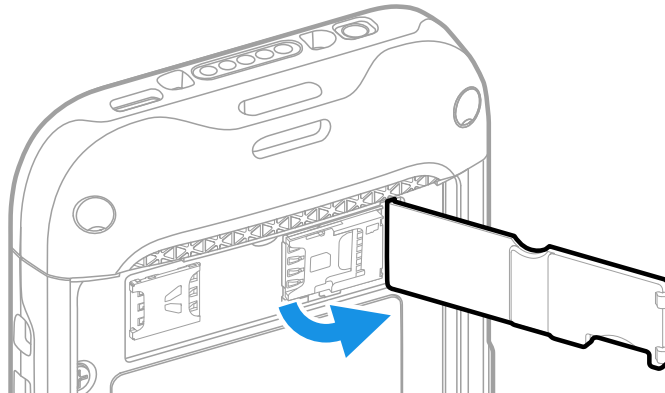

5. Slide the nano-SIM card into the card socket.
 - a. SIM 1: Slide card into bottom of dual socket with contacts facing down.

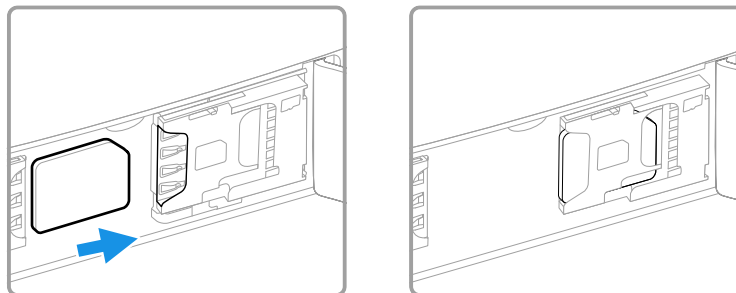

- b. Optional - SIM 2 (model dependent): Slide the nano-SIM card into the socket with contacts facing down.

Note: On CT45 XP WWAN models with an eSIM instead of a second nano-SIM socket, the eSIM is SIM 2. For more information, see [Provision eSIM](#) on page 52.

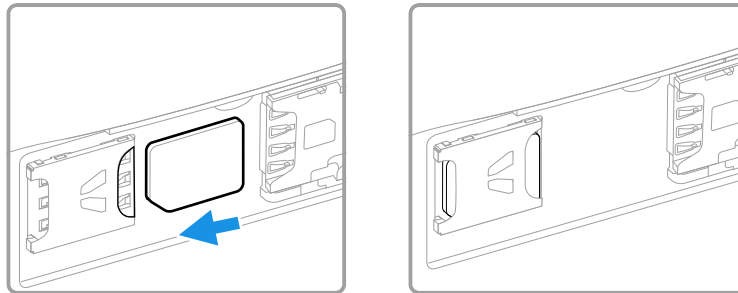

6. Close the SIM card access door.
7. Install the battery. Refer to [Install the Battery](#) on page 8.
8. Follow your phone carrier instructions for activation and connection to a mobile network. By default, the nano-SIM card installed in SIM 1 is assigned to SIM Slot 1, which is used for phone activation.

If you installed a second nano-SIM card in SIM 2, you must first use the SIM Selection App to assign the SIM 2 card to SIM Slot 1 before you activate the second card. For more information, see **Assigning a SIM to SIM Slot 1** on page 49.

If both nano-SIM cards are activated, you can use them both in Dual SIM Dual Standby mode. For more information, see **Using Dual SIM Dual Standby Mode** on page 49.

Provision eSIM

Follow these steps to provision the mobile computer if you are using the embedded SIM (eSIM), available on supported CT45 XP models. On these models, the eSIM is SIM 2.

To connect to a mobile network using eSIM, the eSIM must be provisioned by downloading and enabling an operational profile. Mobility Edge devices use the Thales LPA (Local Profile Assistant) app to download carrier profiles to the eSIM and manage the downloaded profiles.

Mobile computers are enrolled by scanning a QR code. Contact your mobile carrier to obtain the QR code and any other information required to activate the profile.







Download a Profile

The mobile computer must be connected to a Wi-Fi network to download the profile. For more information, see [Network & Internet](#) on page 62.

1. Assign the eSIM to SIM Slot 1, which is used for phone activation. Refer to **Assigning a SIM to SIM Slot 1** on page 49.
2. Swipe up from the bottom of the Home screen to access all apps.
3. Tap the **Thales LPA** app.
4. On the home screen, tap the plus sign.
5. Tap the QR code icon.
6. Scan the QR code.
7. The Activation Code value is displayed. Click **NEXT**.
8. If the profile is configured to require additional input, enter the information provided by your mobile carrier.
9. When the profile has downloaded, it will be listed on the app home screen. Tap the slider to enable the profile.

Make a Phone Call

Once the phone is activated, you can make a phone call.



1. Tap  in the favorites tray to open the phone app.
2. Use one of the methods below to enter the telephone number you want to call.
 - Tap  and use the on-screen dialer.
 - Select a person on your saved contact list .
 - Select a favorite on your speed dial list .
 - Select a number from the recent calls list .
3. Tap call .
4. To end the call, tap .

About Apps with Push-to-Talk Functionality

The CT45/CT45 XP series provides a dedicated push-to-talk button for use with common apps that support push-to-talk functionality for voice over IP (VoIP) calls over Wi-Fi or cellular data network connections. Once an app with push-to-talk functionality is installed and opened, the button can be used to initiate a call after selecting a contact from within the app.

Answer the Phone

When you receive a phone call, the Incoming Call screen opens. If the caller's telephone number is available, it appears on the screen. Depending on your calling plan, you may also see a Caller ID information. All incoming calls are recorded in the Call log. If you miss a call, you receive a notification.

1. On the Incoming Call screen, tap and hold the white call icon.
2. Three icons appear:
 - To answer the call, drag the icon to .
 - To send the caller directly to voice mail, drag the icon to .
 - To send a text message back to the caller instead of answering, drag the icon to .

Switch Apps During a Phone Call

You can multitask while a phone call is in progress. For example, you can use the Calendar app to check your schedule during a call.

Note: *Depending on your WWAN connection and carrier, apps that need a data connection may be unable to access online data while the phone call is in progress. If simultaneous phone calls and data connections are not possible due to provider limitations, voice calls receive priority. Check with your provider for more information.*



1. During a phone call the screen goes dark. Take the phone away from your ear to wake the screen. Tap the **Home** button.
2. Select another app (e.g., Calendar, Contacts). The phone icon appears in the status bar at the top of the screen while the call is connected.
3. To return to the call screen, swipe down from the top of the screen and select ongoing call notification or select **Hang up** if you want to end the call.

Make an Emergency Phone Call

You can use the phone to make an emergency phone call even if the SIM card is missing from your phone. The phone shows no service but the call still goes through if you dial certain emergency numbers (e.g., 112, 911, 000, 08, 118, 119, and 999).

Configure Phone Settings

You can customize settings for the phone, including the ringtone, voicemail options, keypad tones, Internet call settings, and other options.

1. Open the phone app .
2. Tap  next to the microphone icon at the top of the screen.
3. Select **Settings**. The Call settings menu appears.
4. Change phone settings as necessary.

Note: Available settings vary depending on your cellular carrier and phone plan.

USE THE CAMERA

Use this chapter to learn how to take pictures and record videos with the color camera(s).

About the Color Camera

The CT45/CT45 XP Series comes equipped with two cameras, a 13-megapixel color camera on the back of the computer and an 8-megapixel camera located on the front. Both include 4K video support with image stabilization and advanced software features for enhanced exposure control when taking pictures and videos.



Use the **Photos** app  to view photos and videos stored on the mobile computer. By default the photos and videos captured with the Camera app are saved on the computer under Internal shared storage\DCIM\Camera.

How to Zoom

The camera zoom is controlled using a pinching motion on the touch screen. Place two fingers on the screen at the same time, and then:

- spread your fingers apart to zoom in (enlarge an object), or
- pinch them together to zoom out.

Take a Photo







1. Tap the **Camera** icon  in the favorites tray on the Home screen.
2. Select  to switch between the front and rear camera. The front camera does not include a Flash feature.
3. Using the screen as a viewfinder, move the computer until you see the image you want to capture.

4. The camera automatically adjusts the focus but you can tap the screen to modify the focal point. By default, the camera senses the lighting in the environment and turns the flash on, if needed.
5. Tap  or the Volume button to take a photo.
 - To view the picture, tap the preview near the bottom of the screen.
 - To return to the Camera app, tap the **Back** navigation button.

Note: Tap **ProMode** to manually control settings for focus, white balance, ISO exposure, and zoom.

Record a Video

This section explains how to record video with the camera in the computer.

1. Tap the **Camera** icon  in the favorites tray.
2. Tap **Video**.
3. Tap  to start recording video.
 - To zoom in or out, pinch or spread your fingers apart.
 - To toggle sound recording on or off, tap the microphone icon at the top of the screen.
 - To pause recording, select . To resume recording, tap .
 - To capture a still picture during recording, tap the **Camera** icon .
 - To add light while recording, tap the flash icon. Flash is only available with the rear camera on the back of the computer.
4. When you are done recording, tap .

Change Camera Settings

You can change the camera settings for best results when taking pictures. The camera settings are adjustable from within the Camera app.

1. Open the **Camera** app .
2. Select **Video**, **HFR** (High Frame Rate), **Photo**, or **ProMode**.

3. At the top of the screen, select any of the following to adjust the settings. The options vary depending on camera mode selected. When ProMode is selected, options appear directly above the camera mode names.

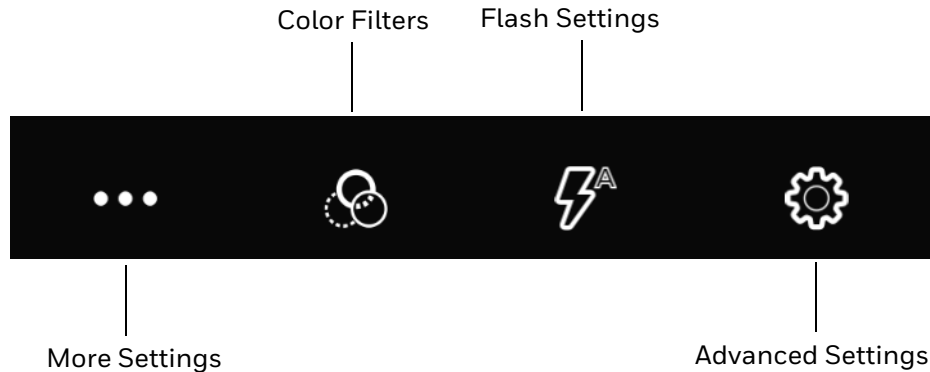

- **More Settings**

Select to access HDR, Automatic and Advanced settings.

HDR

Tap to quickly toggle HDR mode on or off. When enabled, the computer automatically captures multiple photos and combines them into one photo creating the best quality image possible.

Automatic

Select Automatic to have the camera automatically adjust the settings and focus for you.

- **Color Filters**

Stylize your pictures by applying a filter. Options include: None, Mono, Sepia, Negative, Solarize, Posterize, and Aqua.

- **Flash Setting**

Select to adjust the camera flash setting (e.g., automatic, no flash, or always flash). This option is only available for the rear camera.

- **Advanced Settings**

Select the gear  to access settings that allow you to modify the camera setting defaults and to configure how the camera app functions (i.e., General, Still camera, Video camera, System).

Use the Camera as a Flashlight

To use the rear camera as a flashlight.

1. Open Quick Settings (see page [27](#)).
2. Tap the Flashlight icon to toggle the flashlight On or Off.

Note: The flashlight feature only works if the camera app is closed.

CONFIGURE THE COMPUTER

Use this chapter to learn about the available methods for configuring your mobile computer. You can also use this chapter to learn how to configure network communications and wireless security.



How to Configure the Computer

You can configure many parameters on the computer such as the barcode symbologies it decodes or the network settings. The values you set for these parameters determine how the computer operates.

You configure the computer using the Settings app. Or you can use the Wi-Fi Staging app to set up multiple devices with the same base configuration (see page [84](#)).

Start the Settings App

The Settings app is available from the all apps menu and the notification panel.

- Swipe up from the bottom of the Home screen, and then tap **Settings** .
- OR
- Swipe down twice from the top of the Home screen, and then select .

About the Structure of the Settings App

Use this section to learn about the structure of the Settings app so you can find parameters quickly. A search field appears at the top of the screen when you open the Settings app to help you locate settings quickly.

Note: *The Settings app varies by computer model and OS version. Your computer may not include all the features outlined in this section.*

Network & Internet

In the Settings app, select **Network & internet** to access the following settings.

Setting	Description
Wi-Fi	<ul style="list-style-type: none"> • Turn Wi-Fi radio on or off. • Lists available Wi-Fi networks in range and the connection status when the radio is turned on. • Add a network Wi-Fi connection and view saved networks. • Tap Wi-Fi preferences to access advanced Wi-Fi options, view MAC and IP address information, access Honeywell Wi-Fi settings (see page 74), and import and export Wi-Fi configurations.
Mobile network (WWAN models)	<p>Modify mobile network settings, including enabling data access and roaming over mobile networks, selecting access points and network operators, or selecting only 2G networks (to save battery life).</p> <ul style="list-style-type: none"> • Turn Mobile data On or Off. • Turn Roaming On or Off. • View Data use information. • Access advanced options, including: <ul style="list-style-type: none"> • 4G LTE Mode On/Off setting • Preferred network settings • CDMA roaming settings and subscription settings (i.e., RUIM/SIM, NV) • Access point name and selection • Network selection settings
Airplane mode	Turn Airplane mode on or off.
Ethernet	<ul style="list-style-type: none"> • Turn Ethernet connection on and off. • View last Ethernet connection information.
Mobile plan	Provides information on your cell phone plan.
Advanced	
Hotspot & Tethering	<ul style="list-style-type: none"> • Enable or disable Bluetooth tethering for sharing mobile data connections. • Enable or Disable using the computer as a portable Wi-Fi hotspot. • Configure Wi-Fi hotspot.
Data Saver	Turn the Data saver feature On or Off. Specify which apps can use unrestricted data.
VPN	Set the password parameters for a virtual private network (VPN) connection.
Private DNS	Select Private DNS Mode.

Connected devices

In the Settings app, select **Connected devices** to view current, connected devices and to access the following settings.

Setting	Description
Pair new device	<ul style="list-style-type: none"> Connect to a Bluetooth Device. Lists Bluetooth enabled devices in range. View and rename the computer. View the computer Bluetooth address.
USB	Select the type of communication: <ul style="list-style-type: none"> File Transfer USB tethering PTP No data transfer <p>Note: This setting only appears when the unit is connected via USB.</p>
Previously connected devices	View previously connected devices. <p>Note: This setting only appears once the computer has been paired with another device.</p>
Connection Preferences	
Bluetooth	<ul style="list-style-type: none"> Turn the Bluetooth radio On or Off. Lists Bluetooth enabled devices in range when the radio is turned On. Connect to a Bluetooth Device. View and rename the computer. View the computer Bluetooth address.
NFC	Turn Near Field Communication (NFC) On or Off. When the NFC radio is enabled, data exchanges are allowed when the computer touches another NFC enabled device.
Cast	Set up a Cast connection. Cast (project) audio and screen content to a secondary device such as a television.
Printing	Set up a printer connection with the CT45/CT45 XP. Connection options include cloud print services, Wi-Fi printing via a router, or printing via NFC.
Files received via Bluetooth	View statistics and received files.
Chromebook	Set up connection from the mobile computer to a Chromebook.
Nearby Share	Set up file sharing with nearby devices. The device location setting needs to be turned on for Bluetooth and Wi-Fi radios to detect nearby devices.
Android Auto	Use apps on your phone screen or car display. To learn more, go to Android Auto Help at https://support.google.com .

Apps & Notification

In the Settings app, select **Apps & Notifications** to access the following settings.

Setting	Description
Apps info	View a list of recently opened apps or select "See all . ." to view a list of installed apps on the computer and system services running.
Conversations	View conversations marked as a priority.
Notifications	Set rules for notifications.
Screen time	<ul style="list-style-type: none">Shows Screen time, Notifications received, Times opened.Allows to set app timer.
Advanced	
Default apps	View and manage default app use.
Permissions manager	View and manage individual app permissions.
Wireless Emergency alerts	Manage Emergency alert notifications.
Special app access	Manage apps with special unrestricted access.

Battery

In the Settings app, select **Battery** to view battery status, use statistics, and adjust features that conserve battery charge.

Note: Some settings in previous OS versions can be found in Display.

Setting	Description
Battery	View current battery charge or charging status.
Battery saver	Turn the Battery saver feature On or Off manually. Set a schedule, based on the battery charge percentage (%) remaining that automatically activates the Battery saver feature. Use the slider to set the battery percentage level. Slider adjusts from 5% to 7% and is only available once schedule is selected. When charging, set the battery saver feature to turn Off when the battery reaches 90%. Default setting.
Battery Manager	Turn the Battery Manager On or Off. Battery manager detects when apps drain the battery.
Battery percentage	Set to show or do not show battery percentage in status bar.
Last full charge	View time since the battery was fully charged.
Screen usage since last full charge	View amount of time when the screen was used since the battery was fully charged.

Display

In the Settings app, select **Display** to access the following settings.

Setting	Description
Brightness level	Set the Brightness level manually if Adaptive brightness feature is turned Off.
Dark theme	Enable dark mode to switch app backgrounds to a black color.
Night light	Activate the Night light feature to adjust the screen tint to a light amber for easier viewing and reading in dim light or for the hours you use the device before going to sleep. Set the feature to stay on or define a schedule to turn the feature On/Off. You can manually adjust the intensity of the amber hue once the feature is activated.
Adaptive brightness	Set how the screen in sleep mode responds when new notifications are received (e.g., wake or do not wake).
Wallpaper	Set the wallpaper.
Advanced	
Screen timeout	Set the inactivity time limit before the unit automatically turns of the screen to save battery power (seconds or minutes).
Auto-rotate screen	Set the screen to switch from portrait to landscape when the unit is rotated. When Off the screen does not automatically rotate.
Colors	Adjust the screen color settings (e.g., Natural, Boosted, Adaptive).
Font size	Set the default on-screen text size.
Display size	Set the default size of items on your screen.
Screen saver	Set the default screen saver as well as when to display it. Tap Settings to select screen saver style or to turn Night mode on.
Lock screen	Select what to show on the lock screen and when to display new notifications.

Sound

In the Settings app, select **Sound** to modify the audio and sound settings. To learn more, see [Audio Settings](#) on page 17.

Storage

In the Settings app, select **Storage** to view statistics on available and used storage space on the device and on any portable storage cards installed.

Privacy

In the Settings app, select **Privacy** to define privacy settings for the device.

Setting	Description
Permission manager	Define which apps have access to features on the device, such as the camera or microphone.
Show passwords	Briefly displays the characters in a password as you type before hiding them.
Notifications on lock screen	Select whether or not to show all notification content on the lock screen.

Setting	Description
Autofill service from Google	Automatically fill fields using saved data from your Google account.
Advanced	
Google location history	Enable or disable location history and manage or delete activity. A Google account must be associated with the device to use this feature.
Activity controls	Choose what type of activities are saved in your Google account. A Google account must be associated with the device to use this feature.
Ads	Opt in or out of ad personalization features. When this is on, ads are personalized with the activity and information from your Google Account.
Usage & diagnostics	Automatically send diagnostic, device, and app usage data to Google. By default, this setting is turned off.

Location

In the Settings app, select **Location** to define which apps have access to the device's location.

Setting	Description
Use Location	Turn location services (Google and GPS satellite data) On or Off. Set location mode accuracy and view location request history.
App access to location	View and manage app-level location service permissions.
Wi-Fi and Bluetooth scanning	Turn Wi-Fi and/or Bluetooth scanning On or Off. When enabled system apps and services are allowed to detect Wi-Fi networks or Bluetooth devices at any time to improve location services.
Advanced	
Emergency Location Service	Allows the device to automatically send its location to emergency locations.
Google Location Accuracy	Improves location accuracy by using Wi-Fi, mobile networks, and sensors to help estimate the device location.
Google Location History	Allows the device to report Location History to Google. A Google account must be associated with the device to use this feature.
Google Location Sharing	Allows the device to share its location with anyone in the contacts list.

Security

In the Settings app, select **Security** to view latest Security scan results, security updates and phone encryption status. Access additional settings related to device security.

Setting	Description
Google Play Protect	Manually initiate a scan of the apps on the device to check for problems.
Security update	Displays the last date security was updated on the device.
Find My Device	Allows users to locate, ring, or wipe a device remotely.

Setting	Description
Screen Lock	Activate and configure a screen lock (i.e., None, Swipe, Pattern, Pin, Password).
Smart Lock	Define safe conditions or locations where your phone will stay unlocked (e.g. On-body, Trusted places, Trusted devices, Voice Match).
Device admin apps	Manage administrator privileges.
Encryption & credentials	View encryption status and manage trusted credentials (e.g., view, install, clear, and edit).
Trusted agents	View and enable/disable trusted agent apps such as Smart Lock by Google on the device. Trusted agents bypass security based on set parameters.
App pinning	Enable or disable the screen pinning feature. When enabled, you can pin the device screen to a recently used app where it stays until you unpin the app via the security method chosen.

Accounts

In the Settings app, select **Accounts** to access the following settings.

Note: Some settings in previous OS versions can be found in System.

Setting	Description
Add account	Select to add and manage Corporate or Email account on the computer.
Automatically sync app data	Turn auto-sync On or Off for accounts. Turning the feature On allows apps to refresh data automatically.

Accessibility

In the Settings app, select **Accessibility** to access screen readers, display settings, interaction controls, and audio & on-screen text features to improve accessibility levels.

Setting	Description
Screen Readers	
Select to Speak	When turned on, you can tap specific items on the screen to hear them read aloud.
TalkBack	When turned on, the feature provides spoken feedback so you can use the computer without always looking at the screen. TalkBack describes your actions and tells you about alerts and notifications
Text-to-speech output	Select and configure the preferred TTS, set language, speech rate and pitch of synthesized voice.

Setting	Description
Display	<p>Configure display features that may aid visual accessibility levels.</p> <ul style="list-style-type: none"> • Adjust Font size. • Adjust Display size. • Turn Dark theme On/Off. • Turn the Magnification feature On/Off. • Set Color correction. • Turn Color inversion On/Off. • Turn Large mouse pointer On/Off. • Turn Remove Animations On/Off.
Interaction controls	<p>Set interaction controls that may aid physical accessibility levels.</p> <ul style="list-style-type: none"> • Accessibility Menu provides large on-screen menus. • Configure Switch Access. You can use a switch or keyboard to control your device. • Set the Dwell timing (Click after pointer stops moving) delay. • Turn the Power button ends call feature On/Off. • Turn Auto-rotate screen On/Off. • Adjust the Touch & hold delay. • Time to take action (Accessibility timeout). • Vibration & haptic strength. • Set System navigation (e.g., Gesture navigation or 3-button navigation).
Audio & on-screen text	<ul style="list-style-type: none"> • Turn Mono audio On/Off. • Set Audio balance if using headphones or hearing aids. • Turn Captions On/Off.
Experimental	<ul style="list-style-type: none"> • Turn High contrast text On/Off. • Turn Shortcut from lock screen On/Off.

Honeywell Settings

In the Settings app, select **Honeywell Settings** to access the following settings.

Setting	Description
Battery LED	Configures the battery LED behavior. To learn more, see Change the Battery Status LED Behavior on page 10.

Setting	Description
Battery Optimizer	<p>View battery status and app usage information.</p> <p>Tap Optimize Battery to create and enable or disable a battery optimization profile that implements a group of settings to conserve power.</p> <p>Options include:</p> <ul style="list-style-type: none"> • None When selected, no battery optimization profile is active. • Energy Saver This pre-defined profile implements UI settings that optimize battery conservation. • Cold Storage This pre-defined profile implements UI settings that optimize battery savings in cold storage environments. • Custom Profile Tap to create a custom battery profile that balances your application needs with energy saving settings. You can turn location services on or Off, configure sound and vibration options, modify brightness and timeout display options, turn UI transition animations On/Off and background services on or off.
Digital Scan Button	Enable and configure the optional digital scan button. To learn more, see About the Optional Digital Scan Button on page 44.
Display Dock	For information about these settings, see the CT4x Series Universal and Booted Accessories User Guide, available at sps.honeywell.com .
Honeywell Power Setting	Turn Unattended Mode On/Off. When Unattended Mode is On, healthcare apps will continue to notify clinicians of critical communication, even though the unit appears to be in sleep mode.
HXLogger	<p>The HXLogger is an advanced diagnostic log service that provides a basic log service, plug-ins for modified log services, and a log manager.</p> <ul style="list-style-type: none"> • Tap HXLogger to turn the basic log service On/Off. When enabled the service records app and system diagnostic troubleshooting information into four basic log files: main log file, radio log, event log, and kernel dynamic log. • Tap Kernel dynamic log to toggle feature On/Off and to set the Input file name and Input function name. This log is typically used by advanced software application developers. • Tap Plugin to view and enable additional log services and custom plug-ins. • Tap Manager, to change the default log path, delete logs, or upload logs for technical support troubleshooting. <p>Select the more icon  to Select the max bootset count or to manually Sync Log.</p>
Key WakeUp	Set the buttons you want to use to wake the computer from sleep mode. Options include: Left Scan, Right Scan, Volume Up, Volume Down. By default the Left and Right Scan buttons are enabled for wake up.
Key Remap	Change (remap) a button or key function. To learn more, see Remap a Button on page 25.
Provisioning Mode	Enable or disable unrestricted installation of applications, certificates, configuration files, and licenses. Provisioning mode is turned off by default. To learn more About Provisioning Mode , see page 83.

Setting	Description
Scanning	Configure the computer imager. To learn more, see Change the Scanner Settings on page 36.
Smart sensor	Configures the integrated motion detection sensors for advanced power management. Options include: Keep awake on motion, Wake on motion, Face down suspend.
Staging Hub Agent	Use this agent and settings to connect the computer to the Honeywell Staging Hub Foundation software platform; a centralized software platform IT integrators and administrators can use as a solution for managing, monitoring, and deploying Honeywell devices in a connected workspace environment.
Touch Screen Profile	Optimize screen interactions by selecting a touch screen profile designed specifically for your use case. To learn more, see Select a Touch Screen Profile on page 14. This feature is only available on CT45 XP models.
Voice Wedge	Voice-to-text conversion tool that can be triggered by a specified start word or key press event. Voice Wedge can be configured to take effect globally or only for an associated application.
Web Applications	Enables access for the Honeywell Mobility SDK for Web apps and port selection.
Wi-Fi Staging	Use the Honeywell Wi-Fi Staging app to quickly set up new devices by configuring one device and using it to stage others. Wi-Fi Staging can also be used to enroll devices in a Mobile Device Management (MDM) system by connecting units to a specified network and downloading and installing the specified MDM client app. To learn more, see page 84 .

Digital Wellbeing

In the Settings app, select **Digital Wellbeing** to access the following settings. See <https://wellbeing.google/>.

Google

In the Settings app, select **Google** to set up and manage your Google accounts and services.

System

In the Settings app, select **System** to access the following settings.

Setting	Description
Language & input	<ul style="list-style-type: none"> Set the active language. Set and manage Virtual and Physical Keyboard input methods. Configure auto-typing features such as capitalization, punctuation, spell check, and the personal dictionary. Adjusts the pointer speed. Set text-to-speech output.
Gestures	<ul style="list-style-type: none"> Turn Jump to Camera On/Off. Turn Swipe Up on Home Button On/Off. Set the Prevent ringing option. Options: Vibrate, Mute, Do Nothing.

Setting	Description
Date & time	Configure all date and time settings. See page 29 .
Backup	Turn the Google Drive backup feature On or Off. When enabled, phone data (e.g., apps, apps data, call history, contacts, device settings, SMS, Wi-Fi passwords and permissions) is automatically backed up to the Google Drive.
Advanced	
Reset Option	<p>Select from the following reset options:</p> <ul style="list-style-type: none"> Reset Wi-Fi, Mobile & Bluetooth. Use to reset all network settings, including Wi-Fi, Mobile data and Bluetooth. Reset app preferences. Use to reset app preference back to defaults. This includes apps you disabled, notification changes, default app actions set, background data restrictions for apps, and permission restrictions. Enterprise data reset. To learn more, see About an Enterprise Data Reset on page 95. Erase all data (factory reset). To learn more, see About a Full Factory Reset on page 96.
Multiple Users	<ul style="list-style-type: none"> Modify the owner profile name and add profiles for other people who use the computer. Activate a different user profile. Enable or disable allowing users to be added from the lock screen.
Developer options	<p>Enable developer-specific options such as USB debugging and SD card protection.</p> <p>This option only appears under System settings if you enable the feature. To learn more, see Unlock Developer Options on page 33.</p>

About Phone

In the Settings app, select **About Phone** to access the following information.

Setting	Description
Device name	A nickname to identify the device. To change, tap Device name and enter a new name.
Phone number*	The phone number(s) assigned to the device.
Emergency information	Emergency medical and contact information that will be displayed on the lock screen in an emergency.
Legal information	Provides links to third-party licenses and other legal information.
Compliance information	Displays certification and compliance information.
SIM status*	Displays information on the SIM card in the device that can be used for diagnostic purposes.
Model & hardware	Displays the model number, serial number, and hardware version of the device.
IMEI*	Displays the International Mobile Equipment Identify number.
Android version	The version of Android on the device. Tap to view additional details.
Asset number	Asset tag assigned to the device.
IP address	IP address associated with the device.

Setting	Description
Wi-Fi MAC address	Wi-Fi Mac address associated with the device.
Bluetooth address	Bluetooth address associated with the device.
Software component version	Select to view software component version list.
Build number	Kernel number installed.
* If your WWAN model supports a dual SIM card setup, both SIM Slot 1 and SIM Slot 2 will be listed.	

About Network Communications



You can easily add the mobile computer to your wireless or wired network. Connect the CT45/CT45 XP to your computer using:

- 802.11 a/b/g/n/ac/ax radio communication technology
- Ethernet communication technology
- Bluetooth communication technology
- USB communication technology

Connect to a Wi-Fi Network

The computer contains an 802.11 a/b/g/n/ac/ax radio to transfer data using wireless communications. Before you connect to a Wi-Fi network, you need to know about your network security protocol and its required credentials.

By default, the 802.11 radio is disabled.

1. Swipe up from the bottom of the Home screen to access all apps.
2. Tap **Settings**  > **Network & internet** > **Wi-Fi**.
3. Tap the toggle button  to turn the Wi-Fi radio **On** . A list of discovered networks appears.
4. On the list, tap a network name to initiate a connection.

To add a network if it does not appear on the list:

- a. Navigate to the end of the discovered network list, and then tap **Add network**.
 - b. Type the Wi-Fi network name (SSID).
 - c. Choose a security protocol and add any required information.
 - d. Tap **Save**.
5. Enter any required information if the network is secured (e.g., password, key, or certificate name).
 6. Tap **Connect**.

Once you connect to a saved Wi-Fi network:

- Tap the network name on the list to view details (e.g., status, signal strength, speed, frequency, security type). Select **Cancel** to close details screen.
- The computer automatically connects to the same network when the network is in range and the Wi-Fi radio is turned on.
- To remove a network from your saved list, tap and hold the network name and select **Forget**. You can do this for networks you no longer use.
- To view a list of only your saved networks, tap , and then select **Saved networks**.

Configure Proxy Settings for a Wi-Fi Network

If you need to connect to network resources through a proxy server, you can configure settings for the proxy server for each Wi-Fi network you add. By default, the Wi-Fi networks you add are not configured to connect through a proxy server.

Note: Proxy settings apply only to the Wi-Fi network you modify. You must change proxy settings for each network requiring a proxy server.

1. Swipe up from the bottom of the Home screen to access all apps.
2. Tap **Settings**  > **Network & internet** > **Wi-Fi**. The list of available Wi-Fi networks appears.
3. Tap and hold the name of a connected network, and then tap **Modify network**.
4. Tap **Advanced options**.
5. Under Proxy, tap **None** to open menu, and then select **Manual**.
6. Enter the proxy settings for the network.
7. Tap **Save**.

Disable Wi-Fi Notifications

By default, when Wi-Fi is enabled, you receive notifications in the Status bar when the computer discovers a wireless network. You can disable these notifications.

1. Swipe up from the bottom of the Home screen to access all apps.
2. Tap **Settings**  > **Network & internet** > **Wi-Fi**. Verify the Wi-Fi radio is turned On.
3. Tap **Wi-Fi preferences**. The Configure Wi-Fi menu appears.
4. Tap **Notify for public networks** to toggle the setting On or Off.

Honeywell Wi-Fi Settings

To access Wi-Fi preference settings for advanced configuration of the wireless 802.11 radio in the mobile computer:

1. Swipe up from the bottom of the Home screen to access all apps.
2. Tap **Settings**  > **Network & internet** > **Wi-Fi**.
3. Tap **Wi-Fi preferences**. The Configure Wi-Fi menu appears.
4. Tap **Advanced** > **Honeywell Wi-Fi Settings**.
5. Tap a setting to enable or disable the option or to access additional parameters that configure the Wi-Fi radio.

Connect to an Ethernet Network

To connect the computer to an Ethernet network, you need an Ethernet Home Base or Ethernet (Net) Base.

1. Make sure the base is connected to your Ethernet network.
2. Place the computer in the base.
3. Swipe up from the bottom of the Home screen to access all apps.
4. Tap **Settings**  > **Network & internet** > **Ethernet**. The Ethernet setting is turned **On** by default.
5. Tap **Ethernet**.

The Ethernet connection screen shows the current Ethernet connection. By default, the computer assumes a DHCP connection, and that your network has assigned an IP address automatically. If DHCP is working, the Ethernet base should indicate that communication with the network is occurring.

6. (Optional) To assign a static IP address.
 - a. Tap **DHCP** and then select **Static** from the list.
 - b. Enter the required network information, and then tap **Apply**.
7. Tap **Save**.

How to Connect to Virtual Private Networks

The computer supports connecting to virtual private networks (VPNs). This section describes how to add and connect to VPNs. To configure VPN access, you must obtain details from your network administrator. You can view and change VPN settings in the Settings app.

Note: Before you can add or connect to a VPN, you must enable a screen lock method. See [Change the Screen Lock to Protect the Computer](#) on page 14 for more information.

Add a VPN

Before you can connect to a VPN, you must create a VPN profile.

1. Swipe up from the bottom of the Home screen to access all apps.
2. Tap **Settings**  > **Network & internet** > **Advanced** > **VPN**.
3. Tap **+** to add a new VPN profile.
4. Enter the required information for the VPN connection. If needed, swipe up on the screen to access all the required information fields.
5. Tap **Save**. The VPN name appears in the VPN list.

Connect to a VPN



Once a VPN profile is created, you can connect to the VPN at any time.

1. Swipe up from the bottom of the Home screen to access all apps.
2. Tap **Settings**  > **Network & internet** > **Advanced** > **VPN**.
3. Tap the name of the VPN in the list.
4. Enter any necessary credentials when prompted.
5. Tap **Connect**.

A  appears in the status bar and a notification is received. To disconnect from the VPN, tap the notification.

Edit VPN Information

You can edit an existing VPN profile from the VPN screen.

1. Swipe up from the bottom of the Home screen to access all apps.
2. Tap **Settings**  > **Network & Internet** > **Advanced** > **VPN**.
3. Tap and hold the name of the VPN in the list.
4. Tap  to the right of the VPN profile you want to edit.
5. Edit the VPN settings as necessary.
6. When you are done, tap **Save**.

About Wireless Security

The computer provides these security solutions for your wireless network:

- Wi-Fi Protected Access 2 (WPA2™)
- Wi-Fi Protected Access (WPA)
- 802.1x

Honeywell recommends WPA2 security with PSK (Personal) or 802.1x (Enterprise) key management.

Before you set security, you need to enable the radio, set the date, and set the SSID on your computer. To use 802.1x security, you need to load a root certificate on your computer. To use transport layer security (TLS) with 802.1x security, you also need to load a user certificate.

Use the Settings app to access and configure all wireless security settings.

About Certificates

You can use digital certificates to identify the computer for network access or authentication to servers. To use a certificate to identify your device, you must install it in the trusted credential storage on the computer.

Android supports DER-encoded X.509 certificates saved in files with a .crt or .cer file extension. To install a valid certificate with a .der or other extension, you must change the extension to .crt or .cer to install it.

Android also supports X.509 certificates saved in PKCS#12 key store files with a .p12 or .pfx extension. To install a valid key store file with another extension, you must change the extension to .p12 or .pfx to install it. When you install a certificate from a PKCS#12 key store, Android also installs any accompanying private key or certificate authority certificates.

Load a Certificate

To use a certificate, you must install it in the trusted credential storage on the computer.

Note: Apps such as email and browsers that support certificates allow you to install certificates directly from within the app. For more information, see the help that comes with the app.

1. Copy the certificate or key store from your PC to the mobile computer.
2. Swipe up from the bottom of the Home screen to access all apps.
3. Tap **Settings**  > **Security** > **Encryption & credentials**.
4. Tap **Install certificate**.
5. Select **CA certificate**, **VPN and app user certificate**, or **Wi-Fi certificate**.

6. Tap the Menu icon , and then navigate to the location where you saved the certificate.
7. Tap the certificate or key store to install it. If prompted, enter the key store password and tap **OK**.
8. Enter a name for the certificate and tap **OK**.

Disable or Remove Certificates

If a user or system certificate is compromised, or your organization chooses not to trust it, you can disable or remove the certificate.

1. Swipe up from the bottom of the Home screen to access all apps.
2. Tap **Settings**  > **Security** > **Encryption & credentials**.
The trusted credentials screen has two tabs:
 - **System** shows Certificate Authorities (CA) certificates permanently installed on the computer. They can only be disabled.
 - **User** shows CA certificates you have installed yourself. You can remove these certificates.
3. Tap the name of the certificate that you want to disable or remove. The Security certificate screen appears.
4. Scroll to the bottom of the screen and tap **Disable** (for System certificates) or **Remove** (for User certificates).
5. Tap **OK**.

Note: You can enable a disabled System certificate but if you remove a User certificate, you must install it again to enable it.

About Bluetooth Communications

Your mobile computer is equipped to communicate with other devices using Bluetooth technology. The Bluetooth radio must be turned on to discover, pair and connect to other devices using Bluetooth wireless technology. System bar icons indicate Bluetooth radio status.

Connect a Bluetooth Device

To connect to a Bluetooth device, you must turn on the Bluetooth radio and then select the device from a list of discovered devices.

1. Swipe up from the bottom of the Home screen to access all apps.
2. Tap **Settings**  > **Connected devices**.

3. Tap **+** Pair new device. A list of Bluetooth devices appears.
4. Select a device on the list to initiate a pairing request.
5. When the pairing request message appears:
 - Verify the pairing PIN is the same on both devices, and then tap **Pair**.

OR

- If the pairing request requires a PIN, enter the **PIN**, and then tap **Pair**.

When the device is successfully paired with the computer, the device name appears under Previously Connected Devices.

6. (Optional) Once paired to a device, you can connect manually to the device. Tap the device under Paired devices. The word “Connecting” appears under the paired device name. When a connection is established, the device appears under Other Devices.

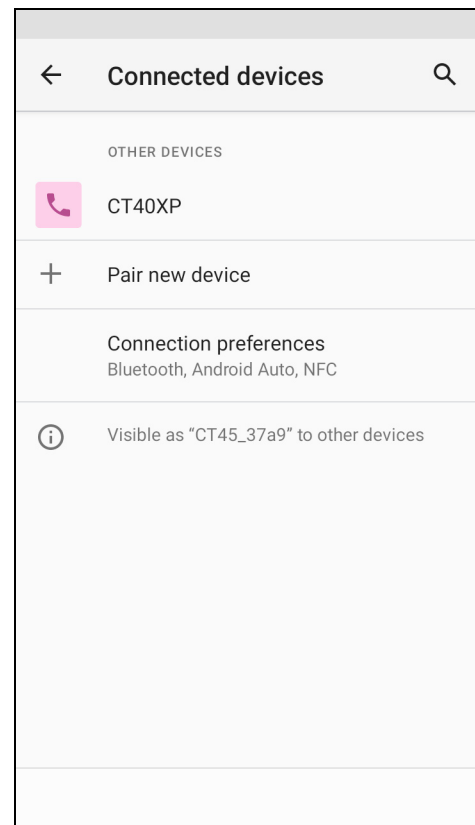
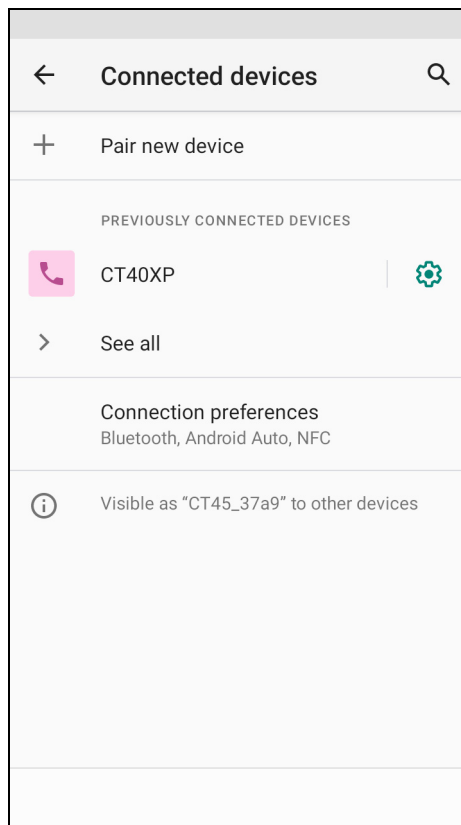

Note: To delete a paired device, tap  next to the name of the paired device and then tap **Forget**.



Rename the Computer and View File History

You can change the name of the computer to make it easier to identify when pairing with other Bluetooth enabled devices and view statistics about received files.

1. Swipe up from the bottom of the Home screen to access all apps.
2. Tap **Settings**  > **Connected devices** > **Connection preferences** > **Bluetooth**.
3. Tap **Device Name** to change the device name. Type the new name and then tap **Rename**.

Rename or Unpair a Paired Device



You can rename a paired device to make it easier to identify on the list or unpair the device to remove it from the paired list.

1. Swipe up from the bottom of the Home screen to access all apps.
2. Tap **Settings**  > **Connected devices** > **Previously connected devices** > **Bluetooth**.
3. Tap  next to the **paired device**.
4. Take one of the following actions:
 - To rename the device, type the new name, and then tap **OK**.
 - To allow **Internet connection sharing** or **Contact Sharing**, tap the check box next to the settings and then tap **OK**.
 - To unpair the device, tap **Forget**.

About the Scanner Edge App



Your mobile computer is equipped to communicate with scanners using Bluetooth technology through the Scanner Edge app. The Bluetooth radio must be turned on. System bar icons indicate Bluetooth radio status.

To turn on the Bluetooth radio:

1. Swipe up from the bottom of the Home screen to access all apps.
2. Tap **Settings**  > **Connected devices** > **Connection preferences** > **Bluetooth**.
3. If necessary, tap **Off**  to toggle the Bluetooth radio **On** .

Connect a Bluetooth Scanner

To connect to a Bluetooth scanner, the Bluetooth radio must be turned on and then scan a pairing barcode with the Bluetooth scanner.

1. Swipe up from the bottom of the Home screen to access all apps.
2. Tap **Scanner Edge** .
3. Tap the menu icon  and then tap **Pair BT Scanner**.
4. For Honeywell branded scanners tap **Honeywell** or for Intermec branded scanners tap **Intermec**.
5. Scan the **Scan to connect barcode** displayed on screen.
6. When the scanner is successfully paired with the computer, the scanner name appears under Connected Device.

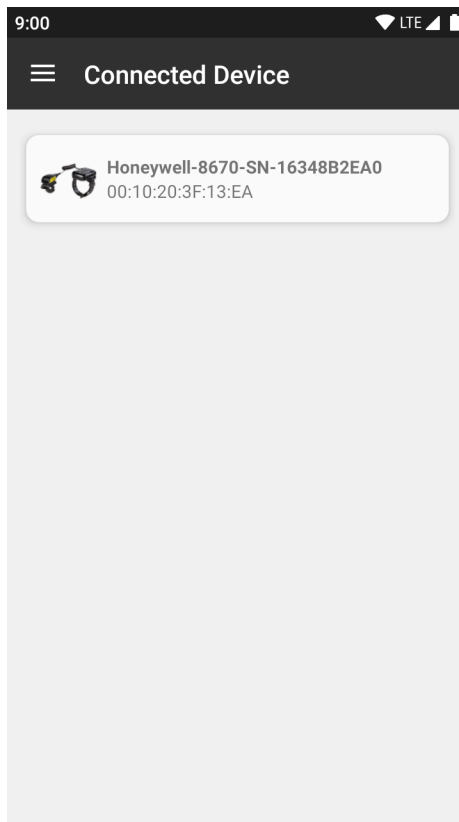

Unpair a Paired Scanner

You can unpair the scanner to remove it from the Connected Device list.

1. Swipe up from the bottom of the Home screen to access all apps.
2. Tap **Scanner Edge** .

3. Tap the menu icon  and then tap **Disconnect BT Scanner**.
4. Tap **Honeywell** or **Intermec**.
5. Scan the **Scan to disconnect barcode** displayed on screen.

About Ethernet and USB Communications

You can use these optional CT45/CT45 XP series accessories to transmit data to and receive data from another device using an Ethernet or USB cable connection:

- Home Bases
- Ethernet Home Bases
- Display Docks
- Snap-on Cup (USB)

Accessory documentation is available for download from the CT45 or CT45 XP product pages at sps.honeywell.com.

For a complete list of compatible accessories for your mobile computer and their part numbers, see the *CT45/CT45 XP Accessory Guide* available for download at sps.honeywell.com.

Contact your local sales representative for ordering information.

USB Troubleshooting

- If you have a problem with your workstation computer recognizing the USB device, try downloading and installing the Honeywell-aidc-usb-driver. The driver is part of the Honeywell_Mobility SDK_Android software.zip file. To learn where to get the software, see [Developer Information](#) on page 83.
- Check to make sure you have enabled the USB for file transfer. To learn more, see [Configure USB Connection and Transfer Files](#) on page 20.

USB or Bluetooth Tethering for Data Connection Sharing

You can share your mobile computer data connection with another device through a USB tethering or Bluetooth tethering connection.

Minimum requirements for USB Tethering

- Mobile computer minimum operating system version of Android 9 or later.
- A compatible USB communication accessory and/or cable.

Set up and Connection

1. Connect the devices using a USB accessories and/or cable.
2. On the mobile computer, tap **Settings**  > **Connected devices** > **USB**.
3. Select **USB tethering**, and then tap the back arrow twice.
4. Tap **Network & Internet** > **Advanced** > **Hotspot & tethering**.
5. Select **USB tethering** to initiate the shared data connection.

Note: To stop sharing the connection, tap **USB tethering** again to turn Off the feature or disconnect the USB accessory.

Minimum requirements for Bluetooth Tethering

All devices must support Bluetooth communication.

Set up and Connection

1. Pair the mobile computer with another Bluetooth enabled device.
2. Verify the other device is set to use a network connection using Bluetooth technology.
3. Swipe up from the bottom of the Home screen to access all apps.
4. Tap **Settings**  > **Network & internet** > **Advanced** > **Hotspot & tethering**.
5. Select **Bluetooth tethering** to initiate the shared data connection.

Note: To stop sharing the connection, tap **Bluetooth tethering** again to turn Off the feature.

About Near Field Communication (NFC)

NFC technology provides the ability for short-range, wireless data transfer between the CT45/CT45 XP and NFC tags or other NFC enabled devices placed in close proximity to the back of the computer. All CT45/CT45 XP mobile computers support the following modes of operation:

- NFC tag reader/writer mode: The computer reads and/or writes digital information from or to an NFC tag.
- Peer-to-Peer (P2P) mode: The computer uses Bluetooth technology to transfer screen content (e.g., a picture, contact information, Web page URL, or file) between NFC enabled devices.
- NFC card emulation mode: The computer emulates an NFC card (smart card) that an external card reader can access. You can download and install apps for card emulation mode from the Google Play™ store. Some examples include

digital wallets (e-wallets) offered by your bank or credit card company and Google Pay™. The app you install determines the type of emulation mode used: Card Emulation with a Secure Element or Host-based Card Emulation. Secure element use is common for financial transactions that require a high level of security in order to provide a secure memory and execution environment for running custom smart card applets and storing your personal information (e.g., account information and credentials).

Note: When using a Universal Integrated Circuit (UICC) card for NFC Secure Element NFC link encryption, install the card in SIM slot 1.

Developer Information

To download the Honeywell Mobility SDK for Android and EZConfig for Mobility:

1. Go to the *Technical Support Downloads Portal* at honeywell.com/PSSsoftware-downloads.
2. Create an account if you have not already created one. You must login to download the software.
3. Install the *Honeywell Download Manager* tool on your workstation (e.g., laptop or desktop computer) prior to trying to download any files.
4. Navigate to the software:
 - *Honeywell Mobility SDK for Android*
Click on **Software** > **Software and Tools** > **Developer Library** > **SDKs for Android**.
 - *EZConfig for Mobility*
Click on **Software** > **Software and Tools** > **EZConfig for Mobility**.
5. Select **Download** next to the software zip file.

About Provisioning Mode

Once you complete the out-of-box initial setup process, Provisioning mode is automatically turned off to improve device security against unwanted modifications to the system.

When Provisioning mode is turned off (disabled):

- Configuration barcodes do not scan and process.
- \honeywell\autoinstall folders are inaccessible.

Note: To learn more about network and security for Honeywell mobile computers with Android operating systems, go to sps.honeywell.com.

Enable or Disable Provisioning Mode

1. Swipe up from the bottom of the Home screen to access all apps.
2. Tap **Settings**  > **Honeywell Settings** > **Provisioning mode**.
3. Tap the button to toggle the provisioning **On** or **Off**.

About Wi-Fi Staging

You can use the Honeywell Wi-Fi Staging app to quickly set up new devices by configuring one device and using it to stage others. Wi-Fi Staging can also be used to enroll devices in a Mobile Device Management (MDM) system by connecting units to a defined network and downloading and installing the MDM client app.

Once you have set up a configuration in the Wi-Fi Staging app on the server device, Wi-Fi staging uses that device as a hotspot and waits for a client to connection. The configuration is distributed to the client device once communication is established between the client and the server device.

Staging Devices

Wi-Fi Staging requires two steps:

1. Set up a master device to act as a server (see [Set Up a Device as a Server](#) on page 84).
2. Set up the client device (see [Set Up Client Devices](#) on page 87).

Set Up a Device as a Server

Wi-Fi Staging provides two kinds of configurations for a master device acting as a server through a hotspot. Setup of the server device differs based on the staging configuration chosen:

- **Basic Configs** include the most common system settings:
 - System language
 - Bluetooth and NFC
 - System volume
 - Location
 - Network
 - File download
 - Application installation or launch

- **Advanced Configs** allow you to stage your devices with .xml files

The hotspot on the server device will be named HONEYWELL_WIFI_STAGING.

Note: We recommend setting up the server before setting up clients. If the server is not created in advance, client setup requires more time and power to scan and search for the hotspot signal.

Note: To control bandwidth usage, the server side of Wi-Fi Staging has a maximum limitation of 10 concurrent client connections. If more than 10 client devices attempt to connect to the server device at the same time, staging of some of those clients will be delayed until client connections become available as the staging process progresses.

Basic Configuration

Basic configuration includes the most common system settings.

1. Tap **Settings**  > **Honeywell Settings** > **Wi-Fi Staging** to launch the Wi-Fi Staging app on the server device.
2. Tap **Basic Configs** to start the configuration wizard.
3. Select system languages. Tap **+** to add a language. At least one language must be selected. Tap **NEXT**.
4. Select connection preferences. Enable Bluetooth and/or NFC. They are disabled by default. Tap **NEXT**.
5. Select sound preferences. Adjust the default volume for each type of audio by dragging the slider, and then tap **NEXT**.
6. Enable the location switch. It is disabled by default. Tap **NEXT**.
7. Set up **Network & Internet** connection, or tap **SKIP** to proceed to Step 9 if you do not want to set up a network connection.

You would need to set up a Network & Internet connection if you want to register devices to an MDM system or the devices being registered need to use applications that require network access.

If you want to set up devices to connect to a Wi-Fi access point, enter the network information:

- a. Tap **Wi-Fi Security** and select either **OPEN** or **WPA/WPA2**.
 - b. Enter the Wi-Fi SSID, and then tap **OK**. This field cannot be left empty.
 - c. Enter the Wi-Fi password. The password must be between 8 and 63 characters long. If you select WPA/WPA2, a password is required.
 - d. Tap **NEXT**.
8. The **Files & Apks** option only appears if you chose to set up Network & internet connections in step 7.

Enter the locations (URLs) of the **Files & Apks** that you want downloaded.

- The URL should end with the file that you want to download. Wi-Fi Staging names the downloaded file with the file name in the URL.
- (Optional) You can include a file's hash in the file name. Wi-Fi Staging supports hash algorithms SH1 and SHA256.
- For security, only Local Area Network URLs are supported. Wi-Fi Staging ignores URLs from Wide Area Networks.
- Supported network protocols include HTTP or HTTPS.
- APK files are installed silently and automatically after download.

9. **Final Setting:** Select whether you want to reboot the device after staging is complete. You can also specify an action (intent) to launch Android activities.
10. Review the items you have configured. If you need to change a setting, tap the Back button to return to the relevant screen.

Tap **Confirmed, start staging now!** to begin. Wi-Fi Staging starts a hotspot on the server device and wait for clients to connect.

11. Proceed to [Set Up Client Devices](#) on page 87.

Configurations are distributed to any client that connects to the server device. Once the data transmission finishes successfully, the name and serial number of the configured client is displayed in the Wi-Fi Staging app on the server device and the client device skips the Android setup wizard.

Note: *If you included a file's hash in Step 8, Wi-Fi Staging will validate that the hash of the file downloaded to a device matches what you specified. If the downloaded file's hash does not match, the file will be removed from the device.*

Advanced Configuration

Advanced configuration allows you to stage your devices with one or more .xml files created by EZConfig or Enterprise Provisioner. For more information about generating .xml files, see the *PowerTools User Guide* or *Enterprise Provisioner User Guide*.

Note: *Advanced Configuration supports .xml files only. Other file types are ignored.*

Note: *Do not change the default names of .xml files. For example, DeviceConfig.xml is acceptable, but DeviceConfig1.xml is not.*

1. Choose one device to act as the server.
2. Tap **Settings**  > **Honeywell Settings** > **Wi-Fi Staging** to launch Wi-Fi Staging on the server.
3. Tap **Advanced Configs**.

4. Tap **File directory**.
5. Specify where on the server device the .xml files to be downloaded are located.
6. Tap **NEXT**.
7. Choose the files to be applied. Tap **NEXT**.
8. Review the files you have selected. If you need to change any files, tap the Back button.

Otherwise, tap **Confirmed, start staging now!** to begin. Wi-Fi Staging starts a hotspot on the server device and waits for clients to connect.

9. Proceed to [Set Up Client Devices](#) on page 87.

Set Up Client Devices

The Wi-Fi Staging client runs automatically on the initial boot of a new device. However, it must be started manually on existing devices.

New Devices

This section applies to new, out-of-the box devices only. For existing devices, see [Existing Devices](#) on page 87.

1. Set up a server device (see page [84](#)).
2. Place the new devices to be configured within 1 meter (3 feet) of the server device and turn them on. When a new device boots up and begins the setup wizard, it attempts to retrieve configuration from the server device, and a staging progress screen appears.

Note: *Client devices should be kept on the Android Welcome or setup wizard screen during staging. If you finish the setup wizard manually, the client side of Wi-Fi Staging stops running.*

Configurations are distributed to any client that connects to the server device. Once data transmission finishes successfully, the name and serial number of the configured client appears in the Wi-Fi Staging app on the server device, and the client device skips the Android setup wizard.

Existing Devices

To start the Wi-Fi Staging client on an existing device:

1. Set up a server device (see page [84](#)).
2. Tap **Settings**  > **Honeywell Settings** > **Wi-Fi Staging** to turn on the client device and launch the Wi-Fi Staging app.
3. Tap **To be Staged**.
4. A message appears notifying you that the Wi-Fi settings on the client device will be reset as part of the staging process. Tap **OK** to confirm you wish to proceed.

Staging begins and a progress screen appears.

5. Place the device within 1 meter (3 feet) of the server device and it begins searching the server hotspot for a configuration.

The client device(s) attempt to retrieve the configuration from the server device and displays the staging progress screen. Once the client device receives and applies the configuration successfully, the progress screen is dismissed.

Note: *To stop the staging process on an existing device, tap the Back button on the client device.*

Log Files

Wi-Fi Staging saves a key process and exception log on the device in the following directory: /sdcard/honeywell/Android/data/com.honeywell.wifistaging/Log/

This directory can be accessed via a file browser on a workstation (e.g., laptop, desktop computer) through a USB file transfer connection with the mobile computer, if Provisioning Mode is enabled.

About Voice Wedge

Voice Wedge is a voice-to-text conversion tool that can be triggered by a specified start word or key press event. When Voice Wedge is activated, the mobile device can capture a user's speech and output it as text in a field in the selected app. Voice Wedge can be configured to apply globally across all apps or only for an associated application.

Note: *Because Voice Wedge is powered by Google speech recognition services, it is only available on Google Mobile Services (GMS) devices.*

Define Trigger Mode

You can define either a spoken word or a key press as the trigger to launch Voice Wedge.

1. Select **Settings**  > **Honeywell Settings** > **Voice Wedge**.
2. Tap **Trigger Mode**.
3. Tap **Start Word** to define a voice command as the trigger or **Key** to use a key press.
4. If you selected Start Word, tap **Trigger start word** then use the keypad to enter the word. The default trigger start word is "honeywell".
5. If you selected Key, tap **Trigger key** then select the key to be mapped. You can either press a button, for example, a scan button, or use a virtual key. Note that

when a button or key is selected for Voice Wedge, its original use is no longer active.

Associate Applications

By default, Voice Wedge is associated with all applications. You have the option to associate Voice Wedge with a single app.

1. Select **Settings**  > **Honeywell Settings** > **Voice Wedge**.
2. Tap **Effective Coverage**.
3. Tap **Single app**.
4. Tap **App package name**.
5. Use the keyboard to enter the associated package name, for example, “com.android.chrome”, then click **OK**.
6. To limit Voice Wedge to a specific activity within an app, tap **App activity name** and use the keyboard to enter the activity name, for example, “com.google.android.apps.chrome.Main”.

Define Key Commands

Voice Wedge allows you to define some words so that they will be interpreted as commands rather than being displayed as text when you are speaking. When you say one of these words, Voice Wedge will send a key press.

Under **Key command**, select the check box for words that should be used as keys.

- Enter - When you say, “enter,” an Enter key will be sent.
- Tab - When you say, “table,” a Tab key will be sent.
- Space - When you say, “space,” a space key will be sent.

Select Data Type

By default, Voice Wedge enters both alphabetic and numeric characters. You can also choose to input only alpha or numeric characters.

1. Select **Settings**  > **Honeywell Settings** > **Voice Wedge**.
2. Tap **Data type**.
3. Tap the data type to input.

Examples:

Data Type	You say...	Voice Wedge inputs...
Any	abc123	abc123

Data Type	You say...	Voice Wedge inputs...
Alpha	abc123	abc
Numeric	abc123	123

To Use Voice Wedge in an App

Follow these steps to use Voice Wedge in an application on your device. Note that if a specific application is defined in the App Package Name setting, Voice Wedge will only work if you are using that app.

1. Select an app on your device.
2. Tap a data entry field in the app.
3. Say the defined Trigger start word or press the Trigger key.
A message indicates, "Waiting for voice input..."
4. Speak normally into the device.
The text will populate the selected field.

MANAGE AND MAINTAIN THE COMPUTER

Use this chapter to understand how to upgrade software, reset and maintain the computer.

About Software Updates

Cyber security best practices include keeping your device apps and OS up to date. To help, Honeywell offers maintenance patches, security updates and operating system upgrades through our Honeywell Edge services.

Availability and cost depend on the following:

- Date of purchase of the device or software app.
- Warranty status.
- Service agreement status (devices) or Maintenance plan status (apps).

To learn more about Honeywell Edge Services, go to <https://sps.honeywell.com/us/en/services/productivity/support-services>.

Software Downloads

Product support is available online through [Technical Support](#). Software updates can be accessed through the [Software Downloads](#) portal. You will need to create a login account for portal access. Additional information such as purchased date, service agreement number, maintenance plan number, or software license number may be required for downloads.

1. Go to honeywell.com/PSSsoftware-downloads.
2. Create a login account if you have not already created one.
3. Install the Honeywell Download Manager tool. See “Note” on the portal page. This tool is required for downloads.
4. Locate the app or upgrade you want to download in the Software directory.
5. If prompted, enter additional information, and click **Submit**.



6. Select **Download**. Follow the prompts to download the file.

About Transferring Files via USB Connection

If you plan on using a USB connection to transfer files to the mobile computer, make sure you set the USB connection to allow file transfers. To learn more, see [Configure USB Connection and Transfer Files](#) on page 20.

Install Software Apps with AutoInstall

Important: *The mobile computer must have power for the entire length of the install process or it could become unstable. Do not attempt to remove the battery during the process.*

1. Swipe up from the bottom of the Home screen to access all apps.
2. Tap **Settings**  > **Honeywell Settings** > **Provisioning mode**.
3. Tap the toggle button to turn Provisioning mode **On**.
4. Save the Android application file (*.zip or *.apk) in one of the following folders on the CT45/CT45 XP mobile computer:
 - **Internal shared storage\honeywell\autoinstall**
Files saved to this folder for installation do not persist when a Full factory reset or Enterprise data reset is performed.
 - **IPSM card\honeywell\autoinstall**
Files saved to this folder for installation do not persist when a Full factory reset is performed. However, the software does persist if an Enterprise data reset is performed.
5. Swipe up from the bottom of the Home screen to access all apps.
6. Tap **AutoInstall Settings**  and verify **Autoinstall** is enabled .
7. Tap **Packages Update** from the AutoInstall Settings screen.



If required by the app, the computer may automatically initiate a reboot before starting the installation process. When the installation is finished, a message appears or the unit finishes rebooting and the lock screen appears.
8. Once installation is complete, turn Provisioning mode **Off**.

Note: *Some updates do not require the computer to reboot before installation.*

Optional microSD Card Method

The mobile computer comes equipped with a microSD card socket. You can install an upgrade from a microSD card you insert in the computer.

Important: *The CT45/CT45 XP must have power for the entire length of the install process or it could become unstable. Do not attempt to remove the battery during the process.*

1. On the CT45/CT45 XP, swipe up from the bottom of the Home screen to access all apps.
2. Tap **Settings**  > **Honeywell Settings** > **Provisioning mode**.
3. Tap the toggle button to turn Provisioning mode **On**.
4. Tap **AutoInstall Settings** . Verify **Autoinstall** is enabled .
5. Press and hold the **Power** button.
6. Tap **Power off** or **Power** > **Power off**, depending your computer model.
7. On your workstation (e.g., laptop, desktop computer), format the microSD card and create a **\honeywell\autoinstall** folder on the root of the card.
8. Save the upgrade file in the **autoinstall** folder.
9. Install the microSD card in the CT45/CT45 XP, and then press the **Power** button.

The computer automatically runs the upgrade found in the autoinstall folder on the card. The system update screen appears during the upgrade process. When the upgrade is finished, the lock screen appears.

10. Once installation is complete, turn Provisioning mode **Off**.

About the Honeywell Upgrader

Use the Honeywell Upgrader app (HUpgrader) to check for and install OTA updates, and view the current OTA version installed on the computer.

Install OTA Updates

To use the HUpgrader to install an OTA update file downloaded from the [Technical Support Downloads Portal](#):

1. Save the OTA file (*.zip) the following folder on the CT45/CT45 XP computer:
 - **Internal shared storage\Download**

2. Tap **HUpgrader**  to open the Honeywell Upgrader app.

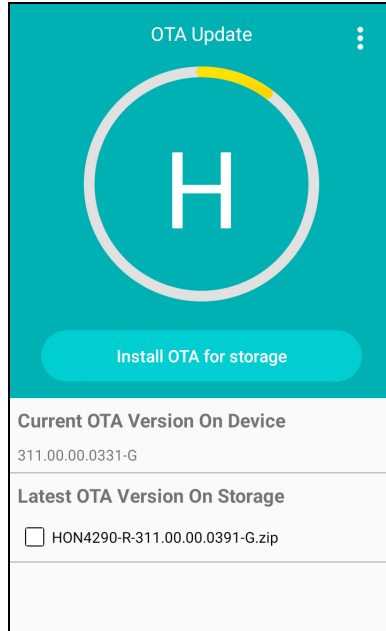

3. Tap , and then tap **Select OTA from storage**.
4. Select the storage location (i.e., Internal Storage) where you saved the file.
5. Tap the OTA update file. The computer examines the file, and then starts the installation.

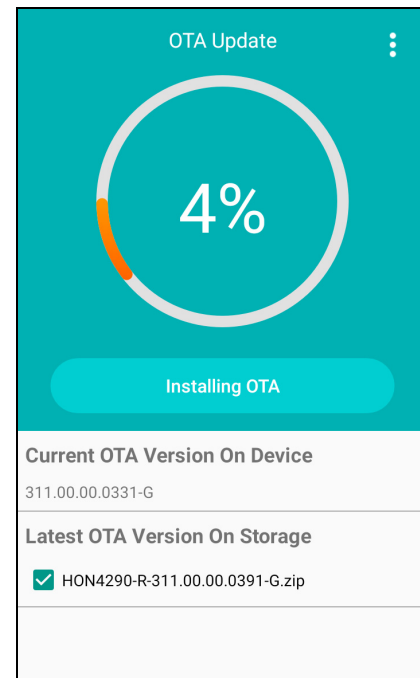
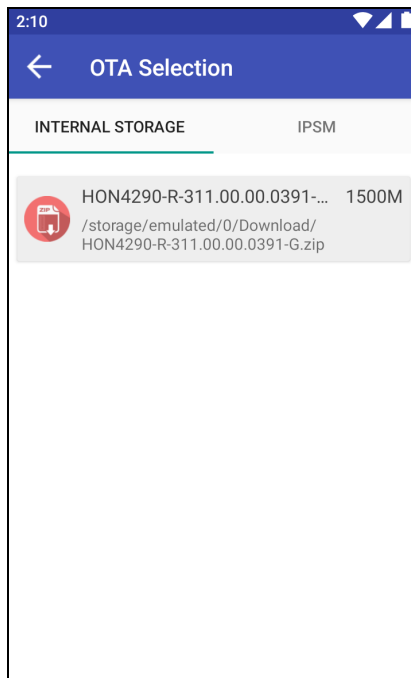

6. Once the installation is complete (100%), select **OK** when prompted to **Reboot** the computer. The computer reboots and finishes the update.

Restart (Reboot) the Computer

You may need to reboot the computer to correct conditions where an application stops responding to the system.

1. Save your files and close any open applications.
2. Press and hold the **Power** button until the options screen appears.
3. Tap **Power** > **Restart**. The computer restarts.

If the touch panel display is unresponsive:

- Press and hold the **Power** button for approximately 8 seconds until the computer reboots.

About an Enterprise Data Reset

You can perform an Enterprise data reset if a Reboot did not improve the condition and all other troubleshooting methods have not resolved the issue. This method provides a clean configuration for troubleshooting by erasing all data from the Internal shared storage location on the computer. Data is not erased from the IPSM Card location.





Caution: An Enterprise data reset results in data loss, only perform this procedure if all other recovery methods have failed. All personal content is erased including, but not limited to emails, pictures, contacts, Google account information, system settings, and app settings.

Note: *This method of recovery may not be available if your system administrator has set policies to prevent the reset use.*

Before You Begin

- If you recently reset your Google Account password, wait 24 hours before performing an Enterprise data reset.
- Make sure you have your screen lock password, PIN, or pattern if you activated one. You will need this to reset the computer.
- If you have a Google Account, back up your data and settings to your Google Account so you can restore them if needed.
- Connect the computer to an external power source or make sure you have a full battery charge.
- Make sure you have an Internet connection.

Enterprise Data Reset the Computer

1. Swipe up from the bottom of the Home screen to access all apps.
2. Select **Settings**  > **System** > **Advanced** > **Reset options**.
3. Tap **Enterprise data reset**.
4. Tap **Erase all data**
5. If prompted, type your screen lock security pattern, PIN, or password and tap next ().
6. Tap **Erase Everything**. A message appears informing you an Enterprise data reset is being performed.

About a Full Factory Reset

A full factory reset should only be performed if you have exhausted all other troubleshooting options. This method reverts the computer back to the factory state by erasing all data in Internal shared storage and the IPSM Card storage locations on the computer.





Caution: A Full factory reset results in data loss. Perform this procedure only if all other recovery methods have failed and have no other option. All personal content is erased including, but not limited to emails, pictures, contacts, Google account information, system settings, and app settings.

Note: *This method of recovery may not be available if your system administrator has set policies to prevent the reset use.*

Before You Begin

- If you added a Google Account to the CT45/CT45 XP computer, make sure you have your Google username and password associated with the computer. If you do not have the username and password, you will not be able to use the computer after the reset. This is a security measure that prevents unauthorized users from using the device if they try a Full factory reset.
- If you did not add a Google Account to the computer, the extra security level is not enabled and you will not need a Google username and password.
- If you recently reset your Google Account password, wait 24 hours before performing a Full factory reset.
- Connect the computer to an external power source or make sure you have a full battery charge.
- Make sure you have an Internet connection.

Full Factory Reset the Computer

1. Swipe up from the bottom of the Home screen to access all apps.
2. Select **Settings**  > **System** > **Advanced** > **Reset options**.
3. Tap **Erase all data (factory reset)**.
4. Tap **Reset Phone**.
5. If prompted, type your screen lock security pattern, PIN, or password and tap next ().
6. Tap **Erase Everything**. A message appears informing you an Enterprise data reset is being performed.

Repairs

Repairs and/or upgrades are not to be performed on this product. These services are to be performed only by an authorized service center (see [Customer Support](#) on page ix).

Maintenance

Your device provides reliable and efficient operation with a minimum of care. Although specific maintenance is not required, the following sections describe periodic checks to ensure dependable operation.

Clean the Computer

The computer housing, scanner window, camera window, and touch screen may be cleaned with a soft cloth dampened with water or a mild detergent-water solution. If a mild detergent solution is used, wipe the computer with a clean cloth dampened only with water to remove any detergent residue.

Note: *Reading performance may degrade if the scanner window is not clean. If the window is visibly dirty, or if the scanner is not operating well, clean the window.*



Caution: **Do not submerge the computer in cleaning solution. Do not use abrasive wipes or cloths on the windows or touch screen. Abrasive wipes may scratch the windows and touch screen. Never use solvents (e.g., acetone) on the housing or windows. Solvents may damage the computer finish, the windows, or touch screen.**



Caution: **Ensure all components are dry prior to mating the computer with charging accessories or other peripheral devices. Mating wet components may cause damage not covered by the warranty.**

Computer Agency Information

CT45 and CT45 XP mobile computers meet or exceed the requirements of all applicable standards organizations for safe operation. The best way to ensure safe operation is to use the mobile computer according to the agency guidelines on the product regulatory sheet, quick start guide, battery insert, and in this user guide. Read all guidelines before using your computer.

Product documentation is available for download from sps.honeywell.com.

Public certificates are available for download from honeywell.com/PSScompliance.

Label Locations

Labels inside the battery compartment contain information about the computer, including compliance information, model number, serial number, IMEI number (CT45-L1N-x*, CT45P-L1N-x* models only), and MAC address. Laser safety labeling is located on the back of the computer.

*x = WWAN model variations

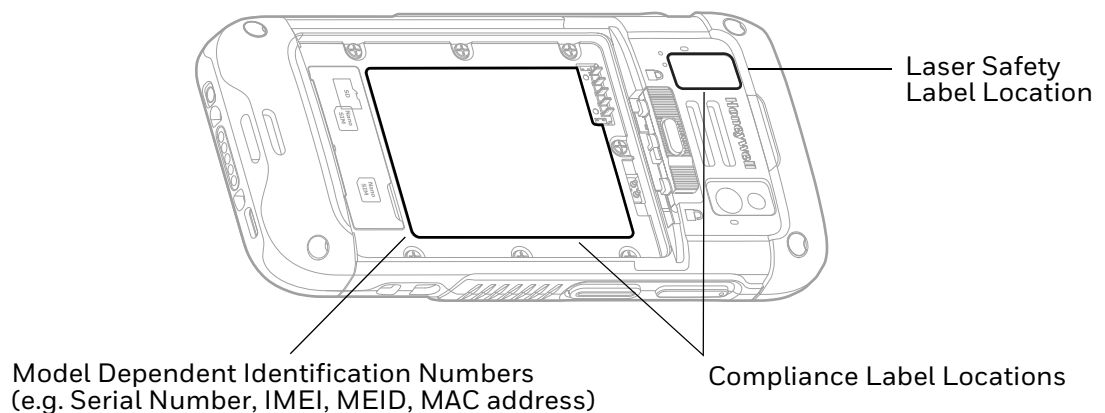

Physical and Environmental Specifications

1. Go to sps.honeywell.com.
2. Type CT45 in the Search box, and then press **Enter**.
3. Click on the product link in the search results.
4. Select one of the following tabs:
 - **Specifications**
View System Architecture, Wireless Connectivity, Mechanical, and Environmental specifications.
 - **Resources or Documents**
View and download available product documentation. For example, Data Sheet, Accessory Guide, Quick Start Guide, User Guide, Regulatory Information, Battery Information.

Imager Specifications

The CT45/CT45 XP series offers three Honeywell high-performance imager options:

- S0703 Imager
- N6803 FlexRange Imager
- N6700 Imager (CT45 XP only)

Barcode Symbolologies

The computer supports the following barcode symbolologies:

1D Symbolologies		2D Symbolologies		Postal Codes	
	Default		Default		Default
Codabar	Enabled	Aztec Code	Enabled	China Post	Disabled
Code 39	Enabled	Codablock A	Disabled	Korean Post	Disabled
Code 11	Disabled	Codablock F	Disabled	2D Postal	Disabled
Code 93	Disabled	DataMatrix	Enabled		
Code 128	Enabled	DotCode	Disabled		
Composite	Disabled	Grid Matrix	Disabled		
EAN-8	Enabled	HanXin	Disabled		
EAN-13	Enabled	Maxicode	Disabled		
GS1-128	Enabled	Micro PDF 417	Disabled		
GS1 DataBar	Disabled	PDF 417	Enabled		
IATA 2 of 5	Disabled	QR Code	Enabled		

1D Symbologies		2D Symbologies		Postal Codes	
	Default		Default		Default
Standard 2 of 5	Disable	OCR	Disabled		
Interleaved 2 of 5	Enable	Digimarc	Disabled		
Matrix 2 of 5	Disable	TLC 39	Disabled		
MSI	Disable				
Telepen	Disable				
Trioptic	Disable				
UPC/EAN	Enabled				
UPC-A	Enabled				
UPC-E	Enabled				

Note: To learn about changing the symbology settings, see [Change the Scanner Settings](#) on page 36.

S0703 Imager

The depth of field measurements used the following parameters:

- Distances are measured from the front of the Imager.
- +23°C (+73°F), 0 lux for guaranteed, 200 lux for typical.
- Photographic quality codes.

Note: Time to Read and Depth of Field are impacted if the barcode symbol is at the edge of the image.

Guaranteed Specs

Focus		Standard Range	
Symbology		Near Distance	Far Distance
5 mils Code 39	mm	79	270
	in.	3.11	10.63
10 mils Code 39	mm	40	450
	in.	1.57	17.72
20 mils Code 39	mm	44	674
	in.	1.73	26.53
13 mils 100% UPC-A	mm	44	515
	in.	1.73	20.27
15 mils Code 128	mm	42	572
	in.	1.65	22.52
10 mils Data Matrix	mm	83.1	236
	in.	3.27	9.29

Focus		Standard Range	
Symbology		Near Distance	Far Distance
5 mils PDF 417	mm	119	177.04
	in.	4.68	6.97
6.7 mils PDF 417	mm	96.01	236
	in.	3.78	9.29
15 mils QR	mm	39	390
	in.	1.54	15.35

Typical Specs

Focus		Standard Range	
Symbology		Near Distance	Far Distance
5 mils Code 39	mm	70	301
	in.	2.75	11.85
10 mils Code 39	mm	40	517
	in.	1.57	20.35
20 mils Code 39	mm	44	800
	in.	1.73	31.5
13 mils 100% UPC-A	mm	44	573
	in.	1.73	22.56
15 mils Code 128	mm	42	650
	in.	1.65	25.59
10 mils Data Matrix	mm	72	297
	in.	2.83	11.69
6.7 mils PDF 417	mm	84	244
	in.	3.31	9.61
15 mils QR	mm	39	414
	in.	1.54	16.30

S0703 Imager Field of View/Resolution

Focus	Standard Range (SR)
Horizontal Field Angle (degrees)	44 ± 2°
Vertical Field Angle (degrees)	28 ± 2°

DPI can be calculated based on the following formula:

Horizontal DPI = 1280 pixels/width of horizontal field of view (inches)

Vertical DPI = 800 pixels/width of vertical field of view (inches)

N6803 FlexRange Imager

The depth of field measurements used the following parameters:

- Distances are measured from the front of the Imager.
- +23°C (+73°F), 200 lux for guaranteed, 200 lux for typical.
- Photographic quality codes.

Note: *Time to Read and Depth of Field will be impacted if the barcode symbol is at the edge of the image.*

Guaranteed Specs

Focus		Standard Range	
Symbology		Near Distance	Far Distance
5 mils Code 39	mm	138	365
	in.	5.43	14.4
10 mils Data Matrix	mm	152	387
	in.	6	15.23
10 mils Code 39	mm	94	1198
	in.	4	47.2
13 mils UPC-A	mm	68	1437
	in.	3	57
15 mils Code 128	mm	66	1571
	in.	3	62
20 mils Code 39	mm	63	2161
	in.	3	85.1
100 mils Data Matrix ¹	mm	-	4505
	in.	-	177.4
55 mils Code 39 ¹	mm	-	6546
	in.	-	258
100 mils Code 39 ^{1,2}	mm	-	9843
	in.	-	388
¹ Minimum distance depends on the length of the barcode. ² Typical code wide to narrow elemental ratio is 3:1. Minimum 100 mils code height of 3 inches.			

Typical Specs

Focus		Standard Range	
Symbology		Near Distance	Far Distance
5 mils Code 39	mm	122	414
	in.	5	16.3
10 mils Data Matrix	mm	135	419
	in.	5.3	17
10 mils Code 39	mm	85	1368
	in.	3.4	54
13 mils UPC-A	mm	60	1600
	in.	2.4	63
15 mils Code 128	mm	58	1894
	in.	2.3	75
20 mils Code 39	mm	56	2645
	in.	2.2	104.1
100 mils Data Matrix ¹	mm	-	5641
	in.	-	222.1
55 mils Code 39 ¹	mm	-	7159
	in.	-	282
100 mils Code 39 ^{1,2}	mm	-	10815
	in.	-	426
¹ Minimum distance depends on the length of the barcode. ² Typical code wide to narrow elemental ratio is 3:1. Minimum 100 mil code height of 3 inches.			

N6803 FlexRange Imager Field of View/Resolution

Near Field Optical System

- Horizontal FOV: 48°
- Vertical FOV: 21°

Note: DPI can be calculated based on the following formula:

Horizontal DPI = 1920 pixels/width of horizontal field of view (inches)

Vertical DPI = 800 pixels/width of vertical field of view (inches)

Far Field Optical System

- Horizontal FOV: 20°
- Vertical FOV: 12°

DPI can be calculated based on the following formula:

Horizontal DPI = 1280 pixels/width of horizontal field of view (inches)

Vertical DPI = 800 pixels/width of vertical field of view (inches)

N6700 Imager (CT45 XP Only)

Note: Time to Read and Depth of Field are impacted if the barcode symbol is at the edge of the image.

Guaranteed Specs

Focus		Standard Range	
Symbology		Near Distance	Far Distance
3 mils Code 39	mm	129.03	164.1
	in.	5.08	6.46
5 mils Code 39	mm	79	270
	in.	3.11	10.63
10 mils Code 39	mm	34.04	450.1
	in.	1.34	17.72
20 mils Code 39	mm	38.1	674
	in.	1.50	26.53
13 mils 100% UPC-A	mm	38.1	515
	in.	1.50	20.27
13 mils 20% UPC-A	mm	83.1	205
	in.	3.27	8.07
15 mils Code 128	mm	36.1	572.01
	in.	1.42	22.52
10 mils Data Matrix	mm	83.1	236
	in.	3.27	9.29
5 mils PDF 417	mm	119	177.04
	in.	4.68	6.97
6.7 mils PDF 417	mm	96.01	236
	in.	3.78	9.29
6.7 mils QR	mm	123	147.1
	in.	4.84	5.79

Focus		Standard Range	
Symbology		Near Distance	Far Distance
15 mils QR	mm	33.02	390
	in.	1.30	15.35

Typical Specs

Focus		Standard Range	
Symbology		Near Distance	Far Distance
3 mils Code 39	mm	106	176.02
	in.	4.17	6.93
5 mils Code 39	mm	70	301
	in.	2.75	11.85
10 mils Code 39	mm	29	517
	in.	1.14	20.35
20 mils Code 39	mm	35.1	800.1
	in.	1.38	31.5
13 mils 100% UPC-A	mm	34.04	573.02
	in.	1.34	22.56
13 mils 20% UPC-A	mm	79	228.1
	in.	3.11	8.98
15 mils Code 128	mm	34.04	650
	in.	1.34	25.59
10 mils Data Matrix	mm	72	297
	in.	2.83	11.69
5 mils PDF 417	mm	105	181
	in.	4.13	7.12
6.7 mils PDF 417	mm	84.1	244.1
	in.	3.31	9.61
6.7 mils QR	mm	105	169
	in.	4.13	6.65
15 mils QR	mm	27	414.02
	in.	1.06	16.30

N6700 Imager

Focus	Standard Range (SR)
Horizontal Field Angle (degrees)	48 ± 2°
Vertical Field Angle (degrees)	31 ± 2°

*DPI can be calculated based on the following formula:
Horizontal DPI = 1280 pixels/width of horizontal field of view (inches)
Vertical DPI = 800 pixels/width of vertical field of view (inches)*

Honeywell
855 S. Mint Street
Charlotte, NC 28202

sps.honeywell.com