

USE AND INSTALLATION INSTRUCTIONS

Thank you very much for purchasing this Air Conditioner. Please read this use and installation instructions carefully before installing and using this appliance and keep this manual for future reference.

Contents

| | |
|---|----|
| Safety introduction | 1 |
| Preparation before use | 2 |
| Safety Precautions | 3 |
| Identification of parts | |
| Indoor unit | 4 |
| Outdoor unit | 4 |
| Display introduction | 5 |
| Maintenance | 6 |
| Protection | 7 |
| Troubleshooting | 8 |
| Installation instructions | |
| Installation diagram | 9 |
| Select the installation locations | 10 |
| Indoor unit installation | 11 |
| Outdoor unit installation | 16 |
| Air purging | 16 |

Remote controller operating instructions. See "remote controller instructions".

Safety instructions

- To guarantee the unit work normally, please read the manual carefully before installation, and try to install strictly according to this manual.
- Do not let air enter the refrigeration system or discharge refrigerant when moving the air conditioner.
- Earth the air conditioner properly.
- Check the connecting cables and pipes carefully, make sure they are correct and firm before connecting the power of the air conditioner.
- There must be an air-break switch.
- After installing, the consumer must operate the air conditioner correctly according to this manual, keep a suitable storage for maintenance and moving of the air conditioner in the future.
- Type of fuse used on indoor unit controller is $\Phi 5 \times 20$, with rating T 3.15A/250V.
- A residual current device (RCD) with the rating of above 10mA shall be incorporated in the fixed wiring according to the national rule
- Warning: Risk of electric shock can cause injury or death: Disconnect all remote electric power supplies before servicing .
- The maximum length of the connecting pipe between the indoor unit and outdoor unit should be less than 5 meters. It will affect the efficiency of the air conditioner if the distance longer than that length.
- This appliance can be used by children aged from 8 years and above and persons with reduced physical, sensory or mental capabilities or lack of experience and knowledge if they have been given supervision or instruction concerning use of the appliance in a safe way and understand the hazards involved. Children shall not play with the appliance. Cleaning and user maintenance shall not be made by children without supervision.
- The batteries in remote controller must be recycled or disposed of properly.
Disposal of Scrap Batteries --- Please discard the batteries as sorted municipal waste at the accessible collection point.
- If the appliance is fixed wiring, the appliance must be fitted with means for disconnection from the supply mains having a contact separation in all poles that provide full disconnection under over voltage category III conditions, and these means must be incorporated in the fixed wiring in accordance with the wiring rules.
- If the supply cord is damaged, it must be replaced by the manufacturer, its service agent or similarly qualified persons in order to avoid a hazard.
- The appliance shall be installed in accordance with national wiring regulations.
- The air conditioner must be installed by professional or qualified persons.
- The appliance shall not be installed in the laundry.

Preparation before use

Note

- When charging refrigerant into the system, make sure to charge in liquid state, if the refrigerant of the appliance is R410A. Otherwise, chemical composition of refrigerant (R410A) inside the system may change and thus affect the performance of the air conditioner.
- According to the character of refrigerant (R410A, the value of GWP is 1975), the pressure of the tube is very high, so be careful when you install and repair the appliance.
- If the supply cord is damaged, it must be replaced by the manufacturer, its service agent or similarly qualified persons in order to avoid a hazard.
- The air conditioner must be installed by a professional engineer.
- The temperature of refrigerant circuit will be high, please keep the interconnection cable away from the copper tube.

Before using the air conditioner, be sure to check and preset as the following.

- **Remote Controller presetting**
Each time after the remote control is replaced with new batteries or is energized, remote control auto presetting heat pump. If the air conditioner you purchased is a Cooling Only one, heat pump remote controller can also be used.
- **Back-light function (optional)**
Hold down any button of the remote controller for about 2 seconds, the back-light will be turned on. It will be turned off automatically after about 10 seconds.
Note: Back-light is an optional function.
- **Auto Restart Presetting**
The air conditioner has Auto-Restart function.
You can set or cancel this function when the air conditioner is running.
 - Hold down the emergency button (ON/OFF) for a few seconds, this function will be set if you hear beep twice. If you just hear beep once, this function will be canceled.

Safeguarding the environment

This marking indicates that this product should not be disposed with other household wastes throughout the EU. To prevent possible harm to the environment or human health from uncontrolled waste disposal, recycle it responsibly to promote the sustainable reuse of material resources. To return your used device, please use the return and collection systems or contact the retailer where the product was purchased. They can take this product for environmental safe recycling.





Safety precautions



















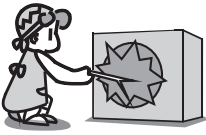

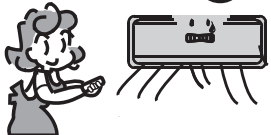

Symbols in this Use and Care Manual are interpreted as shown below.

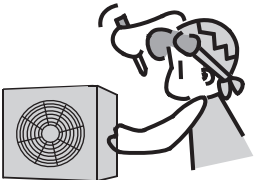
 Be sure not to do.

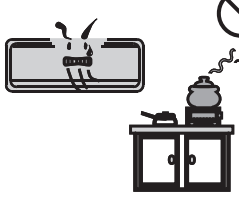
 Grounding is essential.

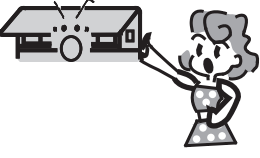
 Pay attention to such a situation.

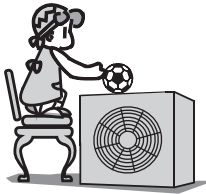
 Warning: Incorrect handling could cause a serious hazard, such as death, serious injury, etc.

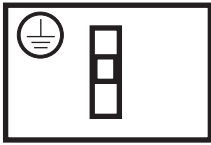
| | | |
|--|---|--|
| <p></p> <p>Use correct power supply in accordance with the rating plate requirement. Otherwise, serious faults or hazard may occur or a fire may break out.</p> | <p></p> <p></p> <p>Keep the power supply circuit breaker or plug from dirt. Connect the power supply cord to it firmly and correctly, lest an electric shock or a fire break out due to insufficient contact.</p> | <p></p> <p></p> <p>Do not use the power supply circuit breaker or pull off the plug to turn it off during operation. This may cause a fire due to spark, etc.</p> |
| <p></p> <p></p> <p>Do not knit, pull or press the power supply cord, lest the power supply cord be broken. An electric shock or fire is probably caused by a broken power supply cord.</p> | <p></p> <p></p> <p>Never insert a stick or similar obstacle to the unit. Since the fan rotates at high speed, this may cause an injury.</p> | <p></p> <p></p> <p>It is harmful to your health if the cool air reaches you for a long time. It is advisable to let the air flow be deflected to all the room.</p> |
| <p></p> <p></p> <p>Turn off the appliance by remote control firstly before cutting off power supply if malfunction occurs.</p> | <p></p> <p></p> <p>Do not repair the appliance by yourself. If this is done incorrectly, it may cause an electric shock, etc.</p> | <p></p> <p></p> <p>Prevent the air flow from reaching the gas burners and stove.</p> |
| <p></p> <p></p> <p>Do not touch the operation buttons when your hands are wet.</p> | <p></p> <p></p> <p>Do not put any objects on the outdoor unit.</p> | <p></p> <p></p> <p></p> <p>It is the user's responsibility to make the appliance be grounded according to local codes or ordinances by a licenced technician.</p> |

Identification of parts

Indoor unit

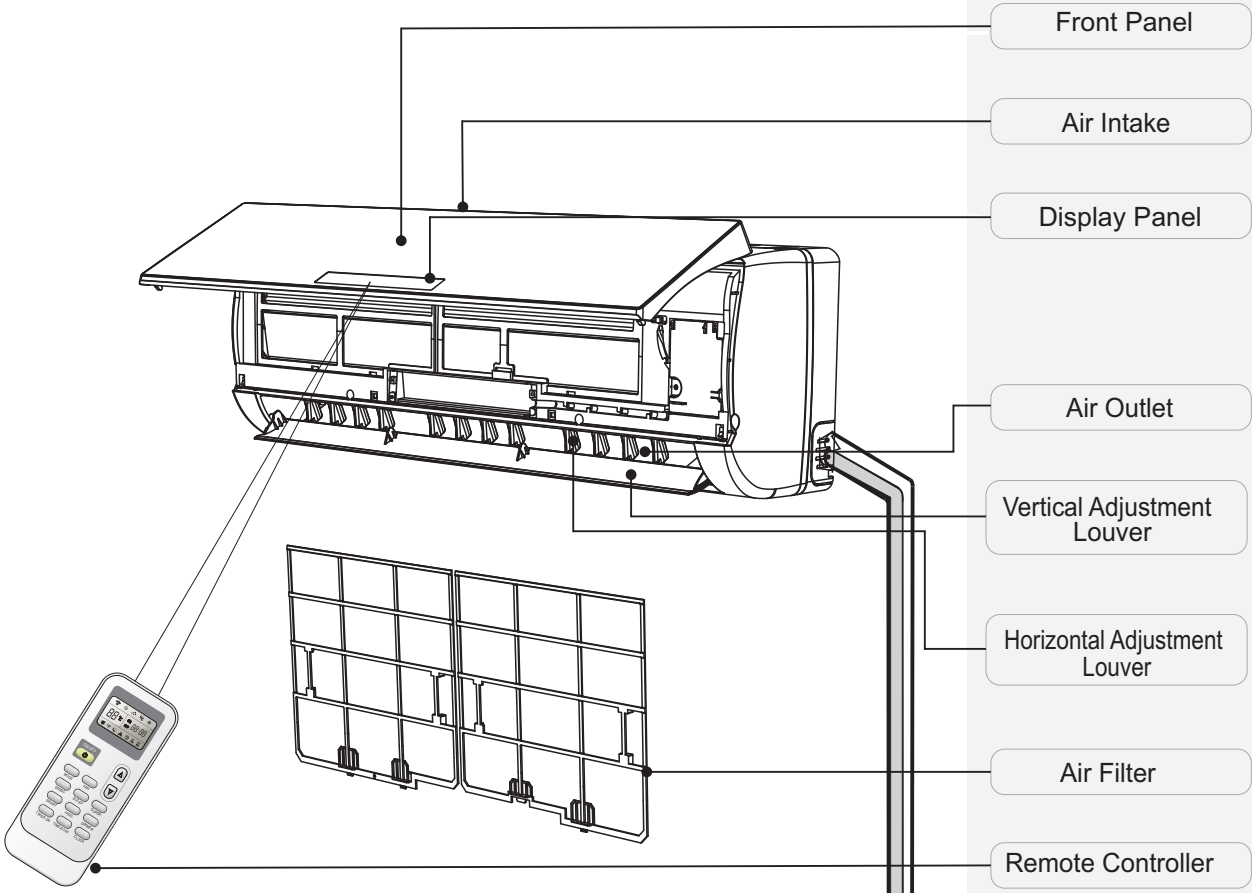

Outdoor unit

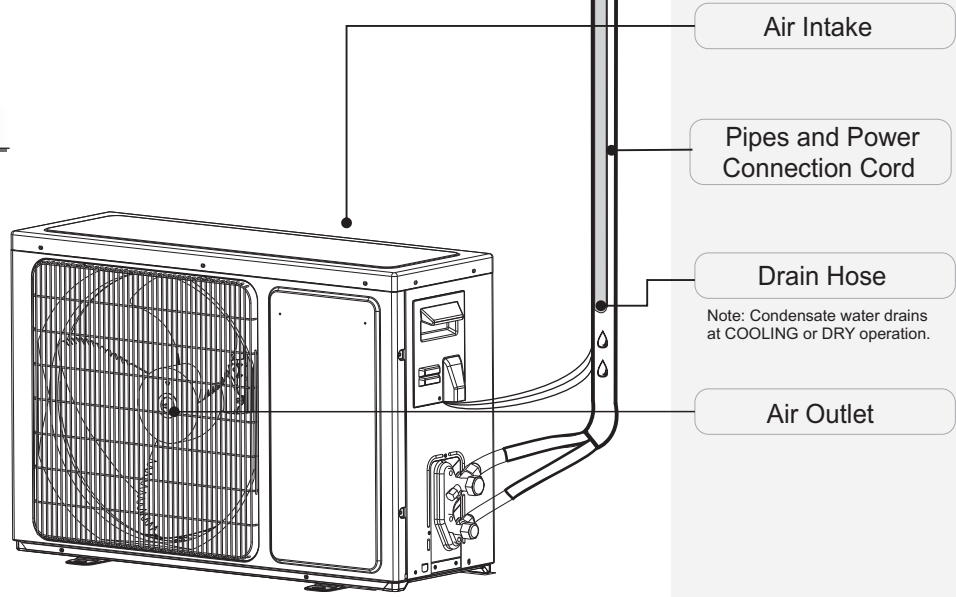





Note: Condensate water drains at COOLING or DRY operation.

☑ The figures in this manual are based on the external view of a standard model. Consequently, the shape may differ from that of the air conditioner you have selected.

Display introduction

88 Temperature indicator 1
 Display set temperature.
 It shows FC after 200 hours of usage as reminder to clean the filter.
 After filter cleaning press the filter reset button located on the indoor unit behind the front panel in order to reset the display. (optional)

    Run 2
 It lights up when the AC is running.
 It flashes during defrosting.

      Timer 3
 It lights up during set time.

      Sleep 4
 It lights up in sleep mode.

     Comp. 5
 It lights up when the compressor is on.

 Super indicator 6
 It lights up in super mode.

 Mode indicator 7
 Heating displays orange, others display white

 Fan speed indicator 8

Signal Receptor 9

 Filter Clean indicator 10
 It lights up when the filter needs to be cleaned.

VG/VL series

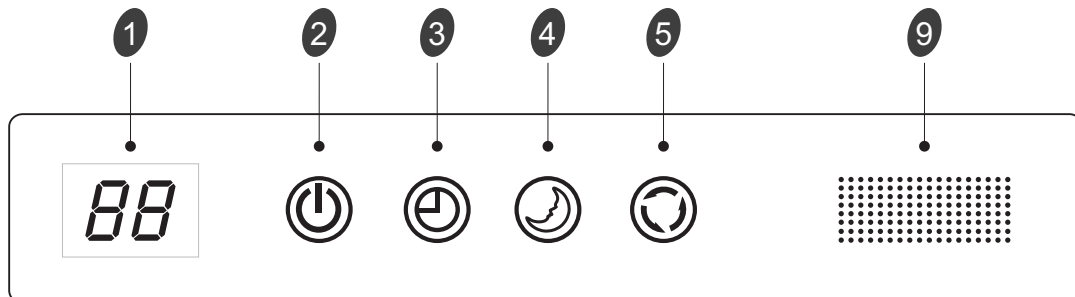

 The symbols may be different from these models, but the functions are similar.

Display introduction

VT series

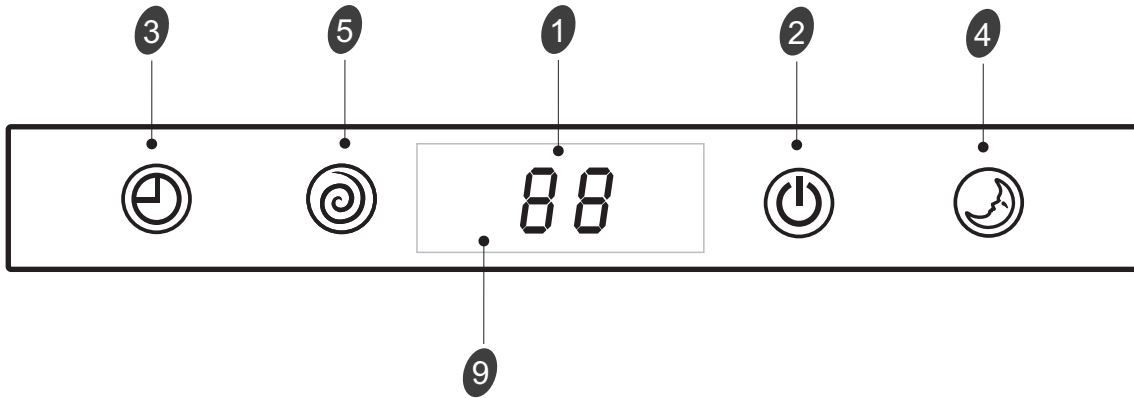

SF/DG(Right side) series

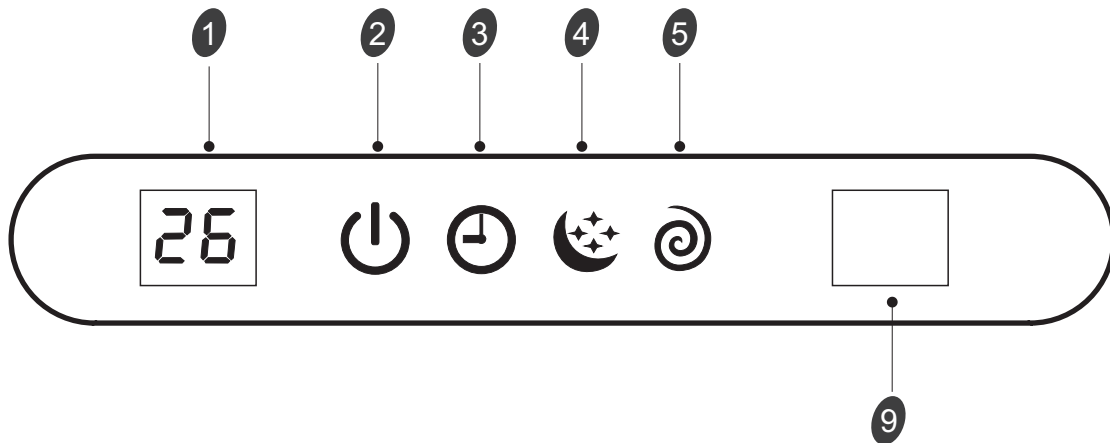

SE series

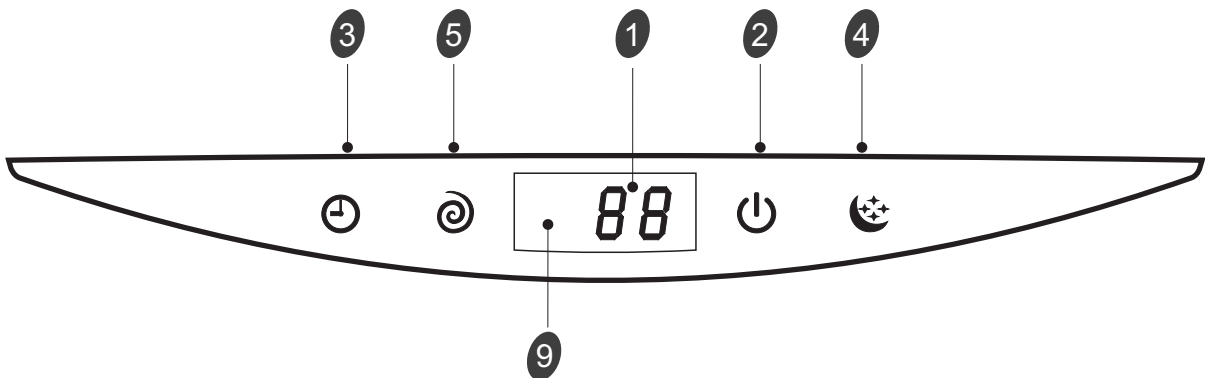

☑ The symbols may be different from these models, but the functions are similar.

Display introduction

UL series

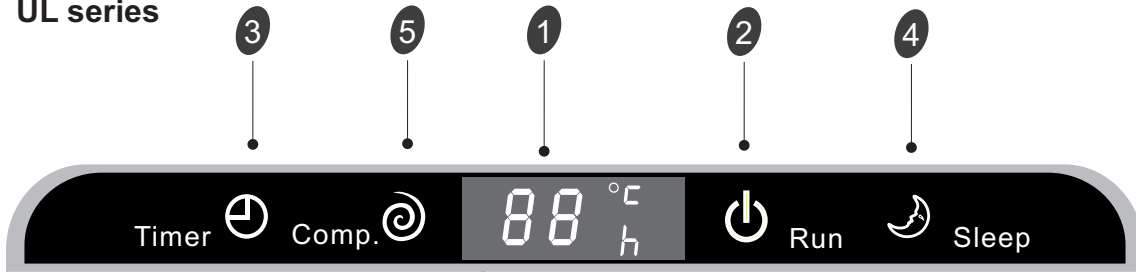

UQ series

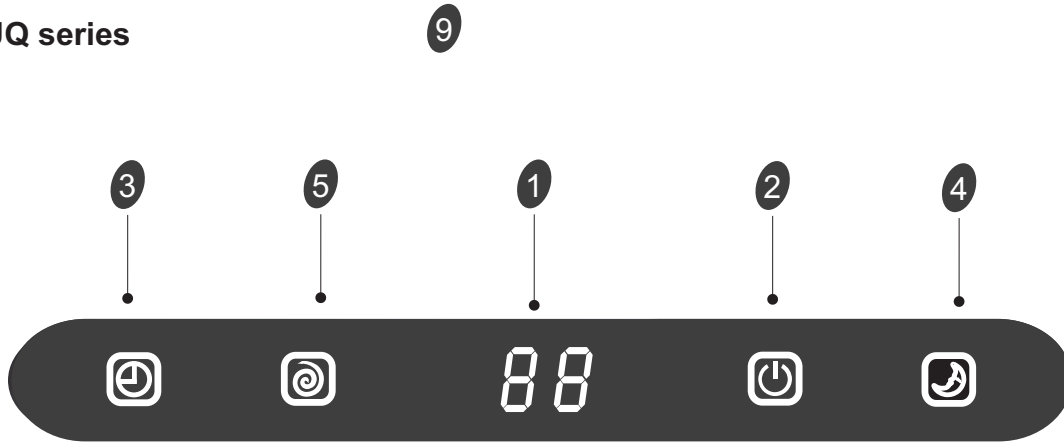

UP series

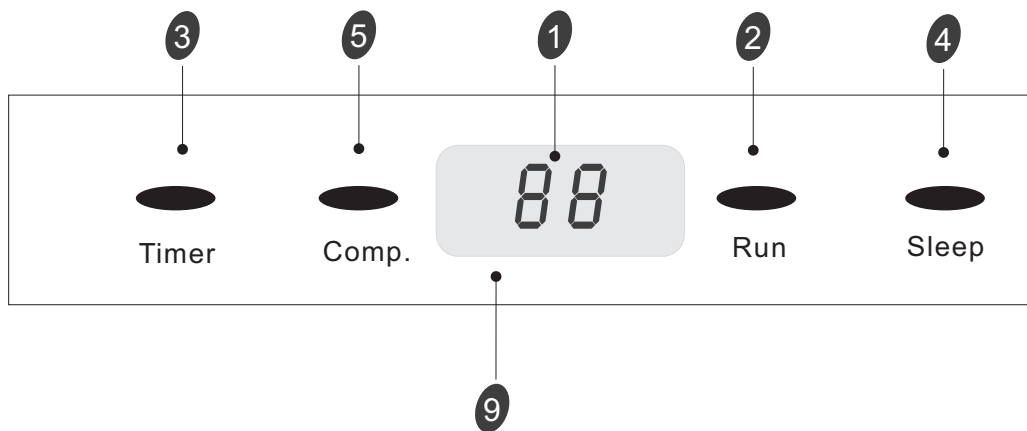

☑ The symbols may be different from these models, but the functions are similar.

Display introduction

NS/DE series

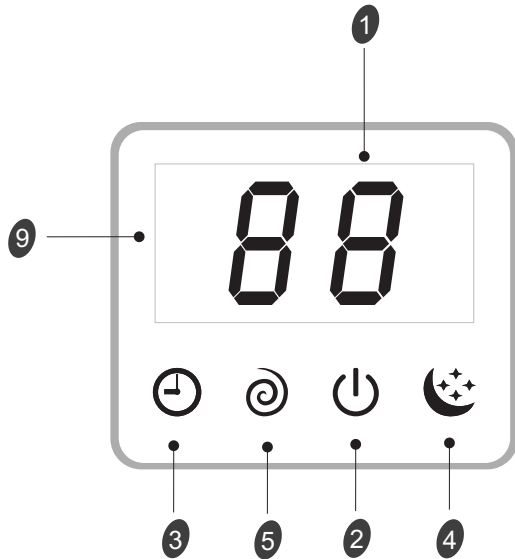

NT series

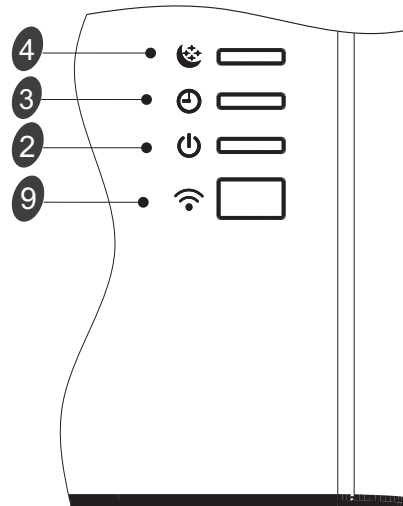

SH series

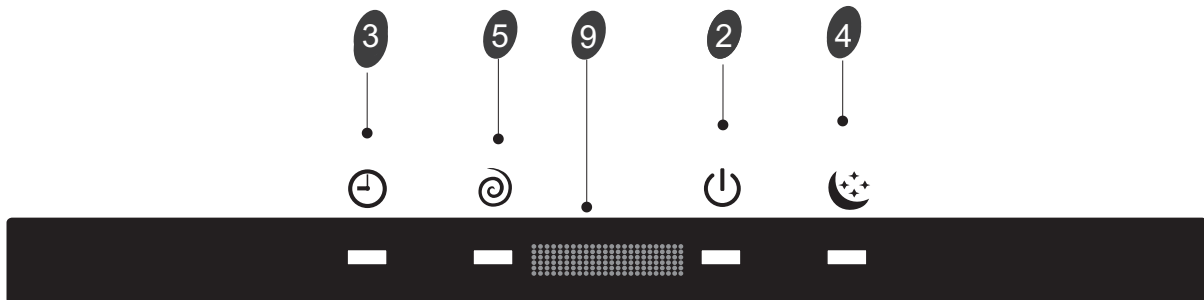

VQ/TE/TF/TK/DA/DG(Middle)/DH/SG series

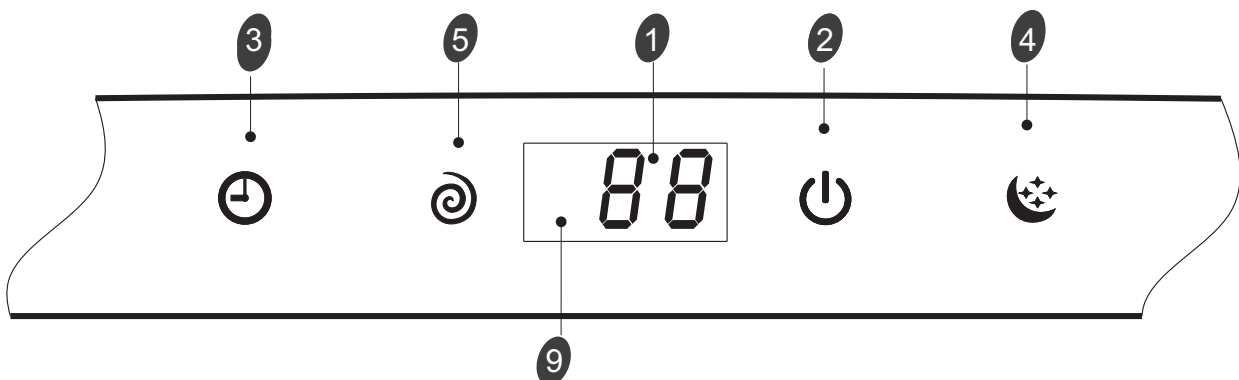

☑ The symbols may be different from these models, but the functions are similar.

Display introduction

VM series

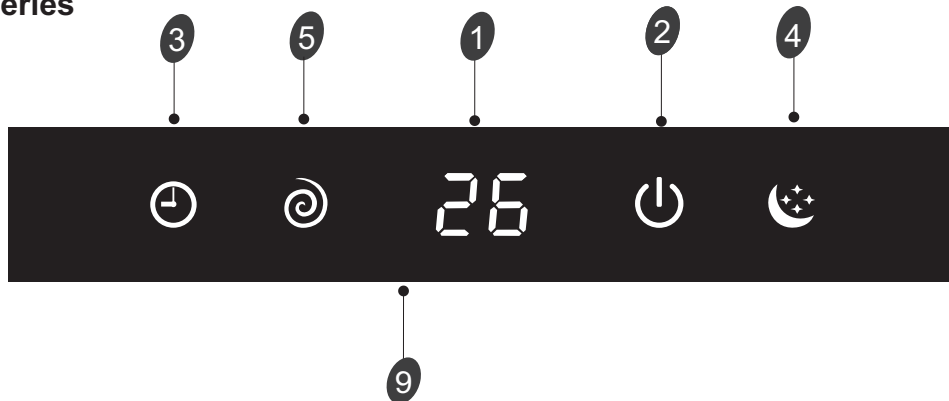

NM/DF series

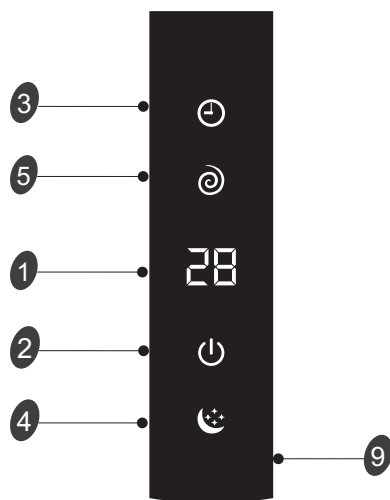

NK series

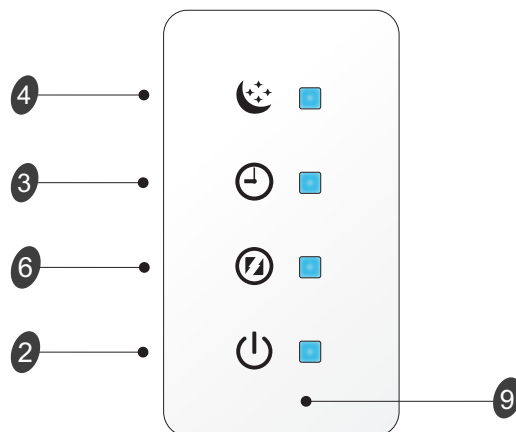

TA/TC series

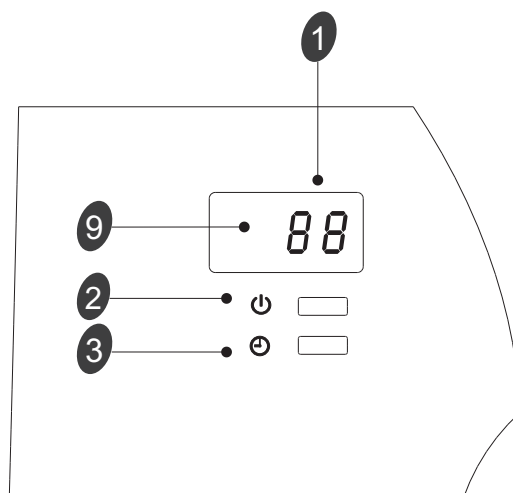

☑ The symbols may be different from these models, but the functions are similar.

Display introduction

TJ series

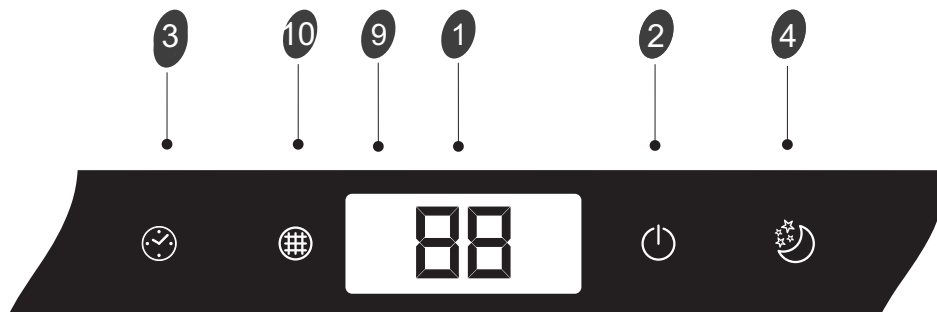

TJ (hidden display) series

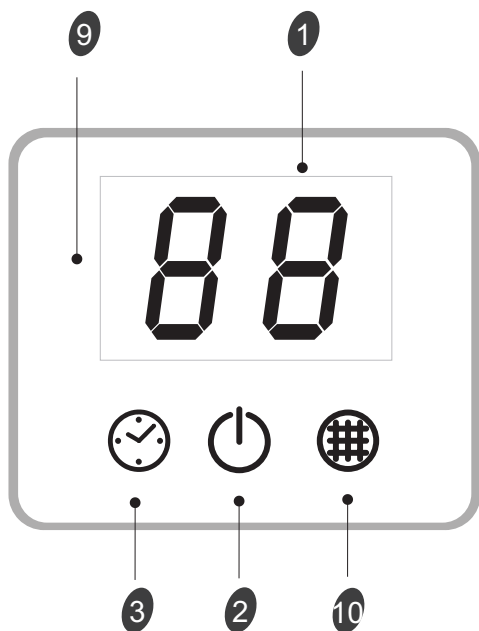

TL series

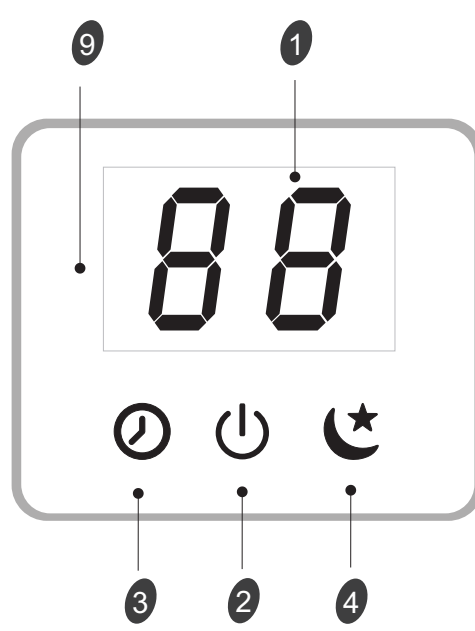

VC series

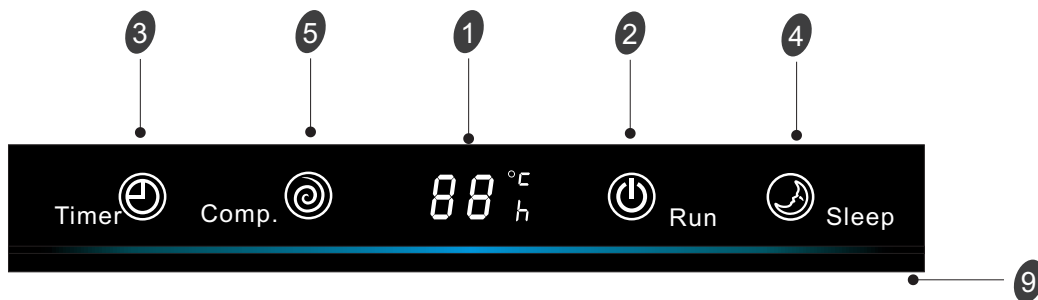

☑ The symbols may be different from these models, but the functions are similar.

Display introduction

SA/TD/TG/DB/DC series

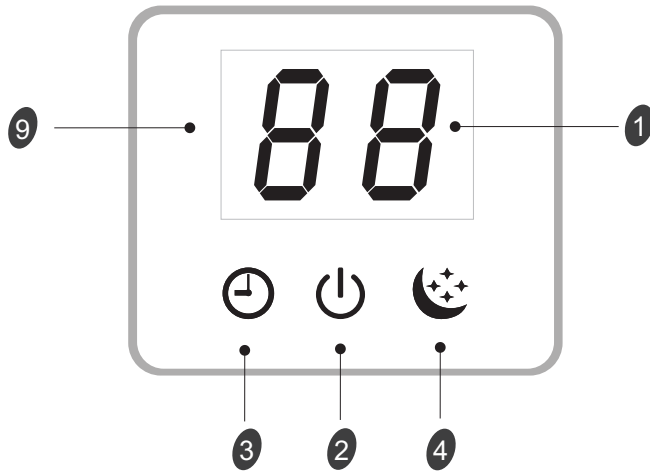

SC series

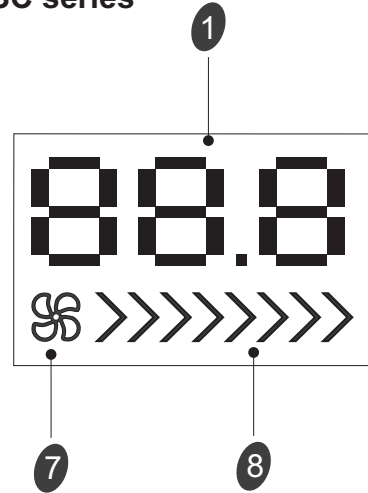

FOR THE WLP TJ SERIES

Emergency button **11**

ON/OFF To let the AC run or stop by pressing the button.

Filter reset button **12**

To reset filter clean indicator by pressing the button.

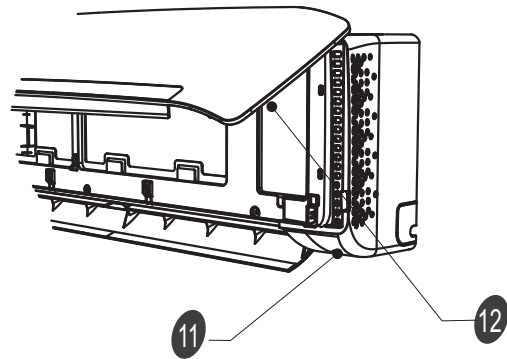

Emergency button **11**

ON/OFF To let the AC run or stop by pressing the button.

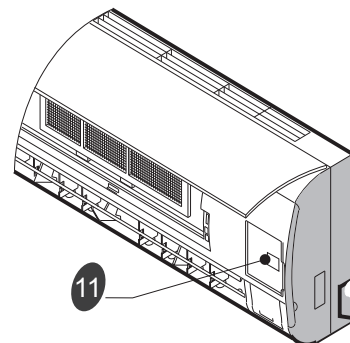

☑ The symbols may be different from these models, but the functions are similar.

Maintenance

Front panel maintenance

1 Cut off the power supply

Turn off the appliance first before disconnecting from power supply.

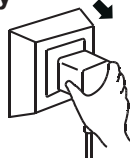

2

Grasp position "a" and pull outward to remove the front panel.

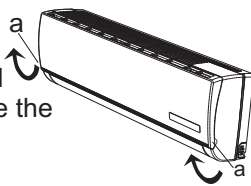

3 Wipe with a soft and dry cloth.

Use soft moisture cloth to clean if the front panel is very dirty.



Use a dry and soft cloth to clean it.

4 Never use volatile substance such as gasoline or polishing powder to clean the appliance.



5 Never sprinkle water onto the indoor unit



Dangerous!
Electric shock!

6 Reinstall and shut the front panel.

Reinstall and shut the front panel by pressing position "b" downward.

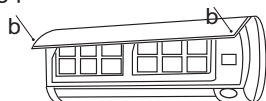

Air filter maintenance

It is necessary to clean the air filter after using it for about 100 hours.

Clean it as follows:

1 Stop the appliance and remove the air filter.

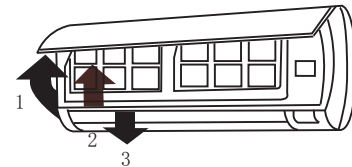

1. Open the front panel.
2. Press the handle of the filter gently from the front.
3. Grasp the handle and slide out the filter.

2 Clean and reinstall the air filter.

If the dirt is conspicuous, wash it with a solution of detergent in lukewarm water. After cleaning, dry well in shade.



3 Close the front panel again.

- ☑ *Clean the air filter every two weeks if the air conditioner operates in an extremely dusty environment.*

Protection

Operating condition

The protective device maybe trip and stop the appliance in the cases listed below.

| | |
|----------------|---------------------------------------|
| HEATING | Outdoor air temperature is over 24°C |
| | Outdoor air temperature is below -7°C |
| | Room temperature is over 27°C |
| COOLING | Outdoor air temperature is over *43°C |
| | Room temperature is below 21°C |
| DRY | Room temperature is below 18°C |

**For Tropical (T3) Climate condition models, the temperature point is 55°C instead of 43°C.
The temperature of some products is allowed beyond the range. In specific situation, please consult the merchant.*

If the air conditioner runs in COOLING or DRY mode with door or window opened for a long time when relative humidity is above 80%, dew may drip down from the outlet.

Noise pollution

- Install the air conditioner at a place that can bear its weight in order to operate more quietly.
- Install the outdoor unit at a place where the air discharged and the operation noise would not annoy your neighbors.
- Do not place any obstacles in front of the air outlet of the outdoor unit lest it increases the noise level.

Features of protector

① The protective device will work at following cases.

- Restarting the unit at once after operation stops or changing mode during operation, you need to wait 3 minutes.
- Connect to power supply and turn on the unit at once, it may start 20 seconds later.

- ② • If all operation has stopped, press **ON/OFF** button again to restart, Timer should be set again if it has been canceled.

Features of HEATING mode

Preheat

At the beginning of **HEATING** operation, the airflow from indoor unit is discharged 2-5 minutes later.



Defrost

In **HEATING** operation the appliance will defrost (de-ice) automatically to raise efficiency. This procedure usually lasts 2-10 minutes. During defrosting, fans stop operation. After defrosting completes, it returns to **HEATING** mode automatically.

Note: Heating is NOT available for cooling only air conditioner models.

Troubleshooting

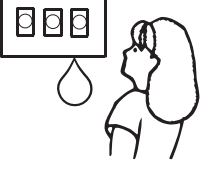
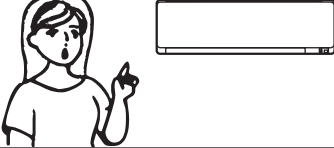
The following cases may not always be a malfunction, please check it before asking for service.

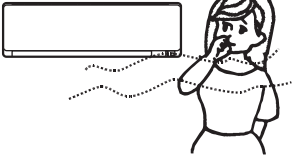
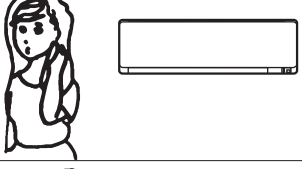
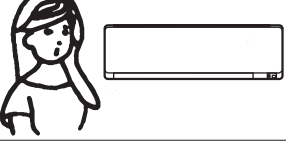
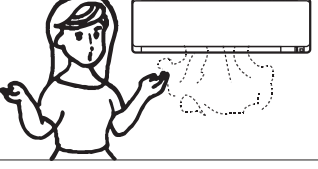
| Trouble | Analysis |
|---|--|
| <p>Does not run</p>  | <ul style="list-style-type: none"> • If the protector trip or fuse is blown. • Please wait for 3 minutes and start again, protector device may be preventing unit to work. • If batteries in the remote controller exhausted. • If the plug is not properly plugged. |
| <p>No cooling or heating air</p>  | <ul style="list-style-type: none"> • Is the air filter dirty? • Are the intakes and outlets of the air conditioner blocked? • Is the temperature set properly? |
| <p>Ineffective control</p>  | <ul style="list-style-type: none"> • If strong interference (from excessive static electricity discharge, power supply voltage abnormality) presents, operation will be abnormal. At this time, disconnect from the power supply and connect back 2-3 seconds later. |
| <p>Does not operate immediately</p>  | <ul style="list-style-type: none"> • Changing mode during operation, 3 minutes will delay. |
| <p>Peculiar odor</p>  | <ul style="list-style-type: none"> • This odor may come from another source such as furniture, cigarette etc, which is sucked in the unit and blows out with the air. |
| <p>A sound of flowing water</p>  | <ul style="list-style-type: none"> • Caused by the flow of refrigerant in the air conditioner, not a trouble. • Defrosting sound in heating mode. |
| <p>Cracking sound is heard</p>  | <ul style="list-style-type: none"> • The sound may be generated by the expansion or contraction of the front panel due to change of temperature. |
| <p>Spray mist from the outlet</p>  | <ul style="list-style-type: none"> • Mist appears when the room air becomes very cold because of cool air discharged from indoor unit during COOLING or DRY operation mode. |
| <p>The compressor indicator (red) lights on constantly, and indoor fan stops.</p> | <ul style="list-style-type: none"> • The unit is shifting from heating mode to defrost. The indicator will lights off within ten minutes and returns to heating mode. |

Installation instructions

Installation diagram

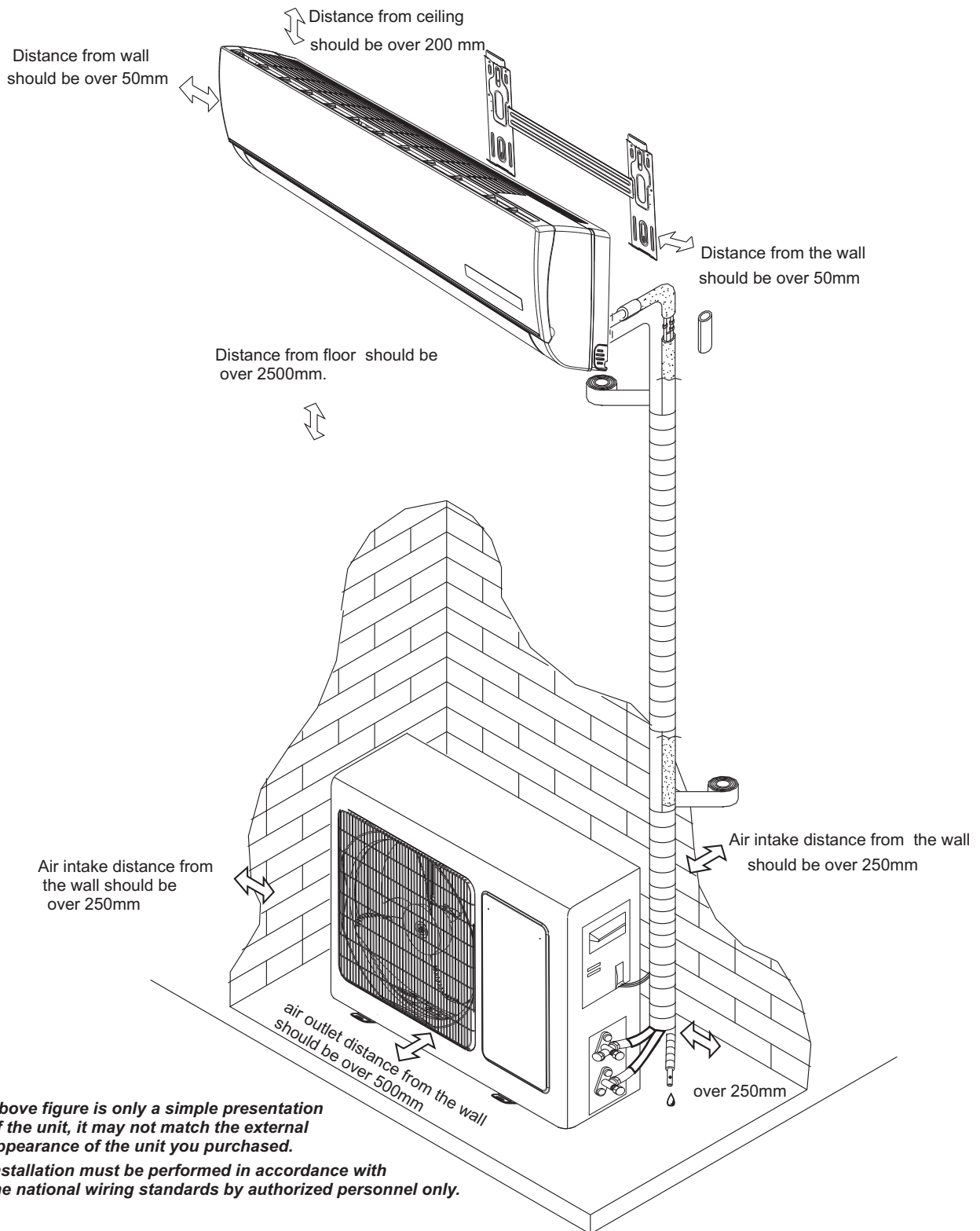

- Above figure is only a simple presentation of the unit, it may not match the external appearance of the unit you purchased.
- Installation must be performed in accordance with the national wiring standards by authorized personnel only.

Installation instructions

Select the installation location

Location for Installing Indoor Unit

- Where there is no obstacle near the air outlet and air can be easily blown to every corner.
- Where piping and wall hole can be easily arranged.
- Keep the required space from the unit to the ceiling and wall according to the installation diagram on previous page.
- Where the air filter can be easily removed.
- Keep the unit and remote controller 1m or more apart from television, radio etc.
- To prevent the effects of a fluorescent lamps, keep as far as possible.
- Do not put anything near the air inlet to obstruct it from air absorption.
- Where there is strong enough to bear the weight and is not tend to increase operation noise and vibration.

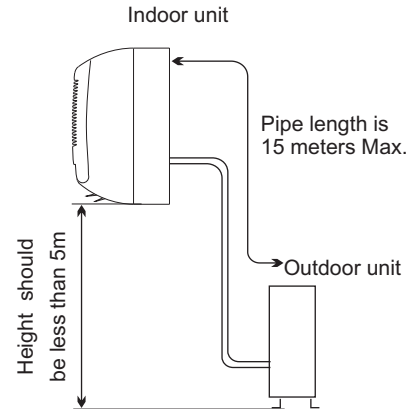

Location for Installing Outdoor Unit

- Where it is convenient to install and well ventilated.
- Avoid installing it where flammable gas could leak.
- Keep the required distance apart from the wall.
- The distance between Indoor and outdoor unit should be 5 meters and can go up to maximum 15 meters with additional refrigerant charge.
- Keep the outdoor unit away from a place of greasy dirt, vulcanization gas exit.
- Avoid installing it at the roadside where there is a risk of muddy water.
- A fixed base where is not subject to increasing operation noise.
- Where there is not any blockage for air outlet.

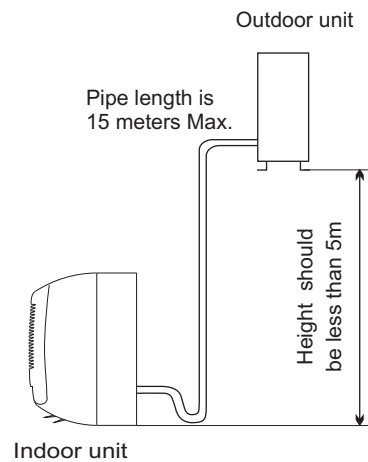

| Model | Max. Allowable Tubing Length at Shipment (m) | Limit of Tubing Length (m) | Limit of Elevation Difference H (m) | Required amount of additional refrigerant (g/m) |
|-------------|--|----------------------------|-------------------------------------|---|
| 5K~18K | 5 | 15 | 5 | 20 |
| 22K.24K | 5 | 15 | 5 | 30 |
| 28K.30K.36K | 5 | 15 | 5 | 40 |

If the height or pipe length is out of the scope of the table, please consult the merchant.

Installation instructions

Indoor unit installation

1. Installing the Mounting Plate

- Decide an installing location for the mounting plate according to the indoor unit location and piping direction.
- Keep the mounting plate horizontally with a horizontal ruler or dropping line.
- Drill holes of 32mm in depth on the wall for fixing the plate.
- Insert the plastic plugs to the hole, fix the mounting plate with tapping screws.
- Inspect if the mounting plate is well fixed. Then drill a hole for piping.

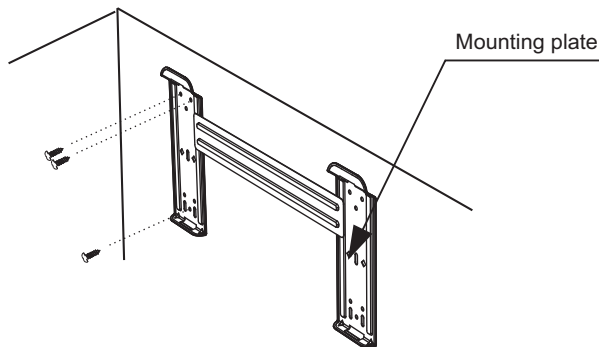

Note: The shape of your mounting plate may be different from the one above, but installation method is similar.

2. Drill a Hole for Piping

- Decide the position of hole for piping according to the location of mounting plate.
- Drill a hole on the wall. The hole should tilt a little downward toward outside.
- Install a sleeve through the wall hole to keep the wall tidy and clean.

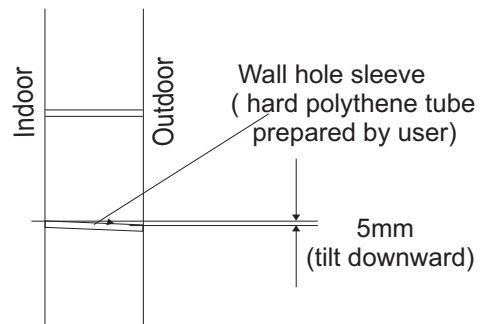

3. Indoor Unit Piping Installation

- Put the piping (liquid and gas pipe) and cables through the wall hole from outside or put them through from inside after indoor piping and cables connection complete so as to connect to outdoor unit.
- Decide whether saw the unloading piece off in accordance with the piping direction. (as shown below)

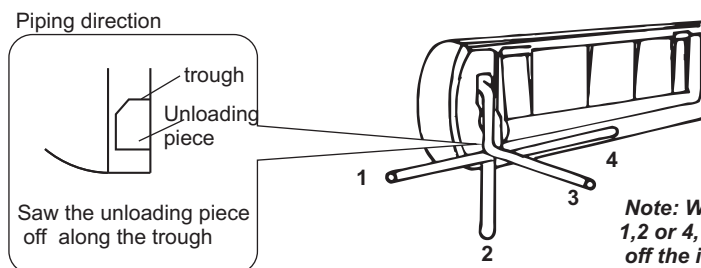

- After connecting piping as required, install the drain hose. Then connect the power cords. After connecting, wrap the piping, cords and drain hose together with thermal insulation materials.

Installation instructions



- **Piping Joints Thermal Insulation:** Wrap the piping joints with thermal insulation materials and then wrap with a vinyl tape.

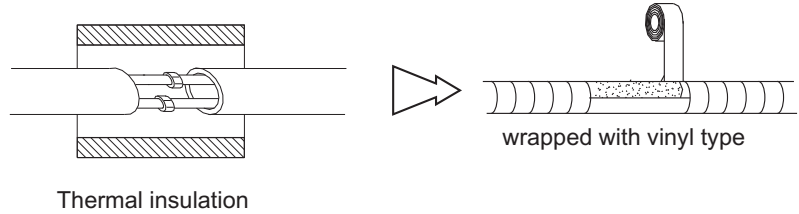

- **Piping Thermal Insulation:**

- Place the drain hose under the piping.
- Insulation material uses polythene foam over 6mm in thickness.
Note: Drain hose is prepared by user.

- Drain pipe should point downward for easy drain flow. Do not arrange the drain pipe twisted, sticking out or wave around, do not immerse the end of it in water.

If an extension drain hose is connected to the drain pipe, make sure to thermal insulated when passing along the indoor unit.

- When the piping is directed to the right, piping, power Cord and drain pipe should be thermal insulated and fixed onto the back of the unit with a piping fixer.

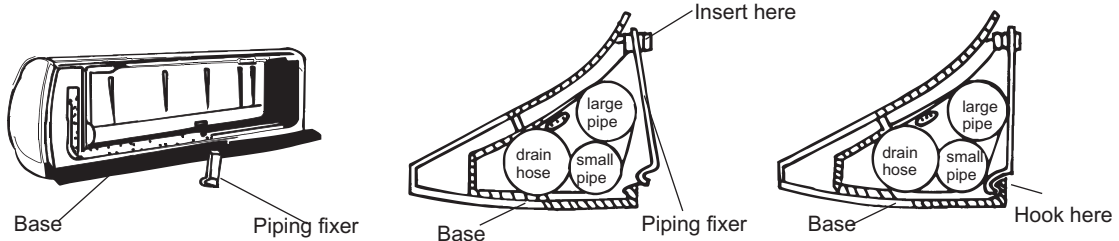
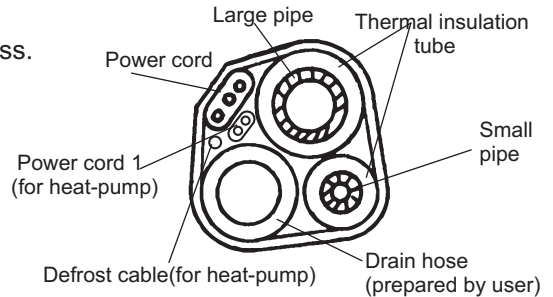

A. Insert the pipe fixer to the slot.

B. Press to hook the pipe fixer onto the base.

Piping Connection:

- Connect indoor unit pipes with two wrenches. Pay special attention to the allowed torque as shown below to prevent the pipes, connectors and flare nuts from being deformed and damaged.
- Pre-tighten them with fingers at first, then use the wrenches.



| Model | Pipe size | Torque | Nut width | Min.thickness |
|----------------------------|--|----------|-----------|---------------|
| 5,7,8,9,10,12,14,15,18,24K | Liquid Side (ϕ 6mm or 1/4 inch) | 15~20N·m | 17mm | 0.5mm |
| 18K*,22,24K*,28,30,36K | Liquid Side (ϕ 9.53mm or 3/8 inch) | 30~35N·m | 22mm | 0.6mm |
| 5,7,8,9,10K | Gas Side (ϕ 9.53mm or 3/8 inch) | 30~35N·m | 22mm | 0.6mm |
| 12,14,15,18K | Gas Side (ϕ 12mm or 1/2 inch) | 50~55N·m | 24mm | 0.6mm |
| 18K*,22,24,28,30,36K | Gas Side (ϕ 16mm or 5/8 inch) | 60~65N·m | 27mm | 0.6mm |
| 36K* | Gas Side (ϕ 19mm or 3/4 inch) | 70~75N·m | 32mm | 1.0mm |

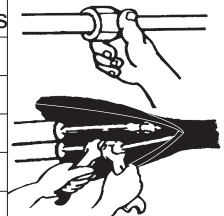

The unit of 12K, 18K*, 24K*, 30K*, 36K* is bigger than the unit of 12K, 18K, 24K, 30K, 36K.

Installation instructions

4. Connecting of the Cable

• Indoor Unit

Connect the power connecting cord to the indoor unit by connecting the wires to the terminals on the control board individually in accordance with the outdoor unit connection.

Note: For some models, it is necessary to remove the cabinet to connect to indoor unit terminal.

• Outdoor Unit

- 1). Remove the access door from the unit by loosening the screw. Connect the wires to the terminals on the control board individually as the following.
- 2). Secure the power connecting cord onto the control board with cable clamp.
- 3). Reinstall the access door to the original position with the screw.
- 4) Use a recognized circuit breaker for 24K model or above between the power source and the unit.

A disconnecting device to adequately disconnected all supply lines must be fitted.

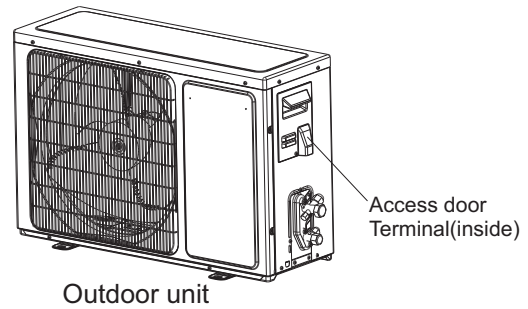
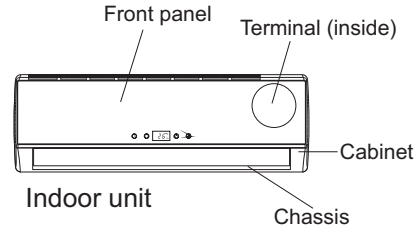

☑ The figures in this manual are based on the external view of a standard model. Consequently, the shape may differ from that of the air conditioner you have selected.

Caution:

1. Never fail to have an individual power circuit specifically for the air conditioner. As for the method of wiring, refer to the circuit diagram posted on the inside of the access door .
2. Confirm that the cable thickness is as specified in the power source specification.
3. Check the wires and make sure that they are all tightly fastened after cable connection.
4. Be sure to install an earth leakage circuit breaker in wet or moist area.

Cable Specifications

| Capacity (Btu/h) | Power cord | | Power connecting cord | | Power connecting cord1 | | Main power supply |
|----------------------------|------------|-------------------------------|-----------------------|--|------------------------|---------------------------------------|-------------------|
| | Type | Normal cross - sectional area | Type | Normal cross - sectional area | Type | Normal cross - sectional area | |
| 5K~12K | H05VV-F | 1.0~1.5mm ² X3 | H07RN-F H05RN-F | 1.5mm ² X3 1.0mm ² X3 | H05RN-F | 0.75mm ² X2 (Heat-pump) | To indoor |
| 14K,15K,18K,22K 24K,30K | H05VV-F | 1.5~2.5mm ² X3 | H07RN-F | 1.5-2.5mm ² X3 | H05RN-F | 0.75mm ² X2 (Heat-pump) | To indoor |
| 18K,24K,30K | H05VV-F | 1.5-2.5mm ² X3 | H07RN-F | 1.5-2.5mm ² X4 | | | To indoor |
| 18K,22K,24K,30K | H07RN-F | 2.5mm ² X3 | H05RN-F H07RN-F | 1.0mm ² X3 1.0mm ² X4Cooling only | H05RN-F | 0.75mm ² X3 (Heat-pump) | To outdoor |
| 28K,30K,36K | H07RN-F | 2.5~4.0mm ² X3 | H07RN-F | 1.0mm ² X4 | | | To outdoor |

The cord may be different from the list above. It may be used as the next list. And it can be larger.

0-7A, use 0.75mm² or 18AWG. 0-10A, use 1mm² or 16AWG. 0-16A, use 1.5mm² or 14AWG.

0-20A, use 2.5mm² or 14AWG. 0-25A, use 2.5mm² or 12AWG. 0-32A, use 4mm² or 12AWG.

Installation instructions

Wiring Diagram

Make sure that the color of wires of the outdoor unit and the terminal No. are the same as those of the indoor unit.

- 5K,7K,8K,9K,10K,12K,14K,15K,18K,22K,24K,30K Model

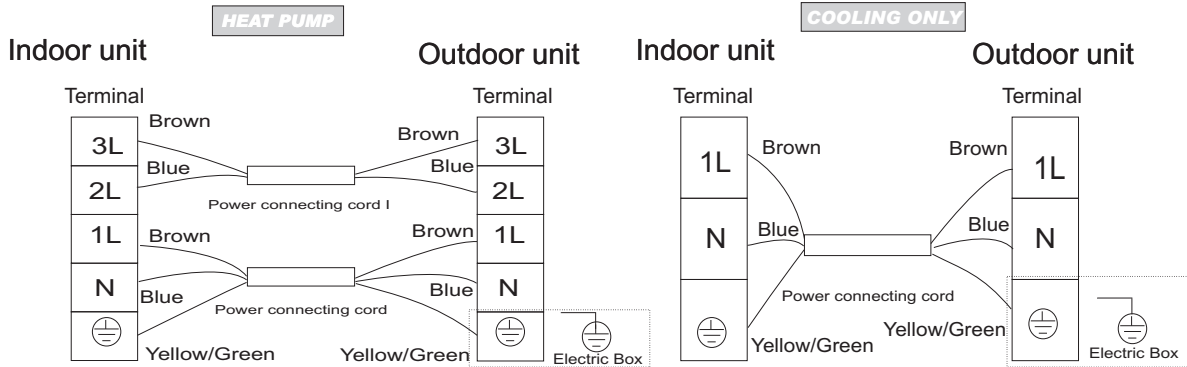

For above models, the power supply are connected from indoor unit.

For some models, the ground wire may be connected to the electric box directly.

For some models, the indicators '1L 2L 3L' may be '4 5 6' or others. And the wires may be different color.

- 18K,22K,24K,30K Model

For these models, the power supply are connected from outdoor unit, with a circuit breaker.

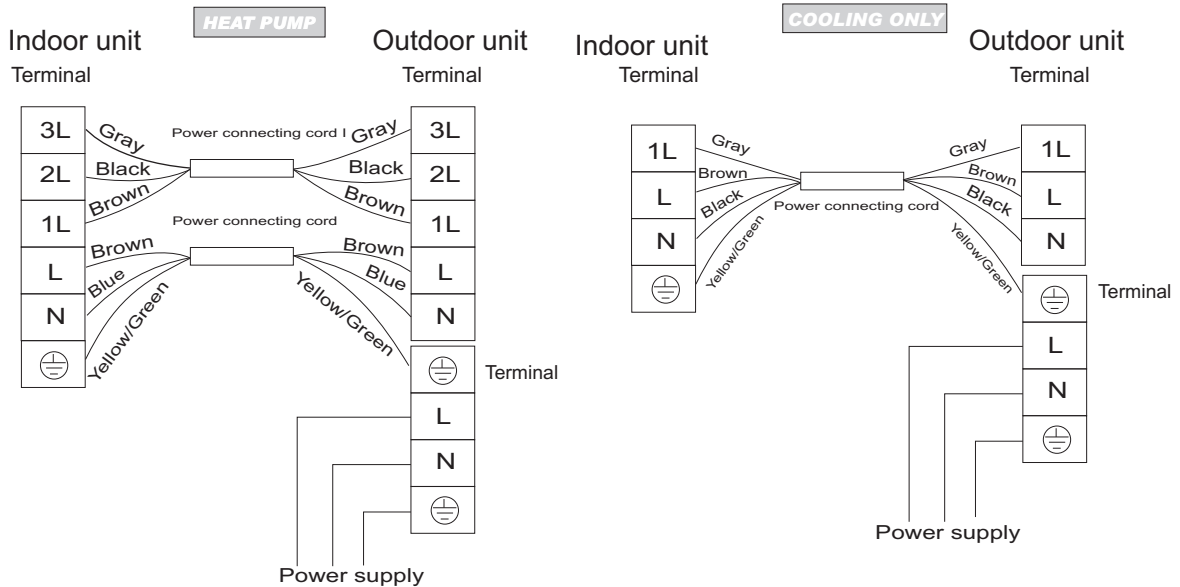

Installation instructions

- **18K,24K,30K Model**

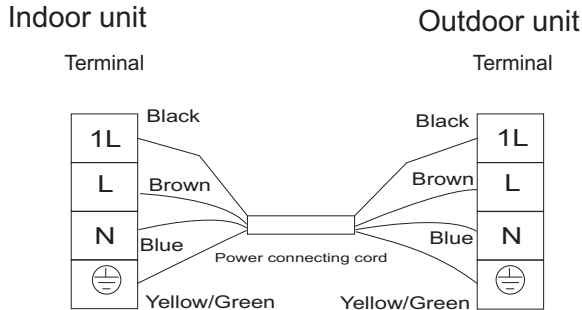

For these models, the power supply are connected from indoor unit.

- **28K.30K.36K Model**

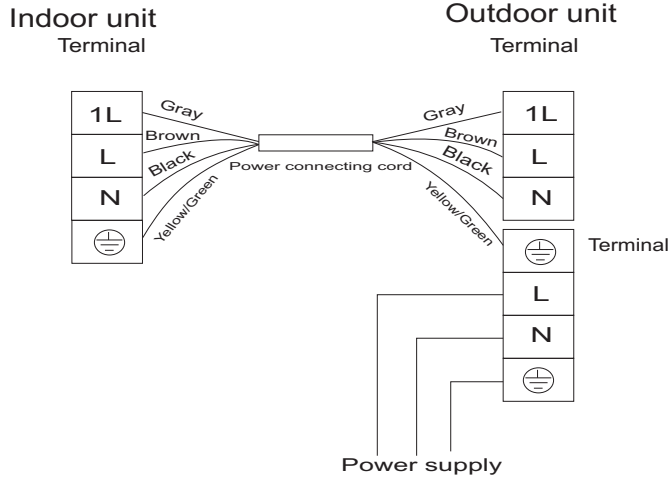

For these models, the power supply are connected from outdoor unit, with a circuit breaker.

- Defrost Cable (for heat-pump air conditioner only ,and it`s an optional part)

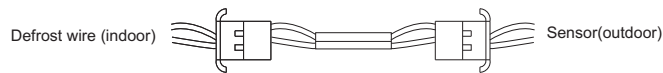

After connection, the defrost wire should be well wrapped with a wrapping tape and the connector should be put inside the unit.

- Overheat Protection or high pressure protection cable (it`s an optional part)

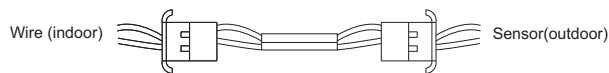

After connection, the wire should be well wrapped with a wrapping tape and the connector should be put inside the unit.

- Ionizer (The ionizer is an optional part)

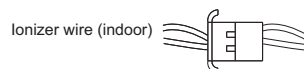

After connection, the ionizer will work automatically .

Installation instructions

Outdoor unit installation

1. Install Drain Port and Drain Hose (for heat-pump model only)

The condensate drains from the outdoor unit when the unit operates in heating mode. In order not to disturb your neighbor and protect the environment, install a drain port and a drain hose to direct the condensate water. Just install the drain port and rubber washer to the chassis of the outdoor unit, then connect a drain hose to the port as the right figure shown.

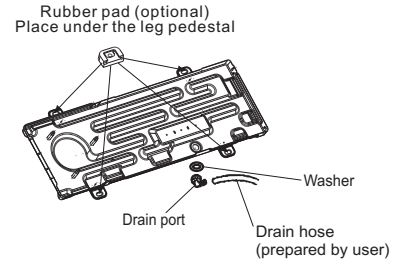

2. Install and Fix Outdoor Unit

Fix with bolts and nuts tightly on a flat and strong floor. If installed on the wall or roof, make sure to fix the supporter well to prevent it from shaking due to serious vibration or strong wind.

3. Outdoor Unit Piping Connection

- Remove the valve caps from the 2-way and 3-way valve.
- Connect the pipes to the 2-way and 3-way valves separately according to the required torque.

4. Outdoor Unit Cable Connection (see previous page)

Air purging

The air which contains moisture remaining in the refrigeration cycle may cause a malfunction on the compressor. After connecting the indoor and outdoor units, evacuate air and moisture from refrigerant cycle using a vacuum pump, as shown below.

Note: To protect the environment, be sure not to discharge the refrigerant to the air directly. See next page for air purging steps.

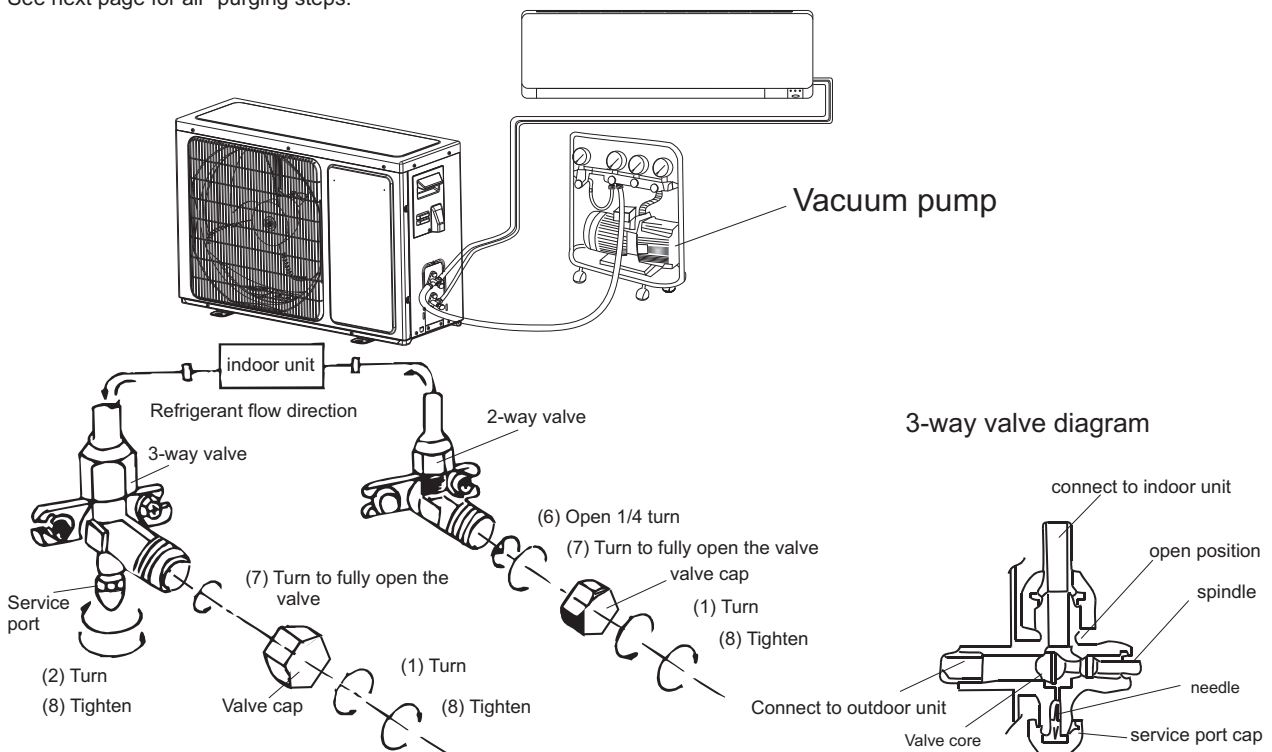

Installation instructions

How to Purge Air Tubes:

- (1). Unscrew and remove caps from 2 and 3-way valves.
- (2). Unscrew and remove cap from service valve.
- (3). Connect vacuum pump flexible hose to the service valve.
- (4). Start vacuum pump for 10-15 minutes until reaching a vacuum of 10 mm Hg absolutes.
- (5). With vacuum pump still running close the low pressure knob on vacuum pump manifold. Then stop vacuum pump.
- (6). Open 2-way valve 1/4 turn then close it after 10 seconds. Check tightness of all joints using liquid soap or an electronic leak detector.
- (7). Turn 2 and 3-way valves stem to fully the valves. Disconnect vacuum pump flexible hose.
- (8). Replace and tighten all valve caps.

