



# Video Conference Camera

## User Manual

### User Manual

Thank you for purchasing our product. If there are any questions, or requests, do not hesitate to contact the dealer.

This manual may contain several technical mistakes or printing errors, and the content is subject to change without notice. The updates will be added to the new version of this manual. We will readily improve or update the products or procedures described in the manual.

01000020221201

©2022 Hangzhou Hikvision Digital Technology Co., Ltd.  
All rights reserved.

## About this Manual

The Manual includes instructions for using and managing the Product. Pictures, charts, images and all other information hereinafter are for description and explanation only. The information contained in the Manual is subject to change, without notice, due to firmware updates or other reasons. Please find the latest version of this Manual at the Hikvision website (<https://www.hikvision.com/>).

Please use this Manual with the guidance and assistance of professionals trained in supporting the Product.

## Trademarks

**HIKVISION** and other Hikvision's trademarks and logos are the properties of Hikvision in various jurisdictions.

Other trademarks and logos mentioned are the properties of their respective owners.

## Disclaimer

TO THE MAXIMUM EXTENT PERMITTED BY APPLICABLE LAW, THIS MANUAL AND THE PRODUCT DESCRIBED, WITH ITS HARDWARE, SOFTWARE AND FIRMWARE, ARE PROVIDED "AS IS" AND "WITH ALL FAULTS AND ERRORS". HIKVISION MAKES NO WARRANTIES, EXPRESS OR IMPLIED, INCLUDING WITHOUT LIMITATION, MERCHANTABILITY, SATISFACTORY QUALITY, OR FITNESS FOR A PARTICULAR PURPOSE. THE USE OF THE PRODUCT BY YOU IS AT YOUR OWN RISK. IN NO EVENT WILL HIKVISION BE LIABLE TO YOU FOR ANY SPECIAL, CONSEQUENTIAL, INCIDENTAL, OR INDIRECT DAMAGES, INCLUDING, AMONG OTHERS, DAMAGES FOR LOSS OF BUSINESS PROFITS, BUSINESS INTERRUPTION, OR LOSS OF DATA, CORRUPTION OF SYSTEMS, OR LOSS OF DOCUMENTATION, WHETHER BASED ON BREACH OF CONTRACT, TORT (INCLUDING NEGLIGENCE), PRODUCT LIABILITY, OR OTHERWISE, IN CONNECTION WITH THE USE OF THE PRODUCT, EVEN IF HIKVISION HAS BEEN ADVISED OF THE POSSIBILITY OF SUCH DAMAGES OR LOSS.

YOU ACKNOWLEDGE THAT THE NATURE OF THE INTERNET PROVIDES FOR INHERENT SECURITY RISKS, AND HIKVISION SHALL NOT TAKE ANY RESPONSIBILITIES FOR ABNORMAL OPERATION, PRIVACY LEAKAGE OR OTHER DAMAGES RESULTING FROM CYBER-ATTACK, HACKER ATTACK, VIRUS INFECTION, OR OTHER INTERNET SECURITY RISKS; HOWEVER, HIKVISION WILL PROVIDE TIMELY TECHNICAL SUPPORT IF REQUIRED.

YOU AGREE TO USE THIS PRODUCT IN COMPLIANCE WITH ALL APPLICABLE LAWS, AND YOU ARE SOLELY RESPONSIBLE FOR ENSURING THAT YOUR USE CONFORMS TO THE APPLICABLE LAW. ESPECIALLY, YOU ARE RESPONSIBLE, FOR USING THIS PRODUCT IN A MANNER THAT DOES NOT INFRINGE ON THE RIGHTS OF THIRD PARTIES, INCLUDING WITHOUT LIMITATION, RIGHTS OF PUBLICITY, INTELLECTUAL PROPERTY RIGHTS, OR DATA PROTECTION AND OTHER PRIVACY RIGHTS. YOU SHALL NOT USE THIS PRODUCT FOR ANY PROHIBITED END-USES, INCLUDING THE DEVELOPMENT OR PRODUCTION OF WEAPONS OF MASS DESTRUCTION, THE DEVELOPMENT OR PRODUCTION OF CHEMICAL OR BIOLOGICAL WEAPONS, ANY ACTIVITIES IN THE CONTEXT RELATED TO ANY NUCLEAR EXPLOSIVE OR UNSAFE NUCLEAR FUEL-CYCLE, OR IN SUPPORT OF HUMAN RIGHTS ABUSES.

IN THE EVENT OF ANY CONFLICTS BETWEEN THIS MANUAL AND THE APPLICABLE LAW, THE LATTER PREVAILS.

## Regulatory Information

### FCC Information

Please take attention that changes or modification not expressly approved by the party responsible for compliance could void the user's authority to operate the equipment.

#### FCC compliance

This product has been tested and found to comply with the limits for a Class B digital device, pursuant to Part 15 of the FCC Rules. These limits are designed to provide reasonable protection against harmful interference in a residential installation.

This product generates, uses, and can radiate radio frequency energy and, if not installed and used in accordance with the instructions, may cause harmful interference to radio communications. However, there is no guarantee that interference will not occur in a particular installation. If this product does cause harmful interference to radio or television reception, which can be determined by turning the equipment off and on, the user is encouraged to try to correct the interference by one or more of the following measures:

- Reorient or relocate the receiving antenna.
- Increase the separation between the equipment and receiver.
- Connect the equipment into an outlet on a circuit different from that to which the receiver is connected.
- Consult the dealer or an experienced radio/TV technician for help.

#### FCC Conditions

This device complies with part 15 of the FCC Rules. Operation is subject to the following two conditions:

1. This device may not cause harmful interference.
2. This device must accept any interference received, including interference that may cause undesired operation.

#### EU Conformity Statement



This product and - if applicable - the supplied accessories too are marked with "CE" and comply therefore with the applicable harmonized European standards listed under the Low Voltage Directive 2014/35/EU, the EMC Directive 2014/30/EU, the RoHS Directive 2011/65/EU.



2012/19/EU (WEEE directive): Products marked with this symbol cannot be disposed of as unsorted municipal waste in the European Union. For proper recycling, return this product to your local supplier upon the purchase of equivalent new equipment, or dispose of it at designated collection points. For more information see: [www.recyclethis.info](http://www.recyclethis.info).



2006/66/EC (battery directive): This product contains a battery that cannot be disposed of as unsorted municipal waste in the European Union. See the product documentation for specific battery information. The battery is marked with this symbol, which may include lettering to indicate cadmium (Cd), lead (Pb), or mercury (Hg). For proper recycling, return the battery to

your supplier or to a designated collection point. For more information, see: [www.recyclethis.info](http://www.recyclethis.info).

### **Industry Canada ICES-003 Compliance**

This device meets the CAN ICES-3 (A)/NMB-3(A) standards requirements.

This device complies with Industry Canada licence-exempt RSS standard(s). Operation is subject to the following two conditions:

1. this device may not cause interference, and
2. this device must accept any interference, including interference that may cause undesired operation of the device.

Le présent appareil est conforme aux CNR d'Industrie Canada applicables aux appareils radioexempts de licence. L'exploitation est autorisée aux deux conditions suivantes:

1. l'appareil ne doit pas produire de brouillage, et
2. l'utilisateur de l'appareil doit accepter tout brouillage radioélectrique subi, même si le brouillage est susceptible d'en compromettre le fonctionnement.

### **Warning**

This is a class A product. In a domestic environment this product may cause radio interference in which case the user may be required to take adequate measures.

### **Safety Instructions**

#### **Warnings**

#### **Laws and Regulations**

The device should be used in compliance with local laws, electrical safety regulations, and fire prevention regulations.

#### **Electrical Safety**

The socket-outlet shall be installed near the equipment and shall be easily accessible.

#### **Battery**

**CAUTION:** Risk of explosion if the battery is replaced by an incorrect type.

Improper replacement of the battery with an incorrect type may defeat a safeguard (for example, in the case of some lithium battery types).

Do not dispose of the battery into fire or a hot oven, or mechanically crush or cut the battery, which may result in an explosion.

Do not leave the battery in an extremely high temperature surrounding environment, which may result in an explosion or the leakage of flammable liquid or gas.

Do not subject the battery to extremely low air pressure, which may result in an explosion or the leakage of flammable liquid or gas.

Dispose of used batteries according to the instructions.

#### **Cautions**

#### **Fire Prevention**

No naked flame sources, such as lighted candles, should be placed on the equipment.

#### **Installation**

Install the equipment according to the instructions in this manual.

Never place the equipment in an unstable location. The equipment may fall, causing serious personal injury or death.

DO NOT touch the sharp edges or corners.

#### **Transportation**

Keep the device in original or similar packaging while transporting it.

DO NOT drop the product or subject it to physical shock.

### **Power Supply**

Refer to the device label for the standard power supply. Please make sure your power supply matches with your device.

Use a power adapter provided by qualified manufacturers. It is recommended to provide an independent power adapter for each device as adapter overload may cause over-heating or a fire hazard.

### **Maintenance**

If the product does not work properly, please contact your dealer or the nearest service center. We shall not assume any responsibility for problems caused by unauthorized repair or maintenance.

### **Cleaning**

Please use a soft and dry cloth to clean the interior and exterior surfaces. Do not use alkaline detergents.

### **Using Environment**

When any laser equipment is in use, make sure that the device lens is not exposed to the laser beam, or it may burn out.

DO NOT aim the lens at the sun or any other bright light. To avoid heat accumulation, good ventilation is required for a proper operating environment.

DO NOT expose the device to extremely hot, cold, dusty, corrosive, saline-alkali, or damp environments. For temperature and humidity requirements, see device specification.

DO NOT expose the device to high electromagnetic radiation.

### **Emergency**

If smoke, odor, or noise arises from the device, immediately turn off the power, unplug the power cable, and contact the service center.

To achieve a better product experience, please visit <https://www.hikvision.com/sg/support/download/software/hikin/> to download the HIK IN installation package.



## 1 Introduction

### 1.1 Product Features









The main features are as follows:

- High performance CMOS sensor
- Varifocal lens
- Clear imaging against strong back light due to WDR technology
- AGC for self-adjust brightness
- Support remote control
- Built-in microphone with clear sound

### 1.2 Packing List

Check the package contents and make sure that the device in the package is in good condition and all the assembly parts are included.

Table 1-1 Packing List

No.	Item	Description	Amount
1		Camera	1
2		Remote Control	1
3		Battery	2
3		Bracket	1
4		Quick Start Guide	1
5		Screws	1
6		Power Adapter	1
7		Cable	1

**Note:**

The figure of power adapter is for reference only. Refer to the actual product as standard.

## 1.3 Overview

### 1.3.1 Appearance

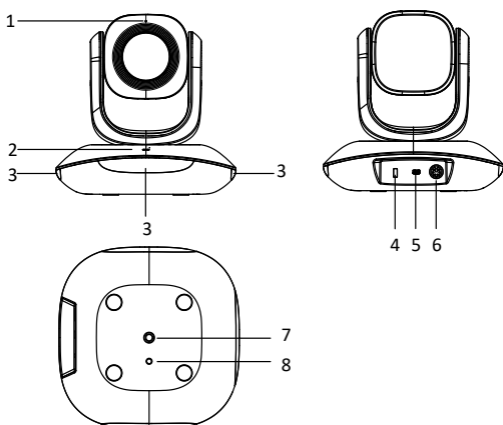

Figure 1-1 Appearance of Video Conference Camera

Table 1-2 Description

No.	Description	No.	Description
1	Microphone	5	Audio In
2	Indicator	6	PS2 Interface
3	IR Signal Receiving Module	7	1/4-20UNC Screw Hole
4	Kensington Lock	8	Lashing Eye

#### **Note:**

When the indicator turns to red, it means the device is standby. When the indicator turns to blue, it means the device is working normally.

### 1.3.2 Remote Control

You can control the camera through the remote control.

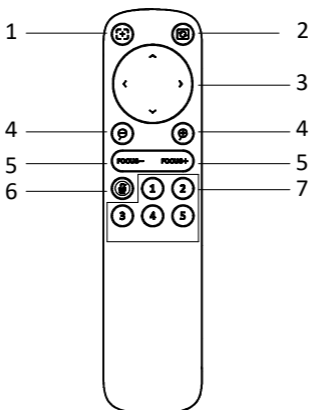

Figure 1-2 Appearance of Remote Control

Table 1-3 Description

No.	Description	No.	Description
1	One-touch Focus	5	Manual Focus
2	One-touch Flip	6	Mute
3	Pan/Tilt Control	7	Presets
4	Zoom in/out		

- One-touch Focus: It enables the device to focus automatically.
- One-touch Flip: It enables to rotate the image 180° when the device is installed upside down.
- Pan/Tilt Control: It enables to adjust the lens direction.
- Manual Focus: It enables the device to focus manually.
- Mute: Turn off the microphone.
- Preset: A preset is a predefined position. For the defined preset, you can press the preset number to quickly view the desired image position.
  1. Adjust the image by remote control.
  2. Press and hold a preset number for 3 seconds, and the indicator flashes blue light twice. It means the preset is successfully set.
  3. Press the preset number, and the device return to the defined position. Up to 5 presets can be set.
- Restore to the default settings: Press and hold One-touch Flip and Mute at the same time for 5 seconds, and the red indicator flashes three times.

### 1.3.3 Device Connection

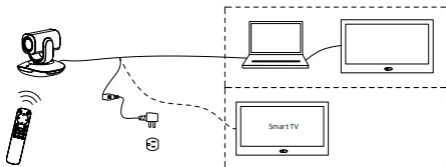

Figure 1-3 Connection



## 2 Installation

The package contains the mount. Table mounting and wall mounting share the same mount.

The installation methods are not compulsory. You can just put the camera on the table, if this way meets your needs.

### 2.1 Table Mounting

#### Steps:

1. Align the screw hole in camera with that on the mount.
2. Use the supplied screw to secure the camera on the mount.

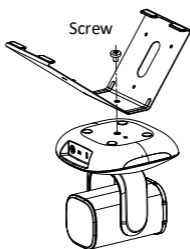

Figure 2-1 Fix the Camera on the Mount

3. Take the lens cover out of the camera to finish the installation

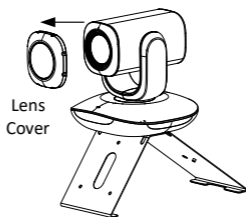

Figure 2-2 Put the Lens Back

4. Power on the camera and connect the camera with the computer.
5. Check whether the image on the screen is gotten from the optimum angle. If not, adjust the view angle by remote control shown as the figure below.

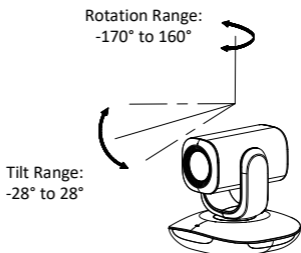

Figure 2-3 Angle Adjustment

- 1) Press right/left direction button on the remote control to adjust the pan range from  $-170^{\circ}$  to  $160^{\circ}$ .
- 2) Press up/down direction button on the remote control to adjust the tilt range from  $-28^{\circ}$  to  $28^{\circ}$ .

## 2.2 Wall Mounting

### Steps:

1. Drill three screw holes in the wall according to the holes of the mount.
2. Align the screw holes on the mount with that on the wall, and secure the mount with supplied screws.

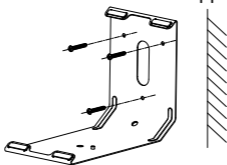

Figure 2-4 Fix the Mount in the Wall

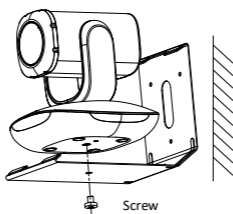

Figure 2-5 Secure the Camera with the Mount

Repeat steps 3 to 5 of section 2.1 Table Mounting to finish the installation.

## 2.3 Pendant Mounting

The device also supports pendant mounting, and the mount should be purchased separately.

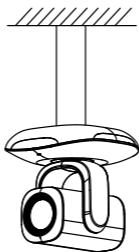

Figure 2-6 Pendant Mounting

## 3 FAQ

---

For frequently asked questions of the device, visit <http://enpinfodata.hikvision.com/analysisQR/showQR/35d08787>

Note that some frequently asked questions only apply to certain models.