



**Anwendungshinweis  
Schlagschrauber,  
extra kurz**



**Application Note  
Impact Wrench,  
extra short**

**Notice d'utilisation  
Clé à chocs,  
extra-courte**

**Toepassingsaanwijzing  
Slagmoersleutel,  
extra kort**















**9012 M-1**



	<i>de</i>	<i>en</i>	<i>fr</i>	<i>nl</i>
	Ultra kompakte Bauweise optimiert für Arbeiten in beengten Räumen	<i>Ultra-compact design optimised for work in tight spaces</i>	<i>Exécution ultra-compacte optimisée aux travaux dans les endroits étroits</i>	Ultra-compacte uitvoering geoptimaliseerd voor werken in kleine ruimten
	Beachten Sie unbedingt die beiliegenden Sicherheitsvorschriften für HAZET-Pneumatikwerkzeuge!	<i>Please observe the enclosed safety instructions for the HAZET pneumatic tools!</i>	<i>Veillez respecter impérativement les consignes de sécurité pour les outils pneumatiques de HAZET !</i>	Neem per se de bijgevoegde veiligheidsvoorschriften in acht voor pneumatische gereedschappen van HAZET!
	Empf. Drehmoment	<i>Recommended torque</i>	<i>Couple recommandé</i>	Aanbevolen moment
	Max. Drehmoment	<i>Max. torque</i>	<i>Couple max.</i>	Maximaal moment
	Max. Lösemoment	<i>Max. loosening torque</i>	<i>Couple de desserrage max.</i>	Maximaal los moment
	Max. Drehzahl/min.	<i>Max. revolutions per minute</i>	<i>Vitesse à vide max. / min.</i>	TPM max.
	Luftbedarf	<i>Air consumption</i>	<i>Consommation d'air</i>	Lucht-verbruik
	Betriebsdruck	<i>Working pressure</i>	<i>Pression de service</i>	Werkdruk
	Pneumatischer Schlagschrauber, Kupplungsstecker Nennweite 7,2 * mit Aufkängehaken	<i>Pneumatic Impact Wrench, Coupler plug, nominal size 7.2 * with suspension hook</i>	<i>Clé à chocs pneumatique, Raccord de taille nominale 7.2 * avec crochet de suspension</i>	Pneumatische slagschroevendraaier, verbindingsstekker, nominale breedte 7,2 * Hook

Technische Daten / Technical data / Informations techniques / Technische gegevens:

		M16
	m/s <sup>2</sup>	13.49
	dB(A)	Lp W 103,2 Lp A 92.2
	bar	6.3
	l/min.	127,4
	Ø mm	10
	kg	1.27
	1/min	8800
	Nm	1200
	Nm	678
	Nm	610
	Ø mm	12,91 <sup>(1/2)</sup> 7,2
	mm	12 <sup>5</sup> 1/2
<b>HAZET</b> No.		
	<b>9012</b> <b>M-1</b>	

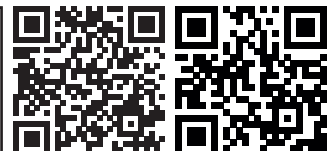
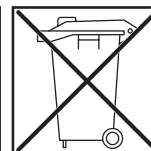
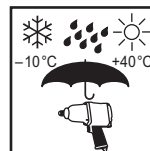
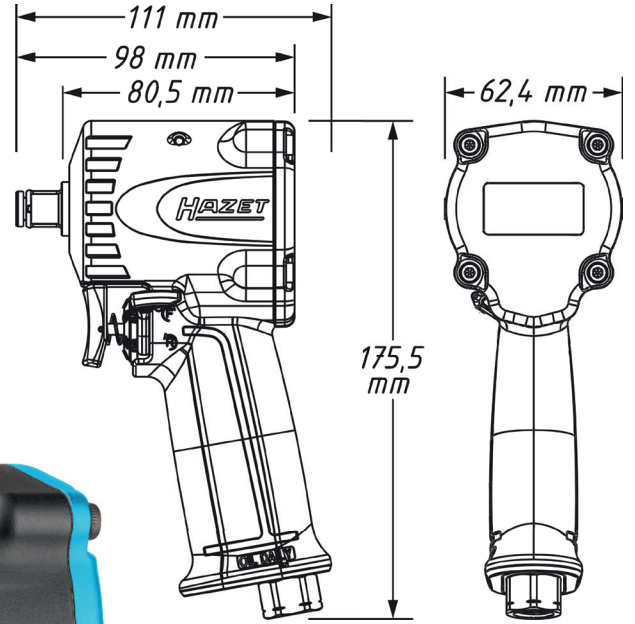

HAZET-WERK Hermann Zerver GmbH & Co. KG •  Güldenwerther Bahnhofstrasse 25-29 • 42857 REMSCHEID

✉ 10 04 61 • 42804 REMSCHEID • GERMANY • ☎ +49 (0) 21 91 / 7 92-0

[FAX] +49 (0) 21 91 / 7 92-375 (Deutschland) -400 (International) • [www.hazet.de](http://www.hazet.de) • [e-mail info@hazet.de](mailto:info@hazet.de)