

# Z690 UD AC Z690 UD AX Z690 UD Z690 UD AX DDR4 Z690 UD DDR4

## User's Manual

Rev. 1001

12ME-Z69UDX4-1001R

Z690 UD AC



Z690 UD AX



Z690 UD



Z690 UD AX DDR4



Z690 UD DDR4



For more product details, please visit GIGABYTE's website.



To reduce the impacts on global warming, the packaging materials of this product are recyclable and reusable. GIGABYTE works with you to protect the environment.

## **Copyright**

© 2021 GIGA-BYTE TECHNOLOGY CO., LTD. All rights reserved.

The trademarks mentioned in this manual are legally registered to their respective owners.

## **Disclaimer**

Information in this manual is protected by copyright laws and is the property of GIGABYTE. Changes to the specifications and features in this manual may be made by GIGABYTE without prior notice. No part of this manual may be reproduced, copied, translated, transmitted, or published in any form or by any means without GIGABYTE's prior written permission.

- In order to assist in the use of this product, carefully read the User's Manual.
- For product-related information, check on our website at: <https://www.gigabyte.com>

## **Identifying Your Motherboard Revision**

The revision number on your motherboard looks like this: "REV: X.X." For example, "REV: 1.0" means the revision of the motherboard is 1.0. Check your motherboard revision before updating motherboard BIOS, drivers, or when looking for technical information.

Example:

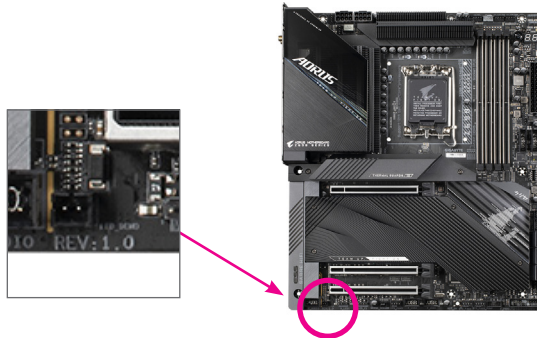

# Table of Contents

Chapter 1 Product Introduction .....	4
1-1 Motherboard Layout .....	4
1-2 Box Contents .....	6
Chapter 2 Hardware Installation .....	7
2-1 Installation Precautions .....	7
2-2 Product Specifications .....	8
2-3 Installing the CPU and CPU Cooler .....	12
2-4 Installing the Memory .....	15
2-5 Installing an Expansion Card .....	16
2-6 Back Panel Connectors .....	17
2-7 Internal Connectors .....	19
Chapter 3 BIOS Setup .....	33
Chapter 4 Installing the Operating System and Drivers .....	35
4-1 Operating System Installation .....	35
4-2 Drivers Installation .....	36
Chapter 5 Appendix .....	37
5-1 Configuring a RAID Set .....	37
Regulatory Notices .....	38
Contact Us .....	44

# Chapter 1 Product Introduction

## 1-1 Motherboard Layout

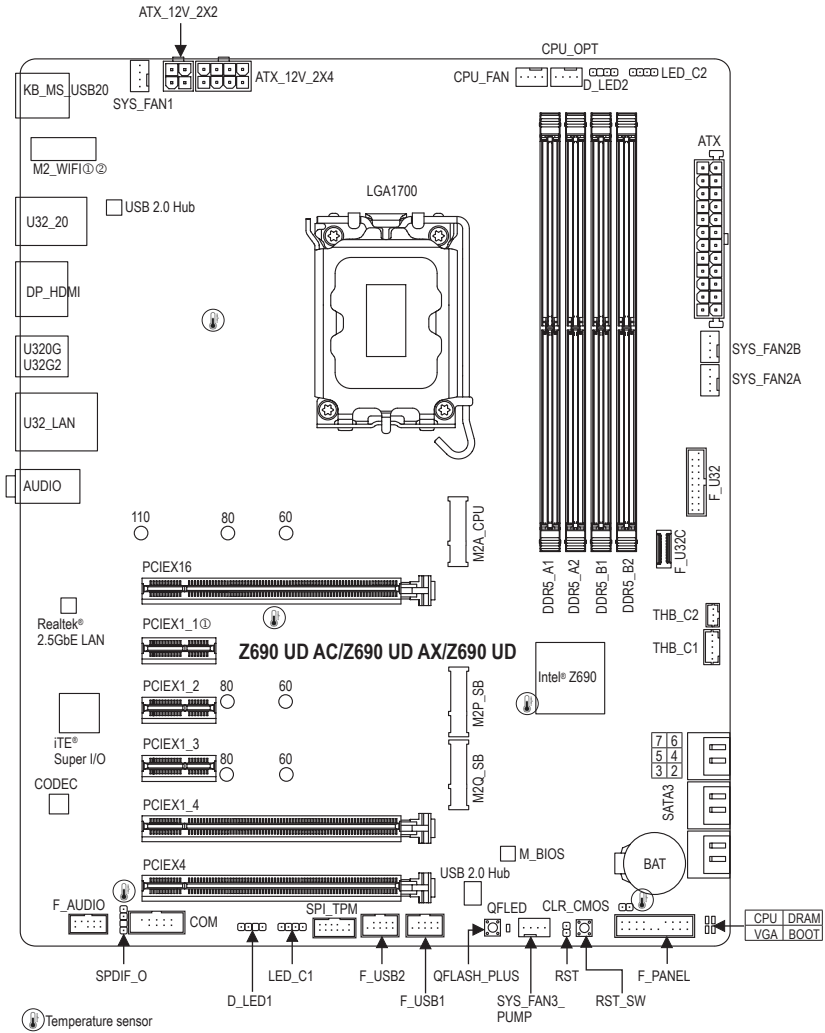

- ① Only for Z690 UD AC.
- ② Only for Z690 UD AX.



## 1-2 Box Contents

- Z690 UD AC, Z690 UD AX, Z690 UD, Z690 UD AX DDR4, or Z690 UD DDR4 motherboard
- User's Manual
- Antenna<sup>①②④</sup>
- Two SATA cables
- M.2 screws

\* The box contents above are for reference only and the actual items shall depend on the product package you obtain. The box contents are subject to change without notice.

- ① Only for Z690 UD AC.
- ② Only for Z690 UD AX.
- ④ Only for Z690 UD AX DDR4.









## Chapter 2 Hardware Installation

### 2-1 Installation Precautions

The motherboard contains numerous delicate electronic circuits and components which can become damaged as a result of electrostatic discharge (ESD). Prior to installation, carefully read the user's manual and follow these procedures:

- Prior to installation, make sure the chassis is suitable for the motherboard.
- Prior to installation, do not remove or break motherboard S/N (Serial Number) sticker or warranty sticker provided by your dealer. These stickers are required for warranty validation.
- Always remove the AC power by unplugging the power cord from the power outlet before installing or removing the motherboard or other hardware components.
- When connecting hardware components to the internal connectors on the motherboard, make sure they are connected tightly and securely.
- When handling the motherboard, avoid touching any metal leads or connectors.
- It is best to wear an electrostatic discharge (ESD) wrist strap when handling electronic components such as a motherboard, CPU or memory. If you do not have an ESD wrist strap, keep your hands dry and first touch a metal object to eliminate static electricity.
- Prior to installing the motherboard, please have it on top of an antistatic pad or within an electrostatic shielding container.
- Before connecting or unplugging the power supply cable from the motherboard, make sure the power supply has been turned off.
- Before turning on the power, make sure the power supply voltage has been set according to the local voltage standard.
- Before using the product, please verify that all cables and power connectors of your hardware components are connected.
- To prevent damage to the motherboard, do not allow screws to come in contact with the motherboard circuit or its components.
- Make sure there are no leftover screws or metal components placed on the motherboard or within the computer casing.
- Do not place the computer system on an uneven surface.
- Do not place the computer system in a high-temperature or wet environment.
- Turning on the computer power during the installation process can lead to damage to system components as well as physical harm to the user.
- If you are uncertain about any installation steps or have a problem related to the use of the product, please consult a certified computer technician.
- If you use an adapter, extension power cable, or power strip, ensure to consult with its installation and/or grounding instructions.

## 2-2 Product Specifications

	CPU	<ul style="list-style-type: none"> <li>◆ LGA1700 socket: Support for 12th Generation Intel® Core™ i9 processors/Intel® Core™ i7 processors/Intel® Core™ i5 processors (Go to GIGABYTE's website for the latest CPU support list.)</li> <li>◆ L3 cache varies with CPU</li> </ul>
	Chipset	<ul style="list-style-type: none"> <li>◆ Intel® Z690 Express Chipset</li> </ul>
	Memory	<ul style="list-style-type: none"> <li>◆ Support for DDR5 4800/4000 MHz memory modules①②③</li> <li>◆ Support for DDR4 3200/3000/2933/2666/2400/2133 MHz memory modules④⑤</li> <li>◆ 4 x DDR DIMM sockets supporting up to 128 GB (32 GB single DIMM capacity) of system memory</li> <li>◆ Dual channel memory architecture</li> <li>◆ Support for ECC Un-buffered DIMM 1Rx8/2Rx8 memory modules (operate in non-ECC mode)</li> <li>◆ Support for non-ECC Un-buffered DIMM 1Rx8/2Rx8/1Rx16 memory modules</li> <li>◆ Support for Extreme Memory Profile (XMP) memory modules (Go to GIGABYTE's website for the latest supported memory speeds and memory modules.)</li> </ul>
	Onboard Graphics	<ul style="list-style-type: none"> <li>◆ Integrated Graphics Processor-Intel® HD Graphics support: <ul style="list-style-type: none"> <li>- 1 x HDMI port, supporting a maximum resolution of 4096x2160@60 Hz * Support for HDMI 2.0 version and HDCP 2.3.</li> <li>- 1 x DisplayPort, supporting a maximum resolution of 4096x2304@60 Hz * Support for DisplayPort 1.2 version and HDCP 2.3</li> </ul> </li> </ul> <p>(Graphics specifications may vary depending on CPU support.)</p>
	Audio	<ul style="list-style-type: none"> <li>◆ Realtek® Audio CODEC</li> <li>◆ High Definition Audio</li> <li>◆ 2/4/5.1/7.1-channel <ul style="list-style-type: none"> <li>* To configure 7.1-channel audio, you need to open the audio software and select Device advanced settings &gt; Playback Device to change the default setting first. Please visit GIGABYTE's website for details on configuring the audio software.</li> </ul> </li> <li>◆ Support for S/PDIF Out</li> </ul>
	LAN	<ul style="list-style-type: none"> <li>◆ Realtek® 2.5GbE LAN chip (2.5 Gbps/1 Gbps/100 Mbps)</li> </ul>
	Wireless Communication Module①	<ul style="list-style-type: none"> <li>◆ Intel® Wi-Fi AC 9560 <ul style="list-style-type: none"> <li>- WIFI a, b, g, n, ac, supporting 2.4/5 GHz Dual-Band</li> <li>- BLUETOOTH 5.1</li> <li>- Support for 11ac 160MHz wireless standard and up to 1.73 Mbps data rate. * Actual data rate may vary depending on environment and equipment.</li> </ul> </li> </ul>
	Wireless Communication Module②④	<ul style="list-style-type: none"> <li>◆ Intel® Wi-Fi 6 AX201 <ul style="list-style-type: none"> <li>- WIFI a, b, g, n, ac, ax, supporting 2.4/5/6 GHz carrier frequency bands</li> <li>- BLUETOOTH 5.2</li> <li>- Support for 11ax 160MHz wireless standard and up to 2.4 Gbps data rate * Actual data rate may vary depending on environment and equipment.</li> </ul> </li> </ul>

① Only for Z690 UD AC.

② Only for Z690 UD AX.

③ Only for Z690 UD.

④ Only for Z690 UD AX DDR4.

⑤ Only for Z690 UD DDR4.



	<p><b>Expansion Slots</b></p> <ul style="list-style-type: none"> <li>◆ 1 x PCI Express x16 slot, running at x16 (PCIEX16) <ul style="list-style-type: none"> <li>* For optimum performance, if only one PCI Express graphics card is to be installed, be sure to install it in the PCIEX16 slot.</li> </ul> </li> <li>(The PCIEX16 slot conforms to PCI Express 5.0 standard.)</li> <li>◆ 1 x PCI Express x16 slot, running at x4 (PCIEX4)</li> <li>◆ 1 x PCI Express x16 slot, running at x1 (PCIEX1_4)</li> <li>◆ 3 x PCI Express x1 slots①</li> <li>◆ 2 x PCI Express x1 slots②③④⑤</li> <li>(The PCIEX4 and PCIEX1 slots conform to PCI Express 3.0 standard.)</li> </ul>
	<p><b>Multi-Graphics Technology</b></p> <ul style="list-style-type: none"> <li>◆ Support for AMD Quad-GPU CrossFire™ and 2-Way AMD CrossFire™ technologies</li> </ul>
	<p><b>Storage Interface</b></p> <ul style="list-style-type: none"> <li>◆ CPU: <ul style="list-style-type: none"> <li>- 1 x M.2 connector (Socket 3, M key, type 2260/2280/22110 PCIe 4.0 x4/x2 SSD support) (M2A_CPU)</li> </ul> </li> <li>◆ Chipset: <ul style="list-style-type: none"> <li>- 1 x M.2 connector (Socket 3, M key, type 2260/2280 PCIe 4.0 x4/x2 SSD support) (M2P_SB)</li> <li>- 1 x M.2 connector (Socket 3, M key, type 2260/2280 PCIe 4.0 x4/x2 SSD support) (M2Q_SB)</li> <li>- 6 x SATA 6Gb/s connectors</li> </ul> </li> <li>◆ Support for RAID 0, RAID 1, RAID 5, and RAID 10</li> <li>◆ Intel® Optane™ Memory Ready <ul style="list-style-type: none"> <li>* System acceleration with Intel® Optane™ Memory can only be enabled on the M.2 connectors supported by the Chipset.</li> </ul> </li> </ul>
	<p><b>USB</b></p> <ul style="list-style-type: none"> <li>◆ Chipset: <ul style="list-style-type: none"> <li>- 1 x USB Type-C® port on the back panel, with USB 3.2 Gen 2x2 support</li> <li>- 1 x USB Type-C® port with USB 3.2 Gen 1 support, available through the internal USB header</li> <li>- 1 x USB 3.2 Gen 2 Type-A ports (red) on the back panel</li> <li>- 6 x USB 3.2 Gen 1 ports (4 ports on the back panel, 2 ports available through the internal USB header)</li> </ul> </li> <li>◆ Chipset+2 USB 2.0 Hubs: <ul style="list-style-type: none"> <li>- 8 x USB 2.0/1.1 ports (4 ports on the back panel, 4 ports available through the internal USB headers)</li> </ul> </li> </ul>
	<p><b>Internal Connectors</b></p> <ul style="list-style-type: none"> <li>◆ 1 x 24-pin ATX main power connector</li> <li>◆ 1 x 8-pin ATX 12V power connector</li> <li>◆ 1 x 4-pin ATX 12V power connector</li> <li>◆ 1 x CPU fan header</li> <li>◆ 1 x water cooling CPU fan header</li> <li>◆ 3 x system fan headers</li> <li>◆ 1 x system fan/water cooling pump header</li> </ul>

① Only for Z690 UD AC.

② Only for Z690 UD AX.

③ Only for Z690 UD.

④ Only for Z690 UD AX DDR4.

⑤ Only for Z690 UD DDR4.

	Internal Connectors	<ul style="list-style-type: none"> <li>◆ 2 x addressable LED strip headers</li> <li>◆ 2 x RGB LED strip headers</li> <li>◆ 3 x M.2 Socket 3 connectors</li> <li>◆ 6 x SATA 6Gb/s connectors</li> <li>◆ 1 x front panel header</li> <li>◆ 1 x front panel audio header</li> <li>◆ 1 x S/PDIF Out header</li> <li>◆ 1 x USB Type-C® header, with USB 3.2 Gen 1 support</li> <li>◆ 1 x USB 3.2 Gen 1 header</li> <li>◆ 2 x USB 2.0/1.1 headers</li> <li>◆ 1 x serial port header</li> <li>◆ 2 x Thunderbolt™ add-in card connectors</li> <li>◆ 1 x Trusted Platform Module header (For the GC-TPM2.0 SPI/GC-TPM2.0 SPI 2.0 module only)</li> <li>◆ 1 x reset button</li> <li>◆ 1 x reset jumper</li> <li>◆ 1 x Q-Flash Plus button</li> <li>◆ 1 x Clear CMOS jumper</li> </ul>
	Back Panel Connectors	<ul style="list-style-type: none"> <li>◆ 1 x PS/2 keyboard/mouse port</li> <li>◆ 2 x SMA antenna connectors (2T2R)<sup>①</sup> ② ④</li> <li>◆ 1 x DisplayPort</li> <li>◆ 1 x HDMI port</li> <li>◆ 1 x USB Type-C® port, with USB 3.2 Gen 2x2 support</li> <li>◆ 1 x USB 3.2 Gen 2 Type-A port (red)</li> <li>◆ 4 x USB 3.2 Gen 1 ports</li> <li>◆ 4 x USB 2.0/1.1 ports</li> <li>◆ 1 x RJ-45 port</li> <li>◆ 3 x audio jacks</li> </ul>
	I/O Controller	<ul style="list-style-type: none"> <li>◆ iTE® I/O Controller Chip</li> </ul>
	Hardware Monitor	<ul style="list-style-type: none"> <li>◆ Voltage detection</li> <li>◆ Temperature detection</li> <li>◆ Fan speed detection</li> <li>◆ Water cooling flow rate detection</li> <li>◆ Fan fail warning</li> <li>◆ Fan speed control <ul style="list-style-type: none"> <li>* Whether the fan (pump) speed control function is supported will depend on the fan (pump) you install.</li> </ul> </li> </ul>
	BIOS	<ul style="list-style-type: none"> <li>◆ 1 x 256 Mbit flash</li> <li>◆ Use of licensed AMI UEFI BIOS</li> <li>◆ PnP 1.0a, DMI 2.7, WfM 2.0, SM BIOS 2.7, ACPI 5.0</li> </ul>

① Only for Z690 UD AC.

② Only for Z690 UD AX.

④ Only for Z690 UD AX DDR4.

	Unique Features	<ul style="list-style-type: none"> <li>◆ Support for APP Center <ul style="list-style-type: none"> <li>* Available applications in APP Center may vary by motherboard model. Supported functions of each application may also vary depending on motherboard specifications.</li> <li>- @BIOS</li> <li>- EasyTune</li> <li>- Fast Boot</li> <li>- Game Boost</li> <li>- ON/OFF Charge</li> <li>- RGB Fusion</li> <li>- Smart Backup</li> <li>- System Information Viewer</li> </ul> </li> <li>◆ Support for Q-Flash Plus</li> <li>◆ Support for Q-Flash</li> <li>◆ Support for Xpress Install</li> </ul>
	Bundled Software	<ul style="list-style-type: none"> <li>◆ Norton® Internet Security (OEM version)</li> <li>◆ Realtek® Gaming LAN Bandwidth Control Utility</li> </ul>
	Operating System	<ul style="list-style-type: none"> <li>◆ Support for Windows 10 64-bit</li> </ul>
	Form Factor	<ul style="list-style-type: none"> <li>◆ ATX Form Factor; 30.5cm x 24.4cm</li> </ul>

\* GIGABYTE reserves the right to make any changes to the product specifications and product-related information without prior notice.



Please visit GIGABYTE's website for support lists of CPU, memory modules, SSDs, and M.2 devices.



Please visit the **SupportUtility List** page on GIGABYTE's website to download the latest version of apps.

## 2-3 Installing the CPU and CPU Cooler



Read the following guidelines before you begin to install the CPU:

- Make sure that the motherboard supports the CPU.  
(Go to GIGABYTE's website for the latest CPU support list.)
- Always turn off the computer and unplug the power cord from the power outlet before installing the CPU to prevent hardware damage.
- Locate the pin one of the CPU. The CPU cannot be inserted if oriented incorrectly. (Or you may locate the notches on both sides of the CPU and alignment keys on the CPU socket.)
- Apply an even and thin layer of thermal grease on the surface of the CPU.
- Do not turn on the computer if the CPU cooler is not installed, otherwise overheating and damage of the CPU may occur.
- Set the CPU host frequency in accordance with the CPU specifications. It is not recommended that the system bus frequency be set beyond hardware specifications since it does not meet the standard requirements for the peripherals. If you wish to set the frequency beyond the standard specifications, please do so according to your hardware specifications including the CPU, graphics card, memory, hard drive, etc.

### A. Note the CPU Orientation

Note the alignment keys on the motherboard CPU socket and the notches on the CPU.

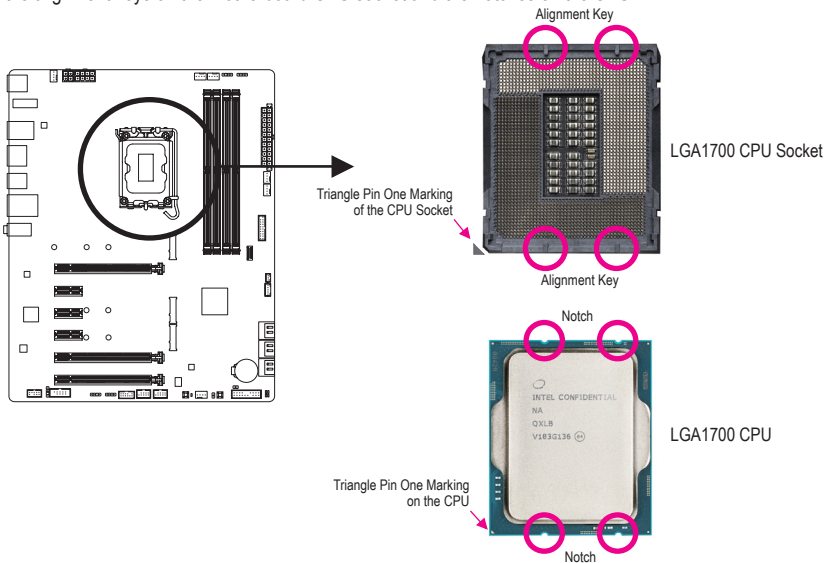

Do not remove the CPU socket cover before inserting the CPU. It may pop off from the load plate automatically after you insert the CPU and close the load plate.



Please visit GIGABYTE's website for details on hardware installation.

## B. Installing the CPU

Follow the steps below to correctly install the CPU into the motherboard CPU socket.

1

- 1 Gently press the CPU socket lever handle down and away from the socket.
- 2 Completely lift up the CPU socket locking lever.
- 3 Use the finger tab on the side of the metal load plate to lift open the metal load plate with the plastic protective cover attached to it.

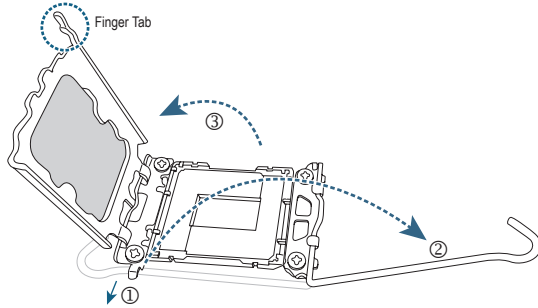

2

Hold the CPU with your fingers by the edges. Align the CPU pin one marking (triangle) with the pin one corner of the CPU socket (or you may align the CPU notches with the socket alignment keys) and gently insert the CPU into position.

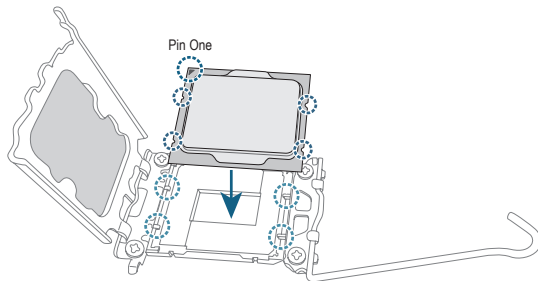

3

Make sure the CPU is properly installed and then close the load plate. The plastic protective cover will pop off, just remove it. Secure the lever under its retention tab to complete the installation of the CPU.

\* Always replace the plastic protective cover when the CPU is not installed to protect the CPU socket.

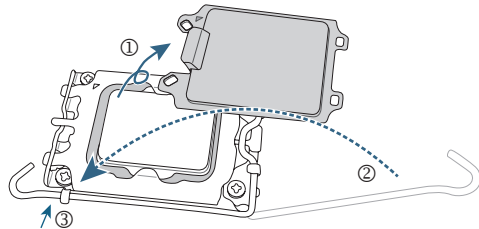

**Do not force to engage the CPU socket locking lever when the CPU is not installed correctly as this would damage the CPU and CPU socket.**

## C. Installing the CPU Cooler

Be sure to install the CPU cooler after installing the CPU. (Actual installation process may differ depending the CPU cooler to be used. Refer to the user's manual for your CPU cooler.)

①

Apply an even and thin layer of thermal grease on the surface of the installed CPU.

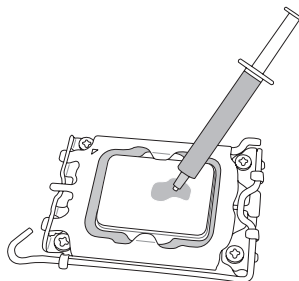

②

Place the cooler atop the CPU, aligning the four push pins through the pin holes on the motherboard. Push down on the push pins diagonally.

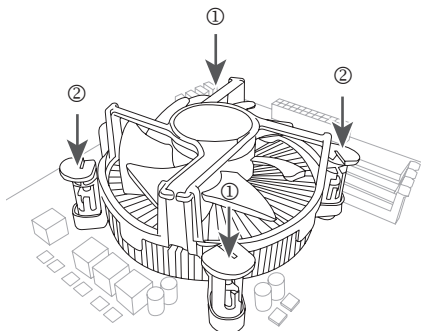

③

Finally, attach the power connector of the CPU cooler to the CPU fan header (CPU\_FAN) on the motherboard.

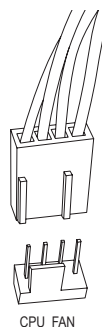

## 2-4 Installing the Memory



Read the following guidelines before you begin to install the memory:

- Make sure that the motherboard supports the memory. It is recommended that memory of the same capacity, brand, speed, and chips be used. (Go to GIGABYTE's website for the latest supported memory speeds and memory modules.)
- Always turn off the computer and unplug the power cord from the power outlet before installing the memory to prevent hardware damage.
- Memory modules have a foolproof design. A memory module can be installed in only one direction. If you are unable to insert the memory, switch the direction.

### Dual Channel Memory Configuration

This motherboard provides four memory sockets and supports Dual Channel Technology. After the memory is installed, the BIOS will automatically detect the specifications and capacity of the memory. Enabling Dual Channel memory mode will double the original memory bandwidth.

The four memory sockets are divided into two channels and each channel has two memory sockets as following:

▶▶ Channel A: ①②③DDR5\_A1/DDR5\_A2, ④⑤DDR4\_A1/DDR4\_A2

▶▶ Channel B: ①②③DDR5\_B1/DDR5\_B2, ④⑤DDR4\_B1/DDR4\_B2

\* Recommended Dual Channel Memory Configuration:

	DDR5_A1①②③ DDR4_A1④⑤	DDR5_A2①②③ DDR4_A2④⑤	DDR5_B1①②③ DDR4_B1④⑤	DDR5_B2①②③ DDR4_B2④⑤
2 Modules	--	DS/SS	--	DS/SS
4 Modules	DS/SS	DS/SS	DS/SS	DS/SS

(SS=Single-Sided, DS=Double-Sided, "--=No Memory)

Due to CPU limitations, read the following guidelines before installing the memory in Dual Channel mode.

1. Dual Channel mode cannot be enabled if only one memory module is installed.
2. When enabling Dual Channel mode with two or four memory modules, it is recommended that memory of the same capacity, brand, speed, and chips be used.

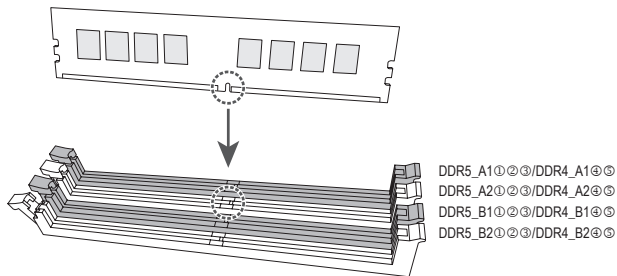

**When installing a single memory module, we recommend that you install it in the DDR5\_A2①②③/DDR4\_A2④⑤ socket.**

- ① Only for Z690 UD AC.
- ② Only for Z690 UD AX.
- ③ Only for Z690 UD.
- ④ Only for Z690 UD AX DDR4.
- ⑤ Only for Z690 UD DDR4.

## 2-5 Installing an Expansion Card



Read the following guidelines before you begin to install an expansion card:

- Make sure the motherboard supports the expansion card. Carefully read the manual that came with your expansion card.
- Always turn off the computer and unplug the power cord from the power outlet before installing an expansion card to prevent hardware damage.

Follow the steps below to correctly install your expansion card in the expansion slot.

1. Locate an expansion slot that supports your card. Remove the metal slot cover from the chassis back panel.
2. Align the card with the slot, and press down on the card until it is fully seated in the slot.
3. Make sure the metal contacts on the card are completely inserted into the slot.
4. Secure the card's metal bracket to the chassis back panel with a screw.
5. After installing all expansion cards, replace the chassis cover(s).
6. Turn on your computer. If necessary, go to BIOS Setup to make any required BIOS changes for your expansion card(s).
7. Install the driver provided with the expansion card in your operating system.

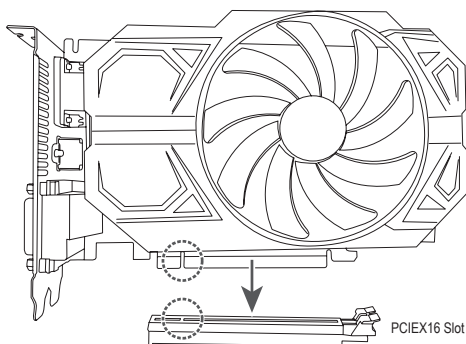



## 2-6 Back Panel Connectors

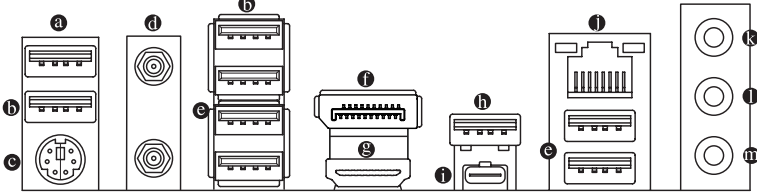

### **a** USB 2.0/1.1 Port (Q-Flash Plus Port)

The USB port supports the USB 2.0/1.1 specification. Use this port for USB devices. Before using Q-Flash Plus <sup>(Note)</sup>, make sure to insert the USB flash drive into this port first.

### **b** USB 2.0/1.1 Port

The USB port supports the USB 2.0/1.1 specification. Use this port for USB devices.

### **c** PS/2 Keyboard/Mouse Port

Use this port to connect a PS/2 mouse or keyboard.

### **d** SMA Antenna Connectors (2T2R) ① ② ④

Use this connector to connect an antenna.



Tighten the antennas to the antenna connectors and then aim the antennas correctly for better signal reception.

### **e** USB 3.2 Gen 1 Port

The USB 3.2 Gen 1 port supports the USB 3.2 Gen 1 specification and is compatible to the USB 2.0 specification. Use this port for USB devices.

### **f** DisplayPort

DisplayPort delivers high quality digital imaging and audio, supporting bi-directional audio transmission. DisplayPort can support HDCP 2.3 content protection mechanisms. You can use this port to connect your DisplayPort-supported monitor. Note: The DisplayPort Technology can support a maximum resolution of 4096x2304@60 Hz but the actual resolutions supported depend on the monitor being used.

### **g** HDMI Port

**HDMI**™ The HDMI port supports HDCP 2.3 and Dolby TrueHD and DTS HD Master Audio formats. It also supports up to 192KHz/16bit 7.1-channel LPCM audio output. You can use this port to connect your HDMI-supported monitor. The maximum supported resolution is 4096x2160@60 Hz, but the actual resolutions supported are dependent on the monitor being used.



After installing the HDMI/DisplayPort device, make sure to set the default sound playback device to HDMI/DisplayPort. (The item name may differ depending on your operating system.)

① Only for Z690 UD AC.

② Only for Z690 UD AX.

④ Only for Z690 UD AX DDR4.

(Note) To enable the Q-Flash Plus function, please navigate to the "Unique Features" page of GIGABYTE's website for more information.



- When removing the cable connected to a back panel connector, first remove the cable from your device and then remove it from the motherboard.
- When removing the cable, pull it straight out from the connector. Do not rock it side to side to prevent an electrical short inside the cable connector.

### ① USB 3.2 Gen 2 Type-A Port (Red)

The USB 3.2 Gen 2 port supports the USB 3.2 Gen 2 specification and is compatible to the USB 3.2 Gen 1 and USB 2.0 specification. Use this port for USB devices.

### ① USB Type-C® Port

The reversible USB port supports the USB 3.2 Gen 2x2 specification and is compatible to the USB 3.2 Gen 2, USB 3.2 Gen 1, and USB 2.0 specifications. Use this port for USB devices.

### ① RJ-45 LAN Port

The Gigabit Ethernet LAN port provides Internet connection at up to 2.5 Gbps data rate. The following describes the states of the LAN port LEDs.

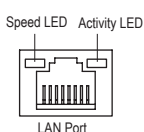

Speed LED:

State	Description
Orange	2.5 Gbps data rate
Green	1 Gbps data rate
Off	100 Mbps data rate

Activity LED:

State	Description
Blinking	Data transmission or receiving is occurring
Off	No data transmission or receiving is occurring

### ③ Line In/Rear Speaker Out (Blue)

The line in jack. Use this audio jack for line in devices such as an optical drive, walkman, etc.

### ① Line Out/Front Speaker Out (Green)

The line out jack.

### ① Mic In/Center/Subwoofer Speaker Out (Pink)

The Mic in jack.

Audio Jack Configurations:

Jack	Headphone/ 2-channel	4-channel	5.1-channel	7.1-channel
③ Line In/Rear Speaker Out		✓	✓	✓
① Line Out/Front Speaker Out	✓	✓	✓	✓
① Mic In/Center/Subwoofer Speaker Out			✓	✓
Front Panel Line Out/Side Speaker Out				✓



- You can change the functionality of an audio jack using the audio software.
- To configure 7.1-channel audio, you need to open the audio software and select Device advanced settings > Playback Device to change the default setting first.



Please visit GIGABYTE's website for details on configuring the audio software.

## 2-7 Internal Connectors

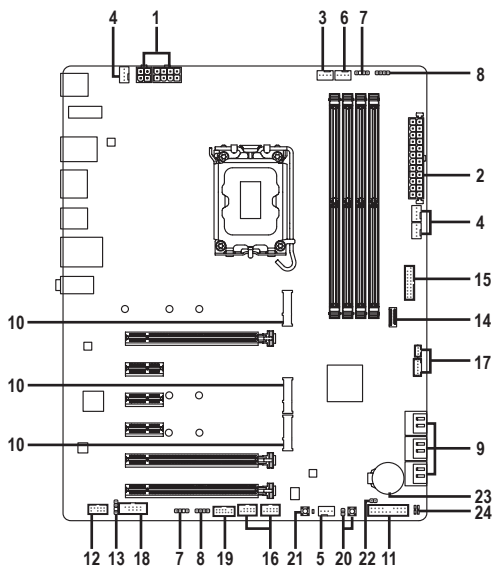

1) ATX_12V_2X2/ATX_12V_2X4	13) SPDIF_O
2) ATX	14) F_U32C
3) CPU_FAN	15) F_U32
4) SYS_FAN1/2A/2B	16) F_USB1/F_USB2
5) SYS_FAN3_PUMP	17) THB_C1/THB_C2
6) CPU_OPT	18) COM
7) D_LED1/D_LED2	19) SPI_TPM
8) LED_C1/LED_C2	20) RST_SW/RST
9) SATA3 2/3/4/5/6/7	21) QFLASH_PLUS
10) M2A_CPU/M2P_SB/M2Q_SB	22) CLR_CMOS
11) F_PANEL	23) BAT
12) F_AUDIO	24) CPU/DRAM/VGA/BOOT



Read the following guidelines before connecting external devices:

- First make sure your devices are compliant with the connectors you wish to connect.
- Before installing the devices, be sure to turn off the devices and your computer. Unplug the power cord from the power outlet to prevent damage to the devices.
- After installing the device and before turning on the computer, make sure the device cable has been securely attached to the connector on the motherboard.

## 1/2) ATX\_12V\_2X2/ATX\_12V\_2X4/ATX (2x2, 2x4, 12V Power Connectors and 2x12 Main Power Connector)

With the use of the power connector, the power supply can supply enough stable power to all the components on the motherboard. Before connecting the power connector, first make sure the power supply is turned off and all devices are properly installed. The power connector possesses a foolproof design. Connect the power supply cable to the power connector in the correct orientation.

The 12V power connector mainly supplies power to the CPU. If the 12V power connector is not connected, the computer will not start.



To meet expansion requirements, it is recommended that a power supply that can withstand high power consumption be used (500W or greater). If a power supply is used that does not provide the required power, the result can lead to an unstable or unbootable system.

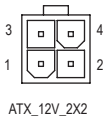
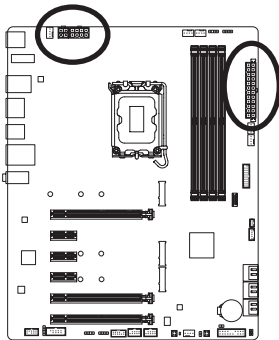

ATX\_12V\_2X2:

Pin No.	Definition
1	GND
2	GND
3	+12V
4	+12V

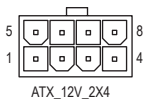

ATX\_12V\_2X4:

Pin No.	Definition	Pin No.	Definition
1	GND (Only for 2x4-pin 12V)	5	+12V (Only for 2x4-pin 12V)
2	GND (Only for 2x4-pin 12V)	6	+12V (Only for 2x4-pin 12V)
3	GND	7	+12V
4	GND	8	+12V

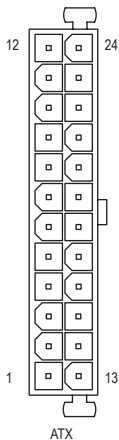

ATX:

Pin No.	Definition	Pin No.	Definition
1	3.3V	13	3.3V
2	3.3V	14	-12V
3	GND	15	GND
4	+5V	16	PS_ON (soft On/Off)
5	GND	17	GND
6	+5V	18	GND
7	GND	19	GND
8	Power Good	20	NC
9	5VSB (stand by +5V)	21	+5V
10	+12V	22	+5V
11	+12V (Only for 2x12-pin ATX)	23	+5V (Only for 2x12-pin ATX)
12	3.3V (Only for 2x12-pin ATX)	24	GND (Only for 2x12-pin ATX)

### 3/4) CPU\_FAN/SYS\_FAN1/2A/2B (Fan Headers)

All fan headers on this motherboard are 4-pin. Most fan headers possess a foolproof insertion design. When connecting a fan cable, be sure to connect it in the correct orientation (the black connector wire is the ground wire). The speed control function requires the use of a fan with fan speed control design. For optimum heat dissipation, it is recommended that a system fan be installed inside the chassis.

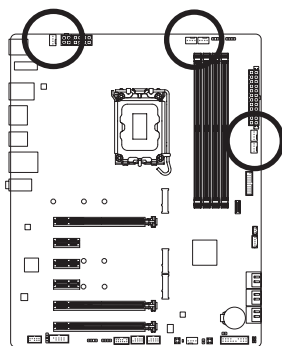

CPU\_FAN/SYS\_FAN1/SYS\_FAN2A:

Pin No.	Definition
1	GND
2	Voltage Speed Control
3	Sense
4	PWM Speed Control

SYS\_FAN2B:

Pin No.	Definition
1	GND
2	Voltage Speed Control
3	Sense
4	NC

### 5) SYS\_FAN3\_PUMP (System Fan/Water Cooling Pump Header)

The fan/pump headers are 4-pin. Most fan headers possess a foolproof insertion design. When connecting a fan cable, be sure to connect it in the correct orientation (the black connector wire is the ground wire). The speed control function requires the use of a fan with fan speed control design. For optimum heat dissipation, it is recommended that a system fan be installed inside the chassis. The header also provides speed control for a water cooling pump. Please navigate to the "BIOS Setup" page of GIGABYTE's website and search for "Smart Fan 6" for more information.

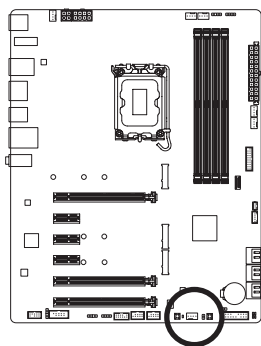

Pin No.	Definition
1	GND
2	Voltage Speed Control
3	Sense
4	PWM Speed Control

## 6) CPU\_OPT (Water Cooling CPU Fan Header)

The fan header is 4-pin and possesses a foolproof insertion design. Most fan headers possess a foolproof insertion design. When connecting a fan cable, be sure to connect it in the correct orientation (the black connector wire is the ground wire). The speed control function requires the use of a fan with fan speed control design.

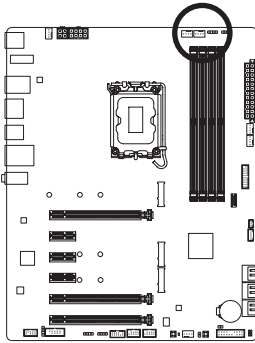

Pin No.	Definition
1	GND
2	Voltage Speed Control
3	Sense
4	PWM Speed Control

Connector	CPU_FAN	SYS_FAN1/2A/2B	SYS_FAN3_PUMP	CPU_OPT
Maximum Current	2A	2A	2A	2A
Maximum Power	24W	24W	24W	24W



- Be sure to connect fan cables to the fan headers to prevent your CPU and system from overheating. Overheating may result in damage to the CPU or the system may hang.
- These fan headers are not configuration jumper blocks. Do not place a jumper cap on the headers.

## 7) D\_LED1/D\_LED2 (Addressable LED Strip Headers)

The headers can be used to connect a standard 5050 addressable LED strip, with maximum power rating of 5A (5V) and maximum number of 1000 LEDs.

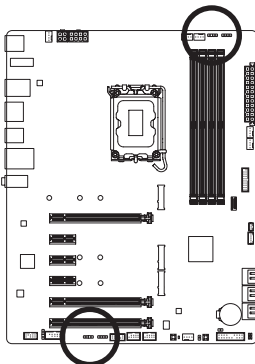

Pin No.	Definition
1	V (5V)
2	Data
3	No Pin
4	GND

Connect your addressable LED strip to the header. The power pin (marked with a triangle on the plug) of the LED strip must be connected to Pin 1 of the addressable LED strip header. Incorrect connection may lead to the damage of the LED strip.

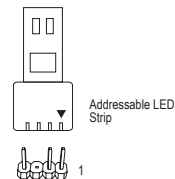

## 8) LED\_C1/LED\_C2 (RGB LED Strip Headers)

The headers can be used to connect a standard 5050 RGB LED strip (12V/G/R/B), with maximum power rating of 2A (12V) and maximum length of 2m.

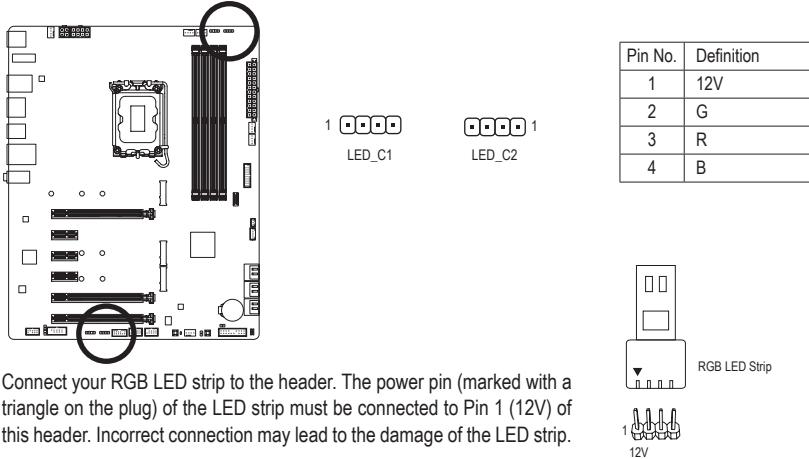

Connect your RGB LED strip to the header. The power pin (marked with a triangle on the plug) of the LED strip must be connected to Pin 1 (12V) of this header. Incorrect connection may lead to the damage of the LED strip.



For how to turn on/off the lights of the LED strip, please navigate to the "Unique Features" page of GIGABYTE's website.



Before installing the devices, be sure to turn off the devices and your computer. Unplug the power cord from the power outlet to prevent damage to the devices.

## 9) SATA3 2/3/4/5/6/7 (SATA 6Gb/s Connectors)

The SATA connectors conform to SATA 6Gb/s standard and are compatible with SATA 3Gb/s and SATA 1.5Gb/s standard. Each SATA connector supports a single SATA device. The Intel® Chipset supports RAID 0, RAID 1, RAID 5, and RAID 10. Please navigate to the "Configuring a RAID Set" page of GIGABYTE's website for instructions on configuring a RAID array.

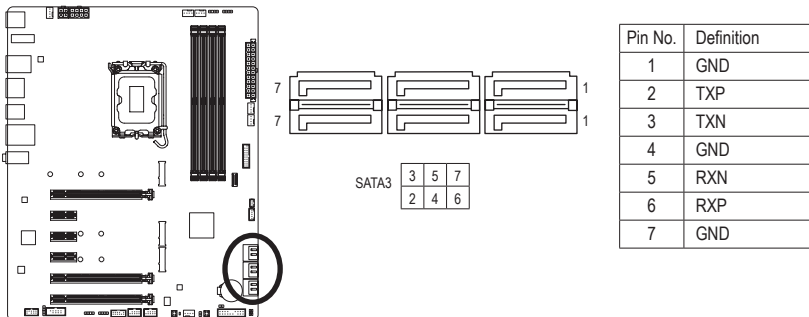

To enable hot-plugging for the SATA ports, please visit the "BIOS Setup," "SATA And RST Configuration," webpage of GIGABYTE's website for more information.

## 10) M2A\_CPU/M2P\_SB/M2Q\_SB (M.2 Socket 3 Connectors)

There are two types of M.2 SSDs: M.2 SATA SSDs and M.2 PCIe SSDs. This motherboard only supports M.2 PCIe SSDs. Be sure to verify the type of M.2 SSDs you want to use. Please note that an M.2 PCIe SSD cannot be used to create a RAID set with a SATA hard drive. Please navigate to the "Configuring a RAID Set" page of GIGABYTE's website for instructions on configuring a RAID array.

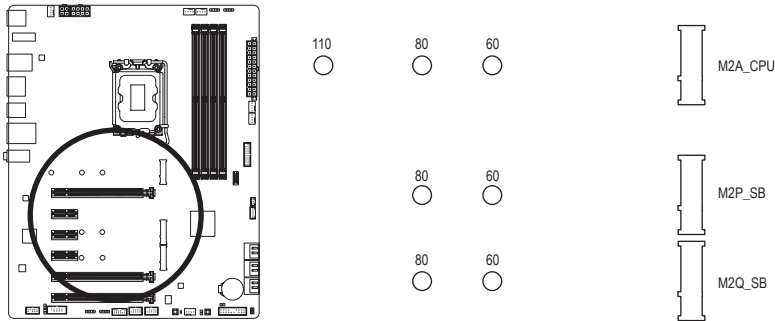

Follow the steps below to correctly install an M.2 SSD in the M.2 connector.

### Step 1:

Locate the M.2 connector where you will install the M.2 SSD, use a screwdriver to unfasten the screw on the heatsink and then remove the heatsink. (Only the M2A\_CPU connector has the heatsink.) Remove the protective film from the thermal pad on the M2A\_CPU connector.

### Step 2:

Locate the proper mounting hole based on the length of your M.2 SSD drive. If needed, move the standoff to the desired mounting hole. Insert the M.2 SSD into the M.2 connector at an angle.

### Step 3:

Press the M.2 SSD down and then use the included screw to secure it in the connector. Replace the heatsink and secure it to the original hole. Remove the protective film from the bottom of the heatsink before replacing the heatsink.

\* Types of M.2 SSDs supported by each M.2 connector:

	M.2 PCIe x4 SSD	M.2 PCIe x2 SSD	M.2 SATA SSD
M2A_CPU	✓	✓	✗
M2P_SB	✓	✓	✗
M2Q_SB	✓	✓	✗



If you want to install an operating system on an M.2 PCIe SSD, you need to install the Intel® RST VMD Controller driver first. Refer to Chapter 4 for more instructions.



## 11) F\_PANEL (Front Panel Header)

Connect the power switch, reset switch, speaker, chassis intrusion switch/sensor and system status indicator on the chassis to this header according to the pin assignments below. Note the positive and negative pins before connecting the cables.

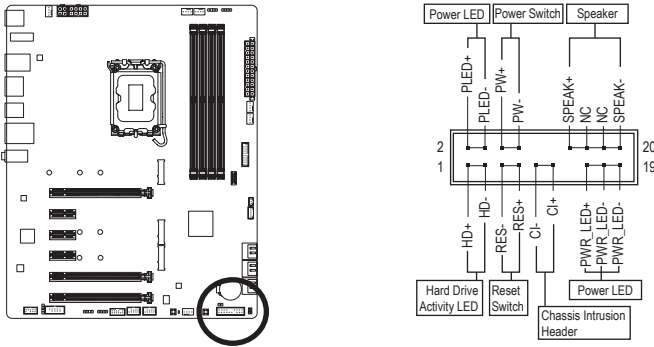

- **PLED/PWR\_LED (Power LED):**

System Status	LED
S0	On
S3/S4/S5	Off

Connects to the power status indicator on the chassis front panel. The LED is on when the system is operating. The LED is off when the system is in S3/S4 sleep state or powered off (S5).

- **PW (Power Switch):**

Connects to the power switch on the chassis front panel. You may configure the way to turn off your system using the power switch (please visit the "BIOS Setup," "Settings\Platform Power," webpage of GIGABYTE's website for more information).

- **SPEAK (Speaker):**

Connects to the speaker on the chassis front panel. The system reports system startup status by issuing a beep code. One single short beep will be heard if no problem is detected at system startup.

- **HD (Hard Drive Activity LED):**

Connects to the hard drive activity LED on the chassis front panel. The LED is on when the hard drive is reading or writing data.

- **RES (Reset Switch):**

Connects to the reset switch on the chassis front panel. Press the reset switch to restart the computer if the computer freezes and fails to perform a normal restart.

- **CI (Chassis Intrusion Header):**

Connects to the chassis intrusion switch/sensor on the chassis that can detect if the chassis cover has been removed. This function requires a chassis with a chassis intrusion switch/sensor.

- **NC: No connection.**



The front panel design may differ by chassis. A front panel module mainly consists of power switch, reset switch, power LED, hard drive activity LED, speaker and etc. When connecting your chassis front panel module to this header, make sure the wire assignments and the pin assignments are matched correctly.

## 12) F\_AUDIO (Front Panel Audio Header)

The front panel audio header supports High Definition audio (HD). You may connect your chassis front panel audio module to this header. Make sure the wire assignments of the module connector match the pin assignments of the motherboard header. Incorrect connection between the module connector and the motherboard header will make the device unable to work or even damage it.

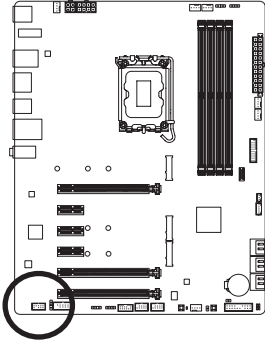

Pin No.	Definition
1	MIC2_L
2	GND
3	MIC2_R
4	NC
5	LINE2_R
6	Sense
7	FAUDIO_JD
8	No Pin
9	LINE2_L
10	Sense



Some chassis provide a front panel audio module that has separated connectors on each wire instead of a single plug. For information about connecting the front panel audio module that has different wire assignments, please contact the chassis manufacturer.

## 13) SPDIF\_O (S/PDIF Out Header)

This header supports S/PDIF digital output, which allows you to connect a S/PDIF digital audio cable to output digital audio from your motherboard to the supported audio devices. For information about connecting the digital audio cable, carefully read the manual for your audio devices.

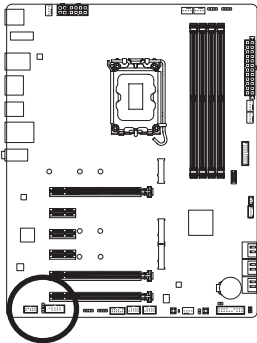

Pin No.	Definition
1	5VDUAL
2	No Pin
3	SPDIFO
4	GND

#### 14) F\_U32C (USB Type-C® Header with USB 3.2 Gen 1 Support)

The header conforms to USB 3.2 Gen 1 specification and can provide one USB port.

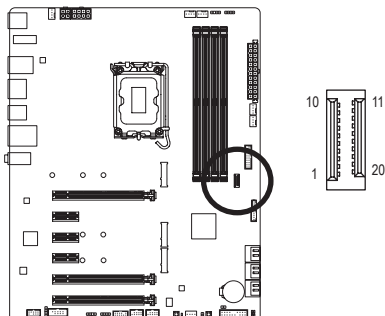

Pin No.	Definition	Pin No.	Definition
1	VBUS	11	VBUS
2	TX1+	12	TX2+
3	TX1-	13	TX2-
4	GND	14	GND
5	RX1+	15	RX2+
6	RX1-	16	RX2-
7	VBUS	17	GND
8	CC1	18	D-
9	SBU1	19	D+
10	SBU2	20	CC2

#### 15) F\_U32 (USB 3.2 Gen 1 Header)

The header conforms to USB 3.2 Gen 1 and USB 2.0 specification and can provide two USB ports. For purchasing the optional 3.5" front panel that provides two USB 3.2 Gen 1 ports, please contact the local dealer.

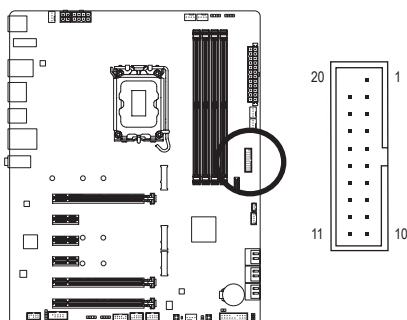

Pin No.	Definition	Pin No.	Definition
1	VBUS	11	D2+
2	SSRX1-	12	D2-
3	SSRX1+	13	GND
4	GND	14	SSTX2+
5	SSTX1-	15	SSTX2-
6	SSTX1+	16	GND
7	GND	17	SSRX2+
8	D1-	18	SSRX2-
9	D1+	19	VBUS
10	NC	20	No Pin

## 16) F\_USB1/F\_USB2 (USB 2.0/1.1 Headers)

The headers conform to USB 2.0/1.1 specification. Each USB header can provide two USB ports via an optional USB bracket. For purchasing the optional USB bracket, please contact the local dealer.

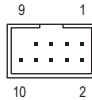
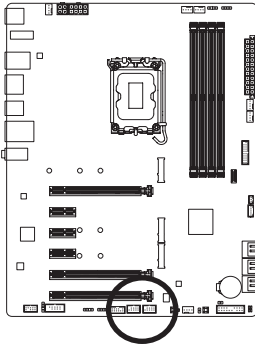

Pin No.	Definition
1	Power (5V)
2	Power (5V)
3	USB DX-
4	USB DY-
5	USB DX+
6	USB DY+
7	GND
8	GND
9	No Pin
10	NC



- Do not plug the IEEE 1394 bracket (2x5-pin) cable into the USB 2.0/1.1 header.
- Prior to installing the USB bracket, be sure to turn off your computer and unplug the power cord from the power outlet to prevent damage to the USB bracket.

## 17) THB\_C1/THB\_C2 (Thunderbolt™ Add-in Card Connectors)

The connectors are used to connect to a GIGABYTE Thunderbolt™ add-in card.

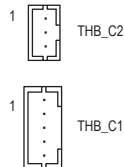
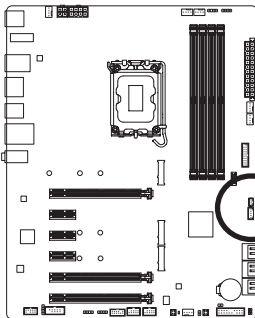

Supports a Thunderbolt™ add-in card.

### 18) COM (Serial Port Header)

The COM header can provide one serial port via an optional COM port cable. For purchasing the optional COM port cable, please contact the local dealer.

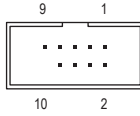
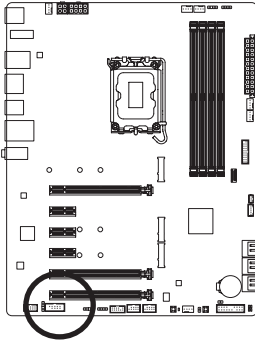

Pin No.	Definition
1	NDCD-
2	NSIN
3	NSOUT
4	NDTR-
5	GND
6	NDSR-
7	NRTS-
8	NCTS-
9	NRI-
10	No Pin

### 19) SPI\_TPM (Trusted Platform Module Header)

You may connect an SPI TPM (Trusted Platform Module) to this header.

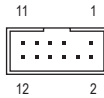
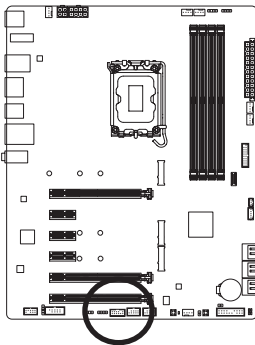

Pin No.	Definition
1	Data Output
2	Power (3.3V)
3	No Pin
4	NC
5	Data Input
6	CLK
7	Chip Select
8	GND
9	IRQ
10	NC
11	NC
12	RST

## 20) RST\_SW/RST (Reset Button/Reset Jumper)

The reset button (RST\_SW) allows users to quickly turn on/off the computer in an open-case environment when they want to change hardware components or conduct hardware testing. The reset jumper (RST) can connect to the reset switch on the chassis front panel. Press the reset switch to restart the computer if the computer freezes and fails to perform a normal restart.

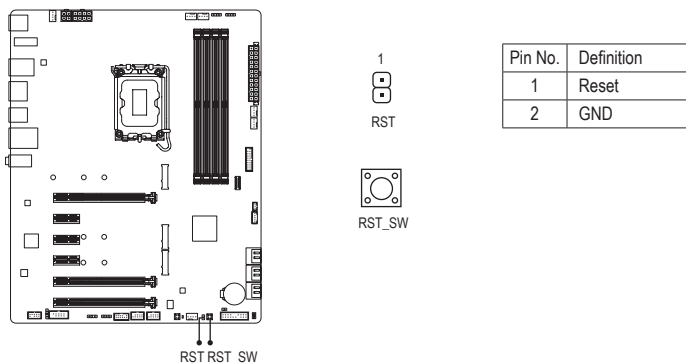

The reset button (RST\_SW)/reset jumper (RST) provides you with several functions to use. To remap the button to perform different tasks, please navigate to the "BIOS Setup" page of GIGABYTE's website and search for "RST\_SW (MULTIKEY)" for more information.

## 21) QFLASH\_PLUS (Q-Flash Plus Button)

Q-Flash Plus allows you to update the BIOS when your system is off (S5 shutdown state). Save the latest BIOS on a USB thumb drive and plug it into the dedicated port, and then you can now flash the BIOS automatically by simply pressing the Q-Flash Plus button. The QFLED will flash when the BIOS matching and flashing activities start and will stop flashing when the main BIOS flashing is complete.

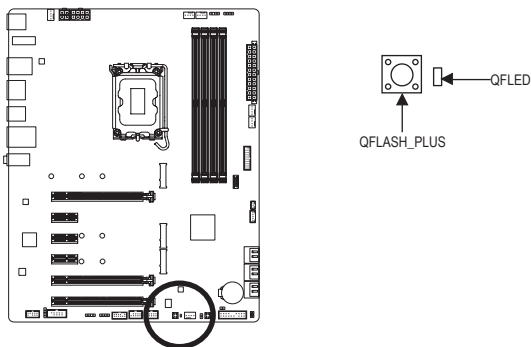

For how to use Q-Flash Plus please visit the "Unique Features" webpage of GIGABYTE's website.

## 22) CLR\_CMOS (Clear CMOS Jumper)

Use this jumper to clear the BIOS configuration and reset the CMOS values to factory defaults. To clear the CMOS values, use a metal object like a screwdriver to touch the two pins for a few seconds.

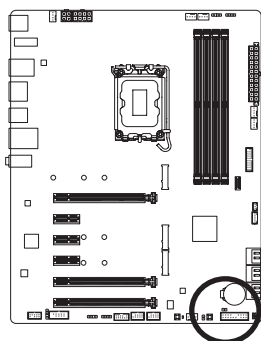

Open: Normal



Short: Clear CMOS Values



- Always turn off your computer and unplug the power cord from the power outlet before clearing the CMOS values.
- After system restart, go to BIOS Setup to load factory defaults (select Load Optimized Defaults) or manually configure the BIOS settings (please navigate to the "BIOS Setup" page of GIGABYTE's website for more information).

## 23) BAT (Battery)

The battery provides power to keep the values (such as BIOS configurations, date, and time information) in the CMOS when the computer is turned off. Replace the battery when the battery voltage drops to a low level, or the CMOS values may not be accurate or may be lost.

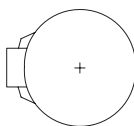
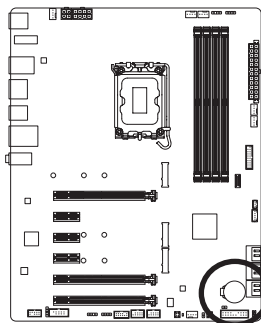

You may clear the CMOS values by removing the battery:

1. Turn off your computer and unplug the power cord.
2. Gently remove the battery from the battery holder and wait for one minute. (Or use a metal object like a screwdriver to touch the positive and negative terminals of the battery holder, making them short for 5 seconds.)
3. Replace the battery.
4. Plug in the power cord and restart your computer.



- Always turn off your computer and unplug the power cord before replacing the battery.
- Replace the battery with an equivalent one. Damage to your devices may occur if the battery is replaced with an incorrect model.
- Contact the place of purchase or local dealer if you are not able to replace the battery by yourself or uncertain about the battery model.
- When installing the battery, note the orientation of the positive side (+) and the negative side (-) of the battery (the positive side should face up).
- Used batteries must be handled in accordance with local environmental regulations.

## 24) CPU/DRAM/VGA/BOOT (Status LEDs)

The status LEDs show whether the CPU, memory, graphics card, and operating system are working properly after system power-on. If the CPU/DRAM/VGA LED is on, that means the corresponding device is not working normally; if the BOOT LED is on, that means you haven't entered the operating system yet.

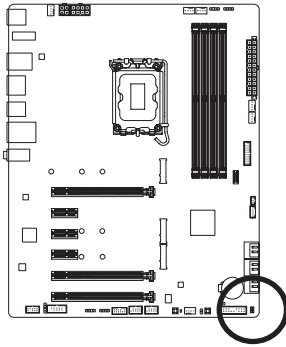

□	□
□	□
CPU	DRAM
VGA	BOOT

**CPU:** CPU status LED

**DRAM:** Memory status LED

**VGA:** Graphics card status LED

**BOOT:** Operating system status LED



## Chapter 3 BIOS Setup

BIOS (Basic Input and Output System) records hardware parameters of the system in the CMOS on the motherboard. Its major functions include conducting the Power-On Self-Test (POST) during system startup, saving system parameters and loading operating system, etc. BIOS includes a BIOS Setup program that allows the user to modify basic system configuration settings or to activate certain system features.

When the power is turned off, the battery on the motherboard supplies the necessary power to the CMOS to keep the configuration values in the CMOS.

To access the BIOS Setup program, press the <Delete> key during the POST when the power is turned on.

To upgrade the BIOS, use either the GIGABYTE Q-Flash or @BIOS utility.

- Q-Flash allows the user to quickly and easily upgrade or back up BIOS without entering the operating system.
- @BIOS is a Windows-based utility that searches and downloads the latest version of BIOS from the Internet and updates the BIOS.

For instructions on using the Q-Flash and @BIOS utilities, please navigate to the "Unique Features" page of GIGABYTE's website and search for "BIOS Update Utilities."



- Because BIOS flashing is potentially risky, if you do not encounter problems using the current version of BIOS, it is recommended that you not flash the BIOS. To flash the BIOS, do it with caution. Inadequate BIOS flashing may result in system malfunction.
- It is recommended that you not alter the default settings (unless you need to) to prevent system instability or other unexpected results. Inadequately altering the settings may result in system's failure to boot. If this occurs, try to clear the CMOS values and reset the board to default values.
- Refer to the introductions of the battery/clear CMOS jumper in Chapter 2 or navigate to the "BIOS Setup" page of GIGABYTE's website and search for "Load Optimized Defaults" for how to clear the CMOS values.



Please visit GIGABYTE's website for details on configuring BIOS Setup.

## Startup Screen:

The following startup Logo screen will appear when the computer boots.



## Function Keys:

### <DEL>: BIOS SETUP/Q-FLASH

Press the <Delete> key to enter BIOS Setup or to access the Q-Flash utility in BIOS Setup.

### <F12>: BOOT MENU

Boot Menu allows you to set the first boot device without entering BIOS Setup. In Boot Menu, use the up arrow key <↑> or the down arrow key <↓> to select the first boot device, then press <Enter> to accept. The system will boot from the device immediately.

Note: The setting in Boot Menu is effective for one time only. After system restart, the device boot order will still be based on BIOS Setup settings.

### <END>: Q-FLASH

Press the <End> key to access the Q-Flash utility directly without having to enter BIOS Setup first.

## Chapter 4 Installing the Operating System and Drivers

### 4-1 Operating System Installation

With the correct BIOS settings, you are ready to install the operating system.

If you want to install an operating system on an M.2 PCIe SSD or a RAID volume, you need to install the Intel® RST VMD Controller driver first during the OS installation process. Refer to the steps below:

Step 1:

Go to GIGABYTE's website, browse to the motherboard model's web page, download the **Intel SATA Preinstall driver** file on the **Support\Download\SATA RAID/AHCI** page, unzip the file and copy the files to your USB thumb drive.

Step 2:

Boot from the Windows setup disc and perform standard OS installation steps. When the screen requesting you to load the driver appears, select **Browse**.

Step 3:

Insert the USB thumb drive and then browse to the location of the driver. When a screen as shown below appears, select **Intel RST VMD Controller 467F** and click **Next** to load the driver and continue the OS installation.

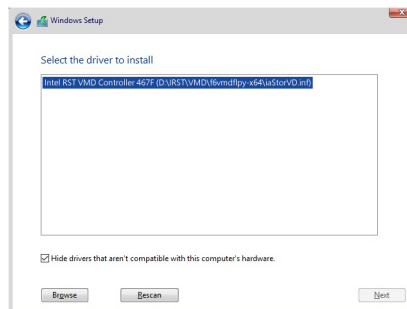

## 4-2 Drivers Installation

After you install the operating system, a dialog box will appear on the bottom-right corner of the desktop asking if you want to download and install the drivers and GIGABYTE applications via APP Center. Click **Install** to proceed with the installation. (In BIOS Setup, make sure Settings\IO Ports\APP Center Download & Install Configuration\APP Center Download & Install is set to **Enabled**.)

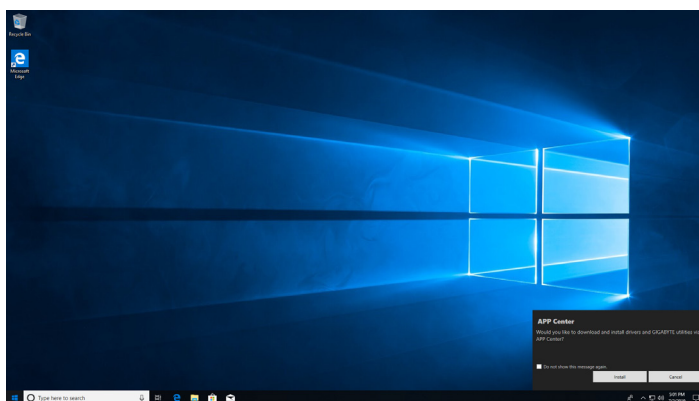

When the End User License Agreement dialog box appears, press <Accept> to install APP Center. On the APP Center screen, select the drivers and applications you want to install and click **Install**.

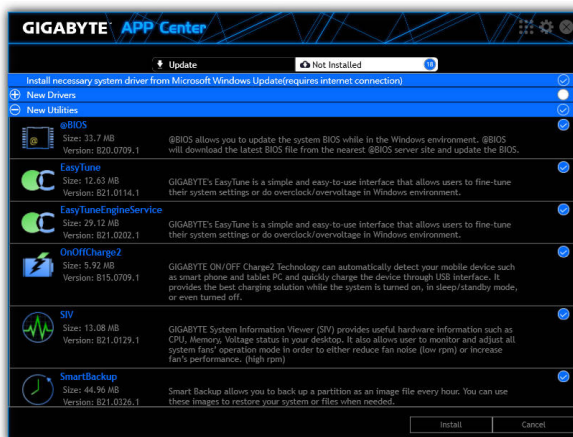

Before the installation, make sure the system is connected to the Internet.



Please visit GIGABYTE's website for more software information.



Please visit GIGABYTE's website for more troubleshooting information.

# Chapter 5 Appendix

## 5-1 Configuring a RAID Set

### RAID Levels

	RAID 0	RAID 1	RAID 5	RAID 10
Minimum Number of Hard Drives	≥2	2	≥3	4
Array Capacity	Number of hard drives * Size of the smallest drive	Size of the smallest drive	(Number of hard drives - 1) * Size of the smallest drive	(Number of hard drives/2) * Size of the smallest drive
Fault Tolerance	No	Yes	Yes	Yes

### Before you begin, please prepare the following items:

This motherboard supports RAID 0, RAID 1, RAID 5, and RAID 10. Prepare the correct number of hard drives as indicated in the table above before configuring a RAID array.

- SATA hard drives or SSDs. To ensure optimal performance, it is recommended that you use two hard drives with identical model and capacity.
- Windows setup disc.
- An Internet connected computer.
- A USB thumb drive.



An M.2 PCIe SSD cannot be used to create a RAID set with a SATA hard drive.



Please visit GIGABYTE's website for details on configuring a RAID array.

# Regulatory Notices

## United States of America, Federal Communications Commission Statement

### Supplier's Declaration of Conformity 47 CFR § 2.1077 Compliance Information

Product Name: **Motherboard**  
Trade Name: **GIGABYTE**  
Model Number: **Z690 UD AC / Z690 UD AX / Z690 UD / Z690 UD AX DDR4 / Z690 UD DDR4**

Responsible Party – U.S. Contact Information: **G.B.T. Inc.**  
Address: 17358 Railroad street, City Of Industry, CA91748  
Tel.: 1-626-854-9338  
Internet contact information: <https://www.gigabyte.com>

#### FCC Compliance Statement:

This device complies with Part 15 of the FCC Rules, Subpart B, Unintentional Radiators.  
Operation is subject to the following two conditions: (1) This device may not cause harmful interference, and (2) this device must accept any interference received, including interference that may cause undesired operation.

The FCC with its action in ET Docket 96-8 has adopted a safety standard for human exposure to radio frequency (RF) electromagnetic energy emitted by FCC certified equipment. The Intel PRO/Wireless 5000 LAN products meet the Human Exposure limits found in OET Bulletin 65, 2001, and ANSI/IEEE C95.1, 1992. Proper operation of this radio according to the instructions found in this manual will result in exposure substantially below the FCC's recommended limits.

The following safety precautions should be observed:

- Do not touch or move antenna while the unit is transmitting or receiving.
- Do not hold any component containing the radio such that the antenna is very close or touching any exposed parts of the body, especially the face or eyes, while transmitting.
- Do not operate the radio or attempt to transmit data unless the antenna is connected; if not, the radio may be damaged.
- Use in specific environments:
  - The use of wireless devices in hazardous locations is limited by the constraints posed by the safety directors of such environments.
  - The use of wireless devices on airplanes is governed by the Federal Aviation Administration (FAA).
  - The use of wireless devices in hospitals is restricted to the limits set forth by each hospital.

#### Antenna use:

In order to comply with FCC RF exposure limits, low gain integrated antennas should be located at a minimum distance of 7.9 inches (20 cm) or more from the body of all persons.

#### Explosive Device Proximity Warning

Warning: Do not operate a portable transmitter (such as a wireless network device) near unshielded blasting caps or in an explosive environment unless the device has been modified to be qualified for such use.

#### Antenna Warning

The wireless adapter is not designed for use with high-gain antennas.

#### Use On Aircraft Caution

Caution: Regulations of the FCC and FAA prohibit airborne operation of radio-frequency wireless devices because their signals could interfere with critical aircraft instruments.

#### Other Wireless Devices

Safety Notices for Other Devices in the Wireless Network: Refer to the documentation supplied with wireless Ethernet adapters or other devices in the wireless network.

#### Canada, Canada-Industry Notice:

This device complies with Industry Canada license-exempt RSS standard(s). Operation is subject to the following two conditions:

- (1) this device may not cause interference, and
- (2) this device must accept any interference, including interference that may cause undesired operation of the device.

Cet appareil est conforme aux normes Canada d'Industrie de RSS permis-exempt. L'utilisation est assujéti aux deux conditions suivantes:  
(1) le dispositif ne doit pas produire de brouillage préjudiciable, et

(2) ce dispositif doit accepter tout brouillage reçu, y compris un brouillage susceptible de provoquer un fonctionnement indésirable.

**Caution:** When using IEEE 802.11a wireless LAN, this product is restricted to indoor use due to its operation in the 5.15-to 5.25-GHz frequency range. Industry Canada requires this product to be used indoors for the frequency range of 5.15 GHz to 5.25 GHz to reduce the potential for harmful interference to co-channel mobile satellite systems. High power radar is allocated as the primary user of the 5.25-to 5.35-GHz and 5.65 to 5.85-GHz bands. These radar stations can cause interference with and/or damage to this device. The maximum allowed antenna gain for use with this device is 6dBi in order to comply with the E.I.R.P limit for the 5.25-to 5.35 and 5.725 to 5.85 GHz frequency range in point-to-point operation. To comply with RF exposure requirements all antennas should be located at a minimum distance of 20cm, or the minimum separation distance allowed by the module approval, from the body of all persons.

**Attention:** l'utilisation d'un réseau sans fil IEEE802.11a est restreinte à une utilisation en intérieur à cause du fonctionnement dans la bande de fréquence 5.15-5.25 GHz. Industry Canada requiert que ce produit soit utilisé à l'intérieur des bâtiments pour la bande de fréquence 5.15-5.25 GHz afin de réduire les possibilités d'interférences nuisibles aux canaux co-existants des systèmes de transmission satellites. Les radars de puissances ont fait l'objet d'une allocation primaire de fréquences dans les bandes 5.25-5.35 GHz et 5.65-5.85 GHz. Ces stations radar peuvent créer des interférences avec ce produit et/ou lui être nuisible. Le gain d'antenne maximum permissible pour une utilisation avec ce produit est de 6 dBi afin d'être conforme aux limites de puissance isotropique rayonnée équivalente (P.I.R.E.) applicable.  
dans les bandes 5.25-5.35 GHz et 5.725-5.85 GHz en fonctionnement point-à-point. Pour se conformer aux conditions d'exposition de RF toutes les antennes devraient être localisées à une distance minimum de 20 cm, ou la distance de séparation minimum permise par l'approbation du module, du corps de toutes les personnes.

Under Industry Canada regulations, this radio transmitter may only operate using an antenna of a type and maximum (or lesser) gain approved for the transmitter by Industry Canada. To reduce potential radio interference to other users, the antenna type and its gain should be chosen so that the equivalent isotropically radiated power (e.i.r.p.) is not more than that necessary for successful communication.

Conformément à la réglementation d'Industrie Canada, le présent émetteur radio peut fonctionner avec une antenne d'un type et d'un gain maximal (ou inférieur) approuvé pour l'émetteur par Industrie Canada. Dans le but de réduire les risques de brouillage radio électrique à l'intention des autres utilisateurs, il faut choisir le type d'antenne et son gain de sorte que la puissance isotrope rayonnée équivalente (p.i.r.e.) ne dépasse pas l'intensité nécessaire à l'établissement d'une communication satisfaisante.

#### European Union (EU) CE Declaration of Conformity

This device complies with the following directives: Electromagnetic Compatibility Directive 2014/30/EU, Low-voltage Directive 2014/35/EU, Radio Equipment Directive 2014/53/EU, ErP Directive 2009/125/EC, RoHS directive (recast) 2011/65/EU & the 2015/863 Statement. This product has been tested and found to comply with all essential requirements of the Directives.

**European Union (EU) RoHS (recast) Directive 2011/65/EU & the European Commission Delegated Directive (EU) 2015/863 Statement**  
GIGABYTE products have not intended to add and safe from hazardous substances (Cd, Pb, Hg, Cr+6, PBDE, PBB, DEHP, BBP, DBP and DIBP). The parts and components have been carefully selected to meet RoHS requirement. Moreover, we at GIGABYTE are continuing our efforts to develop products that do not use internationally banned toxic chemicals.

#### European Union (EU) Community Waste Electrical & Electronic Equipment (WEEE) Directive Statement

GIGABYTE will fulfill the national laws as interpreted from the 2012/19/EU WEEE (Waste Electrical and Electronic Equipment) (recast) directive. The WEEE Directive specifies the treatment, collection, recycling and disposal of electric and electronic devices and their components. Under the Directive, used equipment must be marked, collected separately, and disposed of properly.

#### WEEE Symbol Statement



The symbol shown below is on the product or on its packaging, which indicates that this product must not be disposed of with other waste. Instead, the device should be taken to the waste collection centers for activation of the treatment, collection, recycling and disposal procedure.

For more information about where you can drop off your waste equipment for recycling, please contact your local government office, your household waste disposal service or where you purchased the product for details of environmentally safe recycling.

#### End of Life Directives-Recycling



The symbol shown below is on the product or on its packaging, which indicates that this product must not be disposed of with other waste. Instead, the device should be taken to the waste collection centers for activation of the treatment, collection, recycling and disposal procedure.

#### Déclaration de Conformité aux Directives de l'Union européenne (UE)

Cet appareil portant la marque CE est conforme aux directives de l'UE suivantes: directive Compatibilité Electromagnétique 2014/30/UE, directive Basse Tension 2014/35/UE, directive équipements radioélectriques 2014/53/UE, la directive RoHS II 2011/65/UE & la déclaration 2015/863.

La conformité à ces directives est évaluée sur la base des normes européennes harmonisées applicables.

#### European Union (EU) CE-Konformitätserklärung

Dieses Produkte mit CE-Kennzeichnung erfüllen folgenden EU-Richtlinien: EMV-Richtlinie 2014/30/EU, Niederspannungsrichtlinie 2014/35/EU, Funkanlagen Richtlinie 2014/53/EU, RoHS-Richtlinie 2011/65/EU erfüllt und die 2015/863 Erklärung. Die Konformität mit diesen Richtlinien wird unter Verwendung der entsprechenden Standards zur Europäischen Normierung beurteilt.

#### CE declaração de conformidade

Este produto com a marcação CE estão em conformidade com das seguintes Diretivas UE: Diretiva Baixa Tensão 2014/35/EU; Diretiva CEM 2014/30/EU; Diretiva RSP 2011/65/UE e a declaração 2015/863. A conformidade com estas diretivas é verificada utilizando as normas europeias harmonizadas.

#### CE Declaración de conformidad

Este producto que llevan la marca CE cumplen con las siguientes Directivas de la Unión Europea: Directiva EMC 2014/30/UE, Directiva de bajo voltaje 2014/35/UE, Directiva de equipamientos de radio 2014/53/UE, Directiva RoHS 2011/65/UE y la Declaración 2015/863.

El cumplimiento de estas directivas se evalúa mediante las normas europeas armonizadas.

#### CE Dichiarazione di conformità

I prodotti con il marchio CE sono conformi con una o più delle seguenti Direttive UE, come applicabile: Direttiva EMC 2014/30/UE, Direttiva sulla bassa tensione 2014/35/UE, Direttiva di apparecchiature radio 2014/53/UE, Direttiva RoHS 2011/65/UE e Dichiarazione 2015/863.

La conformità con tali direttive viene valutata utilizzando gli Standard europei armonizzati applicabili.

#### Deklaracja zgodności UE Unii Europejskiej

Urządzenie jest zgodne z następującymi dyrektywami: Dyrektywa kompatybilności elektromagnetycznej 2014/30/UE, Dyrektywa niskonapięciowej 2014/35/UE, Dyrektywa urządzeń radiowych 2014/53/UE, Dyrektywa RoHS 2011/65/UE i dyrektywa 2015/863.

Niniejsze urządzenie zostało poddane testom i stwierdzono jego zgodność z wymaganiami dyrektywy.

#### ES Prohlášení o shodě

Toto zařízení splňuje požadavky Směrnice o Elektromagnetické kompatibilitě 2014/30/EU, Směrnice o Nízkém napětí 2014/35/EU, Směrnice o rádiových zařízeních 2014/53/EU, Směrnice RoHS 2011/65/EU a 2015/863.

Tento produkt byl testován a bylo shledáno, že splňuje všechny základní požadavky směrnic.

#### EK megfelelési nyilatkozata

A termék megfelelnek az alábbi irányelvek és szabványok követelményeinek, azok a kiállításiidőpontjában érvényes, aktuális változatában: EMC irányelv 2014/30/EU, Kisfeszültségű villamos berendezésekre vonatkozó irányelv 2014/35/EU, rádióberendezések irányelv 2014/53/EU, RoHS irányelv 2011/65/UE és 2015/863.

#### Δήλωση συμμόρφωσης EE

Είναι σε συμμόρφωση με τις διατάξεις των παρακάτω Οδηγιών της Ευρωπαϊκής Κοινότητας: Οδηγία 2014/30/ΕΕ σχετικά με την ηλεκτρομαγνητική συμβατότητα, Οδηγία χαμηλής τάσης 2014/35/ΕΕ, Οδηγία 2014/53/ΕΕ σε ραδιοεξοπλισμό, Οδηγία RoHS 2011/65/ΕΕ και 2015/863.

Η συμμόρφωση με αυτές τις οδηγίες αξιολογείται χρησιμοποιώντας τα ισχύοντα εναρμονισμένα ευρωπαϊκά πρότυπα.

**European Community Radio Equipment Directive Compliance Statement:**

This equipment complies with all the requirements and other relevant provisions of Radio Equipment Directive 2014/53/EU. This equipment is suitable for home and office use in all the European Community Member States and EFTA Member States. The low band 5.15 -5.35 GHz is for indoor use only.

 	AT	BE	BG	CH	CY	CZ	DE
	DK	EE	EL	ES	FI	FR	HR
	HU	IE	IS	IT	LI	LT	LU
	LV	MT	NL	PL	PT	RO	SE
	SI	SK	TR	UK			

**Taiwan NCC Wireless Statements / 無線設備警告聲明：**

低功率電波輻射性電機管理辦法

- 取得審驗證明之低功率射頻器材，非經核准，公司、商號或使用者均不得擅自變更頻率、加大功率或變更原設計之特性及功能。低功率射頻器材之使用不得影響飛航安全及干擾合法通信；經發現有干擾現象時，應立即停用，並改善至無干擾時方得繼續使用。前述合法通信，指依電信管理法規定作業之無線電通信。低功率射頻器材須忍受合法通信或工業、科學及醫療用電波輻射性電機設備之干擾。
- 應避免影響附近雷達系統之操作。

**Korea KCC NCC Wireless Statement:**

5.25GHz - 5.35 GHz 대역을 사용하는 무선 장치는 실내에서만 사용하도록 제한됩니다.

**Japan Wireless Statement:**







5.15 GHz 帯 ~ 5.35 GHz 帯: 屋内のみの使用。

**Wireless module country approvals:**









To identify your Motherboard version or revision number, look for "REV: X.X" printed on the PCB on the top left corner of the Motherboard. For example, "REV:1.0" means the revision of the motherboard is 1.0..

Motherboard revision no.:	Wireless module manufacturer, model name:
Z690 UD AC rev. 1.0	Intel® Corporation 9560NGW
Z690 UD AX rev. 1.0	Intel® Corporation AX201NGW
Z690 UD AX DDR4 rev. 1.0	Intel® Corporation AX201NGW

**Country approvals for wireless module 9560NGW:**

United States: FCC: PD99560NG	Japan:  003-170126 D17008003 5.15~5.35GHz indoor use only	Serbia:  H011 17
Canada: IC: 1000M-9560NG		Singapore Complies with IDA standards DB 02941
Australia & New-Zealand: 		Mexico: RCPIN9517-1584
China: CMIIT ID: 2017AJ4643 (M)	South Korea:  MSIP-CRM-INT-9560NGW	Taiwan:  CCAH18LP0140T0
European Union: 	1.상호명: Intel Corporation 2.기자재의 명칭(모델명): 특정소출력 무선기기 (무선전력 포함할 무선접속시스템용 무선기기) 9560NGW 3.제조사기: 2017/07 4.제조자/제조국: Intel Corporation/China	UAE: ER57050/17
India: 2.4GHz: NR-ETA/6863 5GHz: NR-ETA/6862		Ukraine:  UA.TR.028

**Country approvals for wireless module AX201NGW:**

United States: FCC: PD9AX201NG	India: 2.4GHz: NR-ETA/201900296 5GHz: NR-ETA/201900295	Singapore Complies with IDA standards DB 02941	Ukraine:  UA.TR.028
Canada: IC: 1000M-AX201NG	Japan:  003-180232 D180131003 5.15~5.35GHz indoor use only	South Korea:  R-C-INT-AX201NGW 1.상호명: Intel Corporation 2.기자재의 명칭(모델명): 특정소출력 무선기기 (무선전력 포함할 무선접속시스템용 무선기기) AX201NGW 3.제조사기: 2018/11 4.제조자/제조국: Intel Corporation / China	
Australia & New-Zealand: 			Mexico: RCPINAX18-2041 (provisional Nov.23,2019)
Belarus: 	Pakistan APPROVED by PTA: 9.9116/2019	Taiwan:  CCAH19LP8510T3	
China: CMIIT ID: 2018AJ7550 (M)	Serbia:  H011 19		
European Union: 			











## Contact Us

---

### GIGA-BYTE TECHNOLOGY CO., LTD.

Address: No.6, Baoqiang Rd., Xindian Dist., New Taipei City 231, Taiwan

TEL: +886-2-8912-4000, FAX: +886-2-8912-4005

Tech. and Non-Tech. Support (Sales/Marketing) : <https://esupport.gigabyte.com>

WEB address (English): <https://www.gigabyte.com>

WEB address (Chinese): <https://www.gigabyte.com/tw>

---

- **GIGABYTE eSupport**

To submit a technical or non-technical (Sales/Marketing) question, please link to:  
<https://esupport.gigabyte.com>

The screenshot shows the GIGABYTE eSupport landing page. At the top left is the GIGABYTE logo. The main heading is "Welcome to eSupport" in blue. Below it is a sub-heading: "Submit your product/sponsorship/marketing questions or inquiries, and our representative will respond in a timely fashion." The page is divided into three main sections: 1. NEWS: A box with the text "Your submissions will be displayed in your personal page, log in to see the processing status." 2. SIGN IN: A login form with fields for "Account" and "Password", a "SIGN IN" button, and links for "Register" and "Forgot Password". It also features "sign in with" options for Facebook, Google, Twitter, and Microsoft. 3. QUICK LINK: A section with three icons and labels: "Downloads", "FAQ", and "Warranty".