

EasyCut 23/18V P4A
Art. 14700

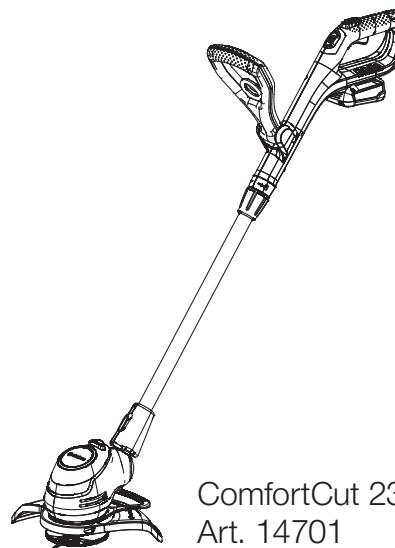

ComfortCut 23/18V P4A
Art. 14701

A1

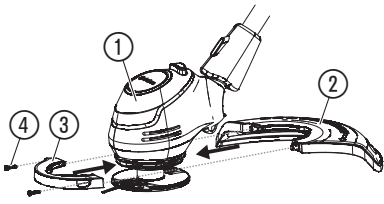

A2

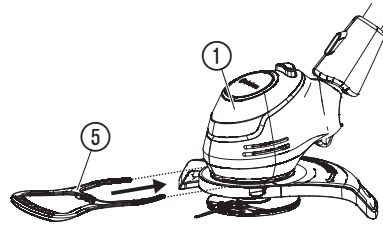

A3

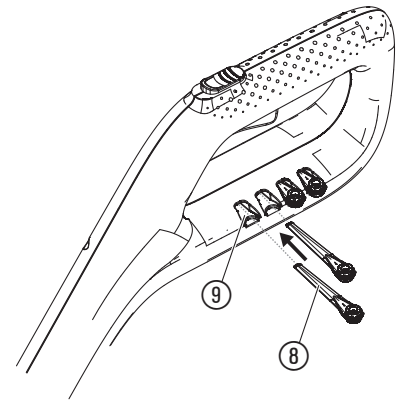

O1

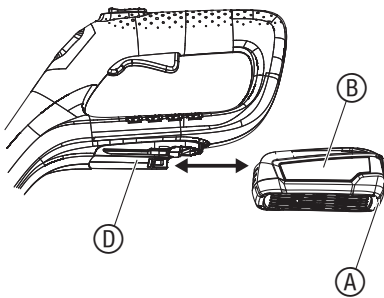

O2

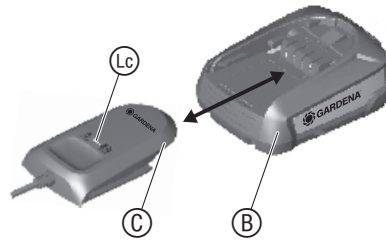

O4

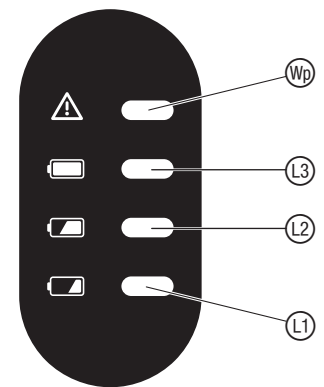

O3

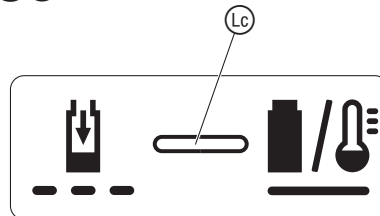

O5



O6

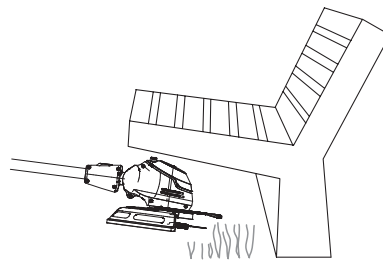

O7

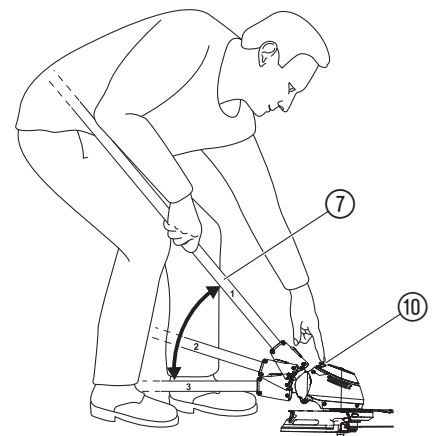

O8

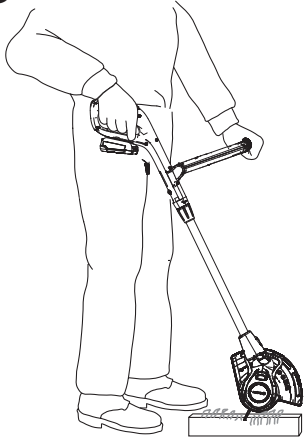

O10

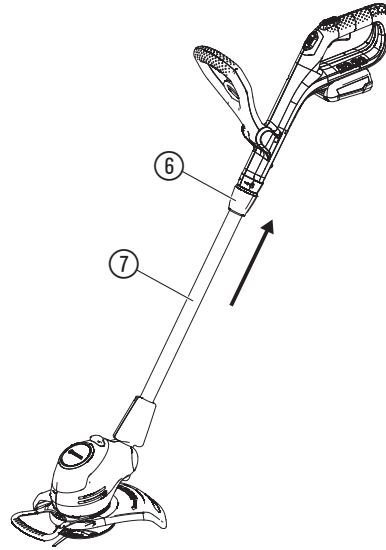

O11

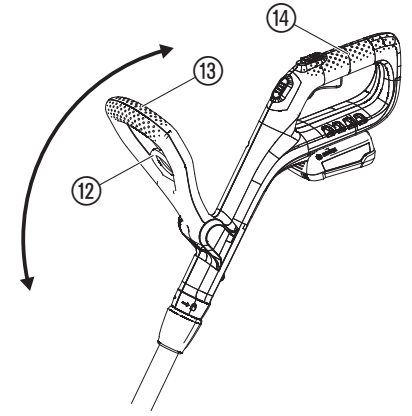

O9

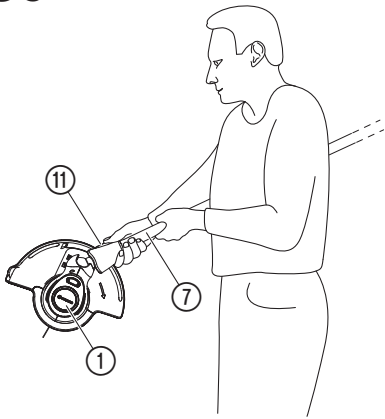

O12

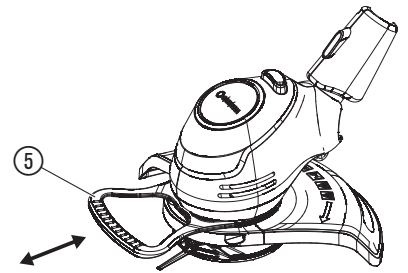

O13

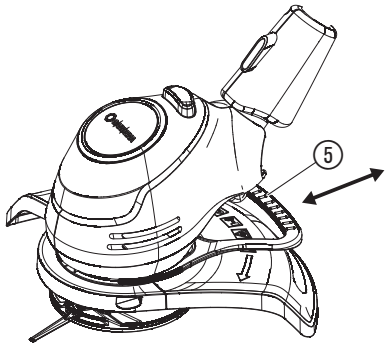

O14

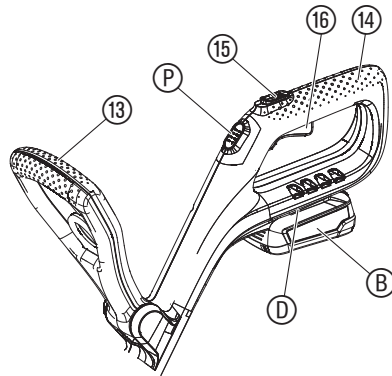

M1

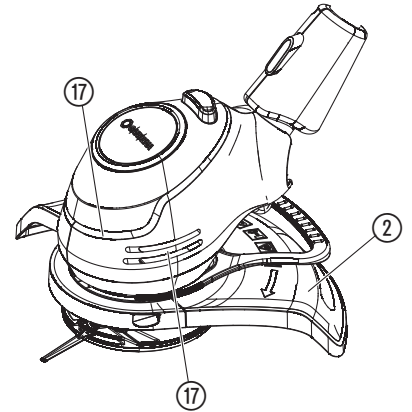

T1

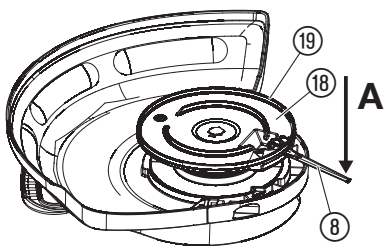

T2

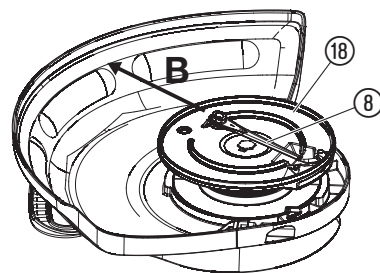

EN Battery Trimmer

1. SAFETY	4
2. ASSEMBLY	5
3. OPERATION	5
4. MAINTENANCE	6
5. STORAGE	7
6. TROUBLESHOOTING	7
7. TECHNICAL DATA	7
8. ACCESSORIES	7
9. SERVICE/WARRANTY	8

Original instructions.

 This product may be used under supervision, or if instruction regarding the safe use of the product has been provided and the resulting dangers have been understood, by children aged 8 and above, as well as by persons with physical, sensory or mental disabilities or a lack of experience and knowledge. Children must not be allowed to play with the product. Cleaning and user maintenance must not be performed by children without supervision. The use of this product by young people under the age of 16 is not recommended.

Intended use:

The **GARDENA Trimmer** is intended to trim and to cut lawn and areas of grass in private domestic gardens and allotments.

The product is not intended for long term use.

 **DANGER! Risk of injury!**
→ Do not use the product to cut hedges, to chop up material or to make compost.

1. SAFETY

IMPORTANT!
Read the operator's manual carefully before use and keep for future reference.

Symbols on the product:



Read operator's manual.



Keep bystanders away.



Always wear approved hearing protection.
Always wear approved eye protection.



Remove the Battery before cleaning or maintenance.



Do not expose to rain.

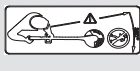

DANGER! Risk of injury to other people!
Keep other people out of the area where you are working.



For the charger:
Remove plug from the mains immediately if the cable is damaged or cut.

General safety warnings

Electrical safety



DANGER! Electric shock!

Risk of injury due to electric shock.

→ The product must be supplied through a residual current device (RCD) having a rated residual operating current not exceeding 30 mA.

Do not overreach and keep the balance at all times. Always be sure of the footing on slopes. Walk, never run.

Do not touch moving hazardous parts before the machine is disconnected from the mains and the moving hazardous parts have come to a complete stop.

Always wear substantial footwear and long trousers while operating the machine.

Safe operating practices

1 Training

- Read the instructions carefully. Be familiar with the controls and the correct use of the machine.
- Never allow children or people unfamiliar with these instructions to use the machine. Local regulations can restrict the age of the operator.
- Keep in mind that the operator or user is responsible for accidents or hazards occurring to other people or their property.

2 Preparation

- Before use check the supply and extension cord for signs of damage or aging. If the cord becomes damaged during use, disconnect the cord from the supply immediately. **DO NOT TOUCH THE CORD BEFORE DISCONNECTING THE SUPPLY.** Do not use the machine if the cord is damaged or worn.
- Before use, always visually inspect the machine for damaged, missing or misplaced guards or shields.
- Never operate the machine while people, especially children, or pets are nearby.

3 Operation

- Keep supply and extension cords away from cutting means.
- Wear eye protection and stout shoes at all times while operating the machine.
- Avoid using the machine in bad weather conditions especially when there is a risk of lightning.
- Use the machine only in daylight or good artificial light.
- Never operate the machine with damaged guards or shields or without guards or shields in place.
- Switch on the motor only when the hands and feet are away from the cutting means.
- Always disconnect the machine from the power supply (i.e. remove the plug from the mains, remove the disabling device or removable battery)
 - whenever the machine is left unattended;
 - before clearing a blockage;
 - before checking, cleaning or working on the machine;
 - after striking a foreign object;
 - whenever the machine starts vibrating abnormally.
- Take care against injury to feet and hands from the cutting means.
- Always ensure that the ventilation openings are kept clear of debris.

4 Maintenance and storage

- Disconnect the machine from the power supply (i.e. remove the plug from the mains, remove the disabling device or removable battery) before carrying out maintenance or cleaning work.
- Use only the manufacturer's recommended replacement parts and accessories.
- Inspect and maintain the machine regularly. Have the machine repaired only by an authorized repairer.
- When not in use, store the machine out of the reach of children.

Additional safety warnings

Battery safety



Read all the safety and general instructions.

Failure to observe the safety and general instructions may result in electric shock, fire and/or serious injury.

Store these instructions in a safe place. Only use the charger if you can fully evaluate all functions and carry them out without restrictions, or if you have received corresponding instructions.

→ **Supervise children during use, cleaning and maintenance.**

This will ensure that children do not play with the charger.

→ **Charge only lithium-ion batteries of the POWER FOR ALL system type PBA 18V with a capacity of 1.5 Ah or more (5 battery cells or more). The battery voltage must match the battery charging voltage of the charger. Do not charge any nonrechargeable batteries.** Otherwise there is a risk of fire and explosion.

→  **Do not expose the charger to rain or wet conditions.**

Water entering a power tool will increase the risk of electric shock.

→ **Keep the charger clean.** Dirt poses a risk of electric shock.

→ **Always check the charger, cable and plug before use. Stop using the charger if you discover any damage. Do not open the charger yourself, and have it repaired only by a qualified specialist using only original replacement parts.**

Damaged chargers, cables and plugs increase the risk of electric shock.

→ **Do not operate the charger on an easily ignited surface (e.g. paper, textiles, etc.) or in a flammable environment.**

There is a risk of fire due to the charger heating up during operation.

→ In order to avoid safety hazards, if the power supply cord needs to be replaced, this must be done by GARDENA or by a customer service centre that is authorised to repair GARDENA power tools.

→ **Do not operate the product while it is charging.**

Products sold in GB only: Your product is fitted with an BS 1363/A approved electric plug with internal fuse (ASTA approved to BS 1362). If the plug is not suitable for your socket outlets, it should be cut off and an appropriate plug fitted in its place by an authorised customer service agent. The replacement plug should have the same fuse rating as the original plug. The severed plug must be disposed of to avoid a possible shock hazard and should never be inserted into a mains socket elsewhere.

→ **These safety warnings apply only for lithium-ion batteries of the POWER FOR ALL system PBA 18V.**

→ **Only use the battery with products of the POWER FOR ALL system manufacturers.** This is the only way in which you can protect the battery against dangerous overload.

→ **Recharge only with the charger specified by the manufacturer.**

A charger that is suitable for one type of battery pack may create a risk of fire when used with another battery pack.

→ **The battery is supplied partially charged.**

To ensure full battery capacity, fully charge the battery in the charger before using your power tool for the first time

→ **Keep battery packs out of the reach of children.**

→ **Do not open the battery.** There is a risk of short-circuiting.

→ **In case of damage and improper use of the battery, vapours may be emitted. The battery can set alight or explode.**

Ensure the area is well ventilated and seek medical attention should you experience any adverse effects. The vapours may irritate the respiratory system.

→ **If used incorrectly or if the battery is damaged, flammable liquid may be ejected from the battery. Contact with this liquid should be avoided. If contact accidentally occurs, rinse off with water. If the liquid comes into contact with your eyes, seek additional medical attention.** Liquid ejected from the battery may cause irritation or burns.

→ **If the battery is damaged liquid can be ejected and cover nearby surfaces. Check affected parts.**

Clean these parts or change them if necessary.

→ **Do not short-circuit the battery pack. When the battery pack is not in use, keep it away from other metal objects, like paper clips, coins, keys, nails, screws or other small metal objects, that can make a connection from one terminal to another.** Shorting the battery terminals together may cause burns or a fire.

→ **The battery can be damaged by pointed objects such as nails or screwdrivers or by force applied externally.** An internal short circuit may occur, causing the battery to burn, smoke, explode or overheat.

→ **Never service damaged battery packs.** Service of battery packs should only be performed by the manufacturer or authorized service providers.

→  **Protect the battery against heat, e.g. against continuous intense sunlight, fire, dirt, water and moisture.**



There is a risk of explosion and short-circuiting.

→ **Only operate and store the battery at an ambient temperature between -20 °C and +50 °C.**

Do not leave the battery in your car in the summer, for example. At temperatures of <0 °C some devices may experience a loss of power.

→ **Only charge the battery at an ambient temperature which is between 0 °C and +45 °C.** Charging outside of this temperature range can increase the risk of damage to the battery and pose a fire hazard.

Electrical safety



DANGER! Cardiac arrest!

This product makes an electromagnetic field while it operates. This field may under some conditions interfere with active or passive medical implants. To decrease the risk of conditions that can possibly injure or kill, we recommend persons with medical implants to speak with their physician and the medical implant manufacturer before you operate the product.

Only use the battery product between 0 °C to 40 °C.

Disconnect the battery in case of emergency.

Do not use the product nearby a water, or for pond care.

Protect the battery contacts from moisture.

Personal safety



DANGER! Risk of suffocation!

Small parts can be easily swallowed. There is also a risk that the poly-bag can suffocate toddlers. Keep toddlers away when you assemble the product.

If the trimmer vibrates heavily, replace the blade and check the blade holder for damage.

Check the wear rib if ok before usage.

Use the front handle to transport the trimmer.

Use personal protective equipment.

Wear gloves for cleaning the cutting device.

Always wear eye protection.

Protective equipment such as gloves, non-skid safety shoes, or hearing protection used for appropriate conditions will reduce personal injuries.

Be careful during adjustment of the product to prevent entrapment of the fingers between moving and fixed parts of the machine, or while assembling the protective cover.

Don't use water, or chemical substances for cleaning the guard or other parts of the trimmer.

Keep all nuts, bolts and screws tight to be sure the product is in a safe working condition.

Do not disassemble the product further than the delivery status.

Warning! When wearing hearing protection, and due to the noise produced by the product, the operator may not notice persons approaching.

While operation and transport pay special attention to the hazard for other people.

Stay alert, watch what you are doing and use common sense when operating a power tool.

Do not use a power tool while you are tired or under the influence of drugs, alcohol or medication.

A moment of inattention while operating power tools may result in serious personal injury.

2. ASSEMBLY



DANGER! Risk of injury!

Cut injury when the product starts accidentally.

→ **Wait for the plastic blades to stop and remove the battery before you assemble the product.**

To assemble the protective cover and the plant guard [Fig. A1/A2]:



DANGER!

→ **The product may only be used when the protective cover is assembled.**

- Slide the front part of the protective cover ③ onto the trimmer head ① until it engages.
- Slide the rear part of the protective cover ② onto the trimmer head ① until it stops.
- Tighten the both screws ④ carefully.
- Slide the plant guard ⑤ onto the trimmer head ① until it engages.

To attach the plastic blade to handle [Fig. A3]:

The scope of delivery includes 5 plastic blades. There are 4 spare plastic blades in the openings ⑨ on the handle.

For the assembly of the plastic blade into the blade holder, see 6. TROUBLESHOOTING *To replace the plastic blade.*

3. OPERATION



DANGER! Risk of injury!

Cut injury when the product starts accidentally.

→ **Wait for the plastic blade to stop and remove the battery before you adjust or transport the product.**

To charge the battery [Fig. O1/O2/O3]:



CAUTION!

→ **Note the mains voltage!** The voltage of the power source must match the voltage specified on the rating plate of the charger.

Thanks to the intelligent charging process, the charge condition of the battery is automatically detected and then charged up with the optimal charge current depending on battery temperature and voltage.

In this way, the battery is treated with care and remains permanently fully charged when it is stored in the charger.

- Push the locking button ① and remove the battery ② from the battery holder ③.
- Connect the battery charger ④ into a mains socket.
- Slide the battery charger ④ onto the battery ②.

When the battery charge indicator (L) at the charger flashes green the battery is being charged.

When the battery charge indicator (L) at the charger illuminates permanently green the battery is completely charged (Charging time, see 7. TECHNICAL DATA).

- Examine the charge status regularly while you charge.
- When the battery (B) is completely charged, you can disconnect the battery (B) from the charger (C).

Meaning of the Indication Elements:

Indication on the charger [Fig. O3]:

Flashing of the Battery Charge Indicator (L) The charging procedure is indicated by flashing of the battery charge indicator (L).



Note: The charging procedure is only possible when the battery temperature is within the allowable charging temperature range, see 7. TECHNICAL DATA.

Continuous Lighting of the Battery Charge Indicator (L)



Continuous lighting of the battery charge indicator (L) indicates that the battery is fully charged or that the temperature of the battery is not within the allowable charging temperature range and can therefore not be charged.

When the battery is not inserted, **continuous lighting** of the battery charge indicator (L) indicates that the mains plug is inserted in the socket outlet and that the battery charger is ready for operation.

Battery charge status indication (P) on the product [Fig. O4/O14]:
After starting the product, the battery charge status indication (P) is displayed for 5 seconds.

Battery charge status	Battery charge status indication
67 – 100 % charged	(1), (2) and (3) illuminate green
34 – 66 % charged	(1) and (2) illuminate green
11 – 33 % charged	(1) illuminates green
0 – 10 % charged	(1) flashes green

If the LED (1) flashes green, the battery must be charged.

If the error LED (9) is illuminated or flashing, see 6. TROUBLESHOOTING.

To set the working position:

Working position 1 [Fig. O5]:

For standard trimming.

Working position 2 [Fig. O6/O7]:

Trimming beneath obstacles

The tube can be lowered from standard position 1 to two lowered positions 2 or 3 for trimming beneath obstacles.

- Put the trimmer on the floor.
- Hold the trimmer by the tube (7) with both hands so that you can push the unlock button (10) with one finger.
- Push the unlock button (10) and lower the tube (7) to the required position.
- Release the unlock button (10) and let the tube (7) engage again.

Working position 3 (only for Art. 14701) [Fig. O8/O9]:

Cutting at lawn edges.

CAUTION! The trimmer may only be used when the trimmer head is locked at 0° or 90°.

To rotate the trimmer head (1) to 90°, the tube must be in standard position 1.

- Hold the trimmer by the tube (7) with both hands so that you can push the unlock button (11) with one finger.
- Push the unlock button (11) and rotate the trimmer head (1) from 0° to 90° until it engages.
- Release the unlock button (11) and let the tube (7) engage again.

To adjust the tube length [Fig. O10]:



DANGER!

The product must not be used when the tube is completely inserted (transport position).

- Loosen the clamping sleeve (6).
- Pull out the tube (7) to the required length.
- Tighten the clamping sleeve again (6).

To adjust the position of the additional handle [Fig. O11]:

The position of the additional handle can be adjusted to your body height.

- Pull the lever (2).
- Tilt the additional handle (13) to the desired position.
- Release the lever (2) again.

If the trimmer is correctly set to the body height, the posture is upright and the trimmer head in working position 1 is tilted forwards slightly.

→ Hold the trimmer by the main handle (14) and additional handle (13) in such a manner that the trimmer head is tilted forwards slightly.

To adjust the plant guard:

– **Work position [Fig. O12]**

– **Park position [Fig. O13]**

→ Pull off the plant guard (5) and put it on into the required position until it engages.

To start the trimmer [Fig. O1/O14]:



DANGER! Risk of injury!

Risk of injury if the product does not stop when you release the start lever.

→ Do not bypass the safety devices or switches. For example do not attach the start lever to the handle.

The product is provided with a two-switch safety device (start lever with starting lockout) to prevent the product from being turned on by accident.

To start:

- Put the battery (B) into the battery holder (D) until it audibly engages.
- Hold the additional handle (13) with one hand.
- Hold the main handle (14) with the other hand, slide the starting lockout (15) forward and pull the start lever (16).
The trimmer starts and the battery charge status indication (P) is displayed for 5 seconds.
- Release the starting lockout (15) again.

CAUTION! Avoid contact of the plastic blade and the blade carrier with hard objects (walls, stones fences etc.) to prevent the plastic blade and the blade carrier from wearing or breaking.

To stop:

- Release the start lever (16).
The trimmer stops.
- Push the locking button (A) and remove the battery (B) from the battery holder (D).

4. MAINTENANCE



DANGER! Risk of injury!

Cut injury when the product starts accidentally.

→ Wait for the plastic blade to stop and remove the battery before you maintain the product.

To clean the trimmer [Fig. M1]:



DANGER! Risk of injury!

Risk of injury and risk of damage to the product.

→ Do not clean the product with water or with a water jet (in particular high-pressure water jet).

→ Do not clean with chemicals including petrol or solvents. Some can destroy critical plastic parts.

The airflow slots must always be clean.

- Clean the airflow slots (17) with a soft brush (do not use a screwdriver).
- Clean all movable parts after each operation. Especially remove any grass and dirt from the protective cover (2).

To clean the battery and the battery charger:

Make sure that the surface and the contacts of the battery and the battery charger always are clean and dry before you connect the battery charger.

Do not use running water.

→ **Battery charger:** Clean the contacts and the plastic parts with a soft and dry cloth.

→ **Battery:** Occasionally clean the ventilation slots and the terminals on the battery using a soft brush that is clean and dry.

5. STORAGE

To put into storage:

The product must be stored away from children.

1. Remove the battery.
2. Charge the battery.
3. Clean the trimmer, the battery and the battery charger (see 4. MAINTENANCE).
4. Store the trimmer, the battery and the battery charger in a dry, enclosed and frost-free place.

Disposal:

(in accordance with RL2012/19/EC)



The product must not be disposed of to normal household waste. It must be disposed of in line with local environmental regulations.

IMPORTANT!

→ Dispose of the product through or via your municipal recycling collection centre.

Disposal of the battery:



The GARDENA battery contains lithium-ion cells that should not be disposed of with normal household waste at the end of its life.

Li-ion

IMPORTANT!

→ Dispose of the batteries through or via your municipal recycling collection centre.

1. Discharge the lithium-ion cells completely (contact the GARDENA Service).
2. Protect the contacts on the lithium-ion cells against short circuits.
3. Dispose of the lithium-ion cells properly.

6. TROUBLESHOOTING



DANGER! Risk of injury!

Cut injury when the product starts accidentally.

→ Wait for the plastic blade to stop and remove the battery before you troubleshoot the product.

To replace the plastic blade [Fig. T1/T2]:



DANGER! Risk of cutting injuries!

→ Do not use metal cutting elements or spare parts and accessories not intended for use by GARDENA.

If the wear rib ¹⁹ is no longer visible, the blade carrier ¹⁶ must be replaced. Contact the GARDENA Service.

The plastic blades may only become worn to half the original length at most. Only use original GARDENA Spare Blades RotorCut. Spare plastic blades are available from your GARDENA dealer or directly from GARDENA Service.

- GARDENA Spare Blades RotorCut for Turbotrimmer Art. 5368

To remove the plastic blade:

1. Turn the trimmer over.
2. Push the end of the plastic blade down slightly (A), slide the plastic blade ⁸ inside through the blade carrier ¹⁶ (B) and pull out.

To insert the plastic blade:

→ Slide the new plastic blade ⁸ from inside through the slot in metal of the blade carrier ¹⁶ until it audibly engages (click).
When the new plastic blade is correctly inserted, it can be moved more easily.

Problem	Possible Cause	Remedy
Trimmer is not cutting cleanly or not cutting at all	Plastic blade is worn or too short.	→ Replace the plastic blade.
	Plastic blade is broken off.	→ Replace the plastic blade.
Trimmer vibrates severely	Plastic blade is excessively worn and creates an unbalance.	→ Replace the plastic blade.
	Blade carrier is worn.	→ Replace the blade carrier.

Problem	Possible Cause	Remedy
Trimmer can no longer be stopped	Start lever is stuck.	→ Remove the battery and loosen the start lever
Trimmer does not start or stops. LED ¹³ is flashing green [Fig. 04]	Battery is empty.	→ Charge the battery.
Trimmer does not start or stops. Error-LED ¹⁰ is illuminated red [Fig. 04]	Battery temperature is outside the permissible temperature range.	→ Wait until the battery temperature is between 0 °C – +45 °C again.
	There are drops of water or moisture between the battery contacts on the trimmer.	→ Remove the water drops/moisture with a dry cloth.
	Engine is blocked.	→ Remove the obstacle. Start again.
Trimmer does not start or stops. Error-LED ¹⁰ is flashing red [Fig. 04]	Product is defective.	→ Contact the GARDENA Service.
Trimmer does not start or stops. Error-LED ¹⁰ is not illuminated [Fig. 04]	Battery is not put completely into the battery holder.	→ Put the battery completely into the battery holder until it audibly engages.
	Battery is defective.	→ Replace the battery.
	Product is defective.	→ Contact the GARDENA Service.
Charging is not possible. Battery charge indicator ¹² is continuously illuminated [Fig. 03]	The battery is not connected (correctly).	→ Connect the battery to charger correctly.
	Battery contacts are dirty.	→ Clean the battery contacts (e.g. by connecting and disconnecting the battery several times. Replace the battery if necessary.
	Battery temperature is outside the permissible charging temperature range.	→ Wait until the battery temperature is between 0 °C – +45 °C again.
	Battery is defective.	→ Replace the battery.
Battery charge indicator ¹² is not illuminated [Fig. 03]	Mains plug of the charger is not (correctly) plugged in.	→ Insert the mains plug into the mains socket (completely).
	Socket outlet, mains cable or charger is defective.	→ Check the mains voltage. Let the charger be checked if necessary by an authorised specialist dealer or the GARDENA Service.



NOTE: For any other malfunctions please contact the GARDENA service department. Repairs must only be done by GARDENA service departments or specialist dealers approved by GARDENA.

7. TECHNICAL DATA

Battery Trimmer	Unit	Value (Art. 14700)	Value (Art. 14701)
Rated current	A	2.3	2.3
Rated voltage	V (DC)	18	18
Cutting width	cm	23	23
Rpm of blade carrier	R/min.	9500	9500
Weight (without Battery)	kg	2.0	2.1
Sound pressure level L_{pA} ¹⁾	dB (A)	74	74
Uncertainty k_{pA}		2.5	2.5
Sound power level L_{WA} ²⁾ : measured / guaranteed	dB (A)	83 / 85	86 / 88
Uncertainty k_{WA}		1.6	1.8
Hand/arm vibration a_{vhw} ¹⁾	m/s ²	< 2.5	< 2.5
Uncertainty k_{vhw}		1.5	1.5

Measuring process complying with: ¹⁾ EN 50636-2-91 ²⁾ RL 2000/14/EC



NOTE: The stated vibration emission value has been measured according to a standardised test procedure and can be used for comparison of one electric power tool with another. It can also be used for preliminary evaluation of exposure. The vibration emission value can vary during actual use of the electric power tool.

8. ACCESSORIES

GARDENA Spare Blades RotorCut for Turbotrimmer	As replacement for consumed plastic blades.	Art. 5368
------------------------------------------------	---------------------------------------------	-----------

GARDENA Replacement blade carrier	Available via the GARDENA Service.	
GARDENA Wheel set for trimmer (only for Art. 14701)	For easy cutting of lawn edges.	Art. 9880
GARDENA System Battery PBA 18V/36 P4A PBA 18V/45 P4A PBA 18V/72 P4A	Battery for additional duration or for replacement.	Art. 14902 Art. 14903 Art. 14905
GARDENA Battery Charger AL 1810 CV P4A		Art. 14900-28 (UK) Art. 14900-52 (AU/NZ)
GARDENA Battery Quick Charger AL 1830 CV P4A	Charger for fast charging the POWER FOR ALL system Batteries PBA 18V..W-..	Art. 14901-28 (UK) Art. 14901-52 (AU/NZ)

9. SERVICE/WARRANTY

Service:

Please contact the address on the back page.

Warranty statement:

In the event of a warranty claim, no charge is levied to you for the services provided.

GARDENA Manufacturing GmbH grants a warranty for all original GARDENA new products for two years from the date of original purchase from the retailer, provided that the devices have been for private use only. This manufacturer's warranty does not apply to products acquired second hand. This warranty includes all significant defects of the product that can be proved to be material or manufacturing faults. This warranty is fulfilled by supplying a fully functional replacement product or by repairing the faulty product sent to us free of charge; we reserve the right to choose between these options. This service is subject to the following provisions:

- The product has been used for its intended purpose as per the recommendations in the operating instructions.
- Neither the purchaser nor a third party has attempted to open or repair the product.
- Only Original GARDENA replacement parts and wear parts have been used for operation.
- Presentation of the receipt.

Normal wear and tear of parts and components (such as blades, blade fixing parts, turbines, light bulbs, V-belts/toothed belts, impellers, air filters, spark plugs), visual changes, wear parts and consumables are excluded from the warranty.

This manufacturer's warranty is limited to replacement and repair of products in accordance with the abovementioned conditions. The manufacturer's warranty does not constitute an entitlement to lodge other claims against us as a manufacturer, such as for damages. This manufacturer's warranty does **not**, of course, affect statutory and contractual warranty claims against the dealer/retailer.

The manufacturer's warranty is governed by the law of the Federal Republic of Germany.

In case of a warranty claim, please return the faulty product, together with a copy of the receipt and a description of the fault, with postage paid to the service address.

Consumables:

The plastic blade and the blade carrier are consumables and are not included in the warranty.

Deutschland / Germany

GARDENA
Manufacturing GmbH
Central Service
Hans-Lorenser-Straße 40
D-89079 Ulm
Produktfragen:
(+49) 731 490-123
Reparaturen:
(+49) 731 490-290
service@gardena.com
http://www.gardena.com

Albania

KRAFT SHPK
Autostrada Tirane-Durres
Km 7
1051 Tirane

Argentina

ROBERTO C. RUMBO S.R.L.
Predio Norlog
Lote 7
Benavidez. ZC:1621
Buenos Aires
ventas@rumbosrl.com.ar

Australia

Husqvarna Australia Pty. Ltd.
Locked Bag 5
Central Coast BC
NSW 2252
Phone: (+61) (0) 2 4352 7400
customer.service@
husqvarna.com.au

Austria / Österreich

Husqvarna Austria GmbH
Industriezeile 36
4010 Linz
Tel.: (+43) 732 77 01 01-485
service.gardena@
husqvarnagroup.com

Azerbaijan

Firm Progress
a. Aliyev Str. 26A
1052 Baku

Belarus

Private Enterprise
"Master Garden"
Minsk
Sharangovich str., 7a
Phone: (+375) 17 257-00-33
Mob.: (+375) 29 676-16-09
mg@mastergarden.by

Belgium

Husqvarna Belgium nv
Gardena Division
Leuvensesteenweg 542
Planet II E
1930 Zaventem
België

Bosnia / Herzegovina

SILK TRADE d.o.o.
Industrijska zona Bukva bb
74260 Tešanj

Brazil

Husqvarna do Brasil Ltda
Av. Francisco Matarazzo,
1400 - 19º andar
São Paulo - SP
CEP: 05001-903
Tel: 0800-112252
marketing.br.husqvarna@
husqvarna.com.br

Bulgaria

AGROLAND България АД
бул. 8 Декември, №13
Офис 5
1700 Студентски град
София
Тел.: (+359) 2466 69 10
info@agroland.eu

Canada / USA

GARDENA Canada Ltd.
100 Summerlea Road
Brampton, Ontario L6T 4X3
Phone: (+1) 905 792 93 30
info@gardenacanada.com

Chile

REPRESENTACIONES
JCE S.A.
Av. Del Valle Norte 857,
Piso 4
Santiago RM
Phone: (+56) 2 24142560
contacto@jce.cl

China

Husqvarna (Shanghai)
Management Co., Ltd.
富世华 (上海) 管理有限公司
3F, Benq Square B,
No207, Song Hong Rd.,
Chang Ning District,
Shanghai
PRC. 200335
上海市长宁区淞虹路207号明
基广场B座3楼, 邮编: 200335

Colombia

Husqvarna Colombia S.A.
Calle 18 No. 68 D-31, zona
Industrial de Montevideo
Bogotá, Cundinamarca
Tel. 571 2922700 ext. 105
jairo.salazar@
husqvarna.com.co

Costa Rica

Compania Exim
Euroiberoamericana S.A.
Los Colegios, Moravia,
200 metros al Sur del Colegio
Saint Francis - San José
Phone: (+506) 297 68 83
exim_euro@racsa.co.cr

Croatia

Husqvarna Austria GmbH
Industriezeile 36
4010 Linz
Tel.: (+43) 732 77 01 01-485
service.gardena@
husqvarnagroup.com

Cyprus

Med Marketing
17 Digeni Akrita Ave
P.O. Box 27017
1641 Nicosia

Czech Republic

Husqvarna Česko s.r.o.
Türkova 2319/5b
149 00 Praha 4 - Chodov
Bezplatná infolinka:
800 100 425
servis@cz.husqvarna.com

Denmark

GARDENA DANMARK
Lejrvvej 19, st.
3500 Værløse
Tlf.: (+45) 70264770
husqvarna@husqvarna.dk
www.gardena.com/dk

Dominican Republic

BOSQUESA, S.R.L
Carretera Santiago Licey
Km. 5 ½
Esquina Copal II.
Santiago
Dominican Republic
Phone: (+809) 736-0333
joserbosquesa@claro.net.do

Ecuador

Husqvarna Ecuador S.A.
Arupos E1-181 y 10 de
Agosto Quito, Pichincha
Tel. (+593) 22800739
francisco.jacome@
husqvarna.com.ec

Estonia

Husqvarna Eesti OÜ
Valdeku 132
EE-11216 Tallinn
info@gardena.ee

Finland

Oy Husqvarna Ab
Gardena Division
Lautatarhankatu 8 B/PL 3
00581 HELSINKI
www.gardena.fi

France

Husqvarna France
9/11 Allée des pierres mayettes
92635 Gennevilliers Cedex
France
http://www.gardena.com/fr
N° AZUR: 0 810 00 78 23
(Prix d'un appel local)

Georgia

Transporter LLC
113b Belialshvili street
0159 Tbilisi, Georgia

Great Britain

Husqvarna UK Ltd
Preston Road
Aycliffe Industrial Park
Newton Aycliffe
County Durham
DL5 6UP
info.gardena@
husqvarna.co.uk

Greece

Π. ΠΑΠΑΔΟΠΟΥΛΟΣ ΑΕΒΕ
Λεωφ. Αθηνών 92
Αθήνα
T.K.104 42
Ελλάδα
Τηλ. (+30) 210 51 93 100
info@papadopoulos.com.gr

Hungary

Husqvarna Magyarország Kft.
Ezred u. 1-3
1044 Budapest
Telefon: (+36) 1 251-4161
vevoszolgalat.husqvarna@
husqvarna.hu

Iceland

BYKO ehf.
Bildshöfva 20
110 Reykjavik

Ireland

Husqvarna UK Ltd
Preston Road
Aycliffe Industrial Park
Newton Aycliffe
County Durham
DL5 6UP
info.gardena@
husqvarna.co.uk

Italy

Husqvarna Italia S.p.A.
Via Santa Vecchia 15
23868 VALMADRERA (LC)
Phone: (+39) 0341.203.111
assistenza.italia@
it.husqvarna.com

Japan

Husqvarna
Zenoah Co. Ltd. Japan
1-9 Minamidai, Kawagoe
350-1165 Saitama
Japan
gardena-jp@
husqvarnagroup.com

Kazakhstan

LAMED Ltd.
155/1, Tazhibayevoi Str.
050060 Almaty
IP Schmidt
Abayavenue 3B
110 005 Kostanay

Korea

Kyung Jin Trading CO.,LTD.
107-4, SunDuk Bld.,
YangJae-dong,
Seocho-gu,
Seoul, (zipcode: 137-891)
Phone: (+82) (0)2 574-6300

Latvia

Husqvarna Latvija SIA
Ulbrokas 19A
LV-1021 Riga
info@gardena.lv

Lithuania

UAB Husqvarna Lietuva
Ateities pl. 77C
LT-52104 Kaunas
info@gardena.lt

Luxembourg

Magasins Jules Neuberg
39, rue Jacques Stas
Luxembourg-Gasperich 2549
Case Postale No. 12
Luxembourg 2010
Phone: (+352) 40 14 01
api@neuberg.lu

Mexico

AFOSA
Av. Lopez Mateos Sur # 5019
Col. La Calma 45070
Zapopan, Jalisco
Mexico
Phone: (+52) 33 3818-3434
icornejo@afosa.com.mx

Moldova

Convel S.R.L.
290A Muncesti Str.
2002 Chisinau

Netherlands

Husqvarna Nederland B.V.
GARDENA Division
Postbus 50131
1305 AC ALMERE
Phone: (+31) 36 521 00 10
info@gardena.nl

Neth. Antilles

Jonka Enterprises N.V.
Sta. Rosa Weg 196
P.O. Box 8200
Curaçao
Phone: (+599) 9 767 66 55
pgm@jonka.com

New Zealand

Husqvarna New Zealand Ltd.
PO Box 76-437
Manukau City 2241
Phone: (+64) (0) 9 9202410
support.nz@husqvarna.co.nz

Norway

Husqvarna Norge AS
Gardena Division
Trøskenvæien 36
1708 Sarpsborg
info@gardena.no

Peru

Husqvarna Perú S.A.
Jr. Ramón Cárcamo 710
Lima 1
Tel: (+51) 1 3320 400 ext. 416
juan.remuzgo@
husqvarna.com

Poland

Husqvarna
Poland Spółka z o.o.
ul. Wysockiego 15 b
03-371 Warszawa
Phone: (+48) 22 330 96 00
gardena@husqvarna.com.pl

Portugal

Husqvarna Portugal, SA
Lagoa - Albarraque
2635 - 595 Rio de Mouro
Tel.: (+351) 21 922 85 30
Fax : (+351) 21 922 85 36
info@gardena.pt

Romania

Madex International Srl
Soseaua Odaii 117-123,
RO 013603 București, S1
Phone: (+40) 21 352.76.03
madex@ines.ro

Russia / Россия

ООО „Хускварна“
141400, Московская обл.,
г. Химки,
улица Ленинградская,
владение 39, стр.6
Бизнес Центр
„Химки Бизнес Парк“,
помещение ОВ02_04
http://www.gardena.ru

Serbia

Domel d.o.o.
Autoput za Novi Sad bb
11273 Belgrade
Phone: (+381) 1 18 48 88 12
miroslav.jejina@domel.rs

Singapore

Hy-Ray PRIVATE LIMITED
40 Jalan Pemimpin
#02-08 Tat Ann Building
Singapore 577185
Phone: (+65) 6253 2277
shiyong@hyray.com.sg

Slovak Republic

Husqvarna Česko s.r.o.
Türkova 2319/5b
149 00 Praha 4 - Chodov
Bezplatná infolinka: 800 154 044
servis@sk.husqvarna.com

Slovenia

Husqvarna Austria GmbH
Industriezeile 36
4010 Linz
Tel.: (+43) 732 77 01 01-485
service.gardena@
husqvarnagroup.com

South Africa

Husqvarna South Africa (Pty) Ltd
Postnet Suite 250
Private Bag X6,
Cascades, 3202, South Africa
Phone: (+27) 33 846 9700
info@gardena.co.za

Spain

Husqvarna España S.A.
Calle de Rivas nº 10
28052 Madrid
Phone: (+34) 91 708 05 00
atencioncliente@gardena.es

Suriname

Deto Handelmaatschappij N.V.
Kernkampweg 72-74
P.O.Box: 12782
Paramaribo - Suriname
South America
Phone: (+597) 438050
www.deto.sr

Sweden

Husqvarna AB/
GARDENA Sverige
Drottninggatan 2
561 82 Huskvarna Sverige

Switzerland / Schweiz

Husqvarna Schweiz AG
Consumer Products
Industriestrasse 10
5506 Mägenwil
Phone: (+41) (0) 62 887 37 90
info@gardena.ch

Turkey

Dost Bahçe Diş Ticaret
Mümessillik A.Ş
Yunus Mah. Adil Sok. No:3
Ic Kapi No: 1 Kartal
34873 Istanbul
Phone: (+90) 216 38 93 939
info@dostbahce.com.tr

Ukraine / Україна

ТОВ «Хускварна Україна»
вул. Васильківська, 34,
офіс 204-г
03022, м. Київ
Тел. (+38) 0 800 504 804
info@gardena.ua

Uruguay

FELI SA
Entre Ríos 1083 CP 11800
Montevideo - Uruguay
Tel: (+598) 22 03 18 44
info@felisa.com.uy

Venezuela

Corporación Casa y Jardín C.A.
Av. Caroní, Edif. Trezmen, PB.
Colinas de Bello Monte.
1050 Caracas.
Tlf: (+58) 212 992 33 22
info@casayjardin.net.ve

14700-56.960.01/0421
© GARDENA Manufacturing GmbH
D-89079 Ulm
http://www.gardena.com