



FESTOOL

Catalogue **2022**

Tools for the toughest demands



You can find all our new products on pages 2 to 5

Dear Festool customers,

Welcome to the new Festool main catalogue for 2022!
You are holding the whole world of Festool products and services in your hands.

Are you already familiar with our many new cordless products? They are tailored to your work and offer just as much power and endurance as their mains-powered counterparts. And thanks to our all-inclusive warranty, you are completely protected for the first three years – typically Festool.

And best of all: 2022 will see the entire cordless Festool system becoming dust-free: The CT MINI and MIDI compact dust extractors are now also available in cordless versions. They impress with proven suction power and integrated Bluetooth® technology. Our CTC SYS Systainer extractor is particularly practical for carrying with you and therefore extraordinarily mobile.

Our KAPEX KSC 60 cordless sliding compound mitre saw and the new TSC 55 K cordless plunge-cut saw complement it perfectly. They are optimally matched to our cordless extractors with the utmost precision and cordless power. You can find more cordless products from page 10.

I hope you enjoy browsing and discovering what's in store.
Sincerely,

Barbara Austel
Shareholder

01	Cordless solutions Machines, batteries, chargers	010
02	Sawing and oscillating (Cordless) jigsaws, (cordless) plunge-cut and portable circular saws, (cordless) compound mitre saws, semi-stationary saws, TKS 80 with SawStop AIM technology, (cordless) oscillators	030
03	Sanding and brushing Electric and cordless sanders, edge sanders, orbital sanders, compressed air sanders, PLANEX long-reach sanders	090
04	Abrasives Machine and manual abrasive	126
05	Polishing Polisher	140
06	Dust extraction (Cordless) mobile dust extractor, AUTOCLEAN mobile dust extractor, special and safety extractor	148
07	Drilling and screwdriving Cordless (percussion) drills, cordless hammer drills, cordless impact driver, cordless drywall screwdrivers	184
08	Routing Routers, edge routers	206
09	Joining – DOMINO joining system DOMINO joining machines	242
10	Planing Electric planers	252
11	Edging CONTURO edge bander	258
12	Stirring Stirrers, DUO stirrer	266
13	Preparing the substrate Surface-restoration grinders, renovation millers	276
14	Cutting Cordless angle grinder, (cordless) diamond cutting systems	284
15	Illuminating Work lights, working lights, grazing light	294
16	Systainer Systainer ³ , organiser, SYS-Combi, SORTAINER, ToolBox, SYS-StorageBox, transport equipment, application systainer	298
17	Workplace organisation SYS-PowerStation, Bluetooth® player, radio, phone charger, workbenches, packaging, organisation and transportation systems, guide rails	310
18	Fan shop	334



CTC MINI/MIDI cordless compact dust extractor

The cordless compact dust extractors are perfectly tailored to Festool cordless tools. Whether for mobile sawing, sanding or drilling, the on-site extractors fit perfectly into the Festool 18 V system. This ensures dust-free work for the cordless application. Additional benefit: Convenient and quick **Bluetooth®** autostart via the battery pack or remote control.

>> Page 156



CTC SYS cordless Systainer extractor

Always by your side, without a cable. Systainer on the outside, cordless extractor on the inside. The CTC SYS offers maximum mobility and independence with minimal weight – perfect for transporting and carrying. This makes it the ideal partner for service work and small tasks, as well as occasional spontaneous use. It enables dust-free work without an electrical outlet module in dust classes L and M.

>> Page 154

New Festool products for 2022.



TPC 18/4, TDC 18/4 cordless (percussion) drill

Powerful. Versatile. With four gears for every application. With the best switching concept you have ever operated. The large number of attachments, combined with perfectly matched accessories, make the QUADRIVE an unmatched percussion drill. What about your hand twisting dangerously if a kickback occurs? Our intelligent KickbackStop minimises the risk of this happening.

>> Page 188

TSC 55 K cordless plunge-cut saw

Kickback is the most common cause of serious injuries when using plunge-cut saws. The intelligent KickbackStop therefore stops the saw blade of the new cordless plunge-cut saw in the blink of an eye. You can now make precise cuts up to twice as fast with an increased battery range. The new generation of saw blades ensures perfect cutting quality.

>> Page 48



TS 55 F plunge-cut saw

Millions of saws don't lie: The plunge-cut saw stands out with its absolute precision cuts, maximum power and extreme durability. The reliability you've come to expect remains the same – but the working speed is unprecedented: The TS 55 F now saws up to twice as fast. The new generation of cutting blades ensures perfect cutting quality with maximum cutting performance.

>> Page 48

Scroll through for
even more exciting
developments

KAPEX KSC 60 cordless sliding compound mitre saw

The KAPEX KSC 60 cordless sliding compound mitre saw produces unbeatably precise cross cuts – in an enormous range of applications with mitre angles of up to 60° on each side and bevel angles of up to 47° on each side. In conjunction with the dual battery system, the brushless EC-TEC motor provides virtually unlimited endurance and is enough for all typical applications for an entire day's work.

>> Page 60



SYS-PowerStation

Imagine how practical it would be – to have a socket with you everywhere and therefore always have access to power. This is exactly what is made possible by our new SYS-PowerStation:

With a completely new type of technology, it does this independently of traditional energy sources: With 2,990 watts permanent power and up to 11,000 watts short-term power, it can operate any mains-powered tool continuously with no losses in performance.

>> Page 312



Router OF 1010 R

Extremely versatile. Extremely precise. Extremely handy: The OF 1010 R router is the perfect tool for fine routing work. The double-sided column clamp makes the router extremely torsionally rigid and ensures results with absolute precision. For routing profiles, grooves, rebates and dovetail joints – the OF 1010 R impresses with a wide variety of possible applications.

>> Page 208



FS/2 KP guide rail with adhesive pads

The new FS/2-KP guide rail allows users to make straight and precise cuts, including on walls. Adhesive pads can be used to securely attach the guide rail without slipping. A straight connection of the guide rails is possible with the self-aligning connecting piece. The angle stop can be easily attached at the guide rail and allows precise angle settings from -60 to +60 degrees.

>> Page 322

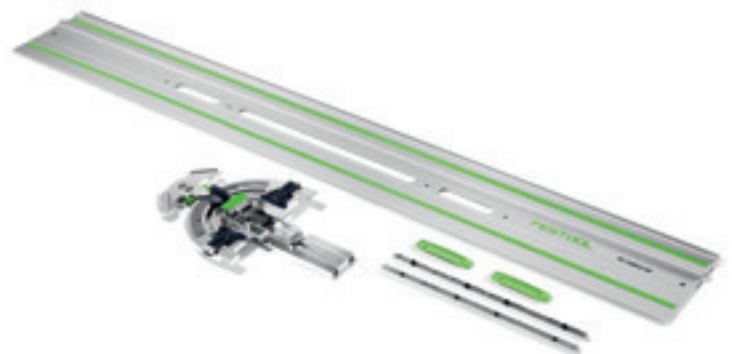

PHC 18 mobile phone charger

No more empty smartphone batteries: The PHC 18 phone charger is a clever adapter that transforms every Festool 18 V battery pack into a power bank (with the exception of: 3.1 Ah Ergo battery packs). So that you can be contacted at all times, the PHC 18 phone charger supplies up to three smartphones with power at the same time – both via users' own charging cables and via inductive charging.

>> Page 327



Energy sets

Complements the cordless Festool Basic versions and delivers even more charge in the workshop or on the construction site: The Energy-Systainer fits all Festool cordless tools and the entire Systainer system. It is available in many different versions, with two or four battery packs (4.0 Ah, 5.2 Ah or 8.0 Ah) and also as an empty Systainer with an inlay for chargers and battery packs of your choice.

>> Page 29

Festool Connected. Handcraft made smart.

Whether in the workshop, on the construction site or at home – with Festool Connected, we offer you intelligent products and smart apps that can optimally support you in every work situation. As a perfect extension to the Festool system, you can easily maintain a digital overview of your Bluetooth®-enabled products and services, configure them easily according to your individual requirements and receive assistance quickly for your specific application.



The Festool system with smart extensions

Our smart apps are perfectly tailored to the intelligent Festool tools and extend their function considerably. With this perfect addition to your Festool system, you will be optimally equipped for every application.

The perfect solution on hand around the clock

Support in any work situation – whether placing a spontaneous order with your dealer, receiving perfect application tips from Festool experts or getting the right guidance if something goes wrong with your tool – the smart Festool apps will give you the help you need. Simple and completely free-of-charge.

Perfect operation. Simply practical

Whether managing your product data and services at a glance or individually adjusting your tools – with Festool smart apps, personal configuration of your tools is just a click away.

Get connected now



For more information on Festool Connected, all the tools that can be connected, and the Festool apps, simply scan the QR code or go to the website:

www.festool.co.uk/connected



For interruption-free work, your extractor will indicate if something is wrong. The Work app sends you the appropriate support via push notification directly to your smartphone.

You can find more information about the compact dust extractors on page 152

Ideal for left-handed people: Simply reverse the rotational direction switch on the QUADRIVE cordless (percussion) drill using the Work app.

You can find more information about the QUADRIVE on page 188



For optimal surface results with the PLANEX LHS 2 225 long-reach sander: Individual adjustment of the LED light ring with the Work app.

You can find more information about the PLANEX on page 116



Always the most up-to-date version: Install software updates to work with the latest functions for your tool at all times.

You can find more information about the batteries on page 28

Discover all of the Festool apps – download for free for Android and iOS now:*



With the Work app, you can individually adjust your connected Festool tools to your work conditions or register for warranty all-inclusive.



With the Order app, you can find your Festool tool, suitable accessories and consumables, and create your digital shopping list and send it conveniently to your dealer.



With the How-to app, you can have a personal video guide to your Festool tool to-hand at all times.

* Festool apps are not available in all countries. You can see a country overview at www.festool.com/connected.



Uncompromising performance.



Hello hotline!
Your contact for all queries.

The direct line to Festool is always the best choice if you want to receive answers to your questions quickly and simply. Whether you require advice, support or repair – we are always happy to hear from you.

Telephone: +44 (0) 7024 8040 | E-mail: customerservice-uk@festool.com



Warranty all-inclusive*
Your performance assured.

After registering your new Festool tool, it is fully covered during the first three years.

Full repair free of charge.**

Fast, thorough and completely free for the first three years. We will even replace battery packs and chargers as well as typical wear parts such as carbon brushes, ball bearings or sealing rings.

Replaced in the event of theft.

If your tool is stolen in the first three years, we will replace your tool with a new machine for a small excess.

Original parts guaranteed.

We guarantee the availability of every spare part for at least ten years after discontinuation of the tool model. And in the unlikely event that we do not have the part you require in stock, you will receive a new tool free of charge.



Register quickly.
Enjoy the benefits for a long time.

The registration of the tool for the warranty all-inclusive can only be done by the purchaser in MyFestool within 30 days of purchase. Please note that the dealer cannot register tools on behalf of customers.

Use the registration form in your MyFestool account or register your tool directly via the Festool Work app.

* Warranty all-inclusive is valid for all Festool tools registered within 30 days of purchase. The Festool warranty terms and conditions shall apply and are available at www.festool.co.uk/service

** "Full repair, free of charge" also applies to battery packs and chargers, but not to other consumables and accessories, or to tools that have been dismantled, or to damage caused by improper use, the use of non-original spare parts, or in the event of continuous use resulting in extensive wear.



MyFestool

Your details just a click away.

With your personal account, you have access to customised information and direct contact with Festool at all times. As a result, you will always be able to take advantage of the full range of services.

Register now for free: www.festool.co.uk/MyFestool

- > Personal online area with individual information and exclusive content
- > Quick registration of your tools for warranty all-inclusive
- > Overview of your registered tools and their warranty periods
- > All warranty certificates at a glance
- > Simplified search for accessories and spare parts
- > Online commissioning of repairs as well as a repair overview
- > Full use of the Festool Work and Order app



Full repair

Your tool, repaired by Festool.

Our experts will take care of your tools with diligence, efficiency and a wealth of expertise. We offer more than just repair services – as part of our warranty all-inclusive*, repairs are even free of charge for the first three years.

- > General overhaul of your tool including maintenance, inspection and adjustment
- > Six-month guarantee on the exchanged spare parts
- > Experienced Festool service technicians
- > Use of original spare parts
- > Comprehensive check with electrical safety test



Simple and convenient.
Repair online.

Commission your repair online in MyFestool and benefit from a short repair time, our free transport service, current status updates and much more!

Our recommendation:

With the Festool Work app, you can enjoy all of the service advantages in one app and register your tool quickly and easily.

Simply scan the QR code to see a guide for registration via the app.

Download now for free for Android and iOS.



01 Cordless solutions

NEW: You can now work dust-free with the entire battery system.



Ready.

With tailor-made cordless solutions.

NEW



012 Cordless extractor



014 Cordless circular saw

NEW



015 Cordless plunge-cut saw

NEW



016 KAPEX cordless sliding compound mitre saw



016 Cordless insulating-material saw



017 CARVEX cordless pendulum jigsaws



017 VECTURO cordless oscillator



018 Cordless sander



018 Cordless edge sander

NEW



020 QUADRIVE cordless percussion drill



021 C 18, T 18+3 cordless drill



021 Cordless impact driver



022 Cordless hammer drill



023 Cordless drywall screwdriver DURADRIVE



023 CXS, TXS cordless drills



024 Cordless angle grinder and cordless freehand cutting system



027 SYSROCK construction site radio and SYSLITE cordless working light

NEW



028 Battery packs, chargers and phone charger

Ready.

For our dust-free battery system.



Goodbye dust. And hello good health. Our cordless extractors love dust and are perfectly tailored to Festool cordless tools: Their compact design and low weight make them the perfect partner for your daily work.

Cordless Systainer extractor CTC SYS

The extractor that is easy to carry: Compact Systainer format, low weight and frees you from the constraints of electrical sockets. This makes it the perfect companion for service work and small tasks, as well as occasional spontaneous use.

NEW



Technical data	CTC SYS
Battery voltage (V)	36
Max. volume flow (l/min)	2.400
Max. vacuum (Pa)	18.000
Container/filter bag capacity (l)	4,5/3,5
Battery capacity (Ah)	4
Weight with battery (kg)	8,8

You can find more information on page 154



Easy to transport in fewer trips

For carrying. This leaves your hands free for any other materials or tools you might need. The removable hose holder means that the CTC SYS can be made even more compact if required.

Cordless mobile dust extractor

CTC MINI/MIDI

Whether for mobile sawing, grinding or drilling: Our compact Festool on-site extractors fit perfectly into the Festool 18 V system. This ensures dust-free work for the cordless application.

Technical data	CTC MINI I*	CTC MIDI I*
Battery voltage (V)	36	36
Max. volume flow (l/min)	3.100	3.100
Max. vacuum (Pa)	19.000	19.000
Container/filter bag capacity (l)	10/7,5	15/12,5
Battery capacity (Ah)	4 / 5,2 / 8	4 / 5,2 / 8
Weight with battery (kg)	13 / 13,2 / 13,8	13,2 / 13,4 / 14

You can find more information on page 156

* 8.0 Ah Li-HighPower battery pack available from October 2022

Available from
spring 2022



Integrated Bluetooth® technology

Ideal combination with Festool cordless tools. Convenient and fast: The extractor switches on automatically via the Bluetooth® battery pack.

Extractor power unleashed. For a completely dust-free cordless system.

Our cordless extractors excel with maximum suction power thanks to the 36 V turbine with 2 x 18 V battery packs. Available in dust classes L and M for a healthy working environment. The special highlights: The highly mobile CTC SYS and the CTC MINI/MIDI for a dust-free working environment in every cordless application. Everything is compatible making the system perfect in every way.

You can find more information on page 152



Ready.

For superior sawing.



If precise cuts, maximum performance and perfectly fitting insulation are in demand, Festool's mobile battery-powered sawing solutions will make your life more enjoyable.

Cordless circular saw

HKC 55

With its even weight distribution and the FSK cross cutting guide rail with stop system, the HKC 55 cordless circular saw is the mobile solution for precise sawing in any position.



Technical data	HKC 55
Battery voltage (V)	18
Idle engine speed (RPM)	4.500
Saw blade diameter (mm)	160
Angular range (°)	0 – 50
Cutting depth 0°, 90° (mm)	0 – 55
Cutting depth 45°/50° (mm)	42/38
Battery capacity (Ah)	5,2
Weight with battery (kg)	4,1

You can find more information on page 54



Concentrated power

The combination of 18 V Li-ion AIRSTREAM battery pack and brushless EC-TEC motor with integrated motor management guarantees impressive cutting performance. Without the need for power outlets and cables.

Cordless plunge-cut saw TSC 55 K

The best cordless plunge-cut saw is now even safer: The unique KickbackStop not only protects the workpiece but also minimises the risk of injury.

Technical data	TSC 55 K
Battery voltage (V)	18/36
Idle engine speed (RPM)	2.650 – 3.800/5.200
Saw blade diameter (mm)	160
Angular range (°)	-1 – 47
Cutting depth (mm)	0 – 55
Cutting depth 45° (mm)	43
Battery capacity (Ah)	5,2
Weight 1 x 18 V/2 x 18 V (kg)	4,6/5,3

You can find more information on page 48

NEW



Exceptional torque

Thanks to our new generation of saw blades and the concentrated torque of our cordless plunge-cut saws, you will be able to work up to twice as fast with an extended battery range. Maximum cutting performance meets perfect cutting quality.

Ready. For the unbeatable double

Pure screwdriving power in four gears and the masterpiece among our saws – the two new incredible cordless tools from Festool make everyday work easy.

You can find more information about the QUADRIVE on page 188



Goodbye to dangerous kickbacks.

Festool has added intelligent KickbackStop technology to the new QUADRIVE and the new generation of TSC 55 K cordless plunge-cut saws. A sensor detects a tool jam in the blink of an eye and stops the motor within a fraction of a second. The risk of injury is reduced to a minimum.



Cordless sliding compound mitre saw KAPEX KSC 60

The cordless KAPEX KSC 60 sliding compound mitre saw produces high-precision cross-cuts – while also offering an enormous range of applications. In conjunction with the dual battery system, the brushless EC-TEC motor provides virtually unlimited endurance.

Technical data	KSC 60
Battery voltage (V)	18/36
Idle engine speed (RPM)	1.300 – 1.800/3.500
Saw blade diameter (mm)	216
Mitre angle (°)	60/60
Inclination angle (°)	47/46
Cutting depth 90°/90° (mm)	305 x 60
Battery capacity (Ah)	5,2
Weight 1 x 18 V/2 x 18 V (kg)	17,1/18,5

You can find more information on page 60

Cordless insulating-material saw ISC 240

A weight of just 2.4 kg and a cutting depth of up to 350 mm makes the ISC 240 cordless insulation saw the first choice for effortless insulation cutting.

Technical data	ISC 240
Battery voltage (V)	18
Stroke rate (RPM)	3.000
Cutting depth (mm)	240
Stroke length (mm)	26
Dust extraction connection dia. (mm)	27
Battery capacity (Ah)	4
Weight with battery (kg)	2,4

You can find more information on page 84

NEW



Versatile

Mitre angles of up to 60° on each side and bevel angles of up to 47° on each side.



Fast and flexible

Perfectly coordinated cutting sets enable fast, clean and precise cutting of flexible mineral and natural fibre insulating materials as well as PUR insulating boards.

Cordless pendulum jigsaws

CARVEX PSC 420

CARVEX PSBC 420

When perfect handling is required for any radius, the cordless pendulum jigsaws with maximum cutting performance and ideal curve handling are enticing options. Available with either an ergonomic soft grip or with a convenient handle.

Technical data	PSC 420	PSBC 420
Battery voltage (V)	18	18
Stroke rate (RPM)	1.500 – 3.800	1.000 – 3.800
Pendulum cover adjustment in stages	4	4
Cutting depth in wood (mm)	120	120
Cutting depth in steel (soft) (mm)	10	10
Battery capacity (Ah)	4	4
Weight with battery (kg)	2,3	2,3

You can find more information on page 32



Perfect combination of power and flexibility

With 3800 strokes per minute, the high-performance, energy-efficient EC-TEC motor gives you powerful, fast sawing progress every time.

Cordless oscillator

VECTURO OSC 18

With the StarlockMax tool holder along with sophisticated positioning and dust extraction accessories – the VECTURO OSC 18 is the intelligent system solution for the highest demands for performance, comfort and precision for dust-free sawing, scraping and cutting.

Technical data	OSC 18
Battery voltage (V)	18
Oscillation (RPM)	10.000 – 19.500
Oscillation angle	2 x 2°
Tool holder	StarlockMax
Battery capacity (Ah)	4
Weight with battery (kg)	1,8

You can find more information on page 86



Sophisticated

Optional system accessories make it possible to create precisely guided plunge cuts and saw with minimal dust generation – even when working above head height.

Ready.

For more relaxed sanding.



Perfect ergonomics is one of the key features that allows your tool to provide you with useful support in your daily routine – and not just when it comes to sawing, drilling and screwdriving. Like all Festool battery solutions, our sanding tools are ergonomically designed to ensure full freedom of movement and mobility.

Cordless eccentric sander

Cordless edge sander

ETSC 125

ES-ETSC 125

The compact ETSC 125 cordless eccentric sander with its ergonomic design and light weight of only 1.4 kg allows for effortless sanding in any situation. Also available as a cordless edge sander – save up to 50% of your time compared to working with a sanding block.



Technical data	ETSC 125	ES-ETSC 125
Battery voltage (V)	18	18
Eccentric motion speed (RPM)	6.000 – 10.000	6.000 – 10.000
Sanding stroke (mm)	2	2
Interchangeable sanding pad dia. (mm)	125	125
Angle adjustment (°)	–	43 – 92
Edge height (mm)	–	5 – 60
Battery capacity (Ah)	3,1	3,1
Weight with battery (kg)	1,4	2,2



Complete cordless mobility without hoses or cables

With the edge sander, you can effortlessly sand small and large workpieces, narrow and wide edges (5 – 60 mm), sloped surfaces (43 – 92°) and external curves on the outline (e.g. on a round dining table). You can work up to the inside corners.

You can find more information on page 100, 108

RUTSCHER cordless orbital sander RTSC 400

With a particularly compact and low design and a narrow 18 V Ergo battery pack, this is the right choice for small and narrow surfaces.



Technical data	RTSC 400
Battery voltage (V)	18
Idle engine speed (RPM)	6.000 – 10.000
Sanding stroke (mm)	2
Interchangeable sanding pad (mm)	80 x 130
Battery capacity (Ah)	3,1
Weight with battery (kg)	1,4

You can find more information on page 110



Unique: With battery or cable

For all applications which require an even longer operating performance, the 18 V Bluetooth® Ergo battery pack can be replaced with the plug it-mains adapter (included in the set version and available as an accessory). This alone creates a mains powered machine with an unlimited running time in combination with the plug it-cable – ideal in conjunction with a Festool mobile dust extractor.

Cordless delta sander DTSC 400

Perfect for corners and edges. With the iron-shaped sanding pad, the DTSC cordless delta sander delivers the best sanding results even in tight spots. And the 18 V Bluetooth® Ergo battery pack in combination with the brushless EC-TEC motor provides plenty of power, similar to that of a mains-powered tool.



Technical data	DTSC 400
Battery voltage (V)	18
Idle engine speed (RPM)	6.000 – 10.000
Sanding stroke (mm)	2
Interchangeable sanding pad (mm)	100 x 150
Battery capacity (Ah)	3,1
Weight with battery (kg)	1,4

You can find more information on page 112



Less reworking

PROTECTOR for smooth sanding along window surfaces, frames and panelling.

Ready.

For greater calm when drilling and screwdriving.



Fast drilling, powerful screwdriving or quickly switch between both. You will find your tailor-made solution in the Festool range. Smart details, such as the CENTROTEC quick-change system and the FastFix attachments help you in all situations.

Cordless drill

QUADRIVE TDC 18/4

QUADRIVE TPC 18/4

The robust four-gear metal drive gives the QUADRIVE enormous power and enables high speeds. Whether you are working on wood, metal or even masonry – with the axial impact feature that can be activated: The TPC 18/4 is extremely durable. The TDC 18/4 is also available as a powerful cordless drill without the impact function.

Technical data	TDC 18/4	TPC 18/4
Battery voltage (V)	18	18
Idling speed, 1st gear/2nd gear (RPM)	0 – 500/0 – 800	0 – 500/0 – 800
Idling speed, 3rd/4th gear (RPM)	0 – 2.350/0 – 3.600	0 – 2.350/0 – 3.600
Max. torque, wood/steel (Nm)	50/75	50/75
Drilling diameter, wood/steel (mm)	70/13	70/13
Drilling diameter in brickwork (mm)	–	10
Battery capacity (Ah)	4/5,2	4/5,2
Weight with battery (kg)	1,9/2	1,9/2

You can find more information on page 188

NEW



NEW



Improved safety and unrivalled versatility.

The electronic KickbackStop prevents your wrist from twisting dangerously. The large number of attachments makes the QUADRIVE the most versatile (percussion) drill and unmatched in its class.

Cordless drill

C 18

T 18+3

The C 18 and T 18+3 cordless drills feature completely electronic torque adjustment, the CENTROTEC quick-change system, as well as angle attachment, eccentric adapter and depth stop – making them ideal solutions for fast work in all drilling and screwdriving applications.

Technical data	C 18	T 18+3
Battery voltage (V)	18	18
Idling speed, 1st gear/2nd gear (RPM)	0 – 450/0 – 1.500	0 – 450/0 – 1.500
Max. torque, wood/steel (Nm)	27/45	35/50
Drilling diameter, wood/steel (mm)	40/13	45/13
Torque adjustment 1st/2nd gear (Nm)	0,8 – 8/0,5 – 6	0,8 – 8/0,5 – 6
Battery capacity (Ah)	4	4
Weight with battery (kg)	1,7	1,7

You can find more information on page 187



Impressively flexible

Quick change of applications thanks to the FastFix interface.

Cordless impact driver

TID 18

The TID 18 offers an impressive service life thanks to its extremely robust hammer mechanism. The turning screw will take the full force of the TID 18 with its 1/4" tool holder – with no strain at all on your wrist: This is thanks to the tangential hammer mechanism with no strength-sapping back torque.

Technical data	TID 18
Battery voltage (V)	18
Idle engine speed, 1st/2nd/3rd gear (RPM)	0 – 1.200/ 0 – 2.000/0 – 3.200
Max. number of strokes (RPM)	4.500
Max. torque (Nm)	180
Tool holder	1/4"
Battery capacity (Ah)	4
Weight with battery (kg)	1,5

You can find more information on page 194



Zero maintenance

The perfect combination of the new-generation brushless EC-TEC motor and the battery pack ensure maximum endurance, even with high performance.

Cordless hammer drill BHC 18

With vibration damping and a weight of just 2.5 kg, the BHC 18 cordless hammer drill is the solution for maximum drilling comfort. The Bluetooth® battery packs start the mobile dust extractor automatically for dust-free, comfortable working with a drilling dust nozzle.



Technical data	BHC 18
Battery voltage (V)	18
Max. number of strokes (RPM)	4.895
Drilling dia. (concrete) (mm)	18
Single impact energy (J)	1,8
Tool holder	SDS-Plus
Battery capacity (Ah)	4
Weight with battery (kg)	2,5

You can find more information on page 196



Powerhouse

Unbeatable power to weight ratio thanks to the combination of EC-TEC motor and C shape model.

Li-HighPower Compact battery pack: Full power at a low weight.

In order to ensure that work is as non-fatiguing as possible, the Li-HighPower Compact battery has a reduced weight, with no detriment to performance. Thanks to the Li-HighPower cell technology, it is powerful enough for any application. With a weight of under 600 grams, it is both 20% lighter and 50% more compact than a 5.2 Ah standard battery pack.

Fully reliable

Thanks to their high-current rechargeable cells, the Li-HighPower Compact batteries are extremely durable. And, naturally, they are fully covered by the comprehensive support provided by Festool Service.



Built-in convenience

The Bluetooth® version of the Li-HighPower battery pack safeguards your health, starting a connected mobile dust extractor automatically when the tool is switched on.



Cordless drywall screwdrivers

DURADRIVE DWC 18

Its design and the tool-free change to magazine attachment make the DWC 18 cordless drywall screwdriver the first choice for fast and precise one-handed screwdriving. Here, the electronic screw depth mechanism ensures the exact screwing depth.

Technical data	DWC 18-2500	DWC 18-4500
Battery voltage (V)	18	18
Idle engine speed (RPM)	0 – 2.500	0 – 4.500
Max. machinable screw length (mm)	55	55
Max. torque, wood/steel (Nm)	7/18	5/14
Battery capacity (Ah)	4	4
Weight with depth stop (kg)	1,8	1,8

You can find more information on page 198



Work progress thanks to magazine attachment

With the magazine attachment, you have one hand completely free to push plasterboard into position or work on ceilings, for example. The magazine can be dismantled in seconds without tools and cleaned quickly and easily.

Cordless drill

CXS

TXS

The 10.8 V XS cordless drills in the ergonomic C shape and classic T shape are attractive options with a light weight of only 0.9 kg. As true powerhouses, they allow for quick and easy screwdriving and drilling without forfeiting anything in the way of power or performance.

Technical data	CXS	TXS
Battery voltage (V)	10,8	10,8
Idling speed, 1st gear/2nd gear (RPM)	0 – 430/0 – 1.300	0 – 430/0 – 1.300
Max. torque, wood/steel (Nm)	10/16	10/16
Drilling diameter, wood/steel (mm)	12/8	12/8
Torque adjustment 1st/2nd gear (Nm)	0,3 – 3,4	0,3 – 3,4
Battery capacity (Ah)	2,6	2,6
Weight with battery (kg)	0,9	0,9

You can find more information on page 186



Extremely versatile

The CENTROTEC quick-change system and the FastFix attachments ensure rapid changing between drilling and screwdriving.

Ready.

For absolute reliability when cutting and grinding.



With robustness, resistance to dust and ideal suction power, the angle grinder can facilitate the cutting of even the hardest of materials.

Cordless angle grinder AGC 18

The AGC 18 cordless angle grinder is dust-resistant and durable thanks to the enclosed brushless EC-TEC motor and protected electronics.



Technical data	AGC 18
Battery voltage (V)	18
Idle engine speed (RPM)	4.500 – 8.500
Disc dia. (mm)	125
Spindle thread/flange	M14
Battery capacity (Ah)	5,2
Weight with battery (kg)	2,7

You can find more information on page 286



Work adapted to the material

The continuously adjustable speed of 4500 to 8500 rpm ensures that cutting and grinding is tailored to the material.

Cordless freehand cutting system DSC-AGC 18 FH

To safeguard health when working, the dust extraction attachment transports over 95% of the dust directly into the mobile dust extractor – making it ideal for dust-free cutting work on mineral materials in interiors. For ease of use, the Bluetooth® battery pack starts up the connected mobile dust extractor automatically.



Technical data	DSC-AGC 18 FH
Battery voltage (V)	18
Idle engine speed (RPM)	4.500 – 8.500
Disc dia. (mm)	125
Cutting depth (mm)	27
Dust extraction connection dia. (mm)	36/27
Spindle thread/flange	M14
Battery capacity (Ah)	5,2
Weight with battery (kg)	3,2

You can find more information on page 288



Precise, unrestricted cutting

Sophisticated guard provides a clear view of the cutting line – for easy orientation along the scribe mark. The guard can also easily be opened out to the front to allow work close to edges.

Exceptional: Full repair, free of charge. Also for batteries.

Fast, thorough, and completely free for the first three years: Our top-class repair service. With our warranty all-inclusive, we will even replace battery packs and chargers free of charge. You will receive a one hundred per cent repair at zero cost.*

You can find more information on page 8



* Warranty all-inclusive is valid for all Festool tools registered within 30 days of purchase. The Festool warranty terms and conditions shall apply and are available at www.festool.co.uk/service
"Full repair, free of charge" also applies to battery packs and chargers, but not to other consumables and accessories, or to tools that have been dismantled, or to damage caused by improper use, the use of non-original spare parts, or in the event of continuous use resulting in extensive wear.

Ready.

For more light, full sound and sufficient power.



In addition to the right tools, your daily work with Festool also demands a suitable working environment. Because work is simply easier with perfect lighting, great sound and sufficient power for your smartphones.

Torch SYSLITE KAL II

The handy KAL II is always ready to light up dark corners. Their powerful, energy-efficient, high-power LEDs and lightweight and compact design makes them a welcome working aid. They are compatible with all conventional Festool battery packs.



Technical data	KAL II
Lumen value 1st/2nd stage (lm)	310/769
Light source (watt)	18
Operating time (internal battery) 1st/2nd stage (min)	290/120
Operation with Festool slide-in battery packs (V)	10,8 – 18
Thread size stand (")	1/4
Weight (without battery pack) (kg)	0,7

You can find more information on page 296

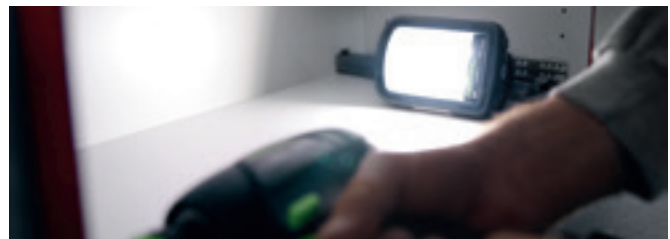

Made for construction sites

The housing for the SYSLITE KAL II consists of breakproof, shockproof and impact-resistant cast aluminium. The large recessed handle is heat-insulated to protect the user and the light.

Site radio

SYSROCK BR 10 DAB+

Robust, compact, powerful: The SYSROCK site radios are perfect for any window ledge, and combine compact dimensions with a low weight and a unique sound. And thanks to the SYSROCK DAB+, frequency interference is a thing of the past.

Technical data	BR 10 DAB+
Operation with Festool slide-in battery packs (V)	18
Radio reception	FM / DAB+
Speaker (watt)	10
Number of stored stations	2 x 4
USB output	5V/1,2A
Weight (kg)	0,7

You can find more information on page 314



For listening to music and making calls

The Bluetooth® interface enables the SYSROCK to be paired with a smartphone – perfect if you want to listen to your own music or make phone calls.

Phone charger

PHC 18

The PHC 18 phone charger acts as a clever adapter that transforms every Festool 18 V battery pack into a power bank (with the exception of 3.1 Ah Ergo battery packs). It supplies up to three smartphones with power – both via users' own charging cables and inductive charging.

Technical data	PHC 18
USB port compatible with type A	5 V / 2,4 A / 12 W
USB port compatible with type C	5 V / 2,4 A / 12 W
Inductive charging compatible with Qi-BPP/PPDE	5 W / 9 W

You can find more information on page 327

NEW



Supplies power to up to three smartphones at the same time

Two USB ports (types A and C) and the inductive charging surface enable up to three smartphones to be charged at the same time.



Ready.

For individual and powerful solutions.

NEW:

also available in a 8.0 Ah variant from October 2022



Overview of the battery packs	2,6 Ah XS	3,1 Ah Ergo	3,1 Ah Compact	4,0 Ah Li-HighPower Compact
Battery voltage	10,8 Volt	18 V	18 V	18 V
AIRSTREAM				•
Suitable chargers	MXC	TCL 6 TCL 6 DUO SCA 8	TCL 6 TCL 6 DUO SCA 8	TCL 6 TCL 6 DUO SCA 8
Benefits	Specially developed for TXS and CXS small, light, compact	Specially developed for ETSC 125, DTSC 400, RTSC 400 cordless one-handed sanders powerful and long-lasting	Very light, and therefore ideal for drilling and screwdriving Specialist for ergonomic working	The new compact solution: Full power at a low weight powerful enough for every application 20% lighter and 50% more compact than a 5.2 Ah standard battery pack
Ideal application area	Light screw joints for assembly tasks with absolute focus on ergonomics and ease.	Uninterrupted sanding work with RTSC 400, DTSC 400 or ETSC 125 thanks to battery packs with significantly longer operating times than the time taken to charge.	Ideal for light assembly work with low power requirements and a high focus on ease: e.g. light screwdriving applications with cordless drills such as T 18, C 18, DWC 18 etc.	For all applications and 18-volt devices – when the focus is on compact design and ease. For example, for all drilling and screwdriving applications with C 18, T 18, DWC 18, TPC 18/ TDC 18, BHC 18, TID 18, and also for applications with the PSC/PSBC 420 jigsaws, etc.
Weight	0,20 kg	0,40 kg	0,40 kg	0,60 kg
Bluetooth® variant		•		•
Order no.	500184	202497	201789	205034
RRP in €*	58.50 70.20	84.50 101.40	66.10 79.32	90.00 108.00



NEW



	charger MXC	rapid charger TCL 6	SCA 8 rapid charger	TCL 6 DUO rapid charger
AIRSTREAM			•	•
Max. charging current	2,8 A	6,0 A	8,0 A	2x 6,0 A
Benefits	specially developed for 2.6 Ah (10.8 V) battery pack (CXS and TXS)	LED display for showing the remaining charge time and the charge status for all Festool 18 V battery packs (including Ergo battery pack)		
			Optimum use in machines with high power consumption and short downtimes	Enables two battery packs (same or different) to be charged at the same time
Weight	0,50 kg	0,80 kg	1,10 kg	1,5 kg
Order no.	497496	201136	200311	577019
RRP in €*	52.20 62.64	52.30 62.76	80.90 97.08	104.40 125.28



5,2 Ah	6,2 Ah
18 V	18 V
•	•
TCL 6 TCL 6 DUO SCA 8 (with AIRSTREAM)	TCL 6 TCL 6 DUO SCA 8 (with AIRSTREAM)
Powerful all-rounder for all applications	The most efficient: For sawing and heavy-duty drilling and screwdriving applications
For all applications and 18-volt devices – with a focus on power and endurance for example, endurance work with AGC 18, HKC 55, TSC 55 as well as for especially heavy drilling and screwdriving applications with TPC 18/TDC 18.	For tasks for which power and extreme endurance are required – can be used for example for very long operating periods in combination with the TSC 55/HKC 55 plunge-cut saw or circular saw or the AGC 18 cordless angle grinder. Only available as an accessory.
0,70 kg	0,70 kg
•	•
202479	201797
108.40 130.08	135.90 163.08



Dust-free working made easy.

With the Bluetooth® battery pack, the mobile dust extractor is automatically started up when the cordless tool is switched on. All 18 V battery packs are available with Bluetooth® technology – and are already included with delivery for many cordless tools. Additionally, using the Festool Work app, you can obtain additional information on fill level, status and last contact at any time.



Exceptional: Full repair, free of charge – including for batteries.**

Fast, thorough and completely free for the first three years: Our top-class repair service. With our warranty all-inclusive***, we will even replace typical wear parts such as carbon brushes, ball bearings and sealing rings free of charge. You'll receive a one hundred per cent repair at zero cost. And best of all: This promise also applies to battery packs and chargers.**

** "Full repair, free of charge" also applies to battery packs and chargers, but not to other consumables and accessories, or to tools that have been dismantled, or to damage caused by improper use, the use of non-original spare parts, or in the event of continuous use resulting in extensive wear.

*** Warranty all-inclusive is valid for all Festool tools registered within 30 days of purchase. The Festool warranty terms and conditions shall apply and are available at www.festool.co.uk/service.



4.0 Ah Li-HighPower Compact energy sets		5.2 Ah energy sets		SYS3 M 187 ENG 18V
Systerainer SYS3 M 187 with 1 x TCL 6 DUO rapid charger and		Systerainer SYS3 M 187 with 1 x TCL 6 DUO rapid charger and		Empty Systerainer with insert: Offers space for four battery packs and two chargers.
2 x 4.0 Ah Li-HighPower Compact battery packs	4 x 4.0 Ah Li-HighPower Compact battery packs	2 x 5.2 Ah battery packs	4 x 5.2 Ah battery packs	
Energy Well-packaged: Two or four battery packs. One charger in a Systerainer ³ . As an ideal addition to the Festool Basic variants or as additional battery packs for the workshop and construction site. Available with 5.2 Ah battery packs or with 4.0 Ah Li-HighPower Compact battery packs. Ready to use again in no time thanks to the DUO TCL 6 rapid charger.				Super flexible: Customise your set-up. Be it maximum power with 5.2 Ah battery packs, maximum ease with compact battery packs or the perfect mix of everything: The clever insert is perfect for all Festool battery packs and chargers.
577256	577105	577076	577137 (from spring 2022)	577133
234.00 280.80	381.60 457.92	263.70 316.44	441.90 530.28	64.10 76.92

* Manufacturer's recommended retail price. Dealer prices may vary. Excl. VAT. | Incl. VAT.

Vibration and emissions values can be found in the operating manual at www.festool.co.uk/vibration

02 Sawing and oscillating





032 CARVEX
pendulum jigsaws



034 TRION
pendulum jigsaws



048 Circular saws



054 Circular saws



059 Guide systems



060 KAPEX
sliding compound mitre saws



066 Compound mitre saw
SYMMETRIC



068 Table saw



072 Bench-mounted trimming saws
PRECISIO



082 Sword saws



084 Cordless
insulating-material saw



086 VECTURO
cordless oscillator

Lightweight. Handy. Unbeatable profile cutting capacity – even with the Li-HighPower Compact battery.

The CARVEX pendulum jigsaws.

Work comfortably in any position with the CARVEX. The machine operates at 3800 strokes per minute for inimitably powerful cutting strokes using an EC-TEC motor and unbeatable profile-cutting capacity. And it can be adapted to any situation you encounter while working. This is guaranteed by the varied range of accessories, including angle table, core maker, guide rail and various base runners.



Cordless pendulum jigsaws **CARVEX PSC 420** **CARVEX PSBC 420**

Our cordless versions: Work ergonomically without a cable – independently of the mains power supply and effortlessly in all application areas thanks to the 18 V battery pack.



Jigsaws **CARVEX PS 420** **CARVEX PSB 420**

The choice is yours: Guide the CARVEX PS 420 directly at the ergonomic knob handle, while the CARVEX PSB 420 has a handy D-handle. You decide based on your preferences – it makes no difference to the power, comfort or ergonomics of the tool.



Brushless
EC-TEC motor





Changes without using tools

Adapting to the working material is worth it. The results are more accurate and the saw blades last much longer. The Festool system is therefore designed to reduce set-up times, e.g. with single-handed saw blade changes without the need for additional equipment. In addition, benches and base runners can be changed without the need for additional equipment.



Optimum handling and operation

With a weight of only 2.3 kg, a slim, ergonomic design, non-slip soft-grip coating and on/off switches mounted on both sides (also centrally on stirrup handle version) for right-handed and left-handed operation.



Extremely versatile

Even the smallest circles (radii of 34 mm to 1.5 m) are easy to manufacture with the core maker and compatible jigsaw blade, e.g. the S 75/4 FSG.



Precision cutting along the scribe mark

The stroboscopic light brings the saw blade to a visible stop, while dust extraction and the blowing function of the CARVEX keep the view of the scribe mark free.

Everything at hand.
The accessories Systainer.

Whether you are working with the various outsoles, core makers, angle table/adapter table or replacement splinter guard – with the ZH-SYS-PS accessories Systainer, you will have everything you need to hand to make optimum use of your jigsaws in all of your applications. And this is stored away neatly and compactly in the practical Systainer³.

You can find more information on page 37



Our classic – tried and tested for universal use. The TRION pendulum jigsaws.

Thoroughly robust and powerful. The three-way saw blade guide with parallel adjustable carbide jaws guarantees precise cuts at accurate angles. You also save time: The simple yet effective splinter guard for splinter-free cuts and the tool-free FastFix saw blade quick-change system avoid the need for rework.

Pendulum jigsaw TRION PS 300

The PS 300 with knob handle is characterised by its excellent handling, e.g. during one-handed operation. The control elements are easy to reach in any situation. A perfect centre of gravity keeps the machine well balanced in any position.



Pendulum jigsaw TRION PSB 300

As the D-handle version of the PS 300, the PSB 300 boasts the same sophisticated features. This means that all users can select the handle shape that suits them best, according to their own personal preferences.



Powerful and consistently accurate

The three-way saw blade guide with parallel adjustable carbide jaws guarantees precise cuts at accurate angles. And, thanks to the simple swivelling function of the table, you can achieve mitre cuts with ease.



Rapid saw blade changes

The FastFix quick-clamping saw blade system saves you time and money without the use of additional tools. Sealing MIM technology (Metal Injection Moulding) and the fibre-reinforced quick-clamping lever guarantee lasting reliability.



Splinter-free cuts

The simple but effective splinter guard ensures splinter-free cuts and avoids time-consuming finishing work, even on veneered surfaces. Typical Festool: Precise right down to the smallest detail.









Technical data	PS 420	PSB 420	PSC 420	PSBC 420	PS 300	PSB 300
Power consumption (watt)	550	550	–	–	720	720
Battery voltage (V)	–	–	18	18	–	–
Stroke rate (RPM)	1.500 – 3.800	1.000 – 3.800	1.500 – 3.800	1.000 – 3.800	1.000 – 2.900	1.000 – 2.900
Pendulum cover adjustment in stages	4	4	4	4	4	4
Inclination (°)	–	–	–	–	0 – 45	0 – 45
Cutting depth in wood (mm)	120	120	120	120	120	120
Cutting depth in NF metals (mm)	20	20	20	20	20	20
Cutting depth in steel (soft) (mm)	10	10	10	10	10	10
Battery capacity (Ah)	–	–	4	4	–	–
Weight (kg)	1,9	1,9	–	–	2,4	2,4
Weight with battery (kg)	–	–	2,3	2,3	–	–

Applications

Work independent of the mains power supply	–	–	●	●	–	–
Cut-outs for sinks and kitchen hobs	●	●	●	●	●	●
Trimming work on furniture, kitchens, for interior fitting	●	●	●	●	●	●
Cutting circles and curves	●	●	●	●	○	○
Coping end strips	●	●	●	●	●	●
Cutting workpieces to length	●	●	●	●	●	●
Edge notching on beams	●	●	●	●	●	●
Cutting from below	●	●	●	●	●	○

Extremely appropriate ●
Appropriate ○

02 Sawing and oscillating

Items included	RRP in £*	Order no.
PS 420		
 PS 420 EBQ-Plus 240V 2 x jigsaw blade set: 1 x WOOD FINE CUT S 75/2.5 and 1 x WOOD UNIVERSAL S 75/4 FSG, splinterguard, Systainer SYS3 M 137	349.00 418.80	576178
PSB 420		
 PSB 420 EBQ-Plus 240V 2 x jigsaw blade set: 1 x WOOD FINE CUT S 75/2.5 and 1 x WOOD UNIVERSAL S 75/4 FSG, splinterguard, Systainer SYS3 M 137	349.00 418.80	576189
PSC 420	All variants: 2 x jigsaw blade set: 1 x WOOD FINE CUT S 75/2.5 and 1 x WOOD UNIVERSAL S 75/4 FSG, splinterguard, Systainer SYS3 M 187	
 PSC 420 EB-Basic without battery pack, without charger	311.00 373.20	576521
PSC 420 HPC 4,0 EBI-Plus BP 18 Li 4.0 HPC-ASI battery pack, rapid charger TCL 6	453.00 543.60	576526
PSBC 420	All variants: 2 x jigsaw blade set: 1 x WOOD FINE CUT S 75/2.5 and 1 x WOOD UNIVERSAL S 75/4 FSG, splinterguard, Systainer SYS3 M 187	
 PSBC 420 EB-Basic without battery pack, without charger	311.00 373.20	576530
PSBC 420 HPC 4,0 EBI-Plus BP 18 Li 4.0 HPC-ASI battery pack, rapid charger TCL 6	453.00 543.60	576533
PS 300	All variants: 2 x jigsaw blade set: 1 x WOOD FINE CUT S 75/2.5 and 1 x WOOD UNIVERSAL S 75/4 FSG, splinterguard, Systainer SYS3 M 137	
 PS 300 EQ-Plus 110V	281.00 337.20	576043
PS 300 EQ-Plus 240V	281.00 337.20	576044
PSB 300		
 PSB 300 EQ-Plus 240V 2 x jigsaw blade set: 1 x WOOD FINE CUT S 75/2.5 and 1 x WOOD UNIVERSAL S 75/4 FSG, splinterguard, Systainer SYS3 M 137	281.00 337.20	576051

Our recommendation: Festool Order app.

Download now
free of charge

With the Order app, you can find your Festool tool, suitable accessories and consumables, and create your digital shopping list and send it conveniently to your dealer. The favourites function allows you to easily re-order saved accessories or consumables. You can also manage your orders comfortably whilst on the go, can maintain an overview of these at all times and ensure your everyday work is even more well organised.



You can find more information on page 6

Accessories		RRP in £*	Order no.
	Angle table WT-PS 420 for PS(C) 400/420, PSB(C) 400/420, for angled cuts from +45° to -45°, stepless angle adjustment	110.70 132.84	496134
	base adapter ADT-PS 420 for PS(C) 400/420, PSB(C) 400/420, for using the PS on the guide rail, for installation in the Compact Module System CMS, in conjunction with circle cutting attachment KS-PS 400	14.00 16.80	497303
Core maker All variants: for PS(C) 400/420, PSB(C) 400/420, circle dia. from 120 mm – 3 m			
	KS-PS 420 in conjunction with adapter table ADT-PS 400	46.30 55.56	497304
	KS-PS 420 Set incl. adapter table ADT-PS 420	60.30 72.36	497443
Base runner All variants: for PS(C) 400/420, PSB(C) 400/420			
	LAS-PS 420 plastic all-round base for wood or similar materials	9.90 11.88	497297
	LAS-Soft-PS 420 studded base with optimum sliding properties for wood or similar materials	9.90 11.88	497298
	LAS-HGW-PS 420 durable laminated fabric base for wood or similar materials	14.70 17.64	497299
	LAS-St-PS 420 for all metallic materials	14.70 17.64	497300
	LAS-STF-PS 420 for sensitive surfaces	14.70 17.64	497301
	Spare felt EF-LAS-STF-PS 420 for PS(C) 400/420, PSB(C) 400/420, 5x spare felt for StickFix LAS-STF-PS 420 base runner	8.70 10.44	497444
	Accessories Systainer ZH-SYS-PS 420 for PS(C) 400/420, PSB(C) 400/420, 5 splinterguards, Soft base runner, Hard base runner, Steel base runner, StickFix baseplate, angle table, base adapter, core maker, StickFix felt, Systainer SYS3 M 112	222.20 266.64	576789
	Guide rail adapter FS-PS/PSB 300 for PS 200, PS 300, PSB 300, PS 2, allows use of jigsaws with FS and FS/2 guide systems	13.80 16.56	490031
	Parallel side fence PA-PS/PSB 300 for PS 300, PSB 300, PS200, PS2, max. workpiece width 200 mm	25.20 30.24	490119
	Core maker KS-PS/PSB 300 for PS 300, PSB 300, PS200, PS2, circle dia. 130 – 720 mm	25.20 30.24	490118
Splinter guard All variants: for PS 300, PSB 300, PS(C) 400/420, PSB(C) 400/420, prevents splintering			
	SP-PS/PSB 300/5 qty. in pack 5 Units	6.30 7.56	490120
	SP-PS/PSB 300/20 qty. in pack 20 Units	11.60 13.92	490121
	Battery and charging technology from page 28		

New versatility for perfect cuts.

Whether you require speed for straight cuts or precision in tight curves. In wood, plastic, building materials or metal. With cross-set or sanded teeth, a small or large pitch, made from HCS tool steel or carbide-tipped. No matter what you want to cut, a glance at the application overview of Festool's new range of jigsaw blades, will help you find the correct saw blade right away.

WOOD

Wood

For outstanding results in wooden materials with high-grade HCS tool steel.

PLASTICS

Plastic materials

Specially designed for excellent cutting results in virtually all plastics.

METAL

Metal

Rippled basic form made from HCS bimetal – ideal for machining metals such as aluminium and steel.

BUILDING MATERIALS

Building materials

Carbide-tipped for the longest service life even with abrasive materials.

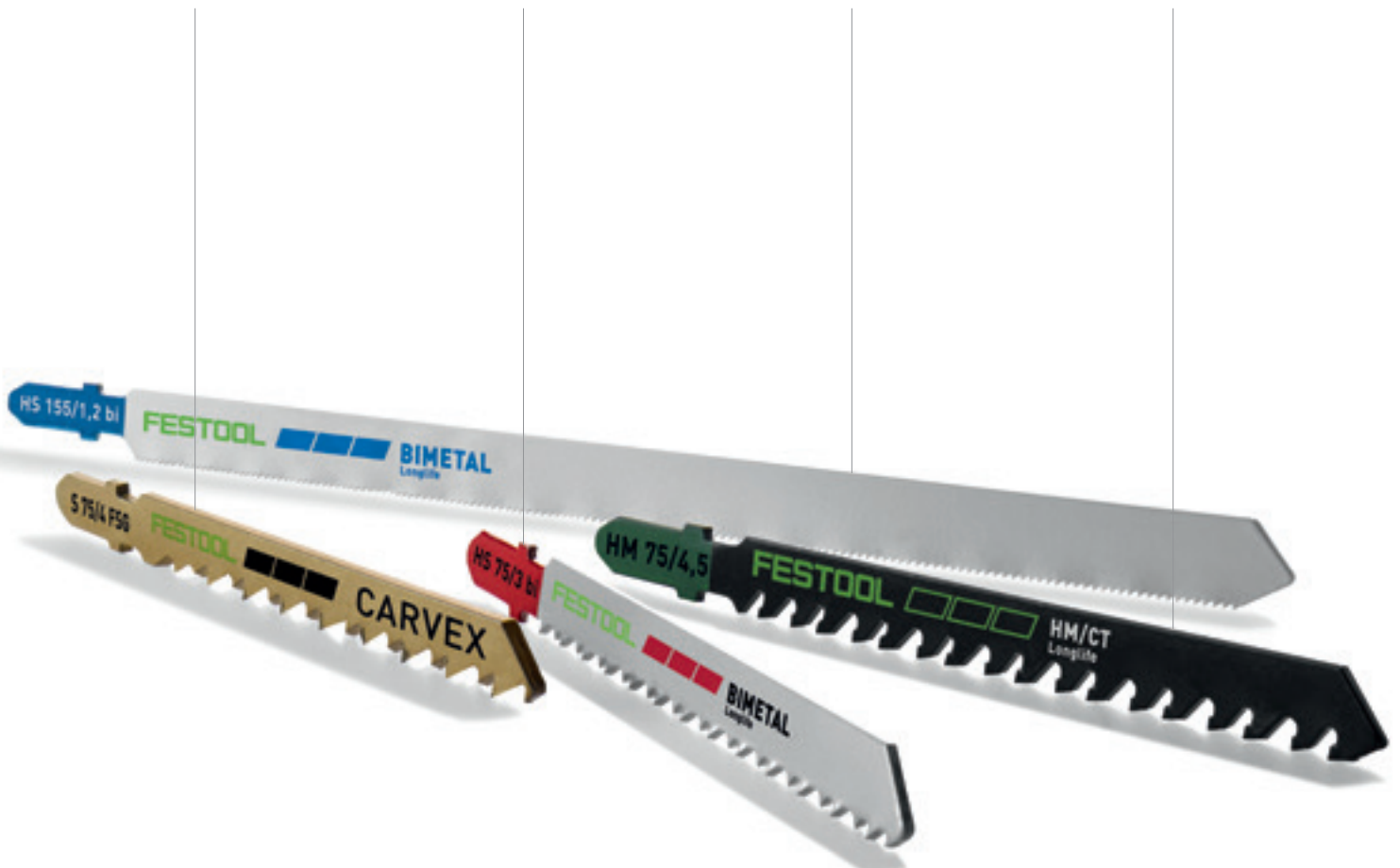

Tips for setting the jigsaw correctly depending on the application.

Speed Control

High speeds in settings 4–6 are ideal for machining soft, temperature-resistant materials such as wood. Low speed settings of 1–3 are recommended for temperature-sensitive plastics such as acrylic glass or PET in order to avoid smearing and for metals and building materials in order to minimise jigsaw blade wear and the production of dust.

Pendulum stroke setting

A higher pendulum stroke makes it faster and easier for the jigsaw to work through the material, but it usually results in significant splintering. A low or deactivated pendulum stroke ensures low-splinter, accurate cuts at a low working speed and is therefore ideal for precise adjustment work and curved cuts.



Material	Saw blade	Application	Speed recommendation	Pendulum stroke recommendation
WOOD	Basic	For quick cuts in wood where high precision is not required.	4-6	
	Universal	The universal blade for perpendicular cuts fundamentally encompasses all relevant applications involving wood. Also ideal in combination with the Festool guide rail.	4-6	
	Straight Cut	For highly precise perpendicular cuts thanks to extremely sharp Japanese teeth – the fibres are firstly scored, then cut through cleanly.	4-6	Min. for high precision Max. for high speed
	Curves	Ideal for curves – even extremely tight radii are possible.	4-6	
	Fine Cut	For precisely cut and splinter-free surfaces.	4-6	
PLASTICS	Solid Materials	For the toughest demands such as plastic solid material and fibre-reinforced plastics.	1-3	
	Profile	For plastic profiles, acrylic glass (e.g. Plexiglas®) and soft plastics.	1-3	off
	Laminate	For laminate and boards bonded with melamine resin (e.g. Trespa®).	1-3	
METAL	Steel/Stainless Steel	For machining aluminium, non-ferrous metals and steel.	1-3	
	Sandwich Materials	For sandwich materials.	1-3	off
BUILDING MATERIALS	Abrasive Materials	For gypsum and cement-bonded chipboard and fibreboard.	1-3	
	Ceramics	For machining brickwork and ceramics.	1-3	Min. for high precision Max. for high speed
	Insulation	For soft insulating materials, cardboard and polystyrene.	1-3	

02 Sawing and oscillating

Tooth pitch, type and material



cross-set teeth for quick cuts



conically ground blades for clean cuts



HCS tool steel: standard quality for all types of wood



HS bimetal: resistant to high temperatures and hard-wearing

Performance features



carbide: resistant to high temperatures and hard-wearing



brazed carbide grit, fine

































coarse or fine saw blade. Rule of thumb: at least 3 teeth should be engaged



serrated blade, milled teeth

Basic		Straight cuts	Curved cuts	perpendicular cuts	Clean, splinter-free cut	Length of cutting blade	Pitch
	S 75/4/5	○	○			75 mm	4 mm
	S 75/4/25	○	○			75 mm	4 mm
	S 75/4/100	○	○			75 mm	4 mm
	S 105/4/5	○	○			105 mm	4 mm
Universal							
	S 75/4 FSG/5	○	○	●		75 mm	4 mm
	S 75/4 FSG/20	○	○	●		75 mm	4 mm
	S 105/4 FSG/5	○	○	●		105 mm	4 mm
	S 105/4 FSG/20	○	○	●		105 mm	4 mm
	S 145/4 FSG/5	○	○	●		145 mm	4 mm
Straight Cut							
	S 75/2,8/5	●		●	○	75 mm	2,8 mm
	S 75/2,8/20	●		●	○	75 mm	2,8 mm
	S 105/2,8/5	●		●	○	105 mm	2,8 mm
	S 105/2,8/20	●		●	○	105 mm	2,8 mm
	S 145/2,8/5	●		●	○	145 mm	2,8 mm
Curves							
	S 75/1,4 K/5		○		○	75 mm	1,4 mm
	S 75/4 K/5		●			75 mm	4 mm
	S 75/4 K/20		●			75 mm	4 mm
Fine Cut							
	S 75/2,5/5	●			●	75 mm	2,5 mm
	S 75/2,5/25	●			●	75 mm	2,5 mm
	S 75/2,5 R/5	●			●	75 mm	2,5 mm

(Shaping teeth)

	Max. workpiece thickness	Qty. in pack	RRP in £*	Order no.	 Solid wood	 Raw chipboard/blockboard, plywood	 Coated chipboard, veneered blockboard	 Melamine resin boards (Trespa®, Resopal®), laminate	 HPL	 EPOXY	 Plastics	 Fibre-reinforced plastics, GFRP	 soft plastics, PVC	 Plastic solid material, acrylic glass (Plexiglas®)	 Plastic profiles, acrylic glass (Plexiglas®)
	30 mm	5 Units	9.00 10.80	204305	●	●	●								
	30 mm	25 Units	34.50 41.40	204306	●	●	●								
	30 mm	100 Units	120.30 144.36	204346	●	●	●								
	60 mm	5 Units	14.20 17.04	204315	●	●	●								
	30 mm	5 Units	19.30 23.16	204316	●	●	●								
	30 mm	20 Units	64.80 77.76	204317	●	●	●								
	60 mm	5 Units	25.60 30.72	204327	●	●	●								
	60 mm	20 Units	83.10 99.72	204332	●	●	●								
	100 mm	5 Units	29.70 35.64	204335	●	●	●								
	30 mm	5 Units	15.90 19.08	204260	●	●	●								
	30 mm	20 Units	53.50 64.20	204261	●	●	●								
	60 mm	5 Units	21.40 25.68	204262	●	●	●								
	60 mm	20 Units	70.50 84.60	204263	●	●	●								
	100 mm	5 Units	24.90 29.88	204264	●	●	●								
	10 mm	5 Units	11.30 13.56	204267	●	●	●								
	30 mm	5 Units	12.00 14.40	204265	●	●	●								
	30 mm	20 Units	40.10 48.12	204266	●	●	●								
	30 mm	5 Units	12.70 15.24	204256	●	○	●					○	○		
	30 mm	25 Units	51.70 62.04	204257	●	○	●					○	○		
	30 mm	5 Units	12.90 15.48	204259	●	○	●					○	○		

Extremely appropriate ●
Appropriate ○

* Manufacturer's recommended retail price. Dealer prices may vary.
Excl. VAT. | Incl. VAT.

02 Sawing and oscillating

Tooth pitch, type and material



cross-set teeth for quick cuts



conically ground blades for clean cuts



HCS tool steel: standard quality for all types of wood



HS bimetal: resistant to high temperatures and hard-wearing

Performance features



carbide: resistant to high temperatures and hard-wearing



brazed carbide grit, fine



coarse or fine saw blade. Rule of thumb: at least 3 teeth should be engaged



serrated blade, milled teeth

	Solid Materials		Straight cuts	Curved cuts	perpendicular cuts	Clean, splinter-free cut	Length of cutting blade	Pitch
PLASTICS	 HS 75/3 BI/5		○	○			75 mm	3 mm
	Profile							
	 S 75/1,5/5		○	○			75 mm	1,5 mm
	Laminate							
	 HM 90/3,3		●				90 mm	3,3 mm
METAL	Steel/stainless steel							
	 HS 75/1,2 BI/5		●				75 mm	1,2 mm
	 HS 75/1,2 BI/20		●				75 mm	1,2 mm
	 HS 105/1 BI/5		●				105 mm	1 mm
	Sandwich Materials							
	 HS 155/1,2 BI/5		●				155 mm	1,2 mm
BUILDING MATERIALS	ABRASIVE MATERIALS							
	 HM 75/4,5		○	●			75 mm	4,5 mm
	Ceramics							
	 R 54 G Riff		○	○				54 mm
	Insulation							
	 S 155/W/3		○	○			155 mm	
	Jigsaw blade range for wood							
	 STS-Sort/25 W						75 mm	
								
								
								

Contents:

- 5 x Wood Basic: S 75/4
- 5 x Wood Universal S 75/4 FSG
- 5 x Wood Straight Cut S 75/2,8
- 5 x Wood Curves S 75/4 K
- 5 x Wood Fine Cut S 75/2,5

Max. workpiece thickness	Qty. in pack	RRP in £*	Order no.	Material compatibility															
				HPL	EPOXY	Plastics	Melamine resin boards (Trespa®, Resopal®), laminate	Fibre-reinforced plastics, GFRP	soft plastics, PVC	Plastic solid material, acrylic glass (Plexiglas®)	Plastic profiles, acrylic glass (Plexiglas®)	Aluminium, aluminium composite panels	Non-ferrous metals	Iron, steel	Multilayered boards	NIROSTA STAINLESS INOX	Brickwork, ceramics	Fibre cement, plasterboard	Cardboard, insulating materials
30 mm	5 Units	20.70 24.84	204336				○	●	●			○	○						
30 mm	5 Units	12.70 15.24	204268					●		●									
30 mm	1 Units	28.30 33.96	204269	●															●
20 mm	5 Units	17.30 20.76	204270								●	●	●		●				
20 mm	20 Units	58.40 70.08	204271								●	●	●		●				
40 mm	5 Units	21.60 25.92	204272								●	●	●		●				
110 mm	5 Units	27.50 33.00	204337								●	●	●		●				
30 mm	1 Units	19.30 23.16	204343	●	●														●
8 mm	1 Units	8.60 10.32	204344			●							○	○				●	
110 mm	3 Units	15.30 18.36	204345																●
30 mm	25 Units	54.10 64.92	204275																

Extremely appropriate ●
Appropriate ○

* Manufacturer's recommended retail price. Dealer prices may vary.
Excl. VAT. | Incl. VAT.

For sawing precision.

The TS 55 F, TSC 55 K and TS 75 plunge-cut saws.



High-quality working results

The guide rail guarantees clean, splinter-free cuts. The plunge-cut saw is fitted with guidance jaws that do not require tools to be adjusted, in order to enable the saw to operate with complete accuracy.



Dust-free work

The adjustable intake manifold with CLEANTEC sleeve ensures that the suction hose is securely fitted in the tool. In combination with a Festool mobile dust extractor, the chips are sucked up at their source – providing a clean and healthy working environment.



Perfect cut-outs

E.g. plunge cuts in kitchen worktops must be made precisely on the scribe mark. The transparent viewing window also allows a perfect view of the end markings, for example in corners.

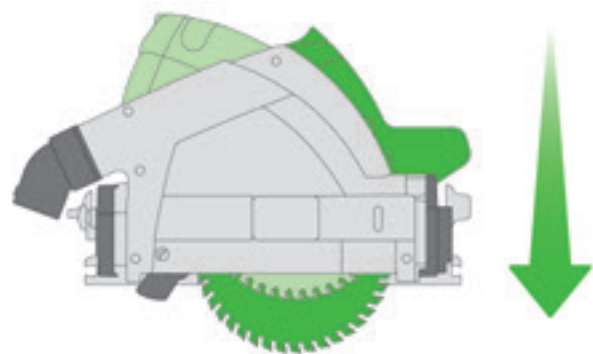

Functional principle of plunge-cut saws

The saw blade plunges into the material at a preset cutting depth. After completing the cut, the saw blade swivels fully back into the housing.

For fast, precise cross-cutting.

The HK 55, HKC 55 and HK 85 portable circular saws.



Quick and precisely angled cuts

Click – and you're ready to go. The circular saws can easily be connected to the FSK cross cutting guide rail. In just a few steps, this produces a portable and easy-to-use compound mitre saw system. This makes it quick and easy for you to cut slats and boards to length.



All-rounders for woodworking

Cutting solid wood to length, joinery work, cutting of boards, square timber or planks – with the Festool circular saws in combination with the cross cutting guide rail, guide rail, parallel side fence or freehand, cuts can be made effortlessly.

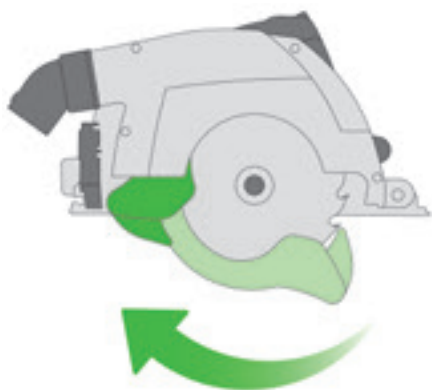

Functional principle of portable circular saws

When sawing, the saw blade is fixed to the set cutting depth. To ensure that the user, workpiece and saw blade are protected, the blade is covered by a pendulum hood.



More independence

For more mobility in timber construction: The cordless circular saw with FSK cross cutting guide rail demonstrates what saws are capable of achieving on construction sites today – with no need for sockets or cable pulling.

Goodbye to dangerous kickbacks. The KickbackStop technology.

Festool has made decisive improvements to the new generation of TSC 55 K cordless plunge-cut saws and the new QUADRIVE – with added intelligent KickbackStop technology. A sensor detects a tool jam in the blink of an eye and stops the motor within a fraction of a second. This reduces the risk of injury to a minimum.





Powerful with extra safety.

The electronic KickbackStop prevents your wrist from twisting dangerously if the drill suddenly becomes caught or jammed, therefore ensuring improved safety when working. A sensor in the electronics continuously monitors the speed in the rotary movement and the twist angle. In the event that the tool jams, the machine switches off in critical situations.

>> Page 188



Our masterpiece.

Now with the one and only KickbackStop.

During sawing with the TSC 55 K, the KickbackStop's feeler wedge rests on the guide rail or on the material that is to be processed. If a kickback occurs when plunging into the workpiece or when sawing, this is immediately detected by the KickbackStop's feeler wedge and emergency braking is triggered. The backwards movement of the plunge-cut saw in the direction of the user is stopped and the risk of injury is therefore minimised.

>> Page 48



Online

For technical experts

You can find the animation for the KickbackStop and additional information at www.festool.co.uk/kickbackstop

Our masterpieces Decisively improved

The plunge-cut saws with 55 mm cutting depth.

Millions of saws don't lie: our plunge-cut saws have always stood out with their absolute precision, maximum power and extreme durability the reliability you've come to expect remains the same – but the working speed is unprecedented: now up to twice as fast in addition, the new generation of cutting blades guarantees perfect cutting quality with maximum cutting performance.

NEW



Plunge-cut saw TS 55 F

The cable variant. Plunge cuts in materials up to 55 mm thick with absolute precision, high power and considerable durability.

Cordless plunge-cut saw TSC 55 K

The best cordless plunge-cut saw is now even safer: The unique KickbackStop not only protects the workpiece but also minimises the risk of injury.

NEW



Brushless
EC-TEC motor





More safety, more comfort

The spring-loaded guide wedge runs in front of the saw blade to prevent it from jamming and makes it easier to insert the blade in existing joints.

Perfect cuts reduce the need for reworking

With the clip-on splinter guard in combination with the guide rail, it is even possible to saw on both sides without virtually any splinters.



Exceptional torque

The concentrated torque of our plunge-cut saw enables work progress at up to twice the speed with an increased saw blade service life. Our new generation of saw blades impresses users when combined with maximum cutting performance and perfect cutting quality.



Perfect results

With their reduced cutting width, teeth shapes and carbide saw teeth, the new saw blades, which are perfectly designed for our plunge-cut saws, ensure a high degree of cutting quality and extended service life – while maintaining a consistent cutting quality.

The cordless plunge-cut saw.
With exceptional KickbackStop technology.

The integrated KickbackStop reduces the risk of injury caused by kickback during sawing or plunge-cutting into the workpiece. It stops the TSC 55 K saw blade in the blink of an eye. Once the saw has been triggered, it is ready for use straight away without replacements or additional costs.



For more details about the KickbackStop technology see page 46

Large saw with depth.

The plunge-cut saw with 75 mm cutting depth.

Follows only one line. Accurate to the millimetre and without splinters. With the necessary force for each material – lightweight and easy to handle. The motor, with three bearings includes MMC electronics for an exceptional service life. The TS 75 combines considerable power in a compact device.

Plunge-cut saw TS 75

Precise plunge cuts in materials up to 75 mm thick.



Optimum cutting quality

For high-quality working results: The guide rail guarantees clean, splinter-free cuts. The TS 75 is fitted with guide jaws that do not require tools to be adjusted, in order to enable the saw to operate without any inaccuracy.



Safe and clean insertion

The spacer wedge is spring loaded and slides back into the housing automatically when placed on the workpiece. Once the machine is inserted, the spacer wedge moves into the saw groove and prevents the saw blade from getting jammed. This means that the spacer wedge is always on the saw, ensuring safety at all times.











Technical data	TS 55 F	TSC 55 K	TS 75
Power consumption (watt)	1.200	–	1.600
Battery voltage (V)	–	18/36	–
Idle engine speed (RPM)	2.000 – 5.800	2.650 – 3.800/5.200	1.350 – 4.400
Saw blade diameter (mm)	160	160	210
Angular range (°)	–1 – 47	–1 – 47	0 – 47
Cutting depth (mm)	0 – 55	0 – 55	0 – 75
Cutting depth 45° (mm)	43	43	55
Dust extraction connection dia. (mm)	27/36	27/36	27/36
Battery capacity (Ah)	–	5,2	–
Weight (kg)	4,5	–	6,2
Weight 1 x 18 V/2 x 18 V (kg)	–	4,6/5,3	–











Applications

Cutting recesses in kitchen worktops	●	●	●
Cutting doors to length	●	●	●
Cutting chipboard to size	●	●	●
Cutting house doors to size, up to 75 mm thick	○	○	●
Window apertures for glass inserts	●	●	●
Cutting out old wooden flooring	●	●	●
Cutting veneered or plastic-laminated board	●	●	●
Sawing and cutting a plank to length	○	○	●

Extremely appropriate ●
Appropriate ○

02 Sawing and oscillating

Items included	RRP in £*	Order no.
TS 55 F	All variants: circular saw blade WOOD FINE CUT HW 160 x 1, 8 x 20 WD42, splinterguard, Flag window; vision panel, hex key, WAF 5, Systainer SYS3 M 337	
	442.00 530.40	576707
TS 55 FEQ-Plus 110V		
	442.00 530.40	576706
TS 55 FEBQ-Plus 240V		
	528.00 633.60	577013
TS 55 FEQ-Plus-FS 110V guide rail FS 1400/2		
	528.00 633.60	577012
TS 55 FEBQ-Plus-FS 240V guide rail FS 1400/2		
TSC 55 K	All variants: circular saw blade WOOD FINE CUT HW 160 x 1, 8 x 20 WD42, splinterguard, Flag window; vision panel, chip collection bag, hex key, WAF 5, Systainer SYS3 M 437	
	468.00 561.60	576712
TSC 55 KEB-Basic without battery pack, without charger		
	720.00 864.00	576716
TSC 55 5,2 KEBI-Plus/XL 2 x BP 18 Li 5.2 ASI battery pack, 2 x rapid charger TCL 6		
	805.00 966.00	577007
TSC 55 5,2 KEBI-Plus/XL-FS 2 x BP 18 Li 5.2 ASI battery pack, 2 x rapid charger TCL 6, guide rail FS 1400/2		
TS 75	All variants: circular saw blade WOOD UNIVERSAL HW 210 x 2, 4 x 30 W36, splinterguard, hex key, WAF 5, SYS 5 TL Systainer	
	656.00 787.20	561439
TS 75 EQ-Plus 110V		
	741.00 889.20	561259
TS 75 EQ-Plus-FS 110V guide rail FS 1400/2		
	656.00 787.20	561441
TS 75 EBQ-Plus 240V set-back stop FS-RSP		
	741.00 889.20	561514
TS 75 EBQ-Plus-FS 240V set-back stop FS-RSP, guide rail FS 1400/2		

Accessories		RRP in £*	Order no.
Parallel side fence All variants: can also be used as table extension, parallel guide, guided on both sides, max. workpiece width 100 mm			
	PA-TS 55 for TS 55, TS 55 R, TS 55 F, TSC 55, TSC 55 K	43.30 51.96	491469
	PA-TS 75 for TS 75	49.50 59.40	492243
	Cover ABSA-TS 55 for TS 55, TS 55 R, TS 55 F, TSC 55, TSC 55 K, can also be used as false joint set, cover for improved dust extraction, width of the shadow gap TS 55 15 - 46 mm	42.90 51.48	491750
Splinter guard All variants: can be used with or without guide rail, for low-splinter cuts to the right of the saw blade, qty. in pack 5 Units			
	SP-TS 55 R/5 for TS 55 R, TS 55 F, TSC 55, TSC 55 K	13.00 15.60	499011
	SP-TS 55/5 for TS 55, TS 75	13.00 15.60	491473
	Kickback stop FS-RSP for TS 55, TS 55 R, TS 55 F, TSC 55, TSC 55 K, TS 75, HKC 55, HK 55, ATF 55, AP 55, AT 65, AP 65, AP 85, can also be used as guide stop, used as a rear and front stop position on guide rail FS/2	15.20 18.24	491582
	Guide-rails from page 59		
	Battery and charging technology from page 28		
	Chip collection bag SB-TSC for TSC 55, TSC 55 K, HKC 55, folds down for space-saving transportation, for all woods, with dust cap	31.30 37.56	500393
	Saw blades from page 76		

Even better cutting performance. Using systems.

As individual tools, they are already an attractive option; as a combined system, they are certain to amaze and impress. Whether with a guide rail, angle stop, parallel side fence, multifunction table or effortless connection to a dust extractor, everything is compatible and optimises your work.

You can find more information on page 316



* Manufacturer's recommended retail price. Dealer prices may vary. Excl. VAT. | Incl. VAT.

Versatility for wooden structures – even with a battery.

The portable circular saws with 55 mm cutting depth.

The compound mitre saw system for more independence combines precision and efficiency with a high level of user-friendliness, optimised ergonomics and ease of use. Features such as the cutting-depth adjustment with plunge cut function, hinged-cover remote control, guide wedge and FastFix saw blade change, for example, provide the best possible working conditions. And the FSK cross cutting guide rail produces precise cuts with repeat accuracy.

Portable circular saw HK 55

The cable variant. For rip and cross cuts in materials up to 55 mm thick. The high-torque 1200 W motor with power electronics ensures constant power when sawing.



Brushless
EC-TEC motor

Cordless circular saw HKC 55

Mobility and independence in any position with the brushless EC-TEC motor combined with a powerful 18 V lithium-ion battery for maximum cutting power. For rip and cross cuts in materials up to 55 mm thick.





Reproducible

Make cross cuts at accurate angles quickly anywhere with the FSK cross cutting guide rail.



Guide wedge for a high level of safety

The guide wedge enables unobstructed, stress-free and therefore safe sawing. As it is integrated into the spring-mounted pendulum hood, it is also possible to carry out plunge cuts in a safe and unobstructed way.



Pendulum hood remote control

To enable a clear view of the saw blade, the pendulum guard can be moved backwards from the front handle. This uncovers the saw blade and ensures your hands always remain at a safe distance from the saw blade.



Scribe mark = cut

Precision work, even for mitre cuts of up to 50°. When sawing in combination with the guide or cross cutting guide rail, the scribe line will always follow the cutting edge exactly, even when mitre cutting.

Reproducible. The FSK cross cutting guide rail.

Coupling the HK 55, HKC 55 and HK 85 with the FSK cross cutting guide rail, which is available in three lengths, is incredibly easy. In no time at all, you have a mobile, easy-to-handle compound mitre saw system for quick and accurately angled crosscuts.

You can find more information on page 59

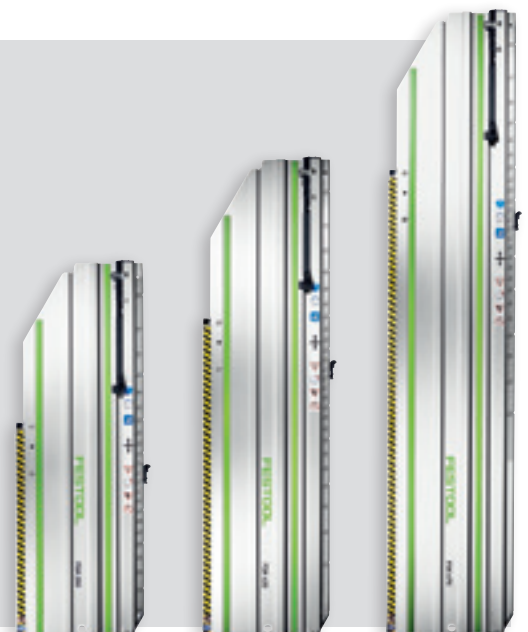

The timber construction all-rounder.

The portable circular saw with 85 mm cutting depth.

Whether you are cutting solid timber, performing joining work, cutting planks, square timber or boards, sawing tenons or cutting panel materials of all types – the robust 1900-watt HK 85 ideally combines performance and ease of use with numerous equipment options and unique accessories. Cutting-depth adjustment with plunge-cut function, hinged-cover remote control and guide wedge make the tool safe and convenient to use.



Portable circular saw **HK 85**

Powerful portable circular saw
with a cutting depth of 85 mm.



From portable circular saw to groove router

With the adjustable groove cutter conversion kit, the versatile HK 85 becomes a groove router for transverse and longitudinal grooves, making it a real all-rounder. For grooves with a width of 16 mm to 25 mm and a depth of up to 35 mm.









Scribe mark = cut

Precision work, even for mitre cuts of up to 60°. When sawing in combination with the guide or cross cutting guide rail, the scribe line will always follow the cutting edge exactly, even when mitre cutting.

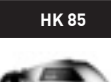

Technical data	HK 55	HKC 55	HK 85
Power consumption (watt)	1.200	–	1.900
Battery voltage (V)	–	18	–
Idle engine speed (RPM)	2.000 – 5.400	4.500	3.500
Saw blade diameter (mm)	160	160	230
Angular range [°]	0 – 50	0 – 50	0 – 60
Cutting depth 0°, 90° (mm)	0 – 55	0 – 55	0 – 86
Cutting depth 45°/50° (mm)	42/38	42/38	–
Cutting depth at 45°/60° (mm)	–	–	62/47
Dust extraction connection dia. (mm)	27/36	27/36	27/36
Battery capacity (Ah)	–	5,2	–
Weight (kg)	4,4	–	6,8
Weight with battery (kg)	–	4,1	–

Items included	RRP in £*	Order no.
HK 55 All variants: circular saw blade WOOD STANDARD HW 160 x 1, 8 x 20 W18, hex key, WAF 5, Systainer SYS3 M 337		
 HK 55 EBQ-Plus 240V	338.00 405.60	576124
 HK 55 EBQ-Plus-FSK 240V FSK 420 trimming rail	491.00 589.20	576134
HKC 55 All variants: circular saw blade WOOD STANDARD HW 160 x 1, 8 x 20 W18, hex key, WAF 5, Systainer SYS3 M 337		
 HKC 55 EB-Basic without battery pack, without charger	330.00 396.00	576163
 HKC 55 5,2 EBI-Plus-SCA 2 x BP 18 Li 5.2 ASI battery pack, SCA 8 rapid charger	591.00 709.20	576166
 HKC 55 5,2 EBI-Set-FSK 420 2 x BP 18 Li 5.2 ASI battery pack, SCA 8 rapid charger, FSK 420 trimming rail	744.00 892.80	576170
HK 85		
 HK 85 EB-Plus 240V circular saw blade WOOD STANDARD HW 230 x 2, 5 x 30 W24, parallel side fence, hex key, WAF 5, Systainer SYS3 M 437	567.00 680.40	576146

* Manufacturer's recommended retail price. Dealer prices may vary.















Excl. VAT. | Incl. VAT.

Vibration and emissions values can be found in the operating manual at www.festool.co.uk/vibration

02 Sawing and oscillating

Applications	HK 55	HKC 55	HK 85
Cutting roof battens to length	●	●	-
Sawing boards to size	●	●	○
Sawing chipboard	●	●	○
Cutting tenons in beams	●	●	●
Splitting tenons	-	-	●
Tapering square timber and rafters	-	-	●
Cutting sandwich elements to length	-	-	●

Extremely appropriate ●
Appropriate ○

Accessories	RRP in £*	Order no.
Cross cutting guide rail All variants: for HKC 55, HK 55, HK 85, fastening clamp FSZ 120		
 FSK 250 cutting length 250 mm, angular range -45 – +60°, weight 0,98 kg	132.50 159.00	769941
 FSK 420 cutting length 420 mm, angular range -60 – +60°, weight 1,26 kg	153.00 183.60	769942
 FSK 670 cutting length 670 mm, angular range -60 – +60°, weight 1,63 kg	173.30 207.96	769943
Bag All variants: transport bag with shoulder straps		
 FSK420-BAG for FSK 250, FSK 420	50.10 60.12	200160
 FSK670-BAG for FSK 670	60.30 72.36	200161
 Kickback stop FS-RSP for TS 55, TS 55 R, TS 55 F, TSC 55, TSC 55 K, TS 75, HKC 55, HK 55, ATF 55, AP 55, AT 65, AP 65, AP 85, can also be used as guide stop, used as a rear and front stop position on guide rail FS/2	15.20 18.24	491582
Parallel side fence		
 PA-HKC 55 for HKC 55, HK 55, can also be used as table extension, parallel guide, guided on both sides	41.90 50.28	576912
 PA-HK 85 for HK 85, can also be used as table extension, parallel guide, guided on both sides	49.00 58.80	576911
 PA-A-HK 85 for HK 85, bilateral offset parallel stop	79.60 95.52	574670
 Groove unit VN-HK85 130X16-25 for HK 85, routing transverse and longitudinal grooves; routing depth 0-35 mm and routing width adjustable by 16-25 mm, reversible blades HW-WP 14x14x2, adjustable groove cutter diameter 130 x 16-25 mm, protective cover (fixed), protective cover (moveable), Clamping flange, Counter flange, Spacer, Systainer SYS3 M 137, dust extraction connection dia. 36 mm, weight 0,9 kg	478.70 574.44	576803
 Reversible blade HW-WP 14x14x2/12 for HK85 adjustable groove cutter, dimensions [L x W x H] 14 x 14 x 2 mm, qty. in pack 12 Units	59.40 71.28	574671
 Guide-rails from page 59		
 Battery and charging technology from page 28		
 Chip collection bag SB-TSC for TSC 55, TSC 55 K, HKC 55, folds down for space-saving transportation, for all woods, with dust cap	31.30 37.56	500393
 Saw blades from page 76		

The FS guide rail.

Safe and dead-straight machine guidance.

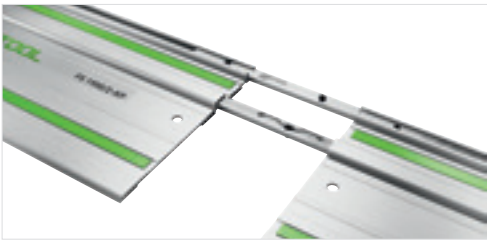

Connect comfortably

The self-aligning connecting piece makes it quick and convenient to connect guide rails so that they are straight. For long, straight cuts.



No splinters

The rubber lip right at the scribe mark works as a splinter guard and prevents the edges from splintering even with angled cuts.



Precision at any angle

The angle stop for the guide rail – for precise and fast angled cuts. Angles of -60° to $+60^\circ$ can be set with repeat accuracy and high precision.

The FSK cross cutting guide rail.

Fast, guided cross cuts at accurate angles.



Stop system

The fixed positioning bolt and the adjustable stop allow angled cuts from -60° to $+60^\circ$ to be made and repeated exactly. For simple work, the most common angle settings are locked into place in the rail.



Quick-acting closure

The circular saws can be connected to or disconnected from the cross cutting guide rail in an instant depending on whether you are sawing with guidance or freely by hand.



Retraction function

To ensure that it is always ready for use, the cross cutting guide rail has an adjustable stop and an integrated rubber spring that brings the saws back to their starting position.

Perfect results, a versatile range of applications and mobility – a perfect combination.

The compact KAPEX sliding compound mitre saws with a cutting depth of up to 60 mm.

The KAPEX KS 60 and KSC 60 sliding compound mitre saws produce high-precision cross-cuts – in an enormous range of applications with mitre angles of up to 60° on each side and bevel angles of up to 47° on each side. The twin-column guide with two bearings ensures that the saw blade is guided smoothly and with precision whichever setting is chosen: This makes every cut perfect, without wobbles or juddering.



Sliding compound mitre saw KAPEX KS 60



Dispenses with everything not needed for the job, such as every unnecessary gram of weight. With impressive features such as ergonomically positioned carrying handles, a cord holder and a transport safety device.

Cordless sliding compound mitre saw KAPEX KSC 60

With maximum battery power: In conjunction with the dual battery system, the brushless EC-TEC motor provides virtually unlimited endurance.



Brushless EC-TEC motor





Maximum precision

Dual ball bearings: The Festool twin-column guide ensures smooth, reliable guidance of the saw blade and maximum precision – without wobbles or juddering.



Optimum visibility of the scribe mark

The LED spotlight projects the saw blade shadow onto the material, indicating the exact cutting line.



Unlimited mobility

With ergonomic carrying handles, cord holder and a transport safety device, in addition to an extremely compact, lightweight design thanks to flush-mounted guide rods.



Maximum power, virtually unlimited endurance

There is no noticeable difference because the combination of the brushless EC-TEC motor and the dual battery system (2 x 18 V) makes our new KSC 60 as impressively powerful as a mains-powered tool – whilst providing full mobility.

**Clever accessories:
Saves time and
eliminates errors.**

The bevel for rapid measurement of interior and exterior corners and subsequent simple and precise transfer to the saw.

You can find more information on page 65



Quality down to the finest detail.

The KAPEX sliding compound mitre saw with a cutting depth of up to 120 mm.

Compact, lightweight, unbeatable comfort and versatile: For precision results in the workshop or during assembly. With spherical bushings on both sides to offer a double layer of protection in terms of keeping the carriage precisely on course across extra-large columns.

Sliding compound mitre saw

KAPEX KS 120

With dual line laser for precise marking, easily accessible precision adjustment to enable the saw blade angle to be set with millimetre accuracy and integrated extra mitre position for cutting depths up to a maximum of 120 mm.



Even greater comfort

The KS 120 features precision adjustment for setting the saw angle accurate to the millimetre. As with all important control elements, quick and convenient adjustment from the front of the machine.



Quality down to the finest detail

The KS 120 boasts a dual-line laser for accurately marking the saw cut.

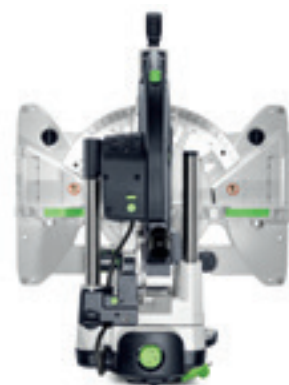

Extra large dimensions with dual ball bearings

The Festool twin-column guide guarantees reliable, smooth guidance of the saw blade and represents maximum precision.



Technical data	KS 60	KSC 60	KS 120
Power consumption (watt)	1.200	–	1.600
Battery voltage (V)	–	18/36	–
Idle engine speed (RPM)	1.300 – 3.500	1.300 – 1.800/3.500	1.400 – 3.400
Saw blade diameter (mm)	216	216	260
Cutting depth 90°/90° (mm)	305 x 60	305 x 60	305 x 88
Cutting depth at 45°/90° (mm)	215 x 60	215 x 60	215 x 88
Special cutting depth 90°/90° (mm)	–	–	60 x 120
Cutting depth 45°/45° (left) (mm)	215 x 40	215 x 40	215 x 55
Crown moulding diagonal cut 45°/90° (mm)	–	–	168
Inclination angle (°)	47/46	47/46	47/47
Mitre angle (°)	60/60	60/60	50/60
Dust extraction connection dia. (mm)	27/36	27/36	27/36
Battery capacity (Ah)	–	5,2	–
Weight (kg)	17,8	–	23,1
Weight 1 x 18 V/2 x 18 V (kg)	–	17,1/18,5	–

Applications

Trimming beams and boards up to 60 mm thick	●	●	●
Trimming beams and square timber up to 88 mm thick	–	–	●
Sawing panels, laminate and strips	●	●	●
Trimming aluminium and other non-ferrous metal profiles	●	●	●
Cutting grooves to a defined depth	●	●	●
Trimming skirting boards and cornices up to 120 mm in height	–	–	●
Trimming skirting board along the bisector	○	○	○

Extremely appropriate ●

Appropriate ○



More mobile with the underframe: Compatible with all KAPEX models.









The underframe takes all KAPEX models up to a working height that is easier on the back and can be set up quickly and easily using a cleverly designed folding mechanism. The additional trimming attachments enable precise working with the extension arm up to a cutting length of 2.4 m.





You can find more information on page 64











02 Sawing and oscillating

Items included	RRP in £*	Order no.
KS 60	All variants: circular saw blade WOOD UNIVERSAL HW 216 x 2, 3 x 30 W36, fastening clamp FSZ 120, hex key, WAF 6	
 KS 60 E 110V	627.00 752.40	561685
KS 60 E 240V	627.00 752.40	561684
KS 60 E-SET 110V LED spotlight, Bevel, elevation	726.00 871.20	561693
KS 60 E-SET 240V LED spotlight, Bevel, elevation	726.00 871.20	561729
KSC 60	All variants: circular saw blade WOOD UNIVERSAL HW 216 x 2, 3 x 30 W36, fastening clamp FSZ 120, LED spotlight, Bevel, elevation, chip collection bag, hex key, WAF 6	
 KSC 60 EB-Basic	765.00 918.00	576847
KSC 60 EB 5,2 I-Plus energy set, SYS 18 V 2 x 5.2/TCL 6 DUO	1,029.00 1,234.80	577175
KSC 60 EB 5,2 I-UG-Set energy set, SYS 18 V 2 x 5.2/TCL 6 DUO, underframe, KA-UG-KS 60 R/L trimming stop	1,793.00 2,151.60	577179
KS 120	All variants: circular saw blade WOOD UNIVERSAL HW 260 x 2, 5 x 30 W60, Bevel, workpiece clamp, hex key, WAF 6	
 KS 120 REB 110V	1,214.00 1,456.80	575305
KS 120 REB 240V	1,214.00 1,456.80	575304
KS 120 Set-UG 110V underframe, trimming attachment KA-UG-R/L, adjustable stop, telescopic slide-out scale, fold-out pedestal	1,978.00 2,373.60	575316
KS 120 Set-UG 240V underframe, trimming attachment KA-UG-R/L, adjustable stop, telescopic slide-out scale, fold-out pedestal	1,978.00 2,373.60	575315

Accessories for KS 60 and KSC 60 sliding compound mitre saws	RRP in £*	Order no.
Trimming attachment All variants: for KS 60, KSC 60, for use in conjunction with the Festool UG-KAPEX KS 60 base frame, adjustable stop, telescopic slide-out scale, fold-out pedestal, measurement scale, length of extension arm (without telescope) 1.480 mm, max. meas. length 2.400 mm		
 KA-UG-KS 60-L weight 4,6 kg	210.20 252.24	201907
KA-UG-KS 60-R weight 4,6 kg	210.20 252.24	201908
 KA-UG-KS 60-R/L comprising KA-UG-L trimming attachment and KA-UG-R trimming attachment	419.90 503.88	201909
 Adapter plate UG-AD-KS 60 for KS 60, KSC 60, adapter plate and saw blade holder for attaching the KS 60 to the UG-KAPEX KS 60 base frame	102.80 123.36	202056
Underframe All variants: for KS 60, KSC 60, simple folding in for transport, work height 900 mm		
 UG-KS 60 weight 13 kg	344.20 413.04	200129
 UG-KA-KS 60 Set (KA-UG-R and KA-UG-L trimming attachments incl. in the contents), underframe, KA-UG-KS R/L trimming attachment, weight 21 kg	764.10 916.92	202055
 Increase A-SYS-KS 60 for KS 60, KSC 60, intermediate bases for elevating the KS 60 to the height of a Systainer SYS 1 T-LOC and Classic, Table height = Systainer: Long workpieces can be comfortably supported on the floor while working, for retrofitting the KS 60, items already included with the KS 60 set variants	28.50 34.20	500121
 Spot lighting SL-KS 60 for KS 60, LED spot lighting for precisely highlighting the cutting line and optimal visibility of the scribe mark, for retrofitting the KS 60, items already included with the KS 60 set variants	48.00 57.60	500120
 Chip collection bag SB-KSC for KSC 60, ensures a dust-free working environment with maximum mobility	36.00 43.20	577173

Accessories for compound mitre saw KAPEX KS 120		RRP in £*	Order no.
Trimming attachment All variants: for KS 120, KS 88, for use in conjunction with the Festool UG-KAPEX KS 120 base frame, measurement scale, adjustable stop, telescopic slide-out scale, fold-out pedestal, length of extension arm (without telescope) 1.480 mm, max. meas. length 2.400 mm			
	KA-UG-KS 120-L weight 4,6 kg	210.20 252.24	497353
	KA-UG-KS 120-R weight 4,6 kg	210.20 252.24	497352
	KA-UG-KS 120-R/L comprising KA-UG-L trimming attachment and KA-UG-R trimming attachment	419.90 503.88	497514
	Crown stop AB-KA-UG/2 for KS 120, KS 88, KS 60, KSC 60, stop for positioning crown mouldings at an angle, only compatible with KA-UG trimming attachment underframe, qty. in pack 2 Units	88.50 106.20	203356
Underframe All variants: for KS 120, KS 88, simple folding in for transport, transport rollers, work height 900 mm			
	UG-KAPEX KS 120 weight 10,1 kg	344.20 413.04	497351
	UG-KA-KS 120-Set underframe, trimming attachment KA-UG-R/L, weight 21 kg	764.10 916.92	497354

Accessories for compound mitre saw KAPEX KS 120		RRP in £*	Order no.
	Multifunction table MFT KAPEX used as a base frame for the KAPEX, clamping kit SZ-KS required for fixing, table with perforated top and foldaway legs, table dimensions 869 x 581 mm, work height/with foldaway legs 180 mm, working height with legs 790 mm, load capacity 120 kg, weight 19 kg	351.00 421.20	495465
	Adjustable stop KA-AR for KA-KS 120-L trimming attachment and KA-KS 120-R trimming attachment, for CS 50, CS 70, for positioning workpieces on trimming attachment CS 70 KA, Basis KA 100/200 and KA-KS L/R	31.10 37.32	488560
	Crown stop AB-KS 120 for KS 120, KS 88, stop for positioning crown mouldings at an angle, also used for securing the table extension KA-KS, only compatible with KA-KS, crown moulding stop with table widener	63.30 75.96	494369
	Terminal KL-KS 120 for KS 120, KS 88, can be used on the left or right, workpiece clamp for securing workpieces, included in the contents of the KS 120, maximum height of workpiece 120 mm	46.30 55.56	494391

Other accessories		RRP in £*	Order no.
	Clamping kit SZ-KS for KS 120, KS 88, KS 60, KSC 60, for tightening the KS on the multifunction table	13.30 15.96	494693
	Bevel SM-KS for KS 60, KSC 60, KS 120, bevel for transferring angles to the circular cross-cut saw, for interior and exterior angles, dissecting angle is generated automatically, no calculations	76.50 91.80	200127
	Battery and charging technology from page 28		
	Saw blades from page 76		

Trimming strips could not be easier. The SYMMETRIC compound mitre saw.

Precision has never been simpler: Measure the angle, transfer it, always saw along the bisecting line without having to perform any calculations, and you're done. The SYMMETRIC SYM 70 lets you work considerably faster thanks to the symmetrical stop system. Making exterior angles up to 60° and interior angles up to 68° is easy.



Compound mitre saw
SYMMETRIC SYM 70

Technical data	SYM 70
Power consumption (watt)	1.150
Idle engine speed (RPM)	2.700 – 5.200
Saw blade diameter (mm)	216
Interior angle [°]	0 – 68
Exterior angle [°]	0 – 60
Max. strip height (mm)	70
Max. strip width (mm)	80
Dust extraction connection dia. (mm)	27/36
Weight (kg)	9,6



Sawing without the need for calculations

It really doesn't get much simpler – use the bevel to measure the angle from the wall or recess, transfer it over to the stop system and make the cut.



A firm grip





The stop jaws on the SYMMETRIC can be locked to prevent the set angle from changing while you work. Whether interior angles up to 68° or exterior angles up to 60°, everything stays in the right position.



Clever accessories

The additional feet raise the workbench of the SYM 70 to the exact height of a Systainer³ M 112 or SYS 1 T-LOC. It can then be used as a workbench to support long workpieces safely and securely.

Items included	RRP in £*	Order no.
SYM 70		
 SYM 70 RE circular saw blade WOOD FINE CUT HW 216 x 2, 3 x 30 W48, precision adjustable square, elevation of EH-SYS-SYM 70, workpiece clamp, hex key, WAF 5	not available in Great Britain	574927

Accessories	RRP in £*	Order no.
 Table top insert TE-SYM 70 for SYM 70, qty. in pack 3 Units	19.40 23.28	491054
 Additional stop ZA-SYM 70 E for SYM 70, for cutting undercut strips, qty. in pack 2 Units	43.00 51.60	491886
 Precision adjustable square SM-SYM 70 for SYM 70	27.70 33.24	491053
 Increase EH-SYS-SYM 70 for SYM 70, intermediate bases for elevating the SYM 70 to the height of a SYS 1 T-LOC and Classic Systainer, table height = Systainer: Long workpieces can be conveniently supported while working, already included in scope of delivery for SYM 70 RE (for retrofitting to the SYM 70 E)	27.10 32.52	203425
 Saw blades from page 76		

* Manufacturer's recommended retail price. Dealer prices may vary. Excl. VAT. | Incl. VAT.

Your fingers – invaluable!

The TKS 80 bench-mounted circular saws with SawStop AIM technology.

Sawing is part and parcel of your everyday work. You place great emphasis on adhering to the highest levels of precision and producing the best cutting results. Even when it comes to larger workpieces, flawless quality is always on your mind. To help you meet these high standards, we have developed the perfect tool – the new TKS 80 bench-mounted circular saw. Thanks to the intelligent SawStop AIM technology, you no longer have to worry about your fingers. Your fingers are your most important tools, and we will ensure they are protected from serious cuts and injuries while you concentrate on your work.

Table saw

TKS 80

The sensitive sensors of the integrated SawStop AIM technology ensure safe sawing.



5000 casualties per year
20 injuries per workday
30% serious injuries*



The BG BAU awards the EuroTest prize for outstanding achievements in occupational health and safety to Festool again in 2019.

SawStop AIM technology Reduces the risk of serious cutting injuries.

Top-quality products and protecting users' health are two important driving factors behind Festool's product development. Working with these criteria in mind, we inspect all innovations and assess the use of new technologies in order to make your daily work easier, safer and more efficient. We want our users to know that they can rely on Festool tools now and in the future, which is why our engineers are already working on innovative technology for the tools you will use in years to come.

Online

**Web special for SawStop
 AIM technology:
www.festool.co.uk/sawstop**



Added safety

The core component of the technology is a cartridge that drives an aluminium block into the saw blade at 500 N with the aid of a spring if it comes into contact with human skin during operation. The saw blade stops within five milliseconds and disappears from the hazardous area into the machine table. This prevents serious injuries from cuts.

Bypass option

SawStop AIM technology can, if necessary, be deactivated. This means that even conductive materials can be machined using the saw.



Flexible cutting height

Flexible cutting height up to 80 mm for larger cross cuts.



Sophisticated

The intelligent electronics in the SawStop AIM control system continuously monitor the operating condition of the complete system: Is the key inserted? Is a cartridge pretensioned? And is the saw blade also installed correctly? Is the distance between the aluminium block and saw blade correct?



Maximum precision

Fewer splinters on the upper surface of the material in mitre rip cuts by swivelling the saw blade to the left. More space for your hands and a clear view of the workpiece.









Healthier working with a system

Dust extraction attachment with CLEANTEC extraction sleeve ensures dust-free work and a free view of the workpiece.

Technical data	TKS 80
Power consumption (watt)	2.200
Idle engine speed (RPM)	1.700 – 3.500
Saw blade diameter (mm)	254
Cutting height 90°/45° (mm)	80/56
Inclination (°)	-2 / 47
Table dimensions (mm)	690 x 580
Table height, legs folded away (mm)	385
Table height, legs unfolded (mm)	900
Dust extraction connection dia. (mm)	27/36
Weight (kg)	37

Items included	RRP in £*	Order no.
TKS 80 All variants: circular saw blade WOOD UNIVERSAL HW 254 x 2, 4 x 30 W40, KT-TKS 80 cartridge, angle stop, dust extraction set, workpiece holder, hex key, WAF 5, 1 open ended spanner, size 50, 1 open ended spanner, size 23		
 TKS 80 EBS 240 V	1,640.00 1,968.00	575784
TKS 80 EBS-Set 240V extension table VB TKS 80, guide extension VL TKS 80, LA TKS 80 stopper, sliding table ST TKS 80	2,726.00 3,271.20	575831

Accessories	RRP in £*	Order no.
 Guide extension VL TKS 80 for TKS 80, for safe and precise sawing to length, extends the support area by 580 mm, easy and quick to assemble and dismantle, with adjustable dimension scale	238.00 285.60	575825
 Extension table VB TKS 80 for TKS 80, for safe and precise width sawing, extends the support area by 411 mm, maximum cutting width with 680 mm rip cut, with adjustable dimension scale, easy and quick to assemble and dismantle	334.80 401.76	575840
 Stopper LA TKS 80 for TKS 80, with fine adjuster for precise rip cuts, front operating lever, clamp for secure mounting on the bench-mounted circular saw, moveable stop profile	234.90 281.88	575826
 Sliding table ST TKS 80 for TKS 80, for cross-cutting with a cutting width up to 920 mm, with four plastic rollers to ensure that the sliding table moves smoothly, can be installed in two positions for a large work area	277.90 333.48	575827
 Cartridge KT-TKS 80 for TKS 80, replacement cartridge, contains the central element of the TKS 80: SawStop AIM technology	80.60 96.72	575851
 Saw blades from page 76		

* Manufacturer's recommended retail price. Dealer prices may vary.

Excl. VAT. | Incl. VAT.

Vibration and emissions values can be found in the operating manual at www.festool.co.uk/vibration

Versatility made easy.

The PRECISIO trimming saws.

Cross or rip cuts. Mobile or stationary. Interior fitting, furniture-making or exhibition stand fitting. Diverse tasks, one solution: The PRECISIO CS 50 and CS 70 – lightweight and sophisticated functions.



Trimming saw **PRECISIO CS 50**

Cross cuts up to 300 mm wide at a 90° angle,
cross cuts up to 200 mm wide at a 45° angle
and with a cutting height of 52 mm.

Trimming saw **PRECISIO CS 70**

Cross cuts up to 320 mm wide at a 90° angle,
cross cuts up to 226 mm wide at a 45° angle
and with a cutting height of 70 mm.





Fast changeover from cross to rip cuts

The angle stop can be rotated by 180° and can be used easily on either side. The CS 50 can therefore be changed from the cross-cut to the rip-cut position in no time at all.

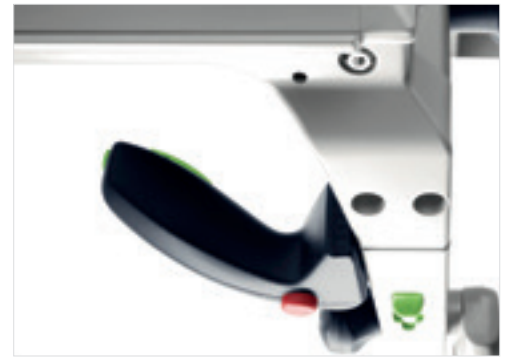

One handle for all functions

On/off switch, speed adjustment, quick start/stop functions and guiding mechanism – all of the most important control elements are integrated and clearly arranged in the multifunctional handle on the CS 50.



Mobile or stationary

Comprehensive system accessories allow you to upgrade the CS 70 to a complete sawing station with minimal effort, enabling you to make cross cuts on materials that exceed standard dimensions.













Technical data	CS 50	CS 50 Set	CS 70	CS 70 Set
Power consumption (watt)	1.200	1.200	2.100	2.100
Idle engine speed (RPM)	1.600 – 4.200	1.600 – 4.200	2.000 – 4.200	2.000 – 4.200
Saw blade diameter (mm)	190	190	225	225
Cutting height 90°/45° (mm)	0 – 52/0 – 37	0 – 52/0 – 37	0 – 70/0 – 48	0 – 70/0 – 48
Inclination (°)	0 [–2]° – 45 [+47]	0 [–2]° – 45 [+47]	0 [–2]° – 45 [+47]	0 [–2]° – 45 [+47]
Cutting path (mm)	304	304	320	320
Table dimensions (mm)	585 x 400	585 x 400	690 x 500	690 x 500
Table height, legs folded away (mm)	333	333	375	375
Table height, legs unfolded (mm)	900	900	900	900
Dust extraction connection dia. (mm)	27/36	27/36	27/36	27/36
Weight (kg)	21,9	42,9	37	68,5

02 Sawing and oscillating

Applications	CS 50	CS 50 Set	CS 70	CS 70 Set
Sawing panels and laminate	●	●	●	●
Rip cuts in boards and panels	●	●	●	●
Cutting plastic and steel cable ducts to size	○	○	●	●
Cutting grooves to a defined depth	○	○	○	○
Trimming aluminium and other non-ferrous metal profiles	●	●	●	●
Cutting strip material to fit	○	○	○	○
Trimming beams and boards up to 60 mm thick	-	-	●	●
Rip cuts with a cutting depth up to 52 mm	●	●	○	○
Rip cuts with a maximum cutting depth of 70 mm	-	-	●	●

Extremely appropriate ●
Appropriate ○

Items included	RRP in £*	Order no.
CS 50 All variants: circular saw blade WOOD UNIVERSAL HW 190 x 2, 6 FF W32, angle stop, foldaway legs, 3 x splinterguard, dust extraction set, workpiece holder, accessories holder, support with transport roller, hex key, WAF 6  CS 50 EBG 240V	1,197.00 1,436.40	574767
CS 70 All variants: circular saw blade WOOD UNIVERSAL HW 225 x 2, 6 x 30 W32, 3 x splinterguard, angle stop, dust extraction set, workpiece holder, accessories holder, support with transport roller, Air filter, hex key, WAF 6  CS 70 EBG 240V	not available in Great Britain	574780

Accessories for trimming saw CS 50	RRP in £*	Order no.
 Extension table VL for CS 50, CMS-GE, simple fitting, folds away, for safe support of long workpieces when sawing to width, enlarges the support surface by 405 mm, dimensions length x width 375 x 454 mm	200.30 240.36	492092
 Extension table VB for CS 50, with adjustable dimension scale, extends the support area by 410 mm, max. working width longitudinal 610 mm, dimensions length x width 664 x 438 mm	257.40 308.88	492090
 Support AF for CS 50, CMS-GE, support for both side use, supports workpieces while cutting, enlarges the support surface by 300 mm, dimensions length x width 662 x 390 mm	86.00 103.20	492242
 Stopper LA-CS 50/CMS for CS 50, CMS-GE, with fine adjustment and rear clamp, can be operated from front, with moveable stop profile for precise and safe longitudinal cuts	207.40 248.88	574796
 Sliding table ST for MFT 3-VL, for CS 50, CMS-GE, max. working width for trimming cuts 830 mm	286.00 343.20	492100
 Splinter guard CS 50 SP/10 for CS 50, for splinter-free cut edges on both sides, qty. in pack 10 Units	16.80 20.16	492241
 Foldaway legs CS 50 KB for CS 50, makes two work heights possible, foldaway legs for the extension of the CS 50 FLR version	171.80 206.16	575671
 Saw blade holder SGA for CS 50, CMS-GE, for safe and space-saving storage of up to 4 saw blades (max. Ø 190 mm) and up to 3 splinterguards (not included in contents)	42.00 50.40	492228

Accessories for trimming saw CS 70		RRP in £*	Order no.
	Extension table CS 70 VL for CS 70, simple fitting, folds away, for safe support of long workpieces when sawing to width, extends the support area by 580 mm, dimensions length x width 525 x 522 mm	245.30 294.36	488061
	Extension table CS 70 VB for CS 70, with adjustable dimension scale, easy and quick to assemble and dismantle, for safe and precise width sawing, extends the support area by 411 mm, max. working width longitudinal 680 mm, dimensions length x width 773 x 435 mm	344.60 413.52	488060
	Trimming attachment CS 70 KA for CS 70 and CS 50, removable, with support, bearing surface, tape measure and adjustable stop, simple extraction and rolling out of measuring tape thanks to telescopic mechanism, length 1.200 – 2.050 mm	297.80 357.36	488063
	Stopper CS 70 LA for CS 70, MFT/3-VL, with fine adjustment and rear clamp, can be operated from front, with moveable stop profile for precise and safe longitudinal cuts	241.80 290.16	488062
Sliding table All variants: for CS 70, easy and quick to assemble and dismantle			
	CS 70 ST for sawing boards, 2 x supporting legs, stop ruler with additional clamp, max. working width for trimming cuts 920 mm	803.60 964.32	488059
	CS 70 ST 650 max. working width for trimming cuts 650 mm	424.80 509.76	490312
	Transport rollers CS 70 TR for CS 70, can be fitted to foldaway legs, for simple and comfortable transportation	87.40 104.88	488064
	Splinter guard CS 70 SP /10 for CS 70, for splinter-free cut edges on both sides, qty. in pack 10 Units	16.80 20.16	490340
	Dust extraction set AB-AS CS/TKS for CT/CTM, antistatic, comprising: Suction hose D 27x2.0 m-AS, suction hose 36x1 m-AS, Y terminal, can be used with all trimming saws and table saws, diameter 27/36 mm	87.40 104.88	577280
Other accessories		RRP in £*	Order no.
	Adjustable stop KA-AR for KA-KS 120-L trimming attachment and KA-KS 120-R trimming attachment, for CS 50, CS 70, for positioning workpieces on trimming attachment CS 70 KA, Basis KA 100/200 and KA-KS L/R	31.10 37.32	488560
	Angle stop WA for CS 70, CS 50, CMS-GE, for work requiring 2 stops	139.50 167.40	574797
	Adjustable stop WA-AR for CS 50, CS 70, to stop workpieces on trimming attachment CS 70 WA, CS 50 WA and Basis WRA 500	31.10 37.32	491712
	Roller stand RB for all semi-stationary devices (CS/KS/CMS), may be used with the CS 50, CS 70, CB 120, Basis Plus System, CMS-GE, multifunction table, to use longer workpieces for longitudinal sections and cross sections and cutting and grinding work, height adjustable 630 – 1.000 mm	152.70 183.24	488711
	Saw blades from page 76		

Our saw blades. Perfect results.

Our saw blades are precisely tailored to the applications and materials. The combination of our tools and the matching saw blades enable users to achieve the perfect cut.



Colour code

WOOD STANDARD

Perfect for machining blockboard and soft plastics (e.g. PVC).

WOOD RIP CUT

For rapid working with low application of power, especially for rip cuts in solid wood Suitable for hardwood and softwood

WOOD UNIVERSAL

The all-rounder for working with all types of wood and wood materials, as well as building panels and soft plastics

WOOD FINE CUT

The fine-cut saw blade for clean and splinter-free cross cuts in solid wood, laminated or veneered sheet materials and acrylic glass

ALUMINIUM/PLASTICS

Ideal for aluminium panels and profiles as well as for fibre-reinforced and hard plastics

LAMINATE/HPL

Ideal for laminate and melamine-resin-bonded panels (e.g. Trespa®)

STEEL

For optimal cuts in composite panels, steel, false floors and cable ducts.

ABRASIVE MATERIALS

The solution for cement-bonded and gypsum-bonded chipboard and fibreboard

Tooth shapes



CROSS-CUT TOOTH

The teeth are slanted on the left and right and cut alternately. This reduces the load on the individual teeth, causing the saw blade to run smoothly and have a longer service life. In addition, this toothing ensures ideal cutting quality.



TRAPEZOIDAL CROSS-CUT TOOTH

In addition to the cross-cut teeth, a "trapezoidal tooth" is used. This relieves the cross-cut teeth and ensures a high and even running smoothness as well as a long service life. Excellent cutting quality is also achieved here.



TRAPEZOIDAL FLAT TOOTH

Trapezoidal and flat teeth are arranged alternately. The trapezoidal tooth is responsible for sawing progress, while the flat tooth ensures a clean cutting edge. The robust toothing results in a longer saw blade service life.



FLAT TOOTH WITH VARIABLE CHAMFER

The flat teeth are slanted on the left and right and cut alternately, thus relieving the individual teeth. This results in a consistent quality and a longer service life.



FLAT TOOTH

The cutting edges of the teeth are straight. This makes the toothing robust. Each tooth cuts in the same way and is therefore used for hard materials such as steel and abrasive materials.



Perfect adaptation

The saw blades are made of high-quality metal for perfect cuts and a long service life. Cutting angle and tooth shapes are adapted to the application and machine.

Robust quality

Long useful life and excellent sharpening properties of saw teeth guarantee an excellent price/performance ratio.

Simple selection

The practical colour coding system helps you quickly locate the correct saw blade for the specific application.

Rapid cutting progress

High-quality steel, very robust carbide saw teeth and optimised expansion slots for smooth, safe sawing progress.

02 Sawing and oscillating

Colour code				
Material			Fe	Al
Recommended speed range	3-6	3-5	2-4	3-6

WOOD STANDARD

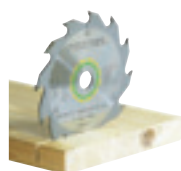

	Diameter	Cutting width	Hole dia.	No. of teeth	Chip angle	Tooth shape	RRP in £*	Order no.
HW 160x1,8x20 W18	160 mm	1,8 mm	20 mm	18	25°	W	34.80 41.76	500458
HW 160x2,2x20 W18	160 mm	2,2 mm	20 mm	18	25°	W	37.80 45.36	768129
HW 210x2,6x30 W18	210 mm	2,6 mm	30 mm	18	20°	W	57.70 69.24	493197
HW 230x2,5x30 W24	230 mm	2,5 mm	30 mm	24	20°	W	72.40 86.88	500647

WOOD RIP CUT



HW 160x1,8x20 PW12	160 mm	1,8 mm	20 mm	12	20°	PW	51.30 61.56	205550
HW 160x2,2x20 PW12	160 mm	2,2 mm	20 mm	12	20°	PW	51.30 61.56	496301
HW 190x2,6 FF PW16	190 mm	2,6 mm	FF**	16	28°	PW	65.70 78.84	492049
HW 210x2,6x30 PW16	210 mm	2,6 mm	30 mm	16	28°	PW	73.10 87.72	493196
HW 225x2,6x30 PW18	225 mm	2,6 mm	30 mm	18	28°	PW	73.40 88.08	496303
HW 230x2,5x30 PW18	230 mm	2,5 mm	30 mm	18	28°	PW	70.30 84.36	500646
HW 254x2,4x30 PW24	254 mm	2,4 mm	30 mm	24	20°	PW	67.50 81.00	575974

WOOD UNIVERSAL



HW 160x1,8x20 W28	160 mm	1,8 mm	20 mm	28	15°	W	58.60 70.32	205551
HW 160x2,2x20 W28	160 mm	2,2 mm	20 mm	28	15°	W	58.60 70.32	496302
HW 190x2,6 FF W32	190 mm	2,6 mm	FF**	32	10°	W	73.20 87.84	492048
HW 210x2,4x30 W36	210 mm	2,4 mm	30 mm	36	15°	W	75.40 90.48	493198
HW 216x2,3x30 W36	216 mm	2,3 mm	30 mm	36	-5°	W	87.20 104.64	500124
HW 225x2,6x30 W32	225 mm	2,6 mm	30 mm	32	20°	W	73.40 88.08	488288
HW 254x2,4x30 W40	254 mm	2,4 mm	30 mm	40	15°	W	104.00 124.80	575975
HW 260x2,5x30 W60	260 mm	2,5 mm	30 mm	60	-5°	W	139.60 167.52	494604

WOOD FINE CUT



HW 160x1,8x20 WD42	160 mm	1,8 mm	20 mm	42	10°	WD	73.00 87.60	205553
HW 160x2,2x20 W48	160 mm	2,2 mm	20 mm	48	5°	W	73.00 87.60	491952
HW 190x2,4 FF W48	190 mm	2,4 mm	FF**	48	8°	W	87.60 105.12	492050
HW 210x2,4x30 W52	210 mm	2,4 mm	30 mm	52	5°	W	102.20 122.64	493199
HW 216x2,3x30 W48	216 mm	2,3 mm	30 mm	48	-5°	W	106.20 127.44	491050
HW 216x2,3x30 W60	216 mm	2,3 mm	30 mm	60	-5°	W	127.20 152.64	500125
HW 225x2,6x30 W48	225 mm	2,6 mm	30 mm	48	10°	W	102.60 123.12	488289
HW 230x2,5x30 W48	230 mm	2,5 mm	30 mm	48	10°	W	99.00 118.80	500648
HW 254x2,4x30 W60	254 mm	2,4 mm	30 mm	60	10°	W	131.10 157.32	575976
HW 260x2,5x30 W80	260 mm	2,5 mm	30 mm	80	-5°	W	167.50 201.00	494605

Recommended speed range

02 Sawing and oscillating

Colour code					
Material			Fe	Al	
Recommended speed range	3-6	3-5	2-4	3-6	4-6

ALUMINIUM/ PLASTICS

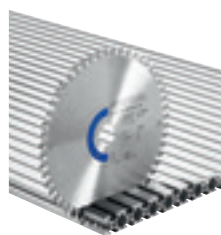

	Diameter	Cutting width	Hole dia.	No. of teeth	Chip angle	Tooth shape	RRP in £*	Order no.
HW 160x1,8x20 F/FA52	160 mm	1,8 mm	20 mm	52	-5°	F/FA	110.00 132.00	205555
HW 160x2,2x20 TF52	160 mm	2,2 mm	20 mm	52	-5°	TF	110.00 132.00	496306
HW 190x2,6 FF TF58	190 mm	2,6 mm	FF**	58	-5°	TF	139.10 166.92	492051
HW 210x2,4x30 TF72	210 mm	2,4 mm	30 mm	72	-5°	TF	164.40 197.28	493201
HW 216x2,3x30 W60	216 mm	2,3 mm	30 mm	60	-5°	W	155.60 186.72	491051
HW 216x2,3x30 TF64	216 mm	2,3 mm	30 mm	64	0°	TF	155.60 186.72	500122
HW 225x2,6x30 TF68	225 mm	2,6 mm	30 mm	68	-5°	TF	161.20 193.44	488291
HW 230x2,5x30 TF76	230 mm	2,5 mm	30 mm	76	-5°	TF	158.40 190.08	500649
HW 254x2,4x30 TF80 A	254 mm	2,4 mm	30 mm	80	-5°	TF	149.20 179.04	575978
HW 260x2,4x30 TF68	260 mm	2,4 mm	30 mm	68	0°	TF	163.90 196.68	494607

LAMINATE/ HPL



HW 160x1,8x20 TF52	160 mm	1,8 mm	20 mm	52	-5°	TF	110.00 132.00	205554
HW 160x2,2x20 TF48	160 mm	2,2 mm	20 mm	48	4°	TF	110.00 132.00	496308
HW 190x2,6 FF TF54	190 mm	2,6 mm	FF**	54	4°	TF	139.10 166.92	492052
HW 210x2,4x30 TF60	210 mm	2,4 mm	30 mm	60	4°	TF	164.40 197.28	493200
HW 216x2,3x30 WZ/FA60	216 mm	2,3 mm	30 mm	60	-5°	WZ/FA	155.60 186.72	500123
HW 225x2,6x30 TF64	225 mm	2,6 mm	30 mm	64	4°	TF	161.20 193.44	489459
HW 254x2,4x30 TF80 L	254 mm	2,4 mm	30 mm	80	4°	TF	149.20 179.04	575977
HW 260x2,5x30 WZ/FA64	260 mm	2,5 mm	30 mm	64	-5°	WZ/FA	163.90 196.68	494606

STEEL



HW 210x2,2x30 F36	210 mm	2,2 mm	30 mm	36	1°	F	114.80 137.76	493351
HW 230x2,5x30 F48	230 mm	2,5 mm	30 mm	48	0°	F	111.00 133.20	500651

ABRASIVE MATERIALS



DIA 160x1,8x20 F4 Saw blade only suitable for TS 55 F and TSC 55 K	160 mm	1,8 mm	20 mm	4	10°	F	137.90 165.48	205558
DIA 160x2,2x20 F4 Saw blade only suitable for TS 55 R and TSC 55	160 mm	2,2 mm	20 mm	4	10°	F	149.50 179.40	201910

Recommended speed range

Innovative and multi-talented.

The sword saws.

Whether it is wood or insulating materials, the UNIVERS SSU 200 sword saw cuts all common materials in wooden structures. The IS 330 is the specialist for cutting insulating materials. It combines the advantages of a chainsaw and a portable circular saw in a unique mobile system. The guide rail ensures straight, splinter-free trimming, longitudinal, mitre and compound cutting with ease.



Sword saw UNIVERS SSU 200

Wood and insulating materials up to 200 mm thick.



Sword saw IS 330

Pressure-resistant insulating materials up to 330 mm thick.*



Tool-free chain changeover



Thanks to FastFix, the chain can be changed with just a few hand movements. The chain can also be tensioned without tools by turning the clamping wheel.



Work adapted to the material

The SSU 200 is equipped with MMC electronics: Material- and chainsaw-chain-specific speed control, smooth start-up, overload protection and quick-acting safety brake guarantee perfect results in all applications and are gentle on both the machine and the material.

Technical data	SSU 200	IS 330
Power consumption (watt)	1.600	1.600
Idle engine speed (RPM)	4.600	4.600
Cutting depth 0°, 90°/45°/60° (mm)	200/140/100	330/230/165
Mitre cuts (°)	0 – 60	0 – 60
Cutting speed (idling) (m/s)	10,6	12
Blade position (°)	0 – 10	0 – 10
Weight (kg)	6,5	7

Items included	RRP in £*	Order no.
SSU 200		
 SSU 200 EB-Plus 240V universal saw chain SC 3/8" 91 U-39E, chain oil 250 ml, 7.5 m power cord, protective cover, SYS 5 TL Systainer	925.00 1,110.00	575981
IS 330		
 IS 330 EB Iso SC 3/8"-90 I-57E chainsaw chain, Iso Hard SC 3/8"-91 IH-57E chainsaw chain, chain oil 250 ml, 7.5 m power cord, protective cover	not available in Great Britain	575979

Accessories	RRP in £*	Order no.
Parallel side fence All variants: for SSU 200, IS 330, SSP 200, ISP 330		
 PA-SSU 200 parallel guide, guided on both sides	38.10 45.72	769098
 PA-A SSU 200 bilateral offset parallel stop	66.10 79.32	769099
Chainsaw chain All variants: chain pitch 3/8"		
 SC 3/8"-91 U-39E for SSU 200, SSP 200, saw chain Uni, for rip and cross cuts	28.60 34.32	769101
 SC 3/8"-91 L-39E for SSU 200, SSP 200, saw chain, longitudinal cuts, for rip cuts	35.80 42.96	769103
 SC 3/8"-91 F-39E for SSU 200, SSP 200, saw chain fine, for fine and cross cuts	35.80 42.96	769102
 SC 3/8"-91 I-39E for SSU 200, SSP 200, saw chain ISO, for flexible to pressure-resistant insulating materials	57.90 69.48	769100
 SC 3/8"-91 I-57E for IS 330, ISP 330, saw chain ISO, for flexible to pressure-resistant insulating materials	not available in Great Britain	769088
 SC 3/8"-91 IH-57E for IS 330, ISP 330, saw chain ISO Hard, for extremely pressure-resistant insulating materials	not available in Great Britain	769090
Blade		
 GB 10"-SSU 200 for SSU 200, SSP 200	53.20 63.84	769066
GB 13"-IS 330 for IS 330, ISP 330	not available in Great Britain	769089
 Guide-rails from page 59		

The revolution in insulating-material saws.

The cordless insulating-material saw.

No matter whether freehand or guided with guide rail and stop system, whether working on roofing, scaffolding or flooring, with insulating material made of mineral fibres, natural fibres or PUR insulating boards – the ISC 240 impresses with its mobility, versatility and efficiency. With powerful 18 V Li-ion battery and brushless EC-TEC motor for cutting insulating materials at a cutting depth of up to 350 mm quickly and when on the go.



Cordless insulating-material saw ISC 240

Mineral fibre, natural fibre insulating materials and PUR insulating boards up to a thickness of 350 mm.



Brushless
EC-TEC motor

Technical data	ISC 240
Battery voltage (V)	18
Stroke rate (RPM)	3.000
Cutting depth (mm)	240
Stroke length (mm)	26
Dust extraction connection dia. (mm)	27
Battery capacity (Ah)	4
Weight with battery (kg)	2,4



You can find more information on Bluetooth® Autostart on page 29

Items included

	RRP in £*	Order no.
ISC 240	All variants: SG-240/W-ISC serrated cutting set, adapter table (204160), guide rail slide, Systainer SYS3 M 237	
	368.00 441.60	576571
ISC 240 EB-Basic without battery pack, without charger		
ISC 240 HPC 4,0 EBI-Plus 2 x BP 18 Li 4.0 HPC-ASI battery pack, rapid charger TCL 6	601.00 721.20	576570
ISC 240 HPC 4,0 EBI-Plus-XL-FS 2 x BP 18 Li 4.0 HPC-ASI battery pack, rapid charger TCL 6, angle stop, guide rail FS 1400/2	829.00 994.80	576573



Versatile

For flexible insulating materials such as mineral wool and natural fibres with serrated cutting set, for insulating materials such as PUR and styrofoam with cross-set cutting set. In two lengths (240 mm/350 mm) for different material thicknesses.













Clean cutting surface

With the guide rail and angle stop (available in a set or as accessories), repeat cuts can be made perfectly straight and with precise angles.



Quick and durable

The cutting sets with special saw blades allow you to make rapid progress on your work with an extra-long service life, even with insulating materials up to 350 mm. Thanks to the quick-change system, the cutting set is replaced easily and without the need for tools in next to no time.

Accessories		RRP in £*	Order no.
Cutting set All variants: for ISC 240 EB			
	SG-240/G-ISC cutting set with cross-set saw blade, for polyurethane and polystyrene insulation boards, hard rock wool and glass wool, cutting length 240 mm	52.50 63.00	575409
	SG-350/G-ISC cutting set with cross-set saw blade, for polyurethane and polystyrene insulation boards, hard rock wool and glass wool, cutting length 350 mm	71.50 85.80	575410
	SG-240/W-ISC cutting set with serrated saw blade, for flexible mineral fibre insulating materials and natural insulating materials, cutting length 240 mm	71.50 85.80	575411
	SG-350/W-ISC cutting set with serrated saw blade, for flexible mineral fibre insulating materials and natural insulating materials, cutting length 350 mm	90.40 108.48	575412
Saw blade All variants: for ISC 240 EB, saw blade material HCS			
	DSB 240/G replacement saw blade for SG-240/G-ISC cross-set cutting set, cutting length 240 mm	19.20 23.04	575414
	DSB 350/G replacement saw blade for SG-350/G-ISC cross-set cutting set, cutting length 350 mm	28.70 34.44	575415
	DSB 240/W Replacement saw blade (movable) for SG-240/W-ISC serrated cutting set, cutting length 240 mm	19.20 23.04	575416
	DSB 350/W Replacement saw blade (movable) for SG-350/W-ISC serrated cutting set, cutting length 350 mm	28.70 34.44	575417
	Angle stop FS-WA-ISC for FS/2 with ISC 240, for fixed cuts, can be re-set using the scale and end stop, mounting on the guide rail without the use of tools, Transport position for compact transport of angle stop connected to the guide rail, stop ruler, adjustable stop, max. workpiece width 900 mm, angular range -47° - +47°	142.90 171.48	575413
	Battery and charging technology from page 28		
	Guide-rails from page 59		

* Manufacturer's recommended retail price. Dealer prices may vary.
Excl. VAT. | Incl. VAT.

Greater precision at maximum performance.

The VECTURO cordless oscillator.

The sophisticated positioning and dust extraction accessories make the VECTURO OSC 18 an intelligent system solution for the highest demands in performance, comfort and precision for dust-free sawing, scraping and cutting.

Cordless oscillator **VECTURO OSC 18**

With vibration and noise damping for optimum working comfort and brushless EC-TEC motor with variable speed control to allow work to progress as quickly as possible.

STARLOCK MAX



Brushless
EC-TEC motor



Technical data	OSC 18
Battery voltage (V)	18
Oscillation (RPM)	10.000 – 19.500
Oscillation angle	2 x 2°
Tool holder	StarlockMax
Battery capacity (Ah)	4
Weight with battery (kg)	1,8



Depth stop
For precisely defined plunge cuts – to protect the saw blade and material.



Quick-change system with StarlockMax tool holder

Set-up times are short since saw blades and accessories can be changed without the need for additional equipment. Maximum transmission of power to the saw blade.



Positioning aid
For precisely guided plunge cuts. With integrated depth stop and extractor connector.







Dust extraction device

For sawing with minimal dust and having a clear view of the workpiece. Ideal for sawing above head height.

Items included		RRP in £*	Order no.
OSC 18	All variants: USB 78/32/Bi/OSC universal saw blade, Systainer SYS3 M 187		
	OSC 18 E-Basic without battery pack, without charger	280.00 336.00	576591
	OSC 18 E-Basic-Set without battery pack, without charger, OSC-AV dust extraction device, OSC-AH positioning aid, OSC-TA depth stop, OSC-A adapter, USB 50/35/Bi/OSC universal saw blade, HSB 100/Bi/OSC wood saw blade	477.00 572.40	576592
	OSC 18 HPC 4,0 EI-Set BP 18 Li 4.0 HPC-ASI battery pack, rapid charger TCL 6, OSC-AV dust extraction device, OSC-AH positioning aid, OSC-TA depth stop, OSC-A adapter, USB 50/35/Bi/OSC universal saw blade, HSB 100/Bi/OSC wood saw blade	621.00 745.20	576594

* Manufacturer's recommended retail price. Dealer prices may vary.
Excl. VAT. | Incl. VAT.

02 Sawing and oscillating











Accessories	RRP in £*	Order no.
 <p>Positioning aid OSC-AH for OSC 18, makes it possible to create precisely guided plunge cuts, equipped with a depth stop and an extractor connector for removing dust when sawing, includes an adapter for fitting accessories without tools, can be used with offset saw blades, OSC-A adapter, max. plunge depth with position guide 42 mm, weight 0.485 kg</p>	<p>111.90 134.28</p>	203254
 <p>Dust extraction device OSC-AV for OSC 18, makes it possible to saw with minimal dust generation, provides an optimal view of the workpiece, machine can be safely guided with both hands, includes an adapter for fitting accessories without tools, OSC-A adapter, max. dust extraction device plunge depth 47 mm, weight 0.125 kg</p>	<p>46.70 56.04</p>	203256
 <p>Depth stop OSC-TA for OSC 18, enables plunge cuts with a defined depth, contains two inserts: A rotating depth stop for plunge cuts and a sliding shoe for long, straight cuts, includes an adapter for fitting accessories without tools, working angle can be flexibly adjusted, OSC-A adapter, max. plunge depth, depth stop 56 mm, max. plunge depth, sliding shoe 20 mm, notch scale on depth adjuster 1,5 mm, weight 0,2 kg</p>	<p>46.70 56.04</p>	203255
 <p>Oscillator accessories set OSC-AH/TA/AV-Set for OSC 18, makes it possible to create precisely guided plunge cuts, saw with minimal dust generation., includes an adapter for fitting accessories without tools, OSC-AH positioning aid, OSC-TA depth stop, OSC-AV dust extraction device, OSC-A adapter, max. plunge depth, depth stop 56 mm, max. plunge depth, sliding shoe 20 mm, max. plunge depth with position guide 42 mm, notch scale on depth adjuster 1,5 mm, weight 0,64 kg</p>	<p>149.10 178.92</p>	203258

Hello hotline!
Your contact for all queries.

Contact Festool directly to get all your questions answered quickly.
If you are unsure about which accessories and consumables are right for you, our Festool experts will be happy to advise you at any time.

You can find more information on page 8



	Length (mm)	Width (mm)		RRP in £*	Quantity in pack Order no.	Solid wood	Wood containing nails	Raw/Coated chipboard	Plastic materials	Window putty	Adhesive	Silicone	Tile joints
Saw blade, wood													
Two rows of original Japan teeth for high-precision cuts and clean cutting edges. Note: Plunge-cuts not possible.		50	35	HSB 50/35/J/OSC/5	65.30 78.36	5×203333	●		●				
		50	65	HSB 50/65/J/OSC/5	69.90 83.88	5×203332	●		●				
Saw blade, wood (HCS) – ideal in combination with the depth stop.													
For long, straight cuts and cutting out sections of laid parquet or laminate flooring.		-	-	HSB 100/Bi/OSC	64.70 77.64	1×203334	●		●				
Universal bi-metal saw blade for plunge-cuts													
Made from premium-quality bimetal. Particularly durable and robust. Ideal for plunge cuts. For working with a wide range of materials, such as wood, treated wood, painted wood, composite materials, fibre-reinforced plastics, plasterboard, non-ferrous metals, plastics.		78	32	USB 78/32/Bi/OSC/5	64.40 77.28	5×203337		●	●	●			
		78	42	USB 78/42/Bi/OSC/5	68.10 81.72	5×203336		●	●	●			
		50	35	USB 50/35/Bi/OSC/5	65.30 78.36	5×203338		●	●	●			
		50	65	USB 50/65/Bi/OSC/5	69.90 83.88	5×203960		●	●	●			
Diamond saw blade – segmented for working right into corners													
Diamond saw blade for cutting marble joints, epoxy resin joints, trass joints, hard epoxy and cement joints.		-	-	SSB 90/OSC/DIA	83.90 100.68	1×204414							●
Segment saw blade													
Segment saw blade for removing window glass (window kit).		-	-	SSB 32/OSC	56.90 68.28	1×204410				●	●		
Filler													
Scraper for removing tile adhesive, old paint, adhesive residue, silicone, carpeted floor and underfloor coatings.		-	-	SSP 52/OSC	21.60 25.92	1×204412					●	●	

■ Wood blades
 ■ Universal blades
 ■ Special blades for window fitters and floor layers
 ● Extremely appropriate

* Manufacturer's recommended retail price. Dealer prices may vary. Excl. VAT. | Incl. VAT.

03 Sanding



Power socket to go.
The new SYS-PowerStation.
You can find more information
on page 312.



094 Gear-drive eccentric sander
ROTEX



100 Eccentric sander



108 Edge sander



110 Orbital sander



112 Delta sander



114 Belt sander



116 PLANEX
long-reach sander



120 LEX
compressed air eccentric sander



122 RUTSCHER
compressed air orbital sander

Sanding motions and strokes

Depending on the surface quality and desired result, different sanding motions can be selected for coarse or fine sanding. It is also true that the longer the sanding stroke, the more material is removed. A short sanding stroke of three millimetres, for example, is ideal for fine sanding; sanding strokes of five to seven millimetres remove a large amount of material for coarse sanding.

Eccentric

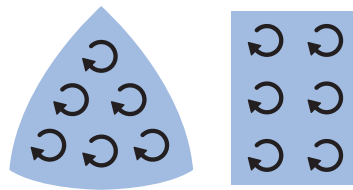

Eccentric rotation

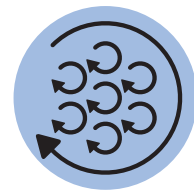

Sanding motion	Oscillating motion, which combines overlapping linear and circular motions.	Combined oscillating and free rotary motion.
Application	Can be deployed depending on the tool and sanding stroke from coarse to fine sanding. Less fine sanding finish than eccentric rotation, since sanding rings can remain visible.	Can be deployed depending on the tool and sanding stroke from coarse to fine sanding. Allows for a surface that is practically free of sanding rings and scratches thanks to a sanding process that leaves no traces.
Note	The delta sander also has an oscillating motion; it is ideal for removing material on small surfaces with angles, corners and edges.	When sanding wooden surfaces using an eccentric rotary motion, it makes no difference whether the machine is moved with or against the grain.
	You can find more information on page 110	You can find more information on page 100



Forced eccentric rotation

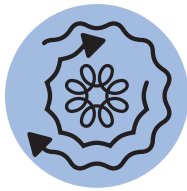

Rotation

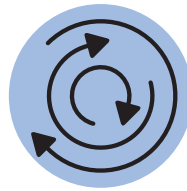

Band



<p>Forced eccentric rotation as a result of connection to a gear unit.</p>	<p>Pure rotary motion.</p>	<p>Pure linear movement in one direction through continuously rotating band.</p>
<p>Using the gear, the material removal capacity is significantly increased. Suitable for coarse sanding, for the quick removal of non-weight-bearing old coatings and for hologram-free polishing.</p>	<p>Enables fast work and a high material removal rate on large surfaces.</p>	<p>For a high rate of removal and grinding out large uneven surfaces.</p>
<p>Quick removal of large amounts of weathered layers of paint and varnish, without a high risk of sanding errors.</p>	<p>Rotary sanders are not forgiving of virtually any users errors because of their quick rotation and the high material removal rate this produces. This means that carelessness may results in sanding marks.</p>	<p>In combination with a sanding frame, the removal is limited so that a particularly level surface can be generated, even for veneered surfaces. Not suitable for wooden corner joints due to the differing grain directions.</p>
<p>You can find more information on page 94</p>	<p>You can find more information on page 116</p>	<p>You can find more information on page 114</p>



ROTEX – multifunctional legend.

The ROTEX geared eccentric sanders.

The unsurpassed original with 3-in-1 principle: With just a single tool for an extremely high material removal capacity in coarse sanding, a super-fine surface in fine sanding and a perfect finish in polishing. When combined with the GRANAT abrasive, the ROTEX saves money thanks to the minimal use of abrasives.



product
design
award
2011

Geared eccentric sanders

ROTEX RO 90

Compact sander with 90 mm sanding pad diameter and unique 4-in-1 principle thanks to the delta sanding pad.



Geared eccentric sanders

ROTEX RO 125

Hand-held sander with 125 mm sanding pad diameter.



Geared eccentric sanders

ROTEX RO 150

Powerful sander with 150 mm sanding pad diameter and patented MULTI-JETSTREAM 2 principle.



Protects the sanding pad and workpiece
Sand safely against abutting edges without the risk of kickbacks with the Festool PROTECTOR.

Corners

A world first: The StickFix sanding pad transforms the ROTEX RO 90 into a triangle sander. Maximum material removal capacity on small surfaces with angles, corners and edges.

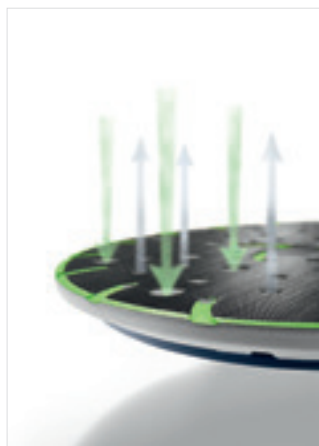

Healthy and dust-free thanks to the MULTI-JETSTREAM 2 principle

The MULTI-JETSTREAM 2 principle is defined by the unique interaction between intake air and exhaust air – with optimum dust extraction right up to the edge. An air flow is created which actively transports the sanding dust to the nearest extraction channel. The result: Virtually 100% dust extraction for a consistently high material removal rate, top surface quality and a healthy working environment.



Changing pads without using tools

Simple, fast and safe. FastFix interface for changing sanding and polishing pads quickly without using tools. This means that you can respond to changing tasks and material requirements.

Continuous sanding.
Without the need to find a power supply or the hassle of pulling cables!

The SYS-PowerStation allows users to be independent of traditional power sources, such as electrical outlet modules, generators or site distribution boards – to guarantee predictable everyday work.

Compact and mobile, it stores 1500 watt-hours of energy – for most applications, that is sufficient for a whole working day.

You can find more information on page 312

NEW



03 Sanding



Technical data	R0 90	R0 125	R0 150
Power consumption (watt)	400	500	720
ROTEX rotary motion speed (RPM)	260 – 520	300 – 600	320 – 660
Eccentric motion speed (RPM)	3.500 – 7.000	3.000 – 6.000	3.300 – 6.800
Sanding stroke (mm)	3	3,6	5
FastFix sanding pad dia. (mm)	90	125	150
Dust extraction connection dia. (mm)	27	27	27
Weight (kg)	1,4	1,9	2,3

Flat surfaces

Coarse sanding	○	●	●
Rough sanding	○	●	●
Fine sanding	○	●	●
Extra-fine sanding	○	○	○

Curved surfaces

Coarse sanding	○	●	●
Rough sanding	●	●	●
Fine sanding	●	●	●
Extra-fine sanding	●	○	○



Internal corners









Coarse sanding	●	-	-
Rough sanding	●	-	-
Fine sanding	●	-	-
Extra-fine sanding	●	-	-

Polishing

Small surfaces	●	●	○
Large surfaces	-	○	●

Extremely appropriate ●
Appropriate ○







Items included		RRP in £*	Order no.
RO 90 DX	All variants: FastFix sanding pad, Ø 90 mm (soft-HT), StickFix sanding pad V93, Festool PROTECTOR, Systainer SYS3 M 187		
	RO 90 DX FEQ-Plus 110V	466.00 559.20	576262
	RO 90 DX FEQ-Plus 240V	466.00 559.20	576261
RO 125			
	RO 125 FEQ-Plus 240V FastFix sanding pad Ø 125 mm (soft-HT), Festool PROTECTOR, Systainer SYS3 M 187	474.00 568.80	576033
RO 150	All variants: MULTI-JETSTREAM 2 FastFix sanding pad Ø 150 mm (soft W), Festool PROTECTOR, Systainer SYS3 M 237		
	RO 150 FEQ-Plus 240V	558.00 669.60	576020
	RO 150 FEQ-Plus 110V	558.00 669.60	576021

Accessories		RRP in £*	Order no.
Sanding pad			
	SSH-GE-STF-R090 DX suitable for abrasive V93, delta sanding pad, plate without interchangeable sanding pad, for attaching StickFix sanding pad, soft and hard, connecting thread FastFix	25.30 30.36	496802
	SSH-STF-V93/6-W/2 for DX 93, RO 90 DX, StickFix adhesive layer for quick change of sanding pad, soft version, with snap stud, qty. in pack 2 Units	15.20 18.24	488715
	SSH-STF-V93/6-H/2 for DX 93, RO 90 DX, StickFix adhesive layer for quick change of sanding pad, hard version, with snap stud, qty. in pack 2 Units	15.20 18.24	488716
	LSS-STF-R090 V93/6 suitable for abrasive V93, plate incl. interchangeable sanding pad, slat sanding pad V93, for sanding in tight spaces	31.10 37.32	496803
	LSS-STF-R090 V93 E replacement backing pad for slat sanding pad	24.00 28.80	497483
Sanding pad All variants: connecting thread FastFix			
	ST-STF D90/7 FX H-HT hard version, fastener resistant to high temperatures, for plain surfaces and narrow edges	31.10 37.32	495623
	ST-STF D90/7 FX W-HT soft version, fastener resistant to high temperatures, for universal use on plain and arced surfaces	31.10 37.32	496804
	ST-STF D125/8 FX H-HT hard version, fastener resistant to high temperatures, high edge solidity, for plain surfaces and narrow edges	38.20 45.84	492127
	ST-STF D125/8 FX W-HT soft version, fastener resistant to high temperatures, for universal use on plain and arced surfaces	38.20 45.84	492125
	ST-STF D125/8 FX SW ultra-soft version, elastic structure, for heavy roundings and cambers	38.20 45.84	492126

* Manufacturer's recommended retail price. Dealer prices may vary.
Excl. VAT. | Incl. VAT.

03 Sanding

Accessories		RRP in £*	Order no.
Sanding pad All variants: for RO 150 FEQ, MULTI-JETSTREAM 2, diameter 150 mm, connecting thread FastFix			
	ST-STF D150/MJ2-FX-H-HT hard version, fastener resistant to high temperatures, high edge solidity, for plain surfaces and narrow edges	49.00 58.80	202463
	ST-STF D150/MJ2-FX-W-HT soft version, fastener resistant to high temperatures, for universal use on plain and arced surfaces	49.00 58.80	202461
	ST-STF D150/MJ2-FX-SW ultra-soft version, elastic structure, for heavy roundings and cambers	49.00 58.80	202462
Interface pad All variants: as damping element between sanding disc and sanding pad			
	IP-STF-D90/6 Interface pad D 90 mm, height 15 mm, diameter 90 mm	8.10 9.72	497481
	IP-STF-D120/8-J for sanding contoured parts and fine-sanding parts with eccentric sander Ø 125 mm, JETSTREAM, height 15 mm, diameter 120 mm, hole circle diameter 90 mm	9.90 11.88	492271
	IP-STF D150/MJ2-5/2 for eccentric sander with diameter of 150 mm, MULTI-JETSTREAM 2, optimal thickness for sanding work on bodies and similarly shaped components, qty. in pack 2 Units, diameter 145 mm, height 5 mm	21.30 25.56	203348
	IP-STF D150/MJ2-15/1 for eccentric sander with diameter of 150 mm, MULTI-JETSTREAM 2, optimal thickness for sanding work on curved components, diameter 145 mm, height 15 mm	13.60 16.32	203351
	Abrasives from page 130		
Systainer³			
	SYS-STF-D77/D90/93V with insert for abrasives with dia. 77 mm, dia. 90 mm and V93, number of compartments 8, SYSTAINER size SYS3 M 112, dimensions (L x W x H) 396 x 296 x 112 mm	54.10 64.92	576784
	SYS-STF-80x133/D125/Delta with insert for abrasives measuring 80 x 133 mm with dia. 125 mm and Delta, number of compartments 5, SYSTAINER size SYS3 M 112, dimensions (L x W x H) 396 x 296 x 112 mm	54.90 65.88	576781
	SYS-STF D150 with insert for abrasives Ø 150 mm, number of compartments 10, SYSTAINER size SYS3 M 237, dimensions (L x W x H) 396 x 296 x 237 mm	64.10 76.92	576785
Protector			
	FESTOOL 90FX for RO 90 DX	10.60 12.72	496801
	FESTOOL 125FX for RO 125 FEQ	10.60 12.72	493912
	FESTOOL 150FX for RO 150 FEQ	13.10 15.72	493913

Accessories		RRP in £*	Order no.
Polishing pad			
	PT-STF-D90 FX-RO90 for RO 90 DX, FastFix, for holding polishing accessories with dia. 80 mm, Polishing edges, Polishing small surfaces, diameter 75 mm	31.10 37.32	495625
	PT-STF-D125 FX-RO125 for RO 125 FEQ, FastFix, fits polishing accessories, diameter 115 mm, height 10 mm	22.40 26.88	492128
	PT-STF-D150 FX for RO 150 FEQ, FastFix, fits polishing accessories, diameter 135 mm, height 10 mm	30.80 36.96	496151
	PT-STF-D150 M8 for RO 150, fits polishing accessories, diameter 135 mm, height 10 mm	22.90 27.48	496152
	Auxiliary handle ZG-RAS/RO for RO 150, RAS, WTS 150, RAP 150	7.80 9.36	487865
	Handle BG-RO 150 for RO 150 FEQ	20.30 24.36	495188

The right abrasive. For every application.

And to ensure that you have a good overview of all your abrasives, Festool has the right Systainer for this. With inserts for the respective abrasive diameter.

The Systainers and other clever accessories can be found from page 98



* Manufacturer's recommended retail price. Dealer prices may vary.
Excl. VAT. | Incl. VAT.

The compact one-handed sanders – even with a battery.

The eccentric sanders.

Thanks to their low weight and their compact design, the eccentric sanders make it possible to perform sanding work above head height or on vertical surfaces for a long period without tiring. Whether powered by a battery or the mains power supply, both versions are especially powerful and boast a high material removal capacity. And you achieve the result you need quickly and gently thanks to the attachable protector and long-life chip collection bag.

Cordless eccentric sander **ETSC 125**

The cordless version for limitless mobility. And also with an unlimited operating time thanks to the optional mains adapter.



Eccentric sander **ETS 125 R**

The extra-lightweight cable variant.



Brushless EC-TEC motor

With a particularly high material removal capacity

At 250 watts, the power of the ETS makes it stand out in its class and ensures rapid work progress.

**Work without interruptions**

Thanks to the Bluetooth® battery packs with 3.1 Ah capacity and a longer running time than charge time.

**Powerful and durable**

The powerful 18 V Bluetooth® Ergo battery pack in combination with the brushless EC-TEC motor ensures constant sanding and power similar to that of a mains-powered tool.

Unique: With battery or cable

For all applications which require an even longer operating performance, the 18 V Bluetooth® Ergo battery pack can be replaced with the plug it-mains adapter (included in the set version and available as an accessory). This alone creates a mains powered machine with an unlimited running time in combination with the plug it-cable – ideal in conjunction with a Festool mobile dust extractor.



Simple edge sanding. With edge sanders ES-ETS 125 and ES-ETSC 125.

Every edge is different. Sometimes it is sawn or routed, sometimes it is coarse or painted. And you want to make all of them perfect. With the innovative solution by Festool, the edge sander, you can do this quickly and easily – from the first application.

You can find more information on page 108



Perfectly built for manual operation. The eccentric sanders with EC-TEC motor.

For reduced fatigue when carrying out overhead sanding work, a good feeling on edges and comfort when working in any position. The ETS EC compact class with ideal ergonomics provides different handle options that remain optimum at all times. The brushless EC-TEC motor and extremely high-quality components guarantee a long service life.

Eccentric sander

ETS EC 150/3

ETS EC 150/5

150 mm diameter and available with two different strokes: ETS EC 150/3 with 3 mm sanding stroke for fine sanding and ETS EC 150/5 with 5 mm sanding stroke for intermediate sanding.



Eccentric sander

ETS EC 125/3

125 mm diameter and 3 mm sanding stroke for fine sanding.



Brushless
EC-TEC motor



The difference between feeling and sensing

The "Vibration Control System" teaches the motor to think. Active regulation of the speed automatically reduces the operating performance when vibrations are too high. The result is smoother operation and a greatly improved feel when sanding with noticeably fewer vibrations.

Great results, without fail

Protects not just the workpiece but also the operator. The sanding pad brake, which is tipped with robust carbide, permanently prevents the sanding pad from revolving too quickly when it is in a no-load state and enables the tool to be applied to a surface without producing scratches and to be set down quickly.



Switched on and off by the operator – not by chance

The perfectly positioned push-button prevents the device from being switched on or off accidentally.

Improves your sanding experience because nothing drags

Redeveloped to provide optimum protection for your surfaces and significantly improved handling. The protective sleeve encasing the suction hose is made from 100% nylon, allowing it to glide gently over surfaces and edges. The integrated plug it-cable is also protected against damage.

**MULTI-JETSTREAM 2.
Sanding with built-in dust conveying system.**

The MULTI-JETSTREAM 2 principle is defined by the unique interaction between intake air and exhaust air – with optimum dust extraction right up to the edge. An air flow is created which actively transports the sanding dust to the nearest extraction channel. The result: Virtually 100% dust extraction for a consistently high material removal rate, top surface quality and a healthy working environment.

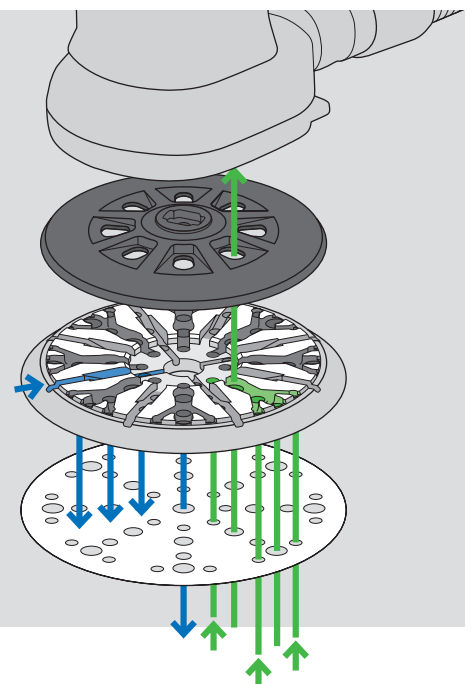

Speedy finishing.

The powerful eccentric sanders.

Extremely quiet, perfect ergonomics, continuous speed adjustment, reliable sanding pad brake:
Common features of these two eccentric sanders – for more comfort when working for prolonged periods.

Eccentric sander

ETS 150/3

ETS 150/5

150 mm diameter and available with two different strokes:
ETS EC 150/3 with 3 mm sanding stroke for fine sanding and
ETS EC 150/5 with 5 mm sanding stroke for intermediate sanding.



Our service. Your success.

Direct, practical and comprehensive service for you and your tool.
Along with excellent tools, we also offer outstanding-quality services –
throughout a tools' entire service life.

You can find more information on page 8





Technical data	ETS 125 R	ETSC 125	ETS EC 125/3
Power consumption (watt)	250	-	400
Battery voltage (V)	-	18	-
Battery capacity (Ah)	-	3,1	-
Eccentric motion speed (RPM)	6.000 – 12.000	6.000 – 10.000	6.000 – 10.000
Sanding stroke (mm)	2	2	3
Interchangeable sanding pad dia. (mm)	125	125	125
Dust extraction connection dia. (mm)	27	27	27
Weight (kg)	1,2	-	1,2
Weight with battery (kg)	-	1,4	-

Flat surfaces

Rough sanding	○	○	○
Fine sanding	●	●	●
Extra-fine sanding	●	●	●

Curved surfaces

Rough sanding	○	○	○
Fine sanding	●	●	●
Extra-fine sanding	●	●	●



Technical data	ETS EC 150/3	ETS EC 150/5	ETS 150/3	ETS 150/5
Power consumption (watt)	400	400	310	310
Eccentric motion speed (RPM)	6.000 – 10.000	6.000 – 10.000	4.000 – 10.000	4.000 – 10.000
Sanding stroke (mm)	3	5	3	5
Interchangeable sanding pad dia. (mm)	150	150	150	150
Dust extraction connection dia. (mm)	27	27	27	27
Weight (kg)	1,2	1,2	1,8	1,8

Flat surfaces











Rough sanding	○	●	○	●
Fine sanding	●	●	●	●
Extra-fine sanding	●	○	●	○

Curved surfaces

Rough sanding	○	●	○	●
Fine sanding	●	●	●	●
Extra-fine sanding	●	○	●	○

- Extremely appropriate
- Appropriate

03 Sanding

Items included	RRP in £*	Order no.
ETS 125 R		
 ETS 125 REQ-Plus 240V StickFix sanding pad Ø 125 mm (soft-HT), Festool PROTECTOR, long-life chip collection bag, Systainer SYS3 M 187	307.00 368.40	576066
ETSC 125	All variants: StickFix sanding pad Ø 125 mm (soft-HT), Festool PROTECTOR, long-life chip collection bag	
 ETSC 125-Basic without battery pack, without charger, Systainer SYS3 M 187	266.00 319.20	576370
 ETSC 125 3,1 I-Plus 2 x BP 18 Li 3.1 ERGO-I battery pack, rapid charger TCL 6, Systainer SYS3 M 187	450.00 540.00	576372
 ETSC 125 Li 3,1 I-Set 2 x BP 18 Li 3.1 ERGO-I battery pack, rapid charger TCL 6, ACA 18 V ERGO mains adapter (incl. plug-it power cable), Systainer SYS-COMBI 2	569.00 682.80	575714
ETS EC 125		
 ETS EC 125/3 EQ-Plus StickFix sanding pad Ø 125 mm (soft-HT), screwdriver, WAF 5, Systainer SYS3 M 187	not available in Great Britain	576341
ETS EC 150	All variants: screwdriver, WAF 5, Systainer SYS3 M 187	
 ETS EC150/3 EQ-Plus 240V MULTI-JETSTREAM 2 M8 sanding pad Ø 150 mm (extra soft SW)	504.00 604.80	576323
 ETS EC150/5 EQ-Plus 240V MULTI-JETSTREAM 2 M8 sanding pad Ø 150 mm (soft W)	504.00 604.80	576332
ETS 150	All variants: filter cartridge, screwdriver, WAF 5, Systainer SYS3 M 187	
 ETS 150/3 EQ-Plus 110V MULTI-JETSTREAM 2 M8 sanding pad Ø 150 mm (extra soft SW)	358.00 429.60	576077
 ETS 150/3 EQ-Plus 240V MULTI-JETSTREAM 2 M8 sanding pad Ø 150 mm (extra soft SW)	358.00 429.60	576073
 ETS 150/5 EQ-Plus 110V MULTI-JETSTREAM 2 M8 sanding pad Ø 150 mm (soft W)	358.00 429.60	576085
 ETS 150/5 EQ-Plus 240V MULTI-JETSTREAM 2 M8 sanding pad Ø 150 mm (soft W)	358.00 429.60	576083

Clean and dust-free. With chip collection bag or dust extraction.

Whether it is extracted via the reusable long-life chip collection bag or the Festool mobile dust extractor: With our system, you can stave off dust directly where it accrues. And, thanks to the Bluetooth® battery pack, you can control the mobile dust extractor directly with the cordless sander.

For more information about our mobile dust extractors, see page 148



Accessories		RRP in £*	Order no.
Sanding pad			
	ST-STF 125/8-M4-J W-HT for ES 125, ETS 125, ETSC 125, soft version, fastener resistant to high temperatures, for universal use on plain and arced surfaces, JETSTREAM, connecting thread M4, hole circle diameter 90 mm	46.40 55.68	492280
	ST-STF 125/8-M4-J SW for ES 125, ETS 125, ETSC 125, ultra-soft version, elastic structure, for heavy roundings and cambers, JETSTREAM, connecting thread M4, hole circle diameter 90 mm	46.40 55.68	492282
	ST-STF 125/8-M8-J H for ETS EC 125, LEX 125, hard version, fastener resistant to high temperatures, high edge solidity, for plain surfaces and narrow edges, JETSTREAM, connecting thread M8	47.70 57.24	492284
	ST-STF 125/8-M8-J W-HT for ETS EC 125, LEX 125, soft version, fastener resistant to high temperatures, for universal use on plain and arced surfaces, JETSTREAM, connecting thread M8	47.70 57.24	492286
	ST-STF 125/8-M8-J SW for ETS EC 125, LEX 125, ultra-soft version, elastic structure, for heavy roundings and cambers, JETSTREAM, connecting thread M8	47.70 57.24	492288
	ST-STF D150/MJ2-M8-H-HT for ETS 150, ETS EC 150, LEX 150 and WTS 150/7, hard version, fastener resistant to high temperatures, high edge solidity, for plain surfaces and narrow edges, MULTI-JETSTREAM 2, diameter 150 mm, connecting thread M8	49.00 58.80	202460
	ST-STF D150/MJ2-M8-W-HT for ETS 150, ETS EC 150, LEX 150 and WTS 150/7, soft version, fastener resistant to high temperatures, for universal use on plain and arced surfaces, MULTI-JETSTREAM 2, diameter 150 mm, connecting thread M8	49.00 58.80	202458
	ST-STF D150/MJ2-M8-SW for ETS 150, ETS EC 150, LEX 150 and WTS 150/7, ultra-soft version, elastic structure, for heavy roundings and cambers, MULTI-JETSTREAM 2, diameter 150 mm, connecting thread M8	49.00 58.80	202459
Interface pad All variants: as damping element between sanding disc and sanding pad			
	IP-STF-D120/8-J for sanding contoured parts and fine-sanding parts with eccentric sander Ø 125 mm, JETSTREAM, height 15 mm, diameter 120 mm, hole circle diameter 90 mm	9.90 11.88	492271
	IP-STF D150/MJ2-5/2 for eccentric sander with diameter of 150 mm, MULTI-JETSTREAM 2, optimal thickness for sanding work on bodies and similarly shaped components, qty. in pack 2 Units, diameter 145 mm, height 5 mm	21.30 25.56	203348
	IP-STF D150/MJ2-15/1 for eccentric sander with diameter of 150 mm, MULTI-JETSTREAM 2, optimal thickness for sanding work on curved components, diameter 145 mm, height 15 mm	13.60 16.32	203351
	Abrasives from page 131		
Systainer³			
	SYS-STF-80x133/D125/Delta with insert for abrasives measuring 80 x 133 mm with dia. 125 mm and Delta, number of compartments 5, SYSTAINER size SYS3 M 112, dimensions [L x W x H] 396 x 296 x 112 mm	54.90 65.88	576781
	SYS-STF D150 with insert for abrasives Ø 150 mm, number of compartments 10, SYSTAINER size SYS3 M 237, dimensions [L x W x H] 396 x 296 x 237 mm	64.10 76.92	576785
	Protector PR ETS-R 125 for ETS 125 REQ, ETSC 125, for smooth sanding along window panes, frames and panelling, for protecting the sanding pad and workpiece with minimal edge distance	10.10 12.12	201690
	Long-life chip collection bag SB-Longlife RTS/DTS/ETS for RTS 400, RTSC 400, DTS 400, DTSC 400, ETS 125, ETSC 125, for holding dust and for dust-free disposal of the extracted product, can be discharged multiple times and is wear resistant thanks to high-strength, durable nonwoven polyester	27.70 33.24	201693
	Battery and charging technology from page 28		
Turbo filter bag All variants: for RS 300, RS 3, RS 200, RS 2, ES 150, ETS 150, ET 2, for insertion in filter cartridge, paper filter bag for turbo dust extraction			
	TF II-RS/ES/ET/25 qty. in pack 25 Units	32.20 38.64	487871
	TF II-RS/ES/ET/5 qty. in pack 5 Units	8.00 9.60	487779
	Turbo filter bag set TFS-ES 150 for ES 150, ETS 150, for clear view and healthy working environment, not suitable for ETS EC 125/150, paper filter bag for turbo dust extraction and one plastic holder, filter cartridge, turbo filter bag	24.30 29.16	489631

* Manufacturer's recommended retail price. Dealer prices may vary.
Excl. VAT. | Incl. VAT.

Every edge. Simple sanding.

The edge sanders.

How many hours have you spent toiling with a sanding block? How many edges have you already sanded through? Every edge is different. Sometimes it is sawn or routed, sometimes it is coarse or painted. And you want to make all of them perfect. With the innovative solution by Festool, the edge sander, you can do this quickly and easily – from the first application.



Cordless edge sander ES-ETSC 125

Complete cordless mobility without hoses or cables – particularly advantageous for large workpieces.

Edge sander ES-ETS 125

An edge sander for every edge:
Whether sawn or routed, untreated
or painted.

Technical data	ES-ETSC 125	ES-ETS 125
Power consumption (watt)	–	250
Battery voltage (V)	18	–
Battery capacity (Ah)	3,1	–
Eccentric motion speed (RPM)	6.000 – 10.000	6.000 – 12.000
Sanding stroke (mm)	2	2
Interchangeable sanding pad dia. (mm)	125	125
Dust extraction connection dia. (mm)	27	27
Angle adjustment (°)	43 – 92	43 – 92
Edge height (mm)	5 – 60	5 – 60
Weight (kg)	–	2
Weight with battery (kg)	2,2	–

Batteries
from page

28



Adjustable sanding mode

In Hard mode (setting for pre-sanding), the edge is sanded according to the set angle. In Soft mode (setting for intermediate sanding), the edge sander adapts precisely to the surface to be sanded – this means that neither paint nor filler is sanded through.











Workpiece protection

It is easy and quick to replace the slideway lining on the crossheaded guide to match the surface. Velour linings for delicate surfaces, plastic lining for all other surfaces.



Angle adjustment

The angle adjustment, which does not require tools, can also be used to copy and lock free angles. The integrated angle display guarantees precision when setting angles manually.

Items included		RRP in €*	Order no.
ES-ETSC 125			
	ES-ETSC 125 3,1 I-Plus 240 V AH-ES-ETS/ETSC positioning aid, 2 x BP 18 Li 3.1 ERGO-I battery pack, rapid charger TCL 6, StickFix sanding pad Ø 125 mm (soft-HT), long-life chip collection bag, hex key, WAF 5, Systainer SYS3 M 337	513.00 615.60	576686
ES-ETS 125			
	ES-ETS 125 REQ-Plus 240V AH-ES-ETS/ETSC positioning aid, StickFix sanding pad Ø 125 mm (soft-HT), long-life chip collection bag, plug it-power cable (4 m), hex key, WAF 5, Systainer SYS3 M 337	370.00 444.00	576680
Accessories		RRP in €*	Order no.
	Positioning aid AH-ES-ETS/ETSC for ETS 125 REQ, ETSC 125, ES-ETS 125 and ES-ETSC 125, for sanding filled, painted and solid wood edges in fixed angular positions without any tipping, LAS-H-ES base runner, LAS-W-ES base runner, hex key, WAF 5, angle adjustment 43 – 92°, edge height 5 – 60 mm	116.80 140.16	205316
Base runner All variants: for AH-ES-ETS/ETSC, ES-ETSC and ES-ETS			
	LAS-H-ES plastic all-round crossheaded guide for wood or similar materials	11.70 14.04	205491
	LAS-W-ES crossheaded guide with hook-and-loop lining for attaching a velour slideway lining for sanding smooth or delicate workpieces, GB-LAS-STF-ES slideway lining	18.00 21.60	205492
	Slideway lining GB-LAS-STF-ES/5 for AH-ES-ETS/ETSC, LAS-W-ES, ES-ETSC and ES-ETS, velour slideway lining for quick and simple replacement, use a separate slideway lining for different applications, e.g. oiled and painted surfaces	19.90 23.88	205493
	Mains adapter ACA 220-240/18V Ergo for RTSC 400, DTSC 400, ETSC 125 cordless sanders, not compatible with all other Festool cordless tools, for continuous electrical operation of the RTSC 400, DTSC 400, ETSC 125 cordless sanders, ergonomic, lightweight design, plug it-power cable (4 m), input voltage 220 – 240 V, tensioner 18 – 20 V, rated power 150 watt, weight 0,3 kg	107.10 128.52	202503
	Abrasives from page 131		

* Manufacturer's recommended retail price. Dealer prices may vary.
Excl. VAT. | Incl. VAT.

The compact one-handed RUTSCHER orbital sanders – even with a battery.

Our ergonomic RUTSCHER orbital sanders.

Ideal for sanding narrow or straight surfaces close to edges. Their compact design, low weight and perfect ergonomics make the RUTSCHER orbital sanders ideal for sanding above head height for prolonged periods without tiring.

Orbital sander RTS 400

Compact mains-powered RUTSCHER orbital sander for continuous use.



Technical data	RTS 400	RTSC 400
Power consumption (watt)	250	–
Battery voltage (V)	–	18
Battery capacity (Ah)	–	3,1
Idle engine speed (RPM)	6.000 – 12.000	6.000 – 10.000
No. of strokes (RPM)	12.000 – 24.000	12.000 – 20.000
Sanding stroke (mm)	2	2
Interchangeable sanding pad (mm)	80 x 130	80 x 130
Dust extraction connection dia. (mm)	27	27
Weight (kg)	1,2	–
Weight with battery (kg)	–	1,4

RUTSCHER cordless orbital sander RTSC 400

Compact RUTSCHER cordless orbital sander for power similar to that of a mains-powered tool. Can also be used as a mains-powered sander with plug-it mains adapter.



Batteries
from page

28

Unique: With battery or cable

For all applications which require an even longer operating performance, the 18 V Bluetooth® Ergo battery pack can be replaced with the plug it-mains adapter (included in the set version and available as an accessory). This alone creates a mains powered machine with an unlimited running time in combination with the plug it-cable – ideal in conjunction with a Festool mobile dust extractor.

**Work without interruptions**

Thanks to the Bluetooth® battery packs with 3.1 Ah capacity and a longer running time than charge time.

Items included		RRP in £*	Order no.
RTS 400 R	All variants: StickFix sanding pad 80 x 130 mm, Festool PROTECTOR, long-life chip collection bag		
	RTS 400 REQ 240V StickFix abrasive discs	277.00 332.40	201225
	RTS 400 REQ-Plus 240V Systainer SYS3 M 187	307.00 368.40	576053
RTSC 400	All variants: StickFix sanding pad 80 x 130 mm, Festool PROTECTOR, long-life chip collection bag		
	RTSC 400-Basic without battery pack, without charger, Systainer SYS3 M 187	266.00 319.20	576347
	RTSC 400 3,1 I-Plus 2 x BP 18 Li 3.1 ERGO-I battery pack, rapid charger TCL 6, Systainer SYS3 M 187	450.00 540.00	576349
	RTSC 400 Li 3,1 I-Set 2 x BP 18 Li 3.1 ERGO-I battery pack, rapid charger TCL 6, ACA 18 V ERGO mains adapter (incl. plug-it power cable), Systainer SYS-COMBI 2	569.00 682.80	575726
Accessories		RRP in £*	Order no.
	Sanding pad SSH-STF-80x130/12 for RTS 400, RS 400, RTSC 400, StickFix adhesive layer for quick change of sanding pad, perforated with 12 suction holes, dimensions 80 x 130 mm	24.30 29.16	489252
	Interface pad IP-STF-80x133/12-STF LS130/2 damping element between sanding pad and abrasive, height 5 mm, qty. in pack 2 Units, dimensions 80 x 133 mm	12.50 15.00	490160
	Abrasives from page 135		
	Systainer² SYS-STF-80x133/D125/Delta with insert for abrasives measuring 80 x 133 mm with dia. 125 mm and Delta, number of compartments 5, SYSTAINER size SYS3 M 112, dimensions [L x W x H] 396 x 296 x 112 mm	54.90 65.88	576781
	Protector PR RTS-R 80x133 for RTS 400 REQ, RTSC 400, for smooth sanding along window panes, frames and panelling, for protecting the sanding pad and workpiece with minimal edge distance	10.10 12.12	201691
	Long-life chip collection bag SB-Longlife RTS/DTS/ETS for RTS 400, RTSC 400, DTS 400, DTSC 400, ETS 125, ETSC 125, for holding dust and for dust-free disposal of the extracted product, can be discharged multiple times and is wear resistant thanks to high-strength, durable nonwoven polyester	27.70 33.24	201693
	Battery and charging technology from page 28		
	Mains adapter ACA 220-240/18V Ergo for RTSC 400, DTSC 400, ETSC 125 cordless sanders, not compatible with all other Festool cordless tools, for continuous electrical operation of the RTSC 400, DTSC 400, ETSC 125 cordless sanders, ergonomic, lightweight design, plug it-power cable (4 m), input voltage 220 – 240 V, tensioner 18 – 20 V, rated power 150 watt, weight 0,3 kg	107.10 128.52	202503
	Turbo filter bag All variants: for RS 300, RS 3, RS 200, RS 2, ES 150, ETS 150, ET 2, for insertion in filter cartridge, paper filter bag for turbo dust extraction		
	TF II-RS/ES/ET/25 qty. in pack 25 Units	32.20 38.64	487871
	TF II-RS/ES/ET/5 qty. in pack 5 Units	8.00 9.60	487779
	Turbo filter bag set TFS II-ET/RS for RS 300, RS 3, RS 200, RS 2, ET2, for clear view and healthy working environment, paper filter bag for turbo dust extraction and one plastic holder, filter cartridge, 5 x turbo filter bag	24.30 29.16	487780

The compact corner sanders – even with a battery.

The delta sanders.

Sanding near edges and in corners – the delta sanders with iron-shaped pad can be guided accurately along narrow edges and into corners. And their compact design, low weight and perfect ergonomics make them ideal for sanding above head height for prolonged periods without tiring.

Delta sander DTS 400

Compact mains powered delta sander for continuous use.



Brushless
EC-TEC motor



Cordless delta sander DTSC 400

Compact cordless delta sander for power similar to that of a mains powered tool. Can also be used as a mains powered sander with plug-it mains adapter.

Technical data	DTS 400	DTSC 400
Power consumption (watt)	250	–
Battery voltage (V)	–	18
Battery capacity (Ah)	–	3,1
Idle engine speed (RPM)	6.000 – 12.000	6.000 – 10.000
Sanding stroke (mm)	2	2
Interchangeable sanding pad (mm)	100 x 150	100 x 150
Dust extraction connection dia. (mm)	27	27
Weight (kg)	1,2	–
Weight with battery (kg)	–	1,4

Batteries
from page

28

Unique: With battery or cable

For all applications which require an even longer operating performance, the 18 V Bluetooth® Ergo battery pack can be replaced with the plug-it-mains adapter (included in the set version and available as an accessory). This alone creates a mains powered machine with an unlimited running time in combination with the plug-it-cable – ideal in conjunction with a Festool mobile dust extractor.

**Less reworking**

PROTECTOR for smooth sanding along window surfaces, frames and panelling.

Items included		RRP in £*	Order no.
DTS 400 R			
	DTS 400 REQ-Plus 240V StickFix sanding pad 100 x 150 mm, Festool PROTECTOR, long-life chip collection bag, Systainer SYS3 M 187	307.00 368.40	576060
DTSC 400			
All variants: StickFix sanding pad 100 x 150 mm, Festool PROTECTOR, long-life chip collection bag			
	DTSC 400-Basic without battery pack, without charger, Systainer SYS3 M 187	266.00 319.20	576359
	DTSC 400 3,1 I-Plus 2 x BP 18 Li 3.1 ERGO-I battery pack, rapid charger TCL 6, Systainer SYS3 M 187	450.00 540.00	576361
	DTSC 400 Li 3,1 I-Set 2 x BP 18 Li 3.1 ERGO-I battery pack, rapid charger TCL 6, ACA 18 V ERGO mains adapter (incl. plug-it power cable), Systainer SYS-COMBI 2	569.00 682.80	575705
Accessories			
	Sanding pad SSH-STF-Delta100x150/7 for DTS 400, DTSC 400, DS 400, for sanding even in corners, dimensions 100 x 150 mm	27.50 33.00	493723
	Abrasives from page 136		
	Systainer³ SYS-STF-80x133/D125/Delta with insert for abrasives measuring 80 x 133 mm with dia. 125 mm and Delta, number of compartments 5, SYSTAINER size SYS3 M 112, dimensions [L x W x H] 396 x 296 x 112 mm	54.90 65.88	576781
	Protector PR DTS-R 100x150 for DTS 400 REQ, DTSC 400, for smooth sanding along window panes, frames and panelling, for protecting the sanding pad and workpiece with minimal edge distance	10.10 12.12	201692
	Long-life chip collection bag SB-Longlife RTS/DTS/ETS for RTS 400, RTSC 400, DTS 400, DTSC 400, ETS 125, ETSC 125, for holding dust and for dust-free disposal of the extracted product, can be discharged multiple times and is wear resistant thanks to high-strength, durable nonwoven polyester	27.70 33.24	201693
	Battery and charging technology from page 28		
	Mains adapter ACA 220-240/18V Ergo for RTSC 400, DTSC 400, ETSC 125 cordless sanders, not compatible with all other Festool cordless tools, for continuous electrical operation of the RTSC 400, DTSC 400, ETSC 125 cordless sanders, ergonomic, lightweight design, plug-it-power cable (4 m), input voltage 220 – 240 V, tensioner 18 – 20 V, rated power 150 watt, weight 0,3 kg	107.10 128.52	202503

* Manufacturer's recommended retail price. Dealer prices may vary.
Excl. VAT. | Incl. VAT.

Continuous precision.

The belt sander.

Sanding wood along the grain with absolute precision: Coarse and fine tasks alike, these belt sanders are the perfect tools for the job when it comes to linear sanding. For best results in record time, without sanding rings and therefore no need for reworking.

Belt sander

BS 75

Universal for smaller surfaces: Perfect for sanding the surface of furniture, for example.



Technical data	BS 75
Power consumption (watt)	1.010
Belt speed, rated load (m/min)	200 – 380
Belt length x belt width (mm)	533 x 75
Sanding area (mm)	135 x 75
Dust extraction connection dia. (mm)	27/36
Weight (kg)	4











Gentle positioning

Thanks to the sanding frame, the belt sander can be positioned gently and securely, does not tilt and is easy to guide.

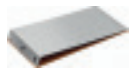
Stationary use

With the bench unit, you can turn a mobile belt sander into a stationary unit in an instant, allowing you to machine smaller workpieces more efficiently.



Items included		RRP in £*	Order no.
BS 75			
	BS 75 E-Plus dust bag, extraction adapter, slip band P100, stationary unit, SYS Maxi	not available in Great Britain	575769
Accessories		RRP in £*	Order no.
Sanding base All variants: for BS 75			
	SU/GG-BS 75 from fabric/graphite, qty. in pack 2 Units	13.60 16.32	490823
	SU/KM-BS 75 made from cork/metal for coarse sanding work	9.60 11.52	490824
	Sanding frame FSR-BS 75 for BS 75, quick installation without a tool	158.00 189.60	204803
	Abrasive belt from page 137		
	Extraction adapter AA-BS 75/105 for BS 75, BS 105, for connecting suction hose to belt sander	15.30 18.36	490818
	Dust bag AS-BS 75/105 for BS 75, BS 105	29.70 35.64	490819
	Bench unit SE-BS 75/105 for BS 75, BS 105, qty. in pack 2 Units	27.00 32.40	490820

* Manufacturer's recommended retail price. Dealer prices may vary.
Excl. VAT. | Incl. VAT.

For perfect drywalling results. The long-reach sanders.

With the Festool long-reach sanders, any room in drywall construction is easy to prepare. Their simple handling enables perfect sanding and, in combination with Festool extractors, they help to make work healthier. The PLANEX LHS 2 225 additionally features an LED light and eccentric movement for especially high surface quality – as well as making work less tiring thanks to extraction.



Long-reach sander **PLANEX LHS 2 225**

The circumferential LED ring light reveals any unevenness on the surface during sanding itself – no need for time-consuming rework.

Brushless
EC-TEC motor



Long-reach sander **PLANEX easy LHS-E 225**

Unpack and go. Particularly simple to use without assembly or adjustment.

Brushless
EC-TEC motor





Work more easily

The adjustable extraction guarantees ergonomic work on walls and ceilings: The PLANEX LHS 2 225 takes the load off your arms and back when working on walls and ceilings thanks to the easy-to-adjust, powerful extraction.

Digital extension

Connection to the Festool Work app provides additional features such as individual control of the LED light ring and tutorials for tool operation.



Increased reach

The ergonomic T-shaped handle of the PLANEX LHS 2 225 provides additional reach even from a shorter machine – and it weighs less, too. For even higher-up spaces, the working length can be adjusted using up to two extensions.



Perfect surface quality

The circumferential LED ring light on the PLANEX LHS 2 225 functions like an integrated spotlight, revealing any unevenness during sanding itself. The eccentric sanding movement creates outstanding surface quality – with no need for costly rework.











Systems get it done
The PLANEX mobile dust extractor.







The powerful CTM 36 AC PLANEX is precisely designed for the high material removal rate of the PLANEX long-reach sander. With a tool holder, kink-resistant hose and standard ComfortClean closing slide for even more effective filter cleaning. The result: Perfect results at maximum speed.

You can find more information on page 164

03 Sanding

		
Technical data	LHS 2 225	LHS-E 225
Power consumption (watt)	400	400
Eccentric motion speed (RPM)	5.000 – 8.500	–
Idle engine speed (RPM)	–	400 – 920
Sanding stroke (mm)	4	–
Interchangeable sanding pad dia. (mm)	220	215
Abrasive dia. (mm)	225	225
Length (m)	1,2/1,65	1,6
Dust extraction connection dia. (mm)	36/27	36/27
Weight (kg)	–	4
Weight (length: 1.20 m) (kg)	4	–
Weight (length: 1.65 m) (kg)	4,7	–

		RRP in £*	Order no.
LHS 2 225	All variants: VL-LHS 2 225 guide extension, SC-LHS 2 225 hose clip, hook-and-loop fastener KV-215 (pack of 5), Granat P180 pack of five, sanding pad dia. 220 mm incl. interface pad, Systainer SYS3 XXL 337		
	LHS 2 225 EQI-Plus 110V plug it-cable H05 RR-F-4 110V	1,086.00 1,303.20	575993
	LHS 2 225 EQI-Plus 240V plug it-power cable (4 m)	1,086.00 1,303.20	576637
	LHS 2 225/CTM 36-Set 110V plug it-power cable (4 m), mobile dust extractor CTM 36E AC PLANEX	2,049.00 2,458.80	576700
	LHS 2 225/CTM 36-Set 240V plug it-power cable (4 m), mobile dust extractor CTM 36E AC PLANEX	2,050.00 2,460.00	577251
LHS-E 225	All variants: StickFix sanding pad dia. 215 mm (extra soft), LHS-E 225-BAG carrying bag, hook-and-loop fastener KV-215 (pack of 5)		
	LHS-E 225 EQ 110V	710.00 852.00	571939
	LHS-E 225 EQ 240V	710.00 852.00	577269
	LHS-E 225/CTM 36-Set 110V CTM 36 E AC-LHS mobile dust extractor	1,643.00 1,971.60	575458

		RRP in £*	Order no.
Accessories for all PLANEX long-reach sanders			
	Abrasives from page 134		
	Systainer³ SYS-STF-D225 with insert for abrasive, dia. 225 mm, number of compartments 5, SYSTAINER size SYS3 M 337, dimensions (L x W x H) 396 x 296 x 337 mm	68.10 81.72	576786
	Tool holder WHR-CT LHS 2 for CT 36 PLANEX, with practical carrier handle, storage space for abrasives, interface pads and other small parts, easy to attach to Festool extractors with T-LOC or SYS-dock, fits all PLANEX long-reach sanders	29.90 35.88	205274
	plug it-cable H05 RN-F-4 PLANEX for the PLANEX LHS 2 225(II), PLANEX 225 EQ and PLANEX LHS-E 225 easy long-reach sanders, rubber insulated cable 240V plug it, particularly suitable for use with the PLANEX LHS 225 thanks to extended cable bushing, for example for sanding work in dry construction, length 4 m	26.00 31.20 6.50 / 1 m 7.80 / 1 m	204028
	Hook-and-loop fastener KV-215/5 for securing the cable on the suction hose, reusable and flexible, suitable for suction hoses with a diameter of 27 mm, 32 mm and 36 mm, qty. in pack 5 Units, length 215 mm	7.20 8.64	205294
	Carrying harness TG-LHS 225 for the PLANEX LHS 2 225(II), PLANEX 225 EQ and PLANEX LHS-E 225 easy long-reach sanders, working aid for sanding ceilings, additional side-mounted hand grip, Systainer SYS3 XXL 237	248.40 298.08	576802
	Auxiliary handle ZG-LHS 225 for PLANEX long-reach sander and carrying harness	46.30 55.56	496916

Accessories for PLANEX LHS 2 225		RRP in £*	Order no.
	Sanding pad ST-D220/48-LHS 2 225 not suitable for PLANEX LHS 225 EQ (until September 2020), not suitable for PLANEX LHS-E 225 EQ, for long-reach sander PLANEX LHS 2 225(I), for creating a perfect and scratch-free surface, the sanding pad may only be used if the IP-STF-D220/48-LHS 2 225 interface pad is fastened, interface pad including eight plastic screws, diameter 220 mm	72.30 86.76	205415
Interface pad All variants: for long-reach sander PLANEX LHS 2 225(I), not suitable for PLANEX LHS 225 EQ (until September 2020), not suitable for PLANEX LHS-E 225 EQ, diameter 220 mm			
	IP-STF-D220/48-LHS 2 225 must be used in conjunction with the ST-D220/48-LHS 2 225 sanding pad, can be attached to the sanding pad with eight plastic screws supplied, easy to screw in the screws using a second screw or coin (no screwdriver is required), StickFix hook-and-loop surface for securing and quickly changing abrasives, 8 x plastic screw	18.00 21.60	205418
	IP-D220-LHS 2 225-SW for sanding particularly soft materials	24.60 29.52	577252
	Guide extension VL-LHS 2 225 for long-reach sander PLANEX LHS 2 225(I), not suitable for PLANEX LHS 225 EQ (until September 2020), not suitable for PLANEX LHS-E 225 EQ, quick extension of the LHS 2 225 long-reach sander by 450 mm, a maximum of two guide extensions can be used at the same time (one is already included in the scope of delivery of the PLANEX LHS 2 225), total length 500 mm, extension action 450 mm	162.80 195.36	205416
	Hose clip SC-LHS 2 225 for long-reach sander PLANEX LHS 2 225(I), for securing the suction hose and cable on either the left hand or right hand T-handle end of the PLANEX LHS 2 225, for a trouble free handle area when sanding ceilings	9.00 10.80	205417
Accessories for PLANEX Easy LHS-E 225		RRP in £*	Order no.
	Sanding pad ST-STF-D215/8-LHS 225-SW for PLANEX, PLANEX easy long-reach sanders, not for the PLANEX LHS 2 225 long-reach sander, for universal use on plain and arced surfaces, ultra-soft, adaptable sanding pad, optimal suction support makes work effortless for the user, diameter 215 mm	94.00 112.80	202546
	Brush segment BS-LHS-E 225 for the PLANEX easy LHS-E 225 EQ long-reach sander, detachable part of the brush strip of the PLANEX easy LHS-E 225 sanding head	25.30 30.36	203189
	Brush strip BE-LHS-E 225 for the PLANEX easy LHS-E 225 EQ long-reach sander, as a replacement for used brush strip	36.50 43.80	203190
	Bag LHS-E 225-BAG for the PLANEX easy LHS-E 225 EQ long-reach sander, transport bag with shoulder straps	83.30 99.96	202477
Accessories for PLANEX LHS 225 (until September 2020)		RRP in £*	Order no.
Sanding pad All variants: not for the PLANEX LHS 2 225 long-reach sander, diameter 215 mm			
	ST-STF-D215/8-LHS 225-SW for PLANEX, PLANEX easy long-reach sanders, for universal use on plain and arced surfaces, ultra-soft, adaptable sanding pad, optimal suction support makes work effortless for the user	94.00 112.80	202546
	ST-STF-D215/8-IP-LHS 225 for long-reach sander PLANEX, for all types of applications, particularly suited for curved surfaces, incl. 2 interface pads, not recommended for PLANEX easy LHS-E 225	105.00 126.00	496106
	Interface pad IP-STF-D215/8/2x as damping element between sanding disc and sanding pad, for use with sanding pad 496106, qty. in pack 2 Units, height 5 mm, diameter 215 mm	28.60 34.32	496140
	Brush segment BS-LHS 225 for long-reach sander PLANEX, not for the PLANEX LHS 2 225 long-reach sander, detachable part of the brush strip of the PLANEX LHS 225 EQ sanding head	25.30 30.36	495166
	Brush strip BE-LHS 225 not for the PLANEX LHS 2 225 long-reach sander, for long-reach sander PLANEX, as a replacement for used brush strip	36.50 43.80	495167
	Guide extension VL-LHS 225 not for the PLANEX LHS 2 225 long-reach sander, for long-reach sander PLANEX, quick guide extension of the PLANEX for high ceilings, length 500 mm	186.20 223.44	495169

* Manufacturer's recommended retail price. Dealer prices may vary.
Excl. VAT. | Incl. VAT.

Designed for continuous operation.

The LEX compressed air eccentric sanders.

Extremely robust, durable and reliable. Ideal for continuous use because compressed air sanders are low-maintenance and lighter than power tools. Sturdy vane motors provide power, while the sophisticated IAS 3 system ensures perfect dust extraction and the vibration stop protects your health while you work.



Compressed air eccentric sander **LEX 3 77/2,5**

Compact sander with 77 mm sanding pad diameter and weight of 800g. Perfect for sanding small or difficult-to-reach surfaces or edges.

Compressed air eccentric sander **LEX 3 125/3** **LEX 3 125/5**

125 mm diameter and available with two different strokes: LEX 3 125/3 with 3 mm sanding stroke for a high-quality sanding finish during fine and final sanding work and LEX 3 125/5 with 5 mm sanding stroke for making fast progress during coarse and intermediate sanding work.



Compressed air eccentric sander **LEX 3 150/3** **LEX 3 150/5** **LEX 3 150/7**

150 mm diameter and available with three different strokes: LEX 3 150/3 with 3 mm sanding stroke for a high-quality sanding finish during fine and final sanding work, LEX 3 150/5 with 5 mm sanding stroke for making fast progress during coarse and intermediate sanding work and LEX 3 150/7 with 7 mm sanding stroke for removing a high volume of material in a very short time during coarse sanding work.





Maximum surface quality

The unique sanding pad brake prevents the sanding pad from turning upwards and prevents the surface being scratched during sanding, thereby minimising both reworking and costs.



Designed to fit your hand

Accurate guidance and precise sanding thanks to SoftGrip coating on the device. The well-balanced ergonomics also ensure effortless work.

Speed adjustment during sanding

The ergonomic position of the speed pre-selection enables infinite adjustment with the thumb, even during sanding.



Pad hardnesses for every application

Hard, soft, ultra-soft. Festool offers sanding pads with three different degrees of hardness for work that is optimally adapted to the material and surface.

**Three-fold benefits.
The Festool IAS 3 system.**

The IAS three-hose system combines three functions in a single hose: Compressed air supply, exhaust air extraction and dust extraction. Sanding dust and exhaust air are kept away from the work surface. Thanks to an intelligently designed exhaust air extraction system, no cold air escapes: Hands and wrists stay warm, work is more comfortable and better for health.



Sanding adapted to the material thanks to speed preselection.

The RUTSCHER compressed air orbital sander.

Thanks to their low weight and ergonomic shape, the RUTSCHER compressed air orbital sander fits perfectly in your hand. It features a vibration stop for healthy, effortless work. Its rectangular shape makes it ideal for flat surfaces.



RUTSCHER compressed air orbital sander **LRS 400**

The long tool for large surfaces.
While still being lightweight and handy.



Cost savings thanks to the durable MPE sanding pad

The MPE sanding pad is extremely durable. MPE has five times the tensile strength of sanding pads made from conventional foam rubbers and is therefore ideal for heavy-duty use.

Technical data	LRS 400
Operating pressure (flow pressure) (bar)	6
No. of strokes (RPM)	14.000
Sanding stroke (mm)	4
Air consumption at rated load (l/min)	390
Sanding pad StickFix (mm)	80 x 400
Weight (kg)	2,1

Internal corners	
Coarse sanding	●
Rough sanding	●
Fine sanding	-

Items included	RRP in £*	Order no.
LRS 400 StickFix sanding pad 80 x 400 mm (soft), bottle of cleaning and lubricating oil LFC 9022 (50 ml)	593.00 711.60	574813

The IAS 3 connection system is required to operate the compressed air sanders.
* Manufacturer's recommended retail price. Dealer prices may vary.

Excl. VAT. | Incl. VAT.

Vibration and emissions values can be found in the operating manual at www.festool.co.uk/vibration



Technical data	LEX 3 77/2,5	LEX 3 125/3	LEX 3 125/5	LEX 3 150/3	LEX 3 150/5	LEX 3 150/7
Operating pressure (flow pressure) (bar)	6	6	6	6	6	6
No. of strokes (RPM)	21.000	19.000	19.000	20.000	20.000	20.000
Eccentric motion speed (RPM)	10.500	9.500	9.500	10.000	10.000	10.000
Sanding stroke (mm)	2,5	3	5	3	5	7
Vibration emission value Ah (single-axle) (m/s ²)	0,8	1,1	1,1	2,1	2,7	3,17
Vibration emissions value Ah (three-axle) (m/s ²)	1,9	3,6	4,2	3,7	3,9	5,8
Air consumption at rated load (l/min)	270	290	290	290	290	310
Sanding pad dia. (mm)	77	125	125	150	150	150
Sound pressure level (dB(A))	72	70	70	72	72	76
Weight (kg)	0,7	1	1	1	1	0,9

Flat surfaces







Coarse sanding	-	○	●	-	●	●
Rough sanding	-	○	●	○	●	○
Fine sanding	●	●	○	●	○	-
Extra-fine sanding	●	●	-	●	-	-

Curved surfaces

Coarse sanding	-	○	●	-	●	●
Rough sanding	-	○	●	○	●	○
Fine sanding	●	●	○	●	○	-
Extra-fine sanding	●	●	-	●	-	-

Extremely appropriate ●

Appropriate ○

Items included	RRP in £*	Order no.
LEX 3 77		
 LEX 3 77/2,5 StickFix sanding pad Ø 77 mm W-HT (soft), bottle of cleaning and lubricating oil LFC 9022 (50 ml), screwdriver, WAF 4	367.00 440.40	691131
LEX 3 125 All variants: bottle of cleaning and lubricating oil LFC 9022 (50 ml), screwdriver, WAF 5		
 LEX 3 125/3 StickFix sanding pad Ø 125 mm (extra soft)	529.00 634.80	691140
 LEX 3 125/5 StickFix sanding pad Ø 125 mm (soft-HT)	529.00 634.80	691141
LEX 3 150 All variants: bottle of cleaning and lubricating oil LFC 9022 (50 ml), screwdriver, WAF 5		
 LEX 3 150/3 MULTI-JETSTREAM 2 M8 sanding pad Ø 150 mm (extra soft SW)	529.00 634.80	574996
 LEX 3 150/5 MULTI-JETSTREAM 2 M8 sanding pad Ø 150 mm (soft W)	529.00 634.80	575081
 LEX 3 150/7 MULTI-JETSTREAM 2 M8 sanding pad Ø 150 mm (soft W)	529.00 634.80	575077

The IAS 3 connection system is required to operate the compressed air sanders.











* Manufacturer's recommended retail price. Dealer prices may vary.

Excl. VAT. | Incl. VAT.

Vibration and emissions values can be found in the operating manual at www.festool.co.uk/vibration

03 Sanding

Accessories	RRP in £*	Order no.
Sanding pad		
 ST-STF-D77/6-M5 W for LEX 3 77, soft version, for tough and universal use, diameter 77 mm, connecting thread M5	28.80 34.56	498694
 ST-STF 125/8-M8-J H for ETS EC 125, LEX 125, hard version, fastener resistant to high temperatures, high edge solidity, for plain surfaces and narrow edges, JETSTREAM, connecting thread M8	47.70 57.24	492284
 ST-STF 125/8-M8-J W-HT for ETS EC 125, LEX 125, soft version, fastener resistant to high temperatures, for universal use on plain and arced surfaces, JETSTREAM, connecting thread M8	47.70 57.24	492286
 ST-STF 125/8-M8-J SW for ETS EC 125, LEX 125, ultra-soft version, elastic structure, for heavy roundings and cambers, JETSTREAM, connecting thread M8	47.70 57.24	492288
 ST-STF D150/MJ2-M8-SW for ETS 150, ETS EC 150, LEX 150 and WTS 150/7, ultra-soft version, elastic structure, for heavy roundings and cambers, MULTI-JETSTREAM 2, diameter 150 mm, connecting thread M8	49.00 58.80	202459
 ST-STF D150/MJ2-M8-W-HT for ETS 150, ETS EC 150, LEX 150 and WTS 150/7, soft version, fastener resistant to high temperatures, for universal use on plain and arced surfaces, MULTI-JETSTREAM 2, diameter 150 mm, connecting thread M8	49.00 58.80	202458
 ST-STF D150/MJ2-M8-H-HT for ETS 150, ETS EC 150, LEX 150 and WTS 150/7, hard version, fastener resistant to high temperatures, high edge solidity, for plain surfaces and narrow edges, MULTI-JETSTREAM 2, diameter 150 mm, connecting thread M8	49.00 58.80	202460
 ST-STF-D185/16-M8 W for LEX 185, soft version, for universal use on plain and arced surfaces, connecting thread M8	56.80 68.16	490514
 ST-STF-D185/16-M8 SW for LEX 185, ultra-soft version, elastic structure, for heavy roundings and cambers, connecting thread M8	56.80 68.16	490526
Interface pad All variants: as damping element between sanding disc and sanding pad		
 IP-STF-D77/6 for LEX 3 77, qty. in pack 2 Units, height 10 mm, diameter 77 mm	17.20 20.64	498818
 IP-STF-D120/8-J for sanding contoured parts and fine-sanding parts with eccentric sander Ø 125 mm, JETSTREAM, height 15 mm, diameter 120 mm, hole circle diameter 90 mm	9.90 11.88	492271
 IP-STF D150/MJ2-5/2 for eccentric sander with diameter of 150 mm, MULTI-JETSTREAM 2, optimal thickness for sanding work on bodies and similarly shaped components, qty. in pack 2 Units, diameter 145 mm, height 5 mm	21.30 25.56	203348
 IP-STF D150/MJ2-15/1 for eccentric sander with diameter of 150 mm, MULTI-JETSTREAM 2, optimal thickness for sanding work on curved components, diameter 145 mm, height 15 mm	13.60 16.32	203351
Sanding pad		
 SSH-STF-93x175/8 for RS 300, RS 3, LRS 93, StickFix adhesive layer for quick change of sanding pad, dimensions 93 x 175 mm	28.80 34.56	483905
 SSH-93x175/8 for RS 300, RS 3, LRS 93, for abrasives for clamping, dimensions 93 x 175 mm	25.20 30.24	489630
 SSH-STF-80x400/17 for LRS 400, HSK 80 x 400, HSK 80 x 200, soft, dimensions 80 x 400 mm	62.70 75.24	493140
 Iron sanding pad SSH-STF-V93x266/14 for RS 300, RS 3, LRS 93, StickFix, pressing iron sanding pad version, dimensions 93 x 266 mm	41.20 49.44	486418
 Abrasives from page 130		

Accessories	RRP in £*	Order no.
Systainer³		
 SYS-STF-D77/D90/93V with insert for abrasives with dia. 77 mm, dia. 90 mm and V93, number of compartments 8, SYSTAINER size SYS3 M 112, dimensions (L x W x H) 396 x 296 x 112 mm	54.10 64.92	576784
 SYS-STF D150 with insert for abrasives Ø 150 mm, number of compartments 10, SYSTAINER size SYS3 M 237, dimensions (L x W x H) 396 x 296 x 237 mm	64.10 76.92	576785
 SYS-STF-80x133/D125/Delta with insert for abrasives measuring 80 x 133 mm with dia. 125 mm and Delta, number of compartments 5, SYSTAINER size SYS3 M 112, dimensions (L x W x H) 396 x 296 x 112 mm	54.90 65.88	576781
IAS hose All variants: for LEX 3, LEX 2, LRS, antistatic, in accordance with DIN IEC 312, bleeder resistor (DIN IEC 312) <1 mΩ/m, temperature-resistant up to + 70°C, hose dia. 44 mm		
 IAS 3-3500 AS for connecting a Festool compressed air sander to a Festool mobile dust extractor or energy box, length 3,5 m	239.10 286.92 68.31 / 1 m 81.98 / 1 m	497208
 IAS 3-5000 AS for connecting a Festool compressed air sander to a Festool mobile dust extractor or energy box, length 5 m	282.70 339.24 56.54 / 1 m 67.85 / 1 m	497209
 IAS 3-7000 AS for connecting a Festool compressed air sander to a Festool mobile dust extractor or energy box, length 7 m	364.80 437.76 52.11 / 1 m 62.54 / 1 m	497210
 IAS 3-10000 AS for connecting a Festool compressed air sander to a Festool energy box, length 10 m	563.10 675.72 56.31 / 1 m 67.57 / 1 m	497211
IAS hose light All variants: for LEX 3, LEX 2, LRS, antistatic, in accordance with DIN IEC 312, bleeder resistor (DIN IEC 312) <1 mΩ/m, temperature-resistant up to + 70°C, hose dia. 37 mm		
 IAS 3 light 3500 AS for connecting a Festool compressed air sander to a Festool mobile dust extractor or energy box, length 3,5 m	209.30 251.16 59.80 / 1 m 71.76 / 1 m	497478
 IAS 3 light 5000 AS for connecting a Festool compressed air sander to a Festool mobile dust extractor or energy box, length 5 m	246.60 295.92 49.32 / 1 m 59.18 / 1 m	497213
 IAS 3 light 7000 AS for connecting a Festool compressed air sander to a Festool mobile dust extractor or energy box, length 7 m	300.20 360.24 42.89 / 1 m 51.46 / 1 m	497479
 IAS 3 light 10000 AS note: not with combination of CT/SR and ASA, for connecting a Festool compressed air sander to a Festool energy box, length 10 m	464.40 557.28 46.44 / 1 m 55.73 / 1 m	497480
 IAS adapter IAS 3-SD for LEX 3, LEX 2, LRS, for connecting a Festool compressed air sander directly to a compressed air line (without dust extraction), length 90 mm	68.20 81.84	497214
 Cleaning and lubricating oil LFC 9022/50 for LEX, LRS, special oil for compressed air preparation, 50 ml	4.90 5.88 9.80 / 100 ml 11.76 / 100 ml	201077

04 Abrasives



130 Abrasives
for our machines

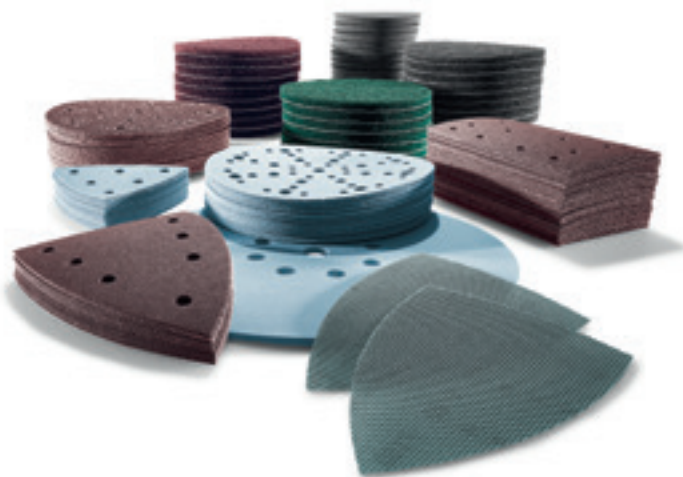



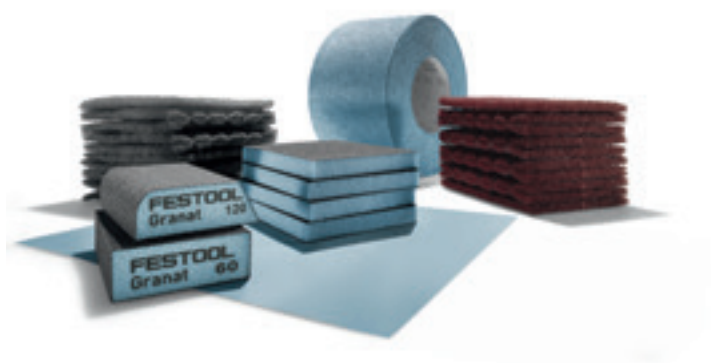



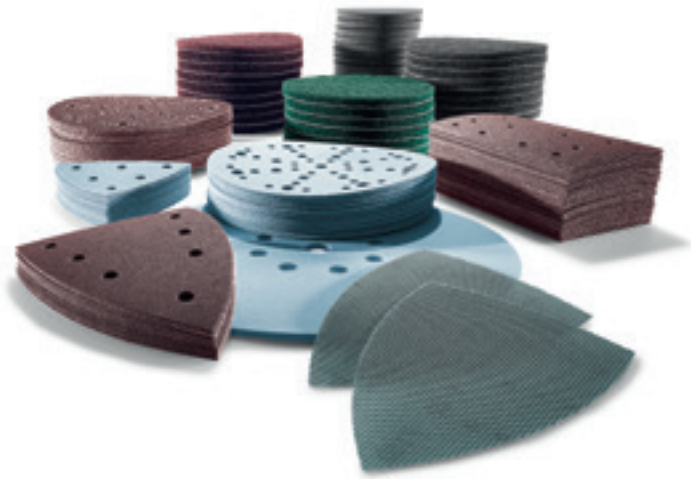

138 Manual abrasive



Abrasives for our machines



Abrasive type	
	Granat P40-500 abrasive paper P800-1500 abrasive sheet
	Granat Net Abrasive net +  Protection pad
	Granat Soft Sandpaper on foam backing
	Rubin 2 Abrasive paper with robust paper backing
	Saphir Abrasive on extremely robust cloth backing (tear-resistant)
	Vlies Sanding cloth – abrasive agent
	Platin 2 Fine abrasive cloth on foam backing

Manual abrasive

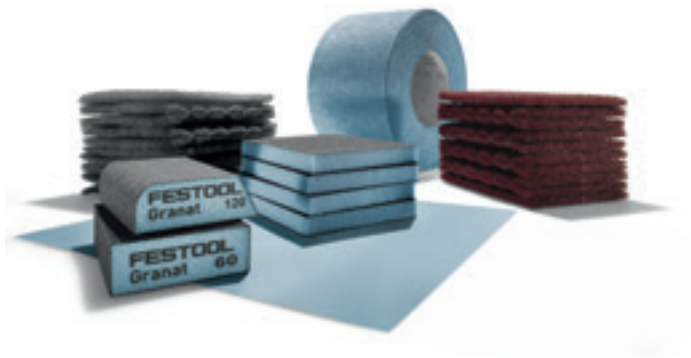

Granat

Abrasive paper

- > flexible, universal manual abrasive paper for paints, repair compound, fillers, varnishes
- > available as a roll (115 mm x 25 m) or in the form of sheets (230 x 230 mm)
- > P40-400 grit

Granat

Sanding block

- > Four-sided, rigid sanding block in two versions:
- > **Standard block**; ideal for sanding edges and profiles; 36-60-120-220 grit
- > **Combi block**; with round and acute-angled side; ideal for sanding areas that are difficult to reach and concave profiles; 120 grit

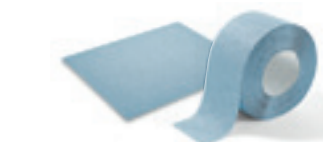

see page 138

see page 139

Area of application	Material									Grit range								
	Solid wood	Composite wooden materials	Oils	Varnishes/paint	Filler	Filler	Metal	Mineral materials	GFRP	Plastic materials	Sanding off 24-60	Coarse sanding 80-120	Intermediate sanding 150-220	Fine sanding 240-500	Extra-fine sanding 800-1500	Preparation for polishing 1500-4000	Oils/waxes	
Premium abrasive for universal use (coarse to extra-fine sanding)	○	○		●	●	●	○	●	○	●	40		1500					
Perfect for surfaces that produce a large quantity of dust; to be used in conjunction with the protection pad (except for D225)	○	○		○	●	●		○	○	○	80		400					
For a very high level of adaptability and even sanding finish on soft repair compounds (D225 only)						●					80		400					
Perfect for processing wood	●	●									40		220					
For extreme coarse sanding	○			●			○		●		24		80					
For light sanding, cleaning, oiling, waxing			●	●			●	●		○	100		800					white/green
For perfect preparation for polishing (dry and wet sanding)				●				●		●					400		4000	

● Extremely appropriate ○ Appropriate



Granat

Abrasive sponge

- > Two-sided flexible abrasive sponge; ideal for sanding radius profiles and mould surfaces
- > 60-120-220-800 grit



Granat Soft

Soft abrasive roll

- > Abrasive paper on foam backing for equal pressure distribution; ideal for light and intermediate sanding
- > Roll 115 mm x 25 m (perforated)
- > P120-800 grit



Vlies

Manual abrasive cloth

- > pre-perforated pads (115 x 152 mm)
- > ideal for roughening and matting old coatings before applying a new coating
- > MEDIUM 100 to ULTRAFINE 800 grit



HSK sanding blocks

- > extractable for abrasives 80 x 133 mm, 115 x 228 mm, 80 x 400 mm and 80 x 200 mm
- > cannot be extracted for abrasives D150 mm, 80 x 133 mm and 46 x 178 mm

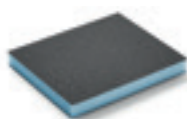

see page 139



see page 139



see page 139



see page 138

LEX 377

RO 90 DX

DX 93, RS 300, LRS 93

Dia. 77 mm

	Grit	Qty. in pack	RRP in €*	Order no.		Grit	Qty. in pack	RRP in €*	Order no.
	Granat								
	P80	50	23.80 28.56	497405	P400	50	20.20 24.24	497412	
	P120	50	20.20 24.24	497406	P500	50	20.20 24.24	497413	
	P150	50	20.20 24.24	497407	P800	50	38.60 46.32	498929	
	P180	50	20.20 24.24	497408	P1000	50	38.60 46.32	498930	
	P240	50	20.20 24.24	497409	P1200	50	38.60 46.32	498931	
	P320	50	20.20 24.24	497411	P1500	50	38.60 46.32	498932	

Ø 90 mm

	Granat				P240	100	42.40 50.88	497371
	P40	50	28.70 34.44	497363	P320	100	42.40 50.88	497372
	P60	50	26.80 32.16	497364	P400	100	42.40 50.88	497373
	P80	50	25.00 30.00	497365	P500	100	42.40 50.88	498326
	P100	100	42.40 50.88	497366	P800	50	40.60 48.72	498327
	P120	100	42.40 50.88	497367	P1000	50	40.60 48.72	498328
	P150	100	42.40 50.88	497368	P1200	50	40.60 48.72	498329
	P180	100	42.40 50.88	497369	P1500	50	40.60 48.72	498330
	P220	100	42.40 50.88	497370				

	Rubin 2				P120	50	21.40 25.68	499081
	P40	50	28.70 34.44	499077	P150	50	21.40 25.68	499082
	P60	50	26.80 32.16	499078	P180	50	21.40 25.68	499083
	P80	50	25.00 30.00	499079	P220	50	21.40 25.68	499084



	Platin 2				S2000	15	33.80 40.56	498324
	S500	15	33.80 40.56	498322	S4000	15	33.80 40.56	498325
	S1000	15	33.80 40.56	498323				

V93



	Granat				P180	100	33.80 40.56	497396
	P40	50	23.00 27.60	497390	P220	100	33.80 40.56	497397
	P60	50	21.50 25.80	497391	P240	100	33.80 40.56	497398
	P80	50	20.00 24.00	497392	P320	100	33.80 40.56	497399
	P100	100	33.80 40.56	497393	P400	100	33.80 40.56	497400
	P120	100	33.80 40.56	497394				
	P150	100	33.80 40.56	497395				

RO 90 DX
 DX 93, RS 300, LRS 93
 RAS 115
 RO 125
 ETS 125, ETSC 125, LEX 3 125



V93

	Grit	Qty. in pack	RRP in £*	Order no.		Grit	Qty. in pack	RRP in £*	Order no.
	P40	50	23.00 27.60	499161		P120	50	17.00 20.40	499165
	P60	50	21.50 25.80	499162		P150	50	17.00 20.40	499166
	P80	50	20.00 24.00	499163		P180	50	17.00 20.40	499167
	P100	50	17.00 20.40	499164		P220	50	17.00 20.40	499168

Ø 115 mm

	P40	50	42.30 50.76	499085	P100	50	31.30 37.56	499088
	P60	50	39.40 47.28	499086	P120	50	31.30 37.56	499089
	P80	50	36.90 44.28	499087				
	P24	25	42.60 51.12	484151	P50	25	36.50 43.80	485245
	P36	25	42.60 51.12	484152	P80	25	36.50 43.80	485246

Dia. 125 mm

	P40	10	14.30 17.16	497145	P180	100	65.30 78.36	497171
	P40	50	44.10 52.92	497165	P220	100	65.30 78.36	497172
	P60	10	13.30 15.96	497146	P240	100	65.30 78.36	497173
	P60	50	41.20 49.44	497166	P320	10	10.70 12.84	497150
	P80	10	12.60 15.12	497147	P320	100	65.30 78.36	497175
	P80	50	38.50 46.20	497167	P400	100	65.30 78.36	497177
	P100	100	65.30 78.36	497168	P500	100	65.30 78.36	497178
	P120	10	10.70 12.84	497148	P800	50	62.50 75.00	497179
	P120	100	65.30 78.36	497169	P1000	50	62.50 75.00	497180
	P150	100	65.30 78.36	497170	P1200	50	62.50 75.00	497181
	P180	10	10.70 12.84	497149	P1500	50	62.50 75.00	497182
	P80	50	54.70 65.64	203294	P220	50	46.40 55.68	203299
	P100	50	46.40 55.68	203295	P240	50	46.40 55.68	203300
	P120	50	46.40 55.68	203296	P320	50	46.40 55.68	203301
	P150	50	46.40 55.68	203297	P400	50	46.40 55.68	203302
	P180	50	46.40 55.68	203298				

	Protection Pad	2	9.00 10.80	203344
---	----------------	---	---------------	--------

for protecting the sanding pad
when using abrasive net

* Manufacturer's recommended retail price. Dealer prices may vary.
Excl. VAT. | Incl. VAT.







RO 125

ETS 125, ETSC 125, LEX 3 125

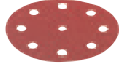
RO 150, ETS 150

LEX 3 150

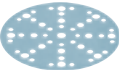
Dia. 125 mm

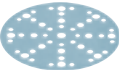
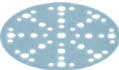





	Grit	Qty. in pack	RRP in £*	Order no.		Grit	Qty. in pack	RRP in £*	Order no.	
	P40	10	14.30 17.16	499101		P120	10	10.70 12.84	499105	
	P40	50	44.10 52.92	499093		P120	50	32.70 39.24	499097	
	P60	10	13.30 15.96	499102		P150	10	10.70 12.84	499106	
	P60	50	41.20 49.44	499094		P150	50	32.70 39.24	499098	
	P80	10	12.60 15.12	499103		P180	10	10.70 12.84	499107	
	P80	50	38.50 46.20	499095		P180	50	32.70 39.24	499099	
	P100	10	10.70 12.84	499104		P220	10	10.70 12.84	499108	
	P100	50	32.70 39.24	499096		P220	50	32.70 39.24	499100	
	100	10	29.60 35.52	201131		S2000	15	39.00 46.80	492376	
	320	10	28.00 33.60	201132		S4000	15	39.00 46.80	492377	
	800	10	28.00 33.60	201133		P180	100	71.60 85.92	575166	
		S400	15	37.90 45.48		492373	P220	100	71.60 85.92	575167
		S500	15	37.90 45.48		492374	P240	100	71.60 85.92	575168
S1000		15	37.90 45.48	492375	P320	10	11.60 13.92	575159		
		P80	10	13.60 16.32	575156	P320	100	71.60 85.92	575170	
		P80	50	42.30 50.76	575162	P400	100	71.60 85.92	575172	
		P100	100	71.60 85.92	575163	P500	100	71.60 85.92	575173	
		P120	10	11.60 13.92	575157	P800	50	68.70 82.44	575174	
		P120	100	71.60 85.92	575164	P1000	50	68.70 82.44	575175	
		P150	100	71.60 85.92	575165	P1200	50	68.70 82.44	575176	
		P180	10	11.60 13.92	575158	P1500	50	68.70 82.44	575177	

Ø 150 mm

* Manufacturer's recommended retail price. Dealer prices may vary. Excl. VAT. | Incl. VAT.

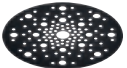
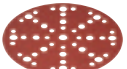
RO 150, ETS 150
LEX 3 150



Ø 150 mm

	Grit	Qty. in pack	RRP in £*	Order no.		Grit	Qty. in pack	RRP in £*	Order no.
 	Granat Net								
	P80	50	59.90 71.88	203303		P220	50	50.90 61.08	203308
	P100	50	50.90 61.08	203304		P240	50	50.90 61.08	203309
	P120	50	50.90 61.08	203305		P320	50	50.90 61.08	203310
	P150	50	50.90 61.08	203306		P400	50	50.90 61.08	203311
	P180	50	50.90 61.08	203307					
		2	9.90 11.88	203343	for protecting the sanding pad when using abrasive net				
	Rubin 2								
	P40	10	15.60 18.72	575178		P120	10	11.60 13.92	575182
	P40	50	48.50 58.20	575186		P120	50	36.00 43.20	575190
	P60	10	14.60 17.52	575179		P150	10	11.60 13.92	575183
	P60	50	45.30 54.36	575187		P150	50	36.00 43.20	575191
	P80	10	13.60 16.32	575180		P180	10	11.60 13.92	575184
	P80	50	42.30 50.76	575188		P180	50	36.00 43.20	575192
	P100	10	11.60 13.92	575181		P220	10	11.60 13.92	575185
	P100	50	36.00 43.20	575189		P220	50	36.00 43.20	575193
	Saphir								
	P24	25	53.20 63.84	575194		P50	25	45.30 54.36	575196
	P36	25	53.20 63.84	575195		P80	25	45.30 54.36	575197
	Vlies								
	100	10	31.60 37.92	201126		green	10	32.70 39.24	496508
	320	10	30.00 36.00	201127		white	10	32.70 39.24	496509
	800	10	30.00 36.00	201128					
	Platin 2								
	S400	15	44.80 53.76	492368		S2000	15	45.40 54.48	492371
	S500	15	44.80 53.76	492369		S4000	15	45.40 54.48	492372
	S1000	15	44.80 53.76	492370					





* Manufacturer's recommended retail price. Dealer prices may vary.
Excl. VAT. | Incl. VAT.

RAS 180
LHS-E 225
LHS 225, LHS 2 225

Ø 180 mm



	Grit	Qty. in pack	RRP in £*	Order no.		Grit	Qty. in pack	RRP in £*	Order no.
	Rubin 2								
	P40	50	61.70 74.04	499125		P120	50	45.70 54.84	499129
	P60	50	57.40 68.88	499126		P150	50	45.70 54.84	499130
	P80	50	53.70 64.44	499127		P180	50	45.70 54.84	499131
	P100	50	45.70 54.84	499128		P220	50	45.70 54.84	499132
	Saphir								
	P24	25	89.50 107.40	485239		P50	25	76.20 91.44	485241
	P36	25	89.50 107.40	485240		P80	25	76.20 91.44	485242

Ø 225 mm

	Granat								
	P40	25	52.80 63.36	205653		P180	5	11.40 13.68	205667
	P60	25	49.30 59.16	205654		P180	25	39.20 47.04	205660
	P80	5	13.50 16.20	205665		P220	25	39.20 47.04	205662
	P80	25	45.90 55.08	205655		P240	5	11.40 13.68	205668
	P100	25	39.20 47.04	205656		P240	25	39.20 47.04	205663
	P120	5	11.40 13.68	205666		P320	5	11.40 13.68	205669
	P120	25	39.20 47.04	205657		P320	25	39.20 47.04	205664
	P150	25	39.20 47.04	205659					
	Granat Net								
	P80	25	65.80 78.96	203312		P220	25	56.20 67.44	203317
	P100	25	56.20 67.44	203313		P240	25	56.20 67.44	203318
	P120	25	56.20 67.44	203314		P320	25	56.20 67.44	203319
	P150	25	56.20 67.44	203315		P400	25	56.20 67.44	201885
	P180	25	56.20 67.44	203316					
	Granat Soft								
	P80	25	98.60 118.32	204221		P180	25	83.90 100.68	204225
	P100	25	83.90 100.68	204222		P240	25	83.90 100.68	204226
	P120	25	83.90 100.68	204223		P320	25	83.90 100.68	204227
	P150	25	83.90 100.68	204224		P400	25	83.90 100.68	204228
	Saphir								
	P24	25	108.60 130.32	205650		P36	25	108.60 130.32	205652

RTS 400, RTSC 400
 LS 130
 HSK-A 80x130
 LRS 400
 HSK-A 80x400 / 80x200

80 x 133 mm

	Grit	Qty. in pack	RRP in £*	Order no.		Grit	Qty. in pack	RRP in £*	Order no.
	P40	10	9.90 11.88	497127		P150	100	44.90 53.88	497121
	P40	50	30.50 36.60	497117		P180	10	7.40 8.88	497130
	P60	50	28.30 33.96	497118		P180	100	44.90 53.88	497122
	P80	10	8.70 10.44	497128		P220	100	44.90 53.88	497123
	P80	50	26.60 31.92	497119		P240	100	44.90 53.88	497124
	P100	100	44.90 53.88	499628		P320	100	44.90 53.88	497125
	P120	10	7.40 8.88	497129		P400	100	44.90 53.88	497126
	P120	100	44.90 53.88	497120					

Protection Pad		2	9.00 10.80	203346
----------------	--	---	---------------	--------



for protecting the sanding pad when using abrasive net

	P40	50	30.50 36.60	499046	P120	50	22.60 27.12	499050
	P60	50	28.30 33.96	499047	P150	50	22.60 27.12	499051
	P80	50	26.60 31.92	499048	P180	50	22.60 27.12	499052
	P100	50	22.60 27.12	499049	P220	50	22.60 27.12	499053

Vlies	800	5	8.60 10.32	483582
-------	-----	---	---------------	--------





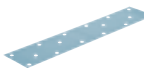



80 x 400 mm (pre-perforated for 80 x 200 mm)

	P40	50	63.10 75.72	497157	P120	50	46.70 56.04	497160
	P60	50	58.70 70.44	497158	P150	50	46.70 56.04	497161
	P80	50	54.90 65.88	497159	P180	50	46.70 56.04	497162
	P100	50	46.70 56.04	499631	P240	50	46.70 56.04	497163





* Manufacturer's recommended retail price. Dealer prices may vary. Excl. VAT. | Incl. VAT.

DTS 400 R
 DTSC 400
 RS 300
 RS 200

100 x 150 mm

	Grit	Qty. in pack	RRP in £*	Order no.		Grit	Qty. in pack	RRP in £*	Order no.	
Granat 	P40	10	11.80 14.16	497131	Granat 	P150	100	53.90 64.68	497139	
	P40	50	36.50 43.80	497135		P180	10	8.80 10.56	497134	
	P60	50	34.00 40.80	497136		P180	100	53.90 64.68	497140	
	P80	10	10.40 12.48	497132		P220	100	53.90 64.68	497141	
	P80	50	31.80 38.16	497137		P240	100	53.90 64.68	497142	
	P100	100	53.90 64.68	499630		P320	100	53.90 64.68	497143	
	P120	10	8.80 10.56	497133		P400	100	53.90 64.68	497144	
	P120	100	53.90 64.68	497138			P220	50	42.20 50.64	203325
							P240	50	42.20 50.64	203326
Granat Net  +	P80	50	49.50 59.40	203320	Granat Net  +	P320	50	42.20 50.64	203327	
	P100	50	42.20 50.64	203321		P400	50	42.20 50.64	203328	
	P120	50	42.20 50.64	203322						
	P150	50	42.20 50.64	203323						
	P180	50	42.20 50.64	203324						
Protection Pad 		2	9.00 10.80	203347	for protecting the sanding pad when using abrasive net					
Rubin 2 	P40	50	36.50 43.80	499133	Rubin 2 	P120	50	27.00 32.40	499137	
	P60	50	34.00 40.80	499134		P150	50	27.00 32.40	499138	
	P80	50	31.80 38.16	499135		P180	50	27.00 32.40	499139	
	P100	50	27.00 32.40	499136		P220	50	27.00 32.40	499140	

93 x 178 mm

Granat 	P40	50	39.90 47.88	498933	Granat 	P150	100	58.80 70.56	498937
	P60	50	37.10 44.52	498934		P180	100	58.80 70.56	498938
	P80	50	34.60 41.52	498935		P220	100	58.80 70.56	498939
	P100	100	58.80 70.56	499633		P240	100	58.80 70.56	498940
	P120	100	58.80 70.56	498936					
Rubin 2 	P40	50	39.90 47.88	499185	Rubin 2 	P120	50	29.40 35.28	499065
	P60	50	37.10 44.52	499062		P150	50	29.40 35.28	499066
	P80	50	34.60 41.52	499063		P180	50	29.40 35.28	499067
	P100	50	29.40 35.28	499064		P220	50	29.40 35.28	499068

RS 100
RS 200
BS 75
BS 105

115 x 228 mm

	Grit	Qty. in pack	RRP in £*	Order no.		Grit	Qty. in pack	RRP in £*	Order no.
	Granat					P180	100	81.80 98.16	498949
	P40	50	55.40 66.48	498944	P220	100	81.80 98.16	498950	
	P60	50	51.50 61.80	498945	P240	100	81.80 98.16	498951	
	P80	50	48.10 57.72	498946	P320	100	81.80 98.16	498953	
	P100	100	81.80 98.16	499632	P400	100	81.80 98.16	498954	
	P120	100	81.80 98.16	498947					
	P150	100	81.80 98.16	498948					

	Rubin 2				P120	50	41.00 49.20	499034
	P40	50	55.40 66.48	499030	P150	50	41.00 49.20	499035
	P60	50	51.50 61.80	499031	P180	50	41.00 49.20	499036
	P80	50	48.10 57.72	499032	P220	50	41.00 49.20	499037
	P100	50	41.00 49.20	499033				

533 x 75 mm

	Rubin 2				P100	10	20.00 24.00	499158
	P40	10	27.00 32.40	499155	P120	10	20.00 24.00	499159
	P60	10	25.10 30.12	499156	P150	10	20.00 24.00	499160
	P80	10	23.50 28.20	499157				

620 x 105 mm

	Rubin 2				P100	10	26.10 31.32	499152
	P40	10	35.10 42.12	499149	P120	10	26.10 31.32	499153
	P60	10	32.60 39.12	499150	P150	10	26.10 31.32	499154
	P80	10	30.50 36.60	499151				









Our recommendation: Festool Order app.

Download now
free of charge

With the Order app, you can find your Festool tool, suitable accessories and consumables, and create your digital shopping list and send it conveniently to your dealer. The favourites function allows you to easily re-order saved accessories or consumables. You can also manage your orders comfortably whilst on the go, can maintain an overview of these at all times and ensure your everyday work is even more well organised.



You can find more information on page 6

Accessories for manual sanding		RRP in £*	Order no.
	Sanding block HSK-A 80x130 compatible abrasive 80 x 133 mm, adapter for Festool hose, bypass adapter, weight 0,19 kg	59.20 71.04	496962
	Sanding block HSK-A 115x226 compatible abrasive 115 x 228 mm, adapter for Festool hose, bypass adapter, weight 0,28 kg	112.10 134.52	496963
	Sanding block HSK-A 80x400 compatible abrasive 80 x 400 mm, adapter for Festool hose, bypass adapter, weight 0,52 kg	123.80 148.56	496964
	Sanding block HSK-A 80x200 compatible abrasive 80 x 400 mm (halved), adapter for Festool hose, bypass adapter, weight 0,2 kg	88.50 106.20	496965
	Sanding block HSK-A-Set compatible abrasive 80 x 133 mm, 115 x 228 mm, 80 x 400 mm, HSK-A 80x130, adapter for Festool hose, bypass adapter, HSK-A 80x200, HSK-A 80x400, HSK-A 115x226	383.40 460.08	497101
	Hand-sanding block HSK-STF-46x178 for supporting StickFix, abrasive sheets 46 x 178 mm	11.60 13.92	583129
	Sanding block HSK-D 150 W soft, for attaching StickFix Ø 150 mm sanding discs	20.80 24.96	495965
	Sanding block HSK-D 150 H hard, for attaching StickFix Ø 150 mm sanding discs	22.30 26.76	495966
	Sanding block HSK 80x133 H hard, for attaching StickFix 80 x 133 mm abrasive sheets	22.30 26.76	495967

Pocket StickFix 46 x 178 mm for hand sanding block

	Grit	Qty. in pack	RRP in £*	Order no.	Grit	Qty. in pack	RRP in £*	Order no.
	P80	10	5.60 6.72	204277	P180	10	4.80 5.76	204279
	P120	10	4.80 5.76	204278				

hand abrasive Granat sandpaper 230 x 280 mm

	Grit	Qty. in pack	RRP in £*	Order no.	Grit	Qty. in pack	RRP in £*	Order no.
	P40	10	12.70 15.24	201256	P180	10	9.40 11.28	201262
	P60	10	11.00 13.20	201257	P220	10	9.40 11.28	201263
	P80	10	10.10 12.12	201258	P240	10	9.40 11.28	201264
	P100	10	9.40 11.28	201259	P320	10	9.40 11.28	201265
	P120	10	9.40 11.28	201260	P400	10	9.40 11.28	201266
	P150	10	9.40 11.28	201261				

hand abrasive Granat abrasive roll 115 mm x 25 m

	Grit	Qty. in pack	RRP in £*	Order no.		Grit	Qty. in pack	RRP in £*	Order no.
	P80	1	37.10 44.52 1.48 / 1 m 1.78 / 1 m	201105	P180	1	34.10 40.92 1.36 / 1 m 1.64 / 1 m	201109	
	P100	1	34.10 40.92 1.36 / 1 m 1.64 / 1 m	201106	P220	1	34.10 40.92 1.36 / 1 m 1.64 / 1 m	201110	
	P120	1	34.10 40.92 1.36 / 1 m 1.64 / 1 m	201107	P240	1	34.10 40.92 1.36 / 1 m 1.64 / 1 m	201111	
	P150	1	34.10 40.92 1.36 / 1 m 1.64 / 1 m	201108					

Manual abrasive Granat Soft abrasive roll (pre-perforated) 115 mm x 25 m

	Grit	Qty. in pack	RRP in £*	Order no.		Grit	Qty. in pack	RRP in £*	Order no.
	P120	1	72.40 86.88 2.90 / 1 m 3.48 / 1 m	497091	P400	1	72.40 86.88 2.90 / 1 m 3.48 / 1 m	497096	
	P150	1	72.40 86.88 2.90 / 1 m 3.48 / 1 m	497092	P500	1	72.40 86.88 2.90 / 1 m 3.48 / 1 m	497097	
	P180	1	72.40 86.88 2.90 / 1 m 3.48 / 1 m	497093	P600	1	72.40 86.88 2.90 / 1 m 3.48 / 1 m	497098	
	P240	1	72.40 86.88 2.90 / 1 m 3.48 / 1 m	497094	P800	1	72.40 86.88 2.90 / 1 m 3.48 / 1 m	497964	
	P320	1	72.40 86.88 2.90 / 1 m 3.48 / 1 m	497095					

Granat sanding block manual abrasive 69 x 98 x 26 mm (four-sided)

	Grit	Qty. in pack	RRP in £*	Order no.		Grit	Qty. in pack	RRP in £*	Order no.
	36	6	4.50 5.40	201080	120	6	4.50 5.40	201082	
	60	6	4.50 5.40	201081	220	6	4.50 5.40	201083	

	Grit	Qty. in pack	RRP in £*	Order no.
	120	6	6.30 7.56	201084

Hand abrasive Granat abrasive sponge 98 x 120 x 13 mm (2-sided)

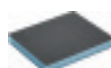
	Grit	Qty. in pack	RRP in £*	Order no.		Grit	Qty. in pack	RRP in £*	Order no.
	60	6	4.30 5.16	201112	220	6	4.30 5.16	201114	
	120	6	4.30 5.16	201113	800	6	4.30 5.16	201507	

Hand abrasive Vlies 115 x 152 mm

	Grit	Qty. in pack	RRP in £*	Order no.		Grit	Qty. in pack	RRP in £*	Order no.
	100	25	32.20 38.64	201115	800	30	32.20 38.64	497089	
	320	30	32.20 38.64	497088					

* Manufacturer's recommended retail price. Dealer prices may vary.
Excl. VAT. | Incl. VAT.

05 Polishing





142 Rotary polishers
SHINEX

All-purpose genius.

The SHINEX rotary polisher.

With the comfortably positioned variable speed trigger, the SHINEX RAP 150 rotary polisher can be controlled at low speed and perfectly adapted to the polishing task at hand. The trigger is locked to ensure a consistent speed. The heat produced by the motor is continuously cooled via an integrated heat sink. This not only protects the bearings but is also effective in the grip area: The RAP 150 remains noticeably cool during prolonged use.



Rotary polishers
SHINEX RAP 150











Technical data	RAP 150-14	RAP 150-21
Power consumption (watt)	1.200	1.200
Idle engine speed (RPM)	600 – 1.400	900 – 2.100
Max. polishing pad dia. (mm)	150	150
Spindle	M14	M14
Weight (kg)	2,1	2,1

Close to the surface

The small distance between the pad and the machine always gives you a good feel for the polishing, whilst also reducing the risk of tipping over.

Compact and ergonomic

The RAP 150 weighs just 2.1 kg. It sits securely in your hand however you grip it, thanks to the comfortable soft grip and slim design.

Items included		RRP in £*	Order no.
RAP 150	All variants: additional side-mounted hand grip, StickFix polishing pad Ø 150 mm		
	RAP 150-14 FE	not available in Great Britain	570809
	RAP 150-21 FE	not available in Great Britain	570811
Accessories		RRP in £*	Order no.
	Polishing pad PT-STF-D150-M14 for RAP 150, with integrated shock absorber for optimum distribution of pressure during polishing, fits polishing accessories, diameter 125 mm, height 25 mm	32.40 38.88	488342
Polishing agent All variants: does not contain silicone, water-based, volume 500 ml			
	MPA 5010 OR/0,5L Speed Cut 1-step sanding polish, perfect in combination with a sheepskin pad or polishing pad (ORANGE)	29.10 34.92 58.20 / 1 l 69.84 / 1 l	202048
	MPA 9010 BL/0,5L Speed Gloss fine sanding polish, perfect in combination with a polishing pad (BLUE)	24.30 29.16 48.60 / 1 l 58.32 / 1 l	202050
	MPA 11010 WH/0,5L anti-swirl-mark high-gloss polish, perfect in combination with a polishing pad (WHITE)	24.30 29.16 48.60 / 1 l 58.32 / 1 l	202051
	Microfibre cloth MPA-Microfibre/2 for excellent finish of new paints, for removing polish residues and grease marks, qty. in pack 2 Units	21.90 26.28	205732
	Sealing spray MPA SV+/0,5L for sealing painted surfaces, does not contain silicone, water-based, volume 500 ml	21.50 25.80 43.00 / 1 l 51.60 / 1 l	202052
	Finish-Cleaner MPA F+/0,5L for removing polish residues and grease marks, does not contain silicone, water-based, volume 500 ml	17.00 20.40 34.00 / 1 l 40.80 / 1 l	202053
	Denibber LZK-HM with cord, for the accurate removal of trapped particles and unevenness, manufactured from carbide, with hollow grinding, dimensions 25 x 30 mm	63.90 76.68	497525
	Auxiliary handle ZG-RAS/RO for RO 150, RAS, WTS 150, RAP 150	7.80 9.36	487865

* Manufacturer's recommended retail price. Dealer prices may vary.
Excl. VAT. | Incl. VAT.

05 Polishing

Surface preparation

Denibber



Fine sanding

Sander ETS 150/3



Sanding pad
dia. 150 mm



Granat P 1500 abrasive
dia. 150 mm

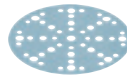

Polishing

Polisher SHINEX RAP 150



Polishing pad
dia. 150 mm



Orange – preliminary polishing

Orange polishing pad (medium)
Premium sheepskin
Polishing felt



MPA 5010 polish



Blue – fine polishing

Blue polishing pad (medium-fine)



MPA 9010 polish



Polishing out swirl marks

Geared eccentric sander
ROTEX RO 150
ROTEX RO 125
ROTEX RO 90 DX



Polishing pad
dia. 150 mm
dia. 125 mm
dia. 90 mm



White – high-gloss polishing

White polishing pad (fine)



MPA 11010 polish



Cleaning/finish

MPA F+ finish cleaner



MPA SV+ spray sealant



MPA Microfibre cloth



RT PREMIUM cleaning cloth



**Leave behind a brilliant impression.
Festool polishes and polishing sponges.**

Polish with ease and achieve brilliant results – Festool polishes are specially designed for their various applications. These polishes are water-based and do not contain silicone. When used in combination with the appropriate sponge they ensure reliable and optimal results for all types of coatings with minimal effort. The clearly organised colour coding system enables users to quickly find the appropriate product.

Polish

MPA 5010

**Speed Cut
1-step sanding polish**

High sanding performance and a high gloss finish in a single step



MPA 9010

**Speed Gloss
fine sanding polish**

Fine sanding performance for intermediate and fine polishing



MPA 11010

**Anti-swirl-mark
high-gloss polish**

Extra fine sanding performance for removing microscratches and swirl marks



Foam polishing pads

medium

For polishing and removing imperfections in paintwork. Ideal together with the MPA 5010.



medium-fine

For creating a perfect gloss finish. Ideal together with the MPA 9010.



Fine

For polishing out swirl marks and producing a deep shine. Ideal together with the MPA 11010.



Very fine

For removing polish residues on the painted surface.



Polishing felt and sheepskin pad

Polishing felt

For preliminary polishing of mineral materials, acrylic glass and clear coats



Premium sheepskin

Particularly suitable for UV clear coats, scratch-resistant clear coats



Finish cleaner and spray sealant



The high-quality microfibre cloths have a scratch-free edge to ensure a perfect finish for paint. They are perfectly suited to removing polish residue and grease spots when used in conjunction with finish cleaner.

The spray sealant is suitable for quickly and easily sealing painted surfaces, conserving, protecting and maintaining the paint.





RAP 80
T 15+3
T 18+3
RO 90 DX
RO 125



PoliStick polishing sponge for dia. 80 mm

		Diameter	Height in mm	Package contents	RRP in £*	Order no.
	orange, medium, for preliminary polishing when repairing paint flaws, ideal together with the MPA 5010	80 mm	20 mm	5	25.60 30.72	201993
	blue, medium-fine, for removing microscratches in clear coats, ideal together with the MPA 9010	80 mm	20 mm	5	23.40 28.08	202001
	white, Fine, for polishing out swirl marks and producing a deep shine, high-gloss polishing, ideal together with the MPA 11010	80 mm	20 mm	5	23.40 28.08	202009



Sheepskin and polishing felt for dia. 80 mm

		Diameter	Height in mm	Package contents	RRP in £*	Order no.
	real hair sheepskin for high abrasiveness and an excellent polishing finish, ideal together with the MPA 5010, Suitable for UV paints, scratch-resistant paints, optimum adhesion thanks to full covering with adhesive velour and edge seams	80 mm	18 mm	5	38.30 45.96	202044
	Polishing felt, hard, For preliminary polishing of mineral materials, acrylic glass and gloss paints, white	80 mm	6 mm	5	20.40 24.48	488339

PoliStick polishing sponge for dia. 125 mm





		Diameter	Height in mm	Package contents	RRP in £*	Order no.
	orange, medium, for preliminary polishing when repairing paint flaws, ideal together with the MPA 5010	125 mm	20 mm	5	59.50 71.40	201995
	blue, medium-fine, for removing microscratches in clear coats, ideal together with the MPA 9010	125 mm	20 mm	5	53.10 63.72	202003
	white, Fine, for polishing out swirl marks and producing a deep shine, high-gloss polishing, ideal together with the MPA 11010	125 mm	20 mm	5	53.10 63.72	202011

Sheepskin and polishing felt for dia. 125 mm



		Diameter	Height in mm	Package contents	RRP in £*	Order no.
	real hair sheepskin for high abrasiveness and an excellent polishing finish, ideal together with the MPA 5010, Suitable for UV paints, scratch-resistant paints, optimum adhesion thanks to full covering with adhesive velour and edge seams	125 mm	18 mm	1	14.40 17.28	202045
	Polishing felt, hard, For preliminary polishing of mineral materials, acrylic glass and gloss paints, white	125 mm	6 mm	5	27.00 32.40	493078

RAP 150
RO 150

PoliStick polishing sponge for dia. 150 mm

	Diameter	Height in mm	Package contents	RRP in £*	Order no.
 <p>orange, medium, for preliminary polishing when repairing paint flaws, ideal together with the MPA 5010</p>	150 mm	30 mm	1	18.30 21.96	202369
	150 mm	30 mm	5	80.30 96.36	201997
 <p>blue, medium-fine, for removing microscratches in clear coats, ideal together with the MPA 9010</p>	150 mm	30 mm	1	14.80 17.76	202373
	150 mm	30 mm	5	62.90 75.48	202005
 <p>white, Fine, for polishing out swirl marks and producing a deep shine, high-gloss polishing, ideal together with the MPA 11010</p>	150 mm	30 mm	1	14.80 17.76	202377
	150 mm	30 mm	5	62.90 75.48	202013
 <p>black, very fine (honeycombed), for removing polish residues on the painted surface</p>	150 mm	30 mm	1	14.40 17.28	202380
	150 mm	30 mm	5	62.40 74.88	202019

Sheepskin and polishing felt for dia. 150 mm

	Diameter	Height in mm	Package contents	RRP in £*	Order no.
 <p>real hair sheepskin for high abrasiveness and an excellent polishing finish, ideal together with the MPA 5010, Suitable for UV paints, scratch-resistant paints, optimum adhesion thanks to full covering with adhesive velour and edge seams</p>	150 mm	18 mm	1	17.20 20.64	202046
 <p>Polishing felt, hard, For preliminary polishing of mineral materials, acrylic glass and gloss paints, white</p>	150 mm	6 mm	5	33.80 40.56	488348

06 Dust extraction

Extractor power unleashed.
For a completely dust-free cordless system.
You can find more information on page 152.



NEW



154 CLEANTEC CT and CTC SYS Systerainer extractor

NEW



156 CLEANTEC CT and CTC MINI, MIDI mobile dust extractors



159 CLEANTEC CT 15 mobile dust extractor



160 CLEANTEC CT 26, CT 36, CT 48 mobile dust extractors



162 CLEANTEC AUTOCLEAN CT 26 AC, CT 36 AC, CT 48 AC mobile dust extractors



164 CLEANTEC AUTOCLEAN CT 36 AC PLANEX mobile dust extractors



165 CLEANTEC AUTOCLEAN CT 26 AC RENOFIX, CT 36 AC RENOFIX mobile dust extractors



168 CLEANTEC CTH 26, CTH 48 special extractor



169 CLEANTEC CT 48 EC/B22 special extractor



170 CT-VA pre-separator

Healthy working with a system. Fighting dust together.



Healthy, precise and time-saving work. Festool offers an uncompromising connection between mobile dust extractors and your tool for every application, dust class and workplace. The result: Simpler and more effective health protection in any situation thanks to a perfectly coordinated system.

When working in a dusty environment or handling materials that generate large quantities of dust, your main priority should be protecting your health. How harmful the dust is to your health depends on the size of the particles as well as the quantity and time that the materials remain inside your lungs.

The smaller the dust particles are, the deeper they can penetrate into the lung tissue and this is why finer particles are much more harmful to the airways, with many being categorised as extremely hazardous to health.

In the interests of your own health, it is imperative that you keep the air clean when handling mineral dust that invariably contains quartziferous substances and always work with a certified and approved dust extractor or safety extractor.

Your Industrial Employers' Liability Insurance Association will provide you with detailed information and specially prepared lists of substances that exceed specified OEL (occupational exposure limits).



**CTL/CTLC SYS
CTL/CTLC MINI/MIDI
CTL 26/36/48/48 EC**

Specialists for dust with OEL > 1 mg/m³.



**CTMC SYS
CTM/CTMC MIDI
CTM 26/36/48/48 LE EC**

Specialists for dust with OEL ≥ 0.1 mg/m³.
For quartziferous mineral dust and wood dust.



CTH 26/48

Specialists for dust with OEL < 0.1 mg/m³.
For carcinogenic and pathogenic dust, e.g. asbestos and mould.



**CTL 48 LE EC/B 22
CTM 48 LE EC/B 22**

Specialised in the extraction of flammable and explosive dust.

Dust categories in accordance with EN 60335-2-69, Appendix AA

	Appropriate	Max. permeability (test)	Disposal	Contamination risk
L (Low)	> Dust with OEL > 1 mg/m ³	1 % (filter material)		
M (Medium)	> Dust with OEL ≥ 0.1 mg/m ³ > mineral dust > Wood dust	0.1% (complete tool incl. upholstery nail test)	Dust-free	Cap for transportation
H (High)	> Dust with OEL < 0.1 mg/m ³ > carcinogenic dust > Dust containing pathogens	0.005% (complete tool incl. upholstery nail test)	Dust-free	Cap for transportation

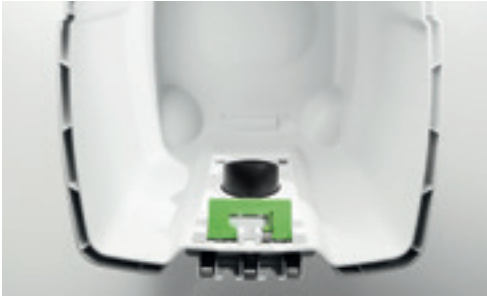

Full usage of space

The sophisticated container geometry, compatible SELFCLEAN filter bag and space-saving flat filter combine to produce a net volume that corresponds almost exactly to the gross volume of the container.



Practical SYS DOCK

Simple transportation, better organisation and endless flexibility. The SYS-Dock with T-LOC for the safe connection of Systainer, SORTAINER and SYS-ToolBox units.



Cable holder

The cable can be wound up quickly and neatly thanks to the new cord holder. And – thanks to the sophisticated folding mechanism – it can be easily removed from the holder without complex unwinding.



Hose garage

The integral hose holder eliminates the need for external hooks and protects the suction hose and mains cable from damage. The suction hose winds around the holder for clean, compact transportation.



Smooth suction hose with CLEANTEC sleeve

The suction hose: Smooth and flexible – with a smooth exterior for perfect sliding over surfaces, a longer service life and greater suction power. The CLEANTEC connecting sleeve allows you to individually set the air flow rate using the infinitely adjustable bypass.



AUTOCLEAN automatic main filter cleaning system

Less cleaning work and constant suction power. The AUTOCLEAN automatic cleaning system eliminates the need to clean the main filter manually. Individual cleaning intervals can be defined to guarantee powerful, constant suction.

Extractor power unleashed.

For a completely dust-free cordless system.

Goodbye dust. And hello good health. Our cordless extractors love dust and are perfectly tailored to Festool cordless tools: Whether for mobile sawing, sanding or drilling, their compact design and low weight make them the perfect partner for your daily work. This allows you to work in a dust-free environment even with a battery system. The innovative Bluetooth® autostart or the practical remote control ensures the perfect combination of the cordless tool and the extractor. Our cordless extractors excel with maximum suction power thanks to the 36 V turbine with 2 x 18 V battery packs. Available in dust classes L and M for a healthy working environment. And, just like usual, everything is compatible: The extractor, cordless tool, T-LOC Systainer connection and the smooth suction hose. This makes the system perfect in every way.

Compact suction power without a cable.

Perfected for your cordless tools.

CTC MINI/MIDI*

It doesn't get any more mobile than this: Compact design, low weight, cordless rather than mains-powered device. Whether for mobile sawing, grinding or drilling: Our compact Festool on-site extractors fit perfectly into the Festool 18 V system. This ensures dust-free work for the cordless application.

For carrying: The extractor in Systainer format.

CTC SYS

Compact Systainer format, low weight and frees you from the constraints of electrical sockets. This makes it the perfect companion for service work and small tasks, as well as occasional spontaneous use.

NEW



NEW



Simply communicative: Extraction with Bluetooth® control.

Directly integrated or simple to retrofit

Directly integrated in the CT/CTC MINI and MIDI as well as the CTC SYS, simple to retrofit in the free slot on the CLEANTEC CT 26/36/48 mobile dust extractors*. The Bluetooth® module – and the mobile dust extractor can easily be controlled remotely straight away via the remote control on the suction hose or the Bluetooth® battery pack on the cordless tool.



Bluetooth® remote control

Saves you a trip to the extractor: For switching on the mobile dust extractor directly at the suction hose – even when the extractor is in AUTO mode. Ideal for occasional cleaning tasks.



Bluetooth® battery packs

For communication with the Bluetooth® module on the mobile dust extractor – and to make sure that even a cordless tool can start the mobile dust extractor automatically when switched on. Available as an accessory and automatically included with many Festool cordless products.



* Bluetooth® module available as an accessory. Installation must be carried out by a qualified and certified electrician.

For carrying: The extractor in Systainer format.

Now also with a battery.

Always by your side. Systainer on the outside, extractor on the inside. Our Systainer extractors offer maximum mobility and independence with minimal weight – perfect for transporting and carrying. This makes them the ideal partners for service work and small tasks, as well as occasional spontaneous use.



Systainer extractor **CLEANTEC CTL SYS**

Compatible with T-LOC in a Systainer system for optimum workplace organisation.

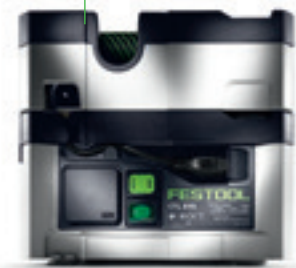

Cordless Systainer extractor **CLEANTEC CTC SYS**

Frees you from the constraints of electrical sockets with maximum suction power thanks to the 36 V turbine with 2 x 18 V battery packs.



NEW

Technical data	CT SYS	CTC SYS
Power consumption (watt)	1.000	–
Battery voltage (V)	–	36
Max. volume flow (l/min)	3.000	2.400
Max. vacuum (Pa)	20.000	18.000
Filter surface area (cm ²)	5.357	5.357
Rubber-insulated mains cable (m)	5	–
Container/filter bag capacity (l)	4,5/3,5	4,5/3,5
Dimensions (L x W x H) (mm)	396 x 296 x 270	396 x 297 x 307
Max. appliance socket connected load (watt)	1.200	–
Battery capacity (Ah)	–	4
2 x 4.0 Ah runtime (min)	–	14 – 25
Weight (kg)	6,9	–
Weight with battery (kg)	–	8,8

System accessories
from page

172



Integrated Bluetooth® technology
Ideal combination of the cordless Systainer extractor with Festool cordless tools. Convenient and fast: The extractor switches on automatically via the remote control or the Bluetooth® battery pack.



Just the size it should be

The removable hose holder makes the Systainer extractor even smaller.





Powerful dust extraction with battery

Impressive suction power: Comparable power to your corded extractor thanks to the 36 V turbine with 2 x 18 V battery packs.



Easy to transport in fewer trips

Its low weight, Systainer format and shoulder strap make the extractor easy to carry. This leaves your hands free for any other materials or tools you might need.

Items included	RRP in £*	Order no.
CTL SYS		
 CTL SYS 240V fitted filter bag, smooth suction hose dia. 27 x 3 m AS/CT with rotating angle adapter on the extractor side, hose holder, SYS-Dock with T-LOC function, upholstery nozzle D 36 PD, crevice nozzle D 36 FD-150, SYS-CT carrying belt	314.00 376.80	575284
CTC SYS		
All variants: main filter, fitted filter bag, smooth suction hose dia. 27 x 3 m AS/CT with rotating angle adapter on the extractor side, hose holder, SYS-Dock with T-LOC function, upholstery nozzle D 36 PD, crevice nozzle D 36 FD-150, SYS-CT carrying belt, CT-F I extractor remote control		
 CTLC SYS I-Basic without battery pack, without charger	311.00 373.20	576936
CTLC SYS HPC 4,0 I-Plus energy set, SYS 18 V 4 x 4.0/TCL 6 DUO	693.00 831.60	576945
CTMC SYS I-Basic without battery pack, without charger	401.00 481.20	576933
CTMC SYS HPC 4,0 I-Plus energy set, SYS 18 V 4 x 4.0/TCL 6 DUO	783.00 939.60	576943

You can find more information about the Energy sets on page 29

* Manufacturer's recommended retail price. Dealer prices may vary.
Excl. VAT. | Incl. VAT.

Compact suction power. Now also with a battery.

The CT MINI and CT MIDI mobile dust extractors.

Low weight, compact dimensions and all of the innovative details you can imagine – the CT MINI/MIDI compact dust extractors boast a comprehensive range of enticing features. For healthier work in dust classes L and M. Additional benefit: Convenient and quick Bluetooth® autostart via your battery pack or remote control. And, just like usual, everything is compatible: The extractor, tool, T-LOC Systemair connection and the smooth suction hose. This makes the system perfect in every way.

Available from
spring 2022



Cordless mobile
dust extractor

CLEANTEC CTC MINI I

10 l container capacity for class L dust.



Mobile
dust extractor
CLEANTEC CT MINI I

10 l container capacity for class L dust.



Available from
spring 2022



Cordless mobile
dust extractor

CLEANTEC CTC MIDI I

With automatic suction hose detection and
15 l container capacity for class L and M dusts.



Mobile
dust extractor

CLEANTEC CT MIDI I

With automatic suction hose detection and
15 l container capacity for class L and M dusts.





Smooth suction hose

With conical geometry for improved suction power, smooth outer skin allow it to glide over all surfaces and edges perfectly.



High suction power

Comparable power to your corded version thanks to the 36 V turbine with 2 x 18 V battery packs (4.0/5.2/8.0* Ah). This makes it ideal for mobile sawing, sanding or drilling.

Manual cleaning

Manual dedusting of the main filter and filter bag means the suction power can be restored once the filter or filter bag is inserted for a significant increase in filling capacity.



Filter replacement from outside

Quick, easy and tool-free.



Practical remote control

Switching on the extractor via the remote control directly on the suction hose saves you a trip to the extractor. Ideal for occasional cleaning tasks.

Perfected. For your cordless tools.

Whether for mobile sawing, grinding or drilling: Our CTC MINI and CTC MIDI compact dust extractors fit perfectly into the Festool 18 V system. This ensures dust-free work for the cordless application. The integrated Bluetooth® technology ensures perfect interaction with Festool cordless tools. Convenient and quick Bluetooth® autostart via the battery pack or remote control.

You can find more information on page 29













06 Dust extraction



Technical data	CT MINI I	CTC MINI I*	CT MIDI I	CTC MIDI I*
Power consumption (watt)	350 – 1.200	–	350 – 1.200	–
Battery voltage (V)	–	36	–	36
Max. volume flow (l/min)	3.700	3.100	3.700	3.100
Max. vacuum (Pa)	24.000	19.000	24.000	19.000
Filter surface area (cm ²)	3.369	3.369	3.369	3.369
Rubber-insulated mains cable (m)	7,5	–	7,5	–
Container/filter bag capacity (l)	10/7,5	10/7,5	15/12,5	15/12,5
Dimensions (L x W x H) (mm)	470 x 320 x 455	550 x 320 x 455	470 x 320 x 495	550 x 320 x 495
Max. appliance socket connected load (watt)	2.200	–	2.200	–
Battery capacity (Ah)	–	4 / 5,2 / 8	–	4 / 5,2 / 8
2 x 4.0 Ah runtime (min)	–	12 – 22	–	12 – 22
2 x 5.2 Ah runtime (min)	–	16 – 30	–	16 – 30
2 x 8.0 Ah runtime (min)	–	24 – 45	–	24 – 45
Weight (kg)	11	–	11,3	–
Weight with battery (kg)	–	13 / 13,2 / 13,8	–	13,2 / 13,4 / 14

* 8.0 Ah Li-HighPower battery pack available from October 2022

Items included	RRP in £*	Order no.
CT MINI I All variants: High-performance main filter, smooth suction hose dia. 27/32 x 3.5 m AS/CTR, SC FIS-CT SELFCLEAN filter bag, hose holder, cable holder, SYS-Dock with T-LOC function		
 CTL MINI I 110V	396.00 475.20	574844
 CTL MINI I 240V	396.00 475.20	574843
CTC MINI I		
 CTLC MINI I-Basic without battery pack, without charger, High-performance main filter, SC FIS-CT SELFCLEAN filter bag, smooth suction hose dia. 27/32 x 3.5 m AS/CTR, hose holder, SYS-Dock with T-LOC function, CT-F I extractor remote control	396.00 475.20	577065
CT MIDI I All variants: High-performance main filter, smooth suction hose dia. 27/32 x 3.5 m AS/CTR, SC FIS-CT SELFCLEAN filter bag, hose holder, cable holder, SYS-Dock with T-LOC function		
 CTL MIDI I 110V	432.00 518.40	574836
 CTL MIDI I 240V	432.00 518.40	574835
 CTM MIDI I 110V extraction sleeve with bypass	523.00 627.60	574825
 CTM MIDI I 240V extraction sleeve with bypass	523.00 627.60	574826
CTC MIDI I All variants: High-performance main filter, SC FIS-CT SELFCLEAN filter bag, smooth suction hose dia. 27/32 x 3.5 m AS/CTR, hose holder, SYS-Dock with T-LOC function, CT-F I extractor remote control		
 CTLC MIDI I-Basic without battery pack, without charger	441.00 529.20	577066
 CTLC MIDI I-Plus energy set, SYS 18 V 4 x 5.2/TCL 6 DUO	883.00 1,059.60	577152
 CTMC MIDI I-Basic without battery pack, without charger	531.00 637.20	577067
 CTMC MIDI I-Plus energy set, SYS 18 V 4 x 5.2/TCL 6 DUO	973.00 1,167.60	577153

System accessories
from page

172

The specialist for cleaning work.

The practical mobile dust extractor.

Ideal for cleaning on construction sites, in workshops and offices: With a 15 l container volume, the CLEANTEC CT 15 extracts dust, dirt and water. Its design ensures that almost the entire container volume can be used – for long periods of work without having to change the filter bag.



Mobile dust extractor **CLEANTEC CT 15**

Cleaning accessories already included with delivery. Extractor with 15 l container capacity.

Technical data	CT 15
Power consumption (watt)	350 – 1.200
Max. volume flow (l/min)	3.700
Max. vacuum (Pa)	24.000
Filter surface area (cm ²)	3.369
Rubber-insulated mains cable (m)	5,5
Container/filter bag capacity (l)	15/12,5
Dimensions (L x W x H) (mm)	470 x 320 x 430
Max. appliance socket connected load (watt)	2.200
Weight (kg)	11,2

Items included	RRP in £*	Order no.
CT 15 E High-performance main filter, suction hose diameter 27/32 x 3.5 m, SC FIS-CT SELF-CLEAN filter bag, crevice nozzle D 36 FD-150, upholstery nozzle D 36 PD	279.00 334.80	574830



Cleaning accessories directly included

Crevice nozzle and upholstery nozzle can be stored in the mobile dust extractor.



Touch operation

Intuitive touch control panel instead of rotary knobs – for extremely simple operation even when wearing gloves and when dirt builds up.

Note: The suction hose included in the CT 15's scope of delivery is not antistatic.
* Manufacturer's recommended retail price. Dealer prices may vary.

Excl. VAT. | Incl. VAT.

Vibration and emissions values can be found in the operating manual at www.festool.co.uk/vibration

The true size can be found inside. The all-round mobile dust extractors.

Compact yet effective. Lightweight yet powerful. Whether on the construction site or in the workshop – the generous container geometry of the CLEANTEC CT 26/36/48 offers a significantly larger capacity with compact dimensions. The extremely compact high-performance turbine supplies the appropriate suction power with a volume flow of 3900 l/min. With antistatic function to prevent build up of static charge when working.



Mobile
dust extractor
CLEANTEC CT 36

36 l container capacity for
class L and M dusts.



Mobile
dust extractor
CLEANTEC CT 26

26 l container capacity for
class L and M dust.



Mobile
dust extractor
CLEANTEC CT 48

48 l container capacity for
class L and M dust.



Large capacity

The filter bag is free to unfold because of the flat filter and the smooth inner contours of the container. This allows the bag to be filled uniformly and a nearly 100% utilisation of the filter bag volume.



Simply flexible

Smooth, elastic and extremely robust. The smooth suction hose will win you over thanks to its improved handling and longer service life. It glides over every edge and possesses conical geometry for increased suction capacity.



Safe transport

Accessories and tools in the Systemer, SORTAINER and SYS tool box can be quickly and easily connected to the extractor via the SYS dock thanks to the T-LOC system.



Optional extension

Depending on requirements, the extractor can be equipped with additional modules, such as a compressed air module, an electrical outlet module with continuous power or automatic electronic switch-on/shut-off switch, an energy box module or a Bluetooth® module.

Our recommendation:
Festool Work app.

With the Work app, you can individually adjust your connected Festool tools to your work conditions, register for warranty all-inclusive or view their performance data at any time. If something should go wrong with your tool, the Work app sends the right solution via push notification directly to your smartphone. This ensures optimal work progress and perfect results adapted to your requirements.

Download now
free of charge



You can find more information on page 6

Fully automatic filter cleaning.

The self-cleaning mobile dust extractors.

No more clogged filters – the AUTOCLEAN (AC) automatic main filter cleaning keeps the filter clean and ensures continuously high suction power for large quantities of fine dust. With antistatic function to prevent static charge when working.



Mobile dust extractor

CLEANTEC CT 26 AC

26 l container capacity for class L and M dust.



Mobile dust extractor

CLEANTEC CT 36 AC

36 l container capacity for class L and M dusts.



Mobile dust extractor

CLEANTEC CT 48 AC

48 l container capacity for class L and M dust.





Adjustable according to requirements

The cleaning intervals can be continuously adjusted using the rotary switch. The shorter the interval, the more intensive the cleaning.



Safe transport

Accessories and tools in the Systainer, SORTAINER and SYS tool box can be quickly and easily connected to the extractor via the SYS dock thanks to the T-LOC system.



Simply flexible

Smooth, elastic and extremely robust. The smooth suction hose will win you over thanks to its improved handling and longer service life. It glides over every edge and possesses conical geometry for increased suction capacity.



Optional extension

Depending on requirements, the extractor can be equipped with additional modules, such as a compressed air module, an electrical outlet module with continuous power or automatic electronic switch-on/shut-off switch, an energy box module or a Bluetooth® module.

Ideal for demanding everyday use on construction sites
The CT-VA pre-separator.

Handles high levels of dust thanks to cyclone technology.
 Ensures constant high suction power thanks to removal of load from the main filter.

You can find more information on page 170



Ideal for drywall construction.

The mobile dust extractor for PLANEX long-reach sander.

The powerful CLEANTEC CTM 36 AC PLANEX with 36 l container capacity is precisely designed for the high material removal rate of the PLANEX long-reach sander. With a kink-resistant hose and standard ComfortClean closing slide for even more effective filter cleaning.



Mobile dust extractor **CLEANTEC CT 36 AC PLANEX**

With 36 l container capacity and tool holder for class L and M dusts.



Convenient and time-saving

The long-reach sander is securely attached to the tool holder. This enables abrasives to be changed quickly and conveniently or the range of the PLANEX to be extended with just a few hand movements. With a practical carry handle.

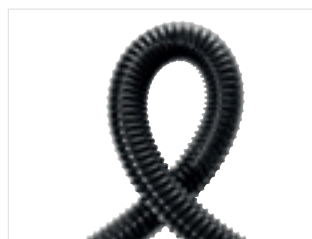

Maximum flexibility

Highly sensitive and non-buckling suction hose.



Mobile dust extractor **CLEANTEC CT 36 AC LHS**

36 l container capacity for class L and M dusts.

Heavy-duty tool.

The construction site extractor with automatic cleaning function.

When it comes to handling particularly large quantities of dust, which can accrue when working with surface-restoration millers and diamond grinders, the RENOFIX extractors are in their element. The AUTOCLEAN (AC) automatic main filter cleaning system regularly rinses the high-performance main filter clean and guarantees a constantly high suction power.



Mobile dust extractor **CLEANTEC CT 36 AC RENOFIX**

36 l container capacity for class L and M dusts.



Mobile dust extractor **CLEANTEC CT 26 AC RENOFIX**

With 26 l container capacity for class L dusts.



Systems get it done

Can be coupled with Systainers and SORTAINERS on the SYS dock. Plug-in system for additional modules: Compressed air or Bluetooth®.



Manual cleaning

Even heavily clogged filters can be cleaned: When the container inlet is closed manually with the ComfortClean sealing slide, a strong vacuum is generated, which cleans the filter with maximum force.





06 Dust extraction





Technical data	CT 26	CT 36	CT 48	CT 26 AC	CT 36 AC	CT 48 AC
Power consumption (watt)	350 – 1.200	350 – 1.200	350 – 1.200	350 – 1.200	350 – 1.200	350 – 1.200
Max. volume flow (l/min)	3.900	3.900	3.900	3.900	3.900	3.900
Max. vacuum (Pa)	24.000	24.000	24.000	24.000	24.000	24.000
Rubber-insulated mains cable (m)	7,5	7,5	7,5	7,5	7,5	7,5
Container/filter bag capacity (l)	26/24	36/34	48/46	26/24	36/34	48/46
Dimensions (L x W x H) (mm)	630 x 365 x 540	630 x 365 x 596	740 x 406 x 1.005	630 x 365 x 540	630 x 365 x 596	740 x 406 x 1.005
Max. appliance socket connected load (watt)	2.400	2.400	2.400	2.400	2.400	2.400
Weight (kg)	13,7	14,4	16,2	14,7	15,2	16,9



Technical data	CT 36 AC LHS	CT 36 AC PLANEX	CT 26 AC RENOFIX	CT 36 AC RENOFIX
Power consumption (watt)	350 – 1.200	350 – 1.200	350 – 1.200	350 – 1.200
Max. volume flow (l/min)	3.900	3.900	3.900	3.900
Max. vacuum (Pa)	24.000	24.000	24.000	24.000
Rubber-insulated mains cable (m)	7,5	7,5	7,5	7,5
Container/filter bag capacity (l)	36/34	36/34	26/24	36/34
Dimensions (L x W x H) (mm)	630 x 365 x 596	630 x 365 x 596	630 x 365 x 540	630 x 365 x 596
Max. appliance socket connected load (watt)	2.400	2.400	2.200	2.200
Weight (kg)	15,2	15,2	14,5	15,2

Items included	RRP in £*	Order no.
CT 26	All variants: High-performance main filter, smooth suction hose dia. 27/32 x 3.5 m AS/CTR, hose holder, SYS-Dock with T-LOC function, cable holder	
 CTL 26 E 110V SELFCLEAN filter bag	546.00 655.20	574950
 CTL 26 E 240V SELFCLEAN filter bag	546.00 655.20	574951
 CTM 26 E 240V SELFCLEAN filter bag, end cap for intake adapter	727.00 872.40	575021
CT 36		
 CTL 36 E 240V High-performance main filter, SELFCLEAN filter bag, smooth suction hose dia. 27/32 x 3.5 m AS/CTR, hose holder, SYS-Dock with T-LOC function, cable holder	658.00 789.60	574968

Items included	RRP in £*	Order no.	
CT 48			
	CTL 48 E High-performance main filter, SELFCLEAN filter bag, smooth suction hose dia. 27/32 x 3.5 m AS/CTR, hose holder, SYS-Dock with T-LOC function, cable holder, handle	not available in Great Britain	574975
CT 26 AC			
All variants: High-performance main filter, disposal bag, smooth suction hose dia. 27/32 x 3.5 m AS/CTR, hose holder, SYS-Dock with T-LOC function, cable holder			
	CTL 26 E AC 240V SELFCLEAN filter bag	639.00 766.80	574944
	CTM 26 E AC 110V SELFCLEAN filter bag, end cap for intake adapter	816.00 979.20	574979
	CTM 26 E AC 240V SELFCLEAN filter bag, end cap for intake adapter	816.00 979.20	575020
CT 36 AC			
	CTM 36 E AC 240V High-performance main filter, SELFCLEAN filter bag, disposal bag, smooth suction hose dia. 27/32 x 3.5 m AS/CTR, end cap for intake adapter, hose holder, SYS-Dock with T-LOC function, cable holder	922.00 1,106.40	577272
CT 48 AC			
	CTL 48 E AC High-performance main filter, SELFCLEAN filter bag, disposal bag, smooth suction hose dia. 27/32 x 3.5 m AS/CTR, hose holder, SYS-Dock with T-LOC function, cable holder, handle	not available in Great Britain	574974
CT 36 AC PLANEX			
All variants: High-performance main filter, SELFCLEAN filter bag, disposal bag, kink-resistant suction hose D36x3.5-AS/LHS 225, Comfort clean closing slide, hose holder, cable holder			
	CTM 36 E AC-LHS 110V	934.00 1,120.80	574985
	CTM 36 E AC LHS 240V	934.00 1,120.80	575652
	CTM 36 E AC-PLANEX 110V PLANEX tool holder	964.00 1,156.80	576852
	CTM 36 E AC-PLANEX 240V PLANEX tool holder	964.00 1,156.80	576855
CT 26 AC RENOFIX			
	CTL 26 E AC RENOFIX High-performance main filter, disposal bag, smooth suction hose dia. 36/32 x 3.5 m AS/R with rotating connecting sleeves, Comfort clean closing slide, hose holder, cable holder	not available in Great Britain	575841
CT 36 AC RENOFIX			
	CTL 36 E AC RENOFIX High-performance main filter, disposal bag, smooth suction hose dia. 36/32 x 3.5 m AS/R with rotating connecting sleeves, Comfort clean closing slide, hose holder, cable holder	not available in Great Britain	575842

No chance for hazardous dust.

The special extractors.

Hazardous dusts such as mould and asbestos, harmful wood preservatives, mineral fibre dust, lead, cadmium, nickel and zinc chromate are reliably extracted by the CLEANTEC CTH. The dust extractor with 99.995% filter collection efficiency is a specialist tool for extracting carcinogenic and pathogenic dusts.



Mobile dust extractor **CLEANTEC CTH 26**

26 l container capacity for class H dust.



Mobile dust extractor **CLEANTEC CTH 48**

48 l container capacity for class H dust.



Technical data	CTH 26	CTH 48
Power consumption (watt)	350 – 1.000	350 – 1.000
Max. volume flow (l/min)	3.900	3.900
Max. vacuum (Pa)	24.000	24.000
Filter surface area (cm ²)	6.318	6.318
Rubber-insulated mains cable (m)	7,5	7,5
Container/filter bag capacity (l)	26/24	48/46
Dimensions (L x W x H) (mm)	630 x 365 x 540	740 x 406 x 1.005
Max. appliance socket connected load (watt)	2.400	2.400
Weight (kg)	13,9	16,5

Items included	RRP in £*	Order no.
All variants: High-performance main filter, smooth suction hose dia. 27/32 x 3.5 m AS/CTR, hose holder, SYS-Dock with T-LOC function, cable holder		
CTH 26 E / a safety filter bag	838.00 1,005.60	577273
CTH 48 E / a safety filter bag, handle	not available in Great Britain	574941

System accessories
from page

172

Mobile dust extractor CLEANTEC CT 48 EC/B22



To ensure maximum safety, the CT 48 EC/B22 special extractor conforms to the ATEX Directive 94/9/EC for zone 22. This means that dry, combustible dust on machines and tools is reliably extracted.



Technical data	CT 48 EC B22
Power consumption (watt)	150 – 1.100
Max. volume flow (l/min)	3.400
Max. vacuum (Pa)	23.000
Rubber-insulated mains cable (m)	7,5
Container/filter bag capacity (l)	48/46
Dimensions (L x W x H) (mm)	630 x 406 x 640
Weight (kg)	18,6

Convenient and safe

The robust ABS plastic container is equipped with additional flame protection and is therefore suitable for the safe extraction of aluminium, paper, soot and powder coating dust right through to glass and carbon-reinforced plastics.

Items included	RRP in £*	Order no.
 CT 48 EC B22		
 CTL 48 E LE EC/B22 R1 High-performance main filter, SELFCLEAN filter bag, smooth suction hose dia. 27/32 x 3.5 m AS/CTR, cable holder, compressed air module	not available in Great Britain	575275

Mobility in the tightest of spaces. WCR 1000 Workcenter

Attached to Festool mobile dust extractors without tools via the SYS dock, the WCR 1000 Workcenter turns any Festool mobile dust extractor from CLEANTEC CT 26 onwards into a mobile, individually configurable compact work station.**

You can find more information on page 328



** For CT 48 EC/B22, the adapter AD-WCR 498805 is required for connection.

* Manufacturer's recommended retail price. Dealer prices may vary.

Excl. VAT. | Incl. VAT.

Vibration and emissions values can be found in the operating manual at www.festool.co.uk/vibration

Copes with high volumes of dust. Efficient, simple and reliable.

The pre-separator.

From now on, large quantities of dust and chips are not a problem any more – neither for the main filter nor for the suction power. Up to 80% of mineral dusts and up to 95% of large dusts such as sawing chips are separated and collected in the collecting vessel. This takes the strain off the main filter and guarantees consistently high suction power throughout the entire work process.



Pre-separator CT-VA

Copes with high levels of dust thanks to cyclone technology. Approved for dust classes L and M.

Technical data	CT-VA
Dimensions (L x W x H) (mm)	395 x 295 x 515
Max. container capacity (l)	20
Weight (kg)	7

System accessories
from page

172

Items included	RRP in £*	Order no.
CT-VA  CT-VA-20 cyclone Systainer, VAB-20 collection container, Systainer pan, connecting hose, disposal bag, container lid	333.10 399.72	204083



Easy retrofitting

Compatible with Festool mobile dust extractors CT 26/36/48 – with and without AC dedusting. Approved for dust categories L and M.



Flexible to use



Flexible operation with or without CT pre-separator depending on the application. The mobile dust extractor and CT pre-separator can be connected easily using the SYS-Dock system.







Easy disposal

Easy and safe to transport thanks to a stackable collection container with compact dimensions and a sturdy design.

Accessories

	RRP in £*	Order no.
 <p>Disposable bag ENS-VA-20/10 ideal shape for CT-VA 20 pre-separator collection container, for class L and M dust, for use in VAB-20 collection container, includes 10 cable ties, qty. in pack 10 Units, max. container capacity 20 l</p>	<p>21.60 25.92</p>	<p>204296</p>
 <p>Collection container VAB-20/1 for CT-VA 20 pre-separator, can be stacked, with compact dimensions, easy to handle and robust design, can be well sealed for transportation using the cover (included in scope of delivery), dimensions (L x W x H) 395 x 295 x 350 mm, max. container capacity 20 l</p>	<p>66.70 80.04</p>	<p>204294</p>
 <p>Connecting cable CT-VA AK for CT-VA 20 pre-separator, for retrofitting the CT-VA pre-separator with additional electrical outlet module, enables particularly easy connection of the plug it suction hose with the CT-VA pre-separator, max. appliance socket connected load 2.400 watt, cable length 0,85 m</p>	<p>not available in Great Britain</p>	<p>575667</p>

CLEANTEC cleaning sets	RRP in £*	Order no.
 <p>Cleaning set D 27 / D 36 D-RS for simple cleaning tasks and to supplement existing cleaning sets, crevice nozzle D 36 FD-210, upholstery nozzle D 36 PD, suction brush D 36 SP</p>	<p>13.70 16.44</p>	492392
 <p>Standard cleaning set RS-ST D 27/36-Plus for all cleaning tasks in narrow spaces, on surfaces and on the ground, curved hand tube D 36 HR-K AS, floor nozzle, D 36 BD 300, extension pipes D 36 VR-K AS, crevice nozzle, D 36 FD-300, suction brush D 36 SP, Systainer SYS3 M 137</p>	<p>72.00 86.40</p>	577257
 <p>Cleaning set for tradesmen RS-HW D 36-Plus universal cleaning set with D 36 suction hose for improved cleaning performance, curved hand tube D 36 HR-K AS, floor nozzle, D 36 BD 300, extension pipes D 36 VR-K AS, crevice nozzle, D 36 FD-300, suction brush D 36 SP, smooth suction hose D 36 x 3.5 m, antistatic, Systainer SYS3 M 437</p>	<p>162.00 194.40</p>	577258
 <p>Floor cleaning set RS-BD D 36-Plus perfect for large floor surfaces thanks to the wide nozzle with height-adjustable brush ring, curved hand tube D 36 HR-K AS, floor nozzle, D 36 BD 370, extension tube, special steel 3-piece D 36 VR-M3x, crevice nozzle, D 36 FD-300, smooth suction hose D 36 x 3.5 m, antistatic, Systainer SYS3 M 437</p>	<p>238.50 286.20</p>	577259
 <p>Cleaning set for industrial use RS-GS D 50 for coarse dusts in the workshop and on the construction site, suction hose, D 50x2.5 m-AS, extension tubes D50VR-K, floor nozzle D 50 BD370, square nozzle D 50 QD, suction brush D 50 SP, crevice nozzle D 50 FD</p>	<p>135.00 162.00</p>	577260















Our recommendation: Festool Order app.

Download now
free of charge

With the Order app, you can find your Festool tool, suitable accessories and consumables, and create your digital shopping list and send it conveniently to your dealer. The favourites function allows you to easily re-order saved accessories or consumables. You can also manage your orders comfortably whilst on the go, can maintain an overview of these at all times and ensure your everyday work is even more well organised.





You can find more information on page 6

Accessories for mobile dust extractors CT and dust extractors SR		RRP in £*	Order no.
CLEANTEC suction hose anti-static version			
	Hook-and-loop fastener KV-215/5 for securing the cable on the suction hose, reusable and flexible, suitable for suction hoses with a diameter of 27 mm, 32 mm and 36 mm, qty. in pack 5 Units, length 215 mm	7.20 8.64	205294
	Suction hose D 27x3m-AS-90°/CT for CTL SYS, CTLC SYS, CTMC SYS, antistatic, temperature-resistant to +70°C, with rotating angle adapter on the extractor side and connecting sleeve with integrated bypass, smooth, diameter 27 mm, length 3 m, bleeder resistor (DIN IEC 312) <1 mΩ/m	107.50 129.00 35.83 / 1 m 43.00 / 1 m	577160
Suction hose All variants: antistatic, temperature-resistant to +70°C, smooth, Conical, diameter 27 /32 mm, bleeder resistor (DIN IEC 312) <1 mΩ/m			
	D 27/32x3,5m-AS-90°/CT for CTL MINI/MIDI manufactured until 12/2018, with rotating angle adapter on the extractor side and connecting sleeve with integrated bypass, length 3,5 m	135.90 163.08 38.83 / 1 m 46.59 / 1 m	577161
	D 27/32x3,5m-AS/CTR for CT 26/36/48, for CTC MINI and CTC MIDI, for CT MINI and CT MIDI from YOM 2019 onwards, with rotating adapter and connecting sleeve with integrated bypass, length 3,5 m	135.90 163.08 38.83 / 1 m 46.59 / 1 m	577158
	D 27/32x5m-AS/CTR for CTC MINI and CTC MIDI, for CT MINI and CT MIDI from YOM 2019 onwards, for CT 26/36/48, with rotating adapter and connecting sleeve with integrated bypass, length 5 m	166.00 199.20 47.43 / 1 m 56.91 / 1 m	577159
Suction hose All variants: for cleaning tasks with CT dust extractors, not suitable for dust extractors with AUTOCLEAN, antistatic, temperature-resistant to +70°C, with rotating adapter and connector, smooth, diameter 36 mm, bleeder resistor (DIN IEC 312) <1 mΩ/m			
	D36x3,5m-AS/CTR length 3,5 m	153.80 184.56 43.94 / 1 m 52.73 / 1 m	204924
	D36x5m-AS/CTR length 5 m	197.80 237.36 39.56 / 1 m 47.47 / 1 m	204925
	D36x7m-AS/CTR length 7 m	251.10 301.32 35.87 / 1 m 43.05 / 1 m	204926
	Suction hose D36/32x3,5m-AS/R suitable for dust extractors with AUTOCLEAN, antistatic, temperature-resistant to +70°C, for masonry renovation and cleaning work, smooth, Conical, diameter 36 /32 mm, length 3,5 m, bleeder resistor (DIN IEC 312) <1 mΩ/m	143.90 172.68 41.11 / 1 m 49.34 / 1 m	204923
	Suction hose D 36x3,5-AS/KS/B/LHS 225 for long-reach sander PLANEX, antistatic, temperature-resistant to +70°C, extremely flexible, kink-resistant suction hose, with bypass sleeve for extremely light fillers: enables the suction effect of the PLANEX on the wall to be reduced to an absolute minimum, diameter 36 mm, length 3,5 m, bleeder resistor (DIN IEC 312) <1 mΩ/m	149.40 179.28 42.69 / 1 m 51.22 / 1 m	577101
Suction hose All variants: antistatic, temperature-resistant to +70°C, ordered by metre (without rotating adapter or reducing sleeve), bleeder resistor (DIN IEC 312) <1 mΩ/m			
	D 27 MW-AS diameter 27 mm	31.70 38.04 31.70 / 1 m 38.04 / 1 m	452384
	D 36 MW-AS diameter 36 mm	39.70 47.64 39.70 / 1 m 47.64 / 1 m	452385
Suction hose All variants: antistatic, temperature-resistant to +70°C, bleeder resistor (DIN IEC 312) <1 mΩ/m, diameter 50 mm			
	D 50x2,5m-AS with 2x rotating adapter, length 2,5 m	122.90 147.48 49.16 / 1 m 58.99 / 1 m	452888
	D 50x4m-AS with 2x rotating adapter, length 4 m	185.90 223.08 46.48 / 1 m 55.77 / 1 m	452890
	D 50 MW-AS ordered by metre (without rotating adapter or reducing sleeve)	43.70 52.44 43.70 / 1 m 52.44 / 1 m	452386

06 Dust extraction

Accessories for mobile dust extractors CT and dust extractors SR

		RRP in £*	Order no.
CLEANTEC suction hose anti-static version			
<p>Suction hose All variants: for all power tools with D27 and D36 flange (all Festool power tools) and cleaning accessories, with plug it-connection, antistatic, suitable for sanding applications, with rotating adapter and reducing sleeve with bayonet fitting, temperature-resistant to +70°C, smooth, diameter 27 /22 mm, bleeder resistor [DIN IEC 312] <1 mΩ/m</p>			
	<p>D 27/22x3,5m-AS-GQ/CT length 3,5 m</p>	<p>167.80 201.36 47.94 / 1 m 57.53 / 1 m</p>	200046
	<p>D 27/22x5m-AS-GQ/CT length 5 m</p>	<p>217.80 261.36 43.56 / 1 m 52.27 / 1 m</p>	201762
	<p>Suction hose D 32/22x10m-AS-GQ/CT for all power tools with D27 and D36 flange (all Festool power tools) and cleaning accessories, with plug it-connection, antistatic, suitable for sanding applications, with rotating adapter and reducing sleeve with bayonet fitting, temperature-resistant to +70°C, smooth, diameter 32 /22 mm, length 10 m, bleeder resistor [DIN IEC 312] <1 mΩ/m</p>	<p>not available in Great Britain</p>	201777



		RRP in £*	Order no.
CLEANTEC suction hose			
	<p>Suction hose D 21,5 x 5m HSK for direct connection (without reducing ring) to hand sanding block with extraction, diameter 21,5 mm, length 5 m</p>	<p>32.40 38.88 6.48 / 1 m 7.78 / 1 m</p>	495019









Accessories for mobile dust extractors CT and dust extractors SR		RRP in £*	Order no.
CLEANTEC hose sleeves			
Rotating adapter All variants: antistatic, hose sleeve for connection to the inlet nozzle on the mobile dust extractor, outside dia. 58 mm			
	D 27 DAG-AS for antistatic suction hose D 27, diameter 27 mm	21.70 26.04	452892
	D32/27 DAG-AS/CTR for D 27/32 antistatic suction hose	21.80 26.16	204919
	D36 DAG-AS/CTR for antistatic suction hose D 36, diameter 36 mm	26.30 31.56	204920
	D 50 DAG-AS for antistatic suction hose D 50	31.30 37.56	452896
	D 36 DAG-AS-GQ/CT for antistatic suction hose D27/22x3.5 AS-GQ/CT and D27/22x5 AS-GQ/CT, diameter 36 mm	26.30 31.56	202931
	D 50 DAG-AS-GQ/CT for antistatic suction hose D32/22x10 AS-GQ/CT, diameter 50 mm	31.40 37.68	203206
	Rotating angle adapter D 32/27 DAG/90°-AS/CT for antistatic suction hose D 32/27 on CTL MINI and CTL MIDI, antistatic, for CTL MINI and CTL MIDI from YOM September 2013 to YOM December 2018, hose sleeve for connection to the inlet nozzle on the mobile dust extractor, outside dia. 58 mm	23.50 28.20	500673
Connecting sleeve			
	D 27 DM-AS/CT for all power tools with D 27 and D 36 flange and D 27 and D 36 cleaning accessories, for the D 27 and D 27/32 suction hose, hose connector for electric tool or suction nozzle, the bayonet fitting produces a secure connection between the mobile dust extractor and the power tool, with bypass for individually adjusting the air flow rate, diameter 27 mm	15.50 18.60	577162
	D 27/22 DM-AS/CT for all power tools with D27 and D36 flange (all Festool power tools) and cleaning accessories, only for the smooth suction hoses with integrated plug it-cable, antistatic, for connection to tools (power tools or suction nozzle), the bayonet fitting creates a secure connection between the mobile dust extractor and the power tool, diameter 27 /22 mm	15.40 18.48	500668
	D 36 DM-AS/CT for all power tools with D36 flange and cleaning accessories, for suction hose D 36, antistatic, hose connector for electric tool or suction nozzle, the bayonet fitting produces a secure connection between the mobile dust extractor and the power tool, diameter 36 mm	19.70 23.64	500670
	D 36/32 DM-AS for all power tools with D36 flange and cleaning accessories, for D 36/32 suction hose, antistatic, hose connector for electric tool or suction nozzle, diameter 36 mm	19.70 23.64	500671
	Suction sleeve D27 BP-AS/CT for improved control of all sanders, especially recommended for RTS 400, RTSC 400, DTS 400, DTSC 400, ETS 125, ETSC 125 and RO 90, prevents sticking on smooth surfaces, diameter 27 mm	16.90 20.28	204822

* Manufacturer's recommended retail price. Dealer prices may vary.
Excl. VAT. | Incl. VAT.

06 Dust extraction

Accessories for mobile dust extractors CT and dust extractors SR		RRP in £*	Order no.
CLEANTEC hose sleeves			
	Reducing sleeve DC-D 36/27-AS for all VCP/CT, dust extraction end, reduction of dia. 36 to 27 mm, can be attached if necessary, diameter 36 mm	21.40 25.68	768135
	Connecting sleeve D 36 DM-AS-B-LHS 225 for suction hose D 36, for long-reach sander PLANEX, antistatic, hose connector for electric tool or suction nozzle, for extremely light fillers: enables the suction effect of the PLANEX on the wall to be reduced to an absolute minimum, diameter 36 mm	20.80 24.96	577100
	Extraction adapter D 50/D 36 for connecting a D 50 suction hose to D 36 accessory	14.30 17.16	452897
	Y-piece D 50 SV-AS/D 50 V for D 50/D 36/D 27, antistatic, for connection of two dust extraction hoses, with blanking plug, for extractors that admit hazardous dust, simultaneous operation is not permitted	38.30 45.96	452898
	Blanking plug D 50/V for closing the inlet nozzle, for retrofitting all CTM/CTH mobile dust extractors	15.20 18.24	452899
	Connector sleeve D 50/D 50 VM-AS antistatic, for connecting suction hoses D 50/D 36/D 27, the reducing sleeve on D 27/D 36 hoses must be replaced with a D 36/D 27 rotating adapter	17.10 20.52	493047
		RRP in £*	Order no.
Tubes			
	Hand tube D 36 HR-K AS for D 27/D 36, antistatic, with sliding air regulator for suction power adjustment, with bayonet fitting for secure connection to the extractor hose, curved, diameter 36 mm	22.20 26.64	203129
Extension pipe			
	D 36 VR-M 3x for D 27/D 36, of stainless steel, 3-piece, qty. in pack 3 Units, length 950 mm	54.20 65.04	452902
	D 36 VR-K AS 3x for D 27/D 36, antistatic, 3-piece, qty. in pack 3 Units, length 950 mm	24.90 29.88	203137
	D 50 VR-K 2x for D 50, plastic, 2 pieces, qty. in pack 2 Units, length 970 mm	33.80 40.56	440412
		RRP in £*	Order no.
Carpet and combination suction hose			
	Carpet nozzle D 36 TD II for D 27/D 36, with sliding base, changeover from carpet to smooth floor, width 292 mm	46.70 56.04	203797
	Turbo combination suction brush D 36 TKB II for D 27/D 36, for textile and linoleum floors, with 4 castors, brush rollers driven by intake air, width 270 mm	119.50 143.40	203809

Accessories for mobile dust extractors CT and dust extractors SR		RRP in £*	Order no.
Floor nozzles			
Floor nozzle			
	D 36 BD 370 for D 27/D 36, high-quality industrial design, aluminium, with 2 castors and 2 brush inserts, diameter 36 mm, width 370 mm	131.90 158.28	452908
	D 50 BD 450 for D 50, high-quality industrial design, aluminium, with 2 castors and 2 brush inserts, width 450 mm	148.30 177.96	452910
	D 36 BD 300 for D 27/D 36, plastic, with 2 castors and 2 brush inserts, width 300 mm, diameter 36 mm	18.50 22.20	577261

Accessories for CT mobile dust extractors		RRP in £*	Order no.
Special nozzles/brushes			
Crevice nozzle All variants: plastic			
	D 36 FD-300 for D 27/D 36, diameter 36 mm, length 300 mm	7.50 9.00	452904
	D 36 FD-210 for D 27/D 36, diameter 36 mm, length 210 mm	6.30 7.56	492391
	D 36 FD-150 for CTL SYS, for D 27/D 36, suitable for the accessory storage of the CTL SYS and CT 15, diameter 36 mm, length 150 mm	6.30 7.56	500593
	D 50 FD for D 50, length 200 mm	19.70 23.64	452912
Suction brush All variants: Plastic			
	D 36 SP for D 27/D 36, diameter 70 mm	10.50 12.60	440404
	D 50 SP for D 50, diameter 85 mm	27.90 33.48	440419
	Upholstery nozzle D 36 PD for D 27/D 36, for CTL SYS, plastic, with brush insert, fits in the accessory storage of the CTL SYS, width 120 mm	8.10 9.72	500592
	Universal brush nozzle D 36 UBD for D 27/D 36, plastic, with brush rim and rotary hinge	14.90 17.88	498527



* Manufacturer's recommended retail price. Dealer prices may vary.
Excl. VAT. | Incl. VAT.

06 Dust extraction

Accessories for CT mobile dust extractors		RRP in £*	Order no.
Modules for attachment system CTL/CTM 26/36/48			
Electrical outlet module All variants: for CT 26/36/48			
	Modul-SD CT 26/36/48 electrical outlet with continuous power	not available in Great Britain	496142
	Modul-SD E/A CT 26/36/48 electrical outlet with automatic On and Off switch	not available in Great Britain	496405
	Energy box module EAA CT 26/36/48 for CT 26/36/48, for connecting a CT mobile dust extractor with an energy box or boom arm	60.40 72.48	496143
	Compressed air module DL CT 26/36/48 for CT 26/36/48, for upgrading E model mobile dust extractors, with additional compressed air automatic On and Off switching mechanism	204.00 244.80	496141
Remote control All variants: the remote control makes it possible to switch on the mobile dust extractor directly from the suction hose (simple changeover to cleaning mode, even when the mobile dust extractor is in AUTO mode), range 10 m, technology Bluetooth®			
	CT-F I/M-Set for CT 26, 36, 48 (except for EC and EC B22), retrofit set for CT 26, 36, 48, Module for installation in the free module slot, Remote operation via remote control (included in the set) or via cordless tool (in combination with Bluetooth® battery pack), enables the mobile dust extractor to be started automatically when the cordless tool is switched on (compatible Bluetooth® battery pack required), reception module (for CT 26, 36, 48)	81.00 97.20	202097
	CT-F I suitable for all dust extractors with Bluetooth® (in combination with Bluetooth® reception module), two fastening straps for D27 and D36 suction hoses	43.00 51.60	202098
		RRP in £*	Order no.
CT boom arm			
Boom arm All variants: pipe set with connections, length 2.119 mm, width 1.136 mm			
	CT-ASA for CT 44, CT 48, without handle	not available in Great Britain	492452
	CT-ASA CT 26/36/SB for CT 26/36, with the SB-CT 26/36 handle, boom arm for mounting to all CT 26/36 models (except CT 26/36 AC HD), handle	not available in Great Britain	496372
	Tool holder WHR/CT-ASA for CT-ASA, CT-ASA/SB, for safe, ergonomic storage of two electric power or pneumatic tools	55.60 66.72	493558
		RRP in £*	Order no.
CLEANTEC filter			
	Filter element HF-CT 17 for CT 17 E, VCP 170 E, VCP 320 E, for dry extraction	28.30 33.96	769134
Main filter			
	HF-CT MINI/MIDI-2/CT15 for CT MINI, CT MINI I, CT MIDI and CT MIDI I manufactured from 2019 onwards, CTC MINI/MIDI and CT 15, main filter surrounded by practical plastic frame, easy replacement of filter cartridge from outside without opening the mobile dust extractor	17.80 21.36	204200
	HF-CT-MINI/MIDI for CT MINI and CT MIDI manufactured until 2018	19.60 23.52	456790
	HF-CT 26/36/48 For CT 26/36/48 and TURBO II, High-performance main filter, not suitable for mobile dust extractors with AUTOCLEAN function	31.80 38.16	496170

Accessories for CT mobile dust extractors		RRP in £*	Order no.
CLEANTEC filter			
Main filter			
	HF-CT 26/36/48 HP for CT AC, VCP 260 AC, 360 AC, 480 AC, main filter optimised for cleaning with PTFE coating	50.10 60.12	203759
	HF CTH 26/48 for CTH 26, CTH 48, special filter complies with the requirements of dust class H, dust class H	68.20 81.84	498995
	HF-CT/2 for CT 11, 22, 33, 44, 55, qty. in pack 2 Units	31.80 38.16	452923
	HF-CT SYS for CT SYS and CTC SYS	16.90 20.28	500558
	Long-life main filter Longlife-HF-CT/2 for CT 11, 22, 33, 44, 55, used only for extraction of dust types which are not hazardous to health, qty. in pack 2 Units	68.30 81.96	454869
Wet filter			
All variants: for wet extraction			
	NF-CT MINI/MIDI-2/CT15 for CT MINI, CT MINI I, CT MIDI and CT MIDI I manufactured from 2019 onwards, CTC MINI/MIDI and CT 15, wet filter surrounded by practical plastic frame, easy replacement of filter cartridge from outside without opening the mobile dust extractor	17.80 21.36	204202
	NF-CT MINI/MIDI for CT MINI and CT MIDI manufactured until 2018	11.00 13.20	456805
	NF-CT 26/36/48 for CT 26/36/48	15.00 18.00	496169
	NF-CT 17 for CT 17 E, VCP 170 E, VCP 320 E, VCP 171 E-L, VCP 321 E-L	20.80 24.96	769135
		RRP in £*	Order no.
CLEANTEC filter bags			
	Filter bag FIS-CT 17/5 for CT 17 E, VCP 170 E, VCP 171 E-L, double wall, qty. in pack 5 Units	27.50 33.00	769136
SELCLEAN filter bag			
All variants: qty. in pack 5 Units			
	SC FIS-CT SYS/5 for CT SYS and CTC SYS, optimum usage of the filter bag volume, with highly tear resistant filter fleece, SELFCLEAN filter bag made of cloth	14.90 17.88	500438
	SC-FIS-CT MINI/MIDI-2/5/CT15 for CT MINI, CT MINI I, CT MIDI and CT MIDI I manufactured from 2019 onwards, CTC MINI/MIDI and CT 15, optimum utilisation of filter bag volume thanks to SELFCLEAN filter material, optimised for cleaning, FSC™-certified, max. filling volume 15 l	17.30 20.76	204308
	SC FIS-CT MINI/5 for CTL MINI manufactured until 2018, optimum utilisation of filter bag capacity and consistently high suction power thanks to SELFCLEAN filter bag, FSC™-certified	17.10 20.52	498410
	SC FIS-CT MIDI/5 for CTL MIDI manufactured until 2018, optimum utilisation of filter bag capacity and consistently high suction power thanks to SELFCLEAN filter bag, FSC™-certified	25.00 30.00	498411

06 Dust extraction

Accessories for CT mobile dust extractors		RRP in £*	Order no.
CLEANTEC filter bags			
SELFCLEAN filter bag All variants: optimum utilisation of filter bag capacity and consistently high suction power thanks to SELFCLEAN filter bag, qty. in pack 5 Units			
	SC FIS-CT 26/5 for CT 26	38.10 45.72	496187
	SC FIS-CT 36/5 for CT 36	41.70 50.04	496186
	SC FIS-CT 48/5 for CT 48	45.10 54.12	497539
Disposable bag All variants: not suitable for CT standard version (without AC), qty. in pack 5 Units			
	ENS-CT 26 AC/5 for CT 26 AC	33.30 39.96	496216
	ENS-CT 36 AC/5 for CT 36 AC/CTL 36 E AC HD	36.20 43.44	496215
	ENS-CT 48 AC/5 for CT/CTL/CTM 48 AC	39.00 46.80	497540
Safety filter bag All variants: double-layered, qty. in pack 3 Units			
	FIS-CTH 26/3 for CTH 26	54.20 65.04	497541
	FIS-CTH 48/3 for CTH 48	60.90 73.08	497542







Our raw materials. From FSC™-certified sources.







The mark of
responsible forestry

The filter bags in the Festool range originate from sustainable forest management and other controlled sources. They bear the Forest Stewardship Council™ (FSC™) quality seal, which means that all stages along the supply chain are FSC-certified. Look for products that are FSC-certified.

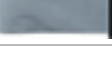

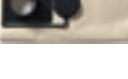
You can find more FSC-certified products on page 247

Accessories for CT mobile dust extractors		RRP in £*	Order no.
CLEANTEC filter bags			
Longlife filter bag All variants: used only for extraction of dust types which are not hazardous to health, from high strength, 3-layer polyester fleece with a long service life, Not recommended for fine dust			
	Longlife-FIS-CT SYS for CT SYS and CTC SYS, multiple filter bag for disposal of dust	57.60 69.12	500642
	LL-FIS-CT MINI/MIDI-2/CT15 for CT MINI, CT MINI I, CT MIDI and CT MIDI I manufactured from 2019 onwards, CTC MINI/MIDI and CT 15, max. filling volume 15 l	121.10 145.32	204309
	Longlife-FIS-CTL MINI for CT MINI manufactured until 2018	74.00 88.80	499703
	Longlife-FIS-CTL MIDI for CT MIDI manufactured until 2018	106.00 127.20	499704
	Longlife-FIS-CT 26 for CT 26	146.80 176.16	496120
	Longlife-FIS-CT 36 for CT 36	154.60 185.52	496121
	Longlife-FIS-CT 48 for CT 48	162.20 194.64	498506

Accessories for CT mobile dust extractors		RRP in £*	Order no.
CLEANTEC filter bags			
Longlife filter bag All variants: used only for extraction of dust types which are not hazardous to health, from high strength, 3-layer polyester fleece with a long service life, Not recommended for fine dust			
	Longlife-FIS-CT 22 for CT 22	146.80 176.16	456737
	Longlife-FIS-CT 33 for CT 33	154.60 185.52	456738
Filter bag			
	FIS-CT 22/5 for CT 22, qty. in pack 5 Units	38.10 45.72	452970
	FIS-CT 22/20 for CT 22, qty. in pack 20 Units	135.90 163.08	494631
	FIS-CT 33/5 for CT 33, qty. in pack 5 Units	41.70 50.04	452971
	FIS-CT 33/20 for CT 33, qty. in pack 20 Units	148.60 178.32	494632
	FIS-CT 44/5 for CT 44, qty. in pack 5 Units	45.10 54.12	452972
	FIS-CT 55/5 for CT 55, qty. in pack 5 Units	48.60 58.32	452973

		RRP in £*	Order no.
SR filter			
	Main filter NANO HF-SRM 45-LHS 225 for SRM 45 E-PLANEX, VCP 450 E-L, VCP 450 E-M, Nano	53.80 64.56	496406

06 Dust extraction

Accessories for SR dust extractors		RRP in £*	Order no.
SR filter bags			
Filter bag All variants: qty. in pack 5 Units			
	FIS-SRM 45 /5 for SRM 45 LE-EC	45.00 54.00	493775
	FIS-SRM 45-LHS 225 /5 for SRM 45 E-PLANEX, VCP 450 E-L, VCP 450 E-M	36.90 44.28	495014

		RRP in £*	Order no.
SR filters and filter bags for discontinued models			
Two-ply filter bag All variants: qty. in pack 5 Units			
	FIS-SR 5/6 /5 for SR 5, SR 6, double-layered	42.30 50.76	483143
	FIS-SR 12/14 /5 for SR 12, SR 14	53.50 64.20	483142
	FIS-SR 150 /5 for SR 151, SRM 152	42.30 50.76	488460
	FIS-SR 200 /5 for SR 200, SR 201, SR 203	46.00 55.20	487070
	FIS-SR 300 /5 for SR 301, SR 303, SRM 312	59.70 71.64	487790
	FIS-SR 202 /5 for SR 202, SR 212, SRH 204, SR 200, SR 201, SR 203	78.80 94.56	487482

Accessories for mobile dust extractors CT and dust extractors SR		RRP in £*	Order no.
CT accessories			
	Hose holder CT-SG for CT 11, 22, 33, 44, 55, for storing the suction hose and mains cable, suitable hose sizes: plug it hose D 22 x 3.5 m / D 27 x 3.5 m / D 27 x 5 m / D 36 x 3.5 m / D 50 x 2.5 m / IAS 2-3500 AS, not suitable for CT 26/36/48, dimensions [L x W x H] 530 x 360 x 110 mm	44.80 53.76	494388

Comfortable grip. The handle for the CT MINI/MIDI.

The handle facilitates transportation of the CT MINI and CT MIDI mobile dust extractors and can be lowered when not in use. The practical holder on the handle provides space-saving storage options for the cleaning accessories while keeping them close at hand whenever they are needed.

You can find more information on page 183



Accessories for mobile dust extractors CT and dust extractors SR		RRP in £*	Order no.
CT accessories			
Tool holder			
	WHR-CT for CT 26/36, galvanised steel tool holder for sanders, for stable and ergonomic placement of an electrical or compressed air power tool	47.20 56.64	496122
	WHR-CT LHS 2 for CT 36 PLANEX, with practical carrier handle, storage space for abrasives, interface pads and other small parts, easy to attach to Festool extractors with T-LOC or SYS-dock, fits all PLANEX long-reach sanders	29.90 35.88	205274
Handle			
	SB-CT 26/36 for CT 26/36, for the convenient transportation of mobile dust extractors, with nozzle holder	71.30 85.56	495802
	SB-CT 48 for CT 48, for the convenient transportation of mobile dust extractors, with nozzle holder	126.50 151.80	497295
	SB-CT MINI/MIDI-2/CT15 for CT MINI, CT MINI I, CT MIDI and CT MIDI I manufactured from 2019 onwards as well as CT 15, not compatible with CTC MINI/MIDI, handle can be lowered when not in use, made of steel and aluminium pipes, with practical holder for storing cleaning accessories (hand tube, three extension pipes and floor nozzle) and parked position for plug-in suction hose with floor nozzle, cable holder	79.20 95.04	204310
	Storage box AB-CTC MINI/MIDI for CTC MINI and CTC MIDI, for storing battery packs and cleaning accessories	24.30 29.16	577213
	Sealing slide VS-CT AC/SRM45 PLANEX for CT AC / CT 36 AC PLANEX, ensures extreme vacuum in container, the filter undergoes thorough cleaning	46.30 55.56	497926
	Adapter AD-WCR adapter for attaching the WCR and/or service unit VE CT 26/36/48 for CT 48 EC and CT 48 EC B22	58.60 70.32	498805
	Sys-Adapter SYS-AP-CT 36 HD for CT 36 E HD-AC, CT 26 HD, VCP 260 E-L AC, VCP 260 E-M AC, VCP 260 E-H, from YOM 2011, for VCP 360 E-L AC, VCP 360 E-M AC, VCP 480 E-L AC, VCP 480 E-M AC, for connecting Systainer to extractor	not available in Great Britain	768115
	Vacuum clamping nozzle CT-W for CT mobile dust extractors and D 27 suction hose, flexible aid for temporary clamping and fixing of workpieces at horizontal and vertical areas, max. clamping height 50 mm, max. load 3 kg, dimensions (L x W x H) 130 x 80 x 50 mm, weight 0,35 kg	35.20 42.24	500312
	Shoulder strap SYS-TG for CT SYS, CTC SYS and all SYSTAINERS T-LOC, easy transport of the CTL SYS and the Systainer T-LOC, max. load 20 kg	18.00 21.60	500532
CT compressed air accessories			
	Service unit VE-CT 26/36/48 for LE version of CT 26/36/48, pressure controller, condensate quick discharge, oiler and oil-free compressed air outlet with quick coupling	421.90 506.28	495886

07 Drilling and screwdriving





186 CXS, TXS
cordless drills



187 T 18+3, C 18
cordless drill



194 TID 18
cordless impact driver



196 Cordless hammer drill
BHC 18



198 Cordless drywall screwdriver
DURADRIVE



188 QUADRIVE
cordless percussion drill

NEW

When it comes to performance, size really isn't that important.

The extra-small cordless drill.

The compact cordless drill XS generates large amounts of torque and packs amazing power, even in awkward spots. With an extremely compact design and balanced weight distribution, it makes it possible to quickly perform work above head height or at an angle. The XS class is a versatile aid for demanding applications, whatever the circumstances.



Cordless drill **CXS**

In the ergonomic C model.



Cordless drill **TXS**

In the classic T model.



Everything is close to hand in an instant

Keep your hands free at the right moment by conveniently attaching the machine to your belt: The belt clip is suitable for right- and left-handers, without the need for tools.

Amazingly powerful

The CXS can overcome any challenge with 10.8 V Lithium-ion battery packs. 12 available torque settings for controlled power.



For quick changes between drilling and screwdriving.

The cordless drills from the C and T 18 class.

For full flexibility when drilling and screwdriving: Fully electronic torque adjustment, CENTROTEC quick-change system, angle attachment, eccentric adapter and depth stop can handle every drilling and screwdriving application. The combination of Li-HighPower battery pack and brushless, therefore maintenance-free, EC-TEC motor makes the C 18 and T 18+3 cordless drills light, powerful and durable.



Brushless
EC-TEC motor



Cordless drill C 18

Power and endurance
in the ergonomic C model.

Cordless drill T 18+3

Power and endurance
in the classic T model.



Brushless
EC-TEC motor



Top performance

Festool has combined EC-TEC motor technology with intelligent motor management and thereby developed it further. The brushless EC-TEC motor is wear-free and converts the energy from the battery into power with virtually no loss. This means that the efficiency of C and T screwdrivers is enormous for their performance class. The electronic motor management also guarantees a longer service life: Microprocessors monitor and control the temperature, voltage and current consumption of the motor, electronics and battery.

In the smallest of spaces

The angle attachment is perfect for work around corners and reaching concealed screws at tight angles.



Pure power, controlled in four gears.

The QUADRIVE cordless drills – with and without impact feature.

Powerful. Versatile. With four gears for every application. With the best switching concept you have ever operated. Whether you are working on wood or metal: the two QUADRIVE drills are extremely tough and have considerable resilience and endurance thanks to their brushless EC-TEC motor. A large number of attachments, combined with perfectly matched accessories, offer a wide range of possible uses.

Cordless drill QUADRIVE TDC 18/4

For intensive torque work with screws and drills with larger diameters...



NEW



Brushless EC-TEC motor



NEW



Brushless EC-TEC motor



Cordless percussion drill QUADRIVE TPC 18/4

... with axial impact feature which can be activated for drilling into masonry and brickwork up to 10 mm.



Optimised gear switching

Fast, safe, direct! Switching in any direction – from any gear straight to any other, without intermediate stages. Fixed stops ensure clear engaging. Fast downshifting possible as required.

Increased power in 2nd gear

40% more torque compared to the previous model for full traction with 8 mm screws.



IoT via Work App

When operated with a Bluetooth® battery, software updates, repair orders for servicing and many other functions can be used: The right-hand/left-hand selector switch can be reversed for left-handed people and the brightness and lighting duration of the LED light can be set via the Work app.



For more details about our IOT-compatible tools see page 6

Ready. For the unbeatable double

Pure screwdriving power in four gears and the masterpiece among our saws – the two new incredible cordless tools from Festool make everyday work easy.

For more details about the TSC 55 K see page 48



Goodbye to dangerous kickbacks.

Festool has added intelligent KickbackStop technology to the new QUADRIVE and the new generation of TSC 55 K cordless plunge-cut saws. A sensor detects a tool jam in the blink of an eye and stops the motor within a fraction of a second. The risk of injury is reduced to a minimum.



07 Drilling and screwdriving



Technical data	CXS	TXS	C 18	T 18+3	TDC 18/4	TPC 18/4
Battery voltage (V)	10,8	10,8	18	18	18	18
Gears	2	2	2	2	4	4
Idling speed, 1st gear/2nd gear (RPM)	0 – 430/0 – 1.300	0 – 430/0 – 1.300	0 – 450/0 – 1.500	0 – 450/0 – 1.500	0 – 500/0 – 800	0 – 500/0 – 800
Idling speed, 3rd/4th gear (RPM)	–	–	–	–	0 – 2.350/0 – 3.600	0 – 2.350/0 – 3.600
Max. number of strokes (RPM)	–	–	–	–	–	57.600
Drilling diameter, wood/steel (mm)	12/8	12/8	40/13	45/13	70/13	70/13
Drilling diameter in brickwork (mm)	–	–	–	–	–	10
Torque adjustment 1st/2nd gear (Nm)	0,3 – 3,4	0,3 – 3,4	0,8 – 8/0,5 – 6	0,8 – 8/0,5 – 6	2 – 20/2 – 20	2 – 20/2 – 20
Max. torque, wood/steel (Nm)	10/16	10/16	27/45	35/50	50/75	50/75
Chuck range (mm)	1 – 10	1 – 10	1,5 – 13	1,5 – 13	1,5 – 13	1,5 – 13
Battery capacity (Ah)	2,6	2,6	4	4	4/5,2	4/5,2
Weight with battery (kg)	0,9	0,9	1,7	1,7	1,9/2	1,9/2





Screwdriving in wood, max. diameter

3 × 15	●	●	○	–	–	–
4 × 35	●	●	●	○	○	○
5 × 40	●	●	●	●	●	●
6 × 80	○	○	●	●	●	●
6 × 120	–	–	●	●	●	●
8 × 220	–	–	○	●	●	●
8 × 300	–	–	–	○	●	●
10 × 300	–	–	–	–	○	○

Drilling in wood, max. diameter

3	●	●	○	○	○	○
15	○	○	●	●	●	●
35	–	–	●	●	●	●
45	–	–	○	●	●	●
50	–	–	–	–	●	●
70	–	–	–	–	○	○

Extremely appropriate ●
Appropriate ○

Items included	RRP in £*	Order no.
CXS		
 CXS 2,6-Set 240V 2 x battery pack BP-XS, charger MXC, CENTROTEC tool chuck, CENTROTEC BH 60 CE Imp magnetic bit holder, FastFix keyless chuck 10 mm, XS elbow adapter, bit PZ 2, belt clip, Systainer SYS3 M 137	268.00 321.60	576094
TXS		
 TXS 2,6-Set 240V 2 x battery pack BP-XS, charger MXC, CENTROTEC tool chuck, CENTROTEC BH 60 CE Imp magnetic bit holder, FastFix keyless chuck 10 mm, XS elbow adapter, bit PZ 2, belt clip, Systainer SYS3 M 137	268.00 321.60	576103
C 18	All variants: CENTROTEC tool chuck, CENTROTEC BH 60 CE Imp magnetic bit holder, FastFix keyless chuck 13 mm KC 13-1/2-K-FFP, bit PZ 2, belt clip, Systainer SYS3 M 187	
 C 18-Basic without battery pack, without charger	221.00 265.20	576434
C 18 HPC 4,0 I-Plus 2 x BP 18 Li 4.0 HPC-ASI battery pack, rapid charger TCL 6	453.00 543.60	576436
C 18 HPC 4,0 I-Set 2 x BP 18 Li 4.0 HPC-ASI battery pack, rapid charger TCL 6, FastFix angle attachment, FastFix eccentric attachment	553.00 663.60	576993
T 18+3	All variants: CENTROTEC tool chuck, CENTROTEC BH 60 CE Imp magnetic bit holder, FastFix keyless chuck 13 mm KC 13-1/2-K-FFP, bit PZ 2, belt clip, Systainer SYS3 M 187	
 T 18+3-Basic without battery pack, without charger	221.00 265.20	576448
T 18+3 HPC 4,0 I-Plus 2 x BP 18 Li 4.0 HPC-ASI battery pack, rapid charger TCL 6	453.00 543.60	576447
T 18+3 HPC 4,0 I-Set 2 x BP 18 Li 4.0 HPC-ASI battery pack, rapid charger TCL 6, FastFix angle attachment, FastFix eccentric attachment	553.00 663.60	576990
TDC 18/4	All variants: CENTROTEC tool chuck, CENTROTEC BH 60 CE Imp magnetic bit holder, FastFix keyless chuck 13 mm KC 13-1/2-MMFP, bit PZ 2, additional side-mounted hand grip, belt clip, Systainer SYS3 M 187	
 TDC 18/4 I-Basic without battery pack, without charger	265.00 318.00	575601
TDC 18/4 5,2/4,0 I-Plus BP 18 Li 4.0 HPC-ASI battery pack, BP 18 Li 5.2 ASI battery pack, rapid charger TCL 6	497.00 596.40	576767
TPC 18/4	All variants: CENTROTEC tool chuck, CENTROTEC BH 60 CE Imp magnetic bit holder, FastFix keyless chuck 13 mm KC 13-1/2-MMFP, bit PZ 2, additional side-mounted hand grip, belt clip, Systainer SYS3 M 187	
 TPC 18/4 I-Basic without battery pack, without charger	274.00 328.80	575604
TPC 18/4 5,2/4,0 I-Plus BP 18 Li 4.0 HPC-ASI battery pack, BP 18 Li 5.2 ASI battery pack, rapid charger TCL 6	506.00 607.20	576773
TPC 18/4 5,2/4,0 I-Plus-SCA BP 18 Li 4.0 HPC-ASI battery pack, BP 18 Li 5.2 ASI battery pack, SCA 8 rapid charger	535.00 642.00	576774
TPC 18/4 5,2/4,0 I-Set BP 18 Li 4.0 HPC-ASI battery pack, BP 18 Li 5.2 ASI battery pack, rapid charger TCL 6, FastFix angle attachment	615.00 738.00	577249
TPC 18/4 5,2/4,0 I-Set/XL BP 18 Li 4.0 HPC-ASI battery pack, BP 18 Li 5.2 ASI battery pack, rapid charger TCL 6, FastFix angle attachment, FastFix depth stop DC UNI FF	655.00 786.00	577250

07 Drilling and screwdriving

Accessories		RRP in £*	Order no.
	Tool chuck WH-CE CENTROTEC for all Festool cordless and mains-operated drills (except DR 20/DRP 20) with CENTROTEC interface	22.10 26.52	492135
	Keyless chuck BF-FX 10 for Festool cordless drills CXS and TXS, holder FastFix, clamping range 1 – 10 mm	51.40 61.68	499949
	Keyless chuck KC 13-1/2-K-FFP for all Festool cordless drills, cordless percussion drills, drills (except DR 20/DRP 20) and percussion drills with CENTROTEC interface, impact resistant, plastic ring, with locking device, holder FastFix, clamping range 1,5 – 13 mm	54.00 64.80	769067
	Keyless chuck KC 13-1/2-MMFP for all Festool cordless drills, cordless percussion drills, drills (except DR 20/DRP 20) and percussion drills with CENTROTEC interface, impact-resistant, metal ring, with additional locking device, holder FastFix, clamping range 1,5 – 13 mm	61.70 74.04	577072
	Angle attachment AN-UNI for TPC 18/4, TDC 18/4 and all Festool C and T cordless drills with FastFix fixture (except CXS/TXS), quick angle adjustment simply by rotating the green ring – the attachment no longer needs to be released from the machine, holder FastFix, max. screw size for softwood 10 x 300 mm	117.70 141.24	205222
	Eccentric attachment EX-UNI for TPC 18/4, TDC 18/4 and all Festool C and T cordless drills with FastFix fixture (except CXS/TXS), quick angle adjustment simply by rotating the green ring – the attachment no longer needs to be released from the machine, max. screw size for softwood 6 x 100 mm	99.60 119.52	205223
	Adapter AD-3/8" FF for all Festool cordless drills, cordless percussion drills, drills (except DR 20/DRP 20) and percussion drills with CENTROTEC interface, for holding socket wrenches with 3/8" square i.a.w. DIN 3121 (machine-operated assembly tools), holder FastFix	54.90 65.88	769064
	Depth stop DD-DC for TPC 18/4, TDC 18/4 and all Festool C and T cordless drills with FastFix fixture (except CXS/TXS), max. screw size for softwood 6 x 100 mm	98.60 118.32	493539
	Depth stop DC UNI FF for all Festool cordless drills, cordless percussion drills, drills (except DR 20/DRP 20) and percussion drills with CENTROTEC interface, stop sleeves Ø 17 mm + 23 mm, PH 2 bit, socket wrench, size 8, max. screw size for softwood 6 x 100 mm, holder FastFix	105.00 126.00	769126
	Guard ring PR D17-DC UNI FF 5x for DC UNI FF, 5 protective rings for stop sleeves Ø 17 mm, qty. in pack 5 Units, D 17 mm	3.90 4.68	768125
	Guard ring PR D23-DC UNI FF 5x for DC UNI FF, 5 protective rings for stop sleeve Ø 23 mm, qty. in pack 5 Units, D 23 mm	3.90 4.68	768127
	Socket spanner SW 3/8"-DC UNI FF 2x for depth stop DC UNI FF, 2 socket wrenches SW 3/8" with ball clamping effect, spanner width across flats 3/8", qty. in pack 2 Units	13.50 16.20	768165
	Socket spanner SW 8-DC UNI FF 2x for depth stop DC UNI FF, 2 socket wrenches SW 8 with ball clamping effect, spanner width across flats 8 mm, qty. in pack 2 Units	13.50 16.20	768113
	Auxiliary handle AHS-43/230 for QUADRIVE TPC 18/4 and TDC 18/4, for absorbing higher torques, with additional protection against accidental unscrewing, holder dia. 43 mm, length 230 mm	12.50 15.00	577073
	Auxiliary handle AH-43/230 for all QUADRILL DR 18/4 and PD 20/4, for absorbing higher torques, holder dia. 43 mm, length 230 mm	12.50 15.00	768613
	Auxiliary handle AH-43/185 for all QUADRIVE DRC 18/4, PDC 18/4 and BHC 18, for absorbing higher torques, holder dia. 43 mm, length 185 mm	10.00 12.00	768615
	Angle attachment XS-AS for CXS and TXS cordless drills, for working in tight spaces, max. screw size for softwood 5 x 40 mm	68.00 81.60	497951
	Battery and charging technology from page 28		

Faster processes with the CENTROTEC quick-change system and the FastFix attachments – all without the need for additional equipment.

NEW

AN-UNI angle attachment

Simply twist the green ring to adjust the angle in no time at all. The attachment no longer needs to be released from the machine.

Depth stop DD-DC

For depth-limited screwdriving, for example drywall screwdriving. Enables unscrewing without removing the attachment. Narrow attachment with good view of the screw position.

NEW

EX-UNI eccentric attachment

Simply twist the green ring to adjust the angle in no time at all. Ideal for screwdriving close to edges.



Keyless chuck KC 13-1/2-MMFP

For tool reception of cylindrical shafts. Optimised locking device to protect against unintentional opening at high speeds.

AD-3/8" FF adapter

For the reception of 3/8" socket spanners.

Depth stop DC UNI FF

Impression-free work thanks to the rubberised guard ring, for screw fittings on façades or terraces, for example, with repeat accuracy.

CENTROTEC tool chuck

Drill chuck and bit holder in one: 50% smaller and 80% lighter than a standard drill chuck! Enables users to change tools in a matter of seconds and fits all Festool cordless drills with a FastFix interface.

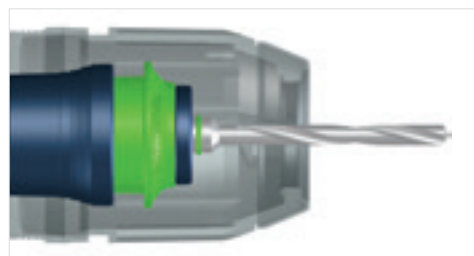

A tool that will stand the test of time.

The cordless impact screwdriver.

Offers an impressive service life thanks to its extremely robust hammer mechanism. Moreover, the turning screw will take the full force of the TID 18 with its 1/4" tool holder – with no strain at all on your wrist: This is thanks to the tangential hammer mechanism with no strength-sapping back torque. The machine weight of just 960 grams also allows you to work for longer without becoming tired.



Cordless impact driver TID 18

With its highly powerful new generation brushless EC-TEC motor and exceptionally robust hammer mechanism, the TID 18 is ready for unlimited, long lasting use.



Brushless
EC-TEC motor

Technical data	TID 18
Battery voltage (V)	18
Gears	3 + T-Modus
Idle engine speed, 1st/2nd/3rd gear (RPM)	0 – 1.200/ 0 – 2.000/0 – 3.200
Max. number of strokes (RPM)	4.500
Max. torque (Nm)	180
Max. screw size for softwood (mm)	8 x 220
Tool holder	1/4"
Battery capacity (Ah)	4
Weight with battery (kg)	1,5



Intelligent power.





The TID 18 cordless impact screwdriver offers extremely strong performance and ensures that work is tailored to the material with three speed settings. The clever T-mode detects the transition between sheet metal and wood and automatically adapts the speed.



Ergonomic

The compact design enables you to work accurately and for longer without becoming tired, even in hard-to-reach areas.

Items included		RRP in £*	Order no.
TID 18	All variants: belt clip		
	TID 18-Basic without battery pack, without charger, Systainer SYS3 M 187	261.00 313.20	576481
	TID 18 HPC 4,0 I-Plus 2 x BP 18 Li 4.0 HPC-ASI battery pack, rapid charger TCL 6, Systainer SYS3 M 187	495.00 594.00	576484
	TID 18 5,2/4,0-Set TPC 18/4 TID 18 cordless impact driver, TPC 18/4 cordless percussion drill, BP 18 Li 4.0 HPC-ASI battery pack, BP 18 Li 5.2 ASI battery pack, rapid charger TCL 6, FastFix keyless chuck 13 mm KC 13-1/2-MMFP, FastFix angle attachment, additional side-mounted hand grip, Systainer SYS3 M 237	774.00 928.80	576997
	TID 18 HPC 4,0 I-Set T18 TID 18 cordless impact driver, T18+3 cordless drills, 2 x BP 18 Li 4.0 HPC-ASI battery pack, rapid charger TCL 6, FastFix keyless chuck 13 mm KC 13-1/2-K-FFP, Systainer SYS3 M 237	679.00 814.80	577245

Accessories		RRP in £*	Order no.
	Bit cassette BT-IMP SORT1 for TID 18 cordless impact screwdriver, extra-impact-resistant bit assortment, 6-pc., in the BitBOX, bit holder BH 52, bit PZ 2, TX 20 bit, TX 25 bit, TX 30 bit, TX 40 bit, length 25 mm	23.90 28.68	204381
	Bit cassette BT-IMP SORT3 for TID 18 cordless impact screwdriver, extra-impact-resistant bit assortment, 6-pc., in the BitBOX, BHS 50 lockable magnetic bit holder, bit PZ 2, TX 20 bit, TX 25 bit, TX 30 bit, TX 40 bit, length 25 mm	36.70 44.04	204383
	Bit cassette BT-IMP SORT5 for TID 18 cordless impact screwdriver, extra-impact-resistant bit assortment, 6-pc., in bit check, with 1/4" hexagonal drive, bit PZ 2, PH 2 bit, TX 20 bit, TX 25 bit, TX 30 bit, TX 40 bit, length 50 mm	38.50 46.20	204385
	Socket spanner STSL-IMP 1/4"-Set for TID 18 cordless impact screwdriver, 3-piece, ideally suited for screwing in and unscrewing hexagon screws, socket spanner with 1/4" hexagonal holder with the following widths across flats: 1/4", 5/16" and 3/8", length 50 mm, qty. in pack 3 Units	39.40 47.28	204388

* Manufacturer's recommended retail price. Dealer prices may vary.
Excl. VAT. | Incl. VAT.

The most powerful compact hammer drill

The BHC cordless hammer drill.

Ergonomically C-shaped and balanced weight distribution to guarantee effortless work. The combination of brushless EC-TEC drive and integrated motor management produces an extraordinarily high impact energy that can penetrate any concrete quickly and powerfully. The vibration damping absorbs impact energy before it is transferred to your hand.



Cordless hammer drill BHC 18

Drilling holes with pneumatic impact action for dowels up to 18 mm in concrete, stone and masonry. Weighing only 2.5 kg and with excellent balance, it is ideally suited for continuous use for interior finishing and assembly.



Brushless
EC-TEC motor

Technical data	BHC 18
Battery voltage (V)	18
Gears	1
Idle engine speed (RPM)	0 – 1.100
Max. number of strokes (RPM)	4.895
Drilling dia. (concrete) (mm)	18
Max. crown borer hole diameter (mm)	68
Max. torque, wood/steel (Nm)	10/25
Tool holder	SDS-Plus
Single impact energy (J)	1,8
Battery capacity (Ah)	4
Weight with battery (kg)	2,5



Working with extraction

Dust-free, residue-free drilling with a secure hold: Thanks to the drill dust nozzle and the patented dual-chamber system, drilling holes up to a maximum diameter of 12 mm in floors, walls and ceilings is effortless. A flexible joint piece ensures the optimum hose position and the foam rubber pad provides a secure hold even on uneven surfaces.









Impact can be disabled

E.g. for drilling tiles.

Simply communicative

The Li-HighPower Compact Bluetooth® battery pack communicates with the Bluetooth® module on the CLEANTEC mobile dust extractor** and starts it automatically when the tool is switched on. In this way, you also benefit from the complete Festool dust-free system when working with the hammer drill in combination with the drill dust nozzle.

Items included		RRP in £*	Order no.
BHC	All variants: additional side-mounted hand grip, depth stop, Systainer SYS3 M 187		
	BHC 18-Basic without battery pack, without charger	288.00 345.60	576511
	BHC 18 HPC 4,0 I-Plus 2 x BP 18 Li 4.0 HPC-ASI battery pack, rapid charger TCL 6	522.00 626.40	576514

Accessories		RRP in £*	Order no.
	Hammer drill SDS-Set D5-D12/7 for cordless hammer drills BHC 18 and all other hammer drills with SDS-Plus tool reception, hammer drill bit D 5 x 50 mm, 2 x hammer drill bit D 6 x 50 mm, hammer drill bit D 6 x 100 mm, hammer drill bit D 8 x 100 mm, hammer drill bit D10 x 100 mm, hammer drill bit D 12 x 100 mm, qty. in pack 7 Units	64.80 77.76	204070
	Adapter AD SDS-plus/FastFix for BHC 18, RHP 18, CHP 26, for holding a CENTROTEC tool chuck	16.20 19.44	769068
	Tool chuck WH-CE CENTROTEC for all Festool cordless and mains-operated drills (except DR 20/DRP 20) with CENTROTEC interface	22.10 26.52	492135
	Auxiliary handle AH-43/185 for all QUADRIVE DRC 18/4, PDC 18/4 and BHC 18, for absorbing higher torques, holder dia. 43 mm, length 185 mm	10.00 12.00	768615
	Drilling dust nozzle D 27-BSD for BHC 18, PDC 18, PD 20 and mobile dust extractors CT/CTL/CTM, adapter with flexible insert, drill sleeve made from nickel-plated steel, compatible with all standard industrial and domestic vacuum cleaners, exception: must be deactivated on extractors with automatic filter cleaning system, connection dia. 27 - 32 mm, drill bit dia. 0 - 12 mm	19.40 23.28	500483
	Battery and charging technology from page 28		

* Manufacturer's recommended retail price. Dealer prices may vary.
Excl. VAT. | Incl. VAT.
 ** can be retrofitted as an accessory on the CT 26/36/48, directly built into the CT MINI I and MIDI I.

Power and durability for interior work.

The DURADRIVE cordless drywall screwdriver.

Works at extremely high cycle speeds and sets a new rhythm for dry mortarless construction. One important factor in this is the innovative stop-and-go function, which ensures the motor is only working when it is needed. The result: An increase of up to 40% in the number of screws that are inserted per battery charge, improved comfort and higher speeds for driving in multiple sets of screws. For speed which can be further increased by the magazine attachment.

















Precision working

The depth stop can be attached without tools and adjusted in increments of 0.1 mm. This ensures that the screws are secure at consistent insertion depths. This eliminates the need for time-consuming reworking from the very beginning.

Lightweight















The compact version is even easier to handle: With the 400 g 3.1 Ah compact battery pack. Ideal for screw joints above head height.

























Items included	RRP in £*	Order no.
DWC 18-2500 All variants: magazine attachment, depth stop, scaffolding holder, magnetic bit holder, 2 x bit PH2, long, PH 2 bit, belt clip, Systainer SYS3 M 187		
 DWC 18-2500 Basic without battery pack, without charger	339.00 406.80	576497
DWC 18-2500 HPC 4,0 I-Plus 2 x BP 18 Li 4.0 HPC-ASI battery pack, rapid charger TCL 6	572.00 686.40	576499
DWC 18-4500 All variants: magazine attachment, depth stop, scaffolding holder, magnetic bit holder, 2 x bit PH2, long, PH 2 bit, belt clip, Systainer SYS3 M 187		
 DWC 18-4500 Basic without battery pack, without charger	339.00 406.80	576504
DWC 18-4500 HPC 4,0 I-Plus 2 x BP 18 Li 4.0 HPC-ASI battery pack, rapid charger TCL 6	572.00 686.40	576503

Accessories	RRP in £*	Order no.
 Magazine attachment AF 55-DWC for DWC, DWP, for taped screws, 25-55 mm, bit PH2, long	144.00 172.80	769146
 Bits PH 2-AF-55 3x AF 55-DWP/DWC, size PH 2, length 152 mm, qty. in pack 3 Units	16.20 19.44	769124
 Bits PZ 2-AF-55 3x AF 55-DWP/DWC, size PZ 2, length 152 mm, qty. in pack 3 Units	16.20 19.44	769078
 Bits TX 20-AF-55/3 AF 55-DWP/DWC, processing timber construction screws loaded in a magazine (TX 20) with a length of up to 55 mm, long bits for magazine attachment, ideal for DWC 18-2500, qty. in pack 3 Units, size TX 20, length 152 mm	16.20 19.44	201463
 Bit holder BH-DWC for DWC, DWP	8.60 10.32	769125
Drywall screws All variants: AF 55-DWP/DWC, qty. in pack 1.000 Units, diameter 3,9 mm		
 DWS C FT 3,9x25 1000x magazine-loaded, 1000 pc. fine thread, length 25 mm	29.80 35.76	769142
 DWS C FT 3,9x35 1000x magazine-loaded, 1000 pc. fine thread, length 35 mm	29.80 35.76	769143
 DWS C CT 3,9x35 1000x magazine-loaded, 1000 pc. coarse thread, length 35 mm	29.80 35.76	769144
 DWS C CT 3,9x45 1000x magazine-loaded, 1000 pc. coarse thread, length 45 mm	29.80 35.76	769145
 Battery and charging technology from page 28		

* Manufacturer's recommended retail price. Dealer prices may vary.
Excl. VAT. | Incl. VAT.











07 Drilling and screwdriving













Assembly package		RRP in £*	Order no.
	Assembly package SYS3 M 89 ORG CE-SORT for all Festool cordless drills with FastFix interface, D 3 CE/W spiral wood drill bits, D 4 CE/W spiral wood drill bits, D 5 CE/W spiral wood drill bits, D 6 CE/W spiral wood drill bits, D 8 CE/W spiral wood drill bits, D 10 CE/W spiral wood drill bits, CENTROTEC BH 60 CE Imp magnetic bit holder, extra-long CENTROTEC magnetic bit holder BV 150 CE, deburring countersink QLS D2-8 CE, deburring countersink QLS D5-15 CE, BTA HW D5 CE drill bit with depth stop, drill countersink with depth stop, BSTA HS D3.5 CE, centering bit ZB HS D5 EURO CE, hook driver HD D18 CE, twinBOX BB-MIX range of bits, drill bit case BKS D3-8 CE/W-K, 12 x 100 mm CENTROTEC bits PZ1/PZ2/PZ3/PH1/PH2/PH3/TX15/TX20/TX25/TX30/SZ 0.8 x 5.5/SZ 1.2 x 6.5, 60 x 25 mm bits, five units each: PZ1/PZ2/PZ3/PH1/PH2/PH3/TX10/TX15/TX20/TX25/TX30/TX40, CENTROTEC BHS 60 CE rapid-change bit holder, screwdriver SD-CE-DRIVE-UNI, CENTROTEC tool chuck, Systainer SYS3 ORG M 89	409.90 491.88	576804
Ratchet set, bit holders and adapters		RRP in £*	Order no.
	Ratchet set 1/4\"-CE RA-Set 36 1/4\" socket set from 4.0 to 13 mm, 19 different bit inserts and 2 bit extensions, ratchet and CENTROTEC handle plus various adapters and extensions, Systainer SYS MINI	128.60 154.32	497881
	Screwdriver SD-CE-DRIVE-UNI for CENTROTEC tools for drilling and screwdriving	23.20 27.84	200140
	Bit holder BHS 60 CE for all Festool cordless drills with FastFix interface, with CENTROTEC interface, magnetic CENTROTEC quick-change bit holder for supporting 25 mm standard bits, length 60 mm	29.80 35.76	205097
Bit holder All variants: for all Festool cordless drills with FastFix interface, with CENTROTEC interface			
	BH 60 CE Imp length 60 mm	11.40 13.68	498974
	BV 150 CE extra-long	22.50 27.00	492540
Adapter All variants: for all Festool cordless drills with FastFix interface, with CENTROTEC interface, for plug-in bits, with ball lock for manual operation			
	1/4\"-50 CE/KG CENTROTEC holder 1/4\", length 50 mm	22.30 26.76	495131
	3/8\"-70 CE/KG CENTROTEC holder 3/8\", length 70 mm	31.20 37.44	495133
25 mm bits		RRP in £*	Order no.
	Bit assortment BITS + BHS 60 CE TL 24x for SYS TL with lid compartment, 24-piece, 2 x PH 1 bit, 2 x PH 2 bit, 2 x PH 3 bit, 2 x PZ 1 bit, 2 x bit PZ 2, 2 x PZ 3 bit, 2 x TX 10 bit, 2 x TX 15 bit, 2 x TX 20 bit, 2 x TX 25 bit, 2 x TX 30 bit, 2 x TX 40 bit, CENTROTEC BHS 60 CE rapid-change bit holder	35.20 42.24	769094
Bit cassette All variants: 31-piece, CENTROTEC BH 60 CE Imp magnetic bit holder			
	TX 10-50/BH-SORT/31x 3 x TX 10 bit, 3 x TX 15 bit, 6 x TX 20 bit, 6 x TX 25 bit, 6 x TX 30 bit, 3 x TX 40 bit, 3 x TX 50 bit	30.60 36.72	769137
	BIT/BH-SORT/31x LS 4,5, LS 5,5, LS 6,5, HEX 4, HEX 5, HEX 6, 2 x TX 10 bit, 2 x TX 15 bit, 2 x TX 20 bit, 2 x TX 25 bit, 2 x TX 30 bit, 2 x TX 40 bit, 2 x PH 1 bit, 2 x PH 2 bit, 2 x PH 3 bit, 2 x PZ 1 bit, 2 x bit PZ 2, 2 x PZ 3 bit	30.60 36.72	769138
	TwinBOX BB-MIX content 10 pieces, PH 1 bit, PH 2 bit, PZ 1 bit, bit PZ 2, PZ 3 bit, SZ 0.8 x 5.5 bit, TX 15 bit, TX 20 bit, TX 25 bit, TX 30 bit	18.90 22.68	496936
Bit assortment All variants: for all Festool cordless drills with FastFix cutting line, Systainer SYS3 XXS 33 with transparent cover, dimensions with adjustable legs (L x W x H) 104 x 66 x 33 mm			
	SYS3 XXS CE-MX BHS 60 CENTROTEC BHS 60 CE rapid-change bit holder, TX 10 bit, TX 15 bit, TX 20 bit, 2 x TX 25 bit, TX 30 bit, PZ 1 bit, 2 x bit PZ 2, PZ 3 bit, PH 1 bit, PH 2 bit, PH 3 bit, SZ 0.8 x 5.5 bit, SZ 0.6 x 4.5 bit	35.80 42.96	205822
	SYS3 XXS CE-TX BHS 60 CENTROTEC BHS 60 CE rapid-change bit holder, 2 x TX 10 bit, 2 x TX 15 bit, 3 x TX 20 bit, 3 x TX 25 bit, 2 x TX 30 bit, 3 x TX 40 bit	35.80 42.96	205823
	SYS3 XXS CE-PZ BHS 60 CENTROTEC BHS 60 CE rapid-change bit holder, 5 x PZ 1 bit, 7 x bit PZ 2, 3 x PZ 3 bit	35.80 42.96	205824
	SYS3 XXS CE-MX BH 60 CENTROTEC BH 60 CE Imp magnetic bit holder, TX 10 bit, TX 15 bit, TX 20 bit, 2 x TX 25 bit, TX 30 bit, PZ 1 bit, 2 x bit PZ 2, PZ 3 bit, PH 1 bit, PH 2 bit, PH 3 bit, SZ 0.6 x 4.5 bit, SZ 0.8 x 5.5 bit	22.30 26.76	205825

CENTROTEC bits, 50 mm long		RRP in £*	Order no.
	Bit assortment DB CE 50/12-Set 1 for all Festool cordless drills with CENTROTEC interface, for SYS TL with lid compartment, 12-piece, in lid compartment insert, PH 1 bit, PH 2 bit, PH 3 bit, PZ 1 bit, bit PZ 2, PZ 3 bit, TX 10 bit, TX 15 bit, TX 20 bit, TX 25 bit, TX 30 bit, TX 40 bit, length 50 mm	73.80 88.56	205089
	Bit assortment CENTRO Bit-Set 1 for all Festool cordless drills with CENTROTEC interface, 6-pc., in bit check, TX 20 bit, TX 25 bit, TX 30 bit, TX 40 bit, PZ 1 bit, bit PZ 2, length 50 mm	35.50 42.60	205087
Bits All variants: for all Festool cordless drills with FastFix interface, with CENTROTEC interface, length 50 mm, qty. in pack 2 Units			
	PZ 1-50 CENTRO/2 size PZ 1	12.70 15.24	205069
	PZ 2-50 CENTRO/2 size PZ 2	12.70 15.24	205070
	PZ 3-50 CENTRO/2 size PZ 3	12.70 15.24	205072
Bits All variants: for all Festool cordless drills with FastFix interface, with CENTROTEC interface, length 50 mm, qty. in pack 2 Units			
	PH 1-50 CENTRO/2 size PH 1	12.70 15.24	205073
	PH 2-50 CENTRO/2 size PH 2	12.70 15.24	205074
	PH 3-50 CENTRO/2 size PH 3	12.70 15.24	205075
Bits All variants: for all Festool cordless drills with FastFix interface, with CENTROTEC interface, length 50 mm, qty. in pack 2 Units			
	TX 10-50 CENTRO/2 size TX 10	12.70 15.24	205076
	TX 15-50 CENTRO/2 size TX 15	12.70 15.24	205079
	TX 20-50 CENTRO/2 size TX 20	12.70 15.24	205080
	TX 25-50 CENTRO/2 size TX 25	12.70 15.24	205081
	TX 30-50 CENTRO/2 size TX 30	12.70 15.24	205082
	TX 40-50 CENTRO/2 size TX 40	12.70 15.24	205083
CENTROTEC bits, 100 mm long		RRP in £*	Order no.
	Bit set CENTROTEC BITS CE SET TL 6X for SYS TL with lid compartment, with CENTROTEC interface, in lid compartment insert, PZ 2 bit, PZ 3 bit, TX 15 bit, TX 20 bit, TX 25 bit, TX 30 bit, qty. in pack 6 Units, length 100 mm	39.70 47.64	769095
Bits All variants: with CENTROTEC interface, qty. in pack 2 Units, length 100 mm			
	PZ 1-100 CE/2 size PZ 1	15.40 18.48	500841
	PZ 2-100 CE/2 size PZ 2	15.40 18.48	500842
	PZ 3-100 CE/2 size PZ 3	15.40 18.48	500843
Bits All variants: with CENTROTEC interface, qty. in pack 2 Units, length 100 mm			
	PH 1-100 CE/2 size PH 1	15.40 18.48	500844
	PH 2-100 CE/2 size PH 2	15.40 18.48	500845
	PH 3-100 CE/2 size PH 3	15.40 18.48	500846
Bits All variants: with CENTROTEC interface, qty. in pack 2 Units, length 100 mm			
	TX 15-100 CE/2 size TX 15	15.40 18.48	500847
	TX 20-100 CE/2 size TX 20	15.40 18.48	500848
	TX 25-100 CE/2 size TX 25	15.40 18.48	500849
	TX 30-100 CE/2 size TX 30	15.40 18.48	500850





* Manufacturer's recommended retail price. Dealer prices may vary.
Excl. VAT. | Incl. VAT.







07 Drilling and screwdriving



Drilling guide systems		RRP in £*	Order no.
Drill stand for carpentry All variants: centering plate for drill bits Ø 8–26 mm, 2 x depth stop, 2 x parallel side fence, adapter ring Ø 57 mm / 43 mm			
	GD 320 max. drill depth 240 mm, max. drill bit length 320 mm, weight 2,8 kg	268.90 322.68	768768
	GD 460 max. drill depth 380 mm, max. drill bit length 460 mm, weight 3,2 kg	290.40 348.48	768119
	GD 460 A max. drill depth 310 mm, max. drill bit length 460 mm, weight 3,7 kg	378.90 454.68	769042
6 CENTROTEC wood twist drills		RRP in £*	Order no.
Drill bit case All variants: with CENTROTEC interface, long spiral wood drill bits with centring point			
	DB WOOD CE SET TL 6x for processing wooden materials, made from high-quality ball bearing steel, qty. in pack 6 Units, diameter 4, 2 x 5, 6, 8, 10 mm	54.20 65.04	769093
	BKS D 3-8 CE/W diameter 3, 4, 5, 6, 8 mm, length 73 (Ø3)/83 (Ø4)/93 (Ø5)/98 (Ø6)/115 (Ø8) mm, spiral length 33 (Ø3)/43 (Ø4)/51 (Ø5)/56 (Ø6)/75 (Ø8) mm, qty. in pack 5 Units	45.90 55.08	493648
Drill bit All variants: for all Festool cordless drills with FastFix interface, with CENTROTEC interface			
	D 3 CE/W diameter 3 mm, length 73 mm, spiral length 33 mm	9.10 10.92	492512
	D 4 CE/W diameter 4 mm, length 83 mm, spiral length 43 mm	9.10 10.92	492513
	D 5 CE/W diameter 5 mm, length 93 mm, spiral length 51 mm	9.40 11.28	492514
	D 6 CE/W diameter 6 mm, length 98 mm, spiral length 56 mm	9.90 11.88	492515
	D 7 CE/W diameter 7 mm, length 109 mm, spiral length 69 mm	10.00 12.00	492516
	D 8 CE/W diameter 8 mm, length 115 mm, spiral length 75 mm	12.20 14.64	492517
	D 10 CE/W diameter 10 mm, length 127 mm, spiral length 88 mm	14.30 17.16	492518
	Drill bit case BKS D 3-8 CE/W-K with CENTROTEC interface, short spiral wood drill bits with centring point, qty. in pack 5 Units, diameter 3, 4, 5, 6, 8 mm, length 65 mm, spiral length 25 mm	41.90 50.28	495130
CENTROTEC Forstner drill bit system		RRP in £*	Order no.
	Forstner drill bit set FB D 15-35 CE-Set with CENTROTEC interface, 5-piece, incl. conical centring bit Ø 4 mm and punch, FB D 15 CE, FB D 20 CE, FB D 25 CE, FB D 30 CE, FB D 35 CE, Systainer SYS MINI 1 TL TRA with a transparent cover, diameter 15, 20, 25, 30, 35 mm	125.80 150.96	205749
Forstner drill bit All variants: with CENTROTEC interface, made from high-quality ball bearing steel, can be sharpened up to 5 times			
	FB D 15 CE diameter 15 mm	24.90 29.88	205752
	FB D 20 CE diameter 20 mm	27.60 33.12	205753
	FB D 25 CE diameter 25 mm	30.30 36.36	205754
	FB D 30 CE diameter 30 mm	33.10 39.72	205755
	FB D 35 CE diameter 35 mm	35.80 42.96	205756
	Spare part set FB-CE/ET-Set for CENTROTEC Forstner drill bit, spare parts set with conical centring point and extra-long conical centring point, conical centring drill bit (4 mm) and punch for FB D 15-35 CE-Set (item no. 205749)	21.50 25.80	205750

CENTROTEC auger bit		RRP in £*	Order no.
	Auger bit set SB CE/6-Set for TPC 18/4, TDC 18/4 and all Festool C and T cordless drills with FastFix fixture (except CXS/TXS), with CENTROTEC interface, can be sharpened up to 15 times, high corrosion resistance and low friction thanks to special coating, perfectly adapted thread enables ideal chip removal, the robust threaded tip allows the drill to be precisely positioned and draws the drill into the wood, allowing for effortless work, D 6 auger bits, D 8 auger bits, D 10 auger bits, D 12 auger bits, D 14 auger bits, D 16 auger bits, Systainer SYS MINI 1 TL TRA with a transparent cover, total length 235 mm, effective length 165 mm, diameter 6 / 8 / 10 / 12 / 14 / 16 mm	116.80 140.16	205902
Auger bit All variants: for TPC 18/4, TDC 18/4 and all Festool C and T cordless drills with FastFix fixture (except CXS/TXS), with CENTROTEC interface, can be sharpened up to 15 times, high corrosion resistance and low friction thanks to special coating, perfectly adapted thread enables ideal chip removal, the robust threaded tip allows the drill to be precisely positioned and draws the drill into the wood, allowing for effortless work, total length 235 mm, effective length 165 mm			
	SB CE D6 diameter 6 mm	19.90 23.88	205903
	SB CE D8 diameter 8 mm	20.80 24.96	205904
	SB CE D10 diameter 10 mm	21.70 26.04	205905
	SB CE D12 diameter 12 mm	22.60 27.12	205906
	SB CE D14 diameter 14 mm	23.50 28.20	205907
	SB CE D16 diameter 16 mm	25.30 30.36	205908
CENTROTEC other accessoires		RRP in £*	Order no.
Deburring countersink			
	QLS D 2- 8 CE diameter 2 – 8 mm	27.90 33.48	492520
	QLS D 5-15 CE for pre-counterboring and flush screwing, diameter 5 – 15 mm	34.20 41.04	492521
	Drill bit with depth stop BTA HW D 5 CE with CENTROTEC interface, carbide, adjustable depth stop, diameter 5 mm	40.00 48.00	492522
	Spare part drill bit HW D 5 F.BTA for drill bit with depth stop, carbide, diameter 5 mm	26.90 32.28	491794
	Drill countersink BSTA HS D 3,5 CE with CENTROTEC interface, adjustable depth stop, diameter 3,5 mm	52.30 62.76	492523
	Spare part drill bit EB-BSTA D 3,5/5 for drill countersink with depth stop, qty. in pack 5 Units, diameter 3,5 mm	14.00 16.80	494445
	Drill countersink BSTA HS D 4,5 CE with CENTROTEC interface, adjustable depth stop, diameter 4,5 mm	55.10 66.12	492524
	Spare part drill bit EB-BSTA D 4,5/5 for drill countersink with depth stop, qty. in pack 5 Units, diameter 4,5 mm	14.00 16.80	494446
	Drill countersink BSTA HS D 5 CE with CENTROTEC interface, adjustable depth stop, diameter 5 mm	57.70 69.24	496451
	Spare part drill bit EB-BSTA D 5/5 for drill countersink with depth stop, qty. in pack 5 Units, diameter 5 mm	14.00 16.80	496452
	Drill countersink BSTA HS D 4 L60 CE for all Festool cordless drills, for use with the CENTROTEC tool chuck, with CENTROTEC interface, adjustable depth stop, especially designed for machining patio flooring, diameter 4 mm, max. drill depth 60 mm	57.30 68.76	202392
	Spare part drill bit EB-BSTA D4/2 for drill countersink with depth stop, extremely long service life because the drill bit is made of high-quality HSS Böhler steel, diameter 4 mm, max. drill depth 60 mm, qty. in pack 2 Units	24.00 28.80	202393

07 Drilling and screwdriving

CENTROTEC other accessoires		RRP in £*	Order no.
	Centering bit ZB HS D 5 EURO CE with CENTROTEC interface, with depth stop for 5 mm Euro-screws, diameter 5 mm	52.30 62.76	492525
	Spare part drill bit HS D 5 for centring bits, diameter 5 mm	19.70 23.64	493572
	Hook driver HD D 18 CE for all Festool cordless drills with FastFix interface, with CENTROTEC interface, diameter 18 mm	10.90 13.08	492526
	Drill adapter BA-CE CENTROTEC suitable for drills, enables drills to fit FastFix attachments such as tool chuck WH-CE CENTROTEC	18.00 21.60	496450

CENTROTEC masonry drills with carbide-tipped cutter		RRP in £*	Order no.
	Masonry drill DB STONE CE SET TL for cordless impact screwdrivers, impact drills with FastFix interface, for SYS TL with lid compartment, with CENTROTEC interface, for machining stone and masonry, with long-lasting carbide-tipped cutter, 6 CENTROTEC masonry drill bits: dia. 4, 5, 2 x 6, 8, 10 mm	50.90 61.08	769096
Masonry drill All variants: for cordless impact screwdrivers, impact drills with FastFix interface, with CENTROTEC interface, qty. in pack 3 Units			
	DB STONE CE D4 3x diameter 4 mm	26.40 31.68	769111
	DB STONE CE D5 3x diameter 5 mm	27.00 32.40	769112
	DB STONE CE D6 3x diameter 6 mm	29.30 35.16	769113
	DB STONE CE D8 3x diameter 8 mm	31.80 38.16	769114
	DB STONE CE D10 3x diameter 10 mm	35.50 42.60	769115

CENTROTEC HSS twist drill bit		RRP in £*	Order no.
	Twist drill bit HSS D3-10 CE/10 Drill bit case, with CENTROTEC interface, for machining steel and non-ferrous metals, hexagon socket wrench, qty. in pack 10 Units, diameter 3 / 3,5 / 4 / 4,5 / 5 / 5,5 / 6 / 6,5 / 8 / 10 mm	92.00 110.40	495128
Twist drill bit All variants: complete drill bit with CENTROTEC interface, hexagon socket wrench			
	HSS D 3/33 CE/M-Set CENTROTEC bit holder and two replacement drill bits, diameter 3 mm	10.40 12.48	493421
	HSS D 3,5/39 CE/M-Set CENTROTEC bit holder and two replacement drill bits, diameter 3,5 mm	10.90 13.08	493422
	HSS D 4/43 CE/M-Set CENTROTEC bit holder and two replacement drill bits, diameter 4 mm	11.50 13.80	493423
	HSS D 4,5/47 CE/M-Set CENTROTEC bit holder and two replacement drill bits, diameter 4,5 mm	12.40 14.88	493424
	HSS D 5/52 CE/M-Set CENTROTEC bit holder and two replacement drill bits, diameter 5 mm	12.60 15.12	493425
	HSS D 5,5/57 CE/M-Set CENTROTEC bit holder and two replacement drill bits, diameter 5,5 mm	12.70 15.24	493426
	HSS D 6/57 CE/M-Set CENTROTEC bit holder and two replacement drill bits, diameter 6 mm	13.30 15.96	493427
	HSS D 6,5/63 CE/M-Set CENTROTEC bit holder and two replacement drill bits, diameter 6,5 mm	13.80 16.56	493428
	HSS D 8,0/75 CE/M-Set CENTROTEC bit holder and replacement drill bits, diameter 8 mm	19.60 23.52	495308
	HSS D 10,0/75 CE/M-Set CENTROTEC bit holder and replacement drill bits, diameter 10 mm	24.40 29.28	495309

CENTROTEC HSS twist drill bit	RRP in £*	Order no.
Twist drill bit All variants: replacement drill bit for CENTROTEC HSS CE/M-Set twist drill bit		
HSS D 3/33 M/10 qty. in pack 10 Units, diameter 3 mm	10.60 12.72	493437
HSS D 3,5/39 M/10 qty. in pack 10 Units, diameter 3,5 mm	11.20 13.44	493438
HSS D 4/43 M/10 qty. in pack 10 Units, diameter 4 mm	13.70 16.44	493439
HSS D 4,5/47 M/10 qty. in pack 10 Units, diameter 4,5 mm	15.60 18.72	493440
HSS D 5/52 M/10 qty. in pack 10 Units, diameter 5 mm	17.10 20.52	493441
HSS D 5,5/57 M/10 qty. in pack 10 Units, diameter 5,5 mm	18.50 22.20	493442
HSS D 6/57 M/10 qty. in pack 10 Units, diameter 6 mm	20.00 24.00	493443
HSS D 6,5/63 M/10 qty. in pack 10 Units, diameter 6,5 mm	22.50 27.00	493444
HSS D 8,0/75 M/5 qty. in pack 5 Units, diameter 8 mm	24.30 29.16	495310
HSS D 10,0/75 M/5 qty. in pack 5 Units, diameter 10 mm	35.80 42.96	495311

HSS steel drill	RRP in £*	Order no.
 Drill bit box for HSS steel drill bits HSS D 1-10 Sort/19 Drill bit case, without CENTROTEC interface, for machining steel and non-ferrous metals, 19 pieces, qty. in pack 19 Units, diameter 1 / 1,5 / 2 / 2,5 / 3 / 3,5 / 4 / 4,5 / 5 / 5,5 / 6 / 6,5 / 7 / 7,5 / 8 / 8,5 / 9 / 9,5 / 10 mm	55.70 66.84	498981

Our recommendation: Festool Order app.

Download now
free of charge

With the Order app, you can find your Festool tool, suitable accessories and consumables, and create your digital shopping list and send it conveniently to your dealer. The favourites function allows you to easily re-order saved accessories or consumables. You can also manage your orders comfortably whilst on the go, can maintain an overview of these at all times and ensure your everyday work is even more well organised.



You can find more information on page 6

08 Routing



NEW



208 Routers



213 Edge trimming system



213 Routing template



214 Worktop template



215 Hole series system



216 Jointing system



218 (Module) edge routers



221 Routing tools

Real all-rounders – in three performance classes. The routers.

Grooving, chamfering, rebating or contouring – anything is possible with these routers. Maximum precision thanks to adjustment of the routing depth accurate to 1/10 mm and MMC electronics for temperature monitoring and adaptation to the material you are working with. Complete safety thanks to the quick-acting brake which brings the routers to a stop within seconds.



NEW

Router OF 1010 R

Lightweight, compact router with 55 mm routing depth adjustment range, and handle and dual for column safe clamping system for precise routing of edges, rebates, circles and much more.

Router OF 1400

The all-rounder for routing. Power and ease of operation in perfect harmony. With its 70 mm routing depth adjustment range, it is the perfect machine for making recesses for fittings and for routing with templates.



Router OF 2200

The 2200-watt powerhouse with enormous torque and a large routing depth adjustment range of 80 mm. Can be used for solid hardwood door fittings or in staircase construction.



Short set-up times

The ratchet principle on the OF 1400 and OF 2200 enables the copying ring to be changed without the need for additional equipment and the router to be replaced with ease.



The Festool cutters

Festool cutters allow you to tackle a wide range of applications safely and optimally. Machines, cutters and useful accessories – expertise from a single source.

Equipped for any task

The system accessories help you work more quickly. Starting with the multi-routing template, to the hole series guide rail, through to the VS 600 jointing system. They eliminate the need to spend time producing handmade routing templates.

System compatible. Clean and healthy work.

Forms the perfect combination with Festool mobile dust extractors for a clear view of the workpiece and for healthy, time-saving work. The bayonet fitting makes it easy to attach the hose and for it to be held securely.



You can find more information on page 148



08 Routing











Technical data	OF 1010 R	OF 1400	OF 2200
Power consumption (watt)	1.010	1.400	2.200
Idle engine speed (RPM)	9.500 – 23.000	10.000 – 22.500	10.000 – 22.000
Collet dia. (mm)	6 – 8	6 – 12,7	6 – 12,7
Routing stroke (mm)	55	70	80
Routing depth fine adjustment range (mm)	8	8	20
Bench opening (mm)	50	63	–
Dust extraction connection dia. (mm)	27/36	27/36	36/27
Weight (kg)	3	4,3	8,3

Items included	RRP in £*	Order no.
OF 1010 R All variants: Ø 8 mm clamping collet, side stop, guide rail adapter, chip deflector, open ended spanner, WAF 19, Systainer SYS3 M 237		
 OF 1010 REQ-Plus 110V	457.00 548.40	576924
OF 1010 REBQ-Plus 240V	457.00 548.40	576918
OF 1010 REBQ-Set 240V guide rail FS 800/2	514.00 616.80	577166
OF 1400 All variants: chip deflector, Ø 8 mm clamping collet, Ø 12 mm clamping collet, side stop with fine setting, copying ring Ø 30 mm, extraction hood, top, open ended spanner, WAF 24, Systainer SYS3 M 337		
 OF 1400 EQ-Plus 110V	593.00 711.60	576209
OF 1400 EBQ-Plus 240V	593.00 711.60	576210
OF 2200 All variants: Ø 8 mm clamping collet, Ø 12 mm clamping collet, copying ring Ø 30 mm, chip deflector, open ended spanner, WAF 24, Systainer SYS3 M 337		
 OF 2200 EB-Plus 110V	828.00 993.60	576219
OF 2200 EB-Plus 240V	828.00 993.60	576218
OF 2200 EB-Set 240V Systainer accessories	1,196.00 1,435.20	576221

Collets	OF 1010 R		OF 1400		OF 2200	
For cutter shank Ø	RRP in £*	Order no.	RRP in £*	Order no.	RRP in £*	Order no.
	6 mm	42.20 50.64	488760	49.60 59.52	494459	494459
	6,35 mm	42.20 50.64	488761	49.60 59.52	494463	494463
	8 mm	42.20 50.64	488755	49.60 59.52	494460	494460
	9,53 mm	–	–	49.60 59.52	494464	494464
	10 mm	–	–	49.60 59.52	494461	494461
	12 mm	–	–	49.60 59.52	494462	494462
	12,7 mm	–	–	49.60 59.52	494465	494465

Copying rings		OF 1010 R		OF 1400		OF 2200	
In self-service display pack		RRP in £*	Order no.	RRP in £*	Order no.	RRP in £*	Order no.
OF 1010 	D 10,8 mm d 7,8 mm	10.40 12.48	486029	-	-	-	-
	D 12,7 mm d 10 mm	-	-	-	-	16.20 19.44	495339
	D 17 mm d 14 mm	10.40 12.48	486030	16.80 20.16	493315	16.20 19.44	494622
OF 1400 	D 19,05 mm d 17 mm	-	-	-	-	16.20 19.44	495340
	D 24 mm d 21 mm	10.40 12.48	486031	17.10 20.52	492183	16.20 19.44	494623
OF 2200 	D 25,4 mm d 23 mm	-	-	-	-	16.20 19.44	495341
	D 27 mm d 24 mm	10.40 12.48	486032	17.10 20.52	492184	16.20 19.44	494624
	D 30 mm d 27 mm	10.40 12.48	486033	17.10 20.52	492185	16.20 19.44	494625
	D 34,93 mm d 32 mm	-	-	-	-	16.20 19.44	495342
	D 40 mm d 37 mm	10.40 12.48	486034	17.10 20.52	492186	16.20 19.44	494626
	D 30 mm/d 21mm**	-	-	-	-	28.60 34.32	497453
For jointing system VS 600 In self-service display pack		RRP in £*	Order no.	RRP in £*	Order no.	RRP in £*	Order no.
OF 1010  	D 8,5 mm d 7,8 mm FZ 6	11.30 13.56	490772	17.10 20.52	492179	-	-
	D 13,8 mm d 10,8 mm	10.40 12.48	484176	17.10 20.52	492180	-	-
	D 17 mm d 14 mm SZ 14	11.30 13.56	490770	17.10 20.52	492181	-	-
	D 24 mm d 21 mm SZ 20	11.30 13.56	490771	17.10 20.52	492182	-	-

** extra long safety copying ring D30, 21 mm high, required for use of reversible blade cutters 497455 and 497456.

Accessories for router OF 1010 R		RRP in £*	Order no.
	Centring mandrel ZD-OF/D 6,35+8 for all Festool routers, for shank support \varnothing 6.35 mm and 8 mm for centering the copying rings	21.40 25.68	492187
	Parallel side fence SA-OF 1000 for OF 900, OF 1000, OF 1010, OF 1010 R, KF, with 2 guide rods	39.10 46.92	489427
	Fine adjuster for parallel side fence FE-OF 1000/KF for OF 900, OF 1000, OF 1010, OF 1010 R, KF, for fast and dimensionally accurate adjustment on the parallel side fence, can be retrofitted, delivered without side stop and guide rods	30.70 36.84	483358
	Fine adjuster for guide stop FE-FS/OF 1000 for OF 900, OF 1000, OF 1010, OF 1010 R, KF	22.90 27.48	488754
	guide rail adapter FS-OF 1000 complete with support, for use of routers OF 900, OF 1000, OF 1010, OF 1010 R with the FS guidance system, without rods	33.60 40.32	488752
	Chip guard SF-OF for OF 900, OF 1000, OF 1010, OF 1010 R, KF	31.20 37.44	486242
	Edging plate UP-OF for OF 900, OF 1000, OF 1010, OF 1010 R, KF, angle arm WA-OF and edging plate UP-OF are needed for the flush trimming of projected edges	57.90 69.48	486058
	Angle arm WA-OF for OF 900, OF 1000, OF 1010, OF 1010 R, OF 1400, KF, needed to copy workpieces in conjunction with the copier scanning set KT-OF	34.90 41.88	486052
	Copier scanning set KT-OF for OF 900, OF 1000, OF 1010, OF 1010 R, OF 1400, KF, copier scanning set KT-OF and angle arm WA-OF are needed to copy workpieces	70.80 84.96	486534

* Manufacturer's recommended retail price. Dealer prices may vary.
Excl. VAT. | Incl. VAT.

08 Routing

Accessories for router OF 1010 R		RRP in £*	Order no.
	Base runner TP-OF not compatible with OF 1010 R, for OF 900, OF 1000, OF 1010, KF, hard fibre base runner, centre hole Ø 15 mm	13.80 16.56	489229
	Chip deflector KSF-OF 1010 for OF 900, OF 1000, OF 1010, OF 1010 R, for sideways extraction, max. aperture 37 mm	17.90 21.48	493180
	Dust extraction attachment AH-OF 1000 for OF 900, OF 1000, OF 1010, OF 1010 R, KF, for jointing system VS 500 / VS 600 and for edge trimming	19.90 23.88	484453
	Trammel unit SZ-OF 1000 for OF 900, OF 1000, OF 1010, OF 1010 R, KF, for cutting radii, circles and decorative curves on surfaces and edges, circle dia. 153 – 760 mm	20.40 24.48	483922
	Systainer³ SYS3-OF D8/D12 with foam insert, for safe storage of cutters D 8, D 12, dimensions (L x W x H) 396 x 296 x 112 mm, inner dimensions (L x W x H) 389 x 275 x 71 mm, SYSTAINER size SYS3 M 112	71.40 85.68	576835
Accessories for router OF 1400		RRP in £*	Order no.
	Base runner All variants: for OF 1400		
	LA-OF 1400 hard-fibre base runner with 20 mm centre bore, reduces the opening of the router to the cutter diameter, max. cutter diameter 37 mm	27.90 33.48	492574
	LAS-OF 1400 for sideways extraction, running pad with support extension, running pad with chip deflector, max. aperture 63 mm	101.00 121.20	493233
	Dust extraction attachment AH-OF 1400 for OF 1400 / VS 600, for sideways extraction	36.00 43.20	492585
	Chip deflector KSF-OF 1400 for OF 1400, for sideways extraction	17.70 21.24	492732
	Guide rail adapter FS-OF 1400 for OF 1400, with fine adjustment and support for router without guide rods, without rods	57.00 68.40	492601
	Parallel side fence SA-OF 1400 for OF 1400, With fine adjustment and extraction hood, without rods	43.10 51.72	492636
Accessories for the OF 2200 router		RRP in £*	Order no.
	Adapter KRA-ZOLL/OF 2200 for OF 2200, adapter for imperial copying rings	11.20 13.44	494627
	Base runner All variants: for OF 2200		
	LA-OF 2200 D36 CT for copying rings < 30 mm, With openings for optimised extraction	51.50 61.80	494675
	LA-OF 2200 D36 reduces the opening of the router to the cutter diameter	51.50 61.80	494677
	Support AFB-OF 2200 for OF 2200, support widener for safe guidance of the router at workpiece edges	61.60 73.92	494682
	Guide rail adapter FS-OF 2200 for OF 2200, Without guide rods ST-OF 2200/2, With fine adjustment and support plate for router	111.20 133.44	494681
	Rod ST-OF 2200/2 for OF 2200, guide rods for side and guide stops 2 pieces	18.80 22.56	495247
	Accessories set ZS-OF 2200 for OF 2200, guide rail adapter, parallel side fence with fine adjustment and extraction hood, Guide rods, copying ring Ø 17 mm, copying ring Ø 24 mm, copying ring Ø 27 mm, copying ring Ø 40 mm, base runner D36, base runner for copying rings, extension, Systainer SYS3 M 237	367.70 441.24	576832
	Parallel side fence SA-OF 2200 for OF 2200, With fine adjustment and extraction hood, Without guide rods ST-OF 2200/2	93.80 112.56	494680
	Chip deflector KSF-OF 2200 for OF 2200, for sideways extraction, max. cutter diameter 80 mm	37.20 44.64	494670

Edge trimming system OF-FH 2200

With the Festool routing aid and the router, front grooves for door seals can be routed directly on the construction site, achieving results which are equal to those of bench-mounted routers. And thanks to the integral dust extraction, the environment also remains free of wood dust.



Items included	RRP in £*	Order no.
OF-FH 2200	197.50 237.00	495246



Effective dimensions of seal types

Seal	Width (mm)	Depth	Cutter type
Planet HS	13,1	30	①
Schall-Ex L	14,8	32	②
Schall-Ex RD	14,8	28	②
Draft excluders	12,0	40	③
Double seals	12,0	40	③
Schall-Ex Ultra	19,7	30	④

Routing door seals

HW "Schall-Ex" and "Planet" groove cutter. The perfect solution when installing automatic door seals on-site.

Routing template MFS 400, MFS 700

Perfect for various curves, round or square cut-outs and routing stair stringers. A scale on the profile which is accurate to the millimetre makes it possible to work with complete precision. The prepared groove allows the MFS to be quickly secured to the workpiece using Festool fastening and lever clamps.



Technical data	MFS 400	MFS 700
Dimensions length x width (mm)	300 x 100	600 x 300
Curves (mm)	40 – 300	40 – 600

Items included	RRP in £*	Order no.
All variants: 2 x angle stop, tilt protection, circle routing insert, Screwdriver		
MFS 400	230.40 276.48	492610
MFS 700	360.40 432.48	492611



Can be extended systemically

With guide extensions from 200 mm to 2000 mm.

* Manufacturer's recommended retail price. Dealer prices may vary.
Excl. VAT. | Incl. VAT.

Worktop template

APS 900/2

Clean corner and panel joints are easy to produce with the worktop template. The permanently fixed template guarantees precise results, even when several routing operations are carried out on a single groove.











Technical data	APS
Dimensions (L x W x H) (mm)	1.000 x 380 x 16
Panel depth with corner joints, without adjustment (mm)	600/650
Panel depth with corner joints, with adjustment (mm)	900
For worktop connectors, bolt length (mm)	65/150



Items included	RRP in £*	Order no.
APS 900/2 corner connection template, profile MFS-VP 1000, 3 x Bolt, Screwdriver	319.20 383.04	204219

Precision as standard

For corner and panel joints with fixed fence with panel depths of 600 and 650 mm or, if moved, up to 900 mm.

Accessories for MFS and APS 900/2	RRP in £*	Order no.
Extension profile All variants: for extension of MFS 400, MFS 700, longitudinal connectors, screwdriver, WAF 2.5, qty. in pack 2 Units		
 MFS-VP 200 with scale, 2 x profile 200 mm	85.70 102.84	492722
 MFS-VP 400 with scale, 2 x 400 mm profile	100.30 120.36	492723
 MFS-VP 700 with scale, 2 x profile 700 mm	177.00 212.40	492724
 MFS-VP 1000 with scale, 2 x profile 1000 mm	210.40 252.48	492725
 MFS-VP 2000 without scale, 2 x profile 2000 mm	261.00 313.20	492726
 Router carriage MFS-FS for MFS 400, MFS 700, for large-surface routing, traverse path 600 mm, copy ring dia. 30 mm	129.50 155.40	495648
 Groove cutter with reversible blades HW S12 D14/45 WM for OF 1400, OF 2200, D 14 mm, NL 45 mm, GL 105 mm, s 12 mm	176.50 211.80	491110
 Groove cutter HW S12 D14/50 D 14 mm, NL 50 mm, GL 100 mm, s 12 mm	80.30 96.36	491089

Hole series system

LR 32

When used together with a Festool OF 1010 or OF 1400 router and a guide rail, the LR 32 system makes it possible to drill precise sets of holes spaced 32 mm apart.

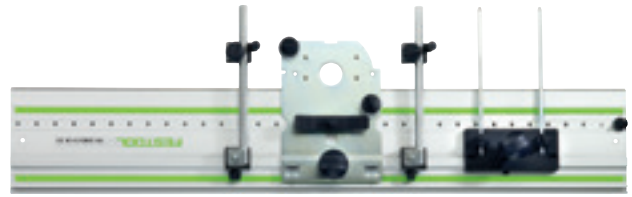









Technical data	LR 32
Hole spacing (mm)	32
Length of series of holes (without guide extension)	1.400 / 2.424
Side stop setting range (mm)	0 – 110
Weight (kg)	0,9



Holes in series

The LR 32 guide rail is aligned quickly and parallel to the two parallel side fences, which are positioned by means of an adjustable stop at the workpiece and guide rail.

Items included	RRP in £*	Order no.
LR 32 set		
 LR 32 Set guide plate, centring mandrel, 2 x side stop, 2 x Longitudinal stop	209.80 251.76	583290
LR 32		
 LR 32-SYS guide plate, centring mandrel, hinge location cutter HM Ø 35 mm, dowel drill HW Ø 5 mm (V-shaped tip), dowel drill HM Ø 5 mm (with centring bit and pre-cutter), 2 parallel side fences with adjustable stop, FSZ 120 fastening clamps (two units), 2 x Longitudinal stop, screwdriver, WAF 5, Systerainer SYS 1 T-LOC	410.90 493.08	584100
Accessories	RRP in £*	Order no.
Guide rail		
 FS 1400/2-LR 32 length 1.400 mm	104.60 125.52	496939
 FS 2424/2-LR 32 length 2.424 mm	254.80 305.76	491622
 Stopper LA-LR 32 FS positions the first hole on the hole series guide rail at a distance of 9.5, 16 or 32 mm from the workpiece edge, qty. in pack 2 Units	36.90 44.28	496938
 Parallel side fence SA-LR 32 with adjustable stop, for parallel alignment of guide rails	59.90 71.88	485758
 Adjustable stop AR-LR 32 for parallel side fence, for OF 900, OF 1000, OF 1010, OF 1400	23.10 27.72	485759
 Guide plate FP-LR 32 for routers OF 900, OF 1000, OF 1010, OF 1400 in the FS-LR32 hole drilling system, centring mandrel	118.90 142.68	494340

* Manufacturer's recommended retail price. Dealer prices may vary.
Excl. VAT. | Incl. VAT.

Jointing system VS 600

The jointing system VS 600 is an exceptionally uncomplicated and time-saving method of achieving perfect results. Offering outstanding precision for traditional positive connections such as partially covered and open dovetail joints, slot joints and custom-fit dowelling joints.







Technical data	VS 600
Workpiece thickness (depending on join) (mm)	6 – 29
Max. workpiece width (mm)	600











Items included	RRP in £*	Order no.
VS 600 GE	387.00 464.40	488876



7 templates

Whether you want to route dovetail joints or slot joints, the seven VS 600 templates will cut them quickly and easily – with a maximum working width of 650 mm.

Accessories	RRP in £*	Order no.
Semi-covered dovetail joints		
 Dovetail joint template VS 600 SZ 14 for OF 1010, OF 1400, for blind dovetail joints, tenon size 14 mm, copying rings for the OF 1400 must be ordered separately, copying ring Ø 17 mm (for OF 1010), workpiece thickness 14 – 20 mm	74.80 89.76	488877
Dovetail cutter All variants: for semi-covered dovetail joints SZ 14, D 13,8 mm, NL 13,5 mm, GL 46 mm, alpha 15°, s 8 mm		
 HS S8 D13,8/13,5/15°	19.50 23.40	490991
HW S8 D13,8/13,5/15°	34.10 40.92	490992
 Dovetail joint template VS 600 SZ 20 for OF 1010, OF 1400, for blind dovetail joints, tenon size 20 mm, copying rings for the OF 1400 must be ordered separately, copying ring Ø 24 mm (for OF 1010), workpiece thickness 21 – 28 mm	74.80 89.76	488878
Dovetail cutter All variants: for semi-covered dovetail joints SZ 20, D 20 mm, NL 17 mm, GL 49 mm, alpha 15°, s 8 mm		
 HS S8 D20/17/15°	29.20 35.04	490995
HW S8 D20/17/15°	38.60 46.32	490996

Accessories		RRP in £*	Order no.
Open dovetail joints			
	Template-kit VS 600 SZO 14 for OF 1010, OF 1400, open dovetail joint, slot size 14 mm, copying rings for the OF 1400 must be ordered separately, copying ring Ø 8.5 mm (for OF 1010), copying ring Ø 17 mm (for OF 1010), workpiece thickness 10 – 14 mm	128.70 154.44	491152
	Dovetail cutter HW S8 D14,3/16/10° for open dovetail joints SZO 14, D 14,3 mm, NL 16 mm, GL 50 mm, alpha 10°, s 8 mm	35.50 42.60	491164
	Template-kit VS 600 SZO 20 for OF 1010, OF 1400, for exposed dovetail joints, tenon size 20 mm, copying rings for the OF 1400 must be ordered separately, copying ring Ø 13.8 mm (for OF 1010), copying ring Ø 24 mm (for OF 1010), workpiece thickness 14 – 25 mm	128.70 154.44	491153
	Dovetail cutter HW S8 D20/26/10° for open dovetail joint slots, SZO 20, D 20 mm, NL 26 mm, GL 58 mm, alpha 10°, s 8 mm	41.30 49.56	491165
	Spiral groove cutter HW Spi S8 D10/30 for slot joints FZ 10 and open dovetail joints SZO 20 with fine precision in diameter, D 10 mm, NL 30 mm, GL 60 mm, s 8 mm	57.20 68.64	490980
		RRP in £*	Order no.
Box joint			
	Slot joint template VS 600 FZ 6 for OF 1010, OF 1400, for slot joint connections, tenon size 6 mm, copying rings for the OF 1400 must be ordered separately, copying ring Ø 8.5 mm (for OF 1010), workpiece thickness 6 – 10 mm	67.00 80.40	488879
	Spiral groove cutter All variants: for slot joints FZ 6 and open dovetail joints SZO 14 with fine precision in diameter, D 6 mm, NL 21 mm, GL 50 mm, s 8 mm		
	HW Spi S8 D6/21	46.20 55.44	490978
	HS Spi S8 D6/16	22.50 27.00	490944
	Slot joint template VS 600 FZ 10 for OF 1010, OF 1400, for slot joint connections, tenon size 10 mm, copying rings for the OF 1400 must be ordered separately, copying ring Ø 13.8 mm (for OF 1010), workpiece thickness 10 – 20 mm	67.00 80.40	488880
	Spiral groove cutter HS Spi S8 D10/30 for slot joints FZ 10 and open dovetail joints SZO 20 with fine precision in diameter, D 10 mm, NL 30 mm, GL 60 mm, s 8 mm	26.10 31.32	490946
		RRP in £*	Order no.
Dowel joint			
	Jointing system dowel joint unit VS 600 DS 32 for OF 1010, OF 1400, dowelling joint in the 32 grid, copying rings for the OF 1400 must be ordered separately, copying ring Ø 13.8 mm (for OF 1010)	74.80 89.76	488881
	Dowel drill All variants: with brad point, NL 30 mm, GL 53,5 mm, s 8 mm		
	HW S8 D5/30 Z D 5 mm	21.90 26.28	491066
	HW S8 D6/30 Z D 6 mm	22.50 27.00	491067
	HW S8 D8/30 Z D 8 mm	23.60 28.32	491068
	HW S8 D10/30 Z D 10 mm	26.10 31.32	491069

* Manufacturer's recommended retail price. Dealer prices may vary.
Excl. VAT. | Incl. VAT.

The edge experts.

The edge routers and module edge routers.

Edge routers provide the solution for an even, clean finish: Suitable for edge veneers, flush trimming, chamfering, rounding, contouring and cutting grooves. The compact design means that the handle position is located close to the router, therefore guaranteeing reliable guidance when working on straight and curved edges.

Laminate trimmer

OFK 500

With a lightweight design that is convenient and simple to use.



Module edge router

MFK 700

The universal edge router with exchangeable table – also suitable for routing grooves.



Laminate trimmer

OFK 700

The multi-talent for edge routing.



Module edge router

MFK 700 Basic

The specialist in edge routing – flush trimming and rounding off in a single step. Perfect in combination with the CONTURO edge bander.



Surface protection

The bench of the OFK 700 and the MFK 700 is inclined by 1.5° to protect the surface from damage. The slight inclination of the cutter prevents the surface from being milled off.



Large support surface

A large, precision-adjustable bench surface enables the MFK 700 to be optimally guided along the edge of the workpiece. Even when routing around corners, the machine does not tilt or route into the surface.



The finishing touch for the perfect edge

The MFK 700 EQ/B-Plus module edge router with special base for flush trimming edge veneers – even on edges cut at 45°. Thanks to the newly developed ball bearing brake with integrated chip deflector, it operates cleanly and efficiently without streaks.



Particularly compact

The OFK 500 works with an especially small spacing between the router and router table. The result: No routing mistakes, no slipping when working around corners and a better result on the whole.

The start of the perfect edge. The **CONTURO** edge bander.

The CONTURO makes edging straight edges, curves, radii, convex and concave shapes, and internal corners a piece of cake. Even mitred edges can be cut to an outstanding quality with the bench unit. Quick, easy and clean – ideal for mouldings and small series.





You can find more information on page 258







08 Routing



Technical data	OFK 500	OFK 700	MFK 700	MFK 700 Basic
Power consumption (watt)	450	720	720	720
Idle engine speed (RPM)	28.000	10.000 – 26.000	10.000 – 26.000	10.000 – 26.000
Max. cutter diameter (mm)	28	26	32	32
Collet dia. (mm)	–	6 – 8	6 – 8	6 – 8
Max. routing width (mm)	–	14	–	–
Routing depth fine adjustment range (mm)	–	–	14	14
Dust extraction connection dia. (mm)	27	27	27	27
Weight (kg)	1,4	2	1,9	1,9

Items included	RRP in £*	Order no.
OFK 500		
 OFK 500 Q-Plus R3 ogee cutter HW R3-OFK, extraction hood, Systainer SYS3 M 187	not available in Great Britain	576225
OFK 700		
 OFK 700 EQ-Plus 240V Ø 8 mm clamping collet, extraction hood, edge trimming cutter D 19 x 16, open ended spanner, WAF 19, Systainer SYS3 M 187	545.00 654.00	576233
MFK 700		
 MFK 700 EQ-Set 240V Ø 8 mm clamping collet, parallel side fence with fine adjustment and extraction hood, 1.5° router table, extraction hood, open ended spanner, WAF 19, Systainer SYS3 M 237	528.00 633.60	576238
MFK 700 Basic		
 MFK 700 EQ/B-Plus 240V Ø 8 mm clamping collet, open ended spanner, WAF 19, Systainer SYS3 M 187	357.00 428.40	576243

Accessories	RRP in £*	Order no.
 Router table FT 0° for routing accurate angles	93.80 112.56	491427
Collet All variants: for MFK/OFK 700, OF 900, OF 1000, OF 1010, KF, with locking nut		
 SZ-D 6/OF 1000 for cutter shank Ø 6 mm	42.20 50.64	488760
SZ-D 6,35/OF 1000 for cutter shank Ø 6.35 mm (1/4")	42.20 50.64	488761
SZ-D 8/OF 1000 for router shank Ø 8 mm	42.20 50.64	488755
 Router table FT-MFK 700 1,5° Set for MFK/OFK 700, tarnishing pad, extraction hood	131.10 157.32	495165
 Parallel side fence SA-MFK 700 for MFK 700, with fine adjuster, extraction hood, 2 x Guide rods	60.60 72.72	495182

Expertise in routing.

The Festool cutters.

If you want to achieve guaranteed quality, compromise is out of the question. That is why we recommend original Festool routing accessories for all Festool routers. Produced with the same care as the tools. With cutting blades which impress with their micro-grain quality and density. And which ensure superb results and an excellent service life with their cutting edge geometry. Machines, routers and accessories – we provide optimum equipment from a single source for versatile and efficient working.



The right material for every application

HW Tungsten carbide
HW routers are ideally suited to processing hardwood, panel materials and plastic.

HS High performance, high speed steel
This steel has mechanical and thermal properties that are best suited for routing soft materials such as spruce and pine.

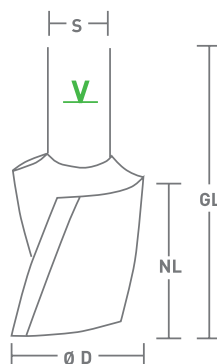

GL Total length (mm)
NL Effective length (mm)
D Cutter diameter (mm)
s Shank diameter (mm)
alpha Cutting angle (°)
R Radius (mm)
V Marking for minimum clamping length
n max. = maximum cutter speed
HW Tungsten carbide
HS High-speed steel

Tip: For optimum routing patterns, the routers should always be clamped at the lowest depth possible, and at least as far as the marking for minimum clamping length on the router shank.

Groove cutter

Router cutter HW, solid hard metal with base blade, shank 8 mm

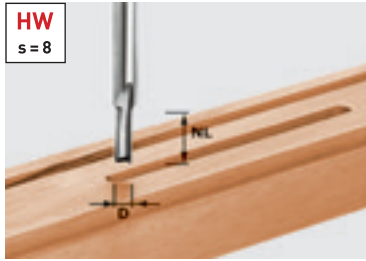

HW
s = 8

D	NL	GL	s	RRP in £*	Order no.
3	6	45	8	27.90 33.48	490952
4	10	45	8	27.90 33.48	490953
5	12	45	8	28.50 34.20	490954
6	14	55	8	29.00 34.80	490955
7	17	55	8	30.60 36.72	490956
8	20	55	8	31.40 37.68	490957
8	30	60	8	35.90 43.08	491647

No compromises.

The partially ground standard tungsten carbide blade provides an increased service life when drilling panel materials

Router cutter HW with fitted base blade, shank 8 mm

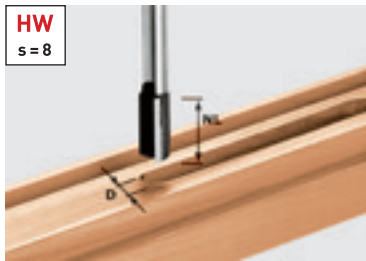

HW
s = 8

D	NL	GL	s	RRP in £*	Order no.
9	23	55	8	26.30 31.56	490958
10	20	60	8	26.60 31.92	490959
10	25	60	8	28.80 34.56	490960**
10	30	60	8	31.10 37.32	491648
11	20	60	8	29.20 35.04	490961
12	20	60	8	30.00 36.00	490962
12	30	60	8	32.90 39.48	491649
13	20	60	8	31.40 37.68	490963
14	20	60	8	32.00 38.40	490964
15	20	60	8	34.10 40.92	490965
16	20	60	8	37.50 45.00	490966
16	30	65	8	38.20 45.84	490967
18	20	60	8	39.80 47.76	490968
18	30	65	8	40.30 48.36	490969
19	20	60	8	40.80 48.96	490970
20	20	60	8	41.00 49.20	490971
20	30	65	8	42.20 50.64	490972
22	20	60	8	43.80 52.56	490973
24	20	60	8	46.40 55.68	490974
25	20	60	8	51.40 61.68	490975
30	20	60	8	57.20 68.64	490976

Long service life, even when plunge cutting.

If you wish to achieve quality cutting results with ease when drilling, grooving, rebating and long-hole routing, you are best advised to use the HW groove cutter. It cuts precisely, makes drilling easier and has a long service life.

Hard-wearing drill point.

After drilling 60 holes in a kitchen worktop (30 mm deep): Cutting edge only shows slight signs of wear.



Ground drill point.

After drilling 60 holes in a kitchen worktop (30 mm deep): Blunt cutting edge.



Router cutter HS single-edged, with base blade, shank 8 mm



HS
s = 8

D	NL	GL	s	RRP in £*	Order no.
3	8	45	8	13.80 16.56	490941
4	15	48	8	13.80 16.56	490942
5	12	50	8	13.80 16.56	490943

Groove cutter, spiral groove cutter

Router cutter HW with fitted base blade, shank 12 mm

HW
s = 12

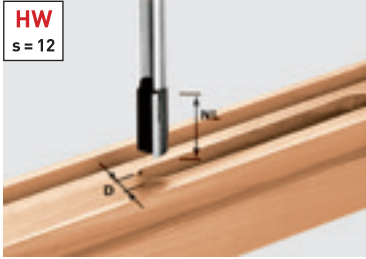

D	NL	GL	s	RRP in €*	Order no.
10	35	90	12	50.90 61.08	491086
12	40	90	12	53.10 63.72	491087
13,2	35	85	12	67.30 80.76	493789
14	40	85	12	62.80 75.36	491088
14	50	100	12	80.30 96.36	491089
15	35	85	12	75.60 90.72	493790
16	45	90	12	64.80 77.76	491090
16	60	100	12	82.60 99.12	491091
18	45	90	12	69.50 83.40	491092
20	45	90	12	73.10 87.72	491093
22	45	90	12	78.50 94.20	491094
24	45	90	12	82.60 99.12	491095
30	35	90	12	110.50 132.60	491096

HW "Schall-Ex" and "Planet" groove cutter.

The perfect solution when installing automatic door seals on-site.

Effective dimensions of seal types

Seal	Width (mm)	Depth	Cutter type
Planet HS	13,1	30	①
Schall-Ex L	14,8	32	②
Schall-Ex RD	14,8	28	②
Draft excluders	12,0	40	③
Double seals	12,0	40	③
Schall-Ex Ultra	19,7	30	④

Spiral router cutter HW solid hard metal with base blade, shank 8 mm

HW
s = 8

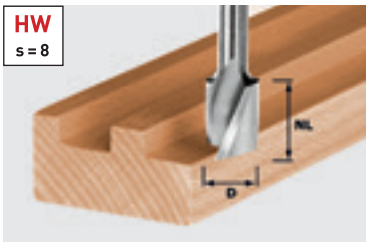

D	NL	GL	s	RRP in €*	Order no.
4	10	45	8	43.90 52.68	490977
6	21	50	8	46.20 55.44	490978
8	25	55	8	48.90 58.68	490979
10	30	60	8	57.20 68.64	490980

Spiral router cutter HS with base blade, shank 8 mm

HS
s = 8

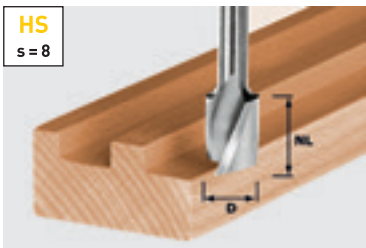

D	NL	GL	s	RRP in €*	Order no.
6	21	50	8	22.50 27.00	490944**
8	19	50	8	17.30 20.76	490945
10	30	60	8	26.10 31.32	490946**
12	20	52	8	21.40 25.68	490947
14	20	52	8	23.60 28.32	490948
16	20	52	8	26.10 31.32	490949
18	25	57	8	30.00 36.00	490950
20	25	57	8	32.40 38.88	490951

Multi-talented.

The HS spiral groove cutter and the HW solid carbide spiral groove cutter: Fast rate of advance for grooving, rebating, long-hole cutting, drilling and copy routing. The chips are drawn upwards by the spiral cutter, keeping the groove permanently clean.

** for slot jointing with the Festool VS 600, with extra precision in the diameter



Router bit box, stepped cutter, reversible blade groove cutter

Router bit box



Items included with the router bit box	RRP in £*	Order no.
Flush trim cutter HW D12.7/NL25 KL, dowel drill HW D5 x 30 Z, Groove cutter HW D10/20 with drill point, groove cutter HW D18/30 with drill point, Roundover cutter HW D16.7/R2 KL, classic ogee cutter HW D25.5 R6.3 KL, Roundover cutter HW D31.7/R9.5 KL, chamfer cutter HW D36/45Grad KL, disc groove cutter HW D40 x 4, dovetail cutter HW D13,8/ 15°	194.90 233.88	498979

Cutter set for the professional.

The router bit box contains ten router bits for the most important and most frequent applications. This therefore offers a price saving compared with purchasing each of them individually. The individual router bits are clearly organised and safely stored in a transparent router bit magazine in the router bit set.

Stepped cutter, Shank 12 mm

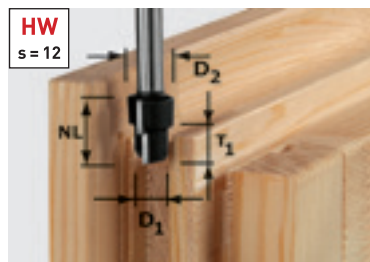

GL	D1	D2	NL	T1	s	RRP in £*	Order no.
80	12,3	16,3	14	9,3	12	85.10 102.12	492713
80	12,3	20,3	14	9,3	12	89.60 107.52	492714

Perfect when combined with the routing aid.

The stepped cutter and the Festool routing aid can be used to route windows and house doors quickly and precisely, making sure they do not tilt or wobble.

Turning plate router cutter HW single-edged, with base blade, shank 8 mm

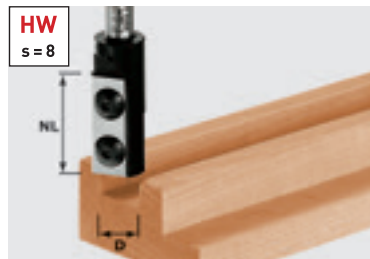

D	NL	GL	s	RRP in £*	Order no.
8	20	50	8	88.50 106.20	491078
10	25	55	8	89.70 107.64	491079
12	30	61	8	92.30 110.76	491080
14	30	66	8	104.30 125.16	492715
16	30	70	8	101.80 122.16	492716
18	30	70	8	107.50 129.00	492717

Its efficiency speaks for itself.

The reversible blades provide consistent cutter dimensions and precision – without resharpening. Quick cutter changes and reversible blade guarantee sharp cutters and greater economic efficiency at all times.



Accessories for turning plate router cutter HW, single-edged with base blade, shank 8 mm

Replacement blade for cutter HW-WP 20x4,1x1,1 (4x) for cutter 491078	42.20 50.64	491386
Replacement blade for cutter HW-WP 25x5,5x1,1 (4x) for cutter 491079 [4 pcs]	44.40 53.28	491387
Replacement blade for cutter HW-WP 30x5,5x1,1 (4x) for cutters 491080, 492715	46.70 56.04	491388
Reversible blade HW-WP 30x12x1,5 (4x) for 492716, 492717, 491120 cutters, main plate	57.20 68.64	491393
Replacement blade for cutter HW-WP 7,6x12x1,5 (4x) pre-cutter for 492716, 492717, 491120 cutters	38.60 46.32	491390

Turning plate router cutter HW single-edged, with base blade, shank 12 mm



D	NL	GL	s	RRP in £*	Order no.
16	50	110	12	179.00 214.80	497454

Accessories for reversible blade rebating cutter HM, single edge with plunge point, shank 12 mm

Reversible blade Wepla Set D 16 2+2 spare reversible blades set for cutter 497454	39.80 47.76	497458
---	-----------------------	--------

Groove cutter with reversible blades, rebating head, half-round cutter

Turning plate router cutter HW single-edged, with base blade, direct bit holder

HW
KN

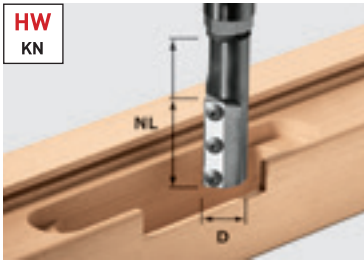

D	NL	GL	RRP in €*	Order no.
20	50	110	189.90 227.88	497455
24	50	117	198.40 238.08	497456

Accessories for turning plate router cutter HW, single-edged with base blade, direct bit holder

Reversible blade Wepla Set D 20 2+2
spare reversible blade set for cutter 497455

43.90
52.68

497568

Reversible blade Wepla Set D 24 2+2
spare reversible blades set for cutter 497456

41.00
49.20

497569

Copying ring KR-D 30,0/21,5/OF 2200
for OF 2200, extra long safety copying ring D30, 21 mm high, required for use of reversible blade cutters 497455 and 497456, D 30 mm, Dia. 27 mm

28.60
34.32

497453

For door hinges in block frames and door leaves.

The extra long reversible blade cutter is suitable for extreme routing depths, with direct bit holder for 20 and 24 mm diameters. For precision working in combination with router OF 2200 and extra long copying ring [order no. 497453].



Rebating head



Diameter	NL	RRP in €*	Order no.
50	30	110.40 132.48	489284

Accessories for rebating head

Reversible blade WP 30x12x1,5
for rebating head, Qty. in pack 2 Units

22.50
27.00

489286

Cutter spindle ASL20/OF1010
for OF 1010, required for holding the FK D rebating head 50 x 30 (489284)

35.60
42.72

489285

Cutter spindle ASL20/OF1400-OF2200
for OF 1400, OF 2200, required for holding the FK D rebating head 50 x 30 (489284)

42.20
50.64

490131



Cutter spindle with direct bit holder

Half-round cutter HW with ball bearing guide, shank 8 mm

HW
s=8

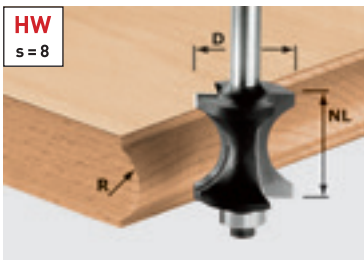

D	NL	GL	R	s	RRP in €*	Order no.
27	28	70	12	8	68.60 82.32	491139

Accessories for half-round cutter HW

Ball bearing guide D12,7 (2x)
Diameter 12,7 mm, Qty. in pack 2 Units

12.40
14.88

491383

For the complete job.

For decorative board edging the HW halfround cutter does a great job. It is perfectly designed for 28 mm thick laminated wood board. Its ball bearing guide guides the router directly along the template and ensures that curved parts can also be profiled.

Roundover cutter, ovolo edge cutter, reversible-blade chamfer cutter/ laminated trimmer

Ogee cutter HW with ball bearing guide, shank 8 mm



** delivered items include Ø 12.7 mm and Ø 9.5 mm ball bearing

D	NL	GL	R	s	RRP in £*	Order no.
16,7	9	49	2	8	47.30 56.76	491009**
19,1	10	50	3	8	47.90 57.48	491010**
20,7	11	51	4	8	48.50 58.20	491011**
22,7	12	52	5	8	48.90 58.68	491012**
25,5	13,5	54	6,35	8	50.20 60.24	491013**
28,7	15	55	8	8	52.10 62.52	491014**
31,7	16,5	56	9,5	8	54.00 64.80	491015**
38,1	19	59	12,7	8	59.50 71.40	491016**
42,7	22	62	15	8	63.00 75.60	491017**

One tool – two uses.



With ball bearing guide Ø 12.7 mm for rounding



With ball bearing guide Ø 9.5 mm for beading

Accessories for classic ogee cutter HW

Ball bearing guide D12,7 (2x) Diameter 12,7 mm, Qty. in pack 2 Units	12.40 14.88	491383
Ball bearing guide D9,53 (2x) Diameter 9,53 mm, Qty. in pack 2 Units	22.10 26.52	491382

Ogee cutter HW with ball bearing guide, shank 12 mm



D	NL	GL	R	s	RRP in £*	Order no.
63	32	82	25	12	115.90 139.08	491107

Accessories for classic ogee cutter HW

Ball bearing guide D12,7 (2x) Diameter 12,7 mm, Qty. in pack 2 Units	12.40 14.88	491383
Ball bearing guide D9,53 (2x) Diameter 9,53 mm, Qty. in pack 2 Units	22.10 26.52	491382

Ovolo edge cutter HW, shank 8 mm

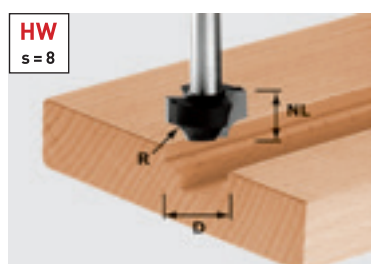

D	NL	GL	R	s	RRP in £*	Order no.
17	10	40	3	8	43.90 52.68	491004
23	13	45	6	8	48.90 58.68	491007

For decorative fronts using imitation panelling.

It is possible to plunge-cut centrally into the front of the furniture using the standard bit.

Turning plate chamfer/edge-trimming cutter HW with ball bearing guide, shank 8 mm

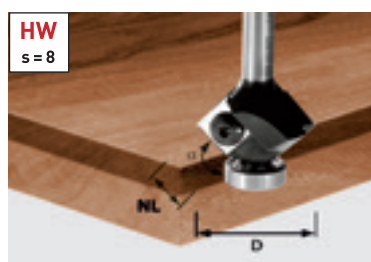

D	NL	GL	Alpha	s	RRP in £*	Order no.
27	8	55	45	8	101.80 122.16	499807

Accessories for turning plate slot cutter HW

Ball bearing guide D12,7 (2x) Diameter 12,7 mm, Qty. in pack 2 Units	12.40 14.88	491383
Reversible blade HW-WP 12x12x1,5 (4x)	35.00 42.00	491391

Precisely calculated.

The edge trimming cutter with HW reversible blades is the ideal tool for those who attach great importance to a long service life, outstanding economic efficiency and constant precision. Purchase one reversible blade, receive the service life of four cutters and save on consequential costs because the cutter can be reversed.

Roundover/chamfer cutter, chamfer cutter

Ogee chamfer cutter HW with ball bearing guide, shank 8 mm



D	NL	GL	R	Alpha	s	RRP in €*	Order no.
23,1	19	60	6	30	8	72.20 86.64	491135



Chamfer cutter HW with ball bearing guide, shank 8 mm

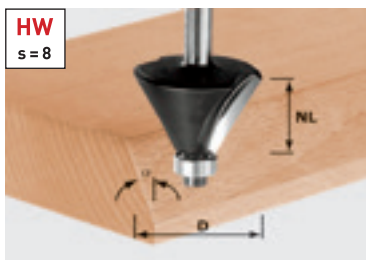

D	NL	GL	Alpha	s	RRP in €*	Order no.
18	11	50	15	8	45.50 54.60	499801
25,7	25,1	70	15	8	48.90 58.68	491132
25	11	50	30	8	46.30 55.56	499800
38,5	25,7	64	30	8	57.20 68.64	491133
26	7	48	45	8	49.10 58.92	499799
36	11,5	53	45	8	45.60 54.72	491025

Accessories for chamfer cutter HW

Ball bearing guide D12,7 (2x) Diameter 12,7 mm, Qty. in pack 2 Units	12.40 14.88	491383
--	-----------------------	--------

An unbeatable team.

You can also produce this familiar edge shape commonly found in industry using these shank cutters in a portable router. Here the chamfer cutter and classic ogee cutter with conical ball bearing guide work together perfectly.



Chamfer cutter HW, Shank 12 mm



D	NL	GL	Alpha	s	RRP in €*	Order no.
44	30	80	30	12	70.80 84.96	491101
55	20	76	45	12	78.50 94.20	491102

Accessories for chamfer cutter HW

Ball bearing guide D12,7 (2x) Diameter 12,7 mm, Qty. in pack 2 Units	12.40 14.88	491383
--	-----------------------	--------

Round nose cutter, flute cutter

Water gutter cutter HW with ball bearing guide, shank 8 mm

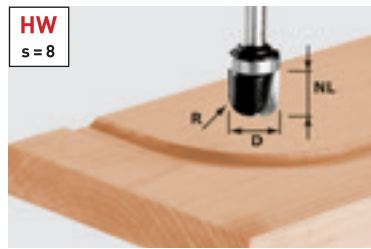

D	NL	GL	R	s	RRP in £*	Order no.
19	16	53	6,4	8	72.20 86.64	490982

Accessories for round nose cutter HW

Ball bearing guide D19 (2x) Diameter 19 mm, Qty. in pack 2 Units	18.90 22.68	491396
--	-----------------------	--------

Routing without a copying ring.

This cutter can produce curved or round water channels 1:1 without any problem using a template. Time-consuming calculation of curves and distances is no longer necessary.

Water gutter cutter HW, shank 8 mm



D	NL	GL	R	s	RRP in £*	Order no.
16	25	65	5	8	60.50 72.60	490981



Flute cutter HW, shank 8 mm

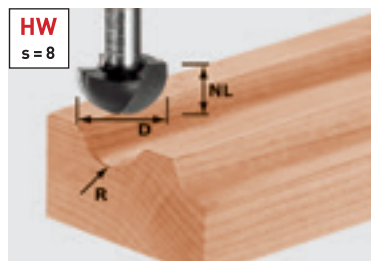

D	NL	GL	R	s	RRP in £*	Order no.
8	8	38	4	8	27.10 32.52	490983
12,7	10	40	6,35	8	30.60 36.72	490984
16	11	41	8	8	34.10 40.92	490985
19,4	11	41	9,7	8	36.90 44.28	490986
25,4	14	44	12,7	8	41.40 49.68	490987

Flute cutter HW, shank 12 mm

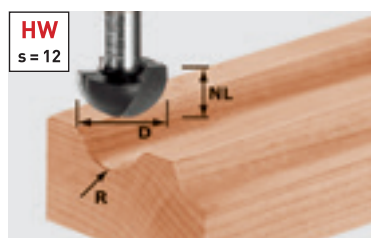

D	NL	GL	R	s	RRP in £*	Order no.
30	20	60	15	12	74.50 89.40	491104
40	25	65	20	12	88.50 106.20	491105

Flute cutter HW with ball bearing guide, shank 8 mm

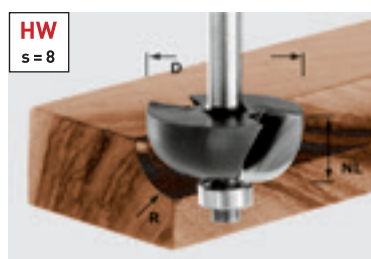

D	NL	GL	R	s	RRP in £*	Order no.
25,5	12,7	54	6,35	8	42.20 50.64	491018
31,7	14,3	56	9,5	8	47.90 57.48	491020
38,1	16	57	12,7	8	54.90 65.88	491021

Accessories for flute cutter HW

Ball bearing guide D12,7 (2x) Diameter 12,7 mm, Qty. in pack 2 Units	12.40 14.88	491383
--	-----------------------	--------

Edge-trimming cutter, edge-trimming cutter with reversible blades, edge trimming chamfer cutter

Edge trimming cutter HW with ball bearing guide, shank 8 mm

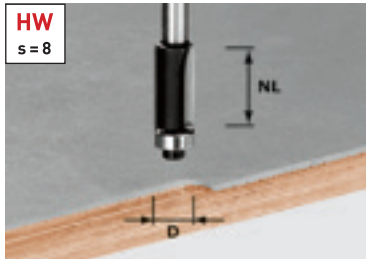

D	NL	GL	Alpha	s	RRP in €*	Order no.
12,7	25	65	0	8	45.60 54.72	491027

Accessories for edge trimming cutter HW

Ball bearing guide D12,7 (2x) Diameter 12,7 mm, Qty. in pack 2 Units	12.40 14.88	491383
--	-----------------------	--------

Through thick and thin.

The HW template router is the ideal tool for simple 1:1 copy routing thanks to its large ball bearing guide.

Edge trimming cutter HW with ball bearing guide, shank 8 mm

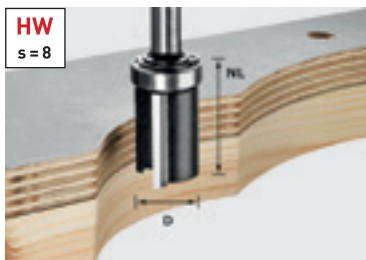

D	NL	GL	Alpha	s	RRP in €*	Order no.
19,05	25	62	0	8	47.90 57.48	491028

Accessories for edge trimming cutter HW

Ball bearing guide D19 (2x) Diameter 19 mm, Qty. in pack 2 Units	18.90 22.68	491396
--	-----------------------	--------



Turning plate edge trimming cutter HW with ball bearing guide, shank 8 mm

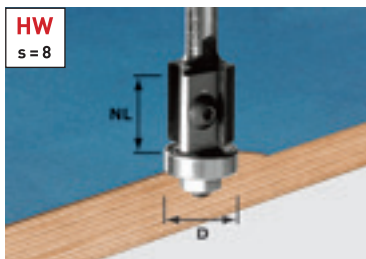

D	NL	GL	Alpha	s	RRP in €*	Order no.
19	20	64	0	8	94.50 113.40	491082
19	12	52	0	8	101.80 122.16	499806

Accessories for turning plate slot cutter HW

Ball bearing guide D19 (2x) Diameter 19 mm, Qty. in pack 2 Units	17.60 21.12	491385
Reversible blade HW-WP 20x12x1,5 (4x)	35.00 42.00	491392
Reversible blade HW-WP 12x12x1,5 (4x)	35.00 42.00	491391

Precision – even after sharpening.

When sharpening blunt edges on conventional cutters, the diameter aligned to the ball bearing guide normally decreases. This causes a ridge to form when edges are trimmed flush after the bit is sharpened. The turning plate slot cutter and ball bearing guide maintain a high level of precision.

Chamfer/edge trimming cutter with ball bearing guide, shank 8 mm

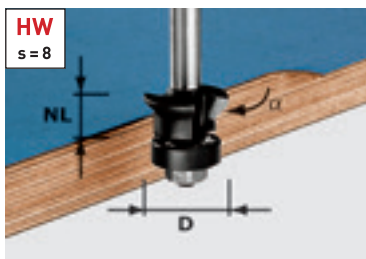

D	NL	GL	s	RRP in €*	Order no.
24	11	54	8	35.80 42.96	491026

One tool – three uses.

Flush trimming of protruding coatings at a right angle, with a 45° chamfer or even both in one working process. The plastic-coated ball bearing guide does not leave any marks and protects the edge of the workpiece.



Drilling cutter, rebating cutter, recessed grip/hand rail cutter

Drilling cutter HW, shank 8 mm

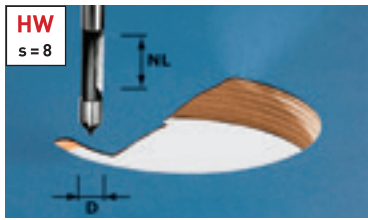

D	NL	GL	s	RRP in £*	Order no.
8	19	65	8	24.70 29.64	491037

Plunge – cut – finished.

The drilling cutter plunges directly into the laminate without requiring pre-drilling and trims the prepared contour flush when guided along the side face.

Turning plate rebating cutter with ball bearing guide, shank 8 mm



D	NL	GL	s	RRP in £*	Order no.
38	12	53,7	8	88.50 106.20	491085**

Amazingly versatile.

Change ball bearings to route to 5 different rebate depths with only one basic bit.

Accessories for turning plate rebating cutter					
Reversible blade HW-WP 12x12x1,5 (4x)	35.00 42.00	491391			
Ball bearing guide D9,5/12,7/16/19/22 Diameter 9,5; 12,7; 16; 19; 22 mm	49.80 59.76	491406			

Rebate depths for reversible blade rebating cutter (with ball bearing guide)

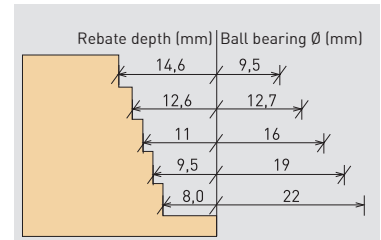

** Items included: ball bearing set, Ø 9.5 mm to Ø 22 mm

Rebating cutter HW with ball bearing guide, shank 8 mm

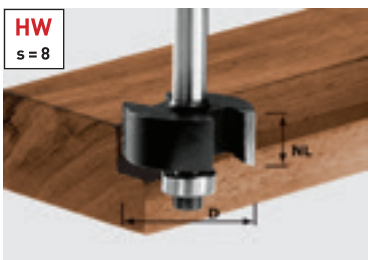

D	NL	GL	T1	s	RRP in £*	Order no.
31,7	12,7	54	9,5	8	43.90 52.68	491022***

Rebate depths for HW rebating cutter (with ball bearing)

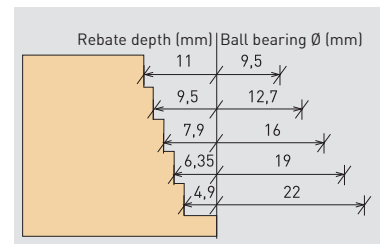

Accessories for rebating cutter HW					
Ball bearing guide D12,7 (2x) Diameter 12,7 mm, Qty. in pack 2 Units	12.40 14.88	491383			
Ball bearing guide D9,5/12,7/16/19/22 Diameter 9,5; 12,7; 16; 19; 22 mm	49.80 59.76	491406			

*** Items included: 1 ball bearing Ø 12.7 mm with 9.5 mm rebate depth

Recessed grip cutter HW with ball bearing guide, shank 8 mm



D	NL	GL	R	s	RRP in £*	Order no.
19	19	68	16	8	72.20 86.64	491033

Accessories for hand hole cutter HW					
Ball bearing guide D19 (2x) Diameter 19 mm, Qty. in pack 2 Units	18.90 22.68	491396			

Hand rail cutter HW, shank 8 mm

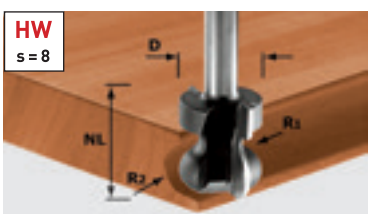

R1	R2	D	NL	GL	s	RRP in £*	Order no.
2,5	6	22	16	59	8	68.00 81.60	491140



Dovetail cutter, tongue and groove cutter

Dovetail cutter with pre-cutter, shank 8 mm



HW
s = 8

D	NL	GL	Alpha	s	RRP in €*	Order no.
14,3	13,5	46	15	8	39.70 47.64	490990

Perfect for dovetail joints.

It is possible to produce traditional open and hidden dovetail joints in no time at all using the appropriate router, template and router tool system.

Dovetail cutters, shank 8 mm

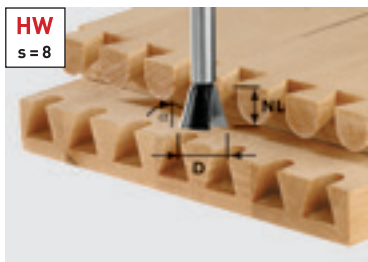

HW
s = 8

D	NL	GL	Alpha	s	RRP in €*	Order no.
13,8	13,5	46	15	8	34.10 40.92	490992 **
16	13,5	46	15	8	41.00 49.20	490993 **
20	17	49	15	8	38.60 46.32	490996 **
14,3	16	50	10	8	35.50 42.60	491164 ***
20	26	58	10	8	41.30 49.56	491165 ***



Dovetail cutters, shank 8 mm



HS
s = 8

D	NL	GL	Alpha	s	RRP in €*	Order no.
13,8	13,5	46	15	8	19.50 23.40	490991 **
20	17	49	15	8	29.20 35.04	490995 **

For use with jointing system VS 600:
** for partially covered dovetail joint
*** for open dovetail joint



Tongue and groove cutter HW, shank 8 mm



HW
s = 8

D	NL	GL	s	RRP in €*	Order no.
34	32	62	8	76.80 92.16	491034

Setting table for tongue and groove cutters

Wood thickness (1)	Height, Y dimension (2)	Stop, X dimension (3)
12	9,2	8,8
13	9,7	9,3
14	10,2	9,8
15	10,7	10,3
16	11,2	10,8
17	11,7	11,3
18	12,2	11,8
19	12,7	12,3
20	13,2	12,8
21	13,7	13,3

Mitre tongue and groove cutter, shank 12 mm

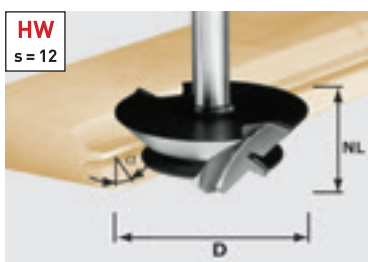

HW
s = 12

D	NL	GL	Alpha	s	RRP in €*	Order no.
△ 64	27	67	45	12	134.80 161.76	492709

△ n max. 22,000

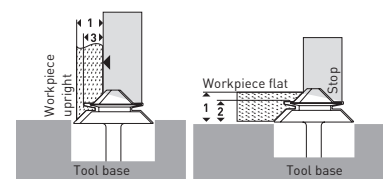

As both workpieces that are to be glued are to be processed in one cutter setting, the setting of the mitre tongue and groove cutter requires the precise adjustment of the stop and the table height. The graphic above and the settings table can be used for assistance. Nevertheless, readjustment may be necessary.

* Manufacturer's recommended retail price. Dealer prices may vary.
Excl. VAT. | Incl. VAT.

V-groove cutter, plasterboard V-groove cutter

V-groove cutter, shank 8 mm

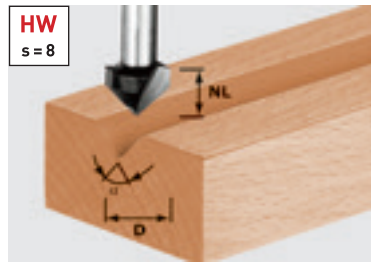

D	NL	GL	Alpha	s	RRP in £*	Order no.
14	7	50	90	8	30.60 36.72	490999

Ideal for decorative veining.

The V-groove cutter is the right choice for decorative veining on workpieces with flush joints – e.g. door frames, furniture frame joints and furniture components.

V-groove cutter, shank 8 mm

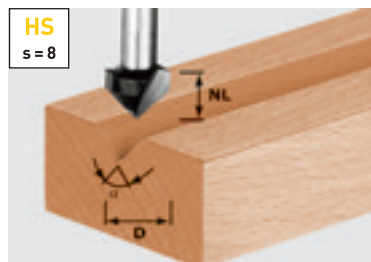

D	NL	GL	Alpha	s	RRP in £*	Order no.
14	7	50	90	8	14.30 17.16	490998
11	9,5	50	60	8	13.30 15,96	490997

V-groove cutter, for processing aluminium composite panels, shank 8 mm

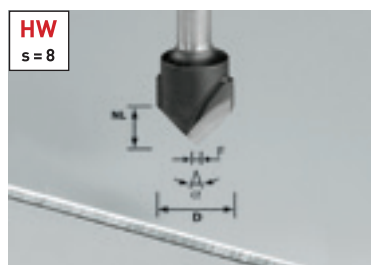

D	NL	GL	Alpha	s	RRP in £*	Order no.
18	3,3	59	135	8	57.20 68.64	491443
18	8	59	90	8	57.20 68.64	491444

Routing aluminium composite panels

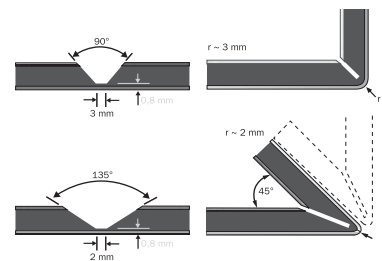

Cutter V groove HW, shank 8 mm



D	NL	GL	Alpha	s	RRP in £*	Order no.
12,5	14	55	45	8	41.00 49.20	491000**
32	16	49	90	8	53.70 64.44	491001

Routing and jointing instead of gluing and smoothing.

A 45° cutter for rebating 45° corner joints is now available in addition to the 90° plasterboard V-groove cutter.

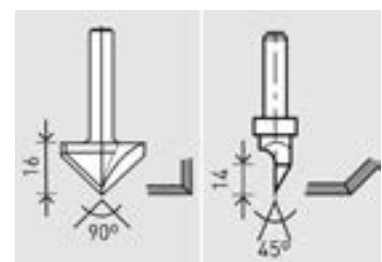

90° plasterboard V-groove cutter (Order no. 491001)

45° plasterboard V-groove cutter (Order no. 491000)

** single-edged tool

Disk groove cutter, hinge location cutter

Groove cutting disc HW, shank 8 mm

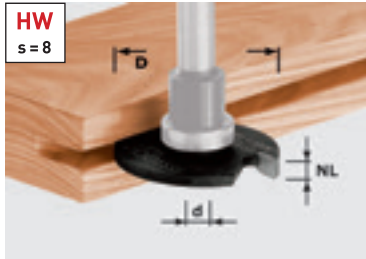

D	Dia.	NL	RRP in €*	Order no.
40	6	1,5	17.80 21.36	491038
40	6	2	18.90 22.68	491040
40	6	2,5	19.20 23.04	491056
40	6	3	19.90 23.88	491057
40	6	3,5	20.20 24.24	491058
40	6	4	20.70 24.84	491059
40	6	5	21.30 25.56	491060

3 different cutter spindles are available for use of the disc groove cutter from 1.5 mm to 5 mm groove width.

Cutter spindle 1 has a fixed shaft, which is not suitable as a thrust surface (fire hazard). Therefore, this cutter spindle is only intended for work with a side stop.

Cutter spindle 2 is equipped with a 16 mm ball bearing (above the disc slot), which serves as a thrust surface. With this cutter spindle, a groove depth of 12 mm results from the use of the 40 mm disc slot.

Cutter spindle 3 is equipped with a 28 mm ball bearing (above the disc slot), which serves as a thrust surface. With this cutter spindle, a groove depth of 6 mm results from the use of the 40 mm disc slot.

Cutter spindle for groove cutting disc HW, shank 8 mm

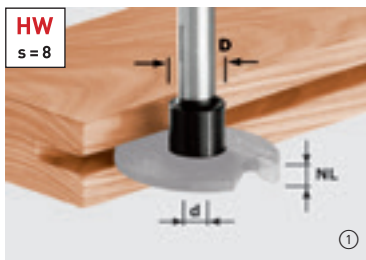

D	Dia.	GL	BB	RRP in €*	Order no.
14	6	49	①	17.50 21.00	499805
16	6	43	16 ②	22.70 27.24	499803
28	6	45	28	36.00 43.20	499804

Accessories for cutter spindle, shank 8 mm

Ball bearing guide D16 (2x) Diameter 16 mm, Qty. in pack 2 Units	②	21.20 25.44	491384
Ball bearing guide D28 (2x) Diameter 28 mm, Qty. in pack 2 Units		23.10 27.72	491397

For sealed doors.

A cutter spindle with ball bearing guide D 28 and disc groove cutter with a width of 4 mm are ideal for routing door seals in door frames.



HW hinge location cutter with HW chip breaker, shank 8 mm

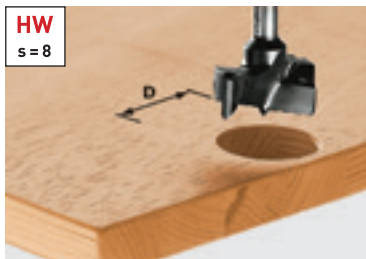

D	GL	s	RRP in €*	Order no.
15	54,5	8	41.00 49.20	491070
20	54,5	8	47.90 57.48	491072
25	54,5	8	54.60 65.52	491073
30	54,5	8	59.40 71.28	491075
34	54,5	8	60.40 72.48	491076
35	54,5	8	61.20 73.44	491077

Accurate dimensioning with System 32.

The LR 32 hole series system makes routing a row of holes for shelves and false floors amazingly simple. The holes for hinge fittings are also cut accurately between the holes on the System 32 grid.

Dowel drill, roman ogee cutter, multi-profile cutter, T-slot cutter

Dowel drill HW, shank 8 mm

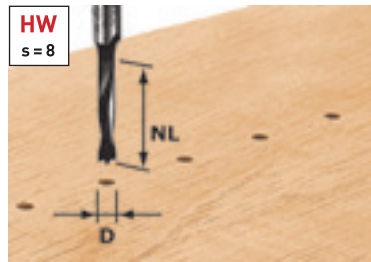

** without centre point

D	NL	GL	s	RRP in £*	Order no.
3	16	55	8	32.40 38.88	491065**
5	30	53,5	8	21.90 26.28	491066
6	30	53,5	8	22.50 27.00	491067
8	30	53,5	8	23.60 28.32	491068
10	30	53,5	8	26.10 31.32	491069

Versatile use.

The dowel drill HW is ideal for drilling rows of holes and combining with the dowel unit from jointing system VS 600.



Drill HW, shank 8 mm

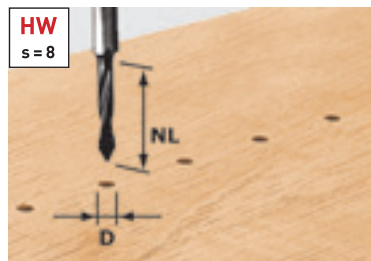

D	NL	GL	s	RRP in £*	Order no.
5	30	53,5	8	26.50 31.80	491064



Roman ogee point cutter HW with ball bearing guide, shank 8 mm

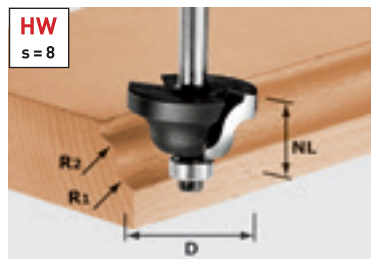

D	NL	GL	R1	R2	s	RRP in £*	Order no.
31,7	13	53	4	4	8	54.00 64.80	491029
38,1	19	59	6,35	6,35	8	61.60 73.92	491030

Accessories for double radius cutter

Ball bearing guide D12,7 (2x) Diameter 12,7 mm, Qty. in pack 2 Units	12.40 14.88	491383
--	-----------------------	--------

Multi-profile cutter HW with ball bearing guide, shank 8 mm

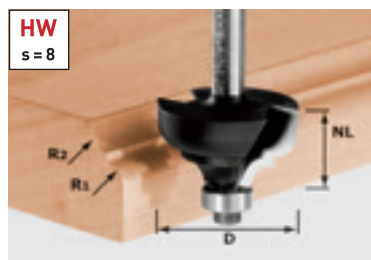

D	NL	GL	R	s	RRP in £*	Order no.
36,7	21	61	6	8	66.40 79.68	491031

Accessories for multi-profile cutter

Ball bearing guide D12,7 (2x) Diameter 12,7 mm, Qty. in pack 2 Units	12.40 14.88	491383
--	-----------------------	--------

Key-hole cutter HW, shank 8 mm

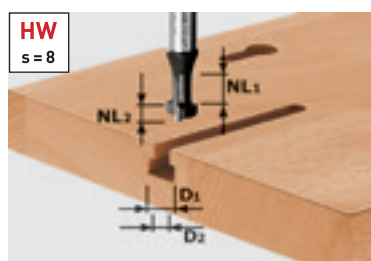

D1	D2	NL1	NL2	GL	s	RRP in £*	Order no.
10,5	6	8	5	50	8	30.60 36.72	491035

Excellent for special tasks.

For cutting T-grooves, shaped holes and keyhole mountings in solid wood and panel material.

Profile cutter, counterprofile cutter, profile tongue cutter, profile groove cutter

Profile cutter HW, shank 8 mm

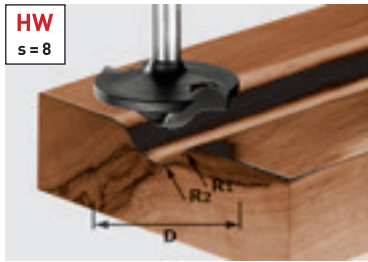

D	NL	GL	R1	R2	s	RRP in €*	Order no.
42	13	50	6	12	8	67.60 81.12	491137



Counterprofile cutter spring HW with ball bearing guide, shank 8 mm



D	NL	B	R	s	RRP in €*	Order no.
43	21	5	16	8	98.90 118.68	491130

Accessories for counterprofile cutter, tongue

Ball bearing guide D16 (2x) Diameter 16 mm, Qty. in pack 2 Units	21.20 25.44	491384
--	-----------------------	--------

Framed doors with counterprofile and panelling.

Whether you wish to produce traditional profiles or modern shapes – adjusting the cutting rings is simple with the ball bearing guide.

Counterprofile cutter groove HW with ball bearing guide, shank 8 mm

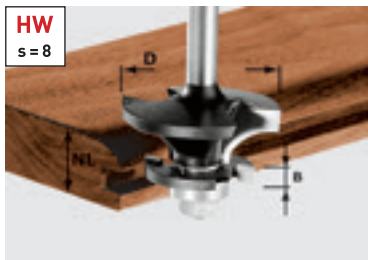

D	NL	B	R	s	RRP in €*	Order no.
43	21	5	16	8	98.90 118.68	491129

Accessories for counterprofile cutter groove HW

Ball bearing guide D16 (2x) Diameter 16 mm, Qty. in pack 2 Units	21.20 25.44	491384
--	-----------------------	--------

Profile/spring cutter HW with ball bearing guide, shank 8 mm

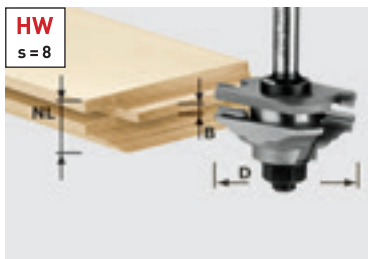

D	NL	B	R	s	RRP in €*	Order no.
46	20	4	22	8	167.30 200.76	490643

For classic furniture fronts.

You can cut classic framed doors in differing styles using these tool sets. The double-edged carbide tools achieve a clean, even routing pattern.

Profile/groove cutter HW with ball bearing guide, shank 8 mm



D	NL	B	R	s	RRP in €*	Order no.
46	20	4	22	8	167.30 200.76	490645



* Manufacturer's recommended retail price. Dealer prices may vary.
Excl. VAT. | Incl. VAT.

Facing cutter, handrail cutter, aluminium cutter

Facing cutter HW, shank 8 mm

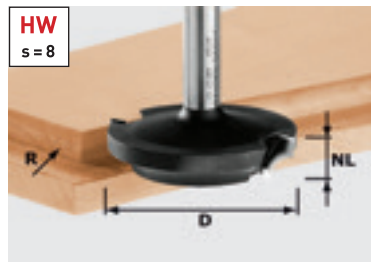

D	NL	GL	R	s	RRP in £*	Order no.
42,7	13	50	6	8	65.20 78.24	491138

Facing and counterprofiling all in one.
You can use this tool to cut the panelling and the frame and produce complete fronts in combination with a disc groove cutter.



Facing cutter HW, shank 12 mm

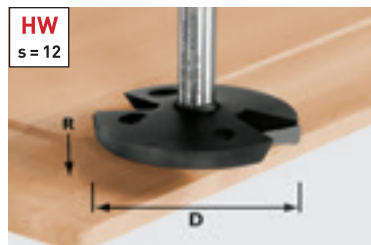

D	NL	GL	R	s	RRP in £*	Order no.
△ 68	14	58	35	12	129.10 154.92	492712
△ n max. 22,000						



Facing cutter without ball bearing:
for deeper tapers.

HW hand rail cutter, shank 12 mm

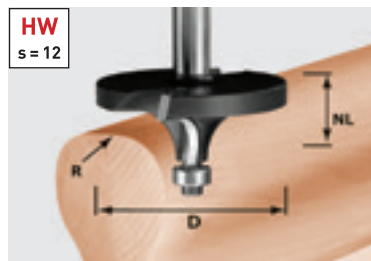

D	NL	R	s	RRP in £*	Order no.
△ 64	26	16	12	123.40 148.08	492710
△ n max. 22,000					

Accessories for HW hand rail cutter

Ball bearing guide D12,7 (2x) Diameter 12,7 mm, Qty. in pack 2 Units	12.40 14.88	491383
--	----------------	--------

Bench-mounted router TF 2200

The CMS with OF 2200 router is ideal for cutting workpieces with larger diameters and always provides a secure support surface during routing.

Hand rail cutter HW Profile, shank 12 mm

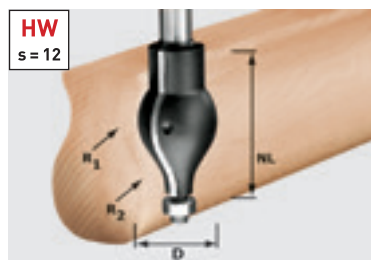

D	NL	R1	R2	s	RRP in £*	Order no.
△ 32	57	20	16	12	116.90 140.28	492711
△ n max. 22,000						

Accessories for HW hand rail cutter

Ball bearing guide D12,7 (2x) Diameter 12,7 mm, Qty. in pack 2 Units	12.40 14.88	491383
--	----------------	--------



Aluminium cutter HS, shank 8 mm

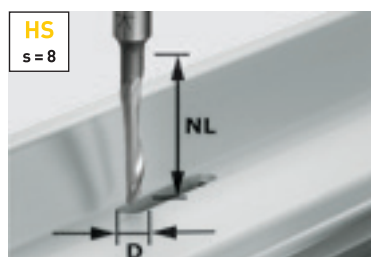

D	NL	GL	s	RRP in £*	Order no.
5	23	65	8	14.30 17.16	491036

The aluminium specialist.

The HS aluminium cutter is designed for routing water drainage channels in aluminium profiles up to 2 mm thick.

Script cutter

Script cutter, shank 8 mm

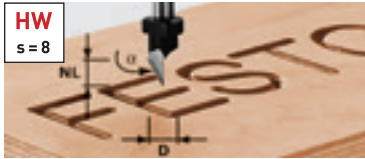

D	NL	GL	Alpha	s	RRP in €*	Order no.
11	9,5	55	60	8	41.00 49.20	491003

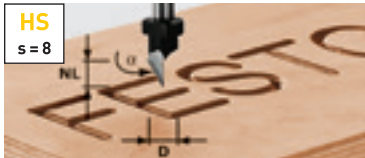

D	NL	GL	Alpha	s	RRP in €*	Order no.
11	9,5	55	60	8	32.90 39.48	491002

Cutter tools for OFK 500 and putty router KF 5

Roundover cutter, without ball bearing guide

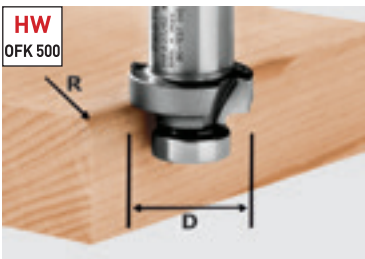

D	R	RRP in €*	Order no.
27	2	54.80 65.76	490092
27	3	54.80 65.76	490093
27	4	59.40 71.28	490094
27	5	64.00 76.80	490095
27	6	64.00 76.80	490096



Rounding plastic or solid wood veneer.

Accessories for cutters OFK 500

Ball bearing guide KLS-D 15,8-OFK for cutter 490090, 490091, 490092, 490093, 490094, 490095, 490096, 491533, with clamping screw	17.20 20.64	490249
--	-----------------------	--------

Chamfer cutter, without ball bearing guide

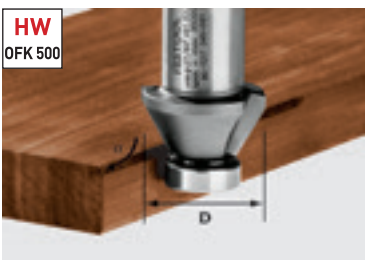

D	Alpha	RRP in €*	Order no.
27	60	49.00 58.80	491533
27	45	49.00 58.80	490090
27	30	49.00 58.80	490091



Chamfering plastic or solid wood veneer.

Accessories for cutters OFK 500

Ball bearing guide KLS-D 15,8-OFK for cutter 490090, 490091, 490092, 490093, 490094, 490095, 490096, 491533, with clamping screw	17.20 20.64	490249
--	-----------------------	--------

Edge trimming cutter, with ball bearing guide

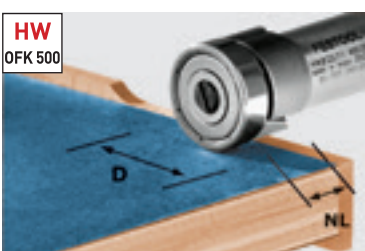

D	NL	s	RRP in €*	Order no.
22	8	8	61.20 73.44	490565
22	8	8	49.00 58.80	490085**

Accessories for cutters OFK 500

Ball bearing guide KLS-D22-OFK for cutter 490085, with clamping screw	19.50 23.40	490250
---	-----------------------	--------



Flush trimming of plastic or solid wood veneer.

** Flush trim cutter without ball bearing

* Manufacturer's recommended retail price. Dealer prices may vary.
Excl. VAT. | Incl. VAT.

Cutter tools for OFK 700 and MFK 700

Turning plate edge trimming cutter HW, shank 8 mm



D	NL	GL	Alpha	s	RRP in £*	Order no.
19	12	52	0	8	101.80 122.16	499806

Accessories for turning plate edge trimming cutter

Reversible blade HW-WP 12x12x1,5 (4x)	35.00 42.00	491391
Ball bearing guide D19 (2x) Diameter 19 mm, Qty. in pack 2 Units	17.60 21.12	491385

Can be used with or without ball bearing.

The recently developed ball bearing attachment system allows you to use trimming cutters with or without a ball bearing guide. Any tool with a ball bearing or external guide system (on the OFK 700, for example) is compatible.

Turning plate chamfer cutter HW, shank 8 mm



D	NL	GL	Alpha	s	RRP in £*	Order no.
27	8	55	45	8	101.80 122.16	499807

Accessories for turning plate chamfer cutter HW

Ball bearing guide D12,7 (2x) Diameter 12,7 mm, Qty. in pack 2 Units	12.40 14.88	491383
Reversible blade HW-WP 12x12x1,5 (4x)	35.00 42.00	491391

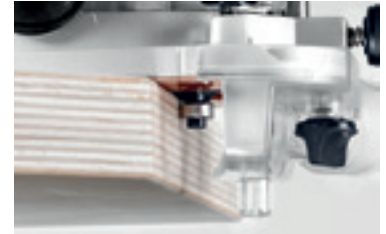

Chamfer cutter HW, shank 8 mm



D	NL	GL	Alpha	s	RRP in £*	Order no.
18	11	50	15	8	45.50 54.60	499801
25	11	50	30	8	46.30 55.56	499800
26	7	48	45	8	49.10 58.92	499799

Accessories for chamfer cutter HW

Ball bearing guide D12,7 (2x) Diameter 12,7 mm, Qty. in pack 2 Units	12.40 14.88	491383
--	-----------------------	--------



Classic ogee cutter HW, shank 8 mm



D	NL	GL	R	s	RRP in £*	Order no.
20	2,2	47	2	8	52.30 62.76	499798
22	3,2	48	3	8	53.20 63.84	499797

Accessories for HW classic ogee cutter

Ball bearing guide D12,7 (2x) Diameter 12,7 mm, Qty. in pack 2 Units	12.40 14.88	491383
--	-----------------------	--------



Router table 0° for straight routing.
Order no. 491427.

Cutter tools for OFK 700 and MFK 700

Roundover cutter with reversible blades

HW
s = 8

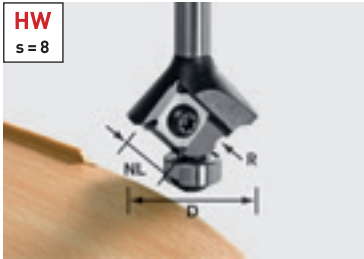

D	NL	GL	R	s	RRP in €*	Order no.
28	3	55	1	8	113.50 136.20	499811
28	3	55	1,5	8	113.50 136.20	499810
28	3	55	2	8	113.50 136.20	499809
28	3	55	3	8	113.50 136.20	499808

Accessories for classic ogee cutter HW with reversible blades

Replacement cutters HW-WP R3 D28 KL12,70FK for Wepla roundover cutters 499808, reversible blades can be used 4 times, R 3 mm, Diameter 28 mm, Ball bearing 12,7 mm	65.70 78.84	500369
Replacement cutters HW-WP R2 D28 KL12,70FK for Wepla roundover cutters 499809, reversible blades can be used 4 times, Ball bearing 12,7 mm, Diameter 28 mm, R 2 mm	65.70 78.84	500370
Replacement cutters HW-WP R1,5 D28 KL12,70FK for Wepla roundover cutters 499810, reversible blades can be used 4 times, Ball bearing 12,7 mm, Diameter 28 mm, R 1,5 mm	65.70 78.84	500371
Replacement cutters HW-WP R1 D28 KL12,70FK for Wepla roundover cutters 499811, reversible blades can be used 4 times, Ball bearing 12,7 mm, Diameter 28 mm, R 1 mm	65.70 78.84	500372
Ball bearing guide D12,7 (2x) Diameter 12,7 mm, Qty. in pack 2 Units	12.40 14.88	491383

Ideal for routing edging: The MFK 700 Basic edge router with spring-loaded ball bearing guide brake and chip deflector, designed specially for machining the most delicate of edging without leaving behind marks.



Edge trimming cutter HW, shank 8 mm

HW
s = 8



D	NL	GL	s	RRP in €*	Order no.
19	16	46	8	38.20 45.84	491666



You can find a comprehensive selection of slot cutters specially designed for routing and cutting slots for edging on page 241. The cutter spindle is required for this application.

HW plane cutter for MFK 700 EQ/B-Plus module edge router, shank 8 mm

HW
s = 8

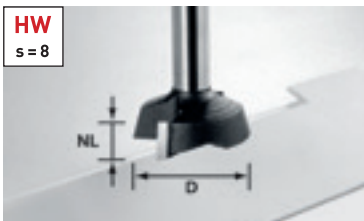

D	NL	GL	Alpha	s	RRP in €*	Order no.
28	7	40	15	8	76.60 91.92	500368



Specialised cutters for solid surface and mineral materials

Reservoir cutter HW with ball bearing guide, Shank 12 mm

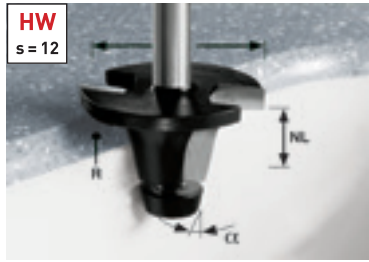

D	NL	R	Alpha	s	RRP in £*	Order no.
45	25	6,35	6	12	111.00 133.20	492671

Accessories for basin cutter with ball bearing guide

Ball bearing guide D21,1/6° for router 6°, Diameter 21,1 mm	22.90 27.48	493061
Ball bearing guide D12,7 Alpha 6°, Diameter 12,7 mm	16.40 19.68	491398

Simply ingenious.

If the cutting blade is not aligned with the ball bearing guide exactly after sharpening, the join to the cutter blade can be readjusted by moving the axial ball bearing guide, extending the service life of your Festool basin cutters even longer.



Adjustable axial ball bearing guide on the basin cutter

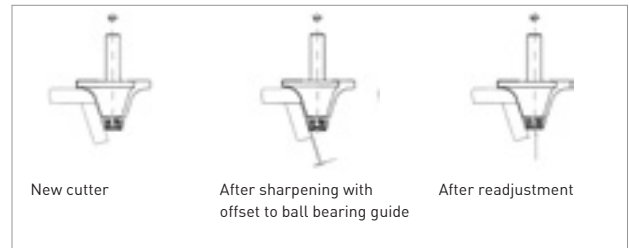

Carbide-tipped facing cutter, Shank 12 mm



D	NL	R	s	RRP in £*	Order no.
52	7,3	1,5	12	84.00 100.80	492701

To suit any task.

Flat protruding edges, e.g. pilaster strip inserts, can be trimmed flush without any problem using the plane cutter.

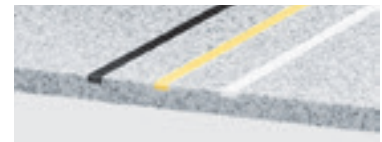

Reversible blade groove cutter HW, Shank 12 mm

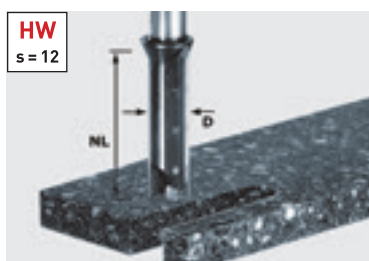

D	NL	GL	s	RRP in £*	Order no.
14	45	105	12	176.50 211.80	491110**

Accessories for turning plate groove cutter

Reversible blade HM-WP 50x5,5x1,1 (4x)	80.20 96.24	491389
---	-----------------------	--------

** also suitable for use with OF 2200 and worktop template APS 900

Extremely resistant to breaking and very efficient.

Solid carbide spiral groove cutters are manufactured from cylindrical rods of carbide specially developed for machining mineral materials and particularly resistant to breaking.

Specialised cutters for solid surface and mineral materials

Spiral groove cutter with roughing and finishing, TC, Shank 12 mm

HW
s = 12

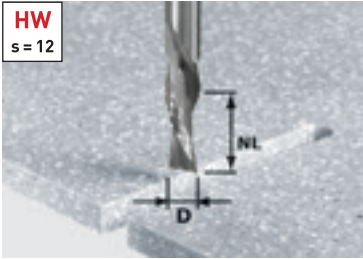

D	NL	GL	s	RRP in €*	Order no.
12	42	87	12	124.70 149.64	492656

For fast working progress.

Solid carbide cutters specially designed for routing cut-outs for basins, for example.



Turning plate edge trimming cutter HW with ball bearing guide, Shank 12 mm

HW
s = 12

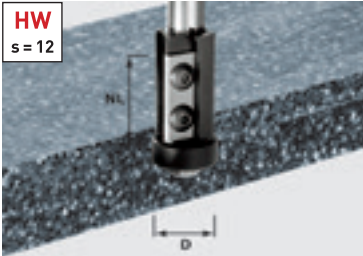

D	NL	GL	s	RRP in €*	Order no.
21	30	89	12	122.40 146.88	491120

Accessories for turning plate edge trimming cutter

Reversible blade HW-WP 30x12x1,5 (4x) for 492716, 492717, 491120 cutters, main plate	57.20 68.64	491393
Ball bearing guide D21-15,88 (2x) Diameter 21 mm, Qty. in pack 2 Units	43.50 52.20	491408

Precise and durable.

Mineral materials are very demanding on the cutting blade. When working with the ball bearing guide, it is absolutely vital that the cutter and ball bearing guide are permanently aligned. This is why tools with reversible blades pay dividends within a very short time.



Edge trimming cutter with ball bearing, bottom, Shank 12 mm

HW
s = 12

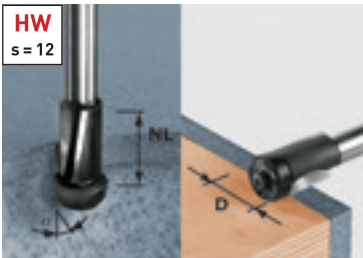

D	NL	s	RRP in €*	Order no.
19	25	12	75.10 90.12	492661

Accessories for edge trimming cutter with ball bearing, bottom

Ball bearing guide D19 Diameter 19 mm	20.80 24.96	493055
Ball bearing guide D22/11° Diameter 22 mm	23.80 28.56	493056

Two tools in one.

Cutting intlays flush or routing overhangs on fitted basins at an angle of 11°. Both are possible simply by changing the ball bearing guide included in the delivery.

Both replacement ball bearing guides are included in delivery



09 Joining





244 DOMINO joining machines

247 DOMINO connector



247 DOMINOs

More precise joints.

The DOMINO joining machines.

Unique among manual machines and patented by Festool: The DOMINO DF 500 jointer routing motion. The simultaneous rotating and pendulum movement of the router allows smooth working and holes without scorch marks. Thanks to the pendulum motion, the routers do not overheat, leading to an extremely long tool life.

Joining machine **DF 500 Q-Plus**

The DOMINO DF 500 is particularly easy to handle and offers almost unlimited jointing possibilities. No matter whether it is panel or cabinet construction, for lightweight frame or rack joints – the DF 500 impresses with maximum precision, flexibility and simple handling.



Joining machine **DF 700 EQ-Plus**

Comes to the workpiece and not vice versa: DOMINO XL. Quick, simple, precise and extremely stable – with measurably shorter tooling times and up to 50% time-saving in comparison to stationary machines. The DOMINO XL is therefore ideally suited for furniture and door construction and solid wood joints.



Innovative stop system

One of the main time-based advantages of working with the DOMINO joiner arises from working without complicated measuring or marking. With the DOMINO DF 500, the fast and precise positioning is quite simple thanks to the stop catches; with the DF 700 this is enabled by stop pins.



Long-hole principle

Custom-fit alignment: The first DOMINO is positioned in a precision cut elongated hole, the next DOMINOs are inserted into wider elongated holes with play so that the joint can be aligned effortlessly. The result is a stable joint, protected against rotation from the first DOMINO.



Routing height and angle setting

Time-saving and precise adjustment of the routing height and angle: For precise mitre routing and processing various material thicknesses. Using presettings or infinite routing angle adjustment.



Save time when using the same cutting depth over and over again

You select your required routing depth using the detent lever lock on the DF 500. The options are 12 mm, 15 mm, 20 mm, 25 mm and 28 mm. On the DF 700, you can use the variable routing depth setting to select between 15–70 mm and set two freely selectable “flag” positions.

The right solution for every combination.
The DOMINO system.



Create robust joints quickly and simply with the DOMINO connectors – and loosen them again when required. Perfect for corner and surface joints, and now also for centre panel joints and joints between series of holes. The cover caps in various colours provide the perfect finishing touch.

You can find more information on page 247





Technical data	DF 500	DF 700
Power consumption (watt)	420	720
Idle engine speed (RPM)	25.500	21.000
Depth stop for routing depth (mm)	12, 15, 20, 25, 28	15 – 70
Max. routing depth (mm)	28	70
DOMINO slot cutter dia. (mm)	4, 5, 6, 8, 10	8, 10, 12, 14
Routing height adjustment (mm)	5 – 30	10 – 50
Mitre routing (°)	0 – 90	0 – 90
Dust extraction connection dia. (mm)	27	27
Weight (kg)	3,2	5,2

Items included	RRP in £*	Order no.
DF 500 All variants: DOMINO cutter D5, Additional stop, open ended spanner, WAF 8, Systainer SYS3 M 187		
 DF 500 Q-Plus 110V	760.00 912.00	576417
DF 500 Q-Plus 240V	760.00 912.00	576415
DF 500 Q-Set 240V trim stop, cross stop	836.00 1,003.20	576422
DF 700		
 DF 700 EQ-Plus 240V DOMINO cutter D 12, Additional stop, empty dowel box, open ended spanner, WAF 12, Systainer SYS3 M 437	1,052.00 1,262.40	576427

Perfect connections made easy. The DOMINO family at a glance.

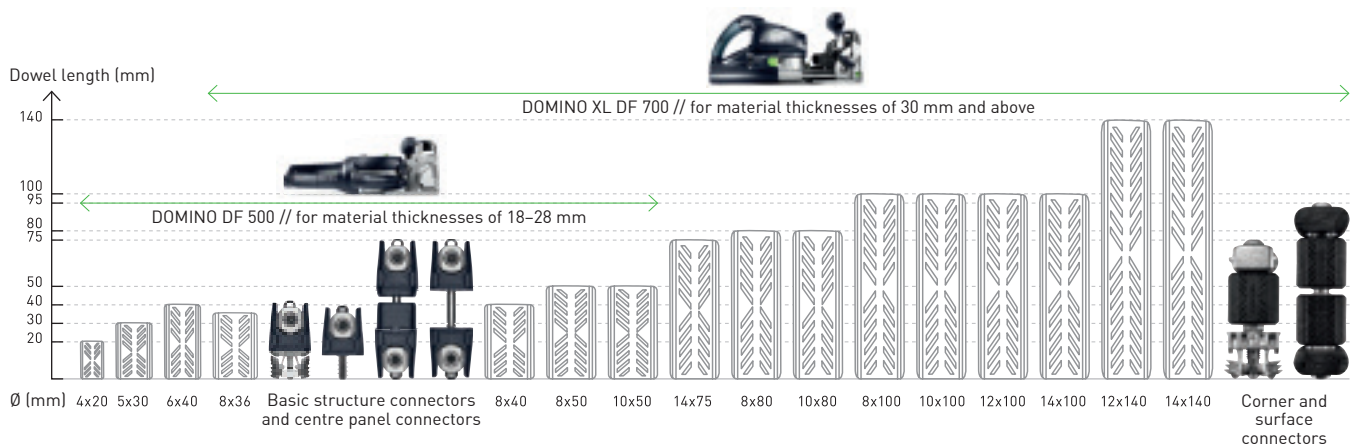

Every wooden joint has its advantages. The DOMINO jointing system combines them all.

DOMINO dowels made from beech and sipo



Responsible forest management: All DOMINOs originate from sustainable forest management and other controlled sources. They bear the Forest Stewardship Council™ (FSC™) seal, which means that all stages along the supply chain are FSC-certified. Look for products that are FSC-certified.



DOMINO dowels made from sipo are resistant to weather, insects and mould, making them ideal for outdoor applications.

Basic structure connectors and furniture connectors for the DOMINO DF 500 joining machine



Corner connector –
for DOMINO/LR 32 joint



Corner connector –
for DOMINO/DOMINO joint



Centre panel connector –
for DOMINO/LR 32 joint



Centre panel connector –
for DOMINO/DOMINO joint

Corner and surface connectors for the DOMINO XL DF 700 joining machine



Corner connector



Flat connectors











Surface connector with extension clips –
specially for materials such as kitchen worktops





Accessories for joining machine DF 500		RRP in £*	Order no.
DOMINO router All variants: for DF 500			
	D 4-NL 11 HW-DF 500 D 4 mm, NL 11 mm	35.20 42.24	495663
	D 5-NL 20 HW-DF 500 D 5 mm, NL 20 mm	30.00 36.00	493490
	D 6-NL 28 HW-DF 500 D 6 mm, NL 28 mm	30.70 36.84	493491
	D 8-NL 28 HW-DF 500 D 8 mm, NL 28 mm	32.00 38.40	493492
	D 10-NL 28 HW-DF 500 D 10 mm, NL 28 mm	35.90 43.08	493493
	Cross stop QA-DF 500/700 for DF 500 and DF 700, for repeat hole spacing between 100 and 205 mm, items included: A left and right cross stop, for precise positioning of milling grooves 100-205 mm away from edges	48.40 58.08	498590
	Trim stop LA-DF 500/700 for DF 500 and DF 700, for strip material with widths between 22 and 70 mm	45.60 54.72	493487
	Handrail fence RA DF 500/700 for DF 500 and DF 700, for round wooden poles, dia. 35 – 60 mm, for precise routing of round poles Ø 35 – 60 mm	38.20 45.84	494847
	Additional stop ZA-DF 500 for DF 500 and DF 700, support widener and side stop, for reducing the dowel centre from 37 mm to 20 mm, for secure positioning of the router	22.70 27.24	495666
Corner connection All variants: 50 x Plastic trays, 50 x Cross anchor with threaded pin, without cover caps, qty. in pack 50 Units, joint fixture (8 mm DOMINO dowel cross-cuts) D8, DOMINO routing depth for base part 28 mm, drilling diameter in base part 15 mm, panel thickness 18 – 28 mm			
	KV D8/50 for 50 corner joints with the DF 500, the DOMINO/DOMINO KV D8/50 connector is positioned both in the cupboard panel and the base of the structure with the DOMINO jointer DF 500, 50 x Split anchor, 50 x Bolt with M4 thread, DOMINO routing depth for side part 15 mm	93.00 111.60	203166
	KV-LR32 D8/50 for 50 corner joints with the DF 500 and drilling series of holes, the DOMINO/LR 32 KV-LR 32 D8/50 connector is positioned both in the cupboard panel in a 5 mm hole in the series of holes and the base of the structure with the DOMINO jointer DF 500, Split anchor, 50 x Bolt with Euro thread for drilling series of holes, drilling diameter for Euro bolt 5 mm	74.00 88.80	203168
Centre panel connector All variants: drill template is required for drilling holes in the surface of the DOMINO D 8 mm joint fixture, 50 x Plastic trays, 50 x Cross anchor with threaded pin, without cover caps, qty. in pack 25 Units, joint fixture (8 mm DOMINO dowel cross-cuts) D8, DOMINO routing depth for base part 28 mm, drilling diameter in base part 15 mm, panel thickness 18 – 28 mm			
	MSV D8/25 for 25 centre panel joints with the DF 500, the DOMINO/DOMINO MSV D8/25 connector is positioned both in the cupboard panel and the base of the structure with the DOMINO jointer DF 500, 25 x bolt with external thread for DOMINO centre panel connector, 25 x bolt with internal thread for DOMINO centre panel connector, DOMINO routing depth for side part 15 mm	65.70 78.84	203167
	MSV-LR32 D8/25 for 25 centre panel joints with the DF 500 and drilling series of holes, the DOMINO/LR 32 MSV-LR 32 D8/25 connector is positioned both in the cupboard panel in a 5 mm hole in the series of holes and the base of the structure with the DOMINO jointer DF 500, 25 x Bolt with external thread for centre panel connector, 25 x Bolt with internal thread for centre panel connector, drilling diameter for Euro bolt 5 mm	59.20 71.04	203169
	Hinge location cutter KVB-HW D15 CE for DF 500, 15 mm hinge location cutter is required for drilling holes in the surface of the DOMINO D 8 mm joint fixture, Shaft mount: CENTROTEC, the drill bit is adapted to the Festool drill template (203164), depth stop, drill bit dia. 15 mm	46.80 56.16	203165
	Drilling template BS-KV D15 for DF 500, drill template is required for drilling holes in the surface of the DOMINO D 8 mm joint fixture, adapted to Festool D15 hinge location cutter (203165), drill guide dia. 15 mm, panel thickness 18 – 28 mm	63.90 76.68	203164
	DOMINO connector range KV-SYS D8 DOMINO/DOMINO KV D8 basic structure connector, DOMINO/LR32 KV-LR32 D8 basic structure connector, DOMINO/DOMINO MSV D8 centre panel connector, DOMINO/LR32 MSV-LR32 D8 centre panel connector, 50 light brown cover caps, KV-AK D15 brn, 50 silver cover caps, KV-AK D15 slr, 50 white cover caps, KV-AK D15 wht, 50 grey cover caps, KV-AK D15 gr, DOMINO D 8 x 36 mm, BS-KV D15 drill template, KVB-HW D15 CE hinge location cutter, Screwdriver, Systainer SYS3 M 137	352.20 422.64	576797

Accessories for joining machine DF 500		RRP in £*	Order no.
Cover cap All variants: for DF 500, for covering the DOMINO D 8 mm joint fixture, qty. in pack 50 Units			
	KV-AK D15 brn/50 colour: Light brown	5.90 7.08	203171
	KV-AK D15 wht/50 white	5.90 7.08	203173
	KV-AK D15 gr/50 Colour: grey	5.90 7.08	203174
	KV-AK D15 slr/50 colour: Lacquered silver	10.80 12.96	203172
Accessories for joining machine DOMINO XL DF 700		RRP in £*	Order no.
DOMINO router All variants: for DF 700, routing tools with threaded supports for the DOMINO joining machine XL DF 700			
	D 8-NL 50 HW-DF 700 D 8 mm, NL 50 mm	43.50 52.20	497868
	D 10-NL 70 HW-DF 700 D 10 mm, NL 70 mm	46.40 55.68	497869
	D 12-NL 70 HW-DF 700 D 12 mm, NL 70 mm	48.40 58.08	497870
	D 14-NL 70 HW-DF 700 D 14 mm, NL 70 mm	51.90 62.28	497871
	Cross stop QA-DF 500/700 for DF 500 and DF 700, for repeat hole spacing between 100 and 205 mm, items included: A left and right cross stop, for precise positioning of milling grooves 100-205 mm away from edges	48.40 58.08	498590
	Trim stop LA-DF 500/700 for DF 500 and DF 700, for strip material with widths between 22 and 70 mm	45.60 54.72	493487
	Handrail fence RA DF 500/700 for DF 500 and DF 700, for round wooden poles, dia. 35 – 60 mm, for precise routing of round poles Ø 35 – 60 mm	38.20 45.84	494847
	Systainer³ SORT-SYS3 M 187 DOMINO empty SYS3 M 187 Systainer, contains three boxes with reconfigurable compartments for individual filling of DOMINOs, dimensions with adjustable legs (L x W x H) 396 x 296 x 187 mm, inner dimensions (L x W x H) 389 x 275 x 146 mm, volume 15,9 l	73.20 87.84	576793
	Anchor bolt SV-AB D14/32 for processing using the DOMINO XL DF 700 joining machine, corner connectors for frame and rack joints at material thicknesses of 30 mm or higher, in conjunction with SV-SA D14 split anchors and SV-QA D14 cross anchors for creating corner connections, 64 x dowel half-shells, qty. in pack 32 Units	41.80 50.16	201350
	Split anchor SV-SA D14/32 for processing using the DOMINO XL DF 700 joining machine, corner connectors for frame and rack joints at material thicknesses of 30 mm or higher, in conjunction with SV-AB D14 anchor bolts and SV-QA D14 cross anchors for creating detachable corner connections, qty. in pack 32 Units	29.60 35.52	201349
	Cross anchor SV-QA D14/32 for processing using the DOMINO XL DF 700 joining machine, at a material thickness of 30 mm or higher, acts as a counter bearing and tightening element for anchor bolts or double-headed bolts, with soft or porous material such as chipboard, the use of the cross anchor expander SV-V D14 is recommended (for material thickness 35 mm and greater – stops the cross anchor being pulled into the material), in conjunction with SV-SA D14 split anchors and SV-AB D14 anchor bolts for creating corner connections, in conjunction with SV-DB D14 double-headed bolts for creating flat connections, 32 x set screws, qty. in pack 32 Units	29.60 35.52	201351
	Extension table SV-V D14/32 for SV-QA D14 cross anchors, for processing cross anchors for improved pressure distribution for applications in porous or soft materials such as kitchen worktops, prevents the cross anchor being drawn into the material, 64 half-shells for widening 32 cross anchors, qty. in pack 32 Units	12.50 15.00	201498
	Double-headed bolt SV-DB D14/16 for processing using the DOMINO XL DF 700 joining machine, in conjunction with 2x SV-QA D14 cross anchors (and optional SV-V D14 widening clips for soft materials) for creating flat connections in furniture manufacturing, 64 x dowel half-shells, qty. in pack 16 Units	31.60 37.92	201352

* Manufacturer's recommended retail price. Dealer prices may vary.
 Excl. VAT. | Incl. VAT.

09 Joining

Accessories for joining machine DOMINO XL DF 700		RRP in £*	Order no.
Cover cap All variants: for processing using the DOMINO XL DF 700 joining machine, plastic cover caps for closing D14 dowel cross-cuts, qty. in pack 32 Units			
	SV-AK D14 slr/32 colour: Lacquered silver	9.10 10.92	201354
	SV-AK D14 brn1/32 colour: Dark brown	5.80 6.96	201355
	SV-AK D14 brn2/32 colour: Light brown	5.80 6.96	201356
Connector set All variants: 32 cross anchors, SV-QA D14			
	FV/16-Set surface connectors, complete set for 16 surface connections consisting of double-headed bolts, cross anchors and wideners, 16 double-headed bolts, SV-DB D14, SV-V D14 widener for 32 cross anchors	75.00 90.00	203421
	EV/32-Set corner connectors for frame and rack joints at material thicknesses of 30 mm or higher, complete set consisting of anchor bolts, split anchors and cross anchors for 32 corner connectors, 32 anchor bolts, SV-AB D14, 32 split anchors, SV-SA D14	102.90 123.48	203420
	DOMINO connector range SV-SYS D14 for processing using the DOMINO XL DF 700 joining machine, includes corner connectors and flat connectors incl. cover caps and DOMINO wooden dowels, required accessories: DOMINO cutter D 14 (497871), WAF 4 pin wrench for tightening the set screws, 32 anchor bolts, SV-AB D14, 12 x double-headed bolts, SV-DB D14, 32 split anchors, SV-SA D14, DOMINO birch D 14 x 75, 56 x cross anchors, SV-QA D14, SW 4 pin key, 48 x SV-V D14 width extension table for cross anchors, 32 cover caps, silver, SV-AK D14 slr, 32 cover caps, dark brown, SV-AK D14 brn1, 32 cover caps, light brown, SV-AK D14 brn2, Systainer SYS3 M 137	227.80 273.36	576795
DOMINO beech		RRP in £*	Order no.
DOMINO, beech All variants: material: Beech, FSC™-certified			
	D 4x20/450 BU for DF 500, qty. in pack 450 Units, dimensions 4 x 20 mm	14.00 16.80	495661
	D 5x30/300 BU for DF 500, qty. in pack 300 Units, dimensions 5 x 30 mm	14.00 16.80	494938
	D 5x30/1800 BU for DF 500, qty. in pack 1.800 Units, dimensions 5 x 30 mm	74.70 89.64	493296
	D 6x40/190 BU for DF 500, qty. in pack 190 Units, dimensions 6 x 40 mm	14.00 16.80	494939
	D 6x40/1140 BU for DF 500, qty. in pack 1.140 Units, dimensions 6 x 40 mm	74.70 89.64	493297
	D 8x36/130 BU for DF 500, dimensions 8 x 36 mm, qty. in pack 130 Units	14.00 16.80	203175
	D 8x40/130 BU for DF 500, qty. in pack 130 Units, dimensions 8 x 40 mm	14.00 16.80	494940
	D 8x40/780 BU for DF 500, qty. in pack 780 Units, dimensions 8 x 40 mm	74.70 89.64	493298
	D 8x50/100 BU for DF 500, qty. in pack 100 Units, dimensions 8 x 50 mm	14.00 16.80	494941
	D 8x50/600 BU for DF 500, qty. in pack 600 Units, dimensions 8 x 50 mm	74.70 89.64	493299
	D 10x50/85 BU for DF 500, qty. in pack 85 Units, dimensions 10 x 50 mm	14.00 16.80	494942
	D 10x50/510 BU for DF 500, qty. in pack 510 Units, dimensions 10 x 50 mm	74.70 89.64	493300
	D 8x80/190 BU for DF 700, qty. in pack 190 Units, dimensions 8 x 80 mm	39.00 46.80	498212
	D 8x100/150 BU for DF 700, qty. in pack 150 Units, dimensions 8 x 100 mm	39.00 46.80	498213
	D 10x80/150 BU for DF 700, qty. in pack 150 Units, dimensions 10 x 80 mm	39.00 46.80	498214
	D 10x100/120 BU for DF 700, qty. in pack 120 Units, dimensions 10 x 100 mm	39.00 46.80	498215
	D 12x100/100 BU for DF 700, qty. in pack 100 Units, dimensions 12 x 100 mm	39.00 46.80	498216
	D 12x140/90 BU for DF 700, qty. in pack 90 Units, dimensions 12 x 140 mm	39.00 46.80	498217
	D 14x75/104 BU for DF 700, qty. in pack 104 Units, dimensions 14 x 75 mm	37.90 45.48	201499
	D 14x100/80 BU for DF 700, qty. in pack 80 Units, dimensions 14 x 100 mm	39.00 46.80	498218
	D 14x140/70 BU for DF 700, qty. in pack 70 Units, dimensions 14 x 140 mm	39.00 46.80	498219

Beechwood DOMINOs		RRP in £*	Order no.
	DOMINO beechwood All variants: for DF 700, material: Beech		
	D 8x750/36 BU qty. in pack 36 Units, dimensions 8 x 750 mm	56.30 67.56	498686
	D 10x750/28 BU qty. in pack 28 Units, dimensions 10 x 750 mm	54.80 65.76	498687
	D 12x750/22 BU qty. in pack 22 Units, dimensions 12 x 750 mm	51.40 61.68	498688
	D 14x750/18 BU qty. in pack 18 Units, dimensions 14 x 750 mm	51.40 61.68	498689
DOMINO sipo		RRP in £*	Order no.
	Sipo DOMINO All variants: for DF 500, material: Sipo, mahogany dowels, weatherproof, FSC™-certified		
	D 5x30/300 MAU qty. in pack 300 Units, dimensions 5 x 30 mm	27.50 33.00	494869
	D 5x30/900 MAU qty. in pack 900 Units, dimensions 5 x 30 mm	74.70 89.64	494859
	D 6x40/190 MAU qty. in pack 190 Units, dimensions 6 x 40 mm	27.50 33.00	494870
	D 6x40/570 MAU qty. in pack 570 Units, dimensions 6 x 40 mm	74.70 89.64	494860
	D 8x40/130 MAU qty. in pack 130 Units, dimensions 8 x 40 mm	27.50 33.00	494871
	D 8x40/390 MAU qty. in pack 390 Units, dimensions 8 x 40 mm	74.70 89.64	494861
	D 8x50/100 MAU qty. in pack 100 Units, dimensions 8 x 50 mm	27.50 33.00	494872
	D 8x50/300 MAU qty. in pack 300 Units, dimensions 8 x 50 mm	74.70 89.64	494862
	D 10x50/85 MAU qty. in pack 85 Units, dimensions 10 x 50 mm	27.50 33.00	494873
	D 10x50/255 MAU qty. in pack 255 Units, dimensions 10 x 50 mm	74.70 89.64	494863
	Sipo DOMINOs		RRP in £*
	DOMINO Sipo All variants: for DF 700, material: Sipo		
	D 8x750/36 MAU qty. in pack 36 Units, dimensions 8 x 750 mm	109.00 130.80	498690
	D 10x750/28 MAU qty. in pack 28 Units, dimensions 10 x 750 mm	105.70 126.84	498691
	D 12x750/22 MAU qty. in pack 22 Units, dimensions 12 x 750 mm	102.40 122.88	498692
	D 14x750/18 MAU qty. in pack 18 Units, dimensions 14 x 750 mm	102.40 122.88	498693
Systainer		RRP in £*	Order no.
	DOMINO, beech range DS 4/5/6/8/10 1060 BU for DF 500, DOMINO dowel range 4 x 20, 5 x 30, 6 x 40, 8 x 40, 8 x 50, 10 x 50 mm, DOMINO router for sizes 4, 5, 6, 8 and 10, Systainer SYS3 M 187, dimensions 396 x 296 x 157,5 mm	210.90 253.08	576794
	DOMINO XL beechwood domino All variants: for DOMINO XL, DOMINO XL beechwood dowel range, Systainer SYS3 M 187		
	DS/XL D8/D10 306 BU DOMINO 8 x 50, 8 x 80, 8 x 100, 10 x 50, 10 x 80, 10 x 100 mm and DOMINO XL cutter for sizes 8 and 10	188.70 226.44	576791
	DS/XL D12/D14 128 BU DOMINO 12 x 100, 12 x 140, 14 x 100, 14 x 140 mm and DOMINO XL cutter for size 14	219.50 263.40	576792
	Systainer T-LOC SORT-SYS3 M 137 DOMINO empty SYS3 M 137 Systainer, contains three boxes with reconfigurable compartments for individual filling of DOMINOs or other accessories or tools, Long plastic containers, Systainer SYS3 M 137, volume 10,4 l, dimensions with adjustable legs [L x W x H] 396 x 296 x 137 mm, inner dimensions [L x W x H] 389 x 275 x 96 mm	64.80 77.76	576796
	Systainer³ SORT-SYS3 M 187 DOMINO empty SYS3 M 187 Systainer, contains three boxes with reconfigurable compartments for individual filling of DOMINOs, volume 15,9 l, inner dimensions [L x W x H] 389 x 275 x 146 mm, dimensions with adjustable legs [L x W x H] 396 x 296 x 187 mm	73.20 87.84	576793

* Manufacturer's recommended retail price. Dealer prices may vary.
Excl. VAT. | Incl. VAT.

10 Planing





254 EHL 65 one-hand electronic planer



256 HL 850 electronic planer

Modified slightly. Improved decisively.

The one-hand electronic planer.

Weighing just 2.4 kg and with a compact design, the EHL 65 electric planer is not only the lightest one-handed planer in its class, but also the most powerful. With a 4 mm planing and 23 mm rebate depth and excellent surface finish thanks to the unique spiral blade with pulling cut. With SoftGrip handle, single-button operation and non-slip ridges on the housing for a secure hold. In short: The one-handed planer for professionals.

One-hand electronic planer
EHL 65



Technical data	EHL 65
Power consumption (watt)	720
Planer shaft speed (RPM)	15.600
Planing width (mm)	65
Planing depth (mm)	0 – 4
Max. rebate depth (mm)	23
Dust extraction connection dia. (mm)	27
Weight (kg)	2,4



Nothing quieter





The EHL 65 is significantly quieter than other planers. In fact, it is so quiet that it makes less noise under load than other planers do when idling. This is an important contribution to safety while working. Yet another benefit of the special shape of the spiral blade.

Stepless cutting depth adjustment

The infinitely adjustable cutting depth is a valuable feature in practice. You can use the rotating handle to accurately adjust the cutting depth, while carrying out your work.



Items included		RRP in €*	Order no.
EHL 65	All variants: parallel side fence, hex key, WAF 2, Systainer SYS 2 T-LOC		
	EHL 65 EQ-Plus 110V	287.00 344.40	576605
	EHL 65 EQ-Plus 240V	287.00 344.40	576604

Accessories		RRP in €*	Order no.
All variants: for EHL 65			
	Spiral blade HW 65 HW version for the EHL 65, HW standard planer blades with 65 mm width	15.70 18.84	488503
	Rebate depth stop FA-EHL for rebate depths of 0-23 mm	11.30 13.56	488543
	Parallel side fence PA-EHL for side guidance, adjustable between 0 mm and 65 mm	14.50 17.40	488544
	Chip collection bag SB-EHL	36.00 43.20	488566

* Manufacturer's recommended retail price. Dealer prices may vary.
Excl. VAT. | Incl. VAT.

Planer with no limits.

Our electronic planer.

Planing and producing rebates close to the edge: Thanks to the single-bearing planing head, the HL 850 electronic planer produces flush results with an unlimited rebate depth. No limit to the rebate depth, no rework required.

Electric planers HL 850



Technical data	HL 850
Power consumption (watt)	850
Planer shaft speed (RPM)	12.000
Planing width (mm)	82
Planing depth (mm)	0 – 3,5
Max. rebate depth	∞
Dust extraction connection dia. (mm)	36
Weight (kg)	3,9















Texturing surfaces

Narrow, wide or rustic waves. Replacing the planing head for textured planing requires a single hand movement.

Accurate chamfering

No slipping or running off course: The 90° V-groove in the planer foot makes the HL 850 electric planer feel like it is gliding along a rail when chamfering boards and beams.



Items included	RRP in £*	Order no.
HL 850		
 HL 850 EB-Plus Planing head HK 82 SD, parallel side fence, rebate depth stop, extraction adapter, hex key, WAF 5, SYS 3 TL Systainer	not available in Great Britain	576607
Accessories		
 Rebate depth stop FA-HL for HL 850, for rebate depths of 0-30 mm	10.00 12.00	484512
 Parallel side fence PA-HL for HL 850, for side guidance, adjustable between 0 mm and 82 mm	18.80 22.56	484513
 Chip collection bag SB-HL for HL 850, without suction adapter	54.50 65.40	484509
 Extraction adapter AD-HL for HL 850, for chip collection bag and suction hose with bushing, suction hose diameter 36 mm	14.50 17.40	484507
 Planing head HK 82 SD for HL 850, standard design, with HW carbide-tipped spiral blade HW 82 SD	130.00 156.00	484520
 Planing head HK 82 RF for HL 850, rustic design, fine, with spiral blade HS 82 RF, depth limiter	151.70 182.04	484521
 Planing head HK 82 RG for HL 850, rustic design, coarse, with HS spiral blade HS 82 RG, depth limiter	151.70 182.04	484522
 Planing head HK 82 RW for HL 850, rustic design, undulating, with HS spiral blade HS 82 RW, depth limiter	151.70 182.04	485331
 Spiral blade HW 82 SD for planer head HK 82 SD, HM standard design, HW standard planer blades with 82 mm width	25.20 30.24	484515
 Spiral blade HS 82 RF for planer head HK 82 RF, HSS rustic design, fine	30.50 36.60	484518
 Spiral blade HS 82 RG for planer head HK 82 RG, HSS rustic design, coarse	30.50 36.60	484519
 Spiral blade HS 82 RW for planer head HK 82 RW, HSS rustic design, undulating	30.50 36.60	485332

* Manufacturer's recommended retail price. Dealer prices may vary.
Excl. VAT. | Incl. VAT.

11 Edging





260 CONTURO edge bander



262 Trimming machine



263 Multifunction table



263 Adapter plate

The start of the perfect edge. The CONTURO edge bander.

Versatile and easy to operate, the CONTURO represents a genuine solution for manufacturing narrow or large workpieces and individual shaped parts, as well as affixing edging to workpieces or furniture components produced in small batches.

Edge bander **CONTURO KA 65**

For classic furniture edging or manufacturing of complex moulded parts with convex or concave curves. For finishes in wood, melamine or plastic. For variable edge heights of up to 65 mm and material thicknesses of up to 3 mm.



Edge trimming set **KA 65 Set**

From the trimming machine and spot repair scraper, through to abrasives and polishes – everything is sorted and clear to see in the Systainer "Edge trimming set".





Low heating

Device housing does not heat up, ensuring safety while working.



Unique cartridge gluing system

Easy, clean and efficient work as well as quick colour changes thanks to the unique cartridge gluing system. The glue is only ever melted as required, avoiding coagulation, discolouration and deterioration.



For an even wider range of applications

Four different adhesive colours (white, natural, brown and black) guarantee the perfect join quality, whatever your decor. And with the new polyurethane adhesive, waterproof and heat-resistant gluing (for example for bathroom and kitchen furnishings) is now easy.



Always ready to use

Nozzle system that is easy to clean. Self-contained system that prevents the unwanted escape of glue.

The perfect edge finish. The MFK 700 Basic.



The final sanding process comes after the gluing and edge trimming: Cut off edge protrusion, smooth down the edge, perform finishing work on corners and polish the edge if necessary to high gloss. Ideal for routing edges: The Festool MFK 700 Basic edge router with spring-loaded ball bearing guide brake and chip deflector. This is designed specially for machining the most delicate edges without leaving behind any marks.

You can find more information on page 218





Technical data	KA 65
Power consumption (watt)	1.200
Edge height (mm)	18 – 65
Edge thickness (mm)	0,5 – 3
Inner radius (mm)	> 50
Heating time (min)	8
Melting temperature (°C)	100 – 210
Feed speed (m/min)	2/4
Safety class	I
Weight (kg)	8,4

Items included	RRP in £*	Order no.
KA 65 All variants: front handle, 4 x EVA adhesive, natural, Systainer SYS3 M 337		
 KA 65-Plus 240V	2,291.00 2,749.20	576575
 KA 65-Set 240V protective edging, 20x StickFix Granat 80 x 133 P320 abrasive sheets, additional roll, HSK 80 x 133 H sanding block, trimming device, scraper, base runner scratch protector with 3x felt layers, polishing felt, S 800 StickFix sanding cloth, MPA 5010 OR polish	2,686.00 3,223.20	576581

Trimming machine KP 65/2

Ergonomic handle location for easy, effortless trimming, even on thick edging. Patented eccentric fine adjustment for precision impact trimming.



Technical data	KP 65/2
Trimming height (mm)	65
Trimming thickness (mm)	2

Items included	RRP in £*	Order no.
KP 65/2	149.00 178.80	499896



The precise cut

Tabletop on both sides of the trimming machine allows the user to trim left and right panel edges from above – with a perfect view of the workpiece. Impact trimming function (for round tables) and trimming of panel edges (final trimming) with a single machine.

Multifunction table

MFT/3 CONTURO

This stationary working method is very practical for straight edges along small or narrow workpieces that are difficult to clamp. The edge is inserted in the usual way, the workpiece is then guided along the rail while even pressure is applied to the contact roller.

Technical data	MFT/3 CONTURO
Table dimensions (mm)	1.157 x 773
Work height (mm)	900
Swivel-mounted edge bander (°)	47
Weight (kg)	29

Items included	RRP in £*	Order no.
MFT/3 Conturo-AP adapter plate AP-KA 65, cross brace QT-MFT/3	826.80 992.16	500869



The CONTURO as a stationary machine

Not only can you affix edging to straight edges or curves, but also oblique edges with an angle of 90°–45° because the CONTURO can be tilted 90°–45° in the stationary unit.

Adapter plate

AP-KA 65

For stationary use of the edge bander. Installation of the adapter plate in a self-constructed table frame or in the MFT perforated top intended for it. For small batches, straight edges, freeform elements and gluing inclined edges, angle of 0 – 47°.

Technical data	AP-KA 65
Dimensions length x width (mm)	254 x 420
Min. installation height (mm)	150
Cutting angle adjustment (°)	0 – 47

Items included	RRP in £*	Order no.
AP-KA 65 mounting plate for edge bander complete with 15 sliding guides, additional roll	319.00 382.80	500175



Horizontal work on oblique edges

Allows the user to swivel the machine (0 – 47°) in the bench and position the workpiece horizontally during edging – for convenient and safe guidance, even with larger objects. Sliding guides for guiding the workpiece safely.

* Manufacturer's recommended retail price. Dealer prices may vary.

Excl. VAT. | Incl. VAT.

Vibration and emissions values can be found in the operating manual at www.festool.co.uk/vibration

11 Edging

Accessories		RRP in £*	Order no.
	Additional roll ZR-KA 65 for KA 65, for affixing edging to tight curves and shaped parts, offers additional pressure point for applying more pressure on the edge of the board when glued, roll height 65 mm	59.20 71.04	499480
	Scratch protector LAS-STF-KA 65 for KA 65, for using the edge bander on delicate or high-gloss surfaces, 4 x retaining screws, 3 x felt pads	28.60 34.32	499892
	Spare felt EF-LAS-STF-KA 65 10x for scratch protector LAS-STF-KA 65, for using the edge bander on delicate or high-gloss surfaces, qty. in pack 10 Units	24.30 29.16	499893
	Magazine for holding edging KSP-KA 65 for KA 65, for the safe guidance of delicate and thin edging into the edge bander KA 65, safe guidance of long edges without damaging or soiling, max. edge lengths of 8 m (edge thickness of 2 mm) possible, max. edge height 45 mm, max. edge thickness 2 mm	49.50 59.40	499479
	Sanding block HSK 80x133 H hard, for attaching StickFix 80 x 133 mm abrasive sheets	22.30 26.76	495967
Vlies  80 x 130 mm	Sanding vlies STF 80x130 SF 800 VL/5 for RTS 400, RTSC 400, RS 400, RS 4, LS 130, HSK-A 80 x 130, HSK 80 x 133, dimensions 80 x 130 mm, grit 800, qty. in pack 5 Units	8.60 10.32	483582
Abrasive sheet All variants: for RTS 400, RTSC 400, RS 400, RS 4, LS 130, dimensions 80 x 133 mm, qty. in pack 100 Units			
	STF 80x133 P220 GR/100 grit P220	44.90 53.88	497123
Granat  80 x 133 mm	STF 80x133 P240 GR/100 grit P240	44.90 53.88	497124
	STF 80x133 P280 GR/100 grit P280	44.60 53.52	497204
	STF 80x133 P320 GR/100 grit P320	44.90 53.88	497125
	Polishing agent MPA 5010 OR/0,5L Speed Cut 1-step sanding polish, does not contain silicone, water-based, perfect in combination with a sheepskin pad or polishing pad (ORANGE), volume 500 ml	29.10 34.92 58.20 / 1 l 69.84 / 1 l	202048
	Polishing felt PF-STF 80x133 STF H/5 for hand sanding block HSK 80 x 133, in conjunction with the MPA 5010 polishing agent, for polishing high-gloss edges, qty. in pack 5 Units, dimensions length x width 80 x 133 mm	14.80 17.76	499894
	Perforated top LP-KA65 MFT/3 for KA 65, allows the user to swivel the machine (0 – 47°) in the bench in combination with the AP-KA 65 adapter plate and therefore position the workpiece horizontally during edging – for convenient and safe guidance, even with larger objects, dimensions length x width 1.102 x 718 mm	137.70 165.24	500366
	Crossheaded guide GP-MFT/3 KA65 15x for KA 65, replacement or extension slide plates for stationary use of the edge bander with the AP-KA 65 adapter plate in the MFT (with KA 65 perforated board, order no. 500366) or installed in a separate workbench, qty. in pack 15 Units, dimensions (L x W x H) 255 x 31 x 6 mm	24.90 29.88	500367

Accessories	RRP in £*	Order no.
 <p>EVA adhesive, natural EVA nat 48x-KA 65 for KA 65, unfilled EVA adhesive – natural colour tone suitable for all types of decor, EVA universal adhesive with high melting point, high softening range of approx. 90°C, therefore also suitable for use on objects with a relatively high temperature resistance from -10°C to +75°C, chemical basis: Adhesive, resin, adhesive diameter 63 mm, adhesive height 26 mm, processing temperature 190°C, moisture resistance in accordance with D1, qty. in pack 48 Units</p>	<p>102.90 123.48</p>	499812
 <p>EVA adhesive, white EVA wht 48x-KA 65 for KA 65, Unfilled EVA adhesive – perfect join quality on white decor, EVA universal adhesive with high melting point, high softening range of approx. 90°C, therefore also suitable for use on objects with a relatively high temperature resistance from -10°C to +75°C, chemical basis: Adhesive, resin, adhesive diameter 63 mm, adhesive height 26 mm, processing temperature 190°C, moisture resistance in accordance with D1, qty. in pack 48 Units</p>	<p>102.90 123.48</p>	499813
 <p>EVA adhesive, brown EVA brn 48x-KA 65 for KA 65, Unfilled EVA adhesive – perfect join quality on brown decor, EVA universal adhesive with high melting point, high softening range of approx. 90°C, therefore also suitable for use on objects with a relatively high temperature resistance from -10°C to +75°C, chemical basis: Adhesive, resin, adhesive diameter 63 mm, adhesive height 26 mm, processing temperature 190°C, moisture resistance in accordance with D1, qty. in pack 48 Units</p>	<p>102.90 123.48</p>	200059
 <p>EVA adhesive, black EVA blk 48x-KA 65 for KA 65, Unfilled EVA adhesive – perfect join quality on black decor, EVA universal adhesive with high melting point, high softening range of approx. 90°C, therefore also suitable for use on objects with a relatively high temperature resistance from -10°C to +75°C, chemical basis: Adhesive, resin, adhesive diameter 63 mm, adhesive height 26 mm, processing temperature 190°C, moisture resistance in accordance with D1, qty. in pack 48 Units</p>	<p>102.90 123.48</p>	200060
 <p>PU adhesive, natural PU nat 4x-KA 65 for KA 65, caution: use rinsing agent to clean machine after use (PU spm 4x KA65, number 200062), can be stored for a maximum of 12 months, adhesive has high initial strength, and cold elasticity, and good solvent resistance, natural colour tone, PU adhesive packed in 200 g airtight containers, chemical basis: Polyurethane adhesive, caution! The polyurethane adhesive provided here contains "o-[p-isocyanatobenzyl] phenyl isocyanate; diphenylmethane-2,4'-diisocyanate" and as a result is labelled with the R40 phrase "Limited evidence of a carcinogenic effect". We are obligated by the Chemikalien-Verbotsverordnung (German Chemicals Prohibition Ordinance) to draw your attention to the presence of hazardous substances in our polyurethane adhesive no. 200056. By purchasing said polyurethane adhesive, you are confirming that you are at least 18 years old, that you shall use the PU adhesive properly and protect skin, eyes and mucous membranes from direct contact with it, e.g. by wearing protective goggles, respiratory protection/mask and disposable gloves. We are trained and assessed in accordance with Section 5 of the Chemicals Prohibition Ordinance, adhesive diameter 63 mm, adhesive height 42 mm, processing temperature 140°C, temperature resistance -40°C – +140° C, softening range 90°C, moisture resistance in accordance with D3/D4, qty. in pack 4 Units, weight 0,8 kg</p>	<p>56.60 67.92 70.75 / 1 kg 84.90 / 1 kg</p>	200056
 <p>Rinsing agent PU spm 4x-KA 65 for KA 65, rinsing cartridge for the CONTURO KA 65 edge bander after use of PU adhesive, natural, PU nat 4x-KA 65, must be used after PU adhesive use to stop remaining PU adhesive chemically reacting, can be stored for a maximum of 12 months, packaged in 140 g containers, weight 0,56 kg, qty. in pack 4 Units</p>	<p>46.10 55.32 82.32 / 1 kg 98.79 / 1 kg</p>	200062
 <p>Scraper ZK HW 45/45 trimming overhanging material after the edge is cut (plastic edging) without damaging the surface of the workpiece, smoothing away impact marks left by cutters during the routing process (R1, R1.5 and R2 mm curves), dimensions 45 x 45 mm, dimensions (L x W x H) 45 x 45 x 1,2 mm, curves 1/1,5/2 mm</p>	<p>51.60 61.92</p>	499749
 <p>Edge trimming set KB-KA 65 SYS3 for KA 65, protective edging, 20x StickFix Granat 80 x 133 P320 abrasive sheets, additional roll, HSK 80 x 133 H sanding block, trimming device, scraper, base runner scratch protector with 3x felt layers, polishing felt, S 800 StickFix sanding cloth, MPA 5010 OR polish, Systainer SYS3 M 337</p>	<p>394.70 473.64</p>	576834

12 Stirring



Power socket to go.
The new SYS-PowerStation.
You can find more information
on page 312.



268 MX 1000, MX 1200
stirrers



270 MX 1200/2, MX 1600/2
stirrers



271 DUO stirrer
MX 1600/2 DUO



273 Extraction for stirrers

Robust. Ergonomic. With perfect dust extraction. The Festool stirrers.

Thick clouds of dust while stirring are a thing of the past: The MX stirrers, including MX extraction around the edge of the bucket, enable you to mix any material with no dust. A welcome breath of fresh air not only for your lungs – but for your back, too. The flexible ErgoFix height adjustment enables you to work while standing, protecting your back. The combination of their powerful motors and robust gear units mean that these machines offer maximum power and a long service life. One more bonus: Your construction site stays clean – before, during and after stirring.



Stirrer **MX 1000**

The universal one-gear stirrer with 1020 watts for mixing applications up to 40 l.



Stirrer **MX 1200**

The single-speed powerhouse with 1200 watts for mixing applications up to 60 l.



Ergonomic – mix while standing upright

Simply adjust your stirrer to match your height with the patented ErgoFix height adjustment system. Mix in a natural upright working position for relaxed and effortless working.

Effective extraction as soon as material is poured in

The MX extraction system is simply clamped onto the edge of the mixing bucket so that the dust disappears into the extractor from the moment the mixing material is poured in. You no longer have to battle with clouds of dust while stirring. And after your work is done, the construction site is as clean as before, saving you valuable time.



Dust-free work begins with stirring. MX extraction.

No exposure to dust when filling and mixing powder-like materials – the MX dust extraction is simply clipped onto the edge of the bucket and ensures that dust ends up in the extractor and not in your lungs. For a clean working environment without reworking.

Also available as an accessory without stirrer.
For more details see page 273



Extremely powerful for harsh industrial environments.

The powerful stirrers for large quantities.

The MX 1200/2 and MX 1600/2 stirrers can withstand the toughest of conditions, from heavy contamination to hard impact or collisions. The even more powerful motors and high-torque two-speed gearbox are perfect for major, heavy-duty mixing applications: First gear for viscous and heavy materials, second gear for simple and fast mixing of liquid materials.



Stirrer
MX 1200/2

The high-torque two-speed stirrer with 1200 watts for mixing applications up to 70 L.

Stirrer
MX 1600/2

Our most powerful two-speed stirrer with 1500 watts for mixing applications up to 90 L.



All within easy reach

A tubular steel frame ensures maximum robustness and parallel rubber-coated handles enable the user to guide the machine with ease and comfort.

Faster. Lighter. More intensive.

The two-spindle stirrer.

For up to 50% more speed, the DUO stirrer works with two spindles working in opposite directions: The two stirring rods interlock, thereby speeding up the mixing of the material. Perfect mixing results with considerably less exertion for the user.



Stirrer MX 1600/2 DUO

Two-speed DUO stirrer with 1500 watts for thorough mixing, even of viscous and multi-component material up to 90 l.

Work more easily

Working with the DUO saves even more energy. The stirring rods working in opposite directions cancel out the torque. You guide the tool through the material with virtually no torque.



Lightning-quick changes without using tools

The FastFix quick-change system allows the machine and stirrer basket to be separated without the use of tools and enables rapid replacement of the stirrer basket, as well as simple cleaning and space-saving transportation.



12 Stirring



Technical data	MX 1000	MX 1200	MX 1200/2	MX 1600/2	MX 1600/2 DUO
Power consumption (watt)	1.020	1.200	1.200	1.500	1.500
Gears	1	1	2	2	2
Idling speed, 1st gear/2nd gear (RPM)	360 – 630/-	360 – 630/-	150 – 360/320 – 780	150 – 300/320 – 650	100 – 250/130 – 350
Tool holder	M14/ErgoFix	M14/ErgoFix	M14/ErgoFix	M14/ErgoFix	FastFix
Collar dia. (mm)	57	57	57	57	57
Max. mixer container diameter (mm)	120	140	140	160	140
Mix quantity (l)	40	60	70	90	90
Weight (kg)	4,6	4,6	6,3	6,7	8,1



RS
Round stirrer



HS3L
Helical stirrer with
3 anticlockwise
spirals



CS
Whisk



HS2
Helical stirrer with
2 spirals



HS3R
Helical stirrer with
3 clockwise spirals



Material consistency liquid
Mixing result liquid

	RS	HS3L	CS	HS2	HS3R
Paints	●	●			
Emulsion paint	○	●			
Wallpaper paste	●	○			
Clear coat, varnish	●	○			
Epoxy resin	○	○	●		









Material consistency powdery/viscous
Mixing result free-flowing

	RS	HS3L	CS	HS2	HS3R
Filler			●	●	○
Bonding mortar			○	●	○
Levelling compound			●	○	
Waterproofing filler			●	●	○
Bitumen			○		○





Material consistency powdery/viscous
Mixing result compact

	RS	HS3L	CS	HS2	HS3R
Ready-mix plaster				○	○
Plaster		○		●	●
Tile cement				●	○
Joint mortar				●	●
Mortar				●	●
Quartz-filled epoxy resin				○	●
Concrete, screed				○	●

Items included	RRP in £*	Order no.
MX 1000		
 MX 1000 RE EF HS2 stirrer rod HS 2 120x600 M14, ErgoFix adapter, double open-ended wrench, MX-A extraction	not available in Great Britain	575806
MX 1200		
 MX 1200 RE EF HS2 240V stirrer rod HS 2 140x600 M14, ErgoFix adapter, double open-ended wrench, MX-A extraction	326.00 391.20	575814
MX 1200/2		
 MX 1200/2 RE EF HS3R stirrer rod HS 3 140x600 R M14, ErgoFix adapter, double open-ended wrench, MX-A extraction	not available in Great Britain	575815
MX 1600/2		
 MX 1600/2 RE EF HS3R 240V stirrer rod HS 3 160x600 R M14, ErgoFix adapter, double open-ended wrench, MX-A extraction	450.00 540.00	575819
MX 1600/2 DUO		
 MX 1600/2 REQ DUO DOUBLE one pair of stirring rods, HS 3 Double 140 x 600, MX-A extraction	not available in Great Britain	575822
Accessories		
	RRP in £*	Order no.
Dust extraction		
 Dust extraction MX – A for all MX stirrers and CT/CTL/CTM mobile dust extractors, for dust-free work with the stirrers, dust extraction connection dia. 36 / 27 mm	45.30 54.36	576759
ErgoFix adapter		
 Adapter AD-EF-M14/80 ErgoFix with M14 thread, For holding Festool stirrer rods M14 at ErgoFix stirrers, stroke length 80 mm	14.10 16.92	769091

12 Stirring

Stirring rods		RRP in £*	Order no.
Round stirrer			
for fluid materials, wall and emulsion paints, standard paste, sealing compounds, clear coats, bitumen, sludge			
	Round stirrer RS 2 120x600 M14 for MX 1000, MX 1000/2, MXP 800, MXP 1000, MXP 1002, material quantity 20 – 40 kg, diameter 120 mm, length 600 mm	not available in Great Britain	769021
	Spiral stirrer for thin materials, gypsum plaster, emulsion paint, clear coats, wall paints, sealing compounds		
	Spiral stirrer All variants: length 600 mm		
	HS 3 120x600 L M14 for MX 1000, MX 1000/2, MXP 800, MXP 1000, MXP 1002, material quantity 15 – 25 kg, diameter 120 mm	not available in Great Britain	767921
	HS 3 140x600 L M14 for MX 1200, MX 1200/2, MXP 1200, MXP 1202, material quantity 25 – 40 kg, diameter 140 mm	not available in Great Britain	768138
	HS 3 160x600 L M14 for MX 1600/2, MXP 1602, material quantity 30 – 60 kg, diameter 160 mm	not available in Great Britain	768709
Stirrer CS			
for filling mixtures and smoothing cement, sealant, adhesives, for stirring without trapping air (no air bubbles)			
	Stirrer All variants: length 600 mm		
	CS 120x600 M14 for MX 1000, MX 1000/2, MXP 800, MXP 1000, MXP 1002, material quantity 10 – 15 kg, diameter 120 mm	not available in Great Britain	769118
	CS 140x600 M14 for MX 1200, MX 1200/2, MXP 1200, MXP 1202, material quantity 20 – 40 kg, diameter 140 mm	not available in Great Britain	769117

Stirring rods

RRP in £*

Order no.

Spiral stirrer

for viscous materials, tile cement, filling compounds, flooring mixtures, ready-mix plasters, screed, smoothing cement, filling mixtures



Spiral stirrer
All variants: length 600 mm

HS 2 120x600 M14

for MX 1000, MX 1000/2, MXP 800, MXP 1000, MXP 1002, material quantity 15 – 20 kg, diameter 120 mm

not available
in Great Britain

769030

HS 2 140x600 M14

for MX 1200, MX 1200/2, MXP 1200, MXP 1202, material quantity 20 – 40 kg, diameter 140 mm

not available
in Great Britain

769031

HS 2 160x600 M14

for MX 1600/2, MXP 1602, material quantity 30 – 60 kg, diameter 160 mm

not available
in Great Britain

769032

HS 3 R helical stirrer with ring

for stiff materials with a high viscosity, mortar, concrete, cement and lime plaster, mounting binder, screed, quartz-filled epoxy resin, bitumen, thick coatings



Spiral stirrer
All variants: length 600 mm

HS 3 120x600 R M14

for MX 1000, MX 1000/2, MXP 800, MXP 1000, MXP 1002, material quantity 15 – 25 kg, diameter 120 mm

not available
in Great Britain

767887

HS 3 140x600 R M14

for MX 1200, MX 1200/2, MXP 1200, MXP 1202, material quantity 25 – 40 kg, diameter 140 mm

not available
in Great Britain

768708

HS 3 160x600 R M14

for MX 1600/2, MXP 1602, material quantity 30 – 60 kg, diameter 160 mm

not available
in Great Britain

768710

Stirring rods for MX 1600/2 EQ DUO

**Stirring rod HS 3 COMBI 140x600 FF**

for MX 1600/2 DUO, MXP 1602 DUO, for liquid and viscous materials, lower part of the stirrer cage raises mixture from the bottom of the container upwards. Upper part of the stirrer cage pushes mixture downwards, material quantity 30 – 60 kg, diameter 140 mm, length 600 mm

not available
in Great Britain

768092

**Stirring rod HS 3 DOUBLE 140x600 FF**

for MX 1600/2 DUO, MXP 1602 DUO, For high viscosity or heavy materials needing thorough mixing, two stirrer rods, each with three helices, counter-rotate. Mixture is pulverised and whisked, material quantity 30 – 60 kg, diameter 140 mm, length 600 mm

not available
in Great Britain

768800

13 Preparing the substrate

Power socket to go.
The new SYS-PowerStation.
You can find more information
on page 312.





278 RENOFIX
surface-restoration grinders



280 RENOFIX
renovation millers



283 Wallpaper perforator

Wall-to-wall floor sanding – healthier for you, cleaner for your customers.

The surface-restoration grinder.





The speed of the RG 130, which is optimised for diamond tools, enables quick removal of concrete, screed and coatings on hard substrates.



Surface-restoration grinder **RENOFIX RG 130**

1600 watt motor for rapid material removal and fast results.

Technical data	RG 130	Items included	RRP in £*	Order no.
Power consumption (watt)	1.600	RG 130 E-Plus 240V front handle, flange set, KF-AG face wrench, hook-and-loop fastener KV-215 (pack of 5), Systainer ³ SYS3 L 237	631.00 757.20	576401
Idle engine speed (RPM)	3.000 – 7.700			
Tool dia. (mm)	130			
Tool holder	D25/M14			
Dust extraction connection dia. (mm)	36			
Weight (kg)	3,8			

Accessories		RRP in £*	Order no.
	Guide table GT-RG 130 for RG 130, RGP 130, Enables the material removal capacity rate to be adjusted and thus the removal in defined layers	33.80 40.56	769080
	Brush ring BC-RG 130 for RG 130, RGP 130, replaceable spare brush rim	22.80 27.36	769110
	Clamping nut UF-DSC/DSG-AG M14 for DSC-AG 125/230 (manufactured from 03/2015) and RG 130 (manufactured from 03/2015), for disc Ø 115 – 230 mm, front clamping flange, for clamping the grinding disc, holder M14	not available in Great Britain	200241
	Spanner KF-AG for DSC-AGC 18 FH, DSC-AG 125/230, RG 130, for flange	not available in Great Britain	769040



Hardly any dust: Good for your health. And for your customers.

The RENOFIX RG 130 E surface-restoration grinder, when combined with the CTM 36 AC RENOFIX mobile dust extractor and the CT-VA pre-separator, achieves excellent extraction results and guarantees dust-free work. Your customers will be amazed by how clean their workspace is.

Wall-to-wall floor sanding

The folding brush segment enables tile and parquet adhesive residue to be removed right up to the wall. Thanks to the diamond disc, recessed by 0.5 mm, no wall damage occurs.



Optimal guidance – precise removal

The guide table allows the surface-restoration grinder to be guided safely. What's more, the removal height can be variably adjusted so that you don't remove any more material than required.



Extremely efficient material removal

The RENOFIX RG 130 surface-restoration grinder makes a real impression with its high removal rate – for perfect substrate preparation that guarantees flawless results.

Replaceable diamond discs. Always adapted to the working material.

Whether you are working with concrete, screed, paint, adhesive or other coatings: The DIA HARD, ABRASIVE, STONE, THERMO and PAINT diamond discs can handle it all. And any disc can be swapped out for another in just a few simple steps.

You can find more information on page 282



The optimal solution for material removal during renovation and restoration.

The RENOFIX renovation millers.

Fast working with powerful electronics for constant speed. With the RENOFIX renovation millers, thanks to the wide range of accessories, both hard and soft materials can be removed.

Renovation miller **RENOFIX RG 80**

One for all. The RENOFIX RG 80 renovation miller is a multi-talent for small to medium-sized surfaces.



Renovation miller **RENOFIX RG 150**

The RG 150 renovation miller with a 150 mm tool diameter and a broad range of accessories guarantees fast progress on large surfaces.



Technical data	RG 80	RG 150
Power consumption (watt)	1.100	1.600
Idle engine speed (RPM)	2.000 – 5.900	1.000 – 2.200
Tool dia. (mm)	80	150
Tool holder	2 x M5	D14/M8
Dust extraction connection dia. (mm)	36	36
Weight (kg)	3,5	6,2





Work adapted to the material





For precise, dust-free work on porous substrates, a speed adapted to the material is key. The speed of the RENOFIX renovation millers can therefore be controlled electronically.



Compact, handy, ergonomic











The slimline motor housing, the additional hand grip, the dome grip above the transmission housing and the stable extraction pipe of the RG 80 enable individual handling options – for comfortable hand positions in every working situation.

Items included	RRP in £*	Order no.
RG 80		
 RG 80 E-Plus extraction hood, Auxiliary handle VIBRASTOP, allen key 4, SYS 3 TL Systainer	not available in Great Britain	768016
RG 150		
 RG 150 E-Plus Puller/removal tool, Socket spanner SW 10/13, SYS 5 TL Systainer	not available in Great Britain	768019

Accessories	RRP in £*	Order no.
 Floor guide BG-RG 150 for RG 150, RGP 150, for easy guidance of RENOFIX RG 150 E over large areas	not available in Great Britain	769109
 Balancer BR-RG 150 for RG 150, RGP 150, for secure and simple guidance of the RENOFIX RG 150 E on the wall, max. load 8 kg, length 2,5 m	not available in Great Britain	769121
 Brush ring BC-RG 150 for RG 150, RGP 150, replaceable spare brush rim	not available in Great Britain	769123
 Cutter heads from page 282		

13 Preparing the substrate

RG 130: diamond discs		RRP in £*	Order no.
Diamond disc All variants: for RG 130, RGP 130, AGP 125, diameter 130 mm, interior dia. 25/22,2 mm			
	DIA HARD-D130 PREMIUM for old solid concrete, removal of epoxy resin from solid surfaces or coatings/paints from concrete, active surface 3.000 mm ² , segment height 7 mm	not available in Great Britain	768017
	DIA ABRASIVE-D130 PREMIUM for sand-based materials, screed, fresh concrete, adhesive on screed, sand-lime brick and cellular concrete, active surface 3.460 mm ² , segment height 7 mm	not available in Great Britain	768018
	DIA STONE-D130 PREMIUM for extremely hard materials and hard concrete (harder than B 35), active surface 2.560 mm ² , segment height 7 mm	190.20 228.24	769166
	DIA THERMO-D130 PREMIUM for removing thermoelastic materials, segment height 3 mm	253.30 303.96	768023
	DIA PAINT-D130 PREMIUM for removing thick layers of paint and clear coats from wood, segment height 2 mm	253.30 303.96	204176
	DIA HARD-D130-ST for old solid concrete, removal of epoxy resin from solid surfaces or coatings/paints from concrete, active surface 2.300 mm ² , segment height 5 mm	not available in Great Britain	499972
	DIA ABRASIVE-D130-ST for sand-based materials, screed, fresh concrete, adhesive on screed, sand-lime brick and cellular concrete, active surface 2.300 mm ² , segment height 5 mm	not available in Great Britain	499973
RG 80: Tool heads, milling heads, grinding discs			
Machine/tool head All variants: for RG 80, RGP 80, diameter 80 mm			
	SZ-RG 80 for hard plaster, adhesive residues and synthetic resin plaster, 12 carbide cutter wheels "pointed"	not available in Great Britain	767982
	FZ-RG 80 for soft plaster, fresh concrete, adhesive residues and protective coatings, 12 "flat" carbide-tipped milling heads	not available in Great Britain	769131
	HW COARSE-RG 80 for elastic coatings, adhesive on soft plaster, plaster and limestone on beams, thick and old layers of paint and roughening GRP, tool head with coarse tungsten-carbide disc	not available in Great Britain	769056
	DIA HARD-RG 80 for old solid concrete, removal of epoxy resin from solid surfaces or coatings/paints from concrete, tool head with hard diamond segments, active surface 1.385 mm ² , segment height 6 mm	not available in Great Britain	767983
	DIA ABRASIVE-RG 80 for sand-based materials, screed, fresh concrete, adhesive on screed, sand-lime brick and cellular concrete, tool head with abrasive diamond segments, active surface 1.385 mm ² , segment height 6 mm	not available in Great Britain	767984
Diamond disc All variants: diameter 80 mm, active surface 1.385 mm ² , segment height 6 mm			
	DIA HARD-D80 replacement disc for tool head DIA HARD-RG 80	not available in Great Britain	769054
	DIA ABRASIVE-D80 replacement disc for tool head DIA ABRASIVE-RG 80	not available in Great Britain	769055
Cutter wheel All variants: complete set with spacer discs and clamping elements			
	HW-SZ 12 12 carbide milling heads with "pointed teeth", replacement heads for SZ-RG 80	not available in Great Britain	769132
	HW-FZ 12 12 "flat" carbide-tipped milling heads, replacement heads for FZ-RG 80	not available in Great Britain	769133

RG 150: tool heads, milling wheels, grinding discs		RRP in £*	Order no.
Machine/tool head All variants: for RG 150, RGP 150, diameter 150 mm			
	SZ-RG 150 for hard plaster, adhesive residues and synthetic resin plaster, tool head with 35 carbide milling heads with "pointed teeth"	not available in Great Britain	768020
	FZ-RG 150 for soft plaster, fresh concrete, adhesive residues and protective coatings, tool head with 35 carbide milling heads with "flat teeth"	not available in Great Britain	769105
	DIA HARD-RG 150 for old solid concrete, removal of epoxy resin from solid surfaces or coatings/paints from concrete, tool head with hard diamond segments, active surface 3.660 mm ² , segment height 11 mm	not available in Great Britain	768021
	DIA ABRASIVE-RG 150 for sand-based materials, screed, fresh concrete, adhesive on screed, sand-lime brick and cellular concrete, tool head with abrasive diamond segments, active surface 3.660 mm ² , segment height 11 mm	not available in Great Britain	768022
	DIA THERMO-RG 150 For thermoelastic materials on concrete, screed, etc., tool head with THERMO diamond disc, segment height 3 mm	not available in Great Britain	769083
Diamond disc All variants: diameter 150 mm			
	DIA HARD-D150 replacement disc for tool head DIA HARD-D150, active surface 3.660 mm ² , segment height 11 mm	not available in Great Britain	769069
	DIA ABRASIVE-D150 replacement disc for tool head DIA ABRASIVE-D150, active surface 3.660 mm ² , segment height 11 mm	not available in Great Britain	769070
	DIA THERMO-D150 replacement disc for tool head DIA THERMO-D150, segment height 3 mm	not available in Great Britain	769085
Cutter wheel All variants: complete set with running sleeves			
	HW-SZ 35 35 carbide milling heads with "pointed teeth", replacement heads for SZ-RG 150	not available in Great Britain	769050
	HW-FZ 35 35 "flat carbide-tipped milling heads", replacement heads for FZ-RG 150	not available in Great Britain	769051

Wallpaper perforator TP 220

Completely new operating principle: Due to the rollers, which are quickly rotating at different speeds, funnel-shaped openings are produced that let water optimally flow in behind the wallpaper and then penetrate into it.



Technical data	TP 220
Telescoping handle length (mm)	900 – 1.300
Max. depth adjustment (mm)	3,5
Cutting diameter (mm)	45
Dimensions (L x W x H) (mm)	168 x 224 x 52
Weight (kg)	1,5

Protects the subsurface

The wallpaper penetration depth of the rollers can be set precisely, thereby protecting the wall against damage.

Items included	RRP in £*	Order no.
TP 220	151.40	495747
protective cover, telescoping handle	181.68	

Accessories	RRP in £*	Order no.
 Replacement roller EW-TP 220 for TP 220, 2 x rollers	40.10 48.12	496111

* Manufacturer's recommended retail price. Dealer prices may vary.
Excl. VAT. | Incl. VAT.
Vibration and emissions values can be found in the operating manual at www.festool.co.uk/vibration

14 Cutting



286 Cordless angle grinder



288 Freehand diamond cutting systems



290 Diamond cutting system



The robust solution for cutting and grinding.

The cordless angle grinder.

The AGC 18 cordless angle grinder is dust-resistant and extremely durable thanks to the enclosed brushless EC-TEC motor and protected electronics. Its continuous adjustable speed from 4500 to 8500 rpm allows for cutting and grinding that is suitable for any material.



Cordless angle grinder

AGC 18

Enclosed, brushless EC-TEC motor and cast electronics are safely protected against dust.



Brushless
EC-TEC motor

* Image does not correspond to the items included. Cutting guard and cutting disc not among the items included.

Technical data	AGC 18
Battery voltage (V)	18
Idle engine speed (RPM)	4.500 – 8.500
Disc dia. (mm)	125
Spindle thread/flange	M14
Battery capacity (Ah)	5,2
Weight with battery (kg)	2,7



Impressively ergonomic









The design is logically set out for optimal operation in cutting work. For especially smooth operation and fewer vibrations, the motor and housing are disconnected from each other.

All-inclusive safety while working

Soft start-up, electronic overload protection, motor brake and restart protection ensure safe work.



Items included		RRP in £*	Order no.
AGC 18	All variants: guard SH-AGC 18, Auxiliary handle VIBRASTOP, QNR-AGC 18 quick-acting clamping nut, flange BF-AGC 18, KF-AGC 18 face wrench, Systainer SYS3 M 187		
	AGC 18-125 EB-Basic without battery pack, without charger	280.00 336.00	576825
	AGC 18-125 5,2 EBI-Plus 2 x BP 18 Li 5.2 ASI battery pack, rapid charger TCL 6	513.00 615.60	577242

Accessories		RRP in £*	Order no.
	Protective cover SH-AGC 18-125 for AGC 18, for grinding work with flap discs and roughing discs, disc dia. 125 mm	8.10 9.72	203384
	Separating protective cover TSH-AGC 18-125 for AGC 18, for safe work with cutting discs made of bonded abrasives, disc dia. 125 mm	26.20 31.44	203378
	Hand protection HS-AGC 18 for AGC 18, for safe work with wire brushes	9.40 11.28	205193
	Auxiliary handle AH-M8 VIBRASTOP for AGC 18, DSC-AGC 18 FH, DSC-AG 125, DSC-AG 125 FH, VIBRASTOP, holder M8	not available in Great Britain	769620
	Keyless flange nut QRN-AGC 18 M14 for disc diameter 115 – 125 mm, for AGC 18, front clamping flange, sanders clamped without using tools, holder M14	23.40 28.08	204927
	Flange BF-AGC M14 for AGC 18, for M14 spindle threads, rear clamping flange, for clamping sanders, holder dia. 22,23 mm	7.20 8.64	204119
	Spanner KF-AGC 18 for AGC 18, for flange	11.70 14.04	204929
	Battery and charging technology from page 28		

* Manufacturer's recommended retail price. Dealer prices may vary.
Excl. VAT. | Incl. VAT.

Accurate separating cuts without dust – even with a battery.

The freehand diamond cutting systems.

To safeguard health when working, the dust extraction attachment for freehand cutting systems transports over 95% of the dust directly into the mobile dust extractor – making it ideal for dust-free cutting work on mineral materials in interiors. The open design allows a clear view of the cutting line for easy orientation on the scribe mark.

Freehand diamond cutting system

DSC-AG 125 FH

The ideal combination of a precise, handy angle grinder and efficient dust extraction with a cutting depth up to 27 mm.



Cordless freehand cutting system

DSC-AGC 18 FH

Time-saving thanks to the Bluetooth® battery pack, which starts a paired CLEANTEC mobile dust extractor automatically when the tool is switched on.



Technical data	DSC-AG 125 FH
Power consumption (watt)	1.400
Idle engine speed (RPM)	3.500 – 11.000
Disc dia. (mm)	125
Side clearance (mm)	23
Front clearance (mm)	16
Cutting depth (mm)	27
Spindle thread/flange	M14
Dust extraction connection dia. (mm)	36/27
Weight of cover/system (kg)	0,6/2,9

Technical data	DSC-AGC 18 FH
Battery voltage (V)	18
Battery capacity (Ah)	5,2
Idle engine speed (RPM)	4.500 – 8.500
Disc dia. (mm)	125
Side clearance (mm)	23
Front clearance (mm)	16
Cutting depth (mm)	27
Spindle thread/flange	M14
Dust extraction connection dia. (mm)	36/27
Weight with battery (kg)	3,2













Precise, unrestricted cutting

The dust extraction attachment provides a clear view of the cutting line and can be opened to allow work close to edges.

Cut dust-free easily

With a cutting depth of 27 mm, ideal for cutting mineral panel materials like tiles and natural stone.



Items included		RRP in £*	Order no.
DSC-AG 125 FH			
	DSC-AG 125 FH-Plus 240V extraction hood DCC-AG 125 FH, ALL-D125 Premium diamond cutting disc, plate TP-DSC-AG 125 FH, Auxiliary handle VIBRASTOP, SYS 3 TL Systainer	282.00 338.40	574806
DSC-AGC 18 FH			
	DSC-AGC 18-125 FH EB-Basic without battery pack, without charger, extraction hood, ALL-D125 Premium diamond cutting disc, plate TP-DSC-AG 125 FH, Auxiliary handle VIBRASTOP, clamping nut UF-AG M14, flange BF-DSC-AGC M14, KF-AG face wrench, Systainer SYS3 M 187	381.00 457.20	576829
Accessories			
	Auxiliary handle AH-M8 VIBRASTOP for AGC 18, DSC-AGC 18 FH, DSC-AG 125, DSC-AG 125 FH, VIBRASTOP, holder M8	not available in Great Britain	769620
	Plate TP-DSC-AG 125 FH for DSC-AG 125 FH Plus, DCC-AG 125 FH, DSC-AGC 18 FH, protects the surface against possible signs of abrasion during cutting, for fastening at guide table of extraction hood, dimensions [L x W x H] 195 x 103 x 14 mm	not available in Great Britain	200002
	Clamping nut All variants: for disc Ø 115 – 230 mm, front clamping flange, for clamping the grinding disc, holder M14		
	UF-AG M14 for DSC-AGC 18 FH, DSC-AG 125/230 (manufactured up to 02/2015) and RG 130 (manufactured up to 02/2015)	not available in Great Britain	769018
	UF-DSC/DSG-AG M14 for DSC-AG 125/230 (manufactured from 03/2015) and RG 130 (manufactured from 03/2015)	not available in Great Britain	200241
	Flange All variants: rear clamping flange, for clamping the grinding disc, holder dia. 22,23 mm		
	BF-AG 22,2 for DSC-AG 125/230, for disc Ø 115 – 230 mm	not available in Great Britain	767973
	BF-DSC-AGC M14 for M14 spindle threads, for DSC-AGC 18 FH	7.20 8.64	204121
	Spanner KF-AG for DSC-AGC 18 FH, DSC-AG 125/230, RG 130, for flange	not available in Great Britain	769040
	Battery and charging technology from page 28		

* Manufacturer's recommended retail price. Dealer prices may vary.
Excl. VAT. | Incl. VAT.

Precise cutting without dust. The diamond cutting system.

Gone are the days when cutting and grinding work was a dusty affair. The hazardous dust is now extracted reliably, the health of the user is protected and a free view of the workpiece guaranteed. A combination of compatible machines, accessories and consumables provides the perfect solution for efficient, perfect and accurate working progress.



Diamond cutting system **DSC-AG 125**

For clean and precise working with a cutting depth of up to 27 mm.

Technical data	DSC-AG 125
Power consumption (watt)	1.400
Idle engine speed (RPM)	3.500 – 11.000
Disc dia. (mm)	125
Side clearance (mm)	32
Front clearance (mm)	78
Cutting depth without/with guide rail (mm)	27/23
Dust extraction connection dia. (mm)	36/27
Weight of cover/system (kg)	2,2/4,1



More precise cutting





The DSC-AG 125 cutting system can be used on the Festool guide rail and therefore opens up new applications. This makes cutting materials of any size simple and precise.

Simply insert

The integrated plunge-cut function makes it possible to start cutting anywhere in the material. Simply insert at the point where the material is damaged and cut to the pre-selected cutting depth.











Items included		RRP in £*	Order no.
DSC-AG 125	All variants: extraction hood DCC-AG 125, ALL-D125 Premium diamond cutting disc, SYS 4 TL Systainer		
	DSC-AG 125 Plus 240V	317.00 380.40	574807
	DSC-AG 125 Plus-FS guide rail FS 800/2	374.00 448.80	574805

Accessories		RRP in £*	Order no.
	Auxiliary handle AH-M8 VIBRASTOP for AGC 18, DSC-AGC 18 FH, DSC-AG 125, DSC-AG 125 FH, VIBRASTOP, holder M8	not available in Great Britain	769620
	Clamping nut All variants: for disc Ø 115 – 230 mm, front clamping flange, for clamping the grinding disc, holder M14		
	UF-AG M14 for DSC-AGC 18 FH, DSC-AG 125/230 (manufactured up to 02/2015) and RG 130 (manufactured up to 02/2015)	not available in Great Britain	769018
	UF-DSC/DSG-AG M14 for DSC-AG 125/230 (manufactured from 03/2015) and RG 130 (manufactured from 03/2015)	not available in Great Britain	200241
	Flange BF-AG 22,2 for disc Ø 115 – 230 mm, for DSC-AG 125/230, rear clamping flange, for clamping the grinding disc, holder dia. 22,23 mm	not available in Great Britain	767973
	Spanner KF-AG for DSC-AGC 18 FH, DSC-AG 125/230, RG 130, for flange	not available in Great Britain	769040

* Manufacturer's recommended retail price. Dealer prices may vary.
Excl. VAT. | Incl. VAT.

14 Cutting

Cutting discs		RRP in £*	Order no.
Cut-off wheel All variants: for AGC 18, for cutting steel and stainless steel, qty. in pack 10 Units, hole dia. 22,23 mm, cutting width 1 mm			
	WS D 125/10 diameter 125 mm	33.60 40.32	204902
	WS D 115/10 diameter 115 mm	29.80 35.76	204903
Diamond cutting disc All variants: segment height 10 mm, diameter 125 mm, hole dia. 22,23 mm			
	ALL-D 125 PREMIUM for AGC 18, DSC-AGC 18 FH, DSC-AG 125, DSC-AG 125 FH, universal range of applications, cutting width 2 mm	68.20 81.84	769154
	C-D 125 PREMIUM for AGC 18, DSC-AGC 18 FH, DSC-AG 125, DSC-AG 125 FH, for concrete, cutting width 2,2 mm	79.80 95.76	769158
	MJ-D125 PREMIUM for DSC-AG 125, DSC-AG 125 FH, For cleaning grouted joints., cutting width 6,5 mm	91.40 109.68	769087
	TL-D125 PREMIUM for AGC 18, DSC-AGC 18 FH, DSC-AG 125, DSC-AG 125 FH, suitable for cutting floor tiles, roof tiles and concrete roofing tiles, cutting width 1,2 mm	45.30 54.36	769162

Extraction hoods	RRP in £*	Order no.
 <p>Dust extraction attachment DCC-AG 125 FH for DSC-AG 125, DSC-AG 125 FH and AG 125, for dust-free work with the angle grinder, hexagon socket wrench, diameter 125 mm, dust extraction connection dia. 36/27 mm, weight 0,6 kg</p>	<p>not available in Great Britain</p>	<p>769953</p>
 <p>Dust extraction attachment DCC-AG 125 for AG 125, AGP 125-12/14, for the reduction of dust, hexagon socket wrench, KF-AG face wrench, Clamping flange, diameter 125 mm, weight 2,2 kg, dust extraction connection dia. 36/27 mm</p>	<p>155.90 187.08</p>	<p>769075</p>

High performance: The SYS-PowerStation.

NEW

The SYS-PowerStation is your portable electrical outlet module. With 2,990 watts permanent power and up to 11,000 watts short-term power, it operates all mains-powered tools continuously with no losses of performance – whether that’s dust extractors, large saws or jack hammers!

You can find more information on page 312



* Manufacturer’s recommended retail price. Dealer prices may vary.
Excl. VAT. | Incl. VAT.

15 Illuminating





296 SYSLITE KAL II
working light



296 SYSLITE DUO
working light



296 SYSLITE STL 450
surface control light

See everything. Work with more precision.

The right light for every situation.

Whether you choose the SYSLITE DUO or SYSLITE KAL working lights, or the SYSLITE STL 450 surface inspection light – all are designed to simplify your work. They provide excellent lighting for every situation – from small surfaces through to entire rooms. Because high-quality lighting is essential for good work.

Working light **SYSLITE KAL II**

Turns dark surfaces into work surfaces in an extremely versatile manner. Can be positioned or suspended in five positions and powered by a wide variety of sources (internal battery, battery pack, mains cable or car charger).

Working light **SYSLITE DUO**

Extensive illumination (mains-powered) of entire rooms with light quality that replicates daylight. Can be used in a wide variety of ways: Stands alone, is attached to a Festool tripod or, if preferred, is hung on a hook using the suspension means on the rear.







Grazing light **SYSLITE STL 450**





The inspection light optimally focuses the light – ideal for inspecting surfaces even when working. Variable height and inclination with compatible tripod and long cable for a large range of applications.





Technical data	KAL II	DUO	STL 450
Lumen value 1st/2nd stage (lm)	310/769	8.000/-	1.200/-
Light source (watt)	18	112	18
Colour (kelvin)	-	5.000	5.000
Operating time (internal battery) 1st/2nd stage (min)	290/120	-	-
Operation with Festool slide-in battery packs (V)	10,8 – 18	-	-
Housing protection class	IP 2X	IP 55	IP 55
Cable length (m)	-	4,8	5
Thread size stand (")	1/4	-	-
Weight (without battery pack) (kg)	0,7	-	-
Weight (kg)	-	3,5	1,5

Items included	RRP in £*	Order no.
KAL II		
 KAL II 240V integrated lithium-ion battery 7.2 V, 230 V adapter, car charger adapter, transport bag	161.00 193.20	500722
DUO		
All variants: Systainer SYS3 M 237		
 DUO-Plus 240V	299.00 358.80	576409
 DUO-Set 240V ST DUO 200 tripod	431.00 517.20	576404
STL 450		
 STL 450 bag	not available in Great Britain	201937

Accessories	RRP in £*	Order no.
 Magnetic spherical head MA KAL for Festool guide rail clamps, spherical head can be rotated 360°, for flexible positioning of the work light SYSLITE KAL and KAL II, pad for external stand, magnetic holding force 16 kg	47.20 56.64	499814
 Tripod ST DUO 200 for SYSLITE DUO, continuously height-adjustable from 150 to 200 cm via two pull-outs, folds to save space and easy to transport at just 5,6 kg	131.50 157.80	200038
 Adapter AD-ST DUO 200 for SYSLITE STL 450 inspection light, for attaching to the ST DUO 200 tripod, weight 1,1 kg	73.60 88.32	201936
 Bag ST-BAG for the ST DUO 200 tripod, STL 450 surface control light and AD-ST DUO 200 adapter, transport bag with shoulder strap and carry handle, for storage and simple transport of the tripod for the SYSLITE DUO and the SYSLITE STL surface control light, with practical side pockets for additional system accessories	64.80 77.76	203639
 Battery and charging technology from page 28		

* Manufacturer's recommended retail price. Dealer prices may vary.

Excl. VAT. | Incl. VAT.

Vibration and emissions values can be found in the operating manual at www.festool.co.uk/vibration

16 Systainer





303 Systainer



304 Organizer



306 Systainer with lid compartment



306 SYS-Combi



307 SORTAINER



307 ToolBox



308 SYS-StorageBox



308 Systainer-Port



308 Systainer pull-out drawer



308 Transport equipment



309 Application Systainer



309 SYS-PowerHub power distribution box



Systainer³ combines workshop and construction site.

The new Systainer³ generation enables you to be more mobile than ever before. Festool, TANOS and bott have collaboratively developed a mobility system that brings the workshop and the construction site closer together. It is perfectly integrated into Bott vario3 vehicle equipment, allowing you to safely deploy the familiar arrangement and simple handling that you are used to from the Systainer system in your vehicle as well.



Secure connection

All Systainer³ can be connected to one another and to other generations.

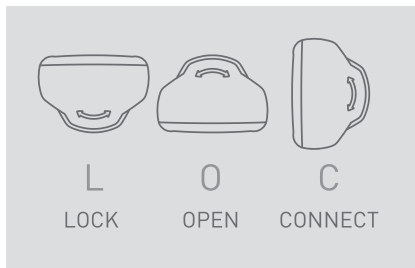

Combines three functions

The central control element of the Systainer allows you to lock, open, or connect with a single turn. The Systainer can always be opened with no need to decouple it.

Available system heights (mm)	Systainer T-LOC	Systainer ³			Systainer ³ Organizer		Systainer ³ ToolBox	
	SYS-MINI	SYS3 M	SYS3 L	SYS3 XXL	SYS3 ORG M	SYS3 ORG L	SYS3 TB M	SYS3 TB L
	Base area 265 x 171	Base area 396 x 296	Base area 508 x 296	Base area 792 x 296	Base area 396 x 296	Base area 508 x 296	Base area 396 x 296	Base area 508 x 296
71	●	-	-	-	-	-	-	-
89	-	-	-	-	●	●	-	-
112	-	●	-	-	-	-	-	-
137	-	●	●	-	-	-	●	●
142	●	-	-	-	-	-	-	-
187	-	●	●	-	-	-	-	-
237	-	●	●	●	-	-	●	●
337	-	●	-	●	-	-	-	-
437	-	●	-	-	-	-	-	-



Systainer T-LOC



Systainer³



Systainer³ Organizer



Systainer³ ToolBox

Simply tidier, more clearly arranged and better organised.

For a long time now, Systainers have been more than just storage boxes for high-quality tools. They bring organisation, mobility and time savings to the workplace. Festool has been setting standards when it comes to functionality with the Systainer organisation system since 1993. The Systainer³ is yet another milestone – and, like all Festool solutions, fits perfectly into the system.

Tools underneath and music on top: The TOPROCK Bluetooth® speaker allows you to take your music with you in your Systainer wherever you go.

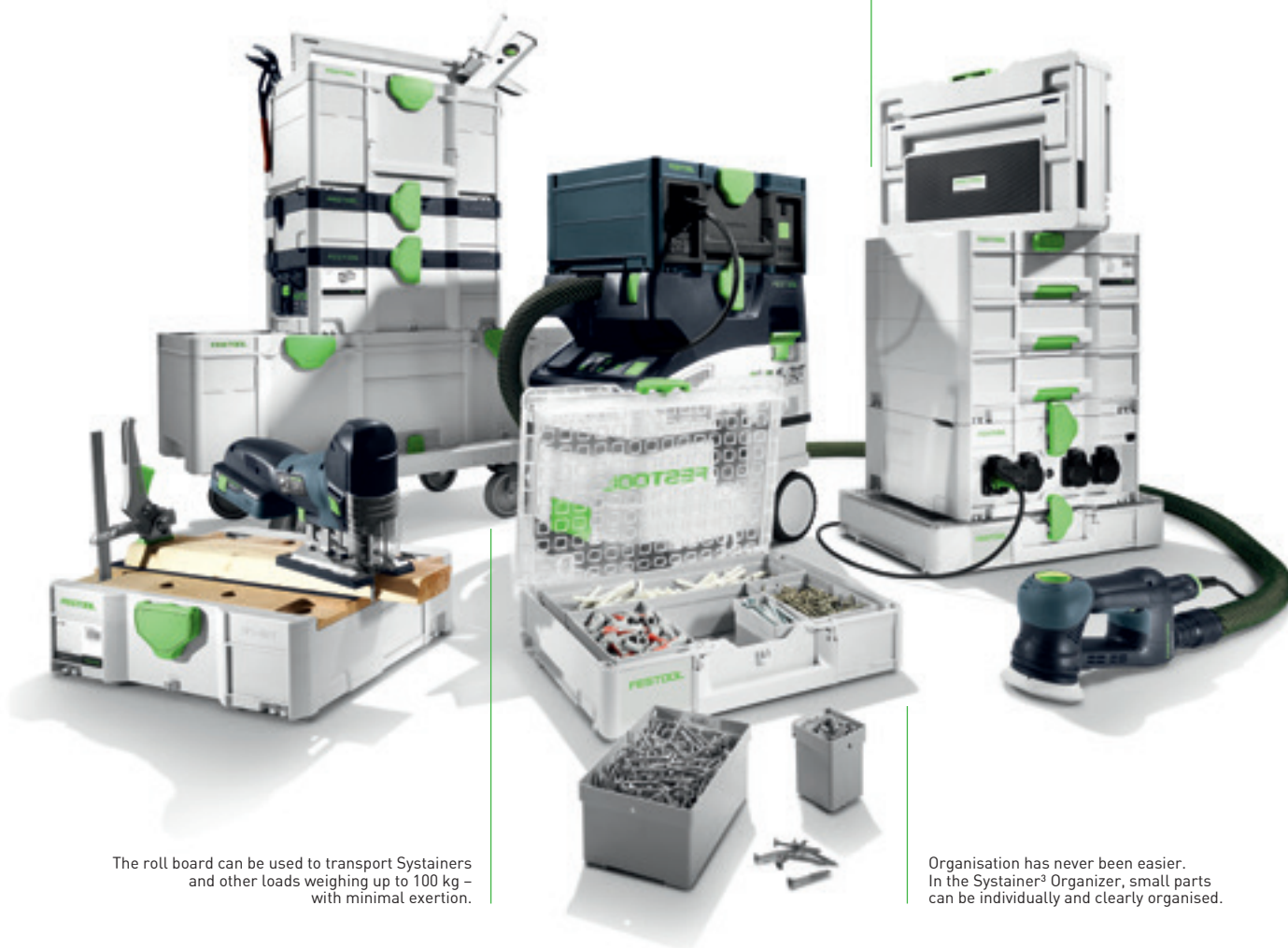

















The roll board can be used to transport Systainers and other loads weighing up to 100 kg – with minimal exertion.

Organisation has never been easier. In the Systainer³ Organizer, small parts can be individually and clearly organised.

Festool creates new innovations – and new standards. We will gradually be converting our portfolio to the Systainer³ system.















All information on this can be found at any time on www.festool.co.uk/mobility











Systainer ³ M		RRP in £*	Order no.
Systainer³ All variants: incl. cover for label field, load capacity 20 kg, load capacity (connected) 40 kg, permitted lid load 100 kg			
	SYS3 M 112 dimensions with adjustable legs [L x W x H] 396 x 296 x 112 mm, inner dimensions [L x W x H] 389 x 275 x 71 mm, volume 7,7 l, weight 1,4 kg	50.90 61.08	204840
	SYS3 M 137 for practical transportation of hand tools, consumable materials and accessories, dimensions with adjustable legs [L x W x H] 396 x 296 x 137 mm, inner dimensions [L x W x H] 389 x 275 x 96 mm, volume 10,4 l, weight 1,5 kg	54.70 65.64	204841
	SYS3 M 187 dimensions with adjustable legs [L x W x H] 396 x 296 x 187 mm, inner dimensions [L x W x H] 389 x 275 x 146 mm, volume 15,9 l, weight 1,7 kg	58.40 70.08	204842
	SYS3 M 237 dimensions with adjustable legs [L x W x H] 396 x 296 x 237 mm, inner dimensions [L x W x H] 389 x 275 x 196 mm, volume 21,4 l, weight 1,9 kg	62.10 74.52	204843
	SYS3 M 337 dimensions with adjustable legs [L x W x H] 396 x 296 x 337 mm, inner dimensions [L x W x H] 389 x 275 x 296 mm, volume 32,4 l, weight 2,4 kg	65.80 78.96	204844
	SYS3 M 437 dimensions with adjustable legs [L x W x H] 396 x 296 x 437 mm, inner dimensions [L x W x H] 389 x 275 x 394 mm, volume 43,1 l, weight 2,9 kg	69.40 83.28	204845
	Cover pad SE-DP SYS3 M for Systainer ³ M, protects the content	5.80 6.96	204940
	Base pad SE-BP SYS3 M for Systainer ³ M, protects the content	6.40 7.68	204941
	Grid foam SE-VAR SYS3 M/2 for Systainer ³ M, diced sections can be pushed out to produce any desired aperture, qty. in pack 2 Units	15.60 18.72	204942
	Cartridge inlay TZE-KT SYS3 M for Systainer ³ M 337/437, for storage of cartridges and cartridge caps	19.40 23.28	204943

Systainer ³ L		RRP in £*	Order no.
Systainer³ All variants: with a broader base area for even more space, incl. cover for label field, load capacity 20 kg, load capacity (connected) 40 kg, permitted lid load 100 kg			
	SYS3 L 137 dimensions with adjustable legs [L x W x H] 508 x 296 x 137 mm, inner dimensions [L x W x H] 501 x 275 x 94 mm, volume 13,2 l, weight 1,9 kg	66.30 79.56	204846
	SYS3 L 187 dimensions with adjustable legs [L x W x H] 508 x 296 x 187 mm, inner dimensions [L x W x H] 501 x 275 x 144 mm, volume 20,2 l, weight 2,1 kg	70.90 85.08	204847
	SYS3 L 237 dimensions with adjustable legs [L x W x H] 508 x 296 x 237 mm, inner dimensions [L x W x H] 501 x 275 x 194 mm, volume 27,4 l, weight 2,4 kg	75.60 90.72	204848
	Cover pad SE-DP SYS3 L for Systainer ³ L, protects the content	13.60 16.32	204944
	Base pad SE-BP SYS3 L for Systainer ³ L, protects the content	11.70 14.04	204945
	Grid foam SE-VAR SYS3 L/2 for Systainer ³ L, diced sections can be pushed out to produce any desired aperture, qty. in pack 2 Units	34.40 41.28	204946











* Manufacturer's recommended retail price. Dealer prices may vary.
 Excl. VAT. | Incl. VAT.











16 Systainer

Systainer ³ Organizer M		RRP in £*	Order no.
<p>Systainer³ Organizer All variants: clear organisation and transportation solution for small parts with transparent lid, dimensions with adjustable legs (L x W x H) 396 x 296 x 89 mm, inner dimensions (L x W x H) 389 x 246 x 60 mm, volume 7,4 l, load capacity 20 kg, permitted lid load 100 kg</p>			
	<p>SYS3 ORG M 89 without plastic containers, weight 1,6 kg</p>	<p>50.90 61.08</p>	204852
	<p>SYS3 ORG M 89 22xESB 13 x plastic container 50 x 50 x 68, 8 x plastic container 50 x 100 x 68, plastic container 100 x 150 x 68, weight 2,2 kg</p>	<p>63.90 76.68</p>	204853
	<p>SYS3 ORG M 89 6xESB plastic container 50 x 50 x 68, plastic container 50 x 100 x 68, 3 x plastic container 100 x 150 x 68, plastic container 100 x 350 x 68, weight 2 kg</p>	<p>63.90 76.68</p>	204854
Systainer ³ Organizer L		RRP in £*	Order no.
<p>Systainer³ Organizer All variants: with a broader base area for even more space, clear organisation and transportation solution for small parts with transparent lid, dimensions with adjustable legs (L x W x H) 508 x 296 x 89 mm, inner dimensions (L x W x H) 501 x 278 x 60 mm, volume 9,7 l, load capacity 20 kg, permitted lid load 100 kg</p>			
	<p>SYS3 ORG L 89 without plastic containers, weight 2 kg</p>	<p>61.70 74.04</p>	204855
	<p>SYS3 ORG L 89 20xESB 10 x plastic container 50 x 50 x 68, 6 x plastic container 50 x 100 x 68, 2 x plastic container 100 x 100 x 68, plastic container 100 x 150 x 68, plastic container 150 x 150 x 68, weight 2,7 kg</p>	<p>74.70 89.64</p>	204856
	<p>SYS3 ORG L 89 10xESB plastic container 50 x 50 x 68, 4 x plastic container 50 x 100 x 68, plastic container 100 x 100 x 68, 3 x plastic container 100 x 150 x 68, plastic container 100 x 350 x 68, weight 2,4 kg</p>	<p>74.70 89.64</p>	204857
Accessories for Systainer ³ Organizer M/L		RRP in £*	Order no.
<p>Plastic containers All variants: for Systainer³ Organizer, for clear storage and organisation, boxes excl. content</p>			
	<p>Box 50x50x68/10 dimensions (L x W x H) 50 x 50 x 68 mm, qty. in pack 10 Units</p>	<p>11.40 13.68</p>	204858
	<p>Box 50x100x68/10 dimensions (L x W x H) 50 x 100 x 68 mm, qty. in pack 10 Units</p>	<p>12.30 14.76</p>	204859
	<p>Box 100x100x68/6 dimensions (L x W x H) 100 x 100 x 68 mm, qty. in pack 6 Units</p>	<p>11.40 13.68</p>	204860
	<p>Box 100x150x68/6 dimensions (L x W x H) 100 x 150 x 68 mm, qty. in pack 6 Units</p>	<p>12.30 14.76</p>	204861
	<p>Box 100x350x68/2 dimensions (L x W x H) 100 x 350 x 68 mm, qty. in pack 2 Units</p>	<p>13.20 15.84</p>	204862
	<p>Box 150x150x68/6 dimensions (L x W x H) 150 x 150 x 68 mm, qty. in pack 6 Units</p>	<p>9.40 11.28</p>	204863
	<p>Box 150x300x68/2 dimensions (L x W x H) 150 x 300 x 68 mm, qty. in pack 2 Units</p>	<p>10.50 12.60</p>	204864
	<p>Marking BS-BOX/25 for all plastic containers with a height of 68 mm, for individual labelling, qty. in pack 25 Units</p>	<p>10.00 12.00</p>	204949

Systainer ³ XXL		RRP in £*	Order no.
Systainer³ All variants: incl. cover for label field, load capacity 40 kg, load capacity (connected) 80 kg, permitted lid load 100 kg			
	SYS3 XXL 237 dimensions with adjustable legs [L x W x H] 792 x 296 x 237 mm, inner dimensions [L x W x H] 786 x 279 x 188 mm, volume 42,3 l, weight 3,64 kg	83.20 99.84	204850
	SYS3 XXL 337 dimensions with adjustable legs [L x W x H] 792 x 296 x 337 mm, inner dimensions [L x W x H] 786 x 279 x 288 mm, volume 64,2 l, weight 4,33 kg	90.40 108.48	204851
	Cover pad SE-DP SYS3 XXL for Systainer ³ XXL, protects the content	28.70 34.44	204947
	Base pad SE-BP SYS3 XXL for Systainer ³ XXL, protects the content	31.90 38.28	204948
MINI-Systainer T-LOC		RRP in £*	Order no.
MINI-Systainer T-LOC All variants: for clear and structured arrangement of small parts and hand-held tools, can be combined with SYS-MINI 1 and 3 TL, cannot be connected to Systainer³, Systainer T-LOC or Systainer classic			
	SYS-MINI 1 TL dimensions [L x W x H] 265 x 171 x 71 mm, inner dimensions [L x W x H] 255 x 155 x 53 mm, weight 0,4 kg	16.20 19.44	499622
	SYS-MINI 1 TL TRA transparent cover, dimensions [L x W x H] 265 x 171 x 71 mm, inner dimensions [L x W x H] 255 x 155 x 53 mm, weight 0,4 kg	19.50 23.40	203813
	SYS-MINI 1 TL TRA UNI TZE-UNI SYS MINI TL multi-purpose insert, transparent cover, dimensions [L x W x H] 265 x 171 x 71 mm, inner dimensions [L x W x H] 255 x 155 x 53 mm, weight 0,6 kg	32.80 39.36	203821
	SYS-MINI 3 TL dimensions [L x W x H] 265 x 171 x 142 mm, inner dimensions [L x W x H] 255 x 155 x 124 mm, weight 0,6 kg	21.30 25.56	202544
	Cover pad SE-DP SYS-MINI TL for SYS MINI TL, dimensions [L x W x H] 247 x 134 x 15 mm	5.80 6.96	499619
	Multi-purpose insert TZE-UNI SYS MINI TL for SYS MINI TL, dimensions [L x W x H] 258 x 163 x 45 mm	7.80 9.36	499620











16 Systainer





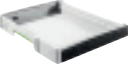

Systainer T-LOC with lid compartment		RRP in £*	Order no.
Systainer T-LOC DF All variants: incl. cover for label field			
	SYS 1 TL-DF dimensions (L x W x H) 396 x 296 x 105 mm, dimensions with adjustable legs (L x W x H) 396 x 296 x 112 mm, inner dimensions (L x W x H) 383 x 273 x 68 mm, weight 1,5 kg	61.30 73.56	497851
	SYS 2 TL-DF dimensions (L x W x H) 396 x 296 x 157,5 mm, dimensions with adjustable legs (L x W x H) 396 x 296 x 164,5 mm, inner dimensions (L x W x H) 383 x 267 x 121 mm, weight 1,7 kg	65.80 78.96	497852
	SYS 3 TL-DF dimensions (L x W x H) 396 x 296 x 210 mm, dimensions with adjustable legs (L x W x H) 396 x 296 x 217 mm, inner dimensions (L x W x H) 382 x 266 x 173 mm, weight 2 kg	69.20 83.04	498390
Accessories for Systainer T-LOC with lid compartment			
	Bit assortment DB CE 50/12-Set 1 for all Festool cordless drills with CENTROTEC interface, for SYS TL with lid compartment, 12-piece, in lid compartment insert, PH 1 bit, PH 2 bit, PH 3 bit, PZ 1 bit, bit PZ 2, PZ 3 bit, TX 10 bit, TX 15 bit, TX 20 bit, TX 25 bit, TX 30 bit, TX 40 bit, length 50 mm	73.80 88.56	205089
	Drill bit case DB WOOD CE SET TL 6x long spiral wood drill bits with centring point, qty. in pack 6 Units, diameter 4, 2 x 5, 6, 8, 10 mm	54.20 65.04	769093
	Bit assortment BITS + BHS 60 CE TL 24x for SYS TL with lid compartment, 24-piece, 2 x PH 1 bit, 2 x PH 2 bit, 2 x PH 3 bit, 2 x PZ 1 bit, 2 x bit PZ 2, 2 x PZ 3 bit, 2 x TX 10 bit, 2 x TX 15 bit, 2 x TX 20 bit, 2 x TX 25 bit, 2 x TX 30 bit, 2 x TX 40 bit, CENTROTEC BHS 60 CE rapid-change bit holder	35.20 42.24	769094
	Bit set CENTROTEC BITS CE SET TL 6X for SYS TL with lid compartment, with CENTROTEC interface, in lid compartment insert, PZ 2 bit, PZ 3 bit, TX 15 bit, TX 20 bit, TX 25 bit, TX 30 bit, qty. in pack 6 Units, length 100 mm	39.70 47.64	769095
	Masonry drill DB STONE CE SET TL for SYS TL with lid compartment, for cordless impact screwdrivers, impact drills with FastFix interface, with CENTROTEC interface, for machining stone and masonry, with long-lasting carbide-tipped cutter, 6 CENTROTEC masonry drill bits: dia. 4, 5, 2 x 6, 8, 10 mm	50.90 61.08	769096
Systainer T-LOC SYS-Combi			
Systainer T-LOC All variants: flexibly divisible drawer for accessories, consumables, small parts and sundries, internal dimensions of the drawer (L x W x H) 350 x 255 x 69 mm			
	SYS-COMBI 2 combination of the Systainer T-LOC size 2 and a spacious drawer, dimensions (L x W x H) 396 x 296 x 263 mm, dimensions with adjustable legs (L x W x H) 396 x 296 x 270 mm, internal dimensions of the top compartment (L x W x H) 383 x 267 x 127 mm, weight 3,2 kg	97.90 117.48	200117
	SYS-COMBI 3 combination of the Systainer T-LOC size 3 and a spacious drawer, dimensions (L x W x H) 396 x 296 x 315 mm, dimensions with adjustable legs (L x W x H) 396 x 296 x 322 mm, internal dimensions of the top compartment (L x W x H) 382 x 266 x 180 mm, weight 3,5 kg	105.20 126.24	200118
	Plastic containers Set 60x60/120x71 3xFT for SYS-COMBI 2, SYS-COMBI 3 and SYS 4 TL-SORT/3, plastic containers and compartment dividers for individual drawer partitions, 8 x box of plastic containers 60 x 60 x 71 mm, 4 x box of plastic containers 60 x 120 x 71 mm, 3 x compartment dividers, 2 x cover pads	18.70 22.44	201124

SORTAINER		RRP in £*	Order no.
	SORTAINER SYS 4 TL-SORT/3 three drawers, each with a capacity of 6.7 litres, can be set up and divided individually with plastic containers and partitions (plastic containers and small partitions are not included), compatible and can be connected to all Systainer generations, mobile dust extractors and many other system accessories, dimensions [L x W x H] 396 x 296 x 322 mm, weight 5,95 kg	108.10 129.72	200119
	Plastic containers Set 60x60/120x71 3xFT for SYS-COMBI 2, SYS-COMBI 3 and SYS 4 TL-SORT/3, plastic containers and compartment dividers for individual drawer partitions, 8 x box of plastic containers 60 x 60 x 71 mm, 4 x box of plastic containers 60 x 120 x 71 mm, 3 x compartment dividers, 2 x cover pads	18.70 22.44	201124
SORTAINER All variants: 2 dividers per drawer, dimensions [L x W x H] 395 x 295 x 210 mm			
	SYS 3-SORT/4 2 x small drawer (L x W x D) 255 x 75 x 30 mm, medium drawer (L x W x D) 255 x 165 x 30 mm, large drawer (L x W x D) 255 x 348 x 85 mm, 6 x label holders, 8 x lettering strips, weight 4 kg	120.70 144.84	491522
	SYS 3-SORT/6 6 x medium drawer (L x W x D) 255 x 165 x 30 mm, 6 x label holders, 8 x lettering strips, weight 4,9 kg	134.40 161.28	491984
	SYS 3-SORT/9 6 x small drawer (L x W x D) 255 x 75 x 30 mm, 3 x medium drawer (L x W x D) 255 x 165 x 30 mm, 9 x label holders, 16 x lettering strips, weight 5,1 kg	134.40 161.28	491985
	SYS 3-SORT/12 12 x small drawer (L x W x D) 255 x 75 x 30 mm, 12 x label holders, 16 x lettering strips, weight 5,3 kg	134.40 161.28	491986
Systainer³ ToolBox M		RRP in £*	Order no.
Systainer³ ToolBox All variants: for practical transportation of hand tools, consumable materials and accessories, incl. cover for label field, load capacity 20 kg, load capacity (connected) 40 kg			
	SYS3 TB M 137 dimensions with adjustable legs [L x W x H] 396 x 296 x 137 mm, volume 10,4 l, weight 1,3 kg	43.30 51.96	204865
	SYS3 TB M 237 dimensions with adjustable legs [L x W x H] 396 x 296 x 237 mm, volume 21,4 l, weight 1,7 kg	49.30 59.16	204866
Systainer³ ToolBox L		RRP in £*	Order no.
Systainer³ ToolBox All variants: with a broader base area for even more space, for practical transportation of hand tools, consumable materials and accessories, incl. cover for label field, load capacity 20 kg, load capacity (connected) 40 kg			
	SYS3 TB L 137 dimensions with adjustable legs [L x W x H] 508 x 296 x 137 mm, volume 13,2 l, weight 1,9 kg	52.50 63.00	204867
	SYS3 TB L 237 volume 27,4 l, dimensions with adjustable legs [L x W x H] 508 x 296 x 237 mm, weight 2,4 kg	60.00 72.00	204868

* Manufacturer's recommended retail price. Dealer prices may vary.
Excl. VAT. | Incl. VAT.

16 Systainer

SYS-StorageBox		RRP in £*	Order no.
	SYS-StorageBox SYS-SB plastic container, no content, with individually removable plastic containers, can be connected to the entire Systainer range (except SYS-Mini), 2 x box 60 x 60 x 71 mm SYS-SB, 2 x box 60 x 120 x 71 mm SYS-SB, 1 x box 180 x 120 x 71 mm SYS-SB, dimensions [L x W x H] 396 x 296 x 167 mm, height including handle 240 mm, weight 2,5 kg	88.00 105.60	499901
Plastic containers All variants: for SYS-Storage Box SYS-SB			
	Box 60x60x71/6 SYS-SB qty. in pack 6 Units, dimensions [L x W x H] 60 x 60 x 71 mm	9.80 11.76	500066
	Box 60x120x71/4 SYS-SB qty. in pack 4 Units, dimensions [L x W x H] 60 x 120 x 71 mm	11.30 13.56	500067
	Box 180x120x71/2 SYS-SB qty. in pack 2 Units, dimensions [L x W x H] 180 x 120 x 71 mm	12.50 15.00	500068
Systainer-Port		RRP in £*	Order no.
	Systainer-Port SYS-PORT 500/2 the height of the individual pull-out drawers can be adjusted – for flexible equipping with different Systainer and SORTAINER sizes, no admission for assembly in car, without Systainer, stable full metal body, 5 x labels for drawers, with 3 Systainer telescopic drawers, dimensions [L x W x H] 400 x 500 x 500 mm, weight 19 kg	401.30 481.56	491921
	Systainer-Port SYS-PORT 1000/2 the height of the individual pull-out drawers can be adjusted – for flexible equipping with different Systainer and SORTAINER sizes, no admission for assembly in car, without Systainer, stable full metal body, 5 x labels for drawers, with 5 Systainer telescopic drawers, 4 ball bearing-mounted swivel castors (2 with locking brakes), dimensions [L x W x H] 400 x 500 x 1.100 mm, weight 33 kg	539.70 647.64	491922
	Set of castors SYS-PORT R/2 for SYS port, for assembly on SYS-Port, diameter 75 mm	71.50 85.80	491932
	Telescopic drawer SYS-PORT/TA	99.40 119.28	491923
Systainer pull-out drawer		RRP in £*	Order no.
Pull-out drawer All variants: for Systainer ³ M, T-LOC and Classic, for constructing an individual shelf system, in 32 hole grid, dimensions [L x W x H] 425 x 376 x 57 mm, max. load 20 kg			
	SYS-AZ	37.80 45.36	500692
	SYS-AZ-Set qty. in pack 5 Units	188.60 226.32	500767
	Lock S-AZ for SYS-AZ, simultaneous lock, for subsequent installation in the pull-out drawer SYS-AZ, locks the individual pull-out drawer on the side of the body (simultaneous)	11.20 13.44	500693
Means of transport for Systainer		RRP in £*	Order no.
	Roll board SYS-RB for easy transportation of Systainer ³ and T-LOC, 4 robust handles, 4 steering rollers, (2 of which can be locked), feedthroughs for straps, bASE 508 x 396 mm, load capacity 100 kg, roll dia. 100 mm, weight 2,9 kg	76.00 91.20	204869
	SYS-Roll SYS-Roll 100 for transporting Systainer ³ , T-LOC and Classic, extra large wheels [D 200 mm] for easy transportation up and down steps, rotating lockable front rollers – manoeuvre in all directions, incl. safety belt, dimensions [L x W x H] 440 x 600 x 1.100 mm, total load capacity 100 kg, drawer load capacity 5 kg, front roll dia. 75 mm, rear roll dia. 200 mm, weight 6,5 kg	161.70 194.04	498660
	Mobile workshop from page 318		

Systainer T-LOC SYS-MFT		RRP in £*	Order no.
	Systainer T-LOC SYS-MFT incl. cover for label field, can be connected to the entire Systainer range (except SYS-MINI), simple, compact transportation, cover with MDF board for clamping and fixing workpieces, dimensions (L x W x H) 396 x 296 x 105 mm, dimensions with adjustable legs (L x W x H) 396 x 296 x 112 mm, inner dimensions (L x W x H) 383 x 273 x 75 mm, weight 2 kg	63.50 76.20	500076
Application Systainer with insert for hand tools			
	Systainer³ SYS3 HWZ M 337 with wooden insert for hand tools, items included without tools (equipment recommendation), dimensions with adjustable legs (L x W x H) 396 x 296 x 337 mm, inner dimensions (L x W x H) 389 x 275 x 296 mm, volume 32,4 l, load capacity 20 kg, load capacity (connected) 40 kg, permitted lid load 100 kg, weight 4,4 kg	142.30 170.76	205518
Empty Systainer with inlay			
NEW	Systainer³ SYS3 M 187 ENG 18V suitable for the BP 18 Li battery packs and the TCL 6, TCL 6 DUO and SCA 8 chargers, not suitable for the Ergo battery packs (ETSC, DTSC, RTSC), for practical and tidy storage and transport of up to four 18 V battery packs (excluding Ergo battery pack) and two Li-ion rapid chargers (TCL 6, SCA) or one TCL 6 DUO dual charger, number of compartments (battery packs) 4, number of compartments (charger) 2, SYSTAINER size SYS3 M 187, dimensions with adjustable legs (L x W x H) 396 x 296 x 187 mm, weight 1,8 kg	64.10 76.92	577133
			
Others			
NEW	SYS-PowerStation from page 312		
			
	Bluetooth® speaker from page 315		
	Cover AB-BF SYS TL 55x85mm /10 transparent cover for the labelling panels of Systainer³, Systainer³ Organizer and T-LOC, protects the labelling from damage and moisture, qty. in pack 10 Units	4.50 5.40	497855

Power distributor SYS-PowerHub

The first cable drum with corners and edges – and a system. There is plenty of room inside for the securely connected 10 m cable. The SYS-PowerHub also has room for any battery packs or small parts required and can simultaneously supply up to four power tools with electricity.



Technical data	SYS-PH	
IP protection class (with closed guards)	IP44	
Cable length (m)	10	
Power consumption (watt)	2.500	
Number of sockets	5	
Dimensions (L x W x H) (mm)	396 x 296 x 157,5	
Inner dimensions (L x W x H) (mm)	383 x 154 x 128	
Weight (kg)	4,2	
Items included	RRP in £*	Order no.
SYS-PH 240V Systainer SYS 2 T-LOC	152.00 182.40	200234



Protection zone

A mobile phone can be connected to the internal socket, for example, where it will be securely protected against dust and contamination. The integrated thermal overload protection provides additional safety.

* Manufacturer's recommended retail price. Dealer prices may vary.
Excl. VAT. | Incl. VAT.

Vibration and emissions values can be found in the operating manual at www.festool.co.uk/vibration

17 Workplace organisation

Power socket to go.
The new SYS-PowerStation.
You can find more information
on page 312.



NEW



312 SYS-PowerStation



314 SYSROCK
construction site radio



315 Bluetooth® TOPROCK
speaker



316 Multifunction table



318 Mobile workshop



320 Saw table and work bench



321 Angle stop

NEW



322 Guide-rails



326 GECKO
dual suction pad



326 Vacuum clamping nozzle
CT WINGS

NEW



327 Phone charger



328 Organisation centre



330 plug it accessories

Power socket to go. The SYS-PowerStation.

The SYS-PowerStation provides power. Even where there would otherwise be none. As a high-performance energy storage solution, it allows users to be independent of traditional power sources, such as electrical outlet modules, generators or site distribution boards – to guarantee predictable everyday work. Without the need to find a power supply or the hassle of pulling cables, overloaded site distribution boards or problems with fuses switching off. Just like a normal 230 V electrical outlet module.

NEW



SYS-PowerStation SYS-PST 1500

The SYS-PowerStation powers tools and machines from any manufacturer – they can all still be used and handled in the usual system. Thanks to the high-quality power, even electronically sensitive machines can be operated without a hitch.



Power. Anytime, anywhere

The SYS-PowerStation stores 1500 watt-hours of energy – for most applications, that is enough for an entire working day.

High performance

With 2,990 watts permanent power and up to 11,000 watts short-term power, it provides enough energy to power all mains-powered tools – even extractors, large saws and hammer drills – continuously with no losses of performance.





Dust-free work

Turns every extractor into a cordless extractor – and operates an additional tool at the same time via the electrical outlet module on the extractor. This means that you can now work with dust extraction anywhere.



Planning

Every construction site operation can be safely planned from now on. The availability of power is no longer an element of uncertainty.



Innovative

Its completely new, globally innovative technology makes the SYS-PowerStation a high-performance energy storage solution: Outstanding performance values, long usage times and short charging times in compact Systainer form, weighing just 16 kg.

Technical data	SYS-PST
Output voltage	230 V ~ / 50 Hz pure sine
Continuous power (watt)	2.990
Peak power (<0.5 sec.) (watt)	11.000
Peak power (<6.0 sec.) (watt)	7.200
Nominal energy content (Wh)	1.555
Battery technology	Li-Ion

Technical data	SYS-PST
Charging duration (depending on cell temperature) (h)	3
Dimensions with adjustable legs (L x W x H) (mm)	396 x 296 x 187
IP protection class (with closed guards)	IP 44
USB output	Typ-C, 5 – 20 V / 3A / 15 – 60 W
Weight (kg)	16,5

Items included	RRP in £*	Order no.
SYS-PST		
 SYS-PST 1500 Li HP 240 V residual current personal protection adapter (to protect an additional electrical outlet module with a fuse), 2 m charging cable	2,624.00 3,148.80	205722

For your safety: Only use with devices that do not require an earthed power supply (therefore do not use the TKS 80 with the SYS-PowerStation). An antistatic suction hose must be used when the device is operated in conjunction with an extractor. Unique: It goes without saying that you are fully covered thanks to the comprehensive support provided by the Festool SERVICE (including the "Replaced in the event of theft" service – with increased deductible).

* Manufacturer's recommended retail price. Dealer prices may vary.
Excl. VAT. | Incl. VAT.
 Vibration and emissions values can be found in the operating manual at www.festool.co.uk/vibration

Always sounds good. At work. And on the phone.

The SYSROCK construction site radio.

The SYSROCK construction site radios fit on every windowsill and combine compact dimensions with a low weight and impeccable sound. And thanks to the Bluetooth® interface, you can listen to your favourite radio stations and tracks from your smartphone with SYSROCK sound quality.

Site radio

SYSROCK BR 10 DAB+

DAB+ digital radio with integrated USB interface for charging external devices such as mobile devices.



Technical data	BR 10 DAB+
Radio reception	FM / DAB+
FM frequency band (VHF) (MHz)	87,5 – 108
Speaker (watt)	10
Operation with Festool slide-in battery packs (V)	18
Number of stored stations	2 x 4
AUX-IN (mm)	3,5
Bluetooth® standard	4,1
USB output	5V/1,2A
Dimensions (L x W x H) (mm)	95 x 102 x 149
Weight (kg)	0,7

Items included	RRP in £*	Order no.
BR 10 DAB+ 240V 230 V adapter, aux-in cable, bag	168.00 201.60	202112

Batteries
from page **28**

The Sound of Systainer.

The Bluetooth® TOPROCK speaker.

TOPROCK is the newest band member of the Festool sound family. The Bluetooth® speaker in the Systainer³ lid combines all the advantages of the Festool Systainer system in perfect harmony. Four high-performance speakers, combined with the cleverly designed resonance chamber, provide a clear and voluminous sound. Do you want even more? Simply connect two TOPROCK speakers to your smartphone and enjoy a stereo sound which fills the room.



Bluetooth® speaker TOPROCK

The Bluetooth® speaker in the Systainer format – tool underneath and music on top.



Technical data	SYS3 BT 20	Items included	RRP in £*	Order no.
Speaker (watt)	20	SYS3 BT20 M 137 240V 230 V adapter	191.00 229.20	205720
Number of speakers	4			
Bluetooth® standard	V5			
Max. Bluetooth® range (m)	50			
Integrated battery (V)	11			
USB output	5 V / 1 A			
Mains adapter (DC-IN)	Ø 4,8 mm 19 V/1,2 A			
Dimensions (L x W x H) (mm)	396 x 296 x 137			
Weight (kg)	2,8			

* Manufacturer's recommended retail price. Dealer prices may vary.
Excl. VAT. | Incl. VAT.

Vibration and emissions values can be found in the operating manual at www.festool.co.uk/vibration

1 table. 1000 possibilities.

The MFT 3 multifunction table.

Creates professional work conditions right from the assembly stage. It's flexible clamping and processing options for large and small workpieces make the multifunction table MFT 3 probably the most diverse worktop in the world.



Multifunction table MFT/3

The working height of 90 cm is ideal to prevent back strain. Additionally, the MFT 3 is quite easy to fold away for space-saving transport.

Technical data	MFT/3
Table dimensions (mm)	1.157 x 773
Table height, legs folded away (mm)	180
Table height, legs unfolded (mm)	900
Max. workpiece thickness (mm)	78
Max. workpiece width (mm)	700
Load capacity (kg)	120
Weight (kg)	28

Items included	RRP in £*	Order no.
All variants: table with perforated top and foldaway legs		
MFT/3 swivel unit, support unit, angle stop, adjustable stop, guide rail FS 1080/2, deflector FS-AW, additional clamp	646.20 775.44	495315
MFT/3 Basic	507.80 609.36	500608



Maximum hold

Specially developed fixed clamps and the customary fastening clamps secure workpieces with maximum flexibility using a hole pattern.



Maximum precision

With all-round aluminium profile for retaining a guide rail and the angle stop.

Accessories		RRP in €*	Order no.
	Cross brace MFT 3-QT for additional MFT 3 stability, qty. in pack 2 Units, diameter 20 mm, length 675 mm	86.40 103.68	495502
	Additional clamp MFT/3-ZK for securing the stop rail to the V-groove	32.20 38.64	495541
	Fixed clamps MFT-SP for MFT, for safe and precise securing of the workpiece (sawing, sanding, routing, drilling, etc.), qty. in pack 2 Units	88.60 106.32	488030
Lever clamp			
	MFT-HZ 80 for MW 1000 mobile workshop and MFT 3, It is possible to secure different materials up to a height of 80 mm, dimensions (L x W x H) 130 x 40 x 155 mm, maximum height of workpiece 80 mm	35.80 42.96	577132
	FS-HZ 160 for FS/2, MFT, solid steel version, clamping width 160 mm	48.60 58.32	491594
Fastening clamp All variants: for FS/2, MFT, solid steel version, qty. in pack 2 Units			
	FSZ 120 clamping width 120 mm	35.30 42.36	489570
	FSZ 300 clamping width 300 mm	43.50 52.20	489571
	Base TSB/1-MW 1000 for MW 1000 mobile workshop and MFT 3, extended work space, aluminium profile and perforated top allow for use of many existing accessories, work height 900 mm, dimensions (L x W x H) 1.045 x 500 x 74 mm, weight 12,2 kg	252.20 302.64	203457
	Connecting piece VS for attachment of FST660/85 or MFT 800 to Basis Plus, for connecting several MFT 3	12.90 15.48	484455
	Adapter VAC SYS AD MFT 3 for VAC SYS SE 1, VAC SYS SE 2, for connecting the VAC SYS clamping unit with the MFT 3	214.90 257.88	494977
	Adjustable stop MFT/3-AR for securing workpieces on the angle stop, Can be folded away	19.50 23.40	495542

* Manufacturer's recommended retail price. Dealer prices may vary.
Excl. VAT. | Incl. VAT.

Turns the construction site into your workshop.

The mobile workshop.

The workshop that you can take with you – for ideal working conditions even on the construction site. Effortless transportation between workshop, vehicle and construction site is ensured by its low weight, compact dimensions and good mobility on stairs. It is immediately ready for on-site use, with no need for time-consuming assembly.





Mobile workshop MW 1000

Ideal connection to the Festool Systemer world – everything fits together. Just as compatible: All accessories for the MFT multifunction table.

Technical data	MW 1000 Basic	MW 1000
Work height (mm)	900	900
Dimensions (L x W x H) (mm)	641 x 600 x 1.076	641 x 600 x 1.185
Table dimensions (mm)	445 x 363	445 x 363
Total load capacity (kg)	100	100
Drawer load capacity (kg)	20	20
Roll dia. (mm)	200	200
Weight (kg)	19	31

Items included

	RRP in £*	Order no.
MW 1000		
 MW 1000 Basic SYS-AZ-MW 1000 pull-out drawer	437.90 525.48	203454
MW 1000 Set		
 MW 1000 SYS-AZ-MW 1000 pull-out drawer, TSB/1-MW 1000 table	690.10 828.12	203802



The perfect system

Compatible with the entire MFT 3 accessories range. These can be found on page 317.











Easy transportation

Easy loading into vehicles by just one person thanks to handle with angle adjustment, sliding surfaces and recessed grip on the basic element.



Convenient

Compact dimensions and effortless assembly and disassembly. Few steps required to stow Systainer and table securely for safe transport – no slipping during transportation.

Accessories	RRP in £*	Order no.
Pull-out drawer		
 <p>SYS-AZ-MW 1000 for MW 1000 mobile workshop, tool-free attachment and customised height adjustment, dimensions [L x W x H] 493 x 373 x 118 mm, drawer load capacity 20 kg, weight 3,2 kg</p>	<p>62.10 74.52</p>	203456
 <p>SYS-AZ for Systainer³ M, T-LOC and Classic, for constructing an individual shelf system, in 32 hole grid, dimensions [L x W x H] 425 x 376 x 57 mm, max. load 20 kg</p>	<p>37.80 45.36</p>	500692
 <p>SYS-AZ-Set for Systainer³ M, T-LOC and Classic, for constructing an individual shelf system, in 32 hole grid, dimensions [L x W x H] 425 x 376 x 57 mm, qty. in pack 5 Units, max. load 20 kg</p>	<p>188.60 226.32</p>	500767
 <p>Base TSB/1-MW 1000 for MW 1000 mobile workshop and MFT 3, extended work space, aluminium profile and perforated top allow for use of many existing accessories, work height 900 mm, dimensions [L x W x H] 1.045 x 500 x 74 mm, weight 12,2 kg</p>	<p>252.20 302.64</p>	203457
 <p>Additional clamp MFT/3-ZK for securing the stop rail to the V-groove</p>	<p>32.20 38.64</p>	495541
 <p>Fixed clamps MFT-SP for MFT, for safe and precise securing of the workpiece (sawing, sanding, routing, drilling, etc.), qty. in pack 2 Units</p>	<p>88.60 106.32</p>	488030
Lever clamp		
 <p>MFT-HZ 80 for MW 1000 mobile workshop and MFT 3, It is possible to secure different materials up to a height of 80 mm, dimensions [L x W x H] 130 x 40 x 155 mm, maximum height of workpiece 80 mm</p>	<p>35.80 42.96</p>	577132
 <p>FS-HZ 160 for FS/2, MFT, solid steel version, clamping width 160 mm</p>	<p>48.60 58.32</p>	491594
Fastening clamp All variants: for FS/2, MFT, solid steel version, qty. in pack 2 Units		
 <p>FSZ 120 clamping width 120 mm</p>	<p>35.30 42.36</p>	489570
 <p>FSZ 300 clamping width 300 mm</p>	<p>43.50 52.20</p>	489571

* Manufacturer's recommended retail price. Dealer prices may vary.
Excl. VAT. | Incl. VAT.

Set safe and sound.

The mobile saw table and work bench.

Thanks to the wooden coverings, sheet material and workpieces are optimally supported for all machining tasks. What is special about it: Even boards up to 3100 x 2150 mm in size can be held by a single person without difficulty or additional assistance, enabling precise machining.

Saw table and work bench **STM 1800**

In conjunction with the circular saw and guide rail, the saw table and work bench turn into a mobile panel saw.

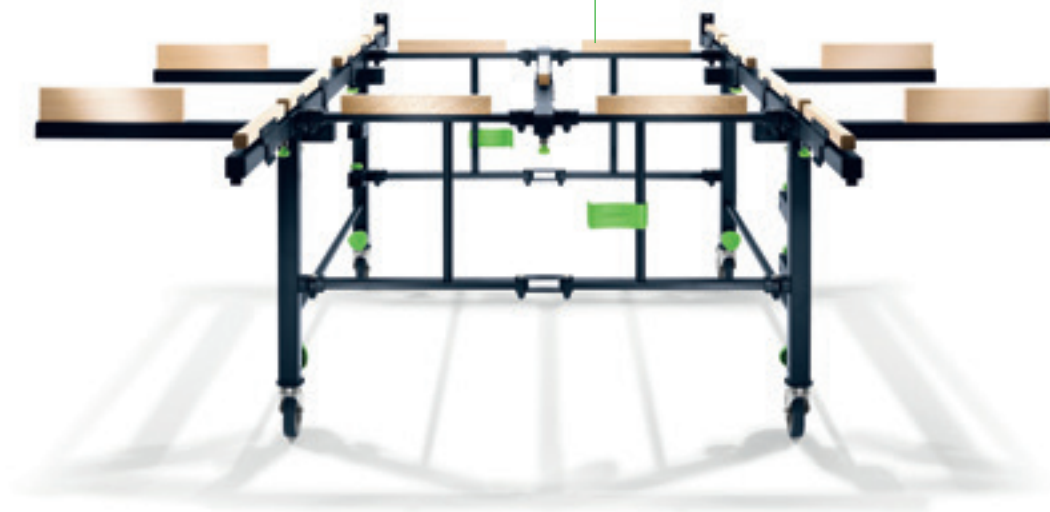

Technical data	STM 1800	Items included	RRP in £*	Order no.
Table dimensions (LxWxH) when folded (mm)	1.150 x 250 x 700	STM 1800 fitted wooden coverings, four extension pipes with wooden coverings	1,095.30 1,314.36	205183
min. contact surface (mm)	1.100 x 1.050			
max. contact surface (mm)	1.800 x 2.100			
Height adjustable (mm)	700 – 900			
Max. load (kg)	150			
max. workpiece dimensions (with tilting function) (mm)	3.100 x 2.150			
Weight (kg)	34			

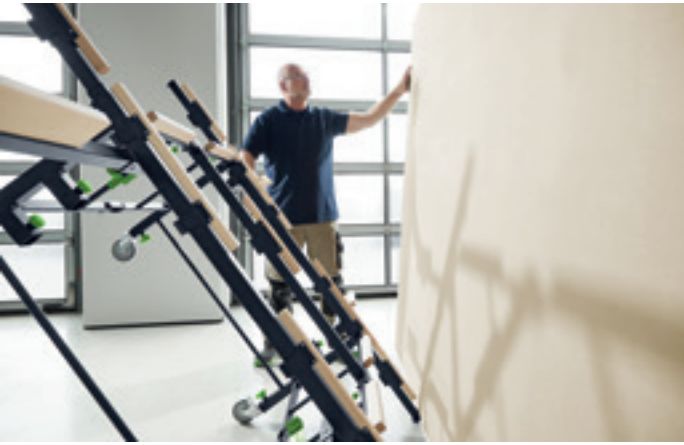

Can be operated by one person

For sheet material up to 3100 x 2150 mm. The bench can be tilted further so that the board can be held even more easily.



Height adjustment

For ergonomic work that protects your back when routing, sawing and gluing workpieces.



Mobile and compact

The saw table is equipped with robust rollers and can be folded for transportation.



Precise cutting of sheets

In combination with guide rail, portable circular saw and 90° angle stop FS-WA/90°.

90° angle stop
FS-WA/90°

Shows you where to go. The aluminium stop milled from a single piece guarantees precise and reproducible perpendicular 90° cuts without any readjustments. Thanks to the quick-change system, the angle stop can be secured to the guide rail in just a couple of movements.



Items included	RRP in £*	Order no.
FS-WA/90°	123.30 147.96	205229



Precise 90° cuts

The angle stop is fixed to the workpiece using fastening clamps.

* Manufacturer's recommended retail price. Dealer prices may vary. Excl. VAT. | Incl. VAT.

The leading original model for precise working results.

The guide rails.

Invented and perfected by Festool: The guide rail. For cuts and grooves that impress thanks to their precision. With a slideway lining for the smooth running of the machines, a groove for the fastening and lever clamps or the splinterguard for splinter-free sawing.

NEW



Guide rails with adhesive pads

FS/2-KP

The guide rail with adhesive pads allows users to make precise cuts in even the most difficult positions. The guide rail is also easy to transport with the Systainer. The FS/2-KP guide rail is available in lengths of 1400 mm and 1900 mm.

Guide rails

FS/2

The guide rail is available in 8 different lengths, from 800 mm to 5000 mm.

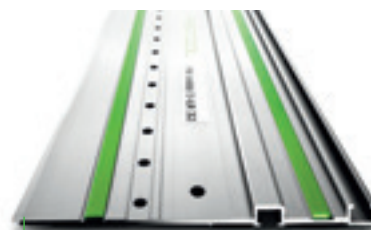

Guide rails with rows of holes

FS/2 LR 32

The hole line distance of 32 mm allows for quick and precise milling of hole lines in furniture manufacturing.

Guide rails with adhesive pads

Items included	RRP in £*	Order no.
FS 1400/2-KP FS-KP/30 adhesive pad	104.10 124.92	577043
FS 1900/2-KP FS-KP/30 adhesive pad	162.90 195.48	577044
FS-KP/30	18.10 21.72	577042

Guide rails with rows of holes

Items included	RRP in £*	Order no.
FS 1400/2-LR 32	104.60 125.52	496939
FS 2424/2-LR 32	254.80 305.76	491622

Guide rails

Items included	RRP in £*	Order no.
FS 800/2	57.10 68.52	491499
FS 1080/2	72.10 86.52	491504
FS 1400/2	85.30 102.36	491498
FS 1900/2	146.30 175.56	491503
FS 2400/2	209.90 251.88	491502
FS 2700/2	244.30 293.16	491937
FS 3000/2	262.30 314.76	491501
FS 5000/2	431.90 518.28	491500



Perfectly compatible
The plunge-cut saws and portable circular saws fit perfectly onto the guide rail. The result: Cuts as straight as they are splinter-free.



Indispensable in furniture construction
A router and guide rail with rows of holes simplify the installation of shelves or fittings.



Machine can be guided in any position
The FS/2-KP guide rail allows users to make straight and precise cuts when carrying out horizontal work on floors or work surfaces, as well as for applications on walls. Adhesive pads can be used to securely attach the guide rail without slipping.



Ready, Systainer, go
The FS/2 KP guide rail is easy to transport with the Systainers. The cut-out in the middle means that the guide rail can be inserted above the carrying handle of all Systainer models and be carried without any problems.

New accessories for the guide rail



The angle stop for precise adjustment
Precise and uncomplicated angled cuts from -60° to $+60^\circ$: The angled cuts are quick and easy to set and made with precision. The specified locking positions for commonly used angle settings make it particularly easy to achieve maximum precision.

Items included	RRP in £*	Order no.
FS-WA positioning bolt	135.80 162.96	577040



Connects guide rails as if they were made from a single piece
The self-aligning connecting piece makes it quick and convenient to connect two guide rails so that they are straight. For long, straight cuts and perfect work results without deviations.

Items included	RRP in £*	Order no.
FSV/2 SW 5/SW 3 combination hex key	41.70 50.04	577039

* Manufacturer's recommended retail price. Dealer prices may vary.
Excl. VAT. | Incl. VAT.

17 Workplace organisation

Accessories for guide rails		RRP in £*	Order no.
Quick-action clamp All variants: Clamping jaws, fixed jaws			
	FS-RAPID/R for clamping and positioning guide rails FS, FS/2 and GRP/2	42.20 50.64	489790
	FS-RAPID/L for use of SSU 200, IS 330 with guide rail, for clamping and positioning with Festool guide rails	42.20 50.64	768116
Lever clamp			
	MFT-HZ 80 for MW 1000 mobile workshop and MFT 3, It is possible to secure different materials up to a height of 80 mm, dimensions [L x W x H] 130 x 40 x 155 mm, maximum height of workpiece 80 mm	35.80 42.96	577132
	FS-HZ 160 for FS/2, MFT, solid steel version, clamping width 160 mm	48.60 58.32	491594
Fastening clamp All variants: for FS/2, MFT, solid steel version, qty. in pack 2 Units			
	FSZ 120 clamping width 120 mm	35.30 42.36	489570
	FSZ 300 clamping width 300 mm	43.50 52.20	489571
	Connecting piece FSV/2 for FS/2, with a self-aligning function for connecting two guide rails for long workpieces so that the rails are straight, SW 5/SW 3 combination hex key	41.70 50.04	577039
	Kickback stop FS-RSP for TS 55, TS 55 R, TS 55 F, TSC 55, TSC 55 K, TS 75, HKC 55, HK 55, ATF 55, AP 55, AT 65, AP 65, AP 85, can also be used as guide stop, used as a rear and front stop position on guide rail FS/2	15.20 18.24	491582
	Deflector FS/2-AW for FS/2, prevents the suction hose and the cable getting caught on the end of the guide rail	18.60 22.32	204787
	Angle stop FS-WA/90° for FS/2, for precise and reproducible 90° cutting of sheet materials without any readjustments, completely self-aligning and precise thanks to milled aluminium stop, easily and quickly connect with the guide rail using the quick-clamping lever	123.30 147.96	205229
	Combination bevel FS-KS for FS/2, for angle cuts on guide rail between 0 and 180	85.60 102.72	491588
	Angle stop FS-WA for FS/2, can be extended with FS-WA-VL guide extension, positioning bolt, angular range -60 – +60°	135.80 162.96	577040
	Guide extension FS-WA-VL for the FS-WA angle stop, used to extend the angle stop, cuts made to size with repeat accuracy using the guide extension with a scale and an adjustable stop, stable connection to the angle stop using the connecting pieces, adjustable stop, connecting pieces, workpiece width 447 – 1.150 mm	44.40 53.28	577041

Accessories for guide rails		RRP in £*	Order no.
Splinter guard All variants: replacement splinter guard for FS, FS/2 and FSK guide rails, transparent			
	FS-SP 1400/T length 1.400 mm	10.50 12.60	495207
	FS-SP 5000/T length 5.000 mm	25.20 30.24	495209
	Slideway lining FS-GB 10M 10 m length, replacement slideway lining for FS/2 and FSK guide rails	31.80 38.16	491741
	Adhesive cushion strip FS-HU 10M 10 m roll, replacement adhesive cushion strip for FS, FS/2 and FSK guide rails	17.90 21.48	485724
	Adhesive pad FS-KP/30 for FS/2-KP, secure grip for the FS/2-KP on a range of surfaces, qty. in pack 30 Units	18.10 21.72	577042
	Parallel side fence FS-PA for FS/2, for sawing along the width, for fixed cuts, can be re-set using the scale and end stop, mounting on the guide rail without the use of tools, stop ruler with additional clamp, adjustable stop, qty. in pack 2 Units, max. workpiece width 650 mm	197.80 237.36	495717
	Guide extension FS-PA-VL for FS/2, only for use with the FS-PA, stop ruler, bridge, scale, qty. in pack 2 Units, max. workpiece width 195 mm, max. material strength 70 mm	117.70 141.24	495718
	Bag FS-BAG carrying bag with shoulder straps, up to length of FS 1400/2	63.30 75.96	466357
	dual suction pad GECKO DOSH from page 326		
	Adapter DOSH-FSAD to fix the guide rail at the GECKO	19.40 23.28	492616
	Accessories set SYS3 M 137 FS/2-Set for FS/2, FS-WA angle stop, 2 FSV/2 connecting pieces, FS/2-AW deflector, FSZ 120 fastening clamps (two units), set-back stop FS-RSP, SW 5/SW 3 combination hex key, Systainer SYS3 M 137	194.50 233.40	577157
	Stopper LA-LR 32 FS positions the first hole on the hole series guide rail at a distance of 9.5, 16 or 32 mm from the workpiece edge, qty. in pack 2 Units	36.90 44.28	496938
	Hole series system for FS/2 from page 215		
	Guide stops for routers from page 211		
	Guide rail adapter FS-PS/PSB 300 for PS 200, PS 300, PSB 300, PS 2, allows use of jigsaws with FS and FS/2 guide systems	13.80 16.56	490031
	base adapter ADT-PS 420 for PS(C) 400/420, PSB(C) 400/420, for using the PS on the guide rail, for installation in the Compact Module System CMS, in conjunction with circle cutting attachment KS-PS 400	14.00 16.80	497303

Dual suction pad GECKO

Work with a vacuum without leaving any marks. The GECKO dual suction pad – for simple and safe transport also for awkward workpieces or for securing the guide rail on smooth surfaces.



Items included	RRP in £*	Order no.
GECKO DOSH	60.00 72.00	492617
GECKO DOSH-Set adapter DOSH-FSAD, dual suction pad GECKO DOSH	79.10 94.92	493507



Designed for a system

The GECKO can be mounted directly to a guide rail using the guide rail adapter.

Vacuum clamping nozzle CT Wings

The practical assembly aid for clamping and fixing workpieces on horizontal and vertical surfaces. Simply position CT WINGS onto a 27 mm or 27/32 mm suction hose with machine sleeve, switch on the mobile dust extractor and then the workpiece is held in place by the suction power.



Technical data	CT-W
Max. clamping height (mm)	50
Max. load (kg)	3
Dimensions (L x W x H) (mm)	130 x 80 x 50
Weight (kg)	0,35

Items included	RRP in £*	Order no.
CT-W	35.20 42.24	500312



A third hand

In many cases replaces the assistant when it comes to having a free hand for marking, clamping, gripping, etc.

Turns the battery pack into a power bank.

The phone charger.

No more empty smartphone batteries: The PHC 18 phone charger acts as a clever adapter that transforms every Festool 18 V battery pack into a power bank (with the exception of 3.1 Ah Ergo battery packs). No more searching for a free socket or worrying about whether your smartphone battery will last until the end of the day: This means that your mobile phone is always ready to use. In addition, despite its compact design, it can supply up to three smartphones with power at the same time – both via users' own charging cables and inductive charging.

Phone charger PHC 18

The charger is a clever adapter that transforms 18 V battery packs from Festool into a power bank.



NEW



Technical data	PHC 18
USB port compatible with type A	5 V / 2,4 A / 12 W
USB port compatible with type C	5 V / 2,4 A / 12 W
Inductive charging compatible with Qi-BPP/PPDE	5 W / 9 W

Items included	RRP in £*	Order no.
PHC 18	41.40 49.68	577155

Batteries
from page **28**

For efficient work processes.

The mobile organisation centre.

The best way to organise your workspace: In a single tool, you can store all your machinery, accessories and even mobile dust extractors, and have these immediately on hand and ready to use. And if you ever need to switch workstations within the workshop, our centre can quite easily be transported to the new location along with you.

Universalcenter UCR 1000

Set consisting of MFH 1000 multifunction stool and WCR 1000 Workcenter.





Workcenter WCR 1000









The Workcenter can not only be connected to the multifunction stool, but also with all Festool mobile dust extractors with T-LOC. Moreover, it offers a large storage area for Systainer units and a number of hooks for accessories and machines.

Multifunction stool MFH 1000

The multifunction stool not only serves as a stable and comfortable seat, but is also the basis for the WCR 1000 Workcenter.

Technical data	WCR 1000	MFH 1000	UCR 1000
Dimensions (L x W x H) (mm)	–	695 x 436 x 524	–
Width of roll (mm)	–	32	32
Roll dia. (mm)	–	100	100
Height adjustable (mm)	545 – 785	–	1.031 – 1.271
Size of square hole pattern (mm)	9,2 x 9,2	9,2 x 9,2	9,2 x 9,2
Inner hole distance of square hole pattern (mm)	38	38,1	38,1
Weight (kg)	10,2	27	37



Items included	RRP in £*	Order no.
UCR 1000		
 <p>UCR 1000 WCR 1000 Workcenter, multifunction stool MFH 1000 (without seat cushion)</p>	<p>663.00 795.60</p>	498966
WCR 1000		
 <p>WCR 1000 Storage shelf, storage trough, storage base for pegboard, double tool hook, 6 x standard hooks (125 mm long), 2 x pegboards with square holes, Systainer retainer</p>	<p>380.70 456.84</p>	497471
MFH 1000		
 <p>MFH 1000 seat cushion MFH 1000 SK, Assembly set</p>	<p>315.00 378.00</p>	498967

Accessories	RRP in £*	Order no.
 <p>Feather key WCR 1000 PF 2x for WCR 1000, UCR 1000, The keys enable the attachment of individual accessories to the profiled groove, 2x keys incl. bits</p>	<p>11.90 14.28</p>	497476
 <p>Pegboard hook LWH HSK-A for WCR 1000, MFH 1000, UCR 1000, for hanging hand sanding blocks HSK-A 80x130, HSK-A 80x200 and HSK-A 115x226, not suitable for hand sanding block HSK-A 80x400, the protective coating prevents damage, dimensions length x width 38,1 x 38,1 mm</p>	<p>31.60 37.92</p>	498968
 <p>Tool hook WCR 1000 WH for WCR 1000, UCR 1000, for hanging two tools, for use as a hose holder</p>	<p>54.60 65.52</p>	497474
 <p>Hook WCR 1000 SHQ for WCR 1000, UCR 1000, Standard hooks for mounting on the pegboard, qty. in pack 6 Units</p>	<p>20.40 24.48</p>	497475
 <p>Holder for spray gun WCR 1000 LPH for WCR 1000, holder for paint gun, for assembly at the profile groove for the WCR 1000 Workcenter, 2x screw, 2x square nut, dimensions [L x W x H] 148 x 76 x 60 mm, weight 0,5 kg</p>	<p>25.20 30.24</p>	498361
 <p>Storage surface WCR 1000 AB for WCR 1000, UCR 1000, Large storage surface for placing sundries, boxes of abrasives or screws, etc.</p>	<p>41.70 50.04</p>	497477
 <p>Hose holder TC-SH for the TC 2000, TC 3000, TC 3000/2, for retrofitting TC 3000</p>	<p>55.70 66.84</p>	487304
 <p>Service unit VE-TC 3000 for Toolcenter TC 2000, TC 3000, for compressed air supply to mobile dust extractors CT 22/33 and SR 151, SR 200 series dust extractors in LE design</p>	<p>423.70 508.44</p>	454808

plug it.

One cable for all devices.

The plug it-system is not only much more practical, quicker and convenient but also more economical. In the event of a cable break (a frequent cause of electric power tool failure) downtimes are reduced because the cables on Festool tools are not integrated into the interior of the machine: you simply plug in another cable and carry on working! This means no costly repairs, and minimal downtimes. Needless to say, a plug it-connector can be retrofitted to tools that do not already have one.

plug it-accessories		RRP in £*	Order no.
plug it-cable			
	H05 RN-F-4 rubber insulated cable 240V plug it, length 4 m	24.70 29.64 6.18 / 1 m 7.41 / 1 m	203924
	H05 RN-F4/3 rubber insulated cable 240V plug it, qty. in pack 3 Units, length 4 m	not available in Great Britain	203935
	H05 RN-F-5,5 rubber insulated cable 240V plug it, length 5,5 m	24.10 28.92 4.38 / 1 m 5.26 / 1 m	203892
	H05 RN-F-7,5 rubber insulated cable 240V plug it, length 7,5 m	not available in Great Britain	203920
	H05 RN-F-10 rubber insulated cable 240V plug it, length 10 m	31.50 37.80 3.15 / 1 m 3.78 / 1 m	203940
	H05 RN-F-4 PLANEX for the PLANEX LHS 2 225(I), PLANEX 225 EQ and PLANEX LHS-E 225 easy long-reach sanders, rubber insulated cable 240V plug it, particularly suitable for use with the PLANEX LHS 225 thanks to extended cable bushing, for example for sanding work in dry construction, length 4 m	26.00 31.20 6.50 / 1 m 7.80 / 1 m	204028
	H05 BQ-F-4 green rubber-insulated cable, length 4 m	not available in Great Britain	203921
	H05 BQ-F-7,5 green rubber-insulated cable, length 7,5 m	not available in Great Britain	203922

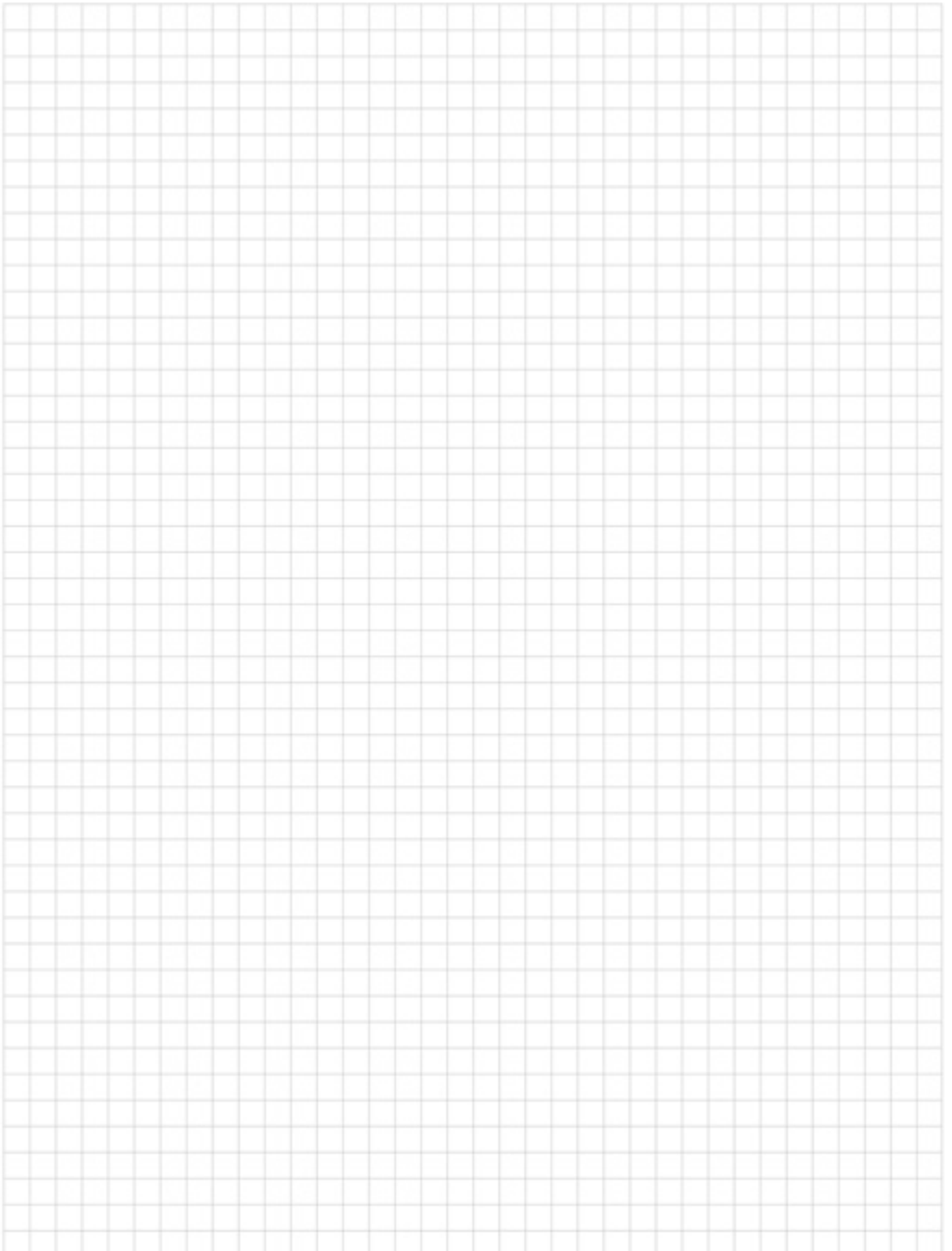

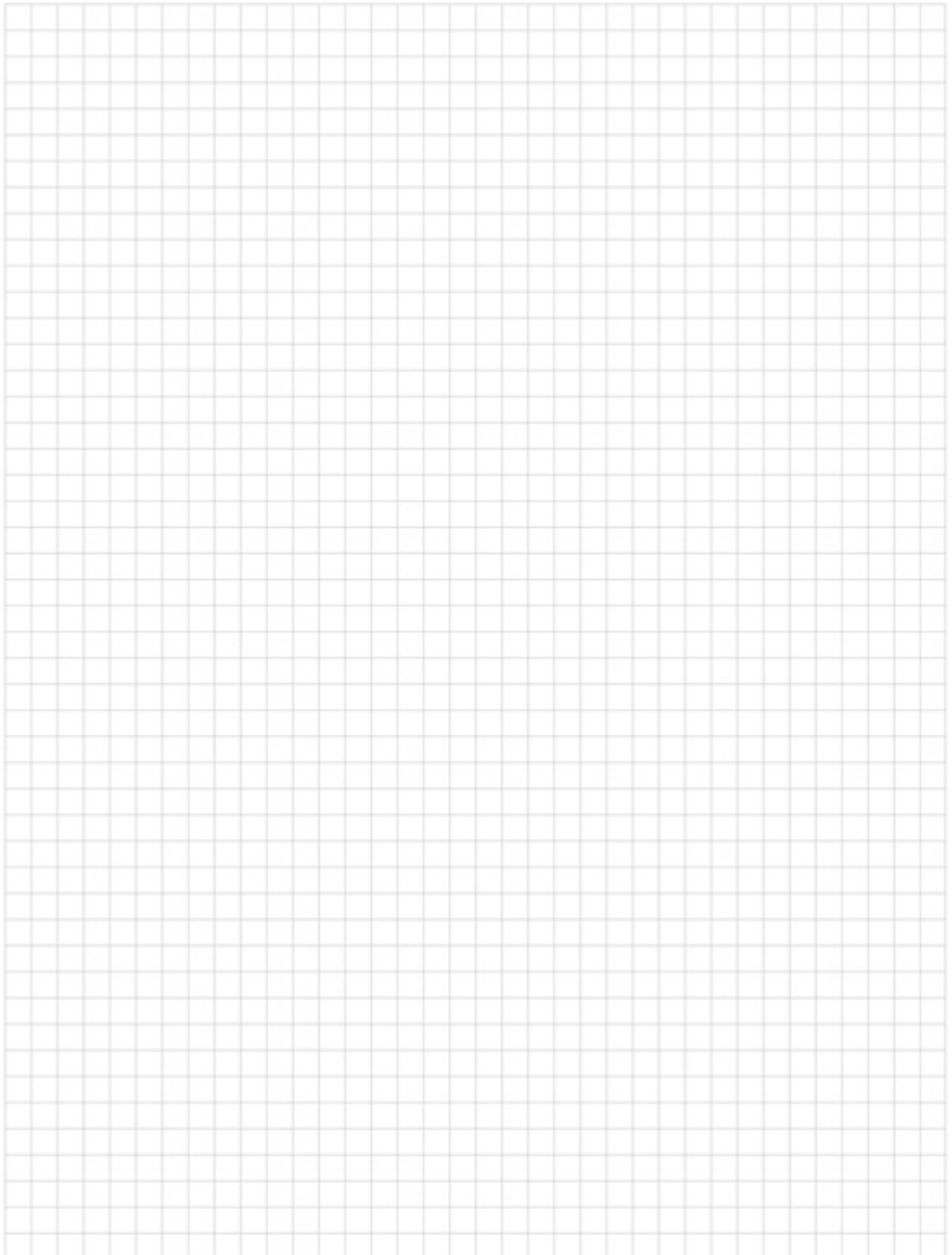

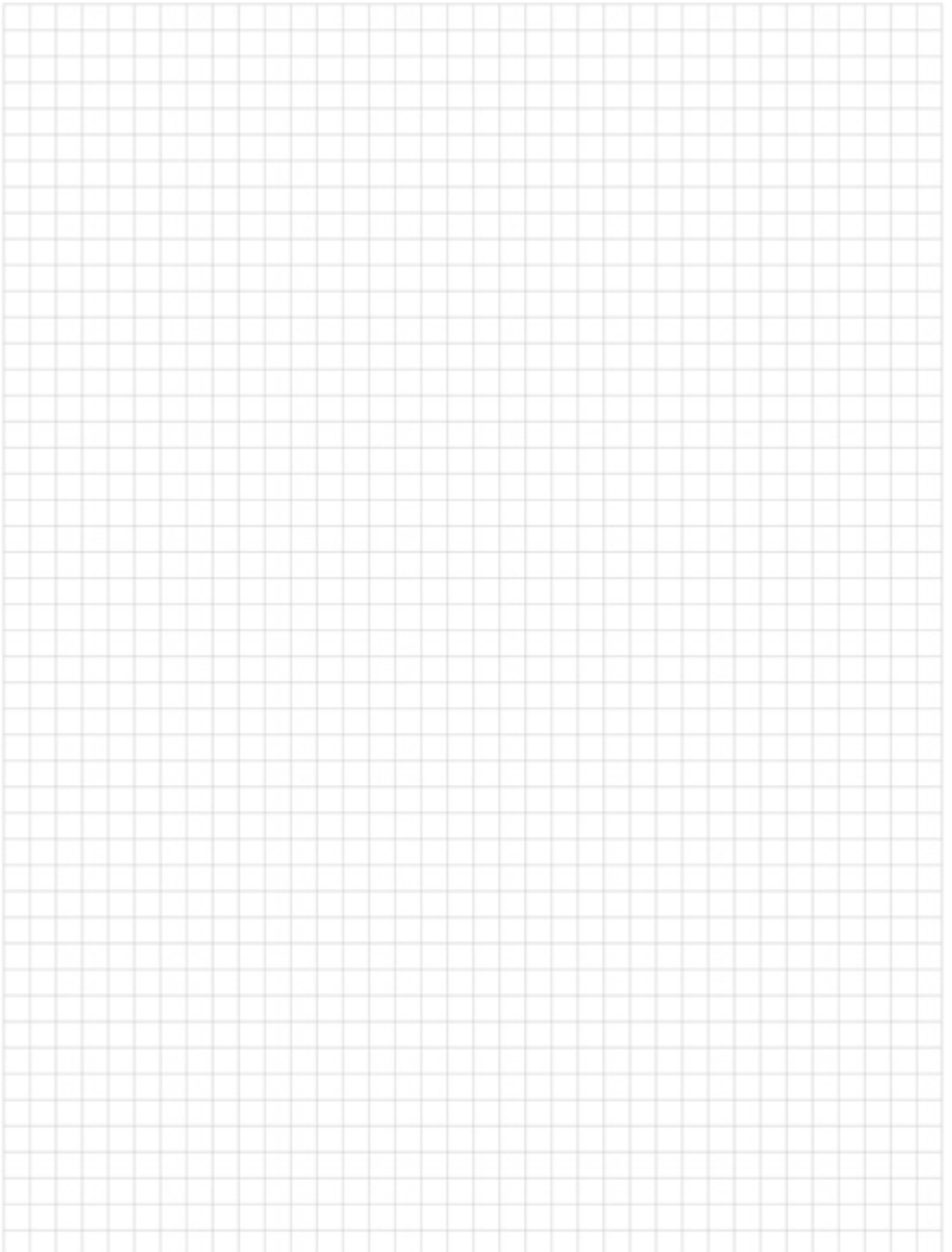

For the construction site, your work area or your free time – browse our fan shop now!



Lunch bag

Insulated bag suitable for the Systainer SYS3 M 187. Stored in the Systainer³, can be stacked in the system and offers good protection for the bag. Made of heavy-duty and water-resistant 480D polyester fabric, PU-coated, with high tear resistance.

	Order no.
Dimensions: 34 x 25 x 13 cm Volume: 11 l	576978



Lunch box

Two high-quality lunch boxes with practical clip closure, "S" size fits twice into the "L" lunch box. The koziol ORGANIC Collection consists of natural cellulose and is suitable for use with foodstuffs, is tasteless, dishwasher-safe, extremely durable and Made in Germany.

	Order no.
"S" dimensions (L x W x H): 151 x 108 x 60 mm	576980
"L" dimensions (L x W x H): 232 x 166 x 62 mm	576981



720 DGREE bottle

720°DGREE water bottle. Also leak-proof for fizzy drinks, innovative anti-glug drink opening.

	Order no.
720 DGREE bottle, 1.0 l Dimensions: Diameter: 7.8 cm, Height: 28.5 cm, Weight: 225 g	576982
720 DGREE bottle, 1.5 l Dimensions: Diameter: 9.8 m, Height: 28.7 cm, Weight: 265 g	576983



Cutlery

Well-designed to-go cutlery for the construction site or for picnics, in the usual size, robust and can be connected in a compact way, suitable for use with foodstuffs, tasteless, dishwasher-safe and extremely durable. The koziol ORGANIC Collection consists of natural cellulose and is Made in Germany.

	Order no.
To-go cutlery	576979



XXS Systainer

Made from sturdy ABS plastic, connectable and fitted with T-LOC lock. There is optimum space for drill bits, business cards or other small items. Made in Germany.

	Order no.
XXS Systainer, grey Dimensions: 30 x 105 x 65 mm	205398
XXS Systainer, blue Dimensions: 30 x 105 x 65 mm	205399



Overshoes

Shoe covers for clean work, for example when fitting kitchens. For multiple use, washed by hand washing, practically stowed in a bag with drawstrings for further storage. With anti-slip sole.

	Order no.
Universal size: One size fits all	577003



TPC key tool

Compact key tool in the shape of the Festool TPC, made of high-quality, sandblasted stainless steel. An essential accessory for every set of keys and combines eight functions in the smallest of spaces.

	Order no.
TPC key tool	577221



Tool belt

Robust tool belt to ensure that tools are available within easy reach. Belt and shoulder strap can be adjusted for high comfort while working, tool bag with plenty of compartments and storage options, hammer and cordless drill holder to ensure they are held as securely as possible.

	Order no.
Tool belt with shoulder strap	577154



Hoodie

Hood with drawstrings in green. Brushed inside and kangaroo pocket on the front, stitched waistband and cuffs. Colour: Dark blue with logo printed on the left breast and the back.

	Order no.
Material: 60% cotton, 40% polyester Produced in accordance with the OEKO-TEX® standard	
Hoodie XS	202849
Hoodie S	201300
Hoodie M	201301
Hoodie L	201302
Hoodie XL	201303
Hoodie XXL	201304

Online

Additional items
can be found on our
website



Softshell jacket

A modern functional jacket for sports activities outdoors or simply for everyday use. This men's jacket is breathable, water-repellent and extremely flexible thanks to its adjustable and removable hood. The ergonomic sleeve style allows for optimum mobility.

	Order no.
Material: 100% polyester – 300 g/m ² Waterproof: 5000 mm Breathability: 3000 g/m ² /24 h	
Softshell jacket S	204056
Softshell jacket M	204057
Softshell jacket L	204058
Softshell jacket XL	204059
Softshell jacket XXL	204060
Softshell jacket XXXL	204061

Festool Worldwide.

Our passion for high-quality power tools has continued for more than 90 years. We share this fascination with our customers and fans all around the world.

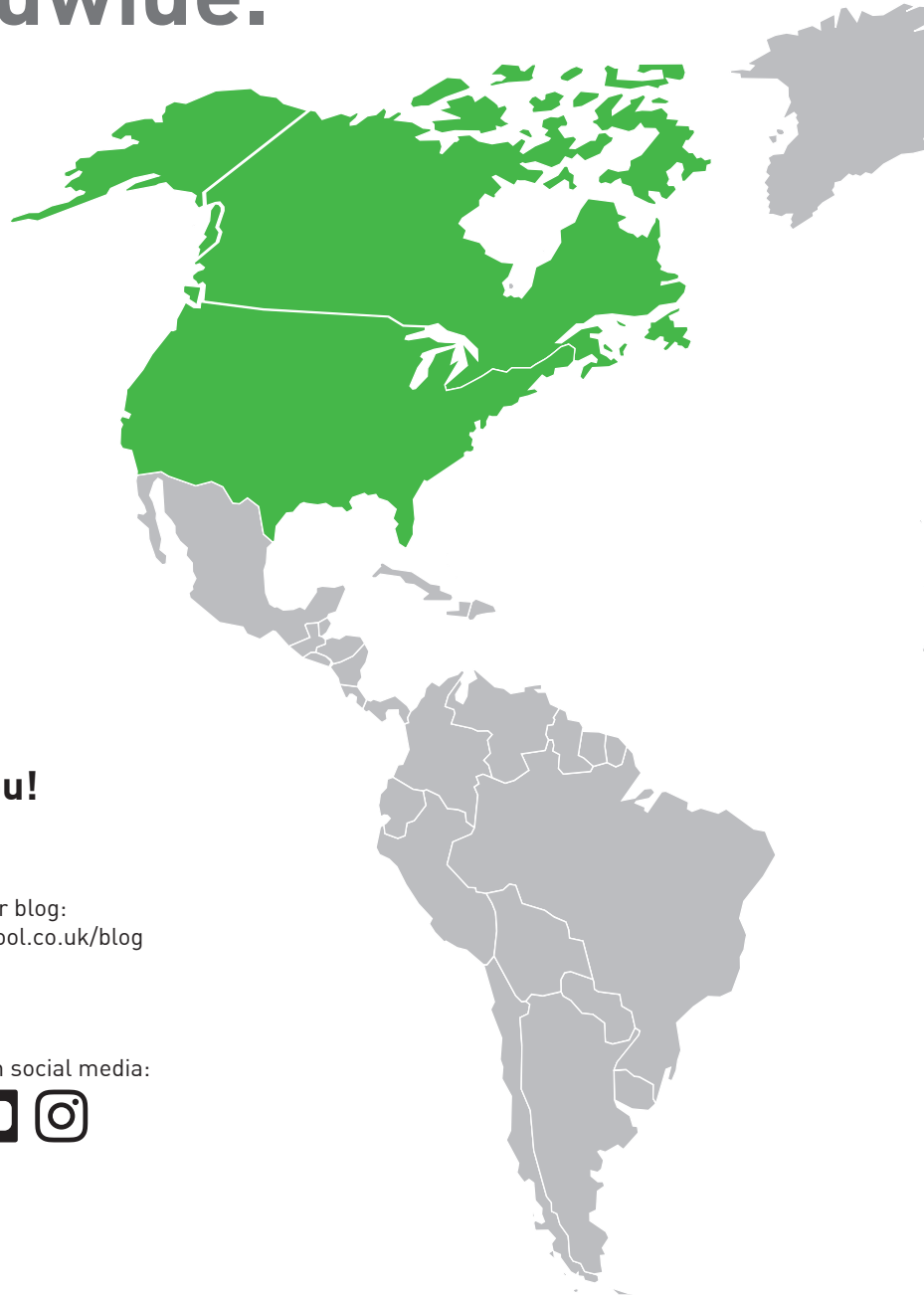

Online, mobile or available from retailers.
We look forward to meeting you!

Find the nearest dealer:
www.festool.co.uk/dealer

Follow our blog:
www.festool.co.uk/blog

Download our apps from the App Store:



Find us on social media:



Product identification key

Product type	Performance class	Equipment variants	Packed in a Systainer	Also included in delivery
RO	150	FEQ	Plus	/ Set
	Pad Ø, container volume, etc.	F Tool changing E Electronics B quick-acting brake CE CENTROTEC Q Plug it SG Hose garage LE Compressed air version I Bluetooth®-compatible	with a Systainer	Extensive range of accessories included with the product

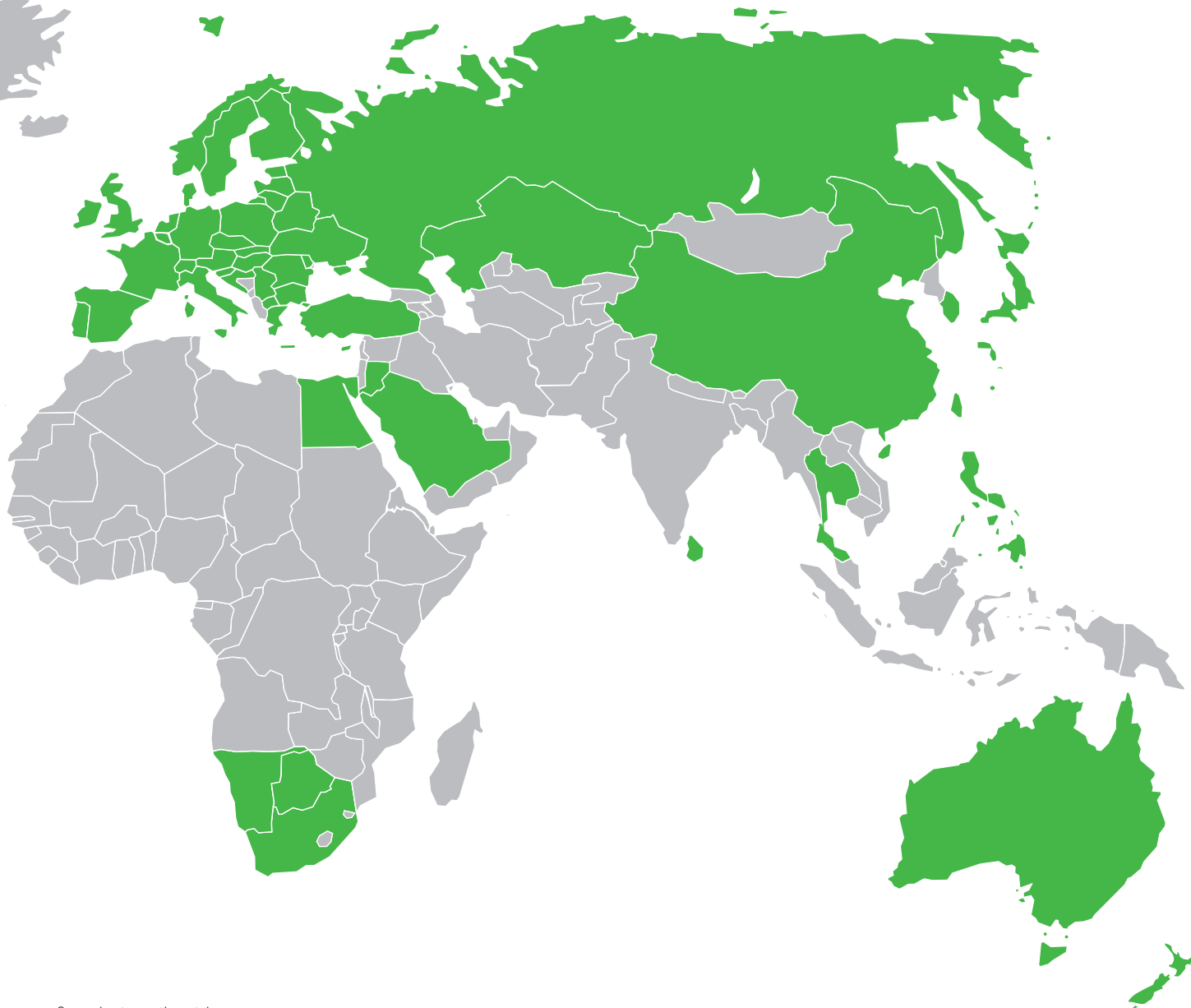

General notes on the catalogue:

01 Remember to use appropriate protective devices or wear personal protective equipment when using Festool products such as compressed air and electric power tools together with their accessories and consumable materials or when machining hazardous materials. For further information, please refer to the relevant safety documentation or consult our customer service department if you have questions.

02 Machine specifications included in the catalogue, such as quantity specifications, time savings, coverage capacities, etc., are average values and may deviate significantly, depending on the material being processed. The manufacturer does not guarantee that the values will be achieved in each individual case. Your Festool specialist dealer will be glad to answer any queries you may have concerning this matter.

03 The machine weights that are specified in the catalogue usually refer to the weight of a machine ready for use including a standard insertion tool, but without a cable, accessories or consumables. Please note that the weights stated may deviate from the specifications in the catalogue, depending on the insertion tool, battery pack, accessories or other additional parts used.

04 All trademark rights, patent rights and other commercial property rights mentioned in this catalogue remain the property of the relevant beneficiary, even in cases where this is not explicitly stated. The reproduction in particular of common names, trade names, goods designations, etc. in this catalogue (even if not identified as such) does not render these names exempt from trademark or brand protection legislation and does not therefore authorise anyone to use them.

05 We reserve the right to make modifications, especially to technical data or specifications, without prior notification. Individual features may vary depending on country-specific conditions.

06 Products may differ from those shown and the images may at times present components or parts that are not included as standard with the tools. If you have any questions, please contact your Festool specialist retailer.

07 Safety: All power tools and compressed air tools listed in this catalogue conform to the valid and applicable IEC or EN safety standards, depending on the type of tool (e.g. IEC/EN 61 029, IEC/EN 60 745, IEC/EN 62 841, IEC/EN 60 335, EN ISO 11 148, IEC/CISPR/EN 55 014, IEC/EN 61 000).

08 CE conformity: All power tools and compressed air tools listed in this catalogue comply with the provisions of the relevant applicable EU directives (e.g. Machinery Directive 2006/42/EC, Low Voltage Directive 2014/35/EU, EMC Directive 2014/30/EU, RoHS Directive 2011/65/EU, Directive on the provision of radio equipment 2014/53/EU, Directive on equipment and protective systems intended for use in potentially explosive atmospheres 2014/34/EU).

09 ISO certification: All the power tools and compressed air tools listed in this catalogue are manufactured in our production plants which are certified in accordance with DIN EN ISO 9001 certified.

10 The Bluetooth® word mark and the logos are registered trademarks of Bluetooth SIG, Inc.; they are used by TTS Tooltechnic Systems AG & Co. KG, and therefore by Festool, under licence.

FESTOOL

Catalogue 2022

As at: 01/2022, replaces all previous catalogues.

Festool UK Ltd

Gottlieb Stoll House
1 Anglo Saxon Way
Rougham
Bury St Edmunds
IP30 9XH
Great Britain
Phone: +44 (0) 1284 760 791
customerservice-uk@festool.com

www.festool.co.uk

Subject to alterations and errors.
Products may differ from those pictured.
Recommended retail price of manufacturer.
Prices valid from 1st January 2022.
Dealer prices may vary.



Art. no. 069 940 GB/en
4014549403419



Festool is dedicated to taking care of forests for future generations. The following materials are FSC[®]-certified: paper.