

EOF4P46X
EOF6P46X



EN	Oven
FR	Four
DE	Backofen
IT	Forno
ES	Horno

User Manual	2
Notice d'utilisation	38
Benutzerinformation	77
Istruzioni per l'uso	116
Manual de instrucciones	155

WE'RE THINKING OF YOU

Thank you for purchasing an Electrolux appliance. You've chosen a product that brings with it decades of professional experience and innovation. Ingenious and stylish, it has been designed with you in mind. So whenever you use it, you can be safe in the knowledge that you'll get great results every time.

Welcome to Electrolux.

Visit our website to:



Get usage advice, brochures, trouble shooter, service and repair information:
www.electrolux.com/support



Register your product for better service:
www.registerelectrolux.com



Buy Accessories, Consumables and Original spare parts for your appliance:
www.electrolux.com/shop



For more recipes, hints, troubleshooting download **My Electrolux Kitchen** app.



CUSTOMER CARE AND SERVICE

Always use original spare parts.

When contacting our Authorised Service Centre, ensure that you have the following data available: Model, PNC, Serial Number.

The information can be found on the rating plate.

Warning / Caution-Safety information

General information and tips

Environmental information

Subject to change without notice.

CONTENTS

1. SAFETY INFORMATION.....	3	3. INSTALLATION.....	9
1.1 Children and vulnerable people safety.....	3	3.1 Building in.....	9
1.2 General Safety.....	4	3.2 Securing the oven to the cabinet...	10
2. SAFETY INSTRUCTIONS.....	5	4. PRODUCT DESCRIPTION.....	11
2.1 Installation.....	5	4.1 General overview.....	11
2.2 Electrical connection.....	6	4.2 Accessories.....	11
2.3 Use.....	7	5. HOW TO TURN OVEN ON AND OFF.....	11
2.4 Care and cleaning.....	8	5.1 Retractable knobs.....	11
2.5 Pyrolytic cleaning.....	8	5.2 Control panel.....	12
2.6 Internal lighting.....	9	6. BEFORE FIRST USE.....	13
2.7 Service.....	9	6.1 Initial cleaning.....	13
2.8 Disposal.....	9	6.2 Initial preheating.....	13

7. DAILY USE.....	13	11.3 Cooking tables for test institutes..	26
7.1 How to set: Heating functions.....	13	12. CARE AND CLEANING.....	28
7.2 Heating functions.....	14	12.1 Notes on cleaning.....	28
7.3 Notes on: Moist Fan Baking.....	15	12.2 How to remove: Shelf supports ...	29
7.4 How to set: Assisted Cooking.....	15	12.3 How to use: Pyrolytic Cleaning....	29
7.5 Assisted Cooking.....	16	12.4 Cleaning Reminder.....	31
8. CLOCK FUNCTIONS.....	21	12.5 How to remove and install: Door..	31
8.1 Clock functions.....	21	12.6 How to replace: Lamp.....	33
8.2 How to set: Clock functions.....	21	13. TROUBLESHOOTING.....	33
9. HOW TO USE: ACCESSORIES.....	23	13.1 What to do if.....	33
9.1 Inserting accessories.....	23	13.2 Service data.....	34
10. ADDITIONAL FUNCTIONS.....	24	14. ENERGY EFFICIENCY.....	35
10.1 Lock.....	24	14.1 Product Information and Product	
10.2 Automatic switch-off.....	24	Information Sheet*.....	35
10.3 Cooling fan.....	24	14.2 Energy saving.....	35
11. HINTS AND TIPS.....	24	15. MENU STRUCTURE.....	36
11.1 Moist Fan Baking.....	24	15.1 Menu.....	36
11.2 Moist Fan Baking -		16. ENVIRONMENTAL CONCERNS.....	37
recommended accessories.....	26		

1. SAFETY INFORMATION

Before the installation and use of the appliance, carefully read the supplied instructions. The manufacturer is not responsible for any injuries or damage that are the result of incorrect installation or usage. Always keep the instructions in a safe and accessible location for future reference.

1.1 Children and vulnerable people safety

- This appliance can be used by children aged from 8 years and above and persons with reduced physical, sensory or mental capabilities or lack of experience and knowledge if they have been given supervision or instruction concerning the use of the appliance in a safe way and understand the hazards involved. Children of less than 8 years of age and persons with very extensive and complex disabilities shall be kept away from the appliance unless continuously supervised.

SAFETY INFORMATION

- Children should be supervised to ensure that they do not play with the appliance.
- Keep all packaging away from children and dispose of it appropriately.
- **WARNING:** The appliance and its accessible parts become hot during use. Keep children and pets away from the appliance when in use and when cooling down.
- If the appliance has a child safety device, it should be activated.
- Children shall not carry out cleaning and user maintenance of the appliance without supervision.

1.2 General Safety

- This appliance is for cooking purposes only.
- This appliance is designed for single household domestic use in an indoor environment.
- This appliance may be used in, offices, hotel guest rooms, bed & breakfast guest rooms, farm guest houses and other similar accommodation where such use does not exceed (average) domestic usage levels.
- Only a qualified person must install this appliance and replace the cable.
- Do not use the appliance before installing it in the built-in structure.
- Disconnect the appliance from the power supply before carrying out any maintenance.
- If the mains power supply cable is damaged, it must be replaced by the manufacturer, its Authorised Service Centre or similarly qualified persons to avoid an electrical hazard.
- **WARNING:** Ensure that the appliance is switched off before replacing the lamp to avoid the possibility of electric shock.
- **WARNING:** The appliance and its accessible parts become hot during use. Care should be taken to avoid touching heating elements.

- Always use oven gloves to remove or insert accessories or ovenware.
- To remove the shelf supports first pull the front of the shelf support and then the rear end away from the side walls. Install the shelf supports in the opposite sequence.
- Do not use a steam cleaner to clean the appliance.
- Do not use harsh abrasive cleaners or sharp metal scrapers to clean the glass door since they can scratch the surface, which may result in shattering of the glass.
- Before pyrolytic cleaning, remove all accessories and excessive deposits/spills from the oven cavity.

2. SAFETY INSTRUCTIONS

2.1 Installation

**WARNING!**

Only a qualified person must install this appliance.

- Remove all the packaging.
- Do not install or use a damaged appliance.
- Follow the installation instructions supplied with the appliance.
- Always take care when moving the appliance as it is heavy. Always use safety gloves and enclosed footwear.
- Do not pull the appliance by the handle.
- Install the appliance in a safe and suitable place that meets installation requirements.
- Keep the minimum distance from other appliances and units.
- Before mounting the appliance, check if the oven door opens without restraint.
- The appliance is equipped with an electric cooling system. It must be operated with the electric power supply.

Cabinet minimum height (Cabinet under the work-top minimum height)	580 (600) mm
Cabinet width	560 mm
Cabinet depth	550 (550) mm
Height of the front of the appliance	589 mm
Height of the back of the appliance	571 mm
Width of the front of the appliance	595 mm

SAFETY INSTRUCTIONS

Width of the back of the appliance	559 mm
Depth of the appliance	569 mm
Built in depth of the appliance	548 mm
Depth with open door	1022 mm
Ventilation opening minimum size. Opening placed on the bottom rear side	560x20 mm
Mains supply cable length. Cable is placed in the right corner of the back side	1500 mm
Mounting screws	4x25 mm

2.2 Electrical connection



WARNING!

Risk of fire and electric shock.

- All electrical connections should be made by a qualified electrician.
- The appliance must be earthed.
- Make sure that the parameters on the rating plate are compatible with the electrical ratings of the mains power supply.
- Always use a correctly installed shockproof socket.
- Do not use multi-plug adapters and extension cables.
- Make sure not to cause damage to the mains plug and to the mains cable. Should the mains cable need to be replaced, this must be carried out by our Authorised Service Centre.
- Do not let mains cables touch or come near the appliance door or the niche below the appliance, especially when it operates or the door is hot.
- The shock protection of live and insulated parts must be fastened in such a way that it cannot be removed without tools.
- Connect the mains plug to the mains socket only at the end of the installation. Make sure that there is access to the mains plug after the installation.
- If the mains socket is loose, do not connect the mains plug.
- Do not pull the mains cable to disconnect the appliance. Always pull the mains plug.
- Use only correct isolation devices: line protecting cut-outs, fuses (screw type fuses removed from the holder), earth leakage trips and contactors.
- The electrical installation must have an isolation device which lets you disconnect the appliance from the mains at all poles. The isolation device must have a contact opening width of minimum 3 mm.
- Fully close the appliance door before you connect the mains plug to the mains socket.
- This appliance is supplied with a main plug and a main cable.

Cable types applicable for installation or replacement for Europe:

H07 RN-F, H05 RN-F, H05 RRF, H05 VV-F, H05 V2V2-F (T90), H05 BB-F

For the section of the cable refer to the total power on the rating plate. You can also refer to the table:

Total power (W)	Section of the cable (mm ²)
maximum 1380	3 x 0.75
maximum 2300	3 x 1
maximum 3680	3 x 1.5

The earth cord (green / yellow cable) must be 2 cm longer than phase and neutral cables (blue and brown cables).

2.3 Use



WARNING!

Risk of injury, burns and electric shock or explosion.

- Do not change the specification of this appliance.
- Make sure that the ventilation openings are not blocked.
- Do not let the appliance stay unattended during operation.
- Deactivate the appliance after each use.
- Be careful when you open the appliance door while the appliance is in operation. Hot air can release.
- Do not operate the appliance with wet hands or when it has contact with water.
- Do not apply pressure on the open door.
- Do not use the appliance as a work surface or as a storage surface.
- Open the appliance door carefully. The use of ingredients with alcohol can cause a mixture of alcohol and air.
- Do not let sparks or open flames to come in contact with the appliance when you open the door.
- Do not put flammable products or items that are wet with flammable products in, near or on the appliance.



WARNING!

Risk of damage to the appliance.

- To prevent damage or discoloration to the enamel:
 - do not put ovenware or other objects in the appliance directly on the bottom.
 - do not put aluminium foil directly on the bottom of cavity of the appliance.
 - do not put water directly into the hot appliance.
 - do not keep moist dishes and food in the appliance after you finish the cooking.
 - be careful when you remove or install the accessories.

SAFETY INSTRUCTIONS

- Discoloration of the enamel or stainless steel has no effect on the performance of the appliance.
- Use a deep pan for moist cakes. Fruit juices cause stains that can be permanent.
- Always cook with the appliance door closed.
- If the appliance is installed behind a furniture panel (e.g. a door) make sure the door is never closed when the appliance operates. Heat and moisture can build up behind a closed furniture panel and cause subsequent damage to the appliance, the housing unit or the floor. Do not close the furniture panel until the appliance has cooled down completely after use.

2.4 Care and cleaning



WARNING!

Risk of injury, fire, or damage to the appliance.

- Before maintenance, deactivate the appliance and disconnect the mains plug from the mains socket.
- Make sure the appliance is cold. There is the risk that the glass panels can break.
- Replace immediately the door glass panels when they are damaged. Contact the Authorised Service Centre.
- Be careful when you remove the door from the appliance. The door is heavy!
- Clean regularly the appliance to prevent the deterioration of the surface material.
- Clean the appliance with a moist soft cloth. Use only neutral detergents. Do not use abrasive products, abrasive cleaning pads, solvents or metal objects.
- If you use an oven spray, follow the safety instructions on its packaging.

2.5 Pyrolytic cleaning



WARNING!

Risk of Injury / Fires / Chemical Emissions (Fumes) in Pyrolytic Mode.

- Before carrying out a Pyrolytic self-cleaning function or the First Use please remove from the oven cavity:
 - any excess food residues, oil or grease spills / deposits.
 - any removable objects (including shelves, side rails etc., provided with the product) particularly any non-stick pots, pans, trays, utensils etc.
- Read carefully all the instructions for Pyrolytic cleaning.
- Keep children away from the appliance while the Pyrolytic cleaning operates. The appliance becomes very hot and hot air is released from the front cooling vents.
- Pyrolytic cleaning is a high temperature operation that can release fumes from cooking residues and construction materials, as such consumers are strongly advised to:
 - provide good ventilation during and after each Pyrolytic cleaning.
 - provide good ventilation during and after the first use at maximum temperature operation.
- Unlike all humans, some birds and reptiles can be extremely sensitive to potential fumes emitted during the cleaning process of all Pyrolytic Ovens.
 - Remove any pets (especially birds) from the vicinity of the appliance location during and after the Pyrolytic cleaning and first use maximum temperature operation to a well ventilated area.
- Small pets can also be highly sensitive to the localized temperature changes in the vicinity of all Pyrolytic Ovens when the Pyrolytic self cleaning program is in operation.

- Non-stick surfaces on pots, pans, trays, utensils etc., can be damaged by the high temperature Pyrolytic cleaning operation of all Pyrolytic Ovens and can be also a source for low level harmful fumes.
- Fumes released from all Pyrolytic Ovens / Cooking Residues as described are not harmful to humans, including children, or persons with medical conditions.

2.6 Internal lighting



WARNING!

Risk of electric shock.

- Concerning the lamp(s) inside this product and spare part lamps sold separately: These lamps are intended to withstand extreme physical conditions in household appliances, such as temperature, vibration, humidity, or are intended to signal information about the operational status of the appliance. They are not intended to be used in other applications and are not suitable for household room illumination.
- This product contains a light source of energy efficiency class G.
- Use only lamps with the same specifications.

2.7 Service

- To repair the appliance contact the Authorised Service Centre.
- Use original spare parts only.

2.8 Disposal



WARNING!

Risk of injury or suffocation.

- Contact your municipal authority for information on how to dispose of the appliance.
- Disconnect the appliance from the mains supply.
- Cut off the mains electrical cable close to the appliance and dispose of it.
- Remove the door catch to prevent children or pets from becoming trapped in the appliance.

3. INSTALLATION



WARNING!

Refer to Safety chapters.

3.1 Building in



YouTube

www.youtube.com/electrolux
www.youtube.com/aeg

How to install your AEG/Electrolux
Oven - Column installation



INSTALLATION

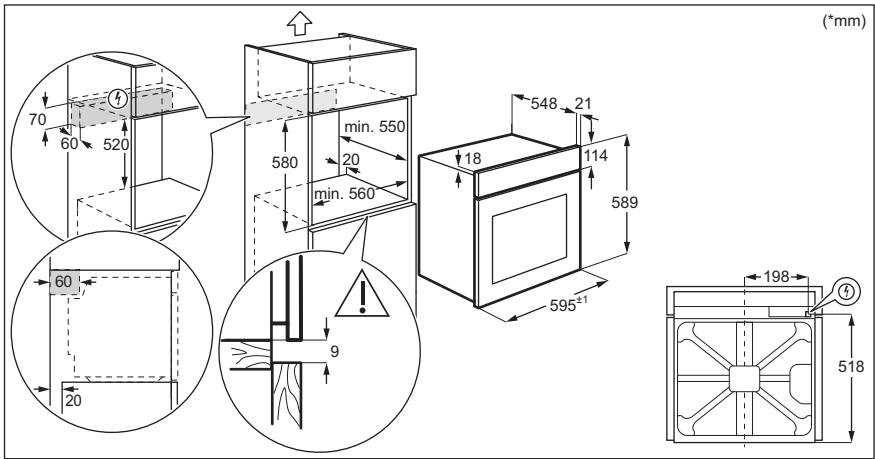
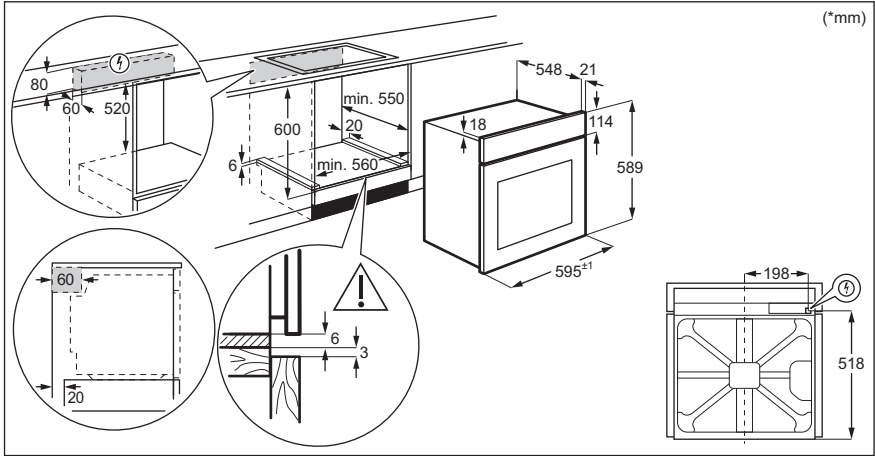

3.2 Securing the oven to the cabinet

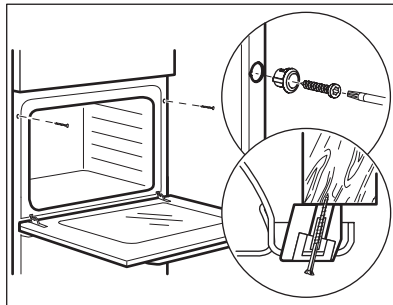

4. PRODUCT DESCRIPTION

4.1 General overview

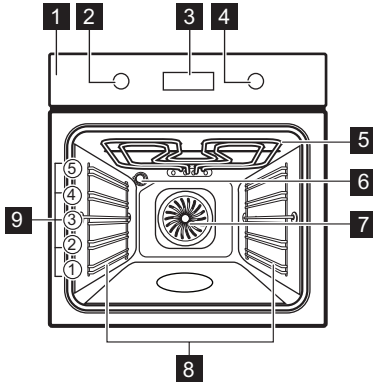

- 1** Control panel
- 2** Knob for the heating functions
- 3** Display
- 4** Control knob
- 5** Heating element
- 6** Lamp
- 7** Fan
- 8** Shelf support, removable
- 9** Shelf positions

4.2 Accessories

- **Wire shelf**
For cookware, cake tins, roasts.
- **Baking tray**
For cakes and biscuits.
- **Grill- / Roasting pan**
To bake and roast or as pan to collect fat.







5. HOW TO TURN OVEN ON AND OFF



5.1 Retractable knobs







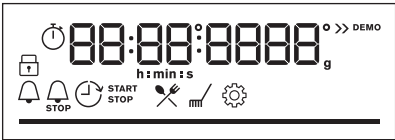

To use the appliance press the knob. The knob comes out.

HOW TO TURN OVEN ON AND OFF

5.2 Control panel

Control panel sensor fields					Press	Turn the knob
 Timer	 Fast Heat Up	 Light	 Lock	OK		
Select a heating function to turn on the oven.						
Turn the knob for the heating functions to the off position to turn the oven off.						

	When the knob for the heating functions is in the off position, the display goes to standby.
	When you cook, the display shows the set temperature, time of day and other available options.
	The display with the maximum number of functions set.

Display indicators				
 Lock	 Assisted Cooking	 Cleaning	 Settings	 Fast Heat Up
Timer indicators:		 STOP		

Progress bar - for temperature or time.	
--	---

6. BEFORE FIRST USE



WARNING!
Refer to Safety chapters.

6.1 Initial cleaning

Before the first use clean the empty oven and set the time:



00:00

Set the time. Press OK.

6.2 Initial preheating

Preheat the empty oven before the first use.

Step 1 Remove all accessories and removable shelf supports from the oven.

Step 2 Set the maximum temperature for the function: 
Let the oven operate for 1 h.

Step 3 Set the maximum temperature for the function: 
Let the oven operate for 15 min.

 The oven can emit an odour and smoke during preheating. Make sure that the room is ventilated.

7. DAILY USE





WARNING!
Refer to Safety chapters.

7.1 How to set: Heating functions

Start cooking







Step 1





Step 2

Start cooking	
	
Set a heating function.	Set the temperature.

7.2 Heating functions

Standard heating functions

Heating function	Application
 True Fan Cooking	To bake on up to three shelf positions at the same time and to dry food. Set the temperature 20 - 40 °C lower than for Conventional Cooking.
 Conventional Cooking	To bake and roast food on one shelf position.
 Frozen Foods	To make convenience food (e.g., french fries, potato wedges or spring rolls) crispy.
 Pizza Function	To bake pizza. To make intensive browning and a crispy bottom.
 Bottom Heat	To bake cakes with crispy bottom and to preserve food.
 Defrost	To defrost food (vegetables and fruit). The defrosting time depends on the amount and size of the frozen food.

Heating function	Application
 <p>Moist Fan Baking</p>	<p>This function is designed to save energy during cooking. When you use this function, the temperature in the cavity may differ from the set temperature. The residual heat is used. The heating power may be reduced. For more information refer to "Daily Use" chapter, Notes on: Moist Fan Baking.</p>
 <p>Grill</p>	<p>To grill thin pieces of food and to toast bread.</p>
 <p>Turbo Grilling</p>	<p>To roast large meat joints or poultry with bones on one shelf position. To make gratins and to brown.</p>
 <p>Menu</p>	<p>To enter the Menu: Assisted Cooking, Cleaning, Settings.</p>

7.3 Notes on: Moist Fan Baking

This function was used to comply with the energy efficiency class and ecodesign requirements according to EU 65/2014 and EU 66/2014. Tests according to EN 60350-1.

The oven door should be closed during cooking so that the function is not interrupted and the oven operates with the highest energy efficiency possible.







When you use this function the lamp automatically turns off after 30 sec.

For the cooking instructions refer to "Hints and tips" chapter, Moist Fan Baking. For general energy saving recommendations refer to "Energy Efficiency" chapter, Energy Saving.

7.4 How to set: Assisted Cooking

Every dish in this submenu has a recommended function and temperature. You can adjust the time and the temperature during cooking.

For some of the dishes you can also cook with:	<ul style="list-style-type: none"> • Weight Automatic
--	--



Assisted Cooking - use it to prepare a dish quickly with default settings:			
Step 1	Step 2	Step 3	Step 4
 	 	 <p>P1 - P45</p>	 <p>OK</p>

Assisted Cooking - use it to prepare a dish quickly with default settings:







Enter the menu.	Select Assisted Cooking. Press OK .	Select the dish. Press OK .	Insert the dish to the oven. Confirm setting.
-----------------	--	------------------------------------	---











7.5 Assisted Cooking

Legend















	Weight Automatic available.
	Preheat the oven before you start cooking.
	Shelf level.





















When the function ends check if the food is ready.

	Dish	Weight	Shelf level / Accessory	Duration time
Beef 				
P1	Roast Beef, rare	1 - 1,5 kg; 4 - 5 cm thick pieces	 2; baking tray Fry the meat for a few minutes on a hot pan. Insert to the oven.	40 min
P2	Roast Beef, medium			50 min
P3	Roast Beef, well done			60 min
P4	Steak, medium	180 - 220 g per piece; 3 cm thick slices	  3; roasting dish on wire shelf Fry the meat for a few minutes on a hot pan. Insert to the oven.	15 min
P5	Beef roast / braised (prime rib, top round, thick flank)	1,5 - 2 kg	  2; roasting dish on wire shelf Fry the meat for a few minutes on a hot pan. Add liquid. Insert to the oven.	120 min

















	Dish	Weight	Shelf level / Accessory	Duration time
P6	Roast Beef, rare (slow cooking)	1 - 1,5 kg; 4 - 5 cm thick pieces	 2; baking tray Use your favourite spices or simply salt and fresh grounded pepper. Fry the meat for a few minutes on a hot pan. Insert to the oven.	75 min
P7	Roast Beef, medium (slow cooking)			85 min
P8	Roast Beef, well done (slow cooking)			130 min
P9	Fillet, rare (slow cooking)	0,5 - 1,5 kg; 5 - 6 cm thick pieces	 2; baking tray Use your favourite spices or simply salt and fresh grounded pepper. Fry the meat for a few minutes on a hot pan. Insert to the oven.	75 min
P10	Fillet, medium (slow cooking)			90 min
P11	Fillet, done (slow cooking)			120 min
Veal 				
P12	Veal roast (e.g. shoulder)	0,8 - 1,5 kg; 4 cm thick pieces	  2; roasting dish on wire shelf Use your favourite spices. Add liquid. Roast covered.	80 min
Pork 				
P13	Pork roast neck or shoulder	1,5 - 2 kg	  2; roasting dish on wire shelf Turn the meat after half of the cooking time.	120 min
P14	Pulled pork (slow cooking)	1,5 - 2 kg	 2; baking tray Use your favourite spices. Turn the meat after half of the cooking time to get an even browning.	215 min
P15	Loin, fresh	1 - 1,5 kg; 5 - 6 cm thick pieces	 2; roasting dish on wire shelf Use your favourite spices.	55 min



DAILY USE

	Dish	Weight	Shelf level / Accessory	Duration time
P16	Spare Ribs	2 - 3 kg; use raw, 2 - 3 cm thin spare ribs	 3; deep pan Add liquid to cover the bottom of a dish. Turn the meat after half of the cooking time.	90 min
Lamb 				
P17	Lamb leg with bones	1,5 - 2 kg; 7 - 9 cm thick pieces	 2; roasting dish on baking tray Add liquid. Turn the meat after half of the cooking time.	130 min
Poultry 				
P18	Whole chicken	1 - 1,5 kg; fresh	  2; casserole dish on baking tray Use your favourite spices. Turn the chicken after half of the cooking time to get an even browning.	60 min
P19	Half chicken	0,5 - 0,8 kg	 3; baking tray Use your favourite spices.	40 min
P20	Chicken breast	180 - 200 g per piece	  2; casserole dish on wire shelf Use your favourite spices. Fry the meat for a few minutes on a hot pan.	25 min
P21	Chicken legs, fresh	-	 3; baking tray If you marinated chicken legs first, set lower temperature and cook them longer.	30 min
P22	Duck, whole	2 - 3 kg	  2; roasting dish on wire shelf Use your favourite spices. Put the meat on roasting dish. Turn the duck after half of the cooking time.	100 min
P23	Goose, whole	4 - 5 kg	  2; deep pan Use your favourite spices. Put the meat on deep baking tray. Turn the goose after half of the cooking time.	110 min
Other 				

	Dish	Weight	Shelf level / Accessory	Duration time
P24	Meat loaf	1 kg	 2; wire shelf Use your favourite spices.	60 min
Fish 				
P25	Whole fish, grilled	0,5 - 1 kg per fish	 2; baking tray Fill the fish with butter and use your favourite spices and herbs.	30 min
P26	Fish fillet	-	  3; casserole dish on wire shelf Use your favourite spices.	20 min
Sweet baking / desserts   				
P27	Cheesecake	-	 2;  28 cm springform tin on wire shelf	90 min
P28	Apple cake	-	 3; baking tray	45 min
P29	Apple tart	-	 2; pie form on wire shelf	40 min
P30	Apple pie	-	 1;  22 cm pie form on wire shelf	60 min
P31	Brownies	2 kg	 3; deep pan	30 min
P32	Chocolate muffins	-	 3; muffin tray on wire shelf	25 min
P33	Loaf cake	-	 2; loaf pan on wire shelf	50 min
Vegetable / Side dishes   				
P34	Baked potatoes	1 kg	 2; baking tray Put the whole potatoes with skin on baking tray.	50 min





DAILY USE

	Dish	Weight	Shelf level / Accessory	Duration time
P35	Wegdes	1 kg	 3; baking tray lined with baking paper Use your favourite spices. Cut potatoes into pieces.	35 min
P36	Grilled mixed vegetables	1 - 1,5 kg	 3; baking tray lined with baking paper Use your favourite spices. Cut the vegetables into pieces.	30 min
P37	Croquets, frozen	0,5 kg	 3; baking tray	25 min
P38	Pommes, frozen	0,75 kg	 3; baking tray	25 min
Gratins, bread and pizza   				
P39	Meat / vegetable lasagna with dry noodle plates	1 - 1,5 kg	 2; casserole dish on wire shelf	45 min
P40	Potato gratin (raw potatoes)	1 - 1,5 kg	 1; casserole dish on wire shelf Rotate the dish after half of the cooking time.	50 min
P41	Pizza fresh, thin	-	  2; baking tray lined with baking paper	15 min
P42	Pizza fresh, thick	-	  2; baking tray lined with baking paper	25 min
P43	Quiche	-	 2; baking tin on wire shelf	45 min
P44	Baguette / Ciabatta / White bread	0,8 kg	  3; baking tray lined with baking paper More time needed for white bread.	30 min



	Dish	Weight	Shelf level / Accessory	Duration time
P45	All grain / rye / dark bread all grain in loaf pan	1 kg	  2; baking tray lined with baking paper / wire shelf	60 min

8. CLOCK FUNCTIONS

8.1 Clock functions







Clock Function	Application
	Minute minder. When the timer ends, the signal sounds.
	Cooking time. When the timer ends, the signal sounds and the heating function stops.
	Time Delay. To postpone the start and / or end of cooking.
	Uptimer. Maximum is 23 h 59 min. This function has no effect on the operation of the oven. To turn on and off the Uptimer select: Menu, Settings.

8.2 How to set: Clock functions

How to set: Time of day		
Step 1	Step 2	Step 3
		
To change the time of day enter the menu and select Settings, Time of day.	Set the clock.	Press: OK.







CLOCK FUNCTIONS

How to set: Minute minder

Step 1	The display shows: 0:00 	Step 2	Step 3
			
Press: 		Set the Minute minder	Press: OK, 











 Timer starts counting down immediately.

How to set: Cooking time

Step 1	Step 2	The display shows: 0:00  STOP	Step 3	Step 4
				
Choose a heating function and set the temperature.	Press repeatedly: 		Set the cooking time.	Press: OK, 

 Timer starts counting down immediately.

How to set: Time Delay

Step 1	Step 2	The display shows: the time of day  START	Step 3	Step 4	The display shows: --:--  STOP	Step 5	Step 6
							
Select the heating function.	Press repeatedly: 		Set the start time.	Press: OK, 		Set the end time.	Press: OK, 

 Timer starts counting down at a set start time.

9. HOW TO USE: ACCESSORIES

9.1 Inserting accessories

A small indentation at the top increases safety. The indentations are also anti-tip devices. The high rim around the shelf prevents cookware from slipping off the shelf.

Wire shelf:

Push the shelf between the guide bars of the shelf support and make sure that the feet point down.

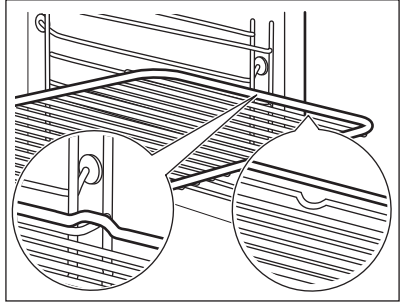

Baking tray / Deep pan:

Push the tray between the guide bars of the shelf support.

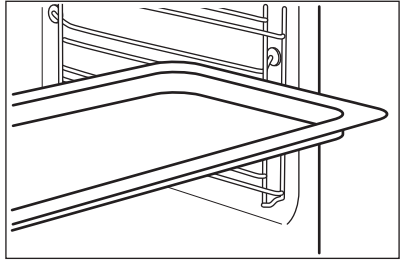

Wire shelf, Baking tray / Deep pan:



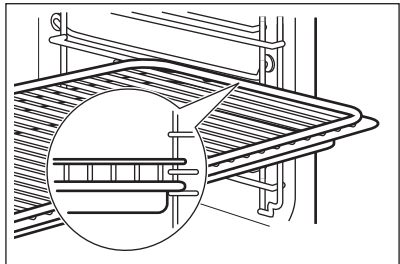

Push the tray between the guide bars of the shelf support and the wire shelf on the guide bars above.



ADDITIONAL FUNCTIONS



10. ADDITIONAL FUNCTIONS

10.1 Lock

This function prevents an accidental change of the oven function.		
Turn it on when the oven works - the set cooking continues, the control panel is locked. Turn it on when the oven is off - the oven cannot be turned on, the control panel is locked.		
	 - press and hold to turn on the function. A signal sounds.	 - press and hold to turn it off.
 3 x  - flashes when the lock is turned on.		

10.2 Automatic switch-off

For safety reasons the oven turns off after some time, if a heating function works and you do not change any settings.

 (°C)	 (h)
30 - 115	12.5
120 - 195	8.5
200 - 245	5.5
250 - maximum	3

The Automatic switch-off does not work with the functions: Light, Time Delay.

10.3 Cooling fan





When the oven operates, the cooling fan turns on automatically to keep the surfaces of the oven cool. If you turn off the oven, the cooling fan can continue to operate until the oven cools down.

11. HINTS AND TIPS





11.1 Moist Fan Baking

For the best results follow suggestions listed in the table below.

HINTS AND TIPS



		 (°C)		 (min)
Sweet rolls, 16 pieces	baking tray or dripping pan	180	2	20 - 30
Rolls, 9 pieces	baking tray or dripping pan	180	2	30 - 40
Pizza, frozen, 0.35 kg	wire shelf	220	2	10 - 15
Swiss Roll	baking tray or dripping pan	170	2	25 - 35
Brownie	baking tray or dripping pan	175	3	25 - 30
Soufflè, 6 pieces	ceramic ramekins on wire shelf	200	3	25 - 30
Sponge flan base	flan base tin on wire shelf	180	2	15 - 25
Victoria sandwich	baking dish on wire shelf	170	2	40 - 50
Poached fish, 0.3 kg	baking tray or dripping pan	180	3	20 - 25
Whole fish, 0.2 kg	baking tray or dripping pan	180	3	25 - 35
Fish fillet, 0.3 kg	pizza pan on wire shelf	180	3	25 - 30
Poached meat, 0.25 kg	baking tray or dripping pan	200	3	35 - 45
Shashlik, 0.5 kg	baking tray or dripping pan	200	3	25 - 30
Cookies, 16 pieces	baking tray or dripping pan	180	2	20 - 30
Macaroons, 24 pieces	baking tray or dripping pan	180	2	25 - 35

HINTS AND TIPS

		 (°C)		 (min)
Muffins, 12 pieces	baking tray or dripping pan	170	2	30 - 40
Savory pastry, 20 pieces	baking tray or dripping pan	180	2	25 - 30
Short crust biscuits, 20 pieces	baking tray or dripping pan	150	2	25 - 35
Tartlets, 8 pieces	baking tray or dripping pan	170	2	20 - 30
Vegetables, poached, 0.4 kg	baking tray or dripping pan	180	3	35 - 45
Vegetarian omelette	pizza pan on wire shelf	200	3	25 - 30
Mediterranean vegetables, 0.7 kg	baking tray or dripping pan	180	4	25 - 30

11.2 Moist Fan Baking - recommended accessories

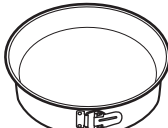
Use the dark and non-reflective tins and containers. They have better heat absorption than the light colour and reflective dishes.







			
Pizza pan	Baking dish	Ramekins	Flan base tin
Dark, non-reflective 28 cm diameter	Dark, non-reflective 26 cm diameter	Ceramic 8 cm diameter, 5 cm height	Dark, non-reflective 28 cm diameter

11.3 Cooking tables for test institutes







Information for test institutes

Tests according to IEC 60350-1.

HINTS AND TIPS

				 (°C)	 (min)	
Small cakes, 20 per tray	Conventional Cooking	Baking tray	3	170	20 - 30	-
Small cakes, 20 per tray	True Fan Cooking	Baking tray	3	150 - 160	20 - 35	-
Small cakes, 20 per tray	True Fan Cooking	Baking tray	2 and 4	150 - 160	20 - 35	-
Apple pie, 2 tins Ø20 cm	Conventional Cooking	Wire shelf	2	180	70 - 90	-
Apple pie, 2 tins Ø20 cm	True Fan Cooking	Wire shelf	2	160	70 - 90	-
Sponge cake, cake mould Ø26 cm	Conventional Cooking	Wire shelf	2	170	40 - 50	Preheat the oven for 10 minutes.
Sponge cake, cake mould Ø26 cm	True Fan Cooking	Wire shelf	2	160	40 - 50	Preheat the oven for 10 minutes.
Sponge cake, cake mould Ø26 cm	True Fan Cooking	Wire shelf	2 and 4	160	40 - 60	Preheat the oven for 10 minutes.

CARE AND CLEANING

				 (°C)	 (min)	
Short bread	True Fan Cooking	Baking tray	3	140 - 150	20 - 40	-
Short bread	True Fan Cooking	Baking tray	2 and 4	140 - 150	25 - 45	-
Short bread	Conventional Cooking	Baking tray	3	140 - 150	25 - 45	-
Toast, 4 - 6 pieces	Grill	Wire shelf	4	max.	2 - 3 minutes first side; 2 - 3 minutes second side	Preheat the oven for 3 minutes.
Beef burger, 6 pieces, 0.6 kg	Grill	Wire shelf and dripping pan	4	max.	20 - 30	Put the wire shelf on the fourth level and the dripping pan on the third level of the oven. Turn the food half-way through the cooking time. Preheat the oven for 3 minutes.

12. CARE AND CLEANING





WARNING!

Refer to Safety chapters.

12.1 Notes on cleaning

 Cleaning Agents	Clean the front of the oven with a soft cloth with warm water and a mild detergent.
	Use a cleaning solution to clean metal surfaces.
	Clean stains with a mild detergent.

 Everyday Use	<p>Clean the cavity after each use. Fat accumulation or other residue may cause fire.</p>
	<p>Moisture can condense in the oven or on the door glass panels. To decrease the condensation, let the oven work for 10 minutes before cooking. Do not store the food in the oven for longer than 20 minutes. Dry the cavity with a soft cloth after each use.</p>

 Accessories	<p>Clean all accessories after each use and let them dry. Use a soft cloth with warm water and a mild detergent. Do not clean the accessories in a dishwasher.</p>
	<p>Do not clean the non-stick accessories using abrasive cleaner or sharp-edged objects.</p>

12.2 How to remove: Shelf supports

Remove the shelf supports to clean the oven.

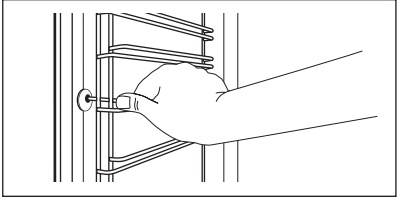
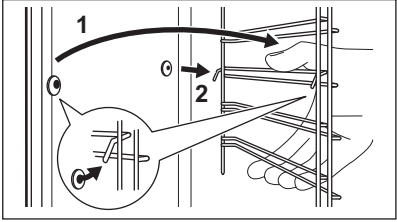
<p>Step 1</p>	<p>Turn off the oven and wait until it is cold.</p>	
<p>Step 2</p>	<p>Pull the front of the shelf support away from the side wall.</p>	
<p>Step 3</p>	<p>Pull the rear end of the shelf support away from the side wall and remove it.</p>	
<p>Step 4</p>	<p>Install the shelf supports in the opposite sequence.</p>	

12.3 How to use: Pyrolytic Cleaning

Clean the oven with Pyrolytic Cleaning.

	<p>WARNING! There is a risk of burns.</p>
--	--



	<p>CAUTION! If there are other appliances installed in the same cabinet, do not use them at the same time as this function. It can cause damage to the oven.</p>
--	---

CARE AND CLEANING

Before the Pyrolytic Cleaning:

Turn off the oven and wait until it is cold.	Remove all accessories.	Clean the oven floor and the inner door glass with warm water, a soft cloth and a mild detergent.
--	-------------------------	---

Pyrolytic Cleaning

Step 1	Enter menu: Cleaning m^{\prime} .	
	Option	Duration
	C1 - Light cleaning	1 h
	C2 - Normal cleaning	1 h 30 min
	C3 - Thorough cleaning	2 h 30 min
Step 2	OK - press to select the cleaning programme.	
Step 3	OK - press to start the cleaning.	
Step 4	After cleaning, turn the knob for the heating functions to the off position.	
 During the cleaning the oven lamp is off.		
When the oven is at the set temperature, the door locks. Until the door unlocks the display shows:  .		

When the cleaning ends:

Turn off the oven and wait until it is cold.	Clean the cavity with a soft cloth.	Remove the residue from the bottom of the cavity.
--	-------------------------------------	---

12.4 Cleaning Reminder

The oven reminds you when to clean it with pyrolytic cleaning.	
 flashes in the display for 5 sec after each cooking session.	To turn off the reminder enter the Menu and select Settings, Cleaning Reminder.

12.5 How to remove and install: Door

The oven door has three glass panels. You can remove the oven door and the internal glass panels to clean them. Read the whole "Removing and installing door" instruction before you remove the glass panels.

	CAUTION! Do not use the oven without the glass panels.
--	--

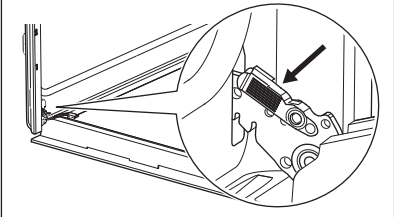
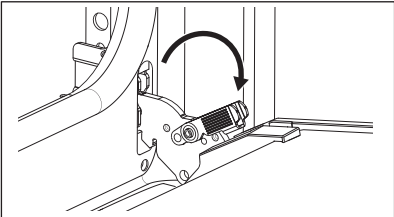
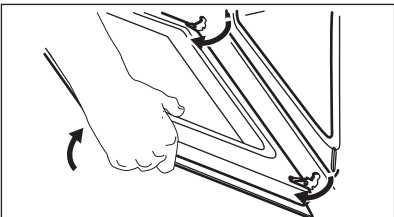
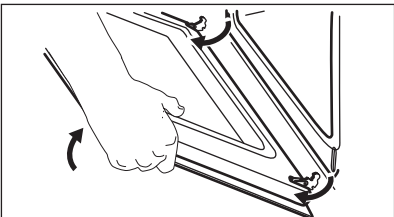
Step 1	Open the door fully and hold both hinges.	
Step 2	Lift and pull the latches until they click.	
Step 3	Close the oven door halfway to the first opening position. Then lift and pull to remove the door from its seat.	
Step 4	Put the door on a soft cloth on a stable surface.	

CARE AND CLEANING

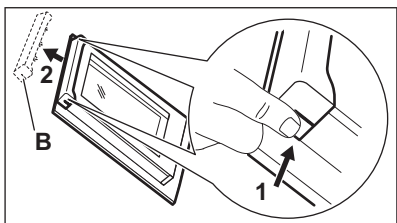
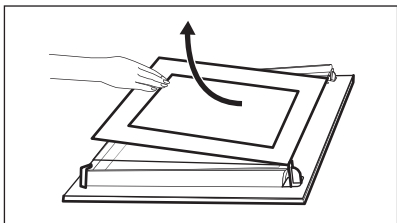
<p>Step 5</p>	<p>Hold the door trim (B) on the top edge of the door at the two sides and push inwards to release the clip seal.</p>	
<p>Step 6</p>	<p>Pull the door trim to the front to remove it.</p>	
<p>Step 7</p>	<p>Hold the door glass panels by their top edge and carefully pull them out one by one. Start from the top panel. Make sure the glass slides out of the supports completely.</p>	
<p>Step 8</p>	<p>Clean the glass panels with water and soap. Dry the glass panels carefully. Do not clean the glass panels in the dishwasher.</p>	
<p>Step 9</p>	<p>After cleaning, install the glass panels and the oven door.</p>	

If the door is installed correctly, you will hear a click when closing the latches.

Make sure that you put the glass panels (A and B) back in the correct sequence. Check for the symbol / printing on the side of the glass panel, each of the glass panels looks different to make the disassembly and assembly easier. When installed correctly the door trim clicks. Make sure that you install the middle panel of glass in the seats correctly.

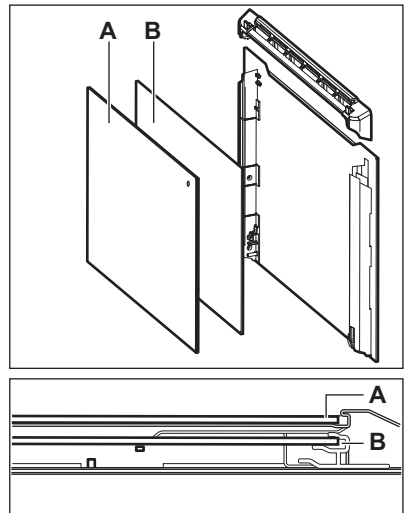

12.6 How to replace: Lamp



WARNING!

Risk of electric shock.
The lamp can be hot.

Always hold the halogen lamp with a cloth to prevent grease residue from burning on the lamp.

Before you replace the lamp:		
Step 1	Step 2	Step 3
Turn off the oven. Wait until the oven is cold.	Disconnect the oven from the mains.	Put a cloth on the bottom of the cavity.

Back lamp

Step 1	Turn the glass cover to remove it.
Step 2	Clean the glass cover.
Step 3	Replace the lamp with a suitable 300 °C heat-resistant lamp.
Step 4	Install the glass cover.

13. TROUBLESHOOTING



WARNING!

Refer to Safety chapters.

13.1 What to do if...

In any cases not included in this table please contact with an Authorised Service Centre.

The oven does not turn on or does not heat up	
Problem	Check if...
You cannot activate or operate the oven.	The oven is correctly connected to an electrical supply.
The oven does not heat up.	The automatic switch-off is deactivated.
The oven does not heat up.	The oven door is closed.
The oven does not heat up.	The fuse is not blown.

TROUBLESHOOTING

The oven does not turn on or does not heat up	
The oven does not heat up.	The Child Lock is off.

Components	
Problem	Check if...
The lamp is turned off.	Moist Fan Baking - is turned on.
The lamp does not work.	The lamp is burnt out.

Error codes	
The display shows...	Check if...
Err C3	The oven door is closed or the door lock is not broken.
Err F102	The oven door is closed.
Err F102	The door lock is not broken.
00:00	There was a power cut. Set the time of day.
If the display shows an error code that is not in this table turn the house fuse off and on to restart the oven. If the error code recurs contact an Authorised Service Centre.	

13.2 Service data

If you cannot find a solution to the problem yourself, contact your dealer or an Authorised Service Centre.

The necessary data for the service centre is on the rating plate. The rating plate is on the front frame of the oven cavity. Do not remove the rating plate from the oven cavity.

We recommend that you write the data here:	
Model (MOD.)
Product number (PNC)
Serial number (S.N.)

14. ENERGY EFFICIENCY

14.1 Product Information and Product Information Sheet*

Supplier's name	Electrolux	
Model identification	EOF4P46X 949498237 EOF6P46X 949498239	
Energy Efficiency Index	81.2	
Energy efficiency class	A+	
Energy consumption with a standard load, conventional mode	0.93 kWh/cycle	
Energy consumption with a standard load, fan-forced mode	0.69 kWh/cycle	
Number of cavities	1	
Heat source	Electricity	
Volume	72 l	
Type of oven	Built-In Oven	
Mass	EOF4P46X	29.5 kg
	EOF6P46X	31.6 kg

* For European Union according to EU Regulations 65/2014 and 66/2014.
For Republic of Belarus according to STB 2478-2017, Appendix G; STB 2477-2017, Annexes A and B.
For Ukraine according to 568/32020.

Energy efficiency class is not applicable for Russia.

EN 60350-1 - Household electric cooking appliances - Part 1: Ranges, ovens, steam ovens and grills - Methods for measuring performance.

14.2 Energy saving



The oven has features which help you save energy during everyday cooking.

MENU STRUCTURE

Make sure that the oven door is closed when the oven operates. Do not open the oven door too often during cooking. Keep the door gasket clean and make sure it is well fixed in its position.

Use metal cookware to improve energy saving.

When possible, do not preheat the oven before cooking.

Keep breaks between baking as short as possible when you prepare a few dishes at one time.

Cooking with fan

When possible, use the cooking functions with fan to save energy.

Residual heat

The fan and lamp continue to operate. When you turn off the oven, the display shows the residual heat. You can use that heat to keep the food warm.

When the cooking duration is longer than 30 min, reduce the oven temperature to minimum 3 - 10 min before the end of cooking. The residual heat inside the oven will continue to cook.

Use the residual heat to warm up other dishes.

Keep food warm

Choose the lowest possible temperature setting to use residual heat and keep a meal warm.

The residual heat indicator or temperature appears on the display.

Cooking with the lamp off

Turn off the lamp during cooking. Turn it on only when you need it.



Moist Fan Baking



Function designed to save energy during cooking.







When you use this function the lamp automatically turns off after 30 sec. You may turn on the lamp again but this action will reduce the expected energy savings.

15. MENU STRUCTURE

15.1 Menu



	 - select to enter the Menu.
---	---

Menu structure		
Assisted Cooking 	Cleaning 	Settings 

Step 1	Step 2	Step 3	Step 4	Step 5
 	 OK	 01 - 011	 OK	
Select the Menu, Settings.	Confirm setting.	Select the setting.	Confirm setting.	Adjust the value and press OK.

Settings					
O1	Time of day	Change	O2	Display brightness	1 - 5
O3	Key tones	1 - Beep 2 - Click 3 - Sound off	O4	Buzzer volume	1 - 4
O5	Uptimer	On / Off	O6	Light	On / Off
O7	Fast Heat Up	On / Off	O8	Cleaning Reminder	On / Off
O9	Demo mode	Activation code: 2468	O10	Software version	Check
O11	Reset all settings	Yes / No			

16. ENVIRONMENTAL CONCERNS

Recycle materials with the symbol . Put the packaging in relevant containers to recycle it. Help protect the environment and human health by recycling waste of electrical and electronic appliances. Do not dispose of appliances marked with the symbol  with the household waste. Return the product to your local recycling facility or contact your municipal office.

NOUS PENSONS À VOUS

Merci d'avoir choisi un appareil Electrolux. Vous avez choisi un produit qui bénéficie de décennies d'expérience professionnelle et d'innovation. Ingénieux et élégant, il a été pensé pour vous. C'est la raison pour laquelle vous pouvez avoir la certitude d'obtenir d'excellents résultats à chaque utilisation.

Bienvenue chez Electrolux
Consultez notre site pour :



Obtenir des conseils d'utilisation, des brochures, un dépanneur, des informations sur le service et les réparations :

www.electrolux.com/support



Enregistrer votre produit pour un meilleur service :

www.registerelectrolux.com



Acheter des accessoires, consommables et pièces de rechange d'origine pour votre appareil :

www.electrolux.com/shop



Pour plus de recettes, conseils, informations de dépannage, téléchargez l'application **My Electrolux Kitchen**.



SERVICE ET ASSISTANCE À LA CLIENTÈLE

N'utilisez que des pièces de rechange d'origine.

Avant de contacter notre centre de service agréé, assurez-vous de disposer des informations suivantes : Modèle, PNC, numéro de série.

Ces informations figurent sur la plaque signalétique.

 Avertissement/Consignes de sécurité

 Informations générales et conseils

 Informations environnementales

Sous réserve de modifications.

TABLE DES MATIÈRES

1. INFORMATION SUR LA SÉCURITÉ.....	39	2.6 Éclairage interne.....	45
1.1 Sécurité des enfants et des personnes vulnérables.....	40	2.7 Service.....	46
1.2 Sécurité générale.....	40	2.8 Mise au rebut.....	46
2. CONSIGNES DE SÉCURITÉ.....	41	3. INSTALLATION.....	46
2.1 Installation.....	41	3.1 Encastrement.....	46
2.2 Branchement électrique.....	42	3.2 Fixation du four au meuble.....	47
2.3 Utilisation.....	43	4. DESCRIPTION DE L'APPAREIL.....	48
2.4 Entretien et Nettoyage.....	44	4.1 Vue d'ensemble.....	48
2.5 Nettoyage par pyrolyse.....	45	4.2 Accessoires.....	48

5. COMMENT ALLUMER ET ÉTEINDRE LE FOUR.....	48	11.2 Circulation d'air humide - accessoires recommandés.....	64
5.1 Manettes rétractables.....	48	11.3 Tableaux de cuisson pour les instituts de tests.....	64
5.2 Bandeau de commande.....	49	12. ENTRETIEN ET NETTOYAGE.....	66
6. AVANT LA PREMIÈRE UTILISATION.....	50	12.1 Remarques concernant l'entretien.....	67
6.1 Nettoyage initial.....	50	12.2 Comment retirer : Supports de grille	67
6.2 Préchauffage initial.....	50	12.3 Comment utiliser : Nettoyage par pyrolyse.....	68
7. UTILISATION QUOTIDIENNE.....	50	12.4 Nettoyage conseillé.....	69
7.1 Comment régler : Modes de cuisson.....	50	12.5 Comment démonter et installer : Couvercle.....	69
7.2 Modes de cuisson.....	51	12.6 Comment remplacer : Éclairage..	71
7.3 Remarques sur : Circulation d'air humide.....	52	13. DÉPANNAGE.....	72
7.4 Comment régler : Cuisson assistée.....	52	13.1 Que faire si.....	72
7.5 Cuisson assistée.....	53	13.2 Données de maintenance.....	73
8. FONCTIONS DE L'HORLOGE.....	58	14. RENDEMENT ÉNERGÉTIQUE.....	73
8.1 Fonctions de l'horloge.....	58	14.1 Informations produit et fiche d'informations produit*.....	73
8.2 Comment régler : Fonctions de l'horloge.....	59	14.2 Économie d'énergie.....	74
9. CONSEILS D'UTILISATION : ACCESSOIRES.....	60	15. STRUCTURE DES MENUS.....	75
9.1 Insertion des accessoires.....	60	15.1 Menu	75
10. FONCTIONS SUPPLÉMENTAIRES.....	61	16. EN MATIÈRE DE PROTECTION DE L'ENVIRONNEMENT.....	76
10.1 Touches Verrouil.....	61		
10.2 Arrêt automatique.....	61		
10.3 Ventilateur de refroidissement.....	62		
11. CONSEILS.....	62		
11.1 Circulation d'air humide.....	62		

1. ⚠ INFORMATION SUR LA SÉCURITÉ

Avant d'installer et d'utiliser cet appareil, lisez soigneusement les instructions fournies. Le fabricant ne pourra être tenu pour responsable des blessures et dégâts résultant d'une mauvaise installation ou utilisation. Conservez toujours les instructions dans un lieu sûr et accessible pour vous y référer ultérieurement.

1.1 Sécurité des enfants et des personnes vulnérables

- Cet appareil peut être utilisé par des enfants âgés d'au moins 8 ans et par des personnes ayant des capacités physiques, sensorielles ou mentales réduites ou dénuées d'expérience ou de connaissance, s'ils sont correctement surveillés ou si des instructions relatives à l'utilisation de l'appareil en toute sécurité leur ont été données et s'ils comprennent les risques encourus. Les enfants de moins de 8 ans et les personnes ayant un handicap très important et complexe doivent être tenus à l'écart de l'appareil, à moins d'être surveillés en permanence.
- Veillez à ce que les enfants ne jouent pas avec l'appareil.
- Ne laissez pas les emballages à la portée des enfants et jetez-les convenablement.
- **AVERTISSEMENT** : L'appareil et ses parties accessibles deviennent chauds pendant l'utilisation. Tenez les enfants et les animaux éloignés de l'appareil lorsqu'il est en cours d'utilisation et de refroidissement.
- Si l'appareil est équipé d'un dispositif de sécurité enfants, nous vous recommandons de l'activer.
- Le nettoyage et l'entretien par l'utilisateur ne doivent pas être effectués par des enfants sans surveillance.

1.2 Sécurité générale

- Cet appareil est exclusivement destiné à un usage culinaire.
- Cet appareil est conçu pour un usage domestique unique, dans un environnement intérieur.
- Cet appareil peut être utilisé dans les bureaux, les chambres d'hôtel, les chambres d'hôtes, les maisons d'hôtes de ferme et d'autres hébergements similaires lorsque cette utilisation ne dépasse pas le niveau (moyen) de l'utilisation domestique.

- Cet appareil doit être installé et le câble remplacé uniquement par un professionnel qualifié.
- N'utilisez pas l'appareil avant de l'avoir installé dans la structure encastrée.
- Débranchez l'appareil de l'alimentation électrique avant toute opération d'entretien.
- Si le câble d'alimentation secteur est endommagé, son remplacement doit être confié exclusivement au fabricant, à son service après-vente ou à toute autre personne qualifiée afin d'éviter tout danger électrique.
- **AVERTISSEMENT** : Assurez-vous que l'appareil est éteint avant de remplacer l'ampoule pour éviter tout risque d'électrocution.
- **AVERTISSEMENT** : L'appareil et ses parties accessibles deviennent chauds pendant l'utilisation. Veillez à ne pas toucher les éléments chauffants.
- Utilisez toujours des gants de cuisine pour retirer ou mettre des accessoires ou des plats allant au four.
- Pour retirer les supports de grille, tirez d'abord l'avant du support de grille, puis l'arrière à distance des parois latérales. Installez les supports de grille dans l'ordre inverse.
- N'utilisez pas de nettoyeur à vapeur pour nettoyer l'appareil.
- N'utilisez pas de produits abrasifs ni de racloirs pointus en métal pour nettoyer la porte en verre car ils peuvent rayer la surface, ce qui peut briser le verre.
- Avant le nettoyage par pyrolyse, retirez tous les accessoires et les dépôts/déversements excessifs de la cavité du four.

2. CONSIGNES DE SÉCURITÉ

2.1 Installation

**AVERTISSEMENT!**

L'appareil doit être installé uniquement par un professionnel qualifié.

- Retirez l'intégralité de l'emballage.
- N'installez pas et ne branchez pas un appareil endommagé.
- Suivez scrupuleusement les instructions d'installation fournies avec l'appareil.

CONSIGNES DE SÉCURITÉ

- Soyez toujours vigilants lorsque vous déplacez l'appareil car il est lourd. Utilisez toujours des gants de sécurité et des chaussures fermées.
- Ne tirez jamais l'appareil par la poignée.
- Installez l'appareil dans un lieu sûr et adapté répondant aux exigences d'installation.
- Respectez l'espacement minimal requis par rapport aux autres appareils et éléments.
- Avant de monter l'appareil, vérifiez si la porte du four s'ouvre sans retenue.
- L'appareil est équipé d'un système de refroidissement électrique. Il doit être utilisé avec l'alimentation électrique.

Hauteur minimale du meuble (Hauteur minimale du meuble sous le plan de travail)	580 (600) mm
Largeur du meuble	560 mm
Profondeur du meuble	550 (550) mm
Hauteur de l'avant de l'appareil	589 mm
Hauteur de l'arrière de l'appareil	571 mm
Largeur de l'avant de l'appareil	595 mm
Largeur de l'arrière de l'appareil	559 mm
Profondeur de l'appareil	569 mm
Profondeur d'encastrement de l'appareil	548 mm
Profondeur avec porte ouverte	1022 mm
Dimensions minimales de l'ouverture de ventilation. Ouverture placée sur la partie inférieure de la face arrière	560x20 mm
Longueur du câble d'alimentation secteur. Le câble est placé dans le coin droit de la face arrière	1500 mm
Vis de montage	4x25 mm

2.2 Branchement électrique



AVERTISSEMENT!

Risque d'incendie ou d'électrocution.

- Tous les raccordements électriques doivent être effectués par un électricien qualifié.
- L'appareil doit être relié à la terre.
- Assurez-vous que les paramètres figurant sur la plaque signalétique correspondent aux données électriques nominale de l'alimentation secteur.

- Utilisez toujours une prise de courant de sécurité correctement installée.
- N'utilisez pas d'adaptateurs multiprise et de rallonges.
- Veillez à ne pas endommager la fiche secteur ni le câble d'alimentation. Le remplacement du câble d'alimentation de l'appareil doit être effectué par notre service après-vente agréé.
- Ne laissez pas les câbles d'alimentation entrer en contact ou s'approcher de la porte de l'appareil ou de la niche d'encastrement sous l'appareil, particulièrement lorsqu'il est en marche ou que la porte est chaude.
- La protection contre les chocs des parties sous tension et isolées doit être fixée de telle manière qu'elle ne puisse pas être enlevée sans outils.
- Ne branchez la fiche secteur dans la prise secteur qu'à la fin de l'installation. Assurez-vous que la prise secteur est accessible après l'installation.
- Si la prise secteur est détachée, ne branchez pas la fiche secteur.
- Ne tirez pas sur le câble secteur pour débrancher l'appareil. Tirez toujours sur la fiche de la prise secteur.
- N'utilisez que des systèmes d'isolation appropriés : des coupe-circuits, des fusibles (les fusibles à visser doivent être retirés du support), un disjoncteur différentiel et des contacteurs.
- L'installation électrique doit comporter un dispositif d'isolation qui vous permet de déconnecter l'appareil du secteur à tous les pôles. Le dispositif d'isolement doit avoir une largeur d'ouverture de contact de 3 mm minimum.
- Fermez bien la porte de l'appareil avant de brancher la fiche à la prise secteur.
- Cet appareil est fourni avec une fiche électrique et un câble d'alimentation.

Types de câbles compatibles pour l'installation ou le remplacement pour l'Europe :

H07 RN-F, H05 RN-F, H05 RRF, H05 VV-F, H05 V2V2-F (T90), H05 BB-F

Pour la section du câble, consultez la puissance totale sur la plaque signalétique. Vous pouvez également consulter le tableau :

Puissance totale (W)	Section du câble (mm ²)
maximum 1 380	3 x 0.75
maximum 2 300	3 x 1
maximum 3 680	3 x 1.5

Le fil de terre (câble vert/jaune) doit être 2 cm plus long que les câbles de phase et neutre (câbles bleu et marron).

2.3 Utilisation



AVERTISSEMENT!

Risque de blessures, de brûlures, d'électrocution ou d'explosion.

- Ne modifiez pas les spécifications de cet appareil.
- Assurez-vous que les orifices d'aération ne sont pas obstrués.
- Ne laissez pas l'appareil sans surveillance durant son fonctionnement.

CONSIGNES DE SÉCURITÉ

- Éteignez l'appareil après chaque utilisation.
- Soyez prudent lors de l'ouverture de la porte de l'appareil lorsque celui-ci fonctionne. De l'air chaud peut se dégager.
- N'utilisez pas l'appareil avec des mains mouillées ou en contact avec de l'eau.
- N'exercez pas de pression sur la porte ouverte.
- N'utilisez pas l'appareil comme plan de travail ou comme espace de rangement.
- Ouvrez la porte de l'appareil avec précaution. L'utilisation d'ingrédients avec de l'alcool peut provoquer un mélange d'alcool et d'air.
- Ne laissez pas des étincelles ou des flammes nues entrer en contact avec l'appareil lorsque vous ouvrez la porte.
- Ne placez pas de produits inflammables ou d'éléments imbibés de produits inflammables à l'intérieur, à proximité ou au-dessus de l'appareil.



AVERTISSEMENT!

Risque d'endommagement de l'appareil.

- Pour éviter tout endommagement ou décoloration de l'émail :
 - ne posez pas de plats allant au four ou d'autres objets directement dans le fond de l'appareil.
 - ne placez jamais de feuilles d'aluminium directement sur le fond de la cavité de l'appareil.
 - ne versez pas d'eau directement dans l'appareil chaud.
 - ne conservez pas de plats et de nourriture humides dans l'appareil après avoir terminé la cuisson.
 - Installez ou retirez les accessoires avec précautions.
- La décoloration de l'émail ou de l'acier inoxydable est sans effet sur les performances de l'appareil.
- Utilisez un plat à rôtir pour des gâteaux moelleux. Les jus de fruits provoquent des taches qui peuvent être permanentes.
- Cuisinez toujours avec la porte de l'appareil fermée.
- Si l'appareil est installé derrière la paroi d'un meuble (par ex. une porte), veuillez à ce que la porte ne soit jamais fermée lorsque l'appareil fonctionne. La chaleur et l'humidité peuvent s'accumuler derrière la porte fermée du meuble et provoquer d'importants dégâts sur l'appareil, votre logement ou le sol. Ne fermez pas la paroi du meuble tant que l'appareil n'a pas refroidi complètement.

2.4 Entretien et Nettoyage



AVERTISSEMENT!

Risque de blessure, d'incendie ou de dommages matériels sur l'appareil.

- Avant toute opération d'entretien, éteignez l'appareil et débranchez la fiche de la prise secteur.
- Vérifiez que l'appareil est froid. Les panneaux de verre risquent de se briser.
- Remplacez immédiatement les vitres de la porte si elles sont endommagées. Contactez le service après-vente agréé.
- Soyez prudent lorsque vous retirez la porte de l'appareil. La porte est lourde !
- Nettoyez régulièrement l'appareil afin de maintenir le revêtement en bon état.
- Nettoyez l'appareil avec un chiffon doux humide. Utilisez uniquement des produits de lavage neutres. N'utilisez pas de produits abrasifs, de tampons à récurer, de solvants ni d'objets métalliques.

- Si vous utilisez un spray pour four, suivez les consignes de sécurité figurant sur son emballage.

2.5 Nettoyage par pyrolyse



AVERTISSEMENT!

Risque de blessures, d'incendie, d'émissions chimiques (fumées) en mode pyrolyse.

- Avant d'utiliser la fonction de nettoyage par pyrolyse ou la fonction Première utilisation, retirez de la cavité du four :
 - tout résidu excessif de nourriture, tout dépôt ou toute éclaboussure de graisse ou d'huile.
 - tout objet amovible (y compris les grilles, les rails, etc., fournis avec le produit), en particulier les récipients, plateaux, plaques, ustensiles, etc. anti-adhésifs.
- Lisez attentivement toutes les instructions relatives au nettoyage par pyrolyse.
- Tenez les jeunes éloignés de l'appareil lorsque le nettoyage par pyrolyse est en cours. L'appareil devient très chaud et de l'air chaud s'échappe des fentes d'aération avant.
- Le nettoyage par pyrolyse est un processus à haute température qui peut dégager de la fumée provenant des résidus alimentaires et des matériaux dont est fait le four. Par conséquent, nous recommandons à nos clients de suivre les conseils ci-dessous :
 - assurez-vous que la ventilation de l'appareil est adéquate pendant et après chaque phase de nettoyage par pyrolyse.
 - assurez-vous que la ventilation de l'appareil est adéquate pendant et après la première utilisation à température maximale.
- Contrairement aux humains, certains oiseaux et reptiles sont extrêmement sensibles aux fumées pouvant se dégager lors du processus de nettoyage des fours à pyrolyse.
 - Ne laissez aucun animal, en particulier aucun oiseau, à proximité de l'appareil pendant et après un nettoyage par pyrolyse ; la première fois, utilisez la température de fonctionnement maximale dans une pièce bien ventilée.
- Les animaux de petite taille peuvent également être très sensibles aux changements de température survenant à proximité d'un four à pyrolyse lorsque le processus de nettoyage est en cours.
- Les surfaces antiadhésives des ustensiles de cuisine (poêles, casseroles, plaques de cuisson, etc.) peuvent être endommagées par la très haute température nécessaire au nettoyage par pyrolyse et peuvent également dégager, dans une moindre mesure, des fumées nocives.
- Les fumées dégagées par les fours à pyrolyse / les résidus de cuisson sont décrites comme étant non nocives pour les êtres humains, y compris pour les enfants et les personnes à la santé fragile.

2.6 Éclairage interne



AVERTISSEMENT!

Risque d'électrocution !

- Concernant la/les lampe(s) à l'intérieur de ce produit et les lampes de rechange vendues séparément : Ces lampes sont conçues pour résister à des conditions physiques extrêmes dans les appareils électroménagers, telles que la température, les vibrations, l'humidité, ou sont conçues pour signaler des informations sur le statut opérationnel de l'appareil. Elles ne sont pas destinées à être utilisées dans d'autres applications et ne conviennent pas à l'éclairage des pièces d'un logement.

INSTALLATION

- Ce produit contient une source lumineuse de classe d'efficacité énergétique G.
- Utilisez uniquement des ampoules ayant les mêmes spécifications.

2.7 Service

- Pour réparer l'appareil, contactez le service après-vente agréé.
- Utilisez uniquement des pièces de rechange d'origine.

2.8 Mise au rebut



AVERTISSEMENT!

Risque de blessure ou d'asphyxie.

- Contactez votre service municipal pour obtenir des informations sur la marche à suivre pour mettre l'appareil au rebut.
- Débranchez l'appareil de l'alimentation électrique.
- Coupez le câble d'alimentation au ras de l'appareil et mettez-le au rebut.
- Retirez le dispositif de verrouillage du hublot pour empêcher les jeunes et les animaux de s'enfermer dans l'appareil.

3. INSTALLATION



AVERTISSEMENT!

Reportez-vous aux chapitres concernant la sécurité.

3.1 Encastrement



YouTube

www.youtube.com/electrolux
www.youtube.com/aeg

How to install your AEG/Electrolux
Oven - Column installation

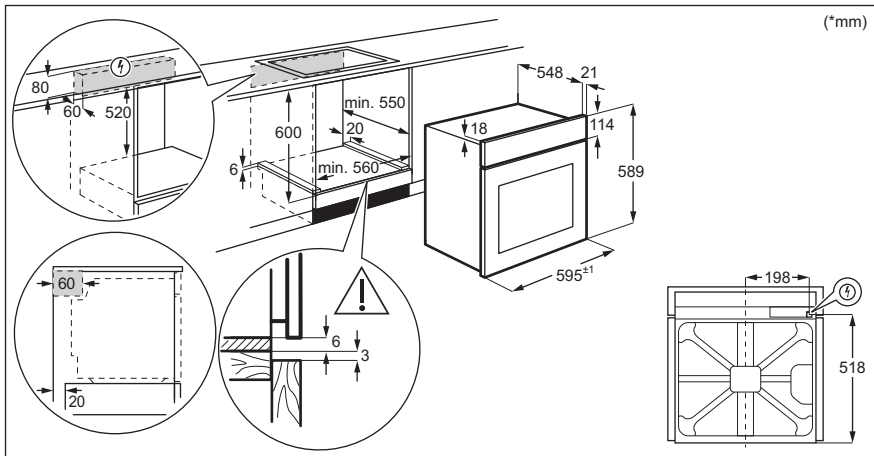

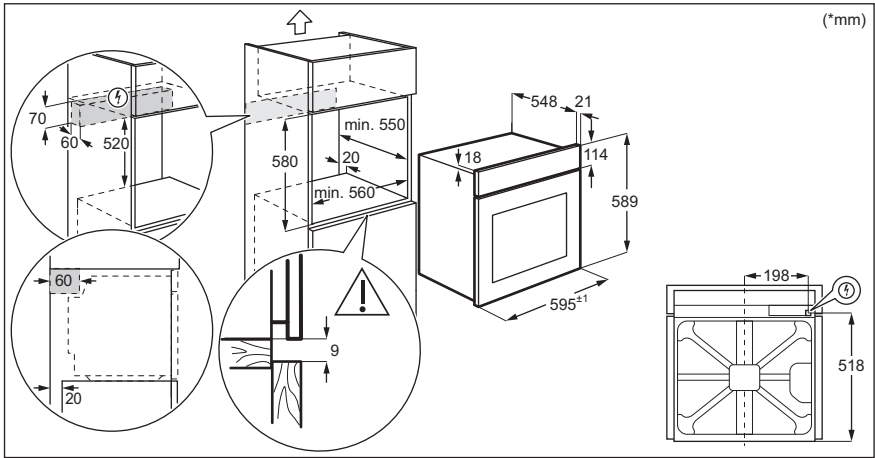

3.2 Fixation du four au meuble

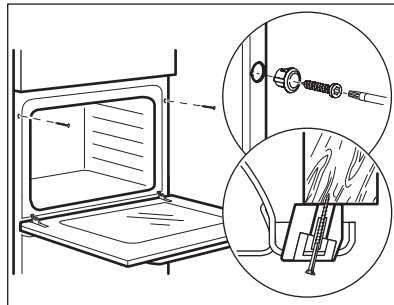

4. DESCRIPTION DE L'APPAREIL

4.1 Vue d'ensemble

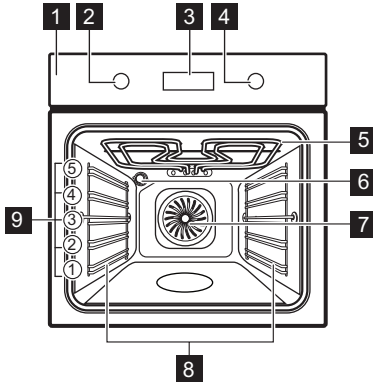

- 1** Bandeau de commande
- 2** Manette de sélection des modes de cuisson
- 3** Affichage
- 4** Manette de commande
- 5** Résistance
- 6** Éclairage
- 7** Chaleur tournante
- 8** Support de grille, amovible
- 9** Niveaux de la grille

4.2 Accessoires

- **Grille métallique**
Pour les plats de cuisson, les moules à gâteaux, les rôtis.
- **Plateau de cuisson**
Pour les gâteaux et biscuits.
- **Plat à rôtir**
Pour cuire et rôtir ou comme plat pour récupérer la graisse.

5. COMMENT ALLUMER ET ÉTEINDRE LE FOUR

5.1 Manettes rétractables

Pour utiliser l'appareil, appuyez sur la manette. La manette sort alors de son logement.



COMMENT ALLUMER ET ÉTEINDRE LE FOUR







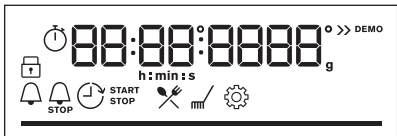

5.2 Bandeau de commande

Touches tactiles du bandeau de commande					Appuyez sur la touche	Tournez la manette
 Minuteur	 Préchauffage rapide	 Eclairage four	 Touches Verrouil	OK		

Sélectionnez un mode de cuisson pour allumer le four.

Tournez la manette des modes de cuisson sur la position Arrêt pour éteindre le four.

	Lorsque la manette des modes de cuisson est en position Arrêt, l'affichage se met en veille.
	Lorsque vous cuisinez, l'affichage indique la température réglée, l'heure et d'autres options disponibles.
	L'affichage avec le nombre maximal de fonctions réglées.

Voyants de l'affichage				
 Touches Verrouil.	 Cuisson assistée	 Nettoyage	 Configurations	 Préchauffage rapide
Voyants du minuteur :				

Barre de progression - de la température ou de l'heure.	
--	---

AVANT LA PREMIÈRE UTILISATION

6. AVANT LA PREMIÈRE UTILISATION



AVERTISSEMENT!

Reportez-vous aux chapitres concernant la sécurité.

6.1 Nettoyage initial

Avant la première utilisation, nettoyez le four à vide et réglez la durée :



0:00.

Réglez l'heure. Appuyez sur la touche OK.

6.2 Préchauffage initial

Préchauffez le four à vide avant de l'utiliser pour la première fois.

Étape 1 Retirez les supports de grille amovibles et tous les accessoires du four.

Étape 2 Réglez la température maximale pour la fonction : .
Laissez le four fonctionner pendant 1 heure.

Étape 3 Réglez la température maximale pour la fonction : .
Laissez le four fonctionner pendant 15 minutes.

 Une odeur et de la fumée peuvent s'échapper du four durant le préchauffage. Assurez-vous que la pièce est ventilée.

7. UTILISATION QUOTIDIENNE



AVERTISSEMENT!



Reportez-vous aux chapitres concernant la sécurité.

7.1 Comment régler : Modes de cuisson

Pour lancer la cuisson







Étape 1





Étape 2

Pour lancer la cuisson	
	
Sélectionnez un mode de cuisson.	Réglez la température.

7.2 Modes de cuisson

Modes de cuisson standard

Mode de cuisson	Application
 Chaleur tournante	Pour faire cuire sur 3 niveaux en même temps et pour sécher des aliments. Diminuez les températures de 20 à 40 °C par rapport à la Chauffage Haut/Bas.
 Chauffage Haut/Bas	Pour cuire et rôtir des aliments sur un seul niveau.
 Plats Surgelés	Pour rendre croustillants vos plats préparés, tels que frites, pommes quartiers et nems.
 Fonction Pizza	Pour cuire des pizzas. Pour faire dorer de façon intensive et obtenir un dessous croustillant.
 Cuisson de sole	Pour cuire des gâteaux à fond croustillant et pour stériliser des aliments.
 Décongélation	Pour décongeler des aliments (fruits et légumes). Le temps de décongélation dépend de la quantité et de la grosseur des plats surgelés.

Mode de cuisson	Application
 <p>Circulation d'air humide</p>	<p>Cette fonction est conçue pour économiser de l'énergie en cours de cuisson. Lorsque vous utilisez cette fonction, la température à l'intérieur de la cavité peut différer de la température sélectionnée. La chaleur résiduelle est utilisée. La puissance peut être réduite. Pour plus d'informations, consultez la partie sur les remarques du chapitre « Utilisation quotidienne ». Circulation d'air humide.</p>
 <p>Gril</p>	<p>Pour faire griller des aliments peu épais et du pain.</p>
 <p>Turbo gril</p>	<p>Pour rôti de gros morceaux de viande ou de volaille avec os sur un seul niveau. Pour gratiner et faire dorer.</p>
 <p>Menu</p>	<p>Pour accéder au menu : Cuisson assistée, Nettoyage, Configurations.</p>

7.3 Remarques sur : Circulation d'air humide

Cette fonction était utilisée pour se conformer à la classe d'efficacité énergétique et aux exigences Ecodesign selon les normes EU 65/2014 et UE 66/2014. Tests conformément à la norme EN 60350-1.

La porte du four doit être fermée pendant la cuisson pour que la fonction ne soit pas interrompue et que le four fonctionne avec la plus grande efficacité énergétique possible. Lorsque vous utilisez cette fonction, l'éclairage s'éteint automatiquement au bout de 30 secondes.

Pour consulter les instructions de cuisson, reportez-vous au chapitre « Conseils », Circulation d'air humide. Pour obtenir des recommandations générales sur l'économie d'énergie, reportez-vous au chapitre « Efficacité énergétique », « Économie d'énergie ».





7.4 Comment régler : Cuisson assistée

Chaque plat apparaissant dans ce sous-menu a une fonction et une température recommandées. Vous pouvez régler la durée et la température pendant la cuisson.



<p>Pour certains plats, vous pouvez également réaliser la cuisson avec :</p>	<ul style="list-style-type: none"> • Poids automatique
--	---

Cuisson assistée - vous pouvez l'utiliser pour préparer un plat rapidement avec les réglages par défaut :			
Étape 1	Étape 2	Étape 3	Étape 4



Cuisson assistée - vous pouvez l'utiliser pour préparer un plat rapidement avec les réglages par défaut :

 ≡	 ✂	 P1 - P45	 OK
Accédez au menu.	Sélectionner Cuisson assistée. Appuyez sur OK.	Sélectionnez le plat. Appuyez sur la touche OK.	Placez le plat dans le four. Confirmez la configuration.











7.5 Cuisson assistée













Légende	
	Poids automatique disponible.
	Préchauffez le four avant de commencer la cuisson.
	Niveau de grille.

Lorsque la fonction se termine, vérifiez si les aliments sont prêts.

















	Plat	Poids	Niveau/Accessoire	Durée
Bœuf 🍖				
P1	Rôti de bœuf, saignant	1 - 1,5 kg ; 4 - 5 cm d'épaisseur	 2 ; plateau de cuisson Faire frire la viande pendant quelques minutes sur une poêle chaude. Insérez au four.	40 min
P2	Rôti de bœuf, à point			50 min
P3	Rôti de bœuf, bien cuit			60 min
P4	Steak de bœuf, à point	180 - 220 g par pièce ; 3 cm d'épaisseur	  3 ; plat à rôtir sur grille métallique Faire frire la viande pendant quelques minutes sur une poêle chaude. Insérez au four.	15 min













UTILISATION QUOTIDIENNE

	Plat	Poids	Niveau/Accessoire	Durée
P5	Bœuf rôti/ braisé (côte de bœuf, intérieur de ronde, flanchet)	1,5 - 2 kg	  2 ; plat à rôtir sur grille métallique Faire frire la viande pendant quelques minutes sur une poêle chaude. Ajoutez du liquide. Insérez au four.	120 min
P6	Rôti de bœuf, saignant (cuisson basse température)	1 - 1,5 kg ; 4 - 5 cm d'épaisseur	 2 ; plateau de cuisson Servez-vous de vos épices préférées ou simplement du sel et du poivre fraîchement moulu. Faire frire la viande pendant quelques minutes sur une poêle chaude. Insérez au four.	75 min
P7	Rôti de bœuf, à point (cuisson basse température)			85 min
P8	Rôti de bœuf, bien cuit (cuisson basse température)			130 min
P9	Filet, saignant (cuisson basse température)	0,5 - 1,5 kg ; 5 - 6 cm d'épaisseur	 2 ; plateau de cuisson Servez-vous de vos épices préférées ou simplement du sel et du poivre fraîchement moulu. Faire frire la viande pendant quelques minutes sur une poêle chaude. Insérez au four.	75 min
P10	Filet, à point (cuisson basse température)			90 min
P11	Filet, bien cuit (cuisson basse température)			120 min
Veau 				
P12	Rôti de veau (par ex. épau- le)	0,8 - 1,5 kg ; 4 cm d'épaisseur	  2 ; plat à rôtir sur grille métallique Utilisez vos épices préférées. Ajoutez du liquide. Rôti couvert.	80 min
Porc  				
P13	Rôti de porc - collet ou épaule	1,5 - 2 kg	  2 ; plat à rôtir sur grille métallique Retournez la viande à la moitié du temps de cuisson.	120 min







	Plat	Poids	Niveau/Accessoire	Durée
P14	Émincé de porc (cuisson lente)	1,5 - 2 kg	 2 ; plateau de cuisson Utilisez vos épices préférées. Retournez la viande à la moitié du temps de cuisson pour faire dorer de manière homogène.	215 min
P15	Longe, fraîche	1 - 1,5 kg ; 5 - 6 cm d'épaisseur	 2 ; plat à rôtir sur grille métallique Utilisez vos épices préférées.	55 min
P16	Travers	2 - 3 kg ; crus, 2 - 3 cm d'épaisseur	 3 plat profond Ajoutez du liquide pour recouvrir le fond d'un plat. Retournez la viande à la moitié du temps de cuisson.	90 min
Agneau 				
P17	Gigot d'agneau avec os	1,5 - 2 kg ; 7 - 9 cm d'épaisseur	 2 ; plat à rôtir sur plateau de cuisson Ajoutez du liquide. Retournez la viande à la moitié du temps de cuisson.	130 min
Volaille 				
P18	Poulet entier	1 - 1,5 kg ; frais	  2 ; cocotte sur plateau de cuisson Utilisez vos épices préférées. Retournez le poulet à la moitié du temps de cuisson pour faire dorer de manière homogène.	60 min
P19	Demi poulet	0,5 - 0,8 kg	 3 ; plateau de cuisson Utilisez vos épices préférées.	40 min
P20	Escalope de poulet	180 - 200 g par pièce	  2 ; cocotte sur grille métallique Utilisez vos épices préférées. Faire frire la viande pendant quelques minutes sur une poêle chaude.	25 min
P21	Cuisses de poulet, fraîches	-	 3 ; plateau de cuisson Si vous avez mariné les cuisses de poulet, réglez une température inférieure et faites-les cuire plus longtemps.	30 min

UTILISATION QUOTIDIENNE

	Plat	Poids	Niveau/Accessoire	Durée
P22	Canard entier	2 - 3 kg	 2 ; plat à rôtir sur grille métallique Utilisez vos épices préférées. Placez la viande sur un plat à rôtir. Retournez le canard à la moitié du temps de cuisson.	100 min
P23	Oie entière	4 - 5 kg	 2 ; plat profond Utilisez vos épices préférées. Placez la viande sur un plateau de cuisson profond. Retournez l'oie à la moitié du temps de cuisson.	110 min
Autres 				
P24	Rôti haché	1 kg	 2 ; grille métallique Utilisez vos épices préférées.	60 min
Poisson 				
P25	Poisson entier, grillé	0,5 - 1 kg par poisson	 2 ; plateau de cuisson Remplissez le poisson avec du beurre et utilisez vos épices et herbes préférées.	30 min
P26	Filet de poisson	-	 3 ; cocotte sur grille métallique Utilisez vos épices préférées.	20 min
Gâteaux/desserts   				
P27	Cheesecake	-	 2 ;  moule à charnière de 28 cm sur grille métallique	90 min
P28	Gâteau aux pommes	-	 3 ; plateau de cuisson	45 min
P29	Tarte aux pommes	-	 2 ; moule à tarte sur grille métallique	40 min
P30	Tarte aux pommes	-	 1 ;  moule à tarte de 22 cm sur grille métallique	60 min
P31	Brownies	2 kg	 3 ; plat profond	30 min





	Plat	Poids	Niveau/Accessoire	Durée
P32	Muffins au chocolat	-	 3 ; bac à muffins sur grille métallique	25 min
P33	Quatre-quarts	-	 2 ; moule quatre-quarts sur grille métallique	50 min
Légumes/Garnitures 				
P34	Pommes de terre au four	1 kg	 2 ; plateau de cuisson Placez les pommes de terre entières avec la peau sur un plateau de cuisson.	50 min
P35	Quartiers	1 kg	 3 ; plateau de cuisson recouvert de papier sulfurisé Utilisez vos épices préférées. Coupez les pommes de terre en morceaux.	35 min
P36	Mélange de légumes grillés	1 - 1,5 kg	 3 ; plateau de cuisson recouvert de papier sulfurisé Utilisez vos épices préférées. Coupez les légumes en morceaux.	30 min
P37	Croquettes surgelées	0,5 kg	 3 ; plateau de cuisson	25 min
P38	Pommes, surgelées	0,75 kg	 3 ; plateau de cuisson	25 min
Gratins, pain et pizza   				
P39	Lasagnes de viande / légumes avec assiettes de nouilles sèches	1 - 1,5 kg	 2 ; cocotte sur grille métallique	45 min
P40	Gratin de pommes de terre (pommes de terre crues)	1 - 1,5 kg	 1 ; cocotte sur grille métallique Tournez le plat après la moitié du temps de cuisson.	50 min

FONCTIONS DE L'HORLOGE



	Plat	Poids	Niveau/Accessoire	Durée
P41	Pizza fraîche, fine	-	 2 ; plateau de cuisson recouvert de papier sulfurisé	15 min
P42	Pizza fraîche, épaisse	-	 2 ; plateau de cuisson recouvert de papier sulfurisé	25 min
P43	Quiche	-	 2 ; plat de cuisson sur grille métallique	45 min
P44	Baguette/ Ciabatta/Pain blanc	0,8 kg	  3 ; plateau de cuisson recouvert de papier sulfurisé Prolonger le temps pour le pain blanc.	30 min
P45	Tous grains/ seigle/pain complet grains entiers dans un moule à pain	1 kg	  2 ; plateau de cuisson recouvert de papier sulfurisé / grille métallique	60 min







8. FONCTIONS DE L'HORLOGE







8.1 Fonctions de l'horloge

Fonctions de l'horloge	Application
	Minuteur. Lorsque le minuteur termine le décompte, le signal sonore retentit.
	Heure de cuisson. Lorsque le minuteur termine le décompte, le signal sonore retentit et le mode de cuisson s'arrête.
	Départ différé. Pour reporter le début et/ou la fin de la cuisson.
	Compteur. Le maximum est de 23 h 59 min. Cette fonction n'a aucun effet sur le fonctionnement du four. Pour activer et désactiver le Compteur, sélectionnez : Menu , Configurations.

8.2 Comment régler : Fonctions de l'horloge









Comment régler Heure actuelle		
Étape 1	Étape 2	Étape 3
		
Pour modifier l'heure actuelle, accédez au menu et sélectionnez Configurations, Heure actuelle.	Réglez l'horloge.	Appuyez sur OK.

Comment régler Minuteur			
Étape 1	L'affichage indique : 0:00 	Étape 2	Étape 3
			
Appuyez sur : 		Réglez la Minuteur	Appuyez sur OK.
 Le minuteur commence son décompte immédiatement.			

Comment régler Heure de cuisson				
Étape 1	Étape 2	L'affichage indique : 0:00  STOP	Étape 3	Étape 4
				
Choisissez le mode de cuisson et réglez la température.	Appuyez à plusieurs reprises : 		Réglez le temps de cuisson.	Appuyez sur OK.
 Le minuteur commence son décompte immédiatement.				

CONSEILS D'UTILISATION : ACCESSOIRES

Comment régler Départ différé

Étape 1	Étape 2		Étape 3	Étape 4		Étape 5	Étape 6
		L'affichage indique : l'heure actuelle			L'affichage indique : --:--		
Sélectionnez le mode de cuisson.	Appuyez à plusieurs reprises : 	 DÉ-MAR-RER	Réglez l'heure de départ.	Appuyez sur OK.	 AR-RÊTER	Réglez l'heure de fin.	Appuyez sur OK.

 Le minuteur commence à compter à l'heure réglée.

9. CONSEILS D'UTILISATION : ACCESSOIRES

9.1 Insertion des accessoires

Une petite indentation sur le dessus apporte plus de sécurité. Les indentations sont également des dispositifs anti-bascule. Le rebord élevé de la grille empêche les ustensiles de cuisine de glisser sur la grille.

Grille métallique:



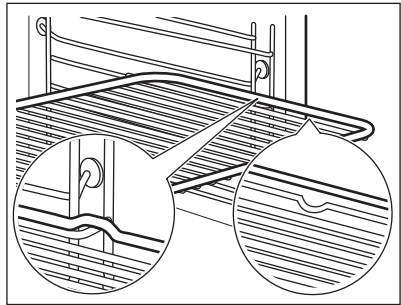

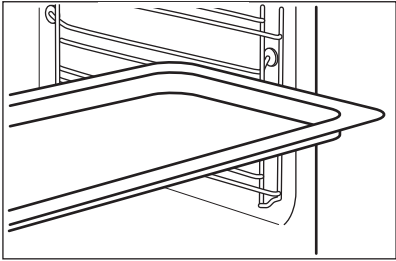
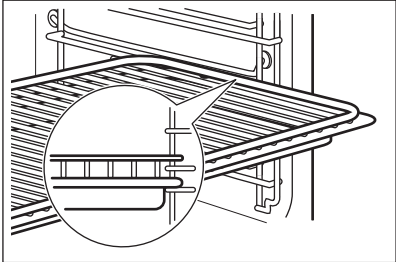
Poussez la grille entre les barres de guidage des supports de grille et assurez-vous que les pieds sont orientés vers le bas.



<p>Plateau de cuisson / Plat à rôtir: Poussez la plaque entre les rails du support de grille.</p>	
<p>Grille métallique, Plateau de cuisson / Plat à rôtir: Poussez la plaque entre les rails du support de grille et glissez la grille métallique entre les rails se trouvant juste au-dessus.</p>	

10. FONCTIONS SUPPLÉMENTAIRES



10.1 Touches Verrouil.

<p>Cette fonction permet d'éviter une modification involontaire de la fonction du four.</p>		
<p>Activez-la lorsque le four est allumé - la cuisson réglée est maintenue, le bandeau de commande est verrouillé. Activez-la lorsque le four est éteint - le four ne peut pas être allumé, le bandeau de commande est verrouillé.</p>		
	<p> - maintenez la touche enfoncée pour activer la fonction. Un signal sonore retentit.</p>	<p> - maintenez la touche enfoncée pour la désactiver.</p>
<p> 3 x  - clignote lorsque le verrouillage est activé.</p>		

10.2 Arrêt automatique

Pour des raisons de sécurité, le four s'éteint au bout d'un certain temps si un mode de cuisson est en cours et vous ne modifiez aucun réglage.

CONSEILS

 (°C)	 (h)
30 - 115	12.5
120 - 195	8.5
200 - 245	5.5
250 -maximum	3

L'arrêt automatique ne fonctionne pas avec les fonctions : Eclairage four, Départ différé.





10.3 Ventilateur de refroidissement





Lorsque le four fonctionne, le ventilateur de refroidissement se met automatiquement en marche pour refroidir les surfaces du four. Si vous éteignez le four, le ventilateur de refroidissement continue à fonctionner jusqu'à ce que le four refroidisse.

11. CONSEILS





11.1 Circulation d'air humide

Pour de meilleurs résultats, suivez les suggestions indiquées dans le tableau ci-dessous.

		 (°C)		 (min)
Petits pains su-crés, (16 pièces)	Plateau de cuisson ou plat à rôtir	180	2	20 - 30
Petits pains, (9 pièces)	Plateau de cuisson ou plat à rôtir	180	2	30 - 40
Pizza, surgelée, 0,35 kg	grille métallique	220	2	10 - 15
Gâteau Roulé	Plateau de cuisson ou plat à rôtir	170	2	25 - 35
Brownie	Plateau de cuisson ou plat à rôtir	175	3	25 - 30
Soufflé, (6 pièces)	ramequins en céramique sur une grille métallique	200	3	25 - 30



		 (°C)		 (min)
Fond de tarte en génoise	moule à tarte sur une grille métallique	180	2	15 - 25
Gâteau à étages	Plat de cuisson sur la grille métallique	170	2	40 - 50
Poisson poché, 0,3 kg	Plateau de cuisson ou plat à rôtir	180	3	20 - 25
Poisson entier, 0,2 kg	Plateau de cuisson ou plat à rôtir	180	3	25 - 35
Filet de poisson, 0,3 kg	plaque à pizza sur la grille métallique	180	3	25 - 30
Viande pochée, 0,25 kg	Plateau de cuisson ou plat à rôtir	200	3	35 - 45
Chachlyk, 0,5 kg	Plateau de cuisson ou plat à rôtir	200	3	25 - 30
Cookies, (16 pièces)	Plateau de cuisson ou plat à rôtir	180	2	20 - 30
Meringues, (24 pièces)	Plateau de cuisson ou plat à rôtir	180	2	25 - 35
Muffins, (12 pièces)	Plateau de cuisson ou plat à rôtir	170	2	30 - 40
Petite pâtisserie salée, (20 pièces)	Plateau de cuisson ou plat à rôtir	180	2	25 - 30
Biscuits à pâte sablée, (20 pièces)	Plateau de cuisson ou plat à rôtir	150	2	25 - 35
Tartelettes, (8 pièces)	Plateau de cuisson ou plat à rôtir	170	2	20 - 30
Légumes, pochés, 0,4 kg	Plateau de cuisson ou plat à rôtir	180	3	35 - 45

CONSEILS

		 (°C)		 (min)
Omelette végétarienne	plaque à pizza sur la grille métallique	200	3	25 - 30
Légumes méditerranéens, 0,7 kg	Plateau de cuisson ou plat à rôtir	180	4	25 - 30

11.2 Circulation d'air humide - accessoires recommandés

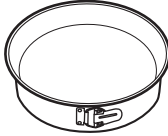

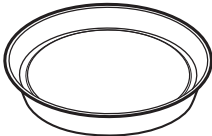



Utilisez les moules et récipients foncés et non réfléchissants. Ils offrent une meilleure absorption de la chaleur que les plats réfléchissants de couleur claire.







			
Plaque à pizza	Plat de cuisson	Ramequins	Moule pour fond de tarte
Sombre, non réfléchissant Diamètre de 28 cm	Sombre, non réfléchissant Diamètre : 26 cm	Céramique 8 cm de diamètre, 5 cm de hauteur	Sombre, non réfléchissant Diamètre de 28 cm

11.3 Tableaux de cuisson pour les instituts de tests







Informations pour les organismes de contrôle

Tests conformément à la norme IEC 60350-1.

				 (°C)	 (min)	
Petits gâteaux, 20 par plateau	Chauffage Haut/Bas	Plateau de cuisson	3	170	20 - 30	-

				 (°C)	 (min)	
Petits gâteaux, 20 par plateau	Chaleur tournante	Plateau de cuisson	3	150 - 160	20 - 35	-
Petits gâteaux, 20 par plateau	Chaleur tournante	Plateau de cuisson	2 et 4	150 - 160	20 - 35	-
Tarte aux pommes, 2 moules Ø20 cm	Chauffage Haut/Bas	Grille métallique	2	180	70 - 90	-
Tarte aux pommes, 2 moules Ø20 cm	Chaleur tournante	Grille métallique	2	160	70 - 90	-
Génoise, moule à gâteau Ø26 cm	Chauffage Haut/Bas	Grille métallique	2	170	40 - 50	Préchauffez le four pendant 10 minutes.
Génoise, moule à gâteau Ø26 cm	Chaleur tournante	Grille métallique	2	160	40 - 50	Préchauffez le four pendant 10 minutes.
Génoise, moule à gâteau Ø26 cm	Chaleur tournante	Grille métallique	2 et 4	160	40 - 60	Préchauffez le four pendant 10 minutes.

ENTRETIEN ET NETTOYAGE

				 (°C)	 (min)	
Sablé	Chaleur tournante	Plateau de cuisson	3	140 - 150	20 - 40	-
Sablé	Chaleur tournante	Plateau de cuisson	2 et 4	140 - 150	25 - 45	-
Sablé	Chauffage Haut/Bas	Plateau de cuisson	3	140 - 150	25 - 45	-
Pain grillé, 4 à 6 morceaux	Gril	Grille métallique	4	max.	2 à 3 minutes sur la première face ; 2 à 3 minutes sur la seconde face.	Préchauffez le four pendant 3 minutes.
Steak haché de bœuf, 6 pièces, 0,6 kg	Gril	Grille métallique et lèche-frite	4	max.	20 - 30	Placez la grille métallique sur le quatrième niveau et la lèche-frite sur le troisième niveau du four. Retournez les aliments à la moitié du temps de cuisson. Préchauffez le four pendant 3 minutes.



12. ENTRETIEN ET NETTOYAGE



AVERTISSEMENT!

Reportez-vous aux chapitres concernant la sécurité.

12.1 Remarques concernant l'entretien

 <p>Agents nettoyants</p>	Nettoyez la façade du four avec un chiffon doux, de l'eau tiède et un détergent doux.
	Utilisez une solution de nettoyage pour nettoyer les surfaces métalliques.
	Nettoyez les taches avec un détergent doux.
 <p>Utilisation quotidienne</p>	Nettoyez la cavité après chaque utilisation. L'accumulation de graisse ou d'autres résidus peut provoquer un incendie.
	De l'humidité peut se déposer dans l'enceinte du four ou sur les vitres de la porte. Pour diminuer la condensation, laissez fonctionner le four pendant 10 minutes avant la cuisson. Ne conservez pas les aliments dans le four pendant plus de 20 minutes. Sécher la cavité avec un chiffon doux après chaque utilisation.
 <p>Accessoires</p>	Après chaque utilisation, lavez tous les accessoires et séchez-les. Utilisez un chiffon doux avec de l'eau tiède et un détergent doux. Ne lavez pas les accessoires au lave-vaisselle.
	Ne nettoyez pas les accessoires antiadhésifs avec un produit nettoyant abrasif ou des objets tranchants.

12.2 Comment retirer : Supports de grille

Retirez les supports de grille pour nettoyer le four.

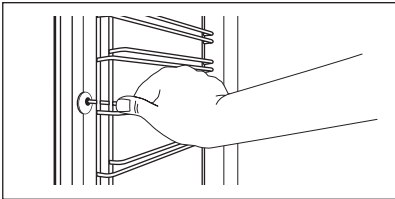
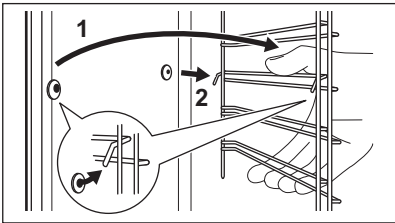
Étape 1	Éteignez le four et attendez qu'il soit froid.	
Étape 2	Écartez l'avant du support de grille de la paroi latérale.	
Étape 3	Écartez l'arrière du support de grille de la paroi latérale et retirez-le.	
Étape 4	Installez les supports de grille dans l'ordre inverse.	

12.3 Comment utiliser : Nettoyage par pyrolyse

Nettoyez le four avec Nettoyage par pyrolyse.



AVERTISSEMENT!

Risque de brûlure.





ATTENTION!

Si un autre appareil est installé dans le même meuble, ne l'utilisez pas en même temps que cette fonction. Vous risqueriez d'endommager le four.

Avant le Nettoyage par pyrolyse :

Éteignez le four et attendez qu'il soit froid.	Retirez les accessoires .	Nettoyez la sole du four et la vitre interne de la porte avec de l'eau tiède, un chiffon doux et un détergent doux.
--	---------------------------	---

Nettoyage par pyrolyse

Étape 1	Ouvrez le menu : Nettoyage  .	
	Option	Durée
	C1 - Nettoyage léger	1 h
	C2 - Nettoyage normal	1 h 30 min
	C3 - Nettoyage complet	2 h 30 min
Étape 2	OK - appuyez pour définir le programme de nettoyage.	
Étape 3	OK - appuyez pour démarrer le nettoyage.	
Étape 4	Après le nettoyage, tournez la manette des modes de cuisson sur la position Arrêt.	
 Au cours du nettoyage, l'éclairage du four est éteint.		
Lorsque le four atteint la température réglée, la porte se verrouille. Jusqu'à ce que la porte se déverrouille, l'affichage indique :  .		

Une fois le nettoyage terminé :

Éteignez le four et attendez qu'il soit froid.	Nettoyez la cavité avec un chiffon doux.	Retirez les résidus du fond de la cavité.
--	--	---

12.4 Nettoyage conseillé

Le four vous rappelle lorsque le nettoyage par pyrolyse est terminé.

 clignote sur l'affichage pendant 5 secondes après chaque session de cuisson.	Pour désactiver le rappel, accédez au Menu et sélectionnez Configurations, Nettoyage conseillé.
---	---

12.5 Comment démonter et installer : Couvercle

La porte du four dispose de trois panneaux de verre. Vous pouvez retirer la porte du four et la vitre interne pour les nettoyer. Lisez toutes les instructions du chapitre « Retrait et installation de la porte » avant de retirer les panneaux de verre.



ATTENTION!

N'utilisez pas le four sans les panneaux de verre.

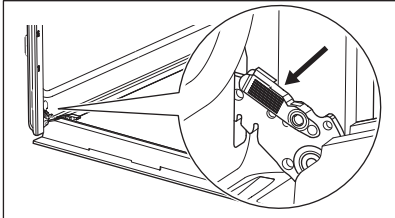
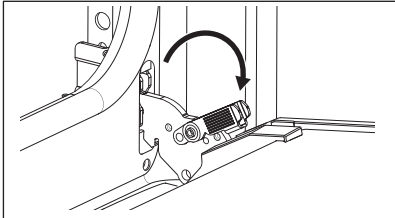
Étape 1	Ouvrez complètement la porte et saisissez les 2 charnières de porte.	
Étape 2	Soulevez et tirez les loquets jusqu'à ce qu'ils produisent un clic.	

ENTRETIEN ET NETTOYAGE

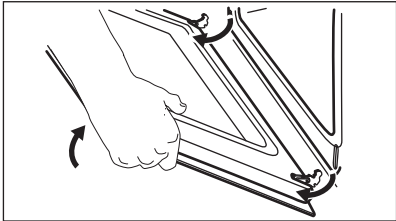
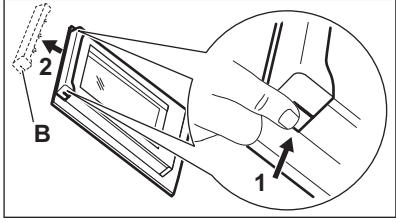
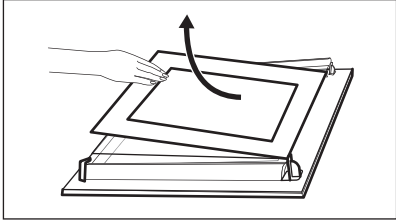
Étape 3	Fermez la porte du four à mi-chemin de la première position d'ouverture. Puis, soulevez et tirez pour retirer la porte de son emplacement.	
Étape 4	Posez la porte sur un chiffon doux placé sur une surface stable.	
Étape 5	Tenez la garniture de porte (B) sur le bord supérieur de la porte des deux côtés et poussez vers l'intérieur pour libérer le joint du clip.	
Étape 6	Retirez le cache de la porte en le tirant vers l'avant.	
Étape 7	Saisissez les panneaux de verre de la porte par leur bord supérieur et dégagez-les un par un. Commencez par le panneau supérieur. Assurez-vous que la vitre glisse entièrement hors de ses supports.	
Étape 8	Nettoyez les vitres à l'eau savonneuse. Essayez soigneusement les panneaux de verre. Ne passez pas les panneaux en verre au lave-vaisselle.	
Étape 9	Après le nettoyage, installez les panneaux de verre et la porte du four.	
Si la porte est installée correctement, vous entendrez un clic lors de la fermeture des loquets.		

Veillez à replacer les panneaux de verre (A et B) dans le bon ordre. Cherchez le symbole / l'impression se trouvant sur le côté du panneau de verre. Tous les panneaux ont un symbole différent pour faciliter le démontage et le montage.

Lorsque le cadre de la porte est installé correctement, il émet un clic.

Veillez à installer correctement le panneau de verre central dans son logement.

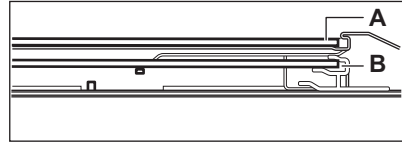
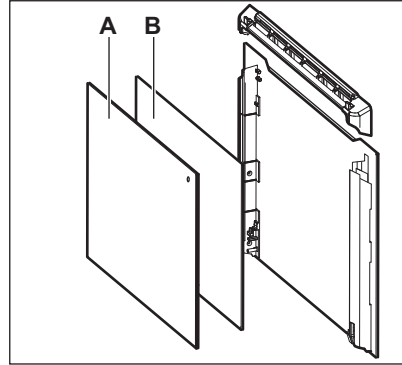

12.6 Comment remplacer : Éclairage



AVERTISSEMENT!

Risque d'électrocution.

L'éclairage peut être chaud.

Tenez toujours l'ampoule halogène avec un chiffon afin d'éviter que des résidus de graisse ne brûlent sur l'ampoule.

Avant de remplacer l'éclairage :

Étape 1	Étape 2	Étape 3
Éteignez le four. Attendez que le four ait refroidi.	Débranchez le four de l'alimentation secteur.	Placez un chiffon au fond de la cavité.

Lampe arrière

Étape 1	Tournez le diffuseur en verre pour le retirer.
Étape 2	Nettoyez le diffuseur en verre.
Étape 3	Remplacez l'ampoule par une ampoule adéquate résistant à une température de 300 °C.
Étape 4	Installez le diffuseur en verre.

13. DÉPANNAGE



AVERTISSEMENT!

Reportez-vous aux chapitres concernant la sécurité.

13.1 Que faire si...

Dans tous les cas ne figurant pas dans ce tableau, veuillez contacter un service après-vente agréé.

Le four ne s'allume pas ou ne chauffe pas	
Problème	Vérifiez si...
Vous ne pouvez pas activer la table de cuisson ni la faire fonctionner.	Le four est correctement branché à l'alimentation électrique.
Le four ne chauffe pas.	L'arrêt automatique est désactivé.
Le four ne chauffe pas.	La porte du four est fermée.
Le four ne chauffe pas.	Le fusible n'a pas disjoncté.
Le four ne chauffe pas.	La Sécurité enfants est désactivée.

Composants	
Problème	Vérifiez si...
L'éclairage est éteint.	La Circulation d'air humide est activée.
L'éclairage ne fonctionne pas.	L'ampoule est grillée.

Codes d'erreur	
L'affichage indique...	Vérifiez si...
Err C3	La porte du four est fermée ou le verrouillage de la porte n'est pas cassé.
Err F102	La porte du four est fermée.
Err F102	Le verrouillage de la porte n'est pas cassé.

Codes d'erreur	
00:00	Une coupure de courant s'est produite. Réglez l'heure actuelle.
Si l'affichage indique un code d'erreur qui ne figure pas dans ce tableau, désactivez et réenclenchez le fusible de l'habitation pour redémarrer le four. Si le code d'erreur réapparaît, contactez un service après-vente agréé.	

13.2 Données de maintenance

Si vous ne trouvez pas de solution au problème, veuillez contacter votre revendeur ou un service après-vente agréé.

Les informations nécessaires au service après-vente figurent sur la plaque signalétique. La plaque signalétique se trouve sur le cadre avant de la cavité du four. Ne retirez pas la plaque signalétique de la cavité du four.

Nous vous recommandons d'écrire les informations ici :	
Modèle (Mod.)
Référence produit (PNC)
Numéro de série (S.N.)

14. RENDEMENT ÉNERGÉTIQUE

14.1 Informations produit et fiche d'informations produit*

Nom du fournisseur	Electrolux
Identification du modèle	EOF4P46X 949498237 EOF6P46X 949498239
Indice d'efficacité énergétique	81.2
Classe d'efficacité énergétique	A+
Consommation d'énergie avec charge standard, en mode conventionnel	0.93 kWh/cycle
Consommation d'énergie avec charge standard, en mode chaleur tournante	0.69 kWh/cycle

RENDEMENT ÉNERGÉTIQUE

Nombre de cavités	1	
Source de chaleur	Électricité	
Volume	72 l	
Type de four	Four encastrable	
Masse	EOF4P46X	29.5 kg
	EOF6P46X	31.6 kg

* Pour l'Union européenne conformément aux Règlements UE 65/2014 et 66/2014.
Pour la République de Biélorussie conformément à STB 2478-2017, Annexe G ; STB 2477-2017, Annexes A et B.
Pour l'Ukraine conformément à 568/32020.

La classe d'efficacité énergétique n'est pas applicable pour la Russie.

EN 60350-1 - Appareils de cuisson domestiques électriques - Partie 1 : Cuisinières, fours, fours à vapeur et grils : Méthodes de mesure des performances.

14.2 Économie d'énergie



Ce four est doté de caractéristiques qui vous permettent d'économiser de l'énergie lors de votre cuisine au quotidien.

Lorsque le four est en marche, assurez-vous que la porte est bien fermée. Évitez d'ouvrir la porte trop souvent pendant la cuisson. Nettoyez régulièrement le joint de porte et assurez-vous qu'il est bien en place.

Utilisez des plats en métal pour accroître les économies d'énergie.

Dans la mesure du possible, ne préchauffez pas le four avant la cuisson.

Lorsque vous préparez plusieurs plats à la fois, faites en sorte que les pauses entre les cuissons soient aussi courtes que possible.

Cuisson avec ventilation

Si possible, utilisez les fonctions de cuisson avec la ventilation pour économiser de l'énergie.

Chaleur résiduelle

L'éclairage et le ventilateur continuent de fonctionner. Lorsque vous éteignez le four, l'affichage montre la chaleur résiduelle. Vous pouvez utiliser cette chaleur pour le maintien au chaud des aliments.

Si la cuisson doit durer plus de 30 minutes, réduisez la température du four au minimum 3 à 10 minutes avant la fin de la cuisson. La chaleur résiduelle à l'intérieur du four poursuivra la cuisson.

Utilisez la chaleur résiduelle pour réchauffer d'autres plats.

Maintien des aliments au chaud

Sélectionnez la température la plus basse possible pour utiliser la chaleur résiduelle et maintenir le repas au chaud. La température ou le voyant de chaleur résiduelle s'affichent.

Cuisson avec l'éclairage éteint

Éteignez l'éclairage en cours de cuisson. Ne l'allumez que lorsque vous en avez besoin.



Circulation d'air humide

Fonction conçue pour économiser de l'énergie en cours de cuisson.



Lorsque vous utilisez cette fonction, l'éclairage s'éteint automatiquement au bout de 30 secondes. Vous pouvez rallumer l'éclairage, mais cela réduira les économies d'énergie.







15. STRUCTURE DES MENUS

15.1 Menu

	 - sélectionnez pour accéder au Menu .
---	---

Structure du Menu

Cuisson assistée 	Nettoyage 	Configurations 
--	---	--

Étape 1	Étape 2	Étape 3	Étape 4	Étape 5
 	 OK	 O1 -O11	 OK	
Sélectionnez le Menu , Configurations.	Confirmez la configuration.	Sélectionnez la configuration.	Confirmez la configuration.	Ajustez la valeur et appuyez sur OK.



Configurations

O1	Heure actuelle	Modifier	O2	Affichage Luminosité	1 - 5
O3	Son touches	1 - Bip 2 - Clic 3 - Son dés-activé	O4	Volume alarme	1 - 4
O5	Compteur	Marche / Arrêt	O6	Eclairage four	Marche / Arrêt
O7	Préchauffage rapide	Marche / Arrêt	O8	Nettoyage conseillé	Marche / Arrêt

STRUCTURE DES MENUS

Configurations					
O9	Mode démo	Code d'activation : 2468	O10	Version du logiciel	Contrôle
O11	Réinitialiser tous les réglages	Oui/Non			

16. EN MATIÈRE DE PROTECTION DE L'ENVIRONNEMENT

Recyclez les matériaux portant le symbole . Déposez les emballages dans les conteneurs prévus à cet effet. Contribuez à la protection de l'environnement et à votre sécurité, recyclez vos produits électriques et électroniques. Ne jetez pas les appareils portant le symbole  avec les ordures ménagères. Emmenez un tel produit dans votre centre local de recyclage ou contactez vos services municipaux.

FR Concerne la France uniquement :



Points de collecte sur www.quefairedemesdechets.fr
Privilégiez la réparation ou le don de votre appareil !

WIR DENKEN AN SIE

Vielen Dank für Ihren Kauf eines Electrolux-Geräts. Sie haben ein Produkt gewählt, das jahrzehntelange professionelle Erfahrung und Innovation mit sich bringt. Das ausgeklügelte und stilvolle Produkt wurde für Sie entwickelt. So können Sie jedes Mal, wenn Sie das Produkt verwenden, sicher sein, dass Sie großartige Ergebnisse erzielen werden. Willkommen bei Electrolux.

Besuchen Sie uns auf unserer Website, um:



Anwendungshinweise, Prospekte, Informationen zu Fehlerbehebung, Service und Reparatur zu erhalten:

www.electrolux.com/support



Registrieren Sie Ihr Produkt, um einen erstklassigen Service zu erhalten:

www.registerelectrolux.com



Um Zubehör, Verbrauchsmaterial und Original-Ersatzteile für Ihr Gerät zu kaufen:

www.electrolux.com/shop



Für weitere Rezepte, Tipps und Fehlerbehebung laden Sie die App **My Electrolux Kitchen** herunter.





KUNDENDIENST UND SERVICE

Verwenden Sie immer Original-Ersatzteile.

Halten Sie folgende Angaben bereit, wenn Sie sich an einen autorisierten Kundendienst wenden: Modell, PNC, Seriennummer.

Die Daten finden Sie auf dem Typenschild.

-  Warnungs-/Sicherheitshinweise
-  Allgemeine Informationen und Empfehlungen
-  Informationen zum Umweltschutz

Änderungen vorbehalten.

INHALTSVERZEICHNIS

1. SICHERHEITSHINWEISE.....	78	2.6 Innenbeleuchtung.....	84
1.1 Sicherheit von Kindern und schutzbedürftigen Personen.....	78	2.7 Wartung.....	85
1.2 Allgemeine Sicherheit.....	79	2.8 Entsorgung.....	85
2. SICHERHEITSANWEISUNGEN.....	80	3. MONTAGE.....	85
2.1 Montage.....	80	3.1 Montage.....	85
2.2 Elektrischer Anschluss.....	81	3.2 Befestigung des Ofens am Möbel.....	86
2.3 Gebrauch.....	82	4. GERÄTEBESCHREIBUNG.....	87
2.4 Reinigung und Pflege.....	83	4.1 Gesamtansicht.....	87
2.5 Pyrolysereinigung.....	84	4.2 Zubehör.....	87

5. EIN- UND AUSSCHALTEN DES BACKOFENS.....	87	11.2 Feuchte Umluft - Empfohlenes Zubehör.....	103
5.1 Versenkbare Knöpfe.....	87	11.3 Gartabellen für Prüfinstitute.....	103
5.2 Bedienfeld.....	88	12. REINIGUNG UND PFLEGE.....	105
6. VOR DER ERSTEN VERWENDUNG.....	89	12.1 Hinweise zur Reinigung.....	105
6.1 Erste Reinigung.....	89	12.2 Entfernen: Einhängegitter	106
6.2 Erstes Vorheizen.....	89	12.3 Benutzung: Pyrolytische Reinigung.....	106
7. TÄGLICHER GEBRAUCH.....	89	12.4 Erinnerungsfunktion Reinigen....	108
7.1 Einstellung: Ofenfunktionen.....	90	12.5 Aus- und Einbau: Tür.....	108
7.2 Ofenfunktionen.....	90	12.6 Austausch: Lampe.....	110
7.3 Hinweise zu: Feuchte Umluft.....	91	13. FEHLERSUCHE.....	110
7.4 Einstellung: Koch-Assistent.....	91	13.1 Was zu tun ist, wenn	110
7.5 Koch-Assistent.....	92	13.2 Servicedaten.....	111
8. UHRFUNKTIONEN.....	97	14. ENERGIEEFFIZIENZ.....	112
8.1 Uhrfunktionen.....	97	14.1 Produktinformationen und Produktinformationsblatt*.....	112
8.2 Einstellung: Uhrfunktionen.....	97	14.2 Energiesparen.....	113
9. VERWENDUNG: ZUBEHÖR.....	99	15. MENÜSTRUKTUR.....	113
9.1 Einsetzen des Zubehörs.....	99	15.1 Menü.....	113
10. ZUSATZFUNKTIONEN.....	100	16. UMWELTTIPPS.....	114
10.1 Verriegelung.....	100		
10.2 Automatische Abschaltung.....	100		
10.3 Kühlgebläse.....	101		
11. TIPPS UND HINWEISE.....	101		
11.1 Feuchte Umluft.....	101		

1. ⚠ SICHERHEITSHINWEISE

Lesen Sie vor der Montage und dem Gebrauch des Geräts zuerst die Bedienungsanleitung. Bei Verletzungen oder Schäden infolge nicht ordnungsgemäßer Montage oder Verwendung übernimmt der Hersteller keine Haftung. Bewahren Sie die Anleitung zum Nachschlagen an einem sicheren und zugänglichen Ort auf.

1.1 Sicherheit von Kindern und schutzbedürftigen Personen

- Das Gerät kann von Kindern ab 8 Jahren und Personen mit eingeschränkten physischen, sensorischen oder geistigen Fähigkeiten oder mit mangelnder Erfahrung/mangelndem

Wissen benutzt werden, wenn sie durch eine für ihre Sicherheit zuständige Person beaufsichtigt werden oder von dieser Person Anweisungen erhalten haben, wie das Gerät sicher zu bedienen ist und welche Gefahren bei nicht ordnungsgemäßer Bedienung bestehen. Kinder unter 8 Jahren und Personen mit schweren Behinderungen oder Mehrfachbehinderung sollten vom Gerät ferngehalten werden, wenn sie nicht ständig beaufsichtigt werden.

- Kinder sollten beaufsichtigt werden, um sicherzustellen, dass sie nicht mit dem Gerät.
- Halten Sie sämtliches Verpackungsmaterial von Kindern fern und entsorgen Sie es ordnungsgemäß.
- **WARNUNG:** Das Gerät und die zugänglichen Geräteteile werden während des Betriebs heiß. Halten Sie Kinder und Haustiere von dem Gerät fern, wenn es in Betrieb oder in der Abkühlphase ist.
- Falls Ihr Gerät mit einer Kindersicherung ausgestattet ist, empfehlen wir, diese einzuschalten.
- Kinder dürfen keine Reinigung und Wartung des Geräts ohne Beaufsichtigung durchführen.

1.2 Allgemeine Sicherheit

- Dieses Gerät ist nur zum Kochen bestimmt.
- Dieses Gerät ist für den Hausgebrauch in einem Einfamilienhaus in Innenräumen bestimmt.
- Dieses Gerät darf in Büros, Hotelzimmern, Gästezimmern in Pensionen, Bauernhöfen und anderen ähnlichen Unterkünften verwendet werden, wenn diese Nutzung das (durchschnittliche) Nutzungsniveau im Haushalt nicht überschreitet.
- Die Montage des Geräts und der Austausch des Kabels muss von einer Fachkraft vorgenommen werden.
- Verwenden Sie das Gerät nicht, bevor es in den Einbauschrank gesetzt wird.

SICHERHEITSANWEISUNGEN

- Vor Wartungsarbeiten ist das Gerät von der elektrischen Stromversorgung zu trennen.
- Wenn das Netzkabel beschädigt ist, muss es vom Hersteller, seinem autorisierten Kundenservice oder einer gleichermaßen qualifizierten Person ausgetauscht werden, um Gefahren durch elektrischen Strom zu vermeiden.
- **WARNUNG:** Vergewissern Sie sich, dass das Gerät ausgeschaltet ist, bevor Sie die Lampe austauschen, um einen Stromschlag zu vermeiden.
- **WARNUNG:** Das Gerät und die zugänglichen Geräteteile werden während des Betriebs heiß. Seien Sie vorsichtig und berühren Sie niemals die Heizelemente.
- Verwenden Sie stets Topfhandschuhe, um Zubehör oder Geschirr zu herauszunehmen oder zu verstauen.
- Ziehen Sie die Einhängegitter zuerst vorne und dann hinten von den Seitenwänden weg. Setzen Sie die Einhängegitter in umgekehrter Reihenfolge ein.
- Reinigen Sie das Gerät nicht mit einem Dampfstrahlreiniger.
- Benutzen Sie zum Reinigen der Glastür keine scharfen Scheuermittel oder Metallschwämmchen; sie könnten die Glasfläche verkratzen und zum Zersplittern der Scheibe führen.
- Entfernen Sie vor der pyrolytischen Reinigung alle Zubehörteile und übermäßige Ansammlungen/ Ablagerungen aus dem Garraum.

2. SICHERHEITSANWEISUNGEN

2.1 Montage

**WARNUNG!**

Die Montage des Geräts darf nur von einer qualifizierten Fachkraft durchgeführt werden.

- Entfernen Sie das gesamte Verpackungsmaterial.
- Montieren Sie ein beschädigtes Gerät nicht und benutzen Sie es nicht.
- Halten Sie sich an die mitgelieferte Montageanleitung.
- Seien Sie beim Umsetzen des Gerätes vorsichtig, da es sehr schwer ist. Tragen Sie stets Sicherheitshandschuhe und festes Schuhwerk.

- Ziehen Sie das Gerät nicht am Griff.
- Montieren Sie das Gerät an einem sicheren und geeigneten Ort, der den Montageanforderungen entspricht.
- Die Mindestabstände zu anderen Geräten und Küchenmöbeln sind einzuhalten.
- Überprüfen Sie vor der Montage des Gerätes, ob sich die Ofentür ohne Kraftanwendung öffnen lässt.
- Das Gerät ist mit einem elektrischen Kühlsystem ausgestattet. Es muss mit der elektrischen Stromversorgung betrieben werden.

Mindesthöhe des Einbaumöbels (Mindesthöhe des Schanks unter der Arbeitsplatte)	580 (600) mm
Schrankbreite	560 mm
Schranktiefe	550 (550) mm
Höhe der Gerätevorderseite	589 mm
Höhe der Geräterückseite	571 mm
Breite der Gerätevorderseite	595 mm
Breite der Geräterückseite	559 mm
Gerätetiefe	569 mm
Geräteeinbautiefe	548 mm
Tiefe bei geöffneter Tür	1022 mm
Mindestgröße der Belüftungsöffnung. Öffnung auf der Rückseite unten	560x20 mm
Länge des Netzanschlusskabels. Das Kabel befindet sich in der rechten Ecke auf der Rückseite	1500 mm
Befestigungsschrauben	4x25 mm

2.2 Elektrischer Anschluss



WARNUNG!

Brand- und Stromschlaggefahr.

- Alle elektrischen Anschlüsse sind von einem geprüften Elektriker vorzunehmen.
- Das Gerät muss geerdet sein.
- Stellen Sie sicher, dass die Daten auf dem Typenschild mit den elektrischen Nennwerten der Netzspannung übereinstimmen.

SICHERHEITSANWEISUNGEN

- Schließen Sie das Gerät nur an eine ordnungsgemäß installierte Schutzkontaktsteckdose an.
- Verwenden Sie keine Mehrfachsteckdosen oder Verlängerungskabel.
- Achten Sie darauf, Netzstecker und Netzkabel nicht zu beschädigen. Falls das Netzkabel des Geräts ersetzt werden muss, lassen Sie diese Arbeit durch unseren autorisierten Kundendienst durchführen.
- Achten Sie darauf, dass das Netzkabel die Gerätetür oder die Nische unter dem Gerät nicht berührt oder in ihre Nähe gelangt, insbesondere wenn das Gerät eingeschaltet oder die Tür heiß ist.
- Alle Teile, die gegen direktes Berühren schützen, sowie die isolierten Teile müssen so befestigt werden, dass sie nicht ohne Werkzeug entfernt werden können.
- Stecken Sie den Netzstecker erst nach Abschluss der Montage in die Steckdose. Stellen Sie sicher, dass der Netzstecker nach der Montage noch zugänglich ist.
- Falls die Steckdose lose ist, schließen Sie den Netzstecker nicht an.
- Ziehen Sie nicht am Netzkabel, wenn Sie das Gerät von der Stromversorgung trennen möchten. Ziehen Sie stets am Netzstecker.
- Verwenden Sie nur geeignete Trenneinrichtungen: Überlastschalter, Sicherungen (Schraubsicherungen müssen aus dem Halter entfernt werden können), Fehlerstromschutzschalter und Schütze.
- Die elektrische Installation muss eine Trenneinrichtung aufweisen, mit der Sie das Gerät allpolig von der Stromversorgung trennen können. Die Trenneinrichtung muss mit einer Kontaktöffnungsbreite von mindestens 3 mm ausgeführt sein.
- Schließen Sie die Gerätetür ganz, bevor Sie den Netzstecker in die Steckdose stecken.
- Das Gerät wird mit einem Netzstecker und Netzkabel geliefert.

Einsetzbare Kabeltypen für Einbau oder Austausch in Europa:

H07 RN-F, H05 RN-F, H05 RRF, H05 VV-F, H05 V2V2-F (T90), H05 BB-F

Für den Kabelabschnitt siehe die Gesamtleistung auf dem Typenschild. Sie können auch die Tabelle heranziehen:

Gesamtleistung (W)	Kabelquerschnitt (mm ²)
maximal 1380	3 x 0.75
maximal 2300	3 x 1
maximal 3680	3 x 1.5

Das Erdkabel (grün/gelb) muss 2 cm länger sein als die Phasen- und Nullleiter (blaue und braune Kabel).

2.3 Gebrauch



WARNUNG!

Verletzungs-, Verbrennungs-, Stromschlag- oder Explosionsgefahr.

- Nehmen Sie keine technischen Änderungen am Gerät vor.

- Vergewissern Sie sich, dass die Lüftungsöffnungen nicht blockiert sind.
- Lassen Sie das Gerät während des Betriebs nicht unbeaufsichtigt.
- Schalten Sie das Gerät nach jedem Gebrauch aus.
- Gehen Sie beim Öffnen der Tür vorsichtig vor, wenn das Gerät in Betrieb ist. Es kann heiße Luft freigesetzt werden.
- Benutzen Sie das Gerät nicht mit nassen Händen oder wenn es mit Wasser Kontakt hat.
- Üben Sie keinen Druck auf die offene Tür aus.
- Verwenden Sie das Gerät nicht als Arbeits- oder Abstellfläche.
- Öffnen Sie die Gerätetür vorsichtig. Die Verwendung von Zutaten mit Alkohol kann eine Mischung aus Alkohol und Luft verursachen.
- Lassen Sie beim Öffnen der Tür keine Funken oder offenen Flammen mit dem Gerät in Kontakt kommen.
- Platzieren Sie keine entflammaren Produkte oder Gegenstände, die mit entflammaren Produkten benetzt sind, im Gerät, auf dem Gerät oder in der Nähe des Geräts.



WARNUNG!

Risiko von Schäden am Gerät.

- Um Beschädigungen und Verfärbungen der Emailbeschichtung zu vermeiden:
 - Stellen Sie feuerfestes Geschirr oder andere Gegenstände nicht direkt auf den Boden des Geräts.
 - Legen Sie keine Alufolie direkt auf den Boden des Garraums.
 - Füllen Sie kein Wasser in das heiße Gerät.
 - Lassen Sie nach Abschluss des Garvorgangs kein feuchtes Geschirr oder feuchte Speisen im Gerät stehen.
 - Gehen Sie beim Herausnehmen oder Einsetzen des Zubehörs sorgfältig vor.
- Verfärbungen der Emaille- oder Edelstahlbeschichtung haben keine Auswirkung auf die Leistung des Geräts.
- Verwenden Sie eine tiefe Pfanne für feuchte Kuchen. Fruchtsäfte verursachen Flecken, die dauerhaft sein können.
- Kochen Sie immer bei geschlossener Gerätetür.
- Ist das Gerät hinter einer Möbelfront (wie etwa einer Tür) installiert, achten Sie darauf, dass die Tür während des Gerätebetriebs nicht geschlossen wird. Hinter einer geschlossenen Möbelfront können sich Hitze und Feuchtigkeit ansammeln und das Gerät, das Gehäuse oder den Boden beschädigen. Schließen Sie die Möbelfront nicht, bevor das Gerät nach dem Gebrauch völlig abgekühlt ist.

2.4 Reinigung und Pflege



WARNUNG!

Verletzungs-, Brandgefahr sowie Risiko von Schäden am Gerät.

- Schalten Sie das Gerät immer aus und ziehen Sie den Netzstecker aus der Steckdose, bevor Reinigungsarbeiten durchgeführt werden.
- Vergewissern Sie sich, dass das Gerät abgekühlt ist. Es besteht die Gefahr, dass die Glasscheiben brechen.
- Ersetzen Sie die Türglasscheiben umgehend, wenn sie beschädigt sind. Wenden Sie sich an einen autorisierten Kundendienst.
- Gehen Sie beim Aushängen der Tür vorsichtig vor. Die Tür ist schwer!
- Reinigen Sie das Gerät regelmäßig, um eine Verschlechterung des Oberflächenmaterials zu verhindern.

SICHERHEITSANWEISUNGEN

- Reinigen Sie das Gerats mit einem weichen, feuchten Tuch. Verwenden Sie ausschlielich Neutralreiniger. Benutzen Sie keine Scheuermittel, scheuernde Reinigungsschwammchen, Losungsmittel oder Metallgegenstande.
- Falls Sie ein Backofenspray verwenden, befolgen Sie die Sicherheitsanweisungen auf seiner Verpackung.

2.5 Pyrolysereinigung



WARNUNG!

Im Pyrolyse-Modus besteht Verletzungs- und Brandgefahr und es konnen chemische Emissionen (Dampfe) austreten.

- Entfernen Sie vor der pyrolytischen Selbstreinigung und vor der Erstinbetriebnahme Folgendes aus dem Ofeninnenraum:
 - Alle groeren Lebensmittelruckstande, Ol- und Fettablagerungen.
 - Alle zum Gerat dazugehorigen herausnehmbaren Teile (Bleche, Einhangegitter) sowie Topfe, Pfannen, Bleche und Utensilien mit Antihaftbeschichtung usw.
- Lesen Sie die Anleitung zur Pyrolyse sorgfaltig durch.
- Halten Sie Kinder wahrend der Pyrolyse vom Gerat fern.
Das Gerat wird sehr hei, und aus den vorderen Kuhlungsoffnungen tritt heie Luft aus.
- Die pyrolytische Reinigung erfolgt bei sehr hoher Temperatur und kann Dampfe von Lebensmittelruckstanden und Geratematerialien freisetzen. Beachten Sie unbedingt Folgendes:
 - Sorgen Sie wahrend und nach der Pyrolyse fur eine gute Beluftung.
 - Sorgen Sie wahrend und nach dem ersten Gebrauch mit der Hochsttemperatur fur eine gute Beluftung.
- Einige Vogel und Reptilien konnen im Gegensatz zu den Menschen sehr empfindlich auf die wahrend des Reinigungsvorgangs freigesetzten Dampfe von Pyrolyse-Backofen reagieren.
 - Bringen Sie Tiere (besonders Vogel) fur die Zeit wahrend und nach der Pyrolyse und nach der ersten Anwendung der Hochsttemperatur in einen gut belufteten Bereich.
- Kleine Tiere reagieren auch wahrend des laufenden Reinigungsprogramms empfindlich auf die lokalen Temperaturschwankungen in der Nahe von Pyrolyse-Backofen.
- Antihaftbeschichtungen auf Topfen, Pfannen, Blechen und Kochutensilien usw. konnen durch die hohen Temperaturen wahrend der pyrolytischen Reinigung beschadigt werden und geringfugige Mengen an gesundheitsschadlichen Dampfen freisetzen.
- Die von den Pyrolyse-Backofen/Speiseresten freigesetzten Dampfe sind ungefahrlich fur Menschen, einschlielich Kinder und Personen mit Gesundheitsbeschwerden.

2.6 Innenbeleuchtung



WARNUNG!

Stromschlaggefahr.

- Bezuglich der Lampe(n) in diesem Gerat und separat verkaufter Ersatzlampen: Diese Lampen mussen extremen physikalischen Bedingungen in Haushaltsgeraten standhalten, wie z.B. Temperatur, Vibration, Feuchtigkeit, oder sollen Informationen uber den Betriebszustand des Gerates anzeigen. Sie sind nicht fur den Einsatz in anderen Geraten vorgesehen und nicht fur die Raumbeleuchtung geeignet.
- Dieses Produkt enthalt eine Lichtquelle der Energieeffizienzklasse G.
- Verwenden Sie nur Lampen mit der gleichen Leistung .

2.7 Wartung

- Wenden Sie sich zur Reparatur des Geräts an den autorisierten Kundendienst.
- Dabei dürfen ausschließlich Originalersatzteile verwendet werden.

2.8 Entsorgung



WARNUNG!

Verletzungs- und Erstickungsgefahr.

- Informationen zur Entsorgung des Geräts erhalten Sie von Ihrer Gemeindeverwaltung.
- Trennen Sie das Gerät von der Stromversorgung.
- Schneiden Sie das Netzkabel in der Nähe des Geräts ab, und entsorgen Sie es.
- Entfernen Sie das Türschloss, um zu verhindern, dass sich Kinder, oder Haustiere im Gerät einschließen.

3. MONTAGE



WARNUNG!

Siehe Kapitel Sicherheitshinweise.

3.1 Montage



YouTube

www.youtube.com/electrolux
www.youtube.com/aeg

How to install your AEG/Electrolux
Oven - Column installation

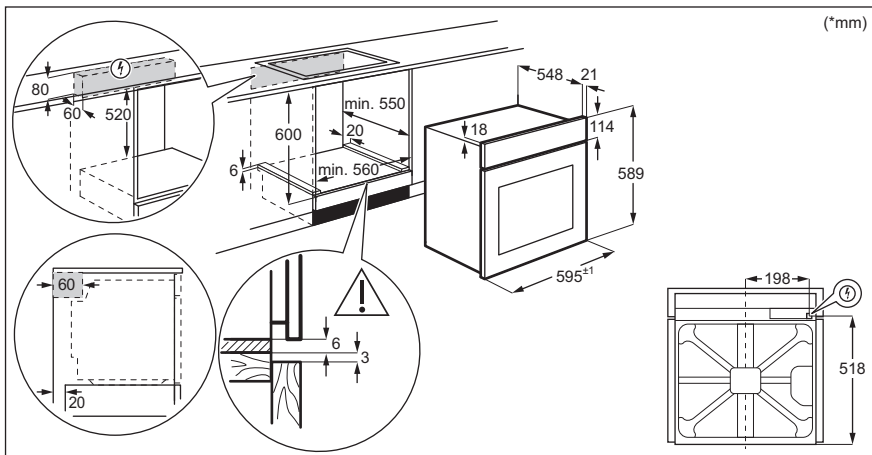

MONTAGE

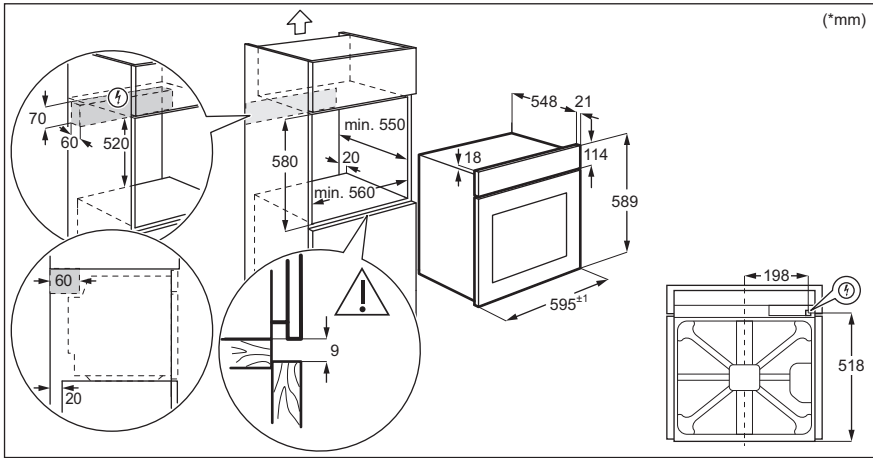

3.2 Befestigung des Ofens am Möbel

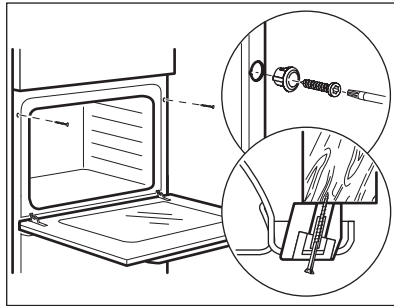

4. GERÄTEBESCHREIBUNG

4.1 Gesamtansicht

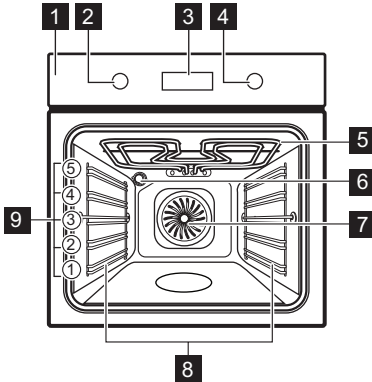

- 1** Bedienfeld
- 2** Einstellknopf für die Ofenfunktionen
- 3** Display
- 4** Einstellknopf
- 5** Heizelement
- 6** Lampe
- 7** Ventilator
- 8** Einschubschienen, herausnehmbar
- 9** Einschubebenen

4.2 Zubehör

- **Kombirost**
Für Kochgeschirr, Kuchenformen, Braten.
- **Backblech**
Für Kuchen und Plätzchen.
- **Brat- und Fettpfanne**
Zum Backen und Braten oder als Pfanne zum Aufsammeln von Fett.

5. EIN- UND AUSSCHALTEN DES BACKOFENS

5.1 Versenkbare Knöpfe

Drücken Sie zum Benutzen des Geräts den Knopf. Der Knopf kommt dann heraus.



EIN- UND AUSSCHALTEN DES BACKOFENS







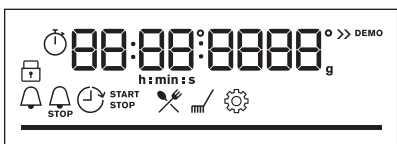

5.2 Bedienfeld

Sensorfelder des Bedienfelds					Drücken Sie	Drehen Sie den Knopf
 Kurzzeit- wecker	 Schnell- aufhei- zung	 Back- ofen- be- leuch- tung	 Verriegelung	OK		

Wählen Sie eine Ofenfunktion, um den Backofen einzuschalten.

Drehen Sie den Knopf für die Ofenfunktionen in die Aus-Position, um den Backofen auszuschalten.

	Wenn sich der Einstellknopf für die Ofenfunktionen in der Aus-Position befindet, schaltet das Display in den Standby-Modus.
	Wenn Sie kochen, zeigt das Display die eingestellte Temperatur, Uhrzeit und andere verfügbare Optionen an.
	Display mit der maximalen Anzahl wählbarer Funktionen.

Display-Anzeigen				
 Verriegelung	 Koch-Assistent	 Reinigung	 Einstellungen	 Schnellaufheizung
Timer-Anzeigen:				

VOR DER ERSTEN VERWENDUNG

Fortschrittsbalken - für Temperatur oder Zeit.



6. VOR DER ERSTEN VERWENDUNG



WARNUNG!

Siehe Kapitel Sicherheitshinweise.

6.1 Erste Reinigung

Reinigen Sie den leeren Backofen vor der ersten Inbetriebnahme und stellen Sie die Uhrzeit ein:



00:00

Stellen Sie die Zeit ein. Drücken Sie

OK.

6.2 Erstes Vorheizen

Heizen Sie den leeren Ofen vor der ersten Inbetriebnahme vor.

Schritt 1

Nehmen Sie die Zubehörteile und die herausnehmbaren Einhängegitter aus dem Ofen.

Schritt 2

Stellen Sie die Höchsttemperatur für folgende Funktion ein: .
Lassen Sie den Ofen 1 Stunde lang eingeschaltet.

Schritt 3

Stellen Sie die Höchsttemperatur für folgende Funktion ein: .
Lassen Sie den Ofen 15 Min. lang eingeschaltet.

 Der Ofen kann während des Vorheizens Geruch und Rauch verströmen. Stellen Sie sicher, dass der Raum belüftet ist.



7. TÄGLICHER GEBRAUCH



WARNUNG!







Siehe Kapitel Sicherheitshinweise.





7.1 Einstellung: Ofenfunktionen

Beginnen Sie mit dem Kochen	
Schritt 1	Schritt 2
	
Stellen Sie eine Backofenfunktion ein.	Stellen Sie die Temperatur ein.

7.2 Ofenfunktionen

Standard-Ofenfunktionen

Ofenfunktion	Gerät
 Heißluft	Zum Backen auf bis zu drei Einschubebenen gleichzeitig und zum Dörren von Lebensmitteln. Stellen Sie eine 20 - 40 °C niedrigere Backofentemperatur als bei Ober-/Unterhitze ein.
 Ober-/Unterhitze	Zum Backen und Braten von Speisen auf einer Einschubebene.
 Tiefkühlgerichte	Lässt Fertiggerichte (z. B. Pommes frites, Kroketten oder Frühlingsrollen) schön knusprig werden.
 Pizzastufe	Zum Backen von Pizza. Für ein intensives Überbacken und einen knusprigen Boden.
 Unterhitze	Zum Backen von Kuchen mit knusprigen Böden und zum Einkochen von Lebensmitteln.
 Auftauen	Zum Auftauen von Lebensmitteln (Gemüse und Obst). Die Auftauzeit hängt von der Menge und Größe der gefrorenen Lebensmittel ab.

Ofenfunktion	Gerät
 Feuchte Umluft	Diese Funktion ist entwickelt worden, um während des Kochvorgangs Energie zu sparen. Wenn Sie diese Funktion nutzen, kann die Temperatur im Garraum von der eingestellten Temperatur abweichen. Es wird die Restwärme genutzt. Die Wärmeleistung kann geringer sein. Weitere Informationen zu folgenden Themen finden Sie im Kapitel „Täglicher Gebrauch“: Feuchte Umluft.
 Grill	Zum Grillen dünner Lebensmittel und zum Toasten von Brot.
 Heißluftgrillen	Zum Braten großer Fleischstücke oder von Geflügel mit Knochen auf einer Ebene. Zum Gratinieren und Überbacken.
 Menü	Aufrufen des Menüs: Koch-Assistent, Reinigung, Einstellungen.

7.3 Hinweise zu: Feuchte Umluft

Diese Funktion wurde zur Bestimmung der Energieeffizienzklasse und den Anforderungen an die umweltgerechte Gestaltung EU 65/2014 und EU 66/2014 verwendet. Tests nach EN 60350-1.

Die Backofentür sollte während des Garvorgangs geschlossen bleiben, damit die Funktion nicht unterbrochen wird. So wird gewährleistet, dass der Backofen mit der höchsten Energieeffizienz arbeitet.

Wenn Sie diese Funktion verwenden, schaltet sich die Backofenbeleuchtung automatisch nach 30 Sekunden aus.

Näheres zum Garen finden Sie im Kapitel „Tipps und Hinweise“, Feuchte Umluft. Allgemeine Empfehlungen zum Energiesparen finden Sie im Kapitel „Energieeffizienz“, Energiesparen.

7.4 Einstellung: Koch-Assistent





Jedes Gericht in diesem Untermenü hat eine empfohlene Funktion und Temperatur. Sie können die Zeit und Temperatur während des Garvorgangs einstellen.

Einige der Speisen können Sie auch mit der folgenden Funktion zubereiten:	<ul style="list-style-type: none"> • Gewichtsautomatik
---	---



Koch-Assistent - Verwenden Sie diese Funktion, um ein Gericht schnell mit den Standardeinstellungen zuzubereiten:			
Schritt 1	Schritt 2	Schritt 3	Schritt 4

TÄGLICHER GEBRAUCH



Koch-Assistent - Verwenden Sie diese Funktion, um ein Gericht schnell mit den Standardeinstellungen zuzubereiten:











			
Öffnen Sie das Menü.	Wählen Koch-Assistent. Drücken Sie OK .	Wählen Sie das Gericht. Drücken Sie OK .	Geben Sie das Gericht in den Backofen. Bestätigen Sie die Einstellung.

7.5 Koch-Assistent













Legende	
	Gewichtsautomatik verfügbar.
	Heizen Sie den Backofen vor, bevor Sie mit dem Kochen beginnen.
	Einschubebene.





















Wenn die Funktion beendet ist, prüfen Sie, ob das Gericht fertig ist.

	Speise	Gewicht	Einschubebene / Zubehör	Dauer
Rindfleisch 🍖				
P1	Roastbeef, blutig	1 - 1,5 kg; 4 - 5 cm dicke Stücke	 2; Backblech Braten Sie das Fleisch einige Minuten in einer heißen Pfanne. Setzen Sie es in den Backofen ein.	40 Min.
P2	Roastbeef, rosa			50 Min.
P3	Roastbeef, durch			60 Min.
P4	Steak, rosa	180 - 220 g pro Stück; 3 cm dicke Scheiben	  3; Bräter auf Kombirost Braten Sie das Fleisch einige Minuten in einer heißen Pfanne. Setzen Sie es in den Backofen ein.	15 Min.













	Speise	Gewicht	Einschubebene / Zubehör	Dauer
P5	Rinderbraten/ geschmort (Prime Rib, obere runde, dicke Flanke)	1,5 - 2 kg	  2; Bräter auf Kombirost Braten Sie das Fleisch einige Minuten in einer heißen Pfanne. Flüssigkeit hinzugeben. Setzen Sie es in den Backofen ein.	120 Min.
P6	Roastbeef, blutig (Niedertemperatur-Garen)	1 - 1,5 kg; 4 - 5 cm dicke Stücke	 2; Backblech Verwenden Sie Ihre Lieblingsgewürze oder einfach Salz und frisch gemahlene Pfeffer. Braten Sie das Fleisch einige Minuten in einer heißen Pfanne. Setzen Sie es in den Backofen ein.	75 Min.
P7	Roastbeef, rosa (Niedertemperatur-Garen)			85 Min.
P8	Roastbeef, durch (Niedertemperatur-Garen)			130 Min.
P9	Filet, blutig (Niedertemperatur-Garen)	0,5 - 1,5 kg; 5 - 6 cm dicke Stücke	 2; Backblech Verwenden Sie Ihre Lieblingsgewürze oder einfach Salz und frisch gemahlene Pfeffer. Braten Sie das Fleisch einige Minuten in einer heißen Pfanne. Setzen Sie es in den Backofen ein.	75 Min.
P10	Filet, rosa (Niedertemperatur-Garen)			90 Min.
P11	Filet, fertig (Niedertemperatur-Garen)			120 Min.
Kalb 				
P12	Kalbsbraten (z. B. Schulter)	0,8 - 1,5 kg; 4 cm dicke Stücke	  2; Bräter auf Kombirost Verwenden Sie Ihre Lieblingsgewürze. Flüssigkeit hinzugeben. Braten zugeeckt.	80 Min.
Schweinefleisch 				
P13	Schweinebraten oder Schulter	1,5 - 2 kg	  2; Bräter auf Kombirost Wenden Sie das Fleisch nach der Hälfte der Gardauer.	120 Min.







TÄGLICHER GEBRAUCH

	Speise	Gewicht	Einschubebene / Zubehör	Dauer
P14	Pulled Pork (Niedertemperatur Garen)	1,5 - 2 kg	 2; Backblech Verwenden Sie Ihre Lieblingsgewürze. Wenden Sie das Fleisch nach der Hälfte der Garzeit, um eine gleichmäßige Bräunung zu erzielen.	215 Min.
P15	Lende, frisch	1 - 1,5 kg; 5 - 6 cm dicke Stücke	 2; Bräter auf Kombirost Verwenden Sie Ihre Lieblingsgewürze.	55 Min.
P16	Rippchen	2 - 3 kg; verwenden Sie rohe, 2 - 3 cm dünne Rippchen	 3; tiefe Pfanne Flüssigkeit hinzufügen, um den Boden eines Gerichts zu bedecken. Wenden Sie das Fleisch nach der Hälfte der Gardauer.	90 Min.
Lamm 				
P17	Lammkeule mit Knochen	1,5 - 2 kg; 7 - 9 cm dicke Stücke	 2; Bräter auf Backblech Flüssigkeit hinzugeben. Wenden Sie das Fleisch nach der Hälfte der Gardauer.	130 Min.
Geflügel 				
P18	Hähnchen, ganz	1 - 1,5 kg; frisch	  2; Auflaufform auf Backblech Verwenden Sie Ihre Lieblingsgewürze. Das Hähnchen nach der Hälfte der Garzeit wenden, um eine gleichmäßige Bräunung zu erzielen.	60 Min.
P19	Halbes Hähnchen	0,5 - 0,8 kg	 3; Backblech Verwenden Sie Ihre Lieblingsgewürze.	40 Min.
P20	Hähnchenbrust	180 - 200 g pro Stück	  2; Auflaufform auf Kombirost Verwenden Sie Ihre Lieblingsgewürze. Braten Sie das Fleisch einige Minuten in einer heißen Pfanne.	25 Min.
P21	Hähnchenschenkel, frisch	-	 3; Backblech Wenn Sie die Hähnchenschenkel zuerst marinieren, stellen Sie die niedrigere Temperatur ein und garen Sie sie länger.	30 Min.

	Speise	Gewicht	Einschubebene / Zubehör	Dauer
P22	Ente, ganz	2 - 3 kg	  2; Bräter auf Kombirost Verwenden Sie Ihre Lieblingsgewürze. Legen Sie das Fleisch in den Bräter. Die Ente nach der Hälfte der Garzeit wenden.	100 Min.
P23	Gans, ganz	4 - 5 kg	  2; tiefe Pfanne Verwenden Sie Ihre Lieblingsgewürze. Legen Sie das Fleisch auf das tiefe Backblech. Die Gans nach der Hälfte der Garzeit wenden.	110 Min.
Sonstige 				
P24	Hackbraten	1 kg	 2; Kombirost Verwenden Sie Ihre Lieblingsgewürze.	60 Min.
Fisch 				
P25	Ganzer Fisch, gegrillt	0,5 - 1 kg pro Fisch	 2; Backblech Fisch mit Butter füllen und Ihre Lieblingsgewürze und Kräuter verwenden.	30 Min.
P26	Fischfilet	-	  3; Auflaufform auf Kombirost Verwenden Sie Ihre Lieblingsgewürze.	20 Min.
Süßes Backen/Desserts   				
P27	Käsekuchen	-	 2;  Springform 28 cm auf Kombirost	90 Min.
P28	Apfelkuchen	-	 3; Backblech	45 Min.
P29	Apfelkuchen	-	 2; Kuchenform auf Kombirost	40 Min.
P30	Apfelkuchen	-	 1;  22 cm Kuchenform auf Kombirost	60 Min.
P31	Brownies	2 kg	 3; tiefe Pfanne	30 Min.





TÄGLICHER GEBRAUCH

	Speise	Gewicht	Einschubebene / Zubehör	Dauer
P32	Schokoladenmuffins	-	 3; Muffin-Blech auf Kombirost	25 Min.
P33	Brotkuchen	-	 2; Brotpfanne auf Kombirost	50 Min.
Gemüse / Beilagen 				
P34	Ofenkartoffeln	1 kg	 2; Backblech Die ganzen Kartoffeln mit der Haut auf das Backblech geben.	50 Min.
P35	Wegdes	1 kg	 3; Backblech mit Backpapier ausgekleidet Verwenden Sie Ihre Lieblingsgewürze. Kartoffeln in Stücke schneiden.	35 Min.
P36	Gegrilltes Gemüse	1 - 1,5 kg	 3; Backblech mit Backpapier ausgekleidet Verwenden Sie Ihre Lieblingsgewürze. Gemüse in Stücke schneiden.	30 Min.
P37	Kroketten, gefroren	0,5 kg	 3; Backblech	25 Min.
P38	Pommes frites, gefroren	0,75 kg	 3; Backblech	25 Min.
Gratins, Brot und Pizza 				
P39	Fleisch-/Gemüselsagne mit trockenen Nudelplatten	1 - 1,5 kg	 2; Auflaufform auf Kombirost	45 Min.
P40	Kartoffelgratin (rohe Kartoffeln)	1 - 1,5 kg	 1; Auflaufform auf Kombirost Drehen Sie das Gericht nach der Hälfte der Garzeit um.	50 Min.
P41	Pizza frisch, dünn	-	  2; Backblech mit Backpapier ausgekleidet	15 Min.

	Speise	Gewicht	Einschubebene / Zubehör	Dauer
P42	Pizza frisch, dick	-	  2; Backblech mit Backpapier ausgekleidet	25 Min.
P43	Quiche	-	 2; Backform auf Kombirost	45 Min.
P44	Baguette/ Ciabatta/ Weißbrot	0,8 kg	  3; Backblech mit Backpapier ausgekleidet Für Weißbrot mehr Zeit nötig.	30 Min.
P45	Alle Getreide/ Roggen/dunkles Brot, alle Getreide in Kastenform	1 kg	  2; Backblech mit Backpapier ausgekleidet / Kombirost	60 Min.

8. UHRFUNKTIONEN



8.1 Uhrfunktionen







Uhrfunktion	Verwendung
	Kurzzeit-Wecker. Nach Ablauf der Zeit ertönt der Signalton.
	Garzeitdauer. Nach Ablauf des Timers ertönt ein akustisches Signal und die Ofenfunktion stoppt.
	Zeitvorwahl. Verzögerung des Starts und/oder Endes des Kochens.
	Uptimer. Max. 23 Std. 59 Min. Diese Funktion wirkt sich nicht auf den Betrieb des Backofens aus. Um den Uptimer ein- oder auszuschalten, wählen Sie: Menü, Einstellungen.







8.2 Einstellung: Uhrfunktionen

Einstellung: Uhrzeit		
Schritt 1	Schritt 2	Schritt 3

UHRFUNKTIONEN

Einstellung: Uhrzeit		
		
Um die Uhrzeit zu ändern, rufen Sie das Menü auf und wählen Sie Einstellungen, Tageszeit.	Stellen Sie die Uhrzeit ein.	Drücken Sie: OK.

Einstellung: Kurzzeit-Wecker			
Schritt 1	Im Display wird Folgendes angezeigt: 0:00 angezeigt. 	Schritt 2	Schritt 3
			
Drücken Sie:  .		Stellen Sie Kurzzeit-Wecker ein.	Drücken Sie: OK.
 Der Countdown des Timers startet umgehend.			

Einstellung: Garzeitdauer				
Schritt 1	Schritt 2	Im Display wird Folgendes angezeigt: 0:00 angezeigt.  <small>STOP</small>	Schritt 3	Schritt 4
				
Wählen Sie eine Ofenfunktion und stellen Sie die Temperatur ein.	Drücken Sie wiederholt:  .		Stellen Sie die Gardauer ein.	Drücken Sie: OK.
 Der Countdown des Timers startet umgehend.				

Einstellung: Zeitvorwahl							
Schritt 1	Schritt 2		Schritt 3	Schritt 4		Schritt 5	Schritt 6
		Das Display zeigt die Uhrzeit an START 			Im Display wird Folgendes angezeigt: --:--  STOPP		
Wählen Sie die Ofenfunktion.	Drücken Sie wiederholt: 		Stellen Sie die Startzeit ein.	Drücken Sie: OK.		Stellen Sie die Endzeit ein.	Drücken Sie: OK.
 Der Countdown des Timers beginnt zu der eingestellten Startzeit.							

9. VERWENDUNG: ZUBEHÖR

9.1 Einsetzen des Zubehörs

Die kleine Einkerbung auf der Oberseite erhöht die Sicherheit. Die Vertiefungen sind auch Kippsicherungen. Durch den umlaufend erhöhten Rand des Rosts ist das Kochgeschirr gegen Abrutschen vom Rost gesichert.

Kombirost:

Schieben Sie den Rost zwischen die Führungsschienen der Einhängegitter mit den Füßen nach unten zeigend.

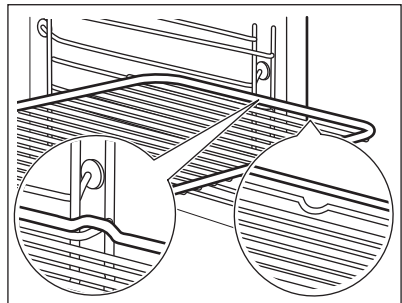



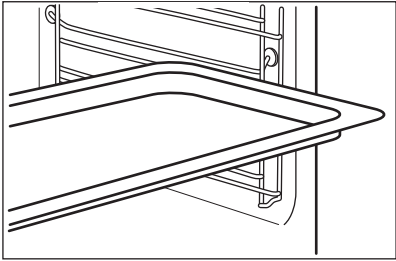
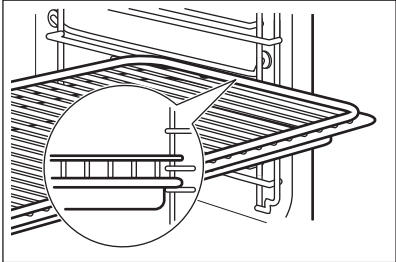



ZUSATZFUNKTIONEN

<p>Backblech / Auflaufpfanne: Schieben Sie das Backblech zwischen die Führungsstäbe der Einhängegitter.</p>	
<p>Kombirost, Backblech / Auflaufpfanne: Schieben Sie das Backblech zwischen die Führungsstäbe der Einhängegitter und dem Kombirost auf die Führungsstäbe darüber.</p>	



10. ZUSATZFUNKTIONEN

10.1 Verriegelung

<p>Diese Funktion verhindert ein versehentliches Verstellen der Ofenfunktion.</p>		
<p>Einschalten, wenn der Backofen in Betrieb ist – das eingestellte Garen wird fortgesetzt und das Bedienfeld ist verriegelt. Einschalten, wenn der Backofen ausgeschaltet ist – der Backofen kann nicht eingeschaltet werden, das Bedienfeld ist verriegelt.</p>		
 	 – gedrückt halten, um die Funktion einzuschalten. Ein Signal ertönt.	 – gedrückt halten, um sie auszuschalten.
<p> 3 x  – blinkt, wenn die Verriegelung eingeschaltet ist.</p>		

10.2 Automatische Abschaltung

Der Backofen wird aus Sicherheitsgründen nach einiger Zeit ausgeschaltet, wenn eine Ofenfunktion eingeschaltet ist und Sie die Einstellungen nicht ändern.

 (°C)	 (Std.)
30 - 115	12.5
120 - 195	8.5
200 - 245	5.5
250 - max.	3

Die Abschaltautomatik funktioniert nicht mit den Funktionen: Backofenbeleuchtung, Zeitvorwahl.





10.3 Kühlgebläse

Wenn der Backofen in Betrieb ist, wird das Kühlgebläse automatisch eingeschaltet, um die Ofenoberflächen zu kühlen. Wenn Sie den Backofen ausschalten kann das Kühlgebläse weiter laufen, bis der Ofen abgekühlt ist.





11. TIPPS UND HINWEISE





11.1 Feuchte Umluft

Beachten Sie für beste Ergebnisse die unten in der Tabelle aufgeführten Empfehlungen.

		 (°C)		 (Min.)
Brötchen, süß, 16 Stück	Backblech oder tiefes Blech	180	2	20 - 30
Brötchen, 9 Stück	Backblech oder tiefes Blech	180	2	30 - 40
Pizza, gefroren, 0,35 kg	Kombirost	220	2	10 - 15
Biskuitrolle	Backblech oder tiefes Blech	170	2	25 - 35
Brownie	Backblech oder tiefes Blech	175	3	25 - 30
Soufflé, 6 Stück	Keramikförmchen auf Kombirost	200	3	25 - 30



TIPPS UND HINWEISE

		 (°C)		 (Min.)
Biskuitboden	Biskuitform auf Kombi- rost	180	2	15 - 25
Englischer Sand- wichkuchen à la Victoria	Backform auf Kombirost	170	2	40 - 50
Fisch, pochiert, 0,3 kg	Backblech oder tiefes Blech	180	3	20 - 25
Fisch, ganz, 0,2 kg	Backblech oder tiefes Blech	180	3	25 - 35
Fischfilet, 0,3 kg	Pizzapfanne auf Kombi- rost	180	3	25 - 30
Fleisch, pochiert, 0,25 kg	Backblech oder tiefes Blech	200	3	35 - 45
Schaschlik, 0,5 kg	Backblech oder tiefes Blech	200	3	25 - 30
Plätzchen, 16 Stück	Backblech oder tiefes Blech	180	2	20 - 30
Makronen, 24 Stück	Backblech oder tiefes Blech	180	2	25 - 35
Muffins, 12 Stück	Backblech oder tiefes Blech	170	2	30 - 40
Kleingebäck, pi- kant, 20 Stück	Backblech oder tiefes Blech	180	2	25 - 30
Mürbeteigplätz- chen, 20 Stück	Backblech oder tiefes Blech	150	2	25 - 35
Törtchen, 8 Stück	Backblech oder tiefes Blech	170	2	20 - 30
Gemüse, po- chiert, 0,4 kg	Backblech oder tiefes Blech	180	3	35 - 45

		 (°C)		 (Min.)
Vegetarisches Omelett	Pizzapfanne auf Kombi-rost	200	3	25 - 30
Mediterranes Gemüse, 0,7 kg	Backblech oder tiefes Blech	180	4	25 - 30

11.2 Feuchte Umluft - Empfohlenes Zubehör

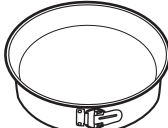





Verwenden Sie die dunklen und nicht reflektierenden Formen und Behälter. Sie haben eine bessere Wärmeabsorption als helle Farbe und reflektierende Schüsseln.

			
Pizzapfanne	Backform	Förmchen	Tortenbodenform
Dunkel, nicht reflektierend 28 cm Durchmesser	Dunkel, nicht reflektierend 26 cm Durchmesser	Keramikform 8 cm Durchmesser, 5 cm Höhe	Dunkel, nicht reflektierend 28 cm Durchmesser







11.3 Gartabellen für Prüfinstitute







Informationen für Prüfinstitute

Tests gemäß IEC 60350-1.

				 (°C)	 (Min.)	
Törtchen, 20 pro Blech	Ober-/ Unterhitze	Backblech	3	170	20 - 30	-
Törtchen, 20 pro Blech	Heißluft	Backblech	3	150 - 160	20 - 35	-

TIPPS UND HINWEISE

				 (°C)	 (Min.)	
Törtchen, 20 pro Blech	Heißluft	Backblech	2 und 4	150 - 160	20 - 35	-
Apfelkuchen, 2 Formen à Ø 20 cm	Ober-/ Unterhitze	Kombirost	2	180	70 - 90	-
Apfelkuchen, 2 Formen à Ø 20 cm	Heißluft	Kombirost	2	160	70 - 90	-
Biskuit, Kuchenform Ø 26 cm	Ober-/ Unterhitze	Kombirost	2	170	40 - 50	Backofen 10 Minuten vorheizen.
Biskuit, Kuchenform Ø 26 cm	Heißluft	Kombirost	2	160	40 - 50	Backofen 10 Minuten vorheizen.
Biskuit, Kuchenform Ø 26 cm	Heißluft	Kombirost	2 und 4	160	40 - 60	Backofen 10 Minuten vorheizen.
Mürbe- teigge- bäck	Heißluft	Backblech	3	140 - 150	20 - 40	-
Mürbe- teigge- bäck	Heißluft	Backblech	2 und 4	140 - 150	25 - 45	-
Mürbe- teigge- bäck	Ober-/ Unterhitze	Backblech	3	140 - 150	25 - 45	-

				 (°C)	 (Min.)	
Toast, 4 - 6 Stück	Grill	Kombirost	4	Max.	2 - 3 Minuten auf der ersten Seite, 2 - 3 Minuten auf der zweiten Seite	Backofen 3 Minuten vorheizen.
Hamburger aus Rindfleisch, 6 Stück, 0,6 kg	Grill	Kombirost und Fettpfanne	4	Max.	20 - 30	Kombirost in die vierte und Fettpfanne in die dritte Einschubebene des Backofens einschieben. Wenden Sie das Gericht nach der Hälfte der Gardauer. Backofen 3 Minuten vorheizen.

12. REINIGUNG UND PFLEGE





WARNUNG!

Siehe Kapitel Sicherheitshinweise.

12.1 Hinweise zur Reinigung

 Reinigungsmittel	Feuchten Sie ein weiches Tuch mit warmem Wasser und etwas mildem Reinigungsmittel an, und reinigen Sie damit die Vorderseite des Backofens.
	Reinigen Sie die Metalloberflächen mit einer Reinigungslösung.
	Reinigen Sie Flecken mit einem milden Reinigungsmittel.

 Täglicher Gebrauch	<p>Reinigen Sie den Garraum nach jedem Gebrauch. Fettansammlungen oder andere Speisereste könnten einen Brand verursachen.</p>
	<p>Es kann sich Feuchtigkeit im Ofen oder an den Glasscheiben der Tür niederschlagen. Um die Kondensation zu reduzieren, schalten Sie den Backofen immer 10 Minuten vor dem Garen ein. Lassen Sie die Speisen nicht länger als 20 Minuten im Backofen stehen. Trocknen Sie den Garraum nach jedem Gebrauch mit einem weichen Tuch ab.</p>

 Zubehör	<p>Reinigen Sie alle Zubehörteile nach jedem Gebrauch und lassen Sie sie trocknen. Feuchten Sie ein weiches Tuch mit warmem Wasser und einem milden Reinigungsmittel an. Reinigen Sie die Zubehörteile nicht im Geschirrpüler.</p>
	<p>Reinigen Sie das Zubehör mit Antihafbeschichtung nicht mit Scheuermitteln oder scharfkantigen Gegenständen.</p>

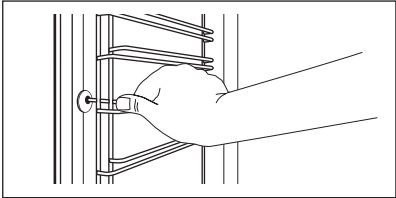
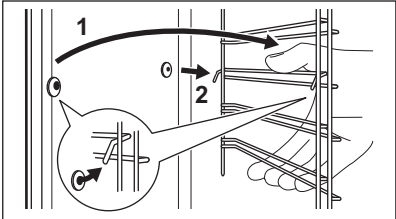

12.2 Entfernen: Einhängegitter

Entfernen Sie Einhängegitter zur Reinigung des Backofens.

<p>Schritt 1</p>	<p>Schalten Sie den Backofen aus und warten Sie, bis er abgekühlt ist.</p>	
<p>Schritt 2</p>	<p>Ziehen Sie das Einhängegitter vorne von der Seitenwand weg.</p>	
<p>Schritt 3</p>	<p>Ziehen Sie das Einhängegitter hinten von der Seitenwand weg und nehmen Sie es heraus.</p>	
<p>Schritt 4</p>	<p>Setzen Sie die Einhängegitter in umgekehrter Reihenfolge ein.</p>	

12.3 Benutzung: Pyrolytische Reinigung



Reinigen Sie den Backofen mit Pyrolytische Reinigung.

	<p>WARNUNG! Es besteht das Risiko von Verbrennungen.</p>
	<p>VORSICHT! Befinden sich weitere Geräte in demselben Küchenmöbel, verwenden Sie diese nicht während dieser Funktion. Andernfalls kann der Backofen beschädigt werden.</p>

Vor dem Pyrolytische Reinigung:

Schalten Sie den Backofen aus und warten Sie, bis er abgekühlt ist.	Entfernen Sie alle Zubehörteile aus dem Backofen.	Reinigen Sie den Backofenboden und die innere Türglasscheibe mit warmem Wasser, einem weichen Tuch und einem milden Reinigungsmittel.
---	---	---

Pyrolytische Reinigung

Schritt 1	Menü eingeben: Reinigung $m /$.	
	Option	Dauer
	C1 - Leichte Reinigung	1 Std.
	C2 - Normale Reinigung	1 Std. 30 Min.
	C3 - Gründliche Reinigung	2 Std. 30 Min.
Schritt 2	OK - drücken, um das Reinigungsprogramm auszuwählen.	
Schritt 3	OK - Drücken, um die Reinigung zu starten.	
Schritt 4	Drehen Sie nach der Reinigung den Knopf für die Backofenfunktionen in die Aus-Position.	
<p> Während der Reinigung ist die Backofenlampe ausgeschaltet.</p> <p>Sobald der Backofen die eingestellte Temperatur erreicht hat, wird die Tür verriegelt. Bis die Tür entriegelt wird, zeigt das Display Folgendes an: .</p>		

Nach Abschluss der Reinigung:

Schalten Sie den Backofen aus und warten Sie, bis er abgekühlt ist.	Reinigen Sie den Garraum mit einem weichen Tuch.	Entfernen Sie die Rückstände vom Garraumboden.
---	--	--



12.4 Erinnerungsfunktion Reinigen

Der Backofen erinnert Sie daran, wann er mit der pyrolytischen Reinigung gereinigt werden muss.	
 blinkt 5 Sekunden nach jedem Kochvorgang im Display.	Zum Ausschalten der Erinnerung geben Sie die Menü ein und wählen Sie Einstellungen, Erinnerungsfunktion Reinigen.

12.5 Aus- und Einbau: Tür

Die Backofentür hat drei Glasscheiben. Sie können die Backofentür und die internen Glasscheiben entfernen, um sie zu reinigen. Lesen Sie die gesamte Anleitung „Aus- und Einbauen der Tür“, bevor Sie die Glasscheiben entfernen.

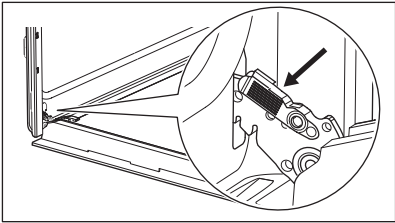
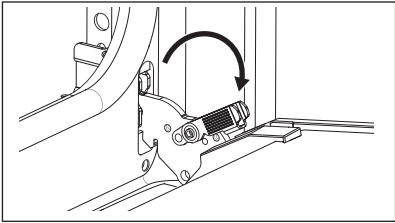
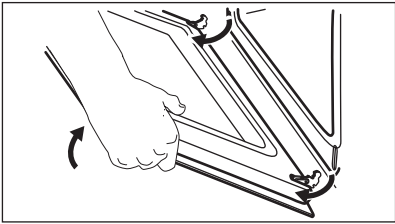
	VORSICHT! Verwenden Sie den Backofen nicht ohne die Glasscheiben.
--	---

Schritt 1	Öffnen Sie die Backofentür vollständig und halten Sie beide Scharniere fest.	
Schritt 2	Heben und ziehen Sie die Verriegelungen an, bis sie einrasten.	
Schritt 3	Schließen Sie die Backofentür halb bis zur ersten Öffnungsstellung. Anschließend heben und ziehen Sie die Tür aus der Aufnahme heraus.	
Schritt 4	Legen Sie die Tür auf einer stabilen Oberfläche auf ein weiches Tuch.	

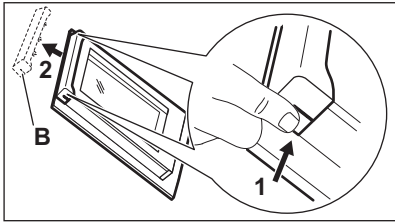
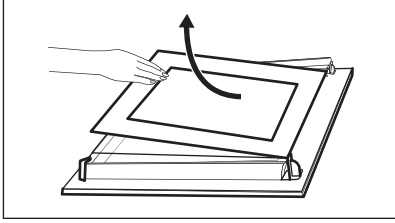
<p>Schritt 5</p>	<p>Fassen Sie die Türabdeckung (B) an der Oberkante der Tür an beiden Seiten an. Drücken Sie sie nach innen, um den Klippverschluss zu lösen.</p>	
<p>Schritt 6</p>	<p>Ziehen Sie die Türabdeckung nach vorn, um sie abzunehmen.</p>	
<p>Schritt 7</p>	<p>Halten Sie die Glasscheiben der Tür an der Oberkante fest und ziehen Sie sie vorsichtig einzeln heraus. Beginnen Sie mit der oberen Glasscheibe. Achten Sie darauf, dass die Glasscheiben vollständig aus den Halterungen gezogen werden.</p>	
<p>Schritt 8</p>	<p>Reinigen Sie die Glasscheiben mit Wasser und Spülmittel. Trocknen Sie die Glasscheiben sorgfältig. Reinigen Sie die Glasscheiben nicht im Geschirrspüler.</p>	
<p>Schritt 9</p>	<p>Setzen Sie nach der Reinigung die Glasscheiben und die Backofentür ein.</p>	
<p>Wenn die Tür korrekt installiert ist, hören Sie beim Schließen der Verriegelungen ein Klicken.</p>		

Achten Sie beim Wiedereinsetzen der Glasscheiben (A und B) auf die richtige Reihenfolge. Überprüfen Sie das Symbol/den Aufdruck auf der Seite der Glasscheibe. Jede Glasscheibe sieht anders aus, um den Aus- und Einbau zu erleichtern. Bei korrektem Einbau macht die Türabdeckung ein Klickgeräusch. Stellen Sie sicher, dass Sie die mittlere Glassplatte korrekt in der Aufnahme installieren.

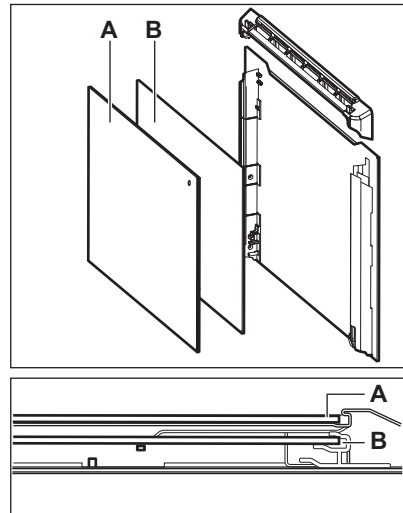

FEHLERSUCHE

12.6 Austausch: Lampe

**WARNUNG!**

Stromschlaggefahr.
Die Lampe kann heiß sein.

Halten Sie die Halogenlampe stets mit einem Tuch, um zu verhindern, dass Fettrückstände auf der Lampe einbrennen.

Bevor Sie die Lampe austauschen:

Schritt 1	Schritt 2	Schritt 3
Schalten Sie den Backofen aus. Warten Sie, bis der Ofen kalt ist.	Trennen Sie den Ofen von der Netzversorgung.	Breiten Sie ein Tuch auf dem Garraumboden aus.

Hintere Lampe

Schritt 1	Drehen Sie die Glasabdeckung und nehmen Sie sie ab.
Schritt 2	Reinigen Sie die Glasabdeckung.
Schritt 3	Ersetzen Sie die Lampe durch eine geeignete, bis 300 °C hitzebeständige Lampe.
Schritt 4	Bringen Sie die Glasabdeckung an.

13. FEHLERSUCHE

**WARNUNG!**

Siehe Kapitel Sicherheitshinweise.

13.1 Was zu tun ist, wenn ...

In allen Fällen, die nicht in dieser Tabelle aufgeführt sind, wenden Sie sich bitte an einen autorisierten Kundendienst.

Der Backofen schaltet sich nicht ein oder heizt nicht auf

Störung	Prüfen Sie, ob Folgendes zutrifft ...
Der Backofen kann nicht eingeschaltet oder bedient werden.	Der Backofen ist ordnungsgemäß an die Spannungsversorgung angeschlossen.

Der Backofen schaltet sich nicht ein oder heizt nicht auf	
Der Backofen heizt nicht auf.	Die Abschaltautomatik ausgeschaltet.
Der Backofen heizt nicht auf.	Die Backofen-Tür ist geschlossen.
Der Backofen heizt nicht auf.	Die Sicherung ist nicht durchgebrannt.
Der Backofen heizt nicht auf.	Die Kindersicherung ist ausgeschaltet.

Komponenten	
Störung	Prüfen Sie, ob Folgendes zutrifft ...
Die Lampe ist ausgeschaltet.	Feuchte Umluft - ist eingeschaltet.
Die Lampe funktioniert nicht.	Die Lampe ist durchgebrannt.

Fehlercodes	
Im Display erscheint ...	Prüfen Sie, ob Folgendes zutrifft ...
Err C3	Die Backofen-Tür ist geschlossen und die Türverriegelung ist nicht beschädigt.
Err F102	Die Backofen-Tür ist geschlossen.
Err F102	Die Türverriegelung nicht defekt ist.
00:00 angezeigt.	Es gab einen Stromausfall. Stellen Sie die Uhrzeit ein.
<p>Wenn das Display einen Fehlercode anzeigt, der nicht in dieser Tabelle enthalten ist, schalten Sie die Haussicherung aus und wieder ein, um den Ofen neu zu starten. Wenn der Fehlercode erneut angezeigt wird, wenden Sie sich an einen autorisierten Kundendienst.</p>	

13.2 Servicedaten

Wenn Sie das Problem nicht selbst lösen können, wenden Sie sich an Ihren Händler oder einen autorisierten Kundendienst.

Die vom Kundendienst benötigten Daten finden Sie auf dem Typenschild. Das Typenschild befindet sich auf dem vorderen Rahmen des Garraums. Entfernen Sie das Typenschild nicht vom Garraum.

Wir empfehlen Ihnen, die Daten hier zu notieren:	
Modell (MOD.):
Produktnummer (PNC)
Seriennummer (S.N.)

14. ENERGIEEFFIZIENZ

14.1 Produktinformationen und Produktinformationsblatt*

Name des Lieferanten	Electrolux	
Modellbezeichnung	EOF4P46X 949498237 EOF6P46X 949498239	
Energieeffizienzindex	81.2	
Energieeffizienzklasse	A+	
Energieverbrauch mit einer Standardbeladung, konventioneller Modus	0.93 kWh/Programm	
Energieverbrauch mit einer Standardbeladung, Umluft-Modus	0.69 kWh/Programm	
Anzahl der Garräume	1	
Wärmequelle	Strom	
Volumen	72 l	
Art des Backofens	Eingebauter Backofen	
Masse	EOF4P46X	29.5 kg
	EOF6P46X	31.6 kg

* Für die Europäische Union gemäß EU-Richtlinien 65/2014 und 66/2014.
Für die Republik Weißrussland gemäß STB 2478-2017, Anhang G; STB 2477-2017, Anlagen A und B
Für die Ukraine gemäß 568/32020.

Die Energieeffizienzklasse gilt nicht für Russland.

EN 60350-1 - Elektrische Kochgeräte für den Hausgebrauch - Teil 1: Stufen, Backöfen, Dampfofen und Grills – Methoden zur Leistungsmessung.

14.2 Energiesparen



Der Backofen verfügt über Funktionen, mit deren Hilfe Sie beim täglichen Kochen Energie sparen können.

Achten Sie darauf, dass die Backofentür während des Ofenbetriebs geschlossen ist. Die Backofentür darf während des Garvorgangs nicht zu oft geöffnet werden. Halten Sie die Türdichtung sauber und stellen Sie sicher, dass sie sich fest in der richtigen Position befindet. Verwenden Sie Kochgeschirr aus Metall, um mehr Energie zu sparen.

Heizen Sie, wenn möglich, den Backofen nicht vor.

Wenn Sie mehrere Speisen gleichzeitig zubereiten, halten Sie die Unterbrechungen beim Backen so kurz wie möglich.

Garen mit Heißluft

Nutzen Sie, wenn möglich, die Garfunktionen mit Heißluft, um Energie zu sparen.

Restwärme

Ventilator und Lampe funktionieren weiter. Sobald Sie den Backofen ausschalten, wird im Display die Restwärme angezeigt. Die Restwärme kann zum Warmhalten von Speisen genutzt werden.

Beträgt die Garzeit mehr als 30 Minuten, reduzieren Sie die Ofentemperatur 3 - 10 Min. vor Ablauf des Garvorgangs. Die Restwärme im Backofen wird weiterhin garen.

Nutzen Sie die Restwärme, um andere Speisen aufzuwärmen.

Warmhalten von Speisen

Wählen Sie die niedrigste Temperatureinstellung, wenn Sie die Restwärme zum Warmhalten von Speisen nutzen möchten. Die Restwärmeanzeige oder Temperatur werden auf dem Display angezeigt.

Garen bei ausgeschalteter Backofenbeleuchtung

Schalten Sie die Lampe während des Garvorgangs aus. Schalten Sie sie nur ein, wenn Sie sie benötigen.

Feuchte Umluft

Diese Funktion soll während des Garvorgangs Energie sparen.

Bei Verwendung dieser Funktion schaltet sich die Lampe automatisch nach 30 Sekunden aus. Sie können die Lampe wieder einschalten, aber dadurch werden die erwarteten Energieeinsparungen reduziert.



15. MENÜSTRUKTUR





15.1 Menü



- Wählen Sie , um die Menü einzugeben.



MENÜSTRUKTUR

Menü Struktur		
Koch-Assistent 	Reinigung 	Einstellungen 

Schritt 1	Schritt 2	Schritt 3	Schritt 4	Schritt 5
	 OK	 O1 - O11	 OK	
Wählen Sie Menü, Einstellungen.	Bestätigen Sie die Einstellung.	Wählen Sie die Einstellung.	Bestätigen Sie die Einstellung.	Stellen Sie den Wert ein und drücken Sie OK.

Einstellungen					
O1	Uhrzeit	Ändern	O2	Helligkeit	1 - 5
O3	Tastentöne	1 - Signalton 2 - Klicken 3 - Ausschalten	O4	Lautstärke	1 - 4
O5	Uptimer	Ein / Aus	O6	Backofenbeleuchtung	Ein / Aus
O7	Schnellaufheizung	Ein / Aus	O8	Erinnerungsfunktion Reinigen	Ein / Aus
O9	DEMO	Aktivierungscode: 2468	O10	Softwareversion	Prüfen
O11	Gerät auf Werkseinstellungen zurücksetzen	Ja / Nein			

16. UMWELTTIPPS

Recyceln Sie Materialien mit dem Symbol . Entsorgen Sie die Verpackung in den entsprechenden Recyclingbehältern. Recyceln Sie zum Umwelt- und Gesundheitsschutz elektrische und elektronische Geräte. Entsorgen Sie Geräte mit diesem Symbol  nicht mit

dem Hausmüll. Bringen Sie das Gerät zu Ihrer örtlichen Sammelstelle oder wenden Sie sich an Ihr Gemeindeamt.

PENSIAMO A TE

Grazie per aver acquistato un elettrodomestico Electrolux. Hai scelto un prodotto che ha alle spalle decenni di esperienza professionale e innovazione. Ingegnoso ed elegante, è stato progettato pensando a te. Quindi, in qualsiasi momento lo utilizzi, avrai la certezza di ottenere sempre i migliori risultati.

Ti diamo il benvenuto in Electrolux.

Visitate il nostro sito web per:



Ricevere consigli, scaricare i nostri opuscoli, eliminare eventuali anomalie, ottenere informazioni sull'assistenza e la riparazione:

www.electrolux.com/support



Per registrare il vostro prodotto e ricevere un servizio migliore:

www.registerelectrolux.com



Acquistare accessori, materiali di consumo e ricambi originali per la vostra apparecchiatura:

www.electrolux.com/shop



Per ulteriori ricette, suggerimenti, indicazioni per la risoluzione dei problemi scaricare l'app **My Electrolux Kitchen**.



ASSISTENZA CLIENTI E ASSISTENZA TECNICA

Consigliamo sempre l'impiego di ricambi originali.

Quando si contatta il nostro Centro di Assistenza Autorizzato, accertarsi di avere a disposizione i dati seguenti: Modello, numero dell'apparecchio (PNC), numero di serie.

Le informazioni sono riportate sulla targhetta identificativa.

 Avvertenza/Attenzione - Importanti Informazioni per la sicurezza

 Informazioni generali e suggerimenti

 Informazioni ambientali

Con riserva di modifiche.

INDICE

1. INFORMAZIONI DI SICUREZZA.....	117	2.6 Illuminazione interna.....	123
1.1 Sicurezza di bambini e persone vulnerabili.....	117	2.7 Assistenza.....	124
1.2 Avvertenze di sicurezza generali.	118	2.8 Smaltimento.....	124
2. ISTRUZIONI DI SICUREZZA.....	119	3. INSTALLAZIONE.....	124
2.1 Installazione.....	119	3.1 Incasso.....	124
2.2 Collegamento elettrico.....	120	3.2 Fissaggio nel mobile.....	125
2.3 Utilizzo:.....	121	4. DESCRIZIONE DEL PRODOTTO.....	126
2.4 Pulizia e cura.....	122	4.1 Panoramica generale.....	126
2.5 Pulizia pirolitica.....	123	4.2 Accessori.....	126

5. COME ACCENDERE E SPEGNERE IL FORNO.....	126	11.2 Cottura ventilata umida - accessori consigliati.....	142
5.1 Manopola incassabile.....	126	11.3 Tabelle di cottura per gli istituti di test.....	142
5.2 Pannello dei comandi.....	127	12. PULIZIA E CURA.....	144
6. PRIMA DEL PRIMO UTILIZZO.....	128	12.1 Note sulla pulizia.....	144
6.1 Pulizia iniziale.....	128	12.2 Come rimuovere: Supporti del ripiano	145
6.2 Preriscaldamento iniziale.....	128	12.3 Istruzioni d'uso: Pulizia per pirolisi.....	145
7. UTILIZZO QUOTIDIANO.....	128	12.4 Promemoria Pulizia.....	147
7.1 Come impostare:		12.5 Procedura di rimozione e installazione: Sportello.....	147
Funzioni cottura.....	128	12.6 Come sostituire: Lampadina.....	149
7.2 Funzioni cottura.....	129	13. RISOLUZIONE DEI PROBLEMI.....	150
7.3 Note su: Cottura ventilata umida.	130	13.1 Cosa fare se.....	150
7.4 Come impostare: Cottura guidata	130	13.2 Dati dell'Assistenza.....	151
7.5 Cottura guidata.....	131	14. EFFICIENZA ENERGETICA.....	151
8. FUNZIONI DEL TIMER.....	136	14.1 Informazioni sul prodotto e scheda informativa sul prodotto*.....	151
8.1 Funzioni orologio.....	136	14.2 Risparmio energetico.....	152
8.2 Come impostare:		15. STRUTTURA DEL MENU.....	153
Funzioni Orologio.....	136	15.1 Menu.....	153
9. COME USARE: ACCESSORI.....	138	16. CONSIDERAZIONI SULL'AMBIENTE..	154
9.1 Inserimento di accessori.....	138		
10. FUNZIONI AGGIUNTIVE.....	139		
10.1 Blocco.....	139		
10.2 Spegnimento automatico.....	139		
10.3 Ventola di raffreddamento.....	140		
11. CONSIGLI E SUGGERIMENTI UTILI....	140		
11.1 Cottura ventilata umida.....	140		

1. INFORMAZIONI DI SICUREZZA

Leggere attentamente le istruzioni fornite prima di installare e utilizzare l'apparecchiatura. I produttori non sono responsabili di eventuali lesioni o danni derivanti da un'installazione o un uso scorretti. Conservare sempre le istruzioni in un luogo sicuro e accessibile per poterle consultare in futuro.

1.1 Sicurezza di bambini e persone vulnerabili

- Quest'apparecchiatura può essere usata da bambini a partire da 8 anni di età e da adulti con capacità fisiche, sensoriali o mentali limitate o con scarsa esperienza e

conoscenza sull'uso dell'apparecchiatura, solamente se sorvegliati o se istruiti relativamente all'utilizzo in sicurezza dell'apparecchiatura e se hanno compreso i rischi coinvolti. I bambini che hanno meno di 8 anni e le persone con disabilità diffuse e complesse vanno tenuti lontani dall'elettrodomestico, a meno che non vi sia una supervisione continua.

- I bambini devono essere sorvegliati per assicurarsi che non giochino con l'apparecchiatura.
- Tenere gli imballaggi lontano dai bambini e smaltirli in modo adeguato.
- **AVVERTENZA:** L'elettrodomestico e le parti accessibili si riscaldano molto durante l'uso. Tenere i bambini e gli animali domestici lontani dall'apparecchiatura durante l'uso e durante il raffreddamento.
- Se l'elettrodomestico ha un dispositivo di sicurezza per i bambini sarà opportuno attivarlo.
- I bambini non devono eseguire interventi di pulizia e manutenzione sull'elettrodomestico senza essere supervisionati.

1.2 Avvertenze di sicurezza generali

- L'apparecchiatura è destinata solo alla cottura.
- Quest'apparecchiatura è progettata per un uso domestico singolo in un ambiente interno.
- Quest'apparecchiatura può essere utilizzata in uffici, camere d'albergo, camere di bed & breakfast, alloggi in agriturismi e altre sistemazioni simili in cui tale utilizzo non superi i livelli di utilizzo domestico (medi).
- L'installazione dell'apparecchiatura e la sostituzione dei cavideve essere effettuata unicamente da personale qualificato.
- Non utilizzare l'apparecchiatura prima di installarla nella struttura a incasso.

- Prima di ogni operazione di manutenzione, scollegare l'apparecchiatura dall'alimentazione elettrica.
- Se il cavo di alimentazione è danneggiato, deve essere sostituito dal produttore, da un centro di assistenza tecnica autorizzato o da una persona qualificata per evitare situazioni di pericolo elettrico.
- **AVVERTENZA:** Assicurarsi che l'elettrodomestico sia spento prima di sostituire la lampadina per evitare la possibilità di scosse elettriche.
- **AVVERTENZA:** L'elettrodomestico e le parti accessibili si riscaldano molto durante l'uso. Fare attenzione a non toccare gli elementi riscaldanti.
- Utilizzare sempre guanti da forno per rimuovere o inserire accessori o pirofile.
- Per rimuovere i supporti del ripiano, tirare prima la parte anteriore del supporto del ripiano e poi l'estremità posteriore lontano dalle pareti laterali. Installare i supporti ripiani seguendo al contrario la procedura indicata.
- Non utilizzare vaporelle per pulire l'elettrodomestico.
- Non utilizzare detergenti abrasivi o raschietti di metallo per pulire il vetro dello sportello per non rigare la superficie e causare la rottura del vetro.
- Prima della pulizia per pirolisi rimuovere gli accessori e i depositi/le fuoriuscite eccessivi dalla cavità del forno.

2. ISTRUZIONI DI SICUREZZA

2.1 Installazione

**AVVERTENZA!**

L'installazione dell'apparecchiatura deve essere eseguita da personale qualificato.

- Rimuovere tutti i materiali di imballaggio.
- Non installare o utilizzare l'apparecchiatura se è danneggiata.
- Attenersi alle istruzioni fornite insieme all'apparecchiatura.
- Prestare sempre attenzione in fase di spostamento dell'apparecchiatura, dato che è pesante. Usare sempre i guanti di sicurezza e le calzature adeguate.
- Non tirare l'apparecchiatura per la maniglia.
- Installare l'apparecchiatura in un luogo sicuro e idoneo che soddisfi i requisiti di installazione.

ISTRUZIONI DI SICUREZZA

- È necessario rispettare la distanza minima dalle altre apparecchiature.
- Prima di montare l'apparecchiatura controllare che la porta del forno si apra senza limitazioni.
- L'apparecchiatura è dotata di un sistema di raffreddamento elettrico. Quest'ultimo funziona a corrente elettrica.

Altezza minima del mobiletto (mobiletto sotto all'altezza minima del piano di lavoro)	580 (600) mm
Larghezza del mobiletto	560 mm
Profondità del mobiletto	550 (550) mm
Altezza della parte anteriore dell'apparecchiatura	589 mm
Altezza della parte posteriore dell'apparecchiatura	571 mm
Larghezza della parte anteriore dell'apparecchiatura	595 mm
Larghezza della parte posteriore dell'apparecchiatura	559 mm
Profondità dell'apparecchiatura	569 mm
Profondità di incasso dell'apparecchiatura	548 mm
Profondità con porta aperta	1022 mm
Dimensioni minime dell'apertura di ventilazione. Apertura collocata sul lato posteriore inferiore	560x20 mm
Lunghezza del cavo di alimentazione. Il cavo è collocato nell'angolo destro del lato posteriore	1500 mm
Viti di montaggio	4x25 mm

2.2 Collegamento elettrico



AVVERTENZA!

Rischio di incendio e scossa elettrica.

- Tutti i collegamenti elettrici devono essere realizzati da un elettricista qualificato.
- L'apparecchiatura deve disporre di una messa a terra.
- Verificare che i parametri sulla targhetta siano compatibili con le indicazioni elettriche dell'alimentazione.
- Utilizzare sempre una presa elettrica con contatto di protezione correttamente installata.
- Non utilizzare prese multiple e prolunghie.

- Accertarsi di non danneggiare la spina e il cavo. Qualora il cavo elettrico debba essere sostituito, l'intervento dovrà essere effettuato dal nostro Centro di Assistenza autorizzato.
- Evitare che i cavi entrino a contatto o si trovino vicino alla porta dell'apparecchiatura o sulla nicchia sotto all'apparecchiatura, in particolare quando il dispositivo è in funzione o la porta è calda.
- I dispositivi di protezione da scosse elettriche devono essere fissati in modo tale da non poter essere disattivati senza l'uso di attrezzi.
- Inserire la spina di alimentazione nella presa solo al termine dell'installazione. Verificare che la spina di alimentazione rimanga accessibile dopo l'installazione.
- Nel caso in cui la spina di corrente sia allentata, non collegarla alla presa.
- Non tirare il cavo di alimentazione per scollegare l'apparecchiatura. Tirare sempre dalla spina.
- Servirsi unicamente di dispositivi di isolamento adeguati: interruttori automatici, fusibili (quelli a tappo devono essere rimossi dal portafusibile), sganciatori per correnti di guasto a terra e relè.
- L'impianto elettrico deve essere dotato di un dispositivo di isolamento che consenta di scollegare l'apparecchiatura dalla presa di corrente a tutti i poli. Il dispositivo di isolamento deve avere una larghezza dell'apertura di contatto non inferiore ai 3 mm.
- Chiudere completamente la porta dell'apparecchiatura prima di collegare spina alla presa elettrica.
- La dotazione standard dell'apparecchiatura al momento della fornitura prevede una spina e un cavo di rete.

Tipi di cavi disponibili per l'installazione o la sostituzione per l'Europa:

H07 RN-F, H05 RN-F, H05 RRF, H05 VV-F, H05 V2V2-F (T90), H05 BB-F

Per la sezione del cavo, fare riferimento alla potenza totale sulla targhetta dei dati. È anche possibile consultare la tabella:

Potenza totale (W)	Sezione del cavo (mm ²)
massimo 1.380	3 x 0.75
massimo 2.300	3 x 1
massimo 3.680	3 x 1.5

Il cavo di terra (verde/giallo) deve essere 2 cm più lungo dei cavi di fase e neutro (blu e marrone).

2.3 Utilizzo:



AVVERTENZA!

Rischio di lesioni, ustioni, scosse elettriche o esplosioni.

- Non modificare le specifiche tecniche dell'apparecchiatura.
- Assicurarsi che le aperture di ventilazione non siano bloccate.
- Non lasciare l'elettrodomestico incustodito durante il funzionamento.

ISTRUZIONI DI SICUREZZA

- Spegnere l'elettrodomestico dopo ogni utilizzo.
- Prestare attenzione in fase di apertura dello sportello dell'elettrodomestico, quando quest'ultimo è in funzione. Può esservi un rilascio di aria calda.
- Non accendere l'elettrodomestico con le mani bagnate o quando è a contatto con l'acqua.
- Non esercitare pressione sullo sportello aperto.
- Non utilizzare l'elettrodomestico come superficie di lavoro o come superficie di deposito.
- Aprire lo sportello dell'elettrodomestico attentamente. L'utilizzo di ingredienti con alcol può provocare una miscela di alcol e aria.
- Non lasciare scintille o fiamme libere a contatto con l'elettrodomestico quando si apre lo sportello.
- Non appoggiare o tenere liquidi o materiali infiammabili, né oggetti facilmente infiammabili sull'apparecchiatura, al suo interno o nelle immediate vicinanze.



AVVERTENZA!

Vi è il rischio di danneggiare l'apparecchiatura.

- Per evitare danni o lo scolorimento dello smalto:
 - Non collocare piropile o altri oggetti all'interno dell'elettrodomestico direttamente sul fondo.
 - Non collocare la pellicola di alluminio direttamente sul fondo della cavità dell'elettrodomestico.
 - Non versare acqua direttamente all'interno dell'elettrodomestico caldo.
 - Non conservare piatti e alimenti umidi all'interno dell'elettrodomestico dopo aver terminato la cottura.
 - Prestare attenzione in fase di rimozione o installazione degli accessori.
- Lo scolorimento dello smalto o dell'acciaio inox non influisce sulle prestazioni dell'elettrodomestico.
- Usare una leccarda per torte umide. I succhi di frutta causano macchie che possono essere permanenti.
- Eseguire sempre la cottura con lo sportello dell'apparecchiatura chiuso.
- Se l'apparecchiatura si trova dietro a un pannello anteriore (ad es. una porta), assicurarsi che questo non sia mai chiuso quando l'apparecchiatura è in funzione. Calore e umidità possono accumularsi sul retro di un pannello chiuso causando danni all'apparecchiatura, all'alloggiamento o al pavimento. Dopo l'uso non chiudere il pannello dell'armadio finché l'apparecchiatura non si è completamente raffreddata.

2.4 Pulizia e cura



AVVERTENZA!

Vi è il rischio di lesioni, incendio o danni all'apparecchiatura.

- Prima di eseguire qualunque intervento di manutenzione, spegnere l'apparecchiatura ed estrarre la spina dalla presa.
- Controllare che l'apparecchiatura sia fredda. Vi è il rischio che i pannelli in vetro si rompano.
- Sostituire immediatamente i pannelli in vetro della porta nel caso in cui siano danneggiati. Contattare il Centro Assistenza Autorizzato.
- Prestare attenzione quando si rimuove la porta dall'apparecchio. La porta è pesante!
- Pulire regolarmente l'apparecchiatura per evitare il deterioramento dei materiali che compongono la superficie.
- Pulire l'apparecchiatura con un panno inumidito e morbido. Utilizzare solo detersivi neutri. Non usare prodotti abrasivi, spugnette abrasive, solventi od oggetti metallici.

- Se si utilizza uno spray per il forno, seguire attentamente le istruzioni di sicurezza sulla confezione.

2.5 Pulizia pirolitica



AVVERTENZA!

Rischio di lesioni/Incendi/Emissioni chimiche (Fumi) in Modalità Pirolitica.

- Prima di eseguire una funzione di pulizia automatica per Pirolisi o prima del Primo Utilizzo, rimuovere dalla cavità del forno:
 - qualsiasi residuo di cibo e schizzo/deposito di grasso.
 - qualsiasi oggetto rimovibile (compresi ripiani, guide ecc. forniti con il prodotto), in particolare qualsiasi pentola, padella, teglia, utensile antiaderente ecc.
- Leggere attentamente tutte le istruzioni riguardanti la pulizia per Pirolisi.
- Tenere bambini lontano dall'apparecchiatura mentre è in corso la pulizia pirolitica. L'apparecchiatura diventa molto calda e viene rilasciata aria calda dalle aperture di raffreddamento anteriori.
- La pulizia per pirolisi è un'operazione ad alta temperatura che può provocare la formazione di fumi prodotti dai residui di cottura e dai materiali strutturali, di conseguenza gli utenti sono fortemente invitati a:
 - assicurare una buona ventilazione durante e dopo ogni pulizia per Pirolisi.
 - assicurare una buona ventilazione durante e dopo il primo utilizzo alla massima temperatura.
- A differenza delle persone, alcune specie di uccelli e rettili possono essere estremamente sensibili ai fumi che possono venire prodotti durante il processo di pulizia dei Forni Pirolitici.
 - Allontanare eventuali animali domestici (in particolare gli uccelli) dall'apparecchiatura durante e dopo la pulizia per Pirolisi e prevedere prima di tutto un funzionamento alla massima temperatura in un'area ben ventilata.
- I piccoli animali domestici sono anche estremamente sensibili alle variazioni di temperatura in prossimità dei Forni Pirolitici quando il programma di pulizia automatica per Pirolisi è in corso.
- Superfici antiaderenti di pentole, teglie, utensili, ecc., possono venire danneggiate dall'alta temperatura utilizzata per la pulizia per Pirolisi in tutti i Forni Pirolitici e diventare fonte di vapori relativamente nocivi.
- I vapori rilasciati da tutti i Forni Pirolitici/Residui di Cottura vengono definiti come non nocivi per la salute umana, compresi bambini o persone affette da malattie.

2.6 Illuminazione interna



AVVERTENZA!

Pericolo di scosse elettriche.

- Per quanto riguarda la lampada o le lampade all'interno di questo prodotto e le lampade di ricambio vendute separatamente: Queste lampade sono destinate a resistere a condizioni fisiche estreme negli elettrodomestici, come temperatura, vibrazioni, umidità, o sono destinate a segnalare informazioni sullo stato operativo dell'apparecchio. Non sono destinate ad essere utilizzate in altre applicazioni e non sono adatte per l'illuminazione di ambienti domestici.
- Questo prodotto contiene una sorgente luminosa di classe di efficienza energetica G.
- Servirsi unicamente di lampadine con le stesse specifiche tecniche .

INSTALLAZIONE

2.7 Assistenza

- Per far riparare l'apparecchiatura, rivolgersi a un Centro di Assistenza Autorizzato.
- Utilizzare solo ricambi originali.

2.8 Smaltimento



AVVERTENZA!

Rischio di lesioni o soffocamento.

- Contattare le autorità locali per ricevere informazioni su come smaltire correttamente l'apparecchiatura.
- Staccare la spina dall'alimentazione elettrica.
- Tagliare il cavo elettrico dell'apparecchiatura e smaltirlo.
- Togliere il blocco porta per evitare che bambini, o animali restino intrappolati nell'apparecchiatura.

3. INSTALLAZIONE



AVVERTENZA!

Fare riferimento ai capitoli sulla sicurezza.

3.1 Incasso



YouTube

www.youtube.com/electrolux
www.youtube.com/aeg

How to install your AEG/Electrolux
Oven - Column installation

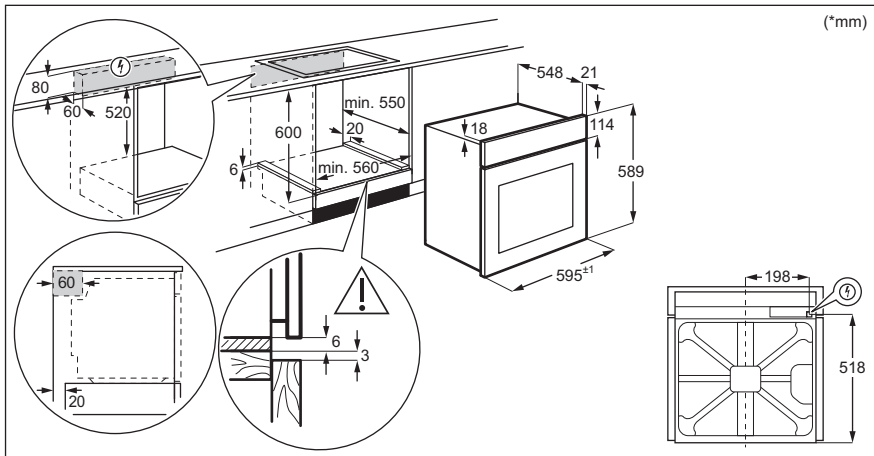

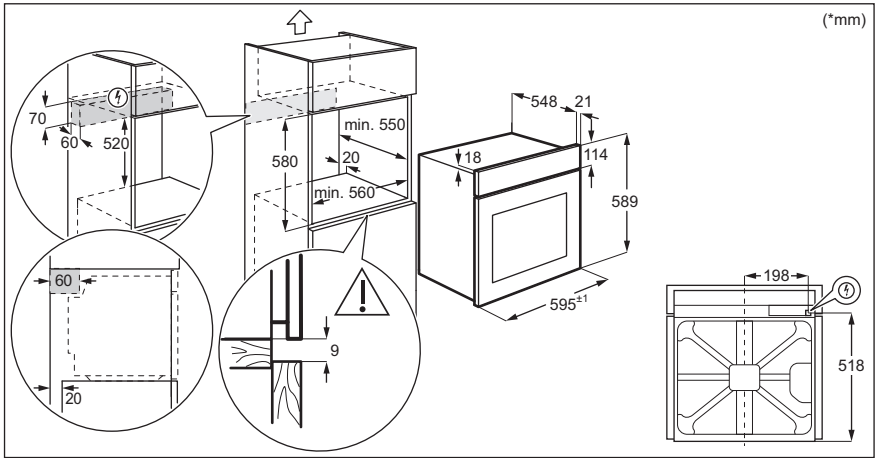

3.2 Fissaggio nel mobile

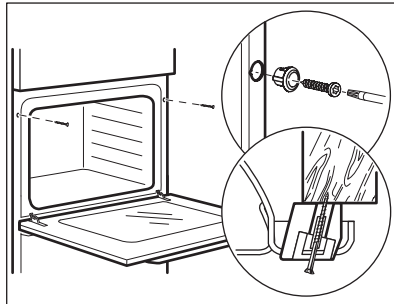

4. DESCRIZIONE DEL PRODOTTO

4.1 Panoramica generale

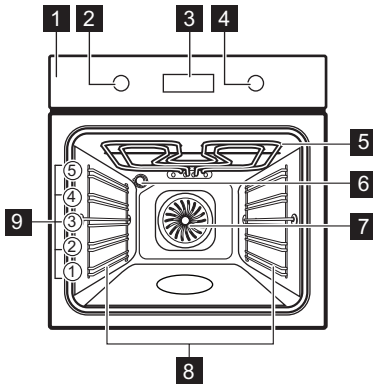

- 1** Pannello dei comandi
- 2** Manopola di regolazione delle funzioni cottura
- 3** Display
- 4** Manopola di regolazione
- 5** Resistenza
- 6** Lampadina
- 7** Ventola
- 8** Supporto ripiano, rimovibile
- 9** Posizioni ripiano

4.2 Accessori

- **Ripiano a filo**
Per stoviglie, stampi per dolci, arrostiti.
- **Lamiera dolci**
Per torte e biscotti.
- **Leccarda**
Per cuocere al forno e arrostitire o per raccogliere il grasso.







5. COME ACCENDERE E SPEGNERE IL FORNO

5.1 Manopola incassabile

Per utilizzare l'apparecchiatura, premere la manopola. La manopola fuoriesce.



COME ACCENDERE E SPEGNERE IL FORNO







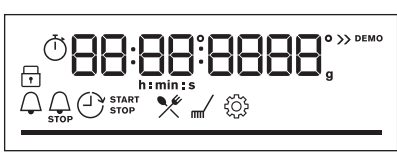

5.2 Pannello dei comandi

Tasti sensore pannello dei comandi					Premere	Ruotare la manopola
 Timer	 Riscaldamento rapido	 Luce forno	 Blocco	OK		

Selezionare una funzione cottura per accendere il forno.

Per spegnere il forno, ruotare la manopola delle funzioni di riscaldamento fino a portarla in posizione off.

	Quando la manopola delle funzioni di riscaldamento è in posizione off, il display passa in modalità standby.
	Quando si cucina, il display mostra la temperatura impostata, l'ora del giorno e le altre opzioni disponibili.
	Il display col numero massimo di funzioni impostate.

Spie display				
 Blocco	 Cottura guidata	 Pulizia	 Impostazioni	 Riscaldamento rapido
Spie timer:		 STOP		

Barra di avanzamento - per temperatura o tempo.



PRIMA DEL PRIMO UTILIZZO

6. PRIMA DEL PRIMO UTILIZZO



AVVERTENZA!

Fare riferimento ai capitoli sulla sicurezza.

6.1 Pulizia iniziale

Prima della messa in uso, pulire il forno vuoto e impostare l'ora:



00:00

Impostare l'ora. Premere OK.

6.2 Preriscaldamento iniziale

Preriscaldare il forno vuoto prima di utilizzarlo per la prima volta.

Fase 1 Togliere gli accessori e i supporti ripiano amovibili dal forno.

Fase 2 Impostare la temperatura massima per la funzione: .
Lasciare in funzione il forno per un'ora.

Fase 3 Impostare la temperatura massima per la funzione: .
Lasciare in funzione il forno per 15 minuti.

 Il forno può produrre un odore sgradevole e fumo in fase di pre-riscaldamento. Accertarsi che la stanza sia ventilata.

7. UTILIZZO QUOTIDIANO



AVVERTENZA!



Fare riferimento ai capitoli sulla sicurezza.

7.1 Come impostare: Funzioni cottura

Avviare la cottura







Passaggio 1





Fase 2

Avviare la cottura	
	
Imposta una funzione di cottura.	Impostare la temperatura.

7.2 Funzioni cottura

Funzioni cottura standard

Funzione cottura	Applicazione
 Cottura ventilata	Per cuocere su massimo tre posizioni della griglia contemporaneamente ed essiccare i cibi. Impostare la temperatura di 20 - 40°C inferiore rispetto a Cottura convenzionale. .
 Cottura convenzionale	Per cuocere e arrostitire alimenti su una sola posizione del ripiano.
 Cibi congelati	Per rendere croccanti i cibi confezionati, come ad esempio patatine fritte, crocchette o involtini primavera.
 Funzione Pizza	Per cuocere la pizza. Per una doratura intensa e una base croccante.
 Resistenza inferiore	Per dorare torte con base croccante e per conservare gli alimenti.
 Scongelamento	Per scongelare gli alimenti (verdura e frutta). Il tempo di scongelamento dipende dalla quantità e dalle dimensioni del cibo congelato.

Funzione cottura	Applicazione
 <p>Cottura ventilata umida</p>	<p>Questa funzione è progettata per il risparmio energetico durante la cottura. Quando viene usata questa funzione, la temperatura all'interno della cavità potrebbe essere diversa rispetto alla temperatura impostata. Viene utilizzato il calore residuo. La potenza riscaldante potrebbe essere ridotta. Per ulteriori informazioni, consultare il capitolo "Uso quotidiano", Note su: Cottura ventilata umida.</p>
 <p>Grill</p>	<p>Per grigliare alimenti di ridotto spessore e tostare il pane.</p>
 <p>Doppio grill ventilato</p>	<p>Per arrostitire grandi tagli di carne o pollame con ossa su una posizione della griglia. Per gratinare e dorare.</p>
 <p>Menu</p>	<p>Per accedere al Menu: Cottura guidata, Pulizia, Impostazioni.</p>

7.3 Note su: Cottura ventilata umida

Questa funzione è stata utilizzata per la conformità alla classe energetica e ai requisiti di ecodesign secondo la normativa UE 65/2014 e UE 66/2014. Test secondo la norma EN 60350-1.

La porta del forno dovrebbe essere chiusa in fase di cottura, in modo che la funzione non venga interrotta. Ciò garantisce inoltre che il forno funzioni con la più elevata efficienza energetica possibile.

Quando viene usata questa funzione, la lampada si spegne automaticamente dopo 30 secondi. Per le istruzioni di cottura rimandiamo al capitolo "Consigli e suggerimenti", Cottura ventilata umida. Per indicazioni generali sul risparmio energetico rimandiamo al capitolo "Efficienza energetica", Risparmio energetico.

7.4 Come impostare: Cottura guidata





Ogni pietanza di questo sottomenu prevede funzione e temperatura consigliate. È possibile regolare l'ora e la temperatura in fase di cottura.

Alcune pietanze possono anche essere cucinate usando:	<ul style="list-style-type: none"> • Peso automatico
---	---



Cottura guidata - utilizzare per preparare un piatto rapidamente con le impostazioni predefinite:

Passaggio 1	Passaggio 2	Passaggio 3	Passaggio 4
-------------	-------------	-------------	-------------



Cottura guidata - utilizzare per preparare un piatto rapidamente con le impostazioni predefinite:

			
≡	✂	P1 - P45	OK
Accedere al menu.	Selezionare Cottura guidata. Premere OK.	Selezionare la pietanza. Premere OK.	Inserire la pietanza nel forno. Confermare l'impostazione.











7.5 Cottura guidata













Legenda	
	Peso automatico disponibile.
	Preriscaldare il forno prima di iniziare a cucinare.
	Livello del ripiano.

Al termine della funzione, controllare se il cibo è pronto.





















	Piatto	Peso	Livello / Accessorio ripiano	Durata
Manzo 🍖				
P1	Roast beef, al sangue	1 - 1,5 kg; pezzi spessi 4-5 cm	 2 lamiera dolci Friggere la carne per alcuni minuti in una padella calda. Informare.	40 min
P2	Roast beef, cottura media			50 min
P3	Roast beef, ben cotto			60 min
P4	Bistecca, media cottura	180 - 220 g per pezzo; fette di 3 cm di spessore	  3 ; pirofila su ripiano a filo Friggere la carne per alcuni minuti in una padella calda. Informare.	15 min

















UTILIZZO QUOTIDIANO

	Piatto	Peso	Livello / Accessorio ripiano	Durata
P5	Arrosto di manzo / brasato (costoletta, scamone, fesa)	1,5 - 2 kg	  2; pirofila su ripiano a filo Friggere la carne per alcuni minuti in una padella calda. Aggiungere liquido. Infornare.	120 min
P6	Roast beef, al sangue (cottura lenta)	1 - 1,5 kg; pezzi spessi 4-5 cm	 2; lamiera dolci Utilizzare le spezie preferite o il semplice pepe macinato. Friggere la carne per alcuni minuti in una padella calda. Infornare.	75 min
P7	Roast beef, cottura media (cottura lenta)			85 min
P8	Roast beef, ben cotto (cottura lenta)			130 min
P9	Filetto, al sangue (cottura lenta)	0,5 - 1,5 kg; pezzi spessi 5-6 cm	 2 lamiera dolci Utilizzare le spezie preferite o il semplice pepe macinato. Friggere la carne per alcuni minuti in una padella calda. Infornare.	75 min
P10	Filetto, cottura media (cottura lenta)			90 min
P11	Filetto, cotto (cottura lenta)			120 min
Vitello 				
P12	Arrosto di vitello (ad es. spalla)	0,8 - 1,5 kg; pezzi spessi 4 cm	  2; pirofila su ripiano a filo Utilizzare le spezie preferite. Aggiungere liquido. Arrosto coperto.	80 min
Maiale  				
P13	Collo o spalla di maiale arrosto	1,5 - 2 kg	  2; pirofila su ripiano a filo Girare la carne a metà cottura.	120 min







	Piatto	Peso	Livello / Accessorio ripiano	Durata
P14	Maiale sfilacciato (cottura lenta)	1,5 - 2 kg	 2 lamiera dolci Utilizzare le spezie preferite. Girare la carne a metà cottura per ottenere una doratura uniforme.	215 min
P15	Lombo, fresco	1 - 1,5 kg; pezzi spessi 5-6 cm	 2 ; pirofila su ripiano a filo Utilizzare le spezie preferite.	55 min
P16	Costolette di maiale	2 - 3 kg; utilizzare puntine crude, 2 - 3 cm	 3; leccarda Aggiungere il liquido per coprire il fondo di un piatto. Girare la carne a metà cottura.	90 min
Agnello 				
P17	Cosciotto d'agnello con ossa	1,5 - 2 kg; 7 - 9 cm di spessore	 2 ; pirofila su lamiera dolci Aggiungere liquido. Girare la carne a metà cottura.	130 min
Pollame 				
P18	Pollo intero	1 - 1,5 kg; fresco	  2 casseruola su lamiera dolci Utilizzare le spezie preferite. Girare il pollo a metà cottura per ottenere una doratura uniforme.	60 min
P19	Mezzo pollo	0,5 - 0,8 kg	 3; teglia da forno Utilizzare le spezie preferite.	40 min
P20	Pollo, petto	180 - 200 g per pezzo	  2 ; casseruola su ripiano a filo Utilizzare le spezie preferite. Friggere la carne per alcuni minuti in una padella calda.	25 min
P21	Cosce di pollo, fresche	-	 3; lamiera dolci Se le cosce di pollo sono state marinate prima, impostare la temperatura più bassa e cuocerle più a lungo.	30 min

UTILIZZO QUOTIDIANO

	Piatto	Peso	Livello / Accessorio ripiano	Durata
P22	Anatra, intera	2 - 3 kg	  2; pirofila su ripiano a filo Utilizzare le spezie preferite. Sistemare la carne sulla teglia. Girare l'anatra a metà cottura.	100 min
P23	Oca, intera	4 - 5 kg	  2; leccarda Utilizzare le spezie preferite. Sistemare la carne su una teglia da forno profonda. Girare l'oca a metà cottura.	110 min
Altro 				
P24	Polpettone	1 kg	 2; ripiano a filo Utilizzare le spezie preferite.	60 min
Pesce 				
P25	Pesce intero, grigliato	0,5 - 1 kg per pesce	 2 lamiera dolci Farcire il pesce con burro e utilizzare spezie ed erbe preferite.	30 min
P26	Filetto di pesce	-	  3; casseruola su ripiano a filo Utilizzare le spezie preferite.	20 min
Dolci da forno / dessert   				
P27	Cheesecake	-	 2;  Tortiera apribile da 28 cm su ripiano a filo	90 min
P28	Torta di mele	-	 3; lamiera dolci	45 min
P29	Crostata di mele	-	 2; tortiera su ripiano a filo	40 min
P30	Torta di mele americana	-	 1;  tortiera da 22 cm su ripiano a filo	60 min
P31	Brownies	2 kg	 3 leccarda	30 min





	Piatto	Peso	Livello / Accessorio ripiano	Durata
P32	Muffin al cioccolato	-	 3, vassoio muffin su ripiano a filo	25 min
P33	Torta di pane	-	 2; leccarda su ripiano a filo	50 min
Verdure / Contorni   				
P34	Patate al forno	1 kg	 2; lamiera dolci Mettere le patate intere con buccia sulla lamiera dolci.	50 min
P35	Spicchi	1 kg	 3 lamiera dolci rivestita con carta da forno Utilizzare le spezie preferite. Tagliare le patate a pezzi.	35 min
P36	Verdure miste grigliate	1 - 1,5 kg	 3 lamiera dolci rivestita con carta da forno Utilizzare le spezie preferite. Tagliare le verdure a pezzi.	30 min
P37	Crocchette, surgelate	0,5 kg	 3; lamiera dolci	25 min
P38	Patatine, surgelate	0,75 kg	 3; lamiera dolci	25 min
Gratin, pane e pizza   				
P39	Lasagne di carne/verdure con piatti di pastasciutta	1 - 1,5 kg	 2 casseruola su ripiano a filo	45 min
P40	Patate gratinate (patate crude)	1 - 1,5 kg	 1 casseruola su ripiano a filo Ruotare il piatto a metà del tempo di cottura.	50 min
P41	Pizza fresca, sottile	-	  2 lamiera dolci rivestita con carta da forno	15 min

FUNZIONI DEL TIMER

	Piatto	Peso	Livello / Accessorio ripiano	Durata
P42	Pizza fresca, spessa	-	  2; lamiera dolci rivestita con carta da forno	25 min
P43	Quiche	-	 2; teglia da forno su ripiano a filo	45 min
P44	Baguette / Ciabatta / Pane bianco	0,8 kg	  3 lamiera dolci rivestita con carta da forno Più tempo necessario per il pane bianco.	30 min
P45	Impasto per pane integrale / pane di segale /pane nero in uno stampo per pane	1 kg	  2; lamiera dolci rivestita con carta da forno/ ripiano a filo	60 min

8. FUNZIONI DEL TIMER



8.1 Funzioni orologio

Funzione Orologio	Applicazione
	Contaminuti. Allo scadere del tempo, viene emesso un segnale acustico.
	Tempo di cottura. Quando il timer arriva alla fine, si sente un segnale e la funzione cottura si ferma.
	Ritardo. Per posticipare l'inizio e/o la fine della cottura.
	Timer. Il massimo è 23 ore 59 min. Questa funzione non ha nessun effetto sul funzionamento del forno. Per accendere e spegnere Timer selezionare: Menu, Impostazioni.





8.2 Come impostare: Funzioni Orologio

Come impostare: Imposta ora		
Fase 1	Passaggio 2	Fase 3

Come impostare: Imposta ora







		
Per modificare l'ora, accedere al menu e selezionare Impostazioni, Ora.	Impostare l'orologio.	Premere: OK.

Come impostare: Contaminuti

Fase 1	Il display visualizza: 0:00 	Passaggio 2	Passaggio 3
			
Premere: 		Imposta Contaminuti	Premere: OK.







i Il timer inizia subito il conto alla rovescia.

Come impostare: Tempo di cottura

Fase 1	Fase 2	Il display visualizza: 0:00  STOP	Passaggio 3	Passaggio 4
				
Selezionare una funzione di cottura e impostare la temperatura.	Premere ripetutamente: 		Impostare la durata della cottura.	Premere: OK.

i Il timer inizia subito il conto alla rovescia.

COME USARE: ACCESSORI

Come impostare: Ritardo							
Fase 1	Fase 2		Passaggio 3	Passaggio 4		Passaggio 5	Passaggio 6
		Il display mostra: l'ora del giorno 			Il display visualizza: ---:-- 		
Selezionare la funzione riscaldamento.	Premere ripetutamente: 	START	Impostare l'orario di inizio.	Premere: OK.	STOP	Impostare l'orario di fine.	Premere: OK.

 Il timer inizia il conto alla rovescia a un orario di inizio impostato.

9. COME USARE: ACCESSORI

9.1 Inserimento di accessori

Un piccolo rientro sulla parte superiore aumenta il livello di sicurezza. Gli incavi sono anche dispositivi antiribaltamento. Il bordo alto intorno al ripiano evita che pentole e padelle scivolino dal ripiano.

Ripiano a filo:

Spingere il ripiano fra le guide del supporto e verificare che i piedini siano rivolti verso il basso.

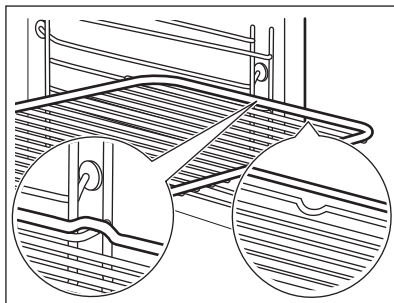

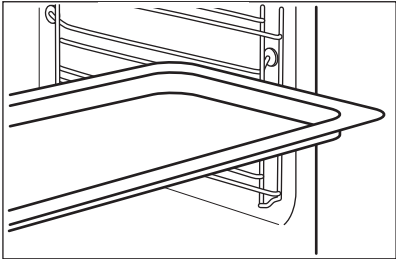
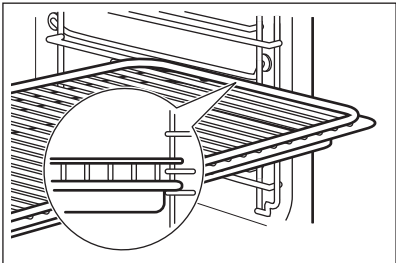
<p>Lamiera dolci / Teglia profonda: Spingere la lamiera tra le guide del supporto ripiano.</p>	
<p>Ripiano a filo, Lamiera dolci / Teglia profonda: Spingere il vassoio tra le guide del supporto ripiano e il ripiano a filo sulle guide sovrastanti.</p>	

10. FUNZIONI AGGIUNTIVE

10.1 Blocco

Questa funzione evita che si cambi per sbaglio la funzione forno.



Attivarla quando il forno è in funzione: la cottura impostata continua, il pannello dei comandi è bloccato.

Attivarla quando il forno è spento - il forno non può essere acceso, il pannello dei comandi è bloccato.



 - tenere premuto per attivare la funzione.
Viene emesso un segnale acustico.



 - premere e tenere premuto per disattivarla.

 3 x  - lampeggia quando il blocco è attivato.

10.2 Spegnimento automatico

Per ragioni di sicurezza, il forno si spegne dopo un determinato periodo di tempo se è attiva una funzione di riscaldamento e non si modificano le impostazioni.

CONSIGLI E SUGGERIMENTI UTILI

 (°C)	 (h)
30 - 115	12.5
120 - 195	8.5
200 - 245	5.5
250 - massimo	3

Lo spegnimento automatico non funziona con le funzioni: Luce forno, Ritardo.





10.3 Ventola di raffreddamento

Quando il forno è in funzione, la ventola di raffreddamento si accende in modo automatico per tenere fresche le superfici del forno. Dopo aver spento il forno, la ventola di raffreddamento potrebbe continuare a funzionare fino a che il forno non si è raffreddato.





11. CONSIGLI E SUGGERIMENTI UTILI

11.1 Cottura ventilata umida





Per ottenere i risultati migliori, attenersi ai suggerimenti elencati nella tabella sottostante.

		 (°C)		 (min.)
Roll dolci, 16 pezzi	vassoio di cottura o leccarda	180	2	20 - 30
Panini, 9 pezzi	vassoio di cottura o leccarda	180	2	30 - 40
Pizza, surgelata, 0,35 kg	ripiano a filo	220	2	10 - 15
Rotolo con marmellata	vassoio di cottura o leccarda	170	2	25 - 35
Brownie	vassoio di cottura o leccarda	175	3	25 - 30
Soufflé, 6 pezzi	stampini di ceramica sulla griglia	200	3	25 - 30

CONSIGLI E SUGGERIMENTI UTILI



		 (°C)		 (min.)
Base pan di spagna	teglia per timballo su griglia	180	2	15 - 25
Pasticcini per il tè	piatto da forno su griglia	170	2	40 - 50
Pesce lesso, 0,3 kg	vassoio di cottura o leccarda	180	3	20 - 25
Pesce intero, 0,2 kg	vassoio di cottura o leccarda	180	3	25 - 35
Filetto di pesce, 0,3 kg	teglia per pizza su griglia	180	3	25 - 30
Carne lessa, 0,25 kg	vassoio di cottura o leccarda	200	3	35 - 45
Shashlik, 0,5 kg	vassoio di cottura o leccarda	200	3	25 - 30
Dolcetti, 16 pezzi	vassoio di cottura o leccarda	180	2	20 - 30
Meringhe, 24 pezzi	vassoio di cottura o leccarda	180	2	25 - 35
Muffin, 12 pezzi	vassoio di cottura o leccarda	170	2	30 - 40
Pasta saporita, 20 pezzi	vassoio di cottura o leccarda	180	2	25 - 30
Biscotti di pasta frolla, 20 pezzi	vassoio di cottura o leccarda	150	2	25 - 35
Tartellette, 8 pezzi	vassoio di cottura o leccarda	170	2	20 - 30
Verdure, lesse, 0,4 kg	vassoio di cottura o leccarda	180	3	35 - 45

CONSIGLI E SUGGERIMENTI UTILI

		 (°C)		 (min.)
Omelette vegetariana	teglia per pizza su griglia	200	3	25 - 30
Verdure alla mediterranea, 0,7 kg	vassoio di cottura o leccarda	180	4	25 - 30

11.2 Cottura ventilata umida - accessori consigliati

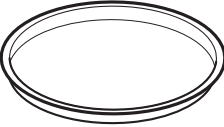
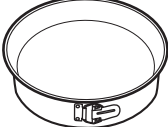





Usare scatole e contenitori scuri e non riflettenti. Assorbono meglio il calore rispetto al colore chiaro e ai piatti riflettenti.

			
Teglia da pizza	Pirofila	Pirofile monoporzione	Tortiera per flan
Scura, non riflettente 28 cm di diametro	Scura, non riflettente 26 cm di diametro	Ceramica diametro 8 cm, altezza 5 cm	Scura, non riflettente 28 cm di diametro







11.3 Tabelle di cottura per gli istituti di test

Informazioni per gli istituti di test







Test in conformità alla norma IEC 60350-1.

				 (°C)	 (min.)	
Tortine, 20 per teglia	Cottura convenzionale	Lamiera dolci	3	170	20 - 30	-
Tortine, 20 per teglia	Cottura ventilata	Lamiera dolci	3	150 - 160	20 - 35	-

CONSIGLI E SUGGERIMENTI UTILI

				 (°C)	 (min.)	
Tortine, 20 per teglia	Cottura ventilata	Lamiera dolci	2 e 4	150 - 160	20 - 35	-
Torta di mele americana, 2 stampi Ø20 cm	Cottura convenzio- nale	Ripiano a filo	2	180	70 - 90	-
Torta di mele americana, 2 stampi Ø20 cm	Cottura ventilata	Ripiano a filo	2	160	70 - 90	-
Pan di Spagna, stampo per torta Ø26 cm	Cottura convenzio- nale	Ripiano a filo	2	170	40 - 50	Preriscaldare il forno per 10 minu- ti.
Pan di Spagna, stampo per torta Ø26 cm	Cottura ventilata	Ripiano a filo	2	160	40 - 50	Preriscaldare il forno per 10 minu- ti.
Pan di Spagna, stampo per torta Ø26 cm	Cottura ventilata	Ripiano a filo	2 e 4	160	40 - 60	Preriscaldare il forno per 10 minu- ti.
Frollini al burro	Cottura ventilata	Lamiera dolci	3	140 - 150	20 - 40	-
Frollini al burro	Cottura ventilata	Lamiera dolci	2 e 4	140 - 150	25 - 45	-

PULIZIA E CURA

				 (°C)	 (min.)	
Frollini al burro	Cottura convenzionale	Lamiera dolci	3	140 - 150	25 - 45	-
Toast, 4 - 6 pezzi	Grill	Ripiano a filo	4	max	2 - 3 minuti sul primo lato; 2 - 3 minuti sul secondo lato	Preriscaldare il forno per 3 minuti.
Hamburger di manzo, 6 pezzi, 0,6 kg	Grill	Su ripiano a filo e leccarda	4	max	20 - 30	Sistemare il ripiano a filo sul quarto livello e la leccarda sul terzo livello del forno. A metà cottura girare gli alimenti. Preriscaldare il forno per 3 minuti.

12. PULIZIA E CURA





AVVERTENZA!

Fare riferimento ai capitoli sulla sicurezza.

12.1 Note sulla pulizia

 Agenti di pulizia	Pulire la parte anteriore del forno con un panno morbido imbevuto di acqua tiepida e detergente delicato.
	Servirsi di una soluzione detergente per pulire le superfici metalliche.
	Pulire le macchie con un detergente delicato.

 Usò quotidiano	<p>Pulire la cavità dopo ogni utilizzo. L'accumulo di grasso o di altri residui potrebbe causare un incendio.</p>
	<p>L'umidità può formare condensa nel forno o sui pannelli di vetro dello sportello. Per ridurre la condensa, mettere in funzione il forno 10 minuti prima di iniziare a cucinare. Non lasciare le vivande nel forno per più di 20 minuti. Asciugare la cavità con un panno morbido dopo ogni uso.</p>

 Accessori	<p>Pulire tutti gli accessori dopo ogni uso e lasciarli asciugare. Utilizzare un panno morbido imbevuto di acqua tiepida e un detergente delicato. Non pulire gli accessori in lavastoviglie.</p>
	<p>Non pulire gli accessori anti-aderenti con agenti abrasivi o oggetti appuntiti.</p>

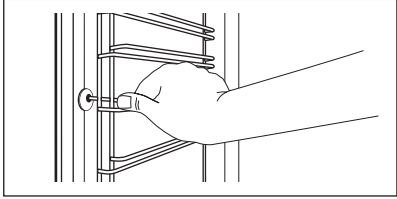
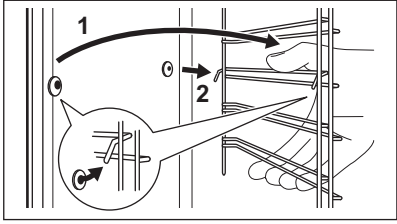

12.2 Come rimuovere: Supporti del ripiano

Rimuovere i supporti ripiano per pulire il forno.

Pas-saggio 1	<p>Spegnerò il forno e attendere che si raffreddi.</p>	
Pas-saggio 2	<p>Sfilare dapprima la guida di estrazione dalla parete laterale tirandola in avanti.</p>	
Pas-saggio 3	<p>Estrarre la parte posteriore del supporto ripiano dalla parete laterale e rimuoverla.</p>	
Pas-saggio 4	<p>Installare i supporti ripiani seguendo al contrario la procedura indicata.</p>	

12.3 Istruzioni d'uso: Pulizia per pirolisi

Pulire il forno con Pulizia per pirolisi.



	<p>AVVERTENZA! Rischio di ustioni.</p>
	<p>ATTENZIONE! Se nello stesso armadietto sono installate altre apparecchiature, non utilizzarle allo stesso tempo di questa funzione. Il forno potrebbe subire danni.</p>

PULIZIA E CURA

Prima della Pulizia per pirolisi:

Spegnere il forno e attendere che si raffreddi.	Rimuovere tutti gli accessori.	Pulire la base del forno e il vetro interno dello sportello con acqua calda, un panno morbido e un detergente delicato.
---	--------------------------------	---

Pulizia per pirolisi

Passaggio 1	Accedere al menu: Pulizia  .	
Opzione	Durata	
C1 - Pulizia leggera	1 h	
C2 - Pulizia normale	1 h 30 min	
C3 - Pulizia completa	2 h 30 min	
Passaggio 2	OK - premere per selezionare il programma di pulizia.	
Passaggio 3	OK - premere per avviare la pulizia.	
Passaggio 4	Dopo la pulizia, ruotare la manopola delle funzioni di cottura sulla posizione di spento.	
 Durante la pulizia la lampadina del forno è spenta.		
Quando il forno raggiunge la temperatura impostata, lo sportello si blocca. Finché lo sportello non si sblocca il display indica:  .		

Al termine della pulizia:

Spegnere il forno e attendere che si raffreddi.	Pulire la cavità con un panno morbido.	Rimuovere il residuo dal basso della cavità.
---	--	--

12.4 Promemoria Pulizia

Il forno vi ricorda quando pulirlo con la pulizia pirolitica.	
 lampeggia sul display per 5 secondi dopo ogni sessione di cottura.	Per disattivare il promemoria inserire il Menu e selezionare Impostazioni, Promemoria Pulizia.

12.5 Procedura di rimozione e installazione: Sportello

La porta del forno ha tre pannelli in vetro. È possibile rimuovere la porta del forno e i pannelli in vetro interni per pulirli. Leggere tutte le istruzioni "Rimozione e installazione della porta" prima di togliere i pannelli in vetro.

	ATTENZIONE! Non utilizzare il forno senza i pannelli in vetro.
--	--

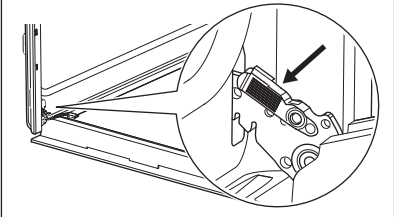
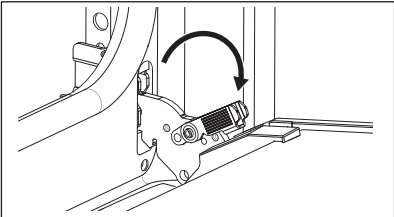
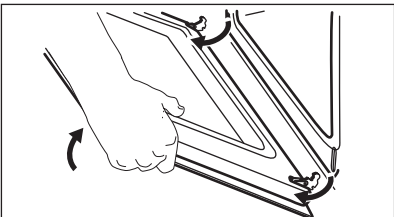
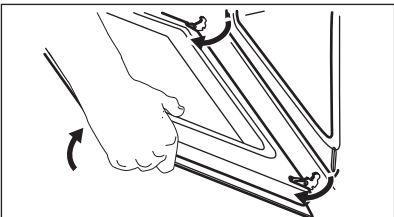
Pas-saggio 1	Aprire completamente la porta e tenere le due cerniere.	
Pas-saggio 2	Sollevare e tirare i fermi fino a quando non fanno clic.	
Pas-saggio 3	Chiudere la porta del forno fino alla prima posizione di apertura. Quindi sollevare e tirare per rimuovere la porta dalla sua sede.	
Pas-saggio 4	Appoggiare la porta su un panno morbido su una superficie stabile.	

PULIZIA E CURA

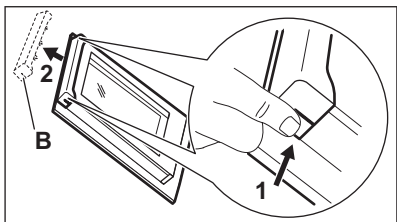
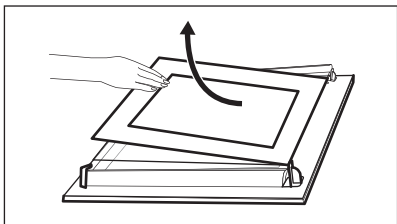
Pas-saggio 5	Tenere il rivestimento della porta (B) sul bordo superiore della porta da entrambi i lati e spingere verso l'interno per sbloccare la guarnizione a clip.	
Pas-saggio 6	Rimuovere il rivestimento tirandolo in avanti.	
Pas-saggio 7	Tenere i pannelli in vetro della porta per l'estremità superiore ed estrarli con attenzione, uno alla volta. Iniziare dal pannello superiore. Verificare che il vetro scorra completamente fino a uscire dai supporti.	
Pas-saggio 8	Pulire i pannelli in vetro con acqua e sapone. Asciugare accuratamente i pannelli in vetro. Non pulire i pannelli in vetro in lavastoviglie.	
Pas-saggio 9	Al termine della pulizia installare i pannelli in vetro e la porta del forno.	
Se la porta è installata correttamente, si sentirà uno clic quando si chiudono i fermi.		

Assicurarsi di rimontare i pannelli in vetro (A e B) nell'ordine esatto. Controllare il simbolo / la stampa sul lato del pannello in vetro, ciascuno dei pannelli in vetro è diverso per semplificare le operazioni di smontaggio e montaggio.
 Se installato correttamente, il profilo della porta emette un clic.
 Assicurarsi di installare correttamente nelle sedi il pannello in vetro centrale.

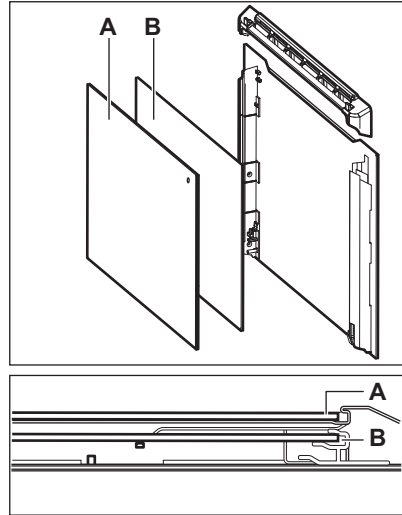

12.6 Come sostituire: Lampadina



AVVERTENZA!

Pericolo di scosse elettriche.
 La lampada potrebbe essere calda.

Tenere sempre la lampadina alogena con uno straccio, per evitare che dei residui di grasso vi brucino sopra.

Prima di sostituire la lampadina:		
Passagio 1	Passagio 2	Passagio 3
Spegnere il forno. Attendere che il forno sia freddo.	Estrarre la spina dalla presa di corrente.	Appoggiare un panno sul fondo della cavità.

Lampadina posteriore

Pas-saggio 1	Girare il rivestimento di vetro per toglierlo.
Pas-saggio 2	Pulire il coperchio in vetro.

RISOLUZIONE DEI PROBLEMI

Pas-saggio 3	Sostituire la lampadina con una resistente al calore fino a 300 °C.
Pas-saggio 4	Installare il coperchio in vetro.

13. RISOLUZIONE DEI PROBLEMI



AVVERTENZA!

Fare riferimento ai capitoli sulla sicurezza.

13.1 Cosa fare se...

Per tutti i casi non inclusi in questa tabella si prega di contattare un Centro di assistenza autorizzato.

Il forno non si accende o non riscalda	
Problema	Controllare se...
Non è possibile attivare il forno o metterlo in funzione.	Il forno è stato collegato correttamente all'alimentazione di rete.
Il forno non scalda.	Lo spegnimento automatico è disattivo.
Il forno non scalda.	La porta del forno è chiusa.
Il forno non scalda.	È saltato il fusibile.
Il forno non scalda.	La Sicurezza bambini è disattivata.

Componenti	
Problema	Controllare se...
La spia è spenta.	Cottura ventilata umida - è acceso.
La lampadina non funziona.	La lampadina è bruciata.

Codici di errore	
Il display visualizza...	Controllare se...

Codici di errore	
Err C3	La porta del forno è chiusa o il blocco della porta non è rotto.
Err F102	La porta del forno è chiusa.
Err F102	Il blocco della porta non è rotto.
00:00	Si è verificata un'interruzione dell'alimentazione elettrica. Impostare l'ora.
Il display mostra un codice di errore non presente nella tabella. Disattivare e riattivare il fusibile domestico e riavviare il forno. In caso di ricomparsa del codice di errore, contattare il Centro di assistenza autorizzato.	

13.2 Dati dell'Assistenza

Qualora non sia possibile trovare una soluzione al problema, contattare il rivenditore o un Centro di assistenza autorizzato.

Le informazioni necessarie per il Centro Assistenza si trovano sulla targhetta dei dati. La targhetta si trova sul telaio anteriore della cavità del forno. Non rimuovere la targhetta dei dati dalla cavità del forno.

Consigliamo di annotare i dati qui:	
Modello (Mod.)
Codice prodotto (PNC)
Numero di serie (S.N.)

14. EFFICIENZA ENERGETICA

14.1 Informazioni sul prodotto e scheda informativa sul prodotto*

Nome del fornitore	Electrolux
Identificazione modello	EOF4P46X 949498237 EOF6P46X 949498239
Indice di efficienza energetica	81.2
Classe di efficienza energetica	A+

Consumo energetico con carico standard, modalità tradizionale	0.93 kWh/ciclo	
Consumo di energia con un carico standard, modalità a circolazione d'aria forzata	0.69 kWh/ciclo	
Numero di cavità	1	
Fonte di calore	Elettricità	
Volume	72 l	
Tipo di forno	Forno da incasso	
Massa	EOF4P46X	29.5 kg
	EOF6P46X	31.6 kg

* Per l'Unione europea secondo i regolamenti UE 65/2014 e 66/2014.
 Per la Repubblica di Bielorussia ai sensi di STB 2478-2017, appendice G; STB 2477-2017, allegati A e B.
 Per l'Ucraina secondo 568/32020.

La classe di efficienza energetica non è applicabile alla Russia.

EN 60350-1 - Apparecchiature elettriche per la cottura per uso domestico - Parte 1: Cucine, forni, forni a vapore e griglie - Metodi per la misura delle prestazioni.

14.2 Risparmio energetico



Il forno è dotato di funzioni che contribuiscono al risparmio energetico durante le operazioni di cottura di tutti i giorni.

Verificare che la porta del forno sia chiusa quando lo stesso è in funzione. Non aprire la porta del forno con eccessiva frequenza in fase di cottura. Tenere pulita la guarnizione della porta e assicurarsi che sia ben fissata nella posizione corretta.

Servirsi di pentole in metallo per migliorare il risparmio energetico.

Ove possibile, non pre-riscaldare il forno prima della cottura.

Ridurre quanto più possibile gli intervalli fra le diverse operazioni di cottura quando vengono preparati più piatti contemporaneamente.

Cucinare con ventola

Ove possibile, servirsi delle funzioni di cottura con la ventola per risparmiare energia.

Calore residuo

La ventola e la lampada continuano a funzionare. Quando si spegne il forno, il display visualizza il calore residuo. Si può usare quel calore per mantenere le pietanze in caldo.

Quando la durata di cottura è superiore ai 30 minuti, ridurre la temperatura del forno al minimo 3-10 minuti prima della fine del processo di cottura. La cottura proseguirà grazie al calore residuo all'interno del forno.

Utilizzare il calore residuo per scaldare altri piatti.

Tenere in caldo gli alimenti

Scegliere l'impostazione di temperatura più bassa per sfruttare il calore residuo e mantenere calda la pietanza. La spia di calore residuo o la temperatura compaiono sul display.

Cottura con lampada spenta

Spegnere la lampada in fase di cottura. Accenderla solo quando è necessario.

Cottura ventilata umida



Funzione progettata per risparmiare energia in fase di cottura.



Quando si utilizza questa funzione, la lampadina si spegne automaticamente dopo 30 secondi.







È possibile riaccendere la lampada, ma questa azione ridurrà i risparmi energetici previsti.

15. STRUTTURA DEL MENU

15.1 Menu

	 - selezionare per accedere alla Menu.
---	---

Menu struttura		
Cottura guidata 	Pulizia 	Impostazioni 



Passaggio 1	Passaggio 2	Passaggio 3	Passaggio 4	Passaggio 5
 	 OK	 O1 - O11	 OK	
Selezionare il Menu, Impostazioni.	Confermare l'impostazione.	Selezionare l'impostazione.	Confermare l'impostazione.	Regolare il valore e premere OK.

Impostazioni					
O1	Imposta ora	Modifica	O2	Luminosità	1 - 5
O3	Volume toni	1 - Bip 2 - Fare clic 3 - Segnale acustico spento	O4	Volume acustico	1 - 4

STRUTTURA DEL MENU

Impostazioni					
O5	Timer	On/Off	O6	Luce forno	On/Off
O7	Riscaldamento rapido	On/Off	O8	Promemoria Pulizia	On/Off
O9	Modalità demo	Codice di attivazione: 2468	O10	Versione software	Controllare
O11	Ripristino impostazioni iniziali di fabbrica	Sì / No			

16. CONSIDERAZIONI SULL'AMBIENTE

Riciclare i materiali con il simbolo . Buttare l'imballaggio negli appositi contenitori per il riciclaggio. Aiutare a proteggere l'ambiente e la salute umana e a riciclare rifiuti derivanti da apparecchiature elettriche ed elettroniche. Non smaltire le apparecchiature che riportano il simbolo  insieme ai normali rifiuti domestici. Portare il prodotto al punto di riciclaggio più vicino o contattare il comune di residenza.

PENSAMOS EN USTED

Gracias por adquirir un electrodoméstico Electrolux. Ha elegido un producto que lleva décadas de experiencia e innovación profesionales. Ingenioso y elegante, ha sido diseñado pensando en usted. Así pues, cada vez que lo utilice, puede tener la seguridad de que obtendrá siempre excelentes resultados.

Le damos la bienvenida a Electrolux.

Visite nuestro sitio web para:



Obtener consejos, folletos, soluciones a problemas e información de servicio y reparación:

www.electrolux.com/support



Registrar su producto para recibir un mejor servicio:

www.registerelectrolux.com



Comprar accesorios, artículos de consumo y piezas de recambio originales para su aparato:

www.electrolux.com/shop



Para más recetas, consejos y resolución de problemas, descargue la aplicación **My Electrolux Kitchen**.



ATENCIÓN AL CLIENTE Y SERVICIO

Le recomendamos que utilice recambios originales.

Cuando se ponga en contacto con nuestro Centro de servicio técnico, asegúrese de tener los siguientes datos disponibles: Modelo, código numérico del producto (PNC), número de serie. La información se encuentra en la placa de características.

 Advertencia / Precaución - Información sobre seguridad

 Información general y consejos

 Información relativa al medioambiente

Salvo modificaciones.

CONTENIDO

1. INFORMACIÓN SOBRE SEGURIDAD... 156	2.5 Limpieza Pirolytica..... 161
1.1 Seguridad de niños y personas vulnerables..... 156	2.6 Iluminación interna..... 162
1.2 Instrucciones generales de seguridad..... 157	2.7 Asistencia técnica..... 162
2. INSTRUCCIONES DE SEGURIDAD..... 158	2.8 Eliminación..... 162
2.1 Instalación..... 158	3. INSTALACIÓN..... 163
2.2 Conexión eléctrica..... 159	3.1 Empotrado..... 163
2.3 Uso..... 160	3.2 Fijación del horno al mueble..... 164
2.4 Mantenimiento y limpieza..... 161	4. DESCRIPCIÓN DEL PRODUCTO..... 165
	4.1 Resumen general..... 165

4.2 Accesorios.....	165	10.3 Ventilador de enfriamiento.....	179
5. CÓMO ENCENDER Y APAGAR EL HORNO.....	165	11. CONSEJOS.....	179
5.1 Mandos escamoteables.....	165	11.1 Horneado húmedo + ventilador.....	179
5.2 Panel de mandos.....	166	11.2 Horneado húmedo + ventilador - accesorios recomendados.....	181
6. ANTES DEL PRIMER USO.....	167	11.3 Tablas de cocción para organismos de control.....	181
6.1 Limpieza inicial.....	167	12. MANTENIMIENTO Y LIMPIEZA.....	183
6.2 Pre calentamiento inicial.....	167	12.1 Notas sobre la limpieza.....	184
7. USO DIARIO.....	167	12.2 Cómo quitar: Carriles de apoyo	184
7.1 Cómo ajustar: Funciones de cocción.....	167	12.3 Instrucciones de uso: Limpieza pirolítica.....	185
7.2 Funciones de cocción.....	168	12.4 Aviso de limpieza.....	186
7.3 Notas sobre: Horneado húmedo + ventilador.....	169	12.5 Cómo quitar e instalar: Puerta... 186	
7.4 Cómo ajustar: Cocción asistida... 169		12.6 Cómo cambiar: Bombilla.....	188
7.5 Cocción asistida.....	170	13. SOLUCIÓN DE PROBLEMAS.....	189
8. FUNCIONES DEL RELOJ.....	175	13.1 Qué hacer si.....	189
8.1 Funciones de reloj.....	175	13.2 Datos de servicio.....	190
8.2 Cómo ajustar: Funciones de reloj 175		14. EFICACIA ENERGÉTICA.....	190
9. INSTRUCCIONES DE USO: ACCESORIOS.....	177	14.1 Información del producto y hoja de información del producto*.....	190
9.1 Inserción de accesorios.....	177	14.2 Ahorro energético.....	191
10. FUNCIONES ADICIONALES.....	178	15. ESTRUCTURA DEL MENÚ.....	192
10.1 Bloqueo.....	178	15.1 Menú.....	192
10.2 Desconexión automática.....	178	16. ASPECTOS MEDIOAMBIENTALES.....	193

1. ⚠ INFORMACIÓN SOBRE SEGURIDAD

Antes de instalar y utilizar el aparato, lea atentamente las instrucciones facilitadas. El fabricante no se hace responsable de lesiones o daños producidos como resultado de una instalación o un uso incorrectos. Conserve siempre estas instrucciones en lugar seguro y accesible para futuras consultas.

1.1 Seguridad de niños y personas vulnerables

- Este aparato puede ser utilizado por niños de 8 años en adelante y personas cuyas capacidades físicas, sensoriales o mentales estén disminuidas o que carezcan de la

experiencia y conocimientos suficientes para manejarlo, siempre que cuenten con las instrucciones o la supervisión sobre el uso del electrodoméstico de forma segura y comprendan los riesgos. Es necesario mantener alejados del aparato a los niños de menos de 8 años, así como a las personas con minusvalías importantes y complejas, salvo que estén bajo supervisión continua.

- Es necesario vigilar a los niños para que no jueguen con el aparato.
- Mantenga todo el material de embalaje fuera del alcance de los niños y deséchelo de forma adecuada.
- **ADVERTENCIA:** El horno y las piezas accesibles se calientan mucho durante el funcionamiento. Mantenga a los niños y las mascotas alejados del aparato cuando esté en uso y cuando se enfríe.
- Si este aparato tiene un bloqueo de seguridad para niños, debe activarlo.
- La limpieza y mantenimiento de usuario del producto no podrán ser realizados por niños sin supervisión.

1.2 Instrucciones generales de seguridad

- Este aparato está diseñado exclusivamente para cocinar.
- Este aparato está diseñado para uso doméstico en interiores.
- Este aparato se puede utilizar en oficinas, habitaciones de hotel, habitaciones de Bed&Breakfast, casas de campo y otros alojamientos similares donde dicho uso no exceda (en promedio) los niveles de uso doméstico.
- Solo un electricista cualificado puede instalar este aparato y sustituir el cable.
- No utilice el aparato antes de instalarlo en la estructura empotrada.
- Desenchufe el aparato de la red eléctrica antes de realizar tareas de mantenimiento.

INSTRUCCIONES DE SEGURIDAD

- Si el cable de alimentación sufre algún daño, el fabricante, su servicio técnico autorizado o un profesional tendrán que cambiarlo para evitar riesgos.
- **ADVERTENCIA:** Asegúrese de que el aparato está apagado antes de cambiar la bombilla para evitar el riesgo de descarga eléctrica.
- **ADVERTENCIA:** El horno y las piezas accesibles se calientan mucho durante el funcionamiento. Preste mucha atención para no tocar las resistencias.
- Utilizar siempre guantes o manoplas para horno para retirar o introducir accesorios o recipientes.
- Para retirar los carriles de apoyo, tire primero del frontal del carril y, a continuación, separe el extremo trasero de las paredes laterales. Instale los carriles de apoyo en el orden inverso.
- No utilice un limpiador a vapor para limpiar el aparato.
- No utilice productos de limpieza abrasivos ásperos ni rascadores de metal afilado para limpiar el cristal de las tapas abisagradas de la placa si no quiere arañar su superficie, lo que podría hacer que el cristal se hiciese añicos.
- Antes de la limpieza pirolítica, retirar todos los accesorios y cualquier depósito/derrames que haya en el interior del horno.

2. INSTRUCCIONES DE SEGURIDAD

2.1 Instalación

**ADVERTENCIA!**

Sólo un técnico cualificado puede instalar el aparato.

- Retire todo el embalaje.
- No instale ni utilice un aparato dañado.
- Siga las instrucciones de instalación suministradas con el aparato.
- Tenga cuidado al mover el aparato, porque es pesado. Utilice siempre guantes de protección y calzado cerrado.
- No tire nunca del aparato sujetando el asa.
- Instale el aparato en un lugar seguro y adecuado que cumpla los requisitos de instalación.

INSTRUCCIONES DE SEGURIDAD

- Respete siempre la distancia mínima entre el aparato y los demás electrodomésticos y mobiliario.
- Antes de montar el aparato, compruebe si la puerta del horno se abre sin limitaciones.
- El aparato está equipado con un sistema de refrigeración eléctrica. Debe utilizarse con la fuente de alimentación eléctrica.

Altura mínima del armario (Altura mínima del armario debajo de la encimera)	580 (600) mm
Ancho del armario	560 mm
Profundidad del armario	550 (550) mm
Altura de la parte frontal del aparato	589 mm
Altura de la parte trasera del aparato	571 mm
Anchura de la parte frontal del aparato	595 mm
Anchura de la parte trasera del aparato	559 mm
Fondo del aparato	569 mm
Fondo empotrado del aparato	548 mm
Fondo con la puerta abierta	1022 mm
Tamaño mínimo de la abertura de ventilación. Abertura situada en la parte trasera inferior	560x20 mm
Longitud del cable de alimentación. El cable está en la esquina derecha de la parte trasera	1500 mm
Tornillos de montaje	4x25 mm

2.2 Conexión eléctrica



ADVERTENCIA!

Riesgo de incendios y descargas eléctricas.

- Todas las conexiones eléctricas deben realizarlas electricistas cualificados.
- El aparato debe conectarse a tierra.
- Asegúrese de que los parámetros de la placa de características son compatibles con los valores eléctricos del suministro eléctrico.
- Utilice siempre una toma con aislamiento de conexión a tierra correctamente instalada.
- No utilice adaptadores de enchufes múltiples ni cables prolongadores.

INSTRUCCIONES DE SEGURIDAD

- Asegúrese de no provocar daños en el enchufe ni en el cable de red. Si es necesario cambiar el cable de alimentación del aparato, debe hacerlo el centro de servicio técnico autorizado.
- Evite que el cable de red toque o entre en contacto con la puerta del aparato o con el hueco por debajo del aparato, especialmente mientras funciona o si la puerta está caliente.
- Los mecanismos de protección contra descargas eléctricas de componentes con corriente y aislados deben fijarse de forma que no puedan aflojarse sin utilizar herramientas.
- Conecte el enchufe a la toma de corriente únicamente cuando haya terminado la instalación. Asegúrese de tener acceso al enchufe del suministro de red una vez finalizada la instalación.
- Si la toma de corriente está floja, no conecte el enchufe.
- No desconecte el aparato tirando del cable de conexión a la red. Tire siempre del enchufe.
- Use únicamente dispositivos de aislamiento apropiados: línea con protección contra los cortocircuitos, fusibles (tipo tornillo que puedan retirarse del soporte), dispositivos de fuga a tierra y contactores.
- La instalación eléctrica debe tener un dispositivo de aislamiento que permita desconectar el aparato de todos los polos de la red. El dispositivo de aislamiento debe tener una apertura de contacto con una anchura mínima de 3 mm.
- Cierre completamente la puerta del aparato antes de enchufar el cable de alimentación a la toma de corriente.
- El aparato se suministra con enchufe y cable de red.

Tipos de cables aplicables para su instalación o cambio para Europa:

H07 RN-F, H05 RN-F, H05 RRF, H05 VV-F, H05 V2V2-F (T90), H05 BB-F

Para la sección del cable, consulte la potencia total de la placa de características. También puede consultar la tabla:

Potencia total (W)	Sección del cable (mm ²)
máximo 1380	3 x 0.75
máximo 2300	3 x 1
máximo 3680	3 x 1.5

El cable de tierra (cable verde/amarillo) debe ser 2 cm más largo que los cables de fase y neutro (cables azul y marrón).

2.3 Uso



ADVERTENCIA!

Riesgo de lesiones, quemaduras y descargas eléctricas o explosiones.

- No cambie las especificaciones de este aparato.
- Asegúrese de que las aberturas de ventilación no están bloqueadas.
- No deje el aparato desatendido durante el funcionamiento.
- Apague el aparato después de cada uso.

- Tenga cuidado al abrir la puerta del aparato mientras funciona. Puede liberarse aire caliente.
- No utilice el aparato con las manos mojadas ni con agua en contacto.
- No ejerza presión sobre la puerta abierta.
- No utilice el aparato como superficie de trabajo ni para depositar objetos.
- Abra la puerta del aparato con cuidado. El uso de ingredientes con alcohol puede provocar una mezcla de alcohol y aire.
- No deje que los chispas ni las llamas abiertas entren en contacto con el aparato cuando abra la puerta.
- No coloque productos inflamables o artículos mojados con productos inflamables dentro, cerca o sobre el aparato.

**ADVERTENCIA!**

Podría dañar el aparato.

- Para evitar daños o decoloraciones en el esmalte:
 - no coloque recipientes ni otros objetos directamente en la base.
 - no coloque papel de aluminio directamente en la parte inferior del interior del aparato.
 - no ponga agua directamente en el aparato caliente.
 - no deje platos húmedos ni alimentos en el aparato una vez finalizada la cocción.
 - tenga cuidado al retirar o instalar los accesorios.
- La pérdida de color del esmalte o el acero inoxidable no afecta al rendimiento del aparato.
- Utilice una bandeja honda para pasteles húmedos. Los jugos de las frutas provocan manchas permanentes.
- Cocina siempre con la puerta del aparato cerrada.
- Si el aparato se instala detrás de un panel de un mueble (por ejemplo una puerta) asegúrese de que la puerta nunca esté cerrada mientras funciona el aparato. El calor y la humedad pueden acumularse detrás de un panel del armario cerrado y provocar daños al aparato, el alojamiento o el suelo. No cierre del panel del armario hasta que el aparato se haya enfriado completamente después de su uso.

2.4 Mantenimiento y limpieza

**ADVERTENCIA!**

Existe riesgo de lesiones, incendios o daños al aparato.

- Antes de proceder con el mantenimiento, apague el aparato y desconecte el enchufe de la red.
- Asegúrese de que el aparato esté frío. Los paneles de cristal pueden romperse.
- Cambie inmediatamente los paneles de cristal de la puerta que estén dañados. Póngase en contacto con el servicio técnico autorizado.
- Tenga cuidado al desmontar la puerta del aparato. ¡La puerta es muy pesada!
- Limpie periódicamente el aparato para evitar el deterioro del material de la superficie.
- Limpie el aparato con un paño suave humedecido. Utilice solo detergentes neutros. No utilice productos abrasivos, estropajos duros, disolventes ni objetos metálicos.
- Si utiliza aerosoles de limpieza para hornos, siga las instrucciones de seguridad del envase.

2.5 Limpieza Piroclítica

**ADVERTENCIA!**

Riesgo de lesiones / Incendios / Emisiones químicas (humos) en el modo piroclítico.

INSTRUCCIONES DE SEGURIDAD

- Antes de realizar una autolimpieza pirolítica o la función de Primer uso, elimine de la cavidad del horno:
 - cualquier resto de comida, aceite o grasa.
 - todos los objetos desmontables (incluidos estantes, carriles laterales, etc. suministrados con el producto), en especial todos los recipientes, sartenes, bandejas, utensilios, etc. antiadherentes.
- Lea atentamente todas las instrucciones de la limpieza pirolítica.
- Mantenga a los niños alejados del aparato cuando se realiza la limpieza pirolítica. El aparato alcanza altas temperaturas y se libera aire caliente de las salidas de ventilación delanteras.
- La limpieza pirolítica es una operación a alta temperatura que puede liberar humos de los residuos de cocción y de los materiales de fabricación, por lo que recomendamos encarecidamente a los consumidores:
 - asegurar una correcta ventilación durante y después de cada limpieza pirolítica.
 - asegurar una correcta ventilación durante y después del primer uso a máxima temperatura.
- A diferencia de los seres humanos, algunas aves y algunos reptiles pueden ser muy sensibles a los posibles humos emitidos durante la limpieza de todos los hornos pirolíticos.
 - Retire cualquier mascota (especialmente pájaros) de las proximidades del aparato durante y después de la limpieza pirolítica y use primero la temperatura máxima para una zona bien ventilada.
- Las mascotas de pequeño tamaño también pueden ser muy sensibles a los cambios de temperatura localizados cerca de los hornos mientras se realiza el programa de autolimpieza pirolítica.
- Las superficies antiadherentes de recipientes, sartenes, bandejas, utensilios, etc., pueden dañarse por las altas temperaturas de la limpieza pirolítica y también pueden ser fuente de humos dañinos de baja intensidad.
- Los humos emitidos por todos los hornos pirolíticos y residuos de cocción descritos no son dañinos para las personas, incluidos los niños, o personas con problemas médicos.

2.6 Iluminación interna



ADVERTENCIA!

Riesgo de descarga eléctrica.

- En cuanto a la(s) bombilla(s) de este producto y las de repuesto vendidas por separado: Estas bombillas están destinadas a soportar condiciones físicas extremas en los aparatos domésticos, como la temperatura, la vibración, la humedad, o están destinadas a señalar información sobre el estado de funcionamiento del aparato. No están destinadas a utilizarse en otras aplicaciones y no son adecuadas para la iluminación de estancias domésticas.
- Este producto contiene una fuente luminosa de la clase de eficiencia energética G.
- Utilice solo bombillas de las mismas características .

2.7 Asistencia técnica

- Para reparar el aparato, póngase en contacto con el centro de servicio autorizado.
- Utilice solamente piezas de recambio originales.

2.8 Eliminación



ADVERTENCIA!

Existe riesgo de lesiones o asfixia.

- Contacte con las autoridades locales para saber cómo desechar correctamente el aparato.
- Desconecte el aparato de la red.
- Corte el cable eléctrico cerca del aparato y deséchelo.
- Retire el pestillo de la puerta para evitar que los niños o las mascotas queden atrapados en el aparato.

3. INSTALACIÓN



ADVERTENCIA!

Consulte los capítulos sobre seguridad.

3.1 Empotrado



YouTube

www.youtube.com/electrolux
www.youtube.com/aeg

How to install your AEG/Electrolux
Oven - Column installation

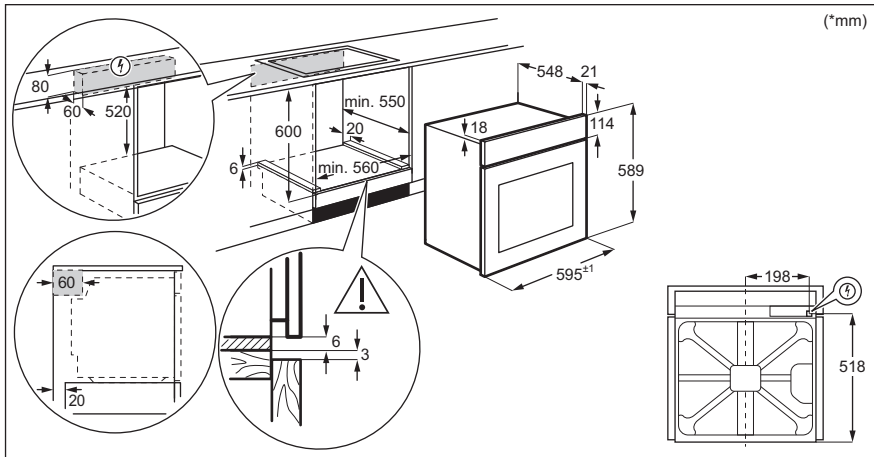

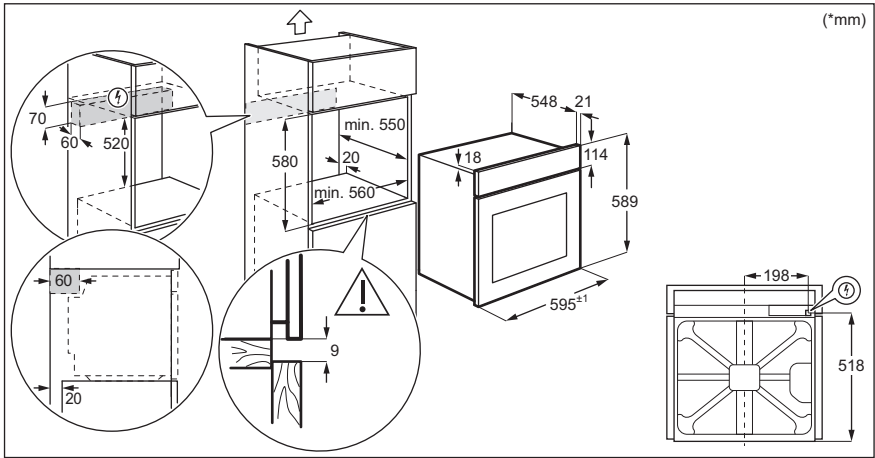

3.2 Fijación del horno al mueble

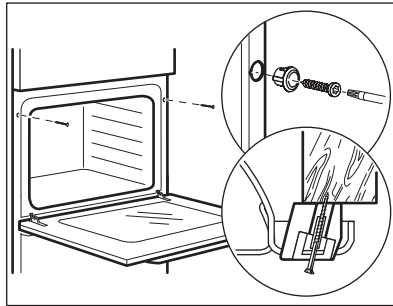

4. DESCRIPCIÓN DEL PRODUCTO

4.1 Resumen general

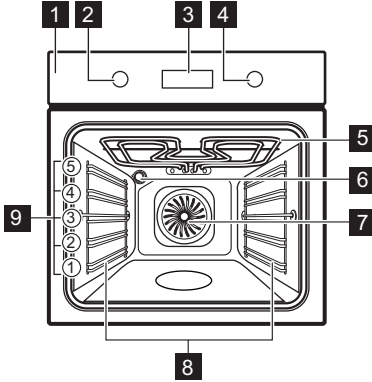

- 1** Panel de mandos
- 2** Mando de las funciones de cocción
- 3** Pantalla
- 4** Mando de control
- 5** Resistencia
- 6** Bombilla
- 7** Ventilador
- 8** Soporte de parrilla extraíble
- 9** Posiciones de las parrillas

4.2 Accesorios

- **Parrilla**
Para utensilios de cocina, moldes de pastelería, asados.
- **Bandeja**
Para bizcochos y galletas.
- **Parrilla/sartén para asar**
Para hornear y asar o como bandeja para grasa.







5. CÓMO ENCENDER Y APAGAR EL HORNO

5.1 Mandos escamoteables

Para usar el aparato, presione el mando. El mando sale del alojamiento.



CÓMO ENCENDER Y APAGAR EL HORNO







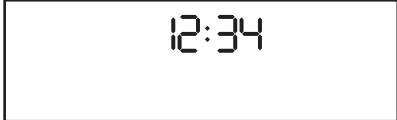

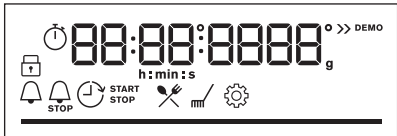
5.2 Panel de mandos

Sensores del panel de control					Pulse	Gire el mando
 Temporizador	 Calentamiento rápido	 Luz	 Bloqueo	OK		

Seleccione una función de cocción para encender el horno.

Gire el mando de las funciones de cocción hasta la posición de apagado para apagar el horno.

	Quando el mando de las funciones de cocción se encuentra en la posición de apagado, la pantalla cambia al modo de espera.
	Al cocinar, la pantalla muestra la temperatura, la hora y otras opciones disponibles.
	Pantalla con el máximo número de funciones seleccionadas.

Indicadores de pantalla				
 Bloqueo	 Cocción asistida	 Limpieza	 Ajustes	 Calentamiento rápido
Indicadores de temporizador:				

Barra de progreso - para la temperatura o el tiempo.	
---	---

6. ANTES DEL PRIMER USO



ADVERTENCIA!

Consulte los capítulos sobre seguridad.

6.1 Limpieza inicial

Antes del primer uso, limpie el horno vacío y ajuste el tiempo:



00:00

Ajuste la hora. Pulse OK.

6.2 Pre calentamiento inicial

Pre caliente el horno vacío antes de utilizarlo por primera vez.

Paso 1 Retire todos los accesorios y carriles de apoyo extraíbles del horno.

Paso 2 Seleccione la temperatura máxima para la función: .
Deje funcionar el horno 1 hora.

Paso 3 Seleccione la temperatura máxima para la función: .
Deje funcionar el horno 15 minutos.

El horno puede emitir olores y humos durante el pre calentamiento. Asegúrese de que la sala esté ventilada.

7. USO DIARIO



ADVERTENCIA!



Consulte los capítulos sobre seguridad.

7.1 Cómo ajustar: Funciones de cocción

Empezar a cocinar







Paso 1





Paso 2

Empezar a cocinar	
	
<p>Seleccione una función de cocción.</p>	<p>Ajuste la temperatura.</p>

7.2 Funciones de cocción

Funciones de cocción estándar

Función de cocción	Aplicación
 <p>Aire caliente</p>	<p>Para hornear en hasta tres posiciones de parrilla a la vez y para secar alimentos. Ajuste la temperatura entre 20 y 40°C menos que para Cocción convencional.</p>
 <p>Cocción convencional</p>	<p>Para hornear y asar alimentos en una posición de parrilla.</p>
 <p>Congelados</p>	<p>Para productos precocinados (por ejemplo, patatas fritas, porciones de patata o rollitos de primavera) crujientes.</p>
 <p>Función Pizza</p>	<p>Para hornear pizza. Para obtener un dorado más intenso y una base más crujiente.</p>
 <p>Calor inferior</p>	<p>Para hornear pasteles con base crujiente y conservar alimentos.</p>
 <p>Descongelar</p>	<p>Para descongelar alimentos (verduras y frutas). El tiempo de descongelación depende de la cantidad y el tamaño de los alimentos congelados.</p>

Función de cocción	Aplicación
 <p>Horneado húmedo + ventilador</p>	<p>Función diseñada para ahorrar energía durante la cocción. Cuando se utiliza esta función, la temperatura del horno puede diferir de la temperatura programada. Se utiliza el calor residual. La potencia calorífica puede reducirse. Para más información, consulte el capítulo "Uso diario", Notas sobre: Horneado húmedo + ventilador.</p>
 <p>Grill</p>	<p>Para asar al grill alimentos de poco espesor y tostar pan.</p>
 <p>Grill turbo</p>	<p>Asado con aire caliente para piezas de carne más grandes o aves con hueso en un nivel. Para gratinar y dorar.</p>
 <p>Menú</p>	<p>Para acceder al menú: Cocción asistida, Limpieza, Ajustes.</p>

7.3 Notas sobre: Horneado húmedo + ventilador

Esta función se utilizaba para cumplir con los requisitos de eficiencia energética y diseño ecológico según EU 65/2014 y EU 66/2014. Pruebas conforme a EN 60350-1. La puerta del horno debe estar cerrada durante la cocción para que no se interrumpa la función y el horno funcione con la máxima eficiencia energética posible. Cuando se utiliza esta función, la lámpara se apaga automáticamente después de 30 s. Consulte las instrucciones de cocción en el capítulo "Consejos", Horneado húmedo + ventilador. Para recomendaciones generales sobre ahorro energético, consulte el capítulo "Eficiencia energética", ahorro energético.







7.4 Cómo ajustar: Cocción asistida

Para cada plato de este submenú se recomienda una función y temperatura. Puede ajustar la hora y la temperatura durante la cocción.



<p>Para algunos de los platos, también puede cocinar con:</p>	<ul style="list-style-type: none"> • Peso automático
---	---

Cocción asistida - utilícelo para preparar rápidamente un plato con los ajustes predeterminados:			
Paso 1	Paso 2	Paso 3	Paso 4





Cocción asistida - utilícelo para preparar rápidamente un plato con los ajustes predeterminados:











 	 	 P1 - P45	 OK
Acceda al menú.	Seleccionar Cocción asistida. Pulse OK .	Seleccione el plato. Pulse OK .	Introduzca el plato en el horno. Confirmar ajuste.













7.5 Cocción asistida





















Leyenda	
	Peso automático disponible.
	Precaliente el horno antes de empezar a cocinar.
	Nivel del estante.

















Cuando termine la función, compruebe si la comida está lista.





	Plato	Peso	Nivel/accesorio de la parrilla	Duración
Vacuno 				
P1	Rosbif, poco hecho	1 - 1,5 kg; piezas de 4 - 5 cm	 2 bandeja de hornear Fría la carne durante unos minutos en una sartén caliente. Introdúzcalo en el horno.	40 min
P2	Rosbif, al punto			50 min
P3	Rosbif, muy hecho			60 min
P4	Bistec, en su punto	180 - 220 g por pieza; rodajas de 3 cm de grosor	  3 fuente de asado encendida parrilla Fría la carne durante unos minutos en una sartén caliente. Introdúzcalo en el horno.	15 min

	Plato	Peso	Nivel/accesorio de la parrilla	Duración
P5	Asado de ternera/estofado (costillas de cebado, redondo superior, flanco grueso)	1,5 - 2 kg	  2 fuente de asado encendida parrilla Fría la carne durante unos minutos en una sartén caliente. Añada líquido. Introdúzcalo en el horno.	120 min
P6	Rosbif, poco hecho (cocción lenta)	1 - 1,5 kg; piezas de 4 - 5 cm	 2; bandeja Use sus condimentos favoritos o simplemente sal y pimienta con molienda fresca. Fría la carne durante unos minutos en una sartén caliente. Introdúzcalo en el horno.	75 min
P7	Rosbif, al punto (cocción lenta)			85 min
P8	Rosbif, muy hecho (cocción lenta)			130 min
P9	Filete poco hecho (cocción lenta)	0,5 - 1,5 kg; trozos de 5 - 6 cm	 2 bandeja de hornear Use sus condimentos favoritos o simplemente sal y pimienta con molienda fresca. Fría la carne durante unos minutos en una sartén caliente. Introdúzcalo en el horno.	75 min
P10	Filete, en su punto (cocción lenta)			90 min
P11	Filete hecho (cocción lenta)			120 min
Ternera 				
P12	Asado de ternera (por ejemplo, el hombro)	0,8 - 1,5 kg; piezas de 4 cm de grosor	  2 fuente de asado encendida parrilla Use sus especias favoritas. Añada líquido. Asado cubierto.	80 min
Cerdo  				
P13	Cerdo asado en el cuello o en el hombro	1,5 - 2 kg	  2 fuente de asado encendida parrilla Después de la mitad del tiempo de cocción, voltee la carne.	120 min

	Plato	Peso	Nivel/accesorio de la parrilla	Duración
P14	Cerdo desmigado (cocción lenta)	1,5 - 2 kg	 2 bandeja de hornear Use sus especias favoritas. Dé la vuelta a la carne a la mitad del tiempo de cocción para dorar uniformemente.	215 min
P15	Lomo, fresco	1 - 1,5 kg; trozos de 5 - 6 cm	 2 ; fuente de asado en laparrilla Use sus especias favoritas.	55 min
P16	Costillas	2 - 3 kg; utilice repuestos finos de 2 - 3 cm	 3 bandeja honda Añada líquido para cubrir la base de un plato. Después de la mitad del tiempo de cocción, voltee la carne.	90 min
Cordero 				
P17	Pierna de cordero con hueso	1,5 - 2 kg; piezas de 7 - 9 cm	 2 ; fuente de asado en la bandeja Añada líquido. Después de la mitad del tiempo de cocción, voltee la carne.	130 min
Aves 				
P18	Pollo entero	1 - 1,5 kg; fresco	  2 cazuela sobre bandeja de hornear Use sus especias favoritas. Dele la vuelta al pollo a la mitad del tiempo de cocción para obtener un dorado uniforme.	60 min
P19	Medio pollo	0,5 - 0,8 kg	 3 bandeja de hornear Use sus especias favoritas.	40 min
P20	Pechuga de pollo	180 - 200 g por pieza	  2 cazuela sobre parrilla Use sus especias favoritas. Fría la carne durante unos minutos en una sartén caliente.	25 min
P21	Muslos de pollo, frescos	-	 3 bandeja de hornear Si se marchan las patas de pollo marinadas, ajuste la temperatura más baja y cocínelas más tiempo.	30 min





	Plato	Peso	Nivel/accesorio de la parrilla	Duración
P22	Pato entero	2 - 3 kg	  2 fuente de asado encendida parrilla Use sus especias favoritas. Coloque la carne en la fuente. Dé la vuelta al pato a la mitad del tiempo de cocción.	100 min
P23	Ganso entero	4 - 5 kg	  2; bandeja honda Use sus especias favoritas. Coloque la carne en la bandeja honda. Dele la vuelta a la mitad del tiempo de cocción.	110 min
Otros 				
P24	Pastel de carne	1 kg	 2; parrilla Use sus especias favoritas.	60 min
Pescado 				
P25	Pescado entero, al grill	0,5 - 1 kg por pescado	 2 bandeja de hornear Llene el pescado con mantequilla y utilice sus especias y hierbas favoritas.	30 min
P26	Filete de pescado	-	  3 cazuela sobre parrilla Use sus especias favoritas.	20 min
Horneado/postres dulces   				
P27	Tarta de queso	-	 2;  molde desmontable de 28 cm en la parrilla	90 min
P28	Tarta de manzana	-	 3; bandeja	45 min
P29	Tarta de manzana	-	 2; forma de pastel en la parrilla	40 min
P30	Pastel de manzana	-	 1  pastel de 22 cm en parrilla	60 min
P31	Brownies	2 kg	 3 bandeja honda	30 min

	Plato	Peso	Nivel/accesorio de la parrilla	Duración
P32	Magdalenas de chocolate	-	 3 bandeja para magdalenas encendida parrilla	25 min
P33	Pastel de hogaza	-	 2; molde de pan en la parrilla	50 min
Verduras / Guarniciones   				
P34	Patatas al horno	1 kg	 2; bandeja Ponga las patatas enteras con piel en la bandeja.	50 min
P35	Aros	1 kg	 3 bandeja de hornear forrado con papel de hornear Use sus especias favoritas. Corte las patatas en trozos.	35 min
P36	Verduras al grill	1 - 1,5 kg	 3 bandeja de hornear forrado con papel de hornear Use sus especias favoritas. Corte las verduras en trozos.	30 min
P37	Croquetas congeladas	0,5 kg	 3; bandeja	25 min
P38	Pomos congelados	0,75 kg	 3; bandeja	25 min
Gratinados, pan y pizza   				
P39	Lasaña de carne/verdura con platos de fideos secos	1 - 1,5 kg	 2 cazuela sobre parrilla	45 min
P40	Patatas gratinadas (patatas crudas)	1 - 1,5 kg	 1 cazuela sobre parrilla Gire el plato transcurrida la mitad del tiempo de cocción.	50 min
P41	Pizza fresca y fina	-	  2 bandeja de hornear forrado con papel de hornear	15 min

	Plato	Peso	Nivel/accesorio de la parrilla	Duración
P42	Pizza fresca, gruesa	-	 2; bandeja forrada con papel de hornear	25 min
P43	Quiche	-	 2; molde de hornear en la parrilla	45 min
P44	Baguette / chapata / pan blanco	0,8 kg	 3 bandeja de hornear forrado con papel de hornear Se necesita más tiempo para el pan blanco.	30 min
P45	Todo el grano / centeno / pan oscuro de grano en molde de pan	1 kg	 2; bandeja forrada con papel de hornear/parrilla	60 min

8. FUNCIONES DEL RELOJ

8.1 Funciones de reloj

Función de reloj	Aplicación
	Avisador. Al finalizar el tiempo, sonará la señal acústica.
	Tiempo de cocción. Cuando el temporizador finaliza, suena la señal y la función de cocción se detiene.
	Tiempo de retardo. Para posponer el inicio y/o fin de la cocción.
	Tiempo de funcionamiento. El máximo es 23 h 59 min. Esta función no influye en el funcionamiento del horno. Para encender y apagar Tiempo de funcionamiento seleccione: Menú, Ajustes.

8.2 Cómo ajustar: Funciones de reloj





Cómo ajustar: Hora		
Paso 1	Paso 2	Paso 3

FUNCIONES DEL RELOJ

Cómo ajustar: Hora







		
Para cambiar la hora, acceda al menú y seleccione Ajustes, Hora.	Ajuste el reloj	Pulse: OK.

Cómo ajustar: Avisador

Paso 1	La pantalla muestra: 0:00 	Paso 2	Paso 3
			
Pulse: 		Ajustar la Avisador	Pulse: OK.

 El temporizador comienza la cuenta atrás inmediatamente.

Cómo ajustar: Tiempo de cocción

Paso 1	Paso 2	La pantalla muestra: 0:00  STOP	Paso 3	Paso 4
				
Elija una función de cocción y la temperatura.	Pulse repetidamente: 		Ajuste el tiempo de cocción.	Pulse: OK.

 El temporizador comienza la cuenta atrás inmediatamente.

INSTRUCCIONES DE USO: ACCESORIOS

Cómo ajustar: Tiempo de retardo							
Paso 1	Paso 2		Paso 3	Paso 4		Paso 5	Paso 6
		La pantalla muestra: la hora 🕒 INICIO			La pantalla muestra: --:-- 🕒 PA-RAR		
Seleccione la función de cocción.	Pulse repetidamente: 		Ajuste la hora de inicio.	Pulse: OK.		Ajuste la hora de fin.	Pulse: OK.
 El temporizador empieza a contar hacia atrás a una hora programada.							

9. INSTRUCCIONES DE USO: ACCESORIOS

9.1 Inserción de accesorios

Una pequeña muesca en la parte superior aumenta la seguridad. Las hendiduras también son dispositivos antivuelco. El borde elevado que rodea la bandeja evita que los utensilios de cocina resbalen de la parrilla.

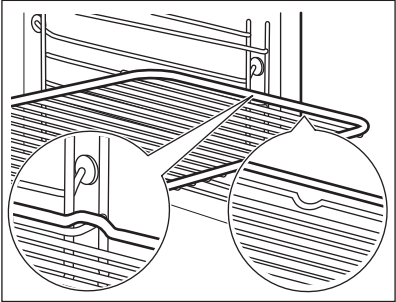
<p>Parrilla: Inserte la parrilla entre las guías del carril y asegúrese de que las hendiduras apunten hacia abajo.</p>	
--	--

FUNCIONES ADICIONALES

Bandeja / Bandeja honda:

Introduzca la bandeja entre las guías del carril de apoyo.

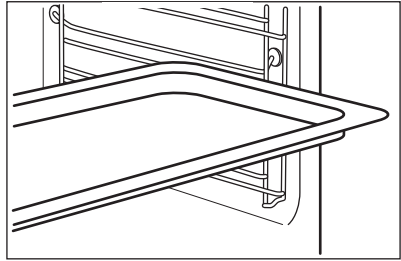

Parrilla, Bandeja / Bandeja honda:

Posicione la bandeja entre las guías del carril de apoyo y la parrilla en las guías de encima.

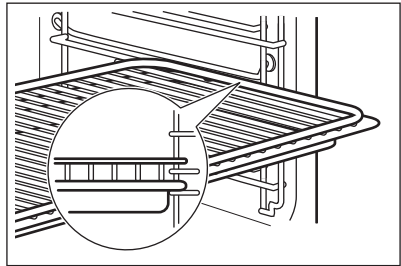

10. FUNCIONES ADICIONALES

10.1 Bloqueo

Esta función impide que se produzca accidentalmente un cambio de la función de horno.

Enciéndala cuando el horno funcione: la cocción ajustada continúa, el panel de control está bloqueado.

Enciéndala cuando el horno está apagado; el horno no se puede encender, el panel de control está bloqueado.



- mantenga pulsado para activar la función.
Suena una señal.





- mantenga pulsado para apagarla.

 3 x  - parpadea cuando se enciende el bloqueo.

10.2 Desconexión automática

Por motivos de seguridad, el horno se desactiva transcurrido un tiempo si una función de cocción está en funcionamiento y no se modifica ningún ajuste.

 (°C)	 (h)
30 - 115	12.5
120 - 195	8.5
200 - 245	5.5
250 - máximo	3

La función de desconexión automática no funciona con las siguientes funciones: Luz, Tiempo de retardo.





10.3 Ventilador de enfriamiento

Cuando el horno funciona, el ventilador de enfriamiento se pone en marcha automáticamente para mantener frías las superficies del horno. Una vez apagado el horno, el ventilador sigue funcionando hasta enfriarlo totalmente.





11. CONSEJOS





11.1 Horneado húmedo + ventilador

Para obtener el mejor resultado, siga las recomendaciones de la tabla siguiente.

		 (°C)		 (min)
Rollitos dulces, 16 piezas	bandeja o bandeja honda	180	2	20 - 30
Rollitos, 9 piezas	bandeja o bandeja honda	180	2	30 - 40
Pizza congelada, 0,35 kg	parrilla	220	2	10 - 15
Brazo de gitano	bandeja o bandeja honda	170	2	25 - 35
Brownie	bandeja o bandeja honda	175	3	25 - 30
Soufflé, 6 piezas	ramekin cerámico sobre parrilla	200	3	25 - 30



CONSEJOS

		 (°C)		 (min)
Base de masa brisé	molde de base sobre parrilla	180	2	15 - 25
Tarta Victoria	bandeja de hornear sobre parrilla	170	2	40 - 50
Pescado pochado, 0,3 kg	bandeja o bandeja honda	180	3	20 - 25
Pescado entero, 0,2 kg	bandeja o bandeja honda	180	3	25 - 35
Filete de pescado, 0,3 kg	molde para pizza sobre parrilla	180	3	25 - 30
Carne pochada, 0,25 kg	bandeja o bandeja honda	200	3	35 - 45
Shashlik, 0,5 kg	bandeja o bandeja honda	200	3	25 - 30
Galletas, 16 piezas	bandeja o bandeja honda	180	2	20 - 30
Mostachones de almendra, 24 piezas	bandeja o bandeja honda	180	2	25 - 35
Muffins, 12 piezas	bandeja o bandeja honda	170	2	30 - 40
Tarta salada, 20 piezas	bandeja o bandeja honda	180	2	25 - 30
Galletas crujientes de masa quebrada, 20 piezas	bandeja o bandeja honda	150	2	25 - 35
Tartaletas, 8 piezas	bandeja o bandeja honda	170	2	20 - 30
Verduras pochadas, 0,4 kg	bandeja o bandeja honda	180	3	35 - 45

		 (°C)		 (min)
Tortilla vegetariana	molde para pizza sobre parrilla	200	3	25 - 30
Verduras mediterráneas, 0,7 kg	bandeja o bandeja honda	180	4	25 - 30

11.2 Horneado húmedo + ventilador - accesorios recomendados

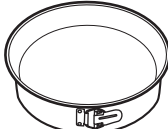





Utilice molde y recipientes oscuros y mates. Tiene mejor absorción del calor que los platos de color claro y brillantes.

			
Bandeja para pizza	Bandeja para hornear	Ramequines	Molde para base
Oscuro, mate 28 cm de diámetro	Oscuro, mate 26 cm de diámetro	Cerámica 8 cm de diámetro, 5 cm de altura	Oscuro, mate 28 cm de diámetro







11.3 Tablas de cocción para organismos de control

Información para institutos de pruebas







Pruebas realizadas de conformidad con IEC 60350-1.

				 (°C)	 (min)	
Pastelillos, 20 unidades por bandeja	Cocción convencional	Bandeja	3	170	20 - 30	-

CONSEJOS

				 (°C)	 (min)	
Pastelillos, 20 unidades por bandeja	Aire caliente	Bandeja	3	150 - 160	20 - 35	-
Pastelillos, 20 unidades por bandeja	Aire caliente	Bandeja	2 y 4	150 - 160	20 - 35	-
Tarta de manzana, 2 moldes, Ø 20 cm	Cocción convencional	Parrilla	2	180	70 - 90	-
Tarta de manzana, 2 moldes, Ø 20 cm	Aire caliente	Parrilla	2	160	70 - 90	-
Bizcocho, molde de repostería Ø26 cm	Cocción convencional	Parrilla	2	170	40 - 50	Precaliente el horno 10 minutos.
Bizcocho, molde de repostería Ø26 cm	Aire caliente	Parrilla	2	160	40 - 50	Precaliente el horno 10 minutos.
Bizcocho, molde de repostería Ø26 cm	Aire caliente	Parrilla	2 y 4	160	40 - 60	Precaliente el horno 10 minutos.

MANTENIMIENTO Y LIMPIEZA

				 (°C)	 (min)	
Mantecados	Aire caliente	Bandeja	3	140 - 150	20 - 40	-
Mantecados	Aire caliente	Bandeja	2 y 4	140 - 150	25 - 45	-
Mantecados	Cocción convencional	Bandeja	3	140 - 150	25 - 45	-
Tostadas, 4 - 6 trozos	Grill	Parrilla	4	máx.	2 - 3 minutos el primer lado; 2 - 3 minutos el segundo	Precale el horno 3 minutos.
Hamburguesa de vacuno, 6 trozos, 0,6 kg	Grill	Parrilla y grasera	4	máx.	20 - 30	Coloque la parrilla en el cuarto nivel y la grasera en el tercer nivel del horno. De la vuelta a la comida a la mitad del tiempo de cocción. Precale el horno 3 minutos.



12. MANTENIMIENTO Y LIMPIEZA



ADVERTENCIA!

Consulte los capítulos sobre seguridad.

12.1 Notas sobre la limpieza

 <p>Agentes limpiadores</p>	<p>Limpie la parte delantera del horno con un paño suave humedecido en agua templada y jabón suave.</p>
	<p>Utilice un producto de limpieza para limpiar las superficies metálicas.</p>
	<p>Limpie las manchas con un detergente suave.</p>
 <p>Uso diario</p>	<p>Limpie el interior después de cada uso. La acumulación de grasa u otros residuos puede provocar un incendio.</p>
	<p>La humedad puede llegar a condensarse en el horno o en los paneles de cristal. Para reducir la condensación, ponga en funcionamiento el horno 10 minutos antes de cocinar. No guarde la comida en el horno más de 20 minutos. Seque el interior con un paño suave después de cada uso.</p>
 <p>Accesorios</p>	<p>Limpie todos los accesorios después de cada uso y déjelos secar. Use un paño suave humedecido en agua caliente y detergente suave. No lave los accesorios en el lavavajillas.</p>
	<p>No limpie los accesorios no adherentes utilizando un limpiador abrasivo ni objetos afilados.</p>

12.2 Cómo quitar: Carriles de apoyo

Para limpiar el horno, retire los carriles de apoyo.

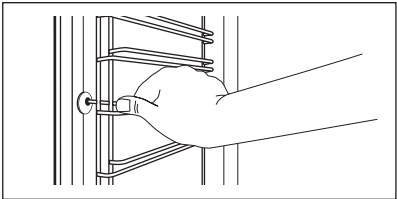
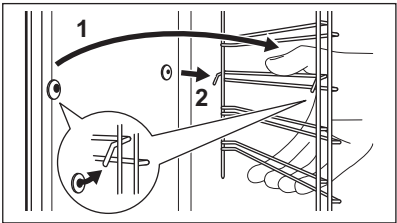
Paso 1	Apague el horno y espere a que esté frío.	
Paso 2	Tire de la parte delantera del carril de apoyo para separarlo de la pared lateral.	
Paso 3	Tire del extremo trasero del carril de apoyo para separarlo de la pared y extráigalo.	
Paso 4	Instale los carriles de apoyo en el orden inverso.	

12.3 Instrucciones de uso: Limpieza pirolítica

Limpie el horno con Limpieza pirolítica.



ADVERTENCIA!

Existe riesgo de quemaduras.





PRECAUCIÓN!

Si hay otros aparatos instalados en el mismo armario, no los utilice al mismo tiempo que esta función. El horno podría dañarse.

Antes de Limpieza pirolítica:

Apague el horno y espere a que esté frío.	Retire todos los accesorios del horno.	Limpie el suelo del horno y la puerta interior de cristal con agua templada, un paño suave y detergente suave.
---	--	--

Limpieza pirolítica

Paso 1	Acceda al menú: Limpieza  .	
	Opción	Duración
	C1 - Limpieza ligera	1 h
	C2 - Limpieza normal	1 h 30 min
	C3 - Limpieza a fondo	2 h 30 min
Paso 2	OK: pulse para seleccionar el programa de limpieza.	
Paso 3	OK - pulse para comenzar la limpieza.	
Paso 4	Tras la limpieza, gire el mando de las funciones de cocción hasta la posición de apagado.	
 Durante la limpieza, la bombilla del horno está apagada.		
Cuando el horno alcanza la temperatura programada, la puerta se bloquea. Hasta que la puerta se abra, la pantalla mostrará:  .		

Cuando termina la limpieza:

Apague el horno y espere a que esté frío.	Seque el interior con un paño suave.	Retire los residuos de la parte inferior del interior.
---	--------------------------------------	--

12.4 Aviso de limpieza

El horno le recuerda que debe limpiarlo con la limpieza pirolítica.

 parpadea en la pantalla durante 5 segundos después de cada sesión de cocción.	Para desactivar el aviso, pulse la tecla Menú y seleccione Ajustes, Aviso de limpieza.
---	--

12.5 Cómo quitar e instalar: Puerta

La puerta del horno tiene tres paneles de cristal. Puedes retirar la puerta del horno y los paneles internos de cristal para limpiarlos. Lee enteramente las instrucciones de "Extracción e instalación de la puerta" antes de retirar los paneles de cristal.



PRECAUCIÓN!

No utilices el horno sin los paneles de cristal.

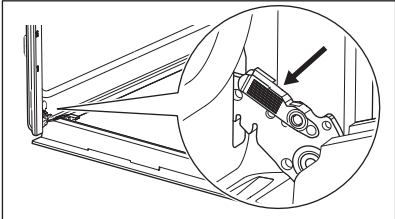
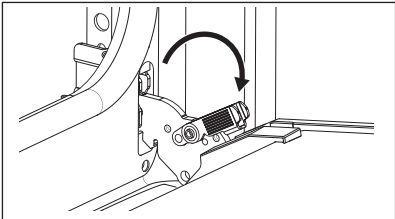
Paso 1	Abra completamente la puerta y sujete las dos bisagras.	
Paso 2	Levanta y tira de los pestillos hasta que hagan clic.	

MANTENIMIENTO Y LIMPIEZA

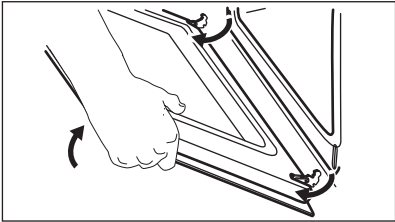
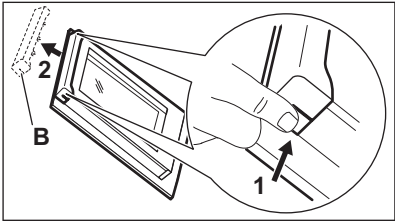
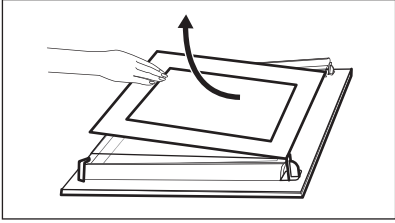
Paso 3	Cierre la puerta del horno hasta la primera posición de apertura (a mitad de camino). A continuación, levanta y tira de la puerta para extraerla de su sitio.	
Paso 4	Coloque la puerta sobre un paño suave en una superficie estable.	
Paso 5	Sujete el marco de la puerta (B) por el borde superior de la puerta por ambos lados y empuje hacia dentro para soltar el cierre.	
Paso 6	Tire del borde del acabado de la puerta hacia delante para desengancharla.	
Paso 7	Sujeta los paneles de cristal de la puerta por el borde superior y tira con cuidado de ellos uno a uno. Empieza por el panel superior. Asegúrese de que el cristal se desliza completamente fuera de los soportes.	
Paso 8	Limpie los paneles de cristal con agua y jabón. Seque cuidadosamente los paneles de cristal con cuidado. No limpie los paneles de cristal en el lavavajillas.	
Paso 9	Después de la limpieza, instala el panel de cristal y la puerta del horno.	
Si la puerta está instalada correctamente, oírás un clic al cerrar los pestillos.		

Asegúrate de volver a colocar los paneles de cristal (A y B) en el orden correcto. Compruebe el símbolo/la ilustración del lado del panel de cristal, cada uno de los paneles de cristal es distinto para facilitar el montaje y desmontaje.

Al instalarlo correctamente, el acabado de la puerta hace clic.

Asegúrese de que coloca correctamente el panel de cristal intermedio en los puntos de sujeción adecuados.

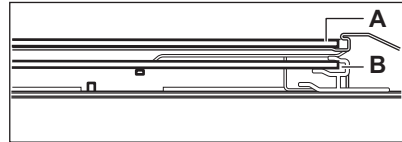
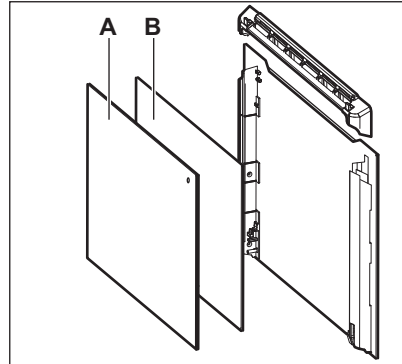

12.6 Cómo cambiar: Bombilla



ADVERTENCIA!

Riesgo de descarga eléctrica.
La lámpara puede estar caliente.

Coja siempre la bombilla halógena con un paño para evitar quemar los residuos de grasa.

Antes de reemplazar la bombilla:

Paso 1	Paso 2	Paso 3
Apague el horno. Espere hasta que el horno esté frío.	Desconecte el horno de la red.	Coloque un paño en el fondo de la cavidad.

Bombilla trasera

Paso 1	Gire la tapa de cristal para extraerla.
Paso 2	Limpié la tapa de cristal.
Paso 3	Cambie la bombilla por otra apropiada termorresistente hasta 300 °C.
Paso 4	Instale la tapa de cristal.

13. SOLUCIÓN DE PROBLEMAS



ADVERTENCIA!

Consulte los capítulos sobre seguridad.

13.1 Qué hacer si...

En cualquier caso no incluido en esta tabla, por favor contacte con un Centro de Servicio Autorizado.

El horno no se enciende o no se calienta	
Problema	Compruebe que...
La placa no se enciende o no funciona.	La batidora está bien conectada a la red eléctrica.
El horno no se calienta.	El apagado automático está desactivado.
El horno no se calienta.	La puerta del horno está cerrada.
El horno no se calienta.	No ha saltado el fusible.
El horno no se calienta.	El bloqueo de seguridad para niños está desactivado.

Componentes	
Problema	Compruebe que...
La bombilla está apagada.	Horneado húmedo + ventilador - está encendido.
La bombilla no funciona.	La bombilla se ha fundido.

Código de error	
La pantalla muestra...	Compruebe que...
Err C3	La puerta del horno está cerrada o el cierre de la puerta no está roto.
F102	La puerta del horno está cerrada.
F102	El cierre de la puerta no está roto.

EFICACIA ENERGÉTICA

Código de error	
00:00	Se ha producido un corte de corriente. Ajuste la hora.
Si la pantalla muestra un código de error que no está en esta tabla, apague y encienda el fusible de la vivienda para reiniciar el horno. Si el código de error se repite, contacte con un Centro de servicio autorizado.	

13.2 Datos de servicio

Si no logra subsanar el problema, póngase en contacto con su distribuidor o un centro de servicio técnico autorizado.

Los datos que necesita para el Centro de servicio técnico se encuentran en la placa de características. La placa de características se encuentra en el marco delantero del interior del horno. No retire la placa de características de la cavidad del horno.

Se recomienda escribir los datos aquí:	
Modelo (MOD):
Número de producto (PNC)
Número de serie (S.N.)

14. EFICACIA ENERGÉTICA

14.1 Información del producto y hoja de información del producto*

Nombre del proveedor	Electrolux
Identificación del modelo	EOF4P46X 949498237 EOF6P46X 949498239
Índice de eficiencia energética	81.2
Clase de eficiencia energética	A+
Consumo de energía con una carga estándar, modo convencional	0.93 kWh/ciclo
Consumo de energía con una carga estándar, modo de ventilador forzado	0.69 kWh/ciclo

Número de cavidades	1	
Fuente de energía	Electricidad	
Volumen	72 L	
Tipo de horno	Horno empotrable	
Masa	EOF4P46X	29.5 kg
	EOF6P46X	31.6 kg

* Para la Unión Europea según los Reglamentos de la UE 65/2014 y 66/2014.
 Para la República de Bielorrusia según STB 2478-2017, apéndice G; STB 2477-2017, anexos A y B.
 Para Ucrania según 568/32020.

La clase de eficiencia energética no es aplicable a Rusia.

EN 60350-1 - Aparatos electrodomésticos de cocción - Parte 1: Gamas, hornos, hornos de vapor y grills - Métodos de medida del rendimiento.

14.2 Ahorro energético



El horno tiene características que le ayudan a ahorrar energía durante la cocina de cada día.

Asegúrese de que la puerta del horno está cerrada cuando el horno funciona. No abra la puerta del horno muchas veces durante la cocción. Mantenga limpia la junta de la puerta y asegúrese de que está bien fijada en su posición.

Utilice utensilios de cocina de metal para mejorar el ahorro energético.

En la medida de lo posible, no precaliente el horno antes de cocinar.

Reduzca al máximo el tiempo entre horneados cuando prepare varios platos de una vez.

Cocción con ventilador

En la medida de lo posible, utilice las funciones de cocción con ventilador para ahorrar energía.

Calor residual

La bombilla y el ventilador siguen funcionando. Al apagar el horno la pantalla mostrará el calor residual. El calor puede emplearse para mantener caliente los alimentos.

Para una duración de la cocción superior a 30 minutos, reduzca la temperatura del horno un mínimo de 3 - 10 minutos antes de que transcurra el tiempo de cocción. El calor residual dentro del horno seguirá cocinando.

Utilice el calor residual para calentar otros platos.

Mantener calientes los alimentos

Si desea utilizar el calor residual para mantener calientes los alimentos, seleccione el ajuste de temperatura más bajo posible. El indicador de calor residual o la temperatura aparecen en la pantalla.

Cocción con la bombilla apagada

Apague la luz mientras cocina. Enciéndala únicamente cuando la necesite.

ESTRUCTURA DEL MENÚ



Horneado húmedo + ventilador



Función diseñada para ahorrar energía durante la cocción.







Cuando utilice esta función, la lámpara se apagará automáticamente después de 30 segundos. Puede volver a encender la luz, pero de este modo reducirá el ahorro energético esperado.

15. ESTRUCTURA DEL MENÚ

15.1 Menú

	 - seleccione para acceder al Menú.
---	--



Menú estructura		
Cocción asistida 	Limpieza 	Ajustes 

Paso 1	Paso 2	Paso 3	Paso 4	Paso 5
 	 OK	 O1 - O11	 OK	
Seleccione la Menú, Ajustes.	Confirmar ajuste.	Seleccione el ajuste.	Confirmar ajuste.	Ajuste el valor y pulse OK.

Ajustes					
O1	Hora	Cambiar	O2	Brillo de la pantalla	1 - 5
O3	Tono de teclas	1 - Pitido 2 - Haga clic 3 - Sonido apagado	O4	Volumen del timbre	1 - 4
O5	Tiempo de funcionamiento	Encendido/ Apagado	O6	Luz	Encendido/ Apagado
O7	Calentamiento rápido	Encendido/ Apagado	O8	Aviso de limpieza	Encendido/ Apagado

Ajustes					
O9	Modo demostración	Código de activación. 2468	O10	Versión del software	Comprobar
O11	Restaurar todos los ajustes	Sí / No			

16. ASPECTOS MEDIOAMBIENTALES

Recicle los materiales con el símbolo . Coloque el material de embalaje en los contenedores adecuados para su reciclaje. Ayude a proteger el medio ambiente y la salud pública, así como a reciclar residuos de aparatos eléctricos y electrónicos. No deseche los aparatos marcados con el símbolo  junto con los residuos domésticos. Lleve el producto a su centro de reciclaje local o póngase en contacto con su oficina municipal.

www.electrolux.com/shop



867369381-A-142022

