



Questo manuale d'istruzione è fornito da trovaprezzi.it. Scopri tutte le offerte per [Dji Osmo Action 5 Pro Standard Combo](#) o cerca il tuo prodotto tra le [migliori offerte di Videocamere Digitali](#)



Questo manuale d'istruzione è fornito da trovaprezzi.it. Scopri tutte le offerte per [Dji Osmo Action 5 Standard Combo](#) o cerca il tuo prodotto tra le [migliori offerte di Videocamere Digitali](#)

dji OSMO ACTION 5 PRO

User Manual

v1.0 2024.09

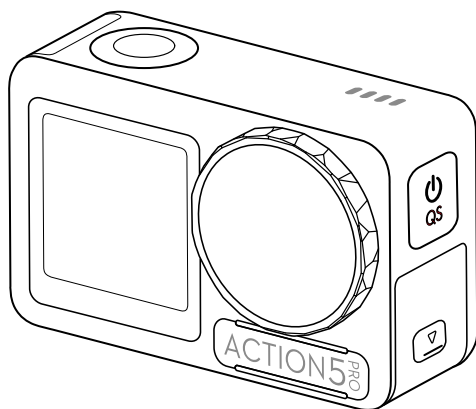



This document is copyrighted by DJI with all rights reserved. Unless otherwise authorized by “DJI”, you are not eligible to use or allow others to use the document or any part of the document by reproducing, transferring, or selling the document. Users should only refer to this document and the content thereof as instructions to operate DJI products. The document should not be used for other purposes.

Searching for Keywords

Search for keywords such as Battery or Install to find a topic. If you are using Adobe Acrobat Reader to read this document, press Ctrl+F on Windows or Command+F on Mac to begin a search.

Navigating to a Topic

View a complete list of topics in the table of contents. Click on a topic to navigate to that section.

Printing this Document

This document supports high resolution printing.

Using this Manual

Legend

Important

Hints and Tips

Reference

Read Before Use

DJI™ provides you with tutorial videos and the following documents:

1. *Safety Guidelines*
2. *Quick Start Guide*
3. *User Manual*

It is recommended to watch all the tutorial videos and read the *Safety Guidelines* before using for the first time. Make sure to review the *Quick Start Guide* before using for the first time and refer to this *User Manual* for more information.

Video Tutorials

Go to the address below or scan the QR code to watch the tutorial videos, which demonstrate how to use the product safely:

<https://www.dji.com/osmo-action-5-pro/video>

Downloading the DJI Mimo App

Scan the QR code to download the DJI Mimo App.



-
- To check the Android and iOS operating system versions supported by DJI Mimo visit <https://www.dji.com/downloads/djiapp/dji-mimo>.
 - The interface and functions of DJI Mimo may vary as the software version is updated. Actual user experience is based on the software version used.
-

Contents

Using this Manual	3
Legend	3
Read Before Use	3
Video Tutorials	3
Downloading the DJI Mimo App	3
1 Product Profile	8
1.1 Overview	8
1.2 Accessories	8
Osmo Action Curved Adhesive Base Kit	9
Osmo Action Horizontal-Vertical Protective Frame	9
Osmo Action Multifunctional Battery Case	10
2 Using for the First Time	13
2.1 Attaching the Battery	13
2.2 Inserting the microSD Card	13
2.3 Powering on	14
2.4 Activation	14
2.5 Charging the Battery	15
3 Basic Operations	17
3.1 Button Features	17
3.2 Operating the Touchscreen	17
3.3 Storing Photos and Videos	18
4 Using the Product	20
4.1 Setting the Shooting Parameters	20
4.2 Setting the Image Parameters	21
4.3 Setting the System Functions	21
4.4 Voice Control	22
4.5 Timecode	22
4.6 Highlight	22
4.7 Super Slow-Motion	23
4.8 Transferring Files	23
4.9 Connecting a Microphone	24
4.10 Webcam Mode	25
4.11 Depth & Altitude	25
5 Maintenance	27
5.1 Updating Firmware	27

5.2	Underwater Usage Notes	27
5.3	Cleaning Notes	28
5.4	Battery Usage Warnings	29
5.5	Using Other Accessories (Not Included)	30
	Osmo 1.5m Extension Rod	30
	Osmo Magnetic Ball-Joint Adapter Mount	31
	Osmo Action 60m Waterproof Case	31
	DJI Floating Handle	31
	Osmo Action Suction Cup Mount	32
	Osmo Action Helmet Chin Mount	32
	Osmo Action Chest Strap Mount	32
	Osmo Action Handlebar Mount	33
	Osmo Action GPS Bluetooth Remote Controller	33
	Osmo Action Multifunctional Charging Handle	34
	Osmo Action Cold Shoe Expansion Kit	34
6	Specifications	36

Product Profile

1 Product Profile

1.1 Overview

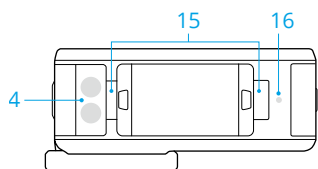
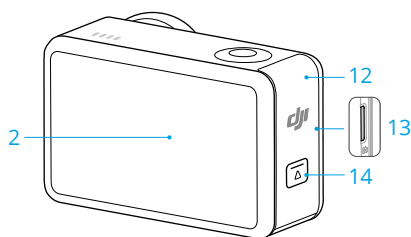
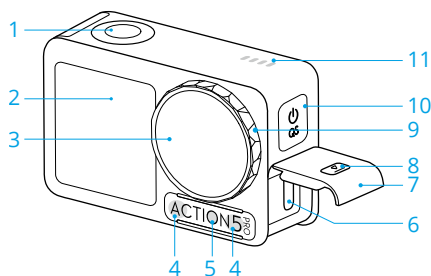

1. Shutter/Record Button
2. Touchscreen
3. Lens
4. Microphone
5. Color Temperature Sensor
6. USB-C Port
7. USB-C Port Cover
8. USB-C Port Cover Release Button
9. Lens Protective Cover
10. Quick Switch Button
11. Speaker
12. Battery Compartment Cover
13. microSD Card Slot
14. Battery Compartment Cover Release Button
15. Quick-Release Slot
16. Pressure Sensor

1.2 Accessories

The product is compatible with various accessories to dynamically adjust the position to shoot various sports scenes.

Osmo Action Curved Adhesive Base Kit

The camera can be securely mounted on smooth and clean curved surfaces using the curved adhesive base kit.

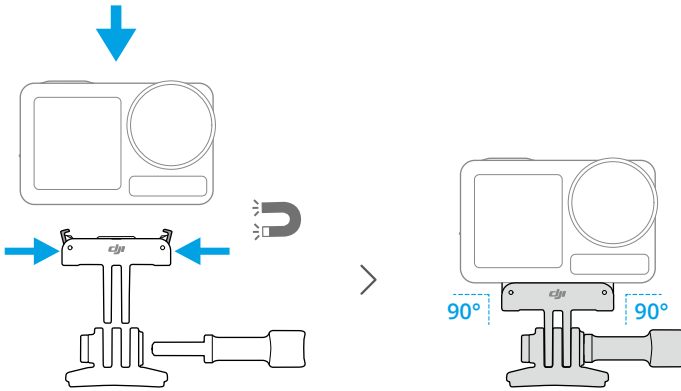

-
- ⚠ • Press down on the camera until the clips of the quick-release adapter mount are firmly inserted into the quick-release slots on the camera, and then tighten the locking screws. Press both clips of the quick-release adapter mount when removing the camera.
 - Attach and press the adhesive base down firmly, and hold for at least 10 seconds. It is recommended to wait 30 minutes before attaching the camera.
 - The adhesive base can only be applied to clean curved surfaces once. DO NOT attach the adhesive base to surfaces that are flat, rough, powdered, peeling, covered in dust or sand, or have oil, wax, or water stains. Otherwise, the adapter mount may not be attached firmly.
 - The recommended application temperature for the adhesive base is -10° to 40° C (14° to 104° F). DO NOT attach the adhesive base to a surface with a higher or lower temperature.
-

Osmo Action Horizontal-Vertical Protective Frame

With the horizontal-vertical protective frame, users can flip the camera from the horizontal to the vertical position for different shooting angles.

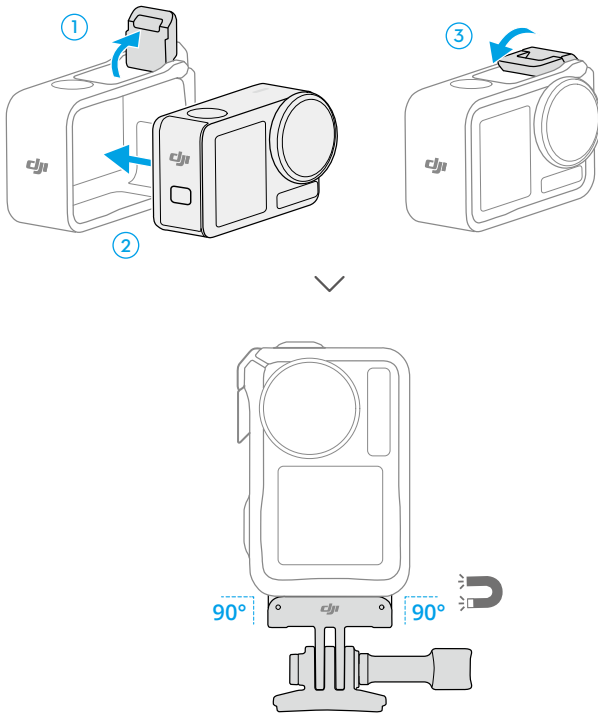

Osmo Action Multifunctional Battery Case

The Osmo Action Multifunctional Battery Case (hereinafter referred to as “the battery case”) is designed for storing batteries and microSD cards safely. Users can check the battery levels by pressing the button once or opening the battery case. The status LEDs will display the battery level.

When a charger is connected to the battery case with batteries inserted, the battery case will charge the batteries in sequence. The battery with the highest power level will be charged first.

When the batteries are inserted into the battery case, with external devices connected to the USB-C port, the batteries can be used as a power bank to charge the connected external devices. The battery with the lowest power level will be discharged first, followed by the remaining batteries to be discharged in sequence.

When using the battery case to charge the battery, it is recommended to use a USB-C charger that supports Power Delivery or PPS (Programmable Power Supply).

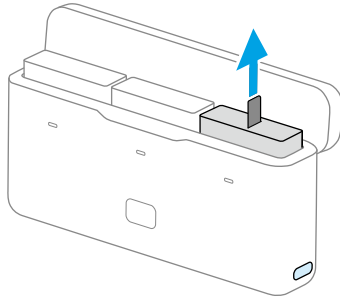

-
- ⚠ • Place the battery case on a flat and stable surface when in use. Make sure the device is properly insulated to prevent fire hazards.
- DO NOT touch the metal terminals on the battery ports.
 - Clean the metal terminals with a clean, dry cloth if there is any noticeable buildup.
 - The battery case is not waterproof. DO NOT place it in water or spill any liquid on the case.
-

Using for the First Time

2 Using for the First Time

2.1 Attaching the Battery

Press the release button on the battery compartment cover and slide upward, then insert the battery into the battery compartment. Make sure the battery is properly inserted, then close the battery compartment cover.

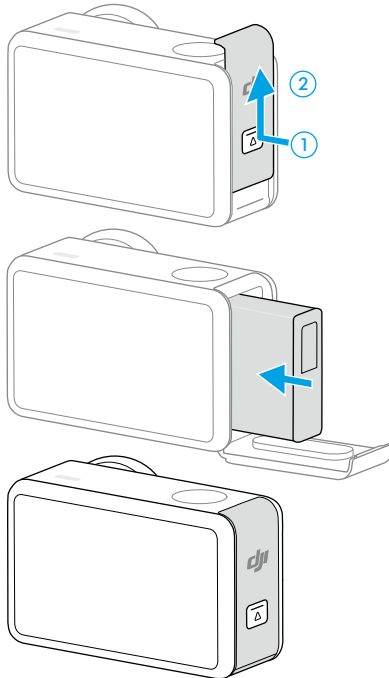

2.2 Inserting the microSD Card

The camera allows for extended storage capacity with microSD cards. Refer to the recommended microSD card list on the DJI website at <https://www.dji.com/osmo-action-5-pro/specs>.

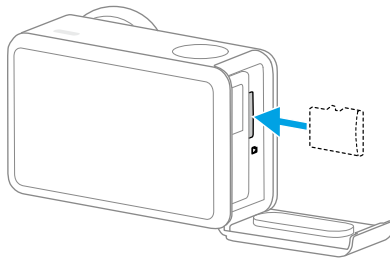

2.3 Powering on

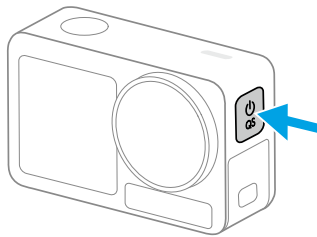

Press and hold the Quick Switch Button to power on. The SnapShot function on the camera is enabled by default.

SnapShot is the quickest way to start shooting and never miss a moment of the action. When the camera is off, you can quickly power it on and start shooting instantly in SnapShot mode by pressing and holding the Shutter/Record button. After shooting, the camera will automatically power off if left idle for three seconds.

Users can press and hold the Quick Switch button to power off.

2.4 Activation

Make sure to activate the camera using DJI Mimo before first use.

1. Press and hold the Quick Switch button to power on.
2. Enable Wi-Fi and Bluetooth on the mobile device.
3. Launch DJI Mimo on the mobile device, tap the camera icon to connect to the camera, and then follow the instructions to activate the camera.

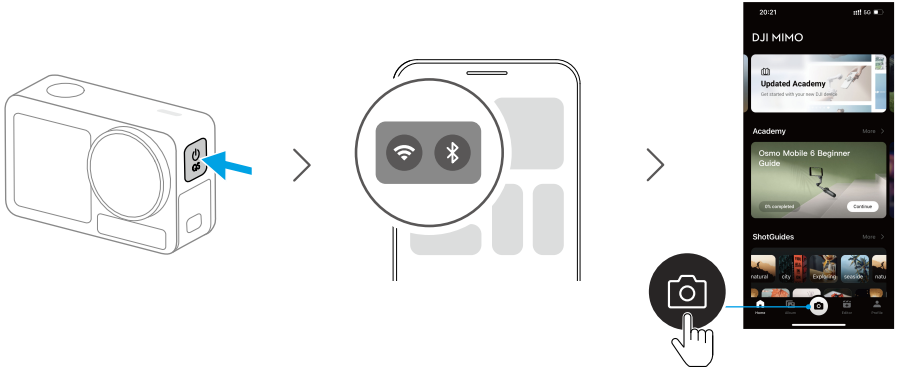

When the camera is used with the DJI Mimo app, you can monitor the current camera view, set the camera parameters, and control the camera with a mobile device. The DJI Mimo app enables you to get most out of the camera with a series of functions, such as transferring, editing, sharing files and livestreaming.



If there is a problem when connecting to DJI Mimo, follow the steps below:

1. Make sure both Wi-Fi and Bluetooth are enabled on the mobile device.
2. Make sure the DJI Mimo app has the latest firmware version.
3. Swipe down from the top of the screen to enter the control menu, select **Wireless Connection > Reset Connection**. The camera will reset all connections and Wi-Fi passwords.

2.5 Charging the Battery

It is recommended to use a USB-C charger that supports Power Delivery or PPS (Programmable Power Supply). When powered off, the status LEDs blink green while charging. When the status LEDs turn off, the battery is fully charged.

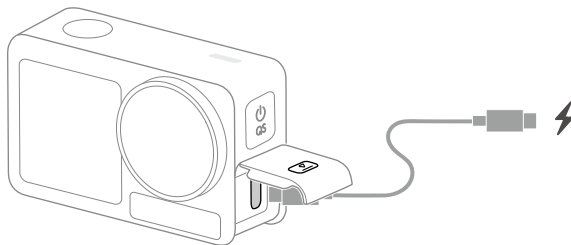

Basic Operations

3 Basic Operations

3.1 Button Features

Shutter/Record Button

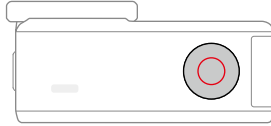

- Press once: Take a photo or start/stop recording.
- Press and hold when powered off: Power on quickly and begin shooting. The shooting mode will depend on the SnapShot settings. After shooting, the camera will automatically power off if left idle for three seconds.

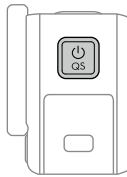

Quick Switch Button

- Press and hold: Power on/off.
- Press once: Switch between shooting modes. During video and slow-motion recording, press to mark a highlight moment in the footage, allowing to quickly locate specific shots during post-editing and reducing the time spent searching for highlights.

3.2 Operating the Touchscreen

After the camera is powered on, both touchscreens of the camera display the liveview as well as the shooting mode, battery level, and microSD card information. Tap or swipe on the touchscreen to interact with the camera.

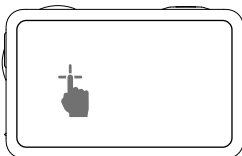

Tap

Select the icons on both sides of the screen to playback footage and change the camera settings.

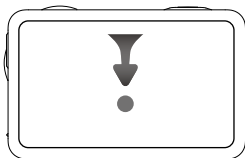

Swipe Down from the top of the Screen
Enters the control menu.

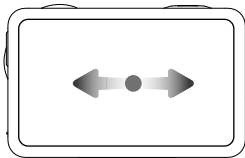

Swipe Left or Right
Switches between video, photo, and other shooting modes.

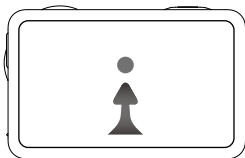

Swipe Up from the Bottom of the Screen
To set shooting parameters such as aspect ratio, count-down time, and resolution.

3.3 Storing Photos and Videos

Swipe down from the top of the screen, and then swipe left to check the storage information. With a microSD card inserted, all the images can be stored to the microSD card. Tap **Storage** to format the internal storage or the microSD card.

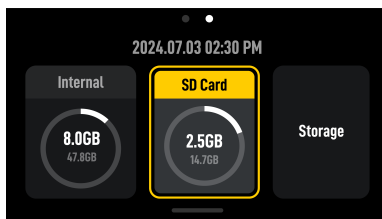

- 💡 • Formatting will permanently delete all data. Make sure to back up all required data before formatting.
-

Using the Product

4 Using the Product

4.1 Setting the Shooting Parameters

Swipe up from the bottom of the screen to set the parameters for each shooting mode. Various parameters can be set in different shooting modes.

Burst

Set the aspect ratio and burst rate (frames per second).

When the burst rate is set to Off, the camera only takes one photo.

With different aspect ratios selected, different burst rates (frames per second) can be set. At this time, the camera will quickly take multiple photos in succession, allowing users to select the best shot from a series of photos. This is ideal for capturing fast-moving subjects.

Pre-Rec and Loop Recording

In the video and SuperNight mode, tap the upper left corner to enable Pre-Rec or Loop Recording and set the time duration.

- **Pre-Rec:** When enabled, the camera will pre-record footage within the set time duration. Once the Shutter/Record button is pressed, the camera will save the latest pre-recorded footage before pressing the Shutter/Record button and keep recording, then save the footage as a whole video. This function allows the camera to save the footage before pressing the Shutter/Record button to avoid taking up too much space on the microSD card, helping capture highlights (especially for fishing).
- **Loop Recording:** When enabled, the camera records a video by overwriting older footage with new footage at selected time intervals. This function allows the camera to save space on the microSD card, and is suitable for use in scenes where the user is waiting to capture unanticipated highlights (such as driving).

EIS Mode

In the video and SuperNight mode, tap on the upper right corner to set the EIS mode.

- **Disabled:** When selected, record the video with the largest FOV.
- **RockSteady:** Stabilizes footage while retaining the dynamics of movement, which is suitable for first-person perspective shooting.
- **RockSteady+:** Compared with RockSteady, the edges of these images will be reduced slightly to obtain a stronger stabilization performance.
- **HorizonBalancing:** This mode reduces the shaking of images within $\pm 45^\circ$.
- **HorizonSteady:** This mode corrects shakes for any horizontal rotation (360°) and locks on the leveled horizon in every frame, regardless of how the camera is mounted or worn.

- To record videos with Gyro data, disable EIS mode and set the camera FOV to **Wide**.

4.2 Setting the Image Parameters

In the camera view, tap  to adjust the image and audio parameters. Tap PRO to adjust pro parameters.

Various parameters can be set in different shooting modes, such as the following:

- **Image Adjustment:** Users can adjust the texture and noise reduction based on their needs for optimal image quality.
- **Colors:** Normal 8bit, Normal 10bit, HLG 10bit, and D-Log M 10bit are available. HLG mode records with wide dynamic range and color gamut which can be displayed on an HLG-compatible TV or monitor. D-Log M is designed for professional color grading when post-editing. In high-contrast or multi-color scenarios (e.g., garden, field, etc.), it can enlarge the dynamic range for more color-grading in post-production. 10-bit color depth enables smoother color transition. With D-Log M selected, users can turn on Color Recovery to preview of the color effects in the liveview.
- **Audio Parameters:** Channel, Wind Noise Reduction, and Microphone are available. When Wind Noise Reduction is enabled, the camera will reduce the wind noise picked up by the built-in microphone using algorithms. Note that Wind Noise Reduction does not work when connected to the external microphone.

4.3 Setting the System Functions

Swipe down from the top of the screen to enter the control menu.

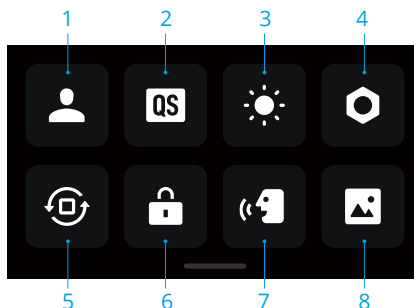

1. Custom Modes

Tap to create and manage custom modes. Custom modes can then be used directly to shoot similar scenes.

2. Quick Switch

Tap the icon to set Voice Prompt and set the modes accessible with the Quick Switch button. When Voice Prompt is enabled, the camera will broadcast the shooting mode when changing modes by pressing the the Quick Switch button. When the camera is installed on a helmet or other hard-to-see locations, users can accurately select the required mode with Voice Prompt.

3. Brightness

4. Settings

5. Orientation Lock

6. Screen Lock

7. Voice Control

8. Full Front Screen

4.4 Voice Control

Swipe down from the top of the screen to enter the control menu, tap , and select **Voice Control**. Enable Voice Control to control the camera with voice commands.

Simplified Chinese and English are supported. Voice commands in English include Start Recording, Stop Recording, Take Photo, and Shut Down.



4.5 Timecode

Swipe down from the top of the screen to enter the control menu, tap , and select **Timecode** to set the timecode for the camera.

Either reset the timecode or sync with the system time. The camera time code can be synchronized with a time code synchronizer using the USB-C port.

Tap **Timecode Display** to display the time code in the liveview.

4.6 Highlight

Tap the  to play back the video. During playback, you can tap the  icon to mark highlights, helping to quickly locate specific moments during post-editing, and reducing

the time to find highlights. The marked highlights can be viewed during playback in DJI Mimo.

4.7 Super Slow-Motion

The super slow-motion feature enables frame-by-frame analysis of the footage and generate slow-motion videos. The feature is particularly suitable for showcasing stunning and exciting moments in high-speed sports scenes such as cycling and skiing.

When playing back a video, select a specific point and tap the  icon to generate a super slow-motion video clip. During the generating process, you can tap Preview to preview the slow-motion effect.

You can tap Cancel to stop the generation of the super slow-motion clip during the process. To delete a super slow-motion clip, tap the  icon in the upper right corner when playing back the video.



- The camera performs 4x frame interpolation, allowing the camera to generate slow-motion videos at up to 960fps.
- Up to 6 super slow-motion clips can be added to a single video footage.
- Super slow-motion is only supported for 4K/2.7K/1080p 16:9 video footage with a frame rate of no less than 100fps. The generated super slow-motion videos will all be in 1080p format.
- The first 1.5 seconds and the last 2 seconds of the video do not support generating super slow-motion clips.

4.8 Transferring Files

Transferring Files to a Mobile Device

Connect the camera to DJI Mimo, tap the Playback icon to preview photos and videos. Tap the  icon to download photos and videos. The photos and videos can be shared directly from DJI Mimo to social media platforms.

Transferring Files to a Computer

Power on the camera and connect it to a computer using a USB-C cable. When connected to a computer, a pop-up will appear. Tap **Transfer File: USB** to download the files from the camera to the computer. When transferring a file, the camera cannot take photos or record videos.

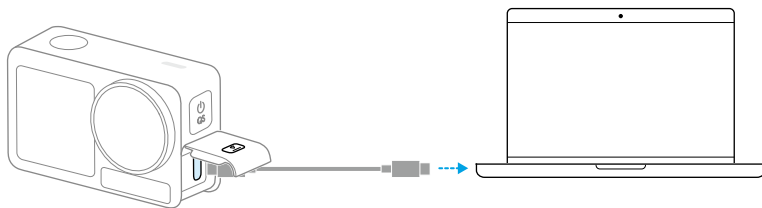

-
- 💡 • Reconnect the device to the computer if a file transfer is interrupted.
-

USB Mode for Transferring Files

For mobile devices that support OTG connection, the files can be transferred from the camera to the mobile device with USB mode.

Connect the camera to a mobile device with the Type-C to Type-C PD Cable (included). When connected, view and transfer photos and videos via the device album or file management.

-
- 💡 • If the camera cannot automatically recognize the mobile device in USB mode, swipe down from the top of the screen and enter the control menu. Tap **Settings** > **USB Mode**, and use the Type-C to Type-C PD cable to connect the camera to the device.
-

4.9 Connecting a Microphone

The product supports connecting two DJI wireless microphones simultaneously via Bluetooth, allowing stable wireless audio recording and remote control of shooting.

Follow the steps below to connect the wireless microphones.

1. Enter the control menu and tap the settings icon. Select Wireless Microphone settings and the transmitter to be linked, and then the camera is ready to link with a transmitter.
2. Power on the transmitter and make sure the transmitter is ready to link via Bluetooth.
3. Initiate the transmitter to start searching for nearby Bluetooth devices.
4. When the transmitter is successfully linked with the camera, you can view the connection status according to the prompt on the screen.
5. Once linked, you can use the transmitter to control the camera to start recording, with the audio being captured by the transmitter.

-
- Visit the DJI website and refer to the user manual of the mic product for more information.
 - Enter the control menu and enable **Built-in Mic Audio Backup**. When enabled, the built-in microphone of the camera will also record audio while shooting video, and save the audio as a separate .wav file.
 - When the transmitter is linked to the camera, tap Wireless Microphone settings to adjust the audio parameters of the transmitter.
-

4.10 Webcam Mode

The product can work as a webcam on a computer. Power on the product and connect it to the computer using a USB cable. The product will go into USB mode. Tap **Webcam** on the camera to enter the Webcam mode, and the camera will function as a webcam input device. The bottom of the screen displays Webcam. Press the Shutter/Record button to start recording. Tap the Image Parameter Settings icon on the right side of the screen to set the exposure, white balance, and FOV parameters. Users can preview recorded videos after exiting the Webcam mode.

4.11 Depth & Altitude

When the related settings of depth or altitude are enabled, the recorded video will include depth or altitude information.

Swipe down from the top of the screen and enter the control menu. Tap the settings icon, select **Depth & Altitude**, and then set the parameters for the Diving or Hiking & Parachuting scenario.

The recorded data can also be added to the video footage in a visualized form using the dashboard feature on the DJI Mimo app, which can better showcase exciting sports moments.

Maintenance

5 Maintenance

5.1 Updating Firmware

Use DJI Mimo to update the firmware of the device.

Ensure the battery is fully charged before updating the firmware. Connect the device to DJI Mimo. If new firmware is available, DJI Mimo will display a prompt. Tap the prompt and follow the on-screen instructions to update the firmware.

 If the update fails, follow the steps for troubleshooting.

1. Restart the camera and DJI Mimo.
2. Enable Wi-Fi and Bluetooth on the mobile device.
3. Connect the camera to DJI Mimo and try the update again.

Contact DJI Support if the update fails again.

5.2 Underwater Usage Notes

The product can be used underwater at depths of up to 20 m. When used with the Osmo Action 60m waterproof case, the product can be operated underwater up to 60 m deep.

Observe the following precautions before using the product in water.

1. Make sure the battery and battery compartment are dry and clean before inserting the battery. Otherwise, it may affect the battery contact and waterproofing ability. Make sure the battery compartment cover is firmly fastened after the battery is inserted. Note that the red marks should not be visible after the cover is properly fastened.
2. Make sure the USB-C port cover, and lens protective cover are firmly mounted and fastened, and that the waterproof seal is clean. Otherwise, it will affect the device waterproofing ability. All the holes on the product use a built-in waterproof material. DO NOT poke the holes.
3. Check if the lens protective cover is in good condition. If damaged, replace it immediately. Make sure the lens protective cover and lens are dry and clean. Sharp or hard objects may damage the lens and affect the ability of the camera. Make sure that the lens protective cover is firmly mounted and the rubber ring at the base of the lens is not detached.
4. The product is NOT waterproof when used with Osmo Action Lens Hood.

Observe the following precautions when using the product in water.

1. Avoid jumping into water at high speed with the product. Otherwise, the impact may result in water seepage.
2. DO NOT use the product in hot springs, corrosive liquids, or extreme underwater environments.

Observe the following precautions after using the product in water.

1. Rinse the camera with tap water after using it underwater. Allow it to dry naturally before using again. Wipe the surface of the camera with a soft and dry cloth.
2. DO NOT dry the camera with hot air using a hair dryer, otherwise the microphone membrane and the built-in breathable membrane will rupture, and the camera will no longer be waterproof.
3. After using the camera in water, open the battery compartment cover facing downward to prevent water from entering the gaps in the battery compartment if you need to replace the battery. Wipe off any water droplets in the gaps of the battery compartment and clean the red waterproof rubber ring to prevent any foreign objects from remaining. Otherwise, it will affect the waterproof performance during subsequent use.
4. When changing the lens protective cover, make sure the camera is dry. After using the camera in water, let it dry before using it again. This will prevent water from seeping into the lens protective cover, allowing for the lens to fog up.

Observe the following precautions when using the product with the waterproof case:

1. Make sure the rubber seal is clean and firmly secured during use.
2. Make sure the waterproof case is dry (for best results, place an anti-fog fiber in the case during use) and that the latch is secure.
3. Before use, it is recommended to place the waterproof case underwater for approximately 5 minutes to ensure it is working properly.
4. Rinse the case with tap water to prevent corrosion after using it in the sea.



- The touchscreens can be used when the surface is wet.
 - The touchscreens do not function when fully submerged underwater. Users can press the camera buttons to start recording. The Shutter/Record button is disabled automatically when the camera is used without a waterproof case at a depth of more than 10 m.
-

5.3 Cleaning Notes

1. DO NOT spill any liquids containing alcohol or cleansing solution on the camera.

2. If the holes of the microphone, heat dissipation slots, or other parts of the camera are blocked by sand or other foreign matter, rinse with fresh water while the camera is in a sealed waterproof state.
3. Clean the lens protective cover with water or a lens cleaning pen, lens air blower, or lens cleaning cloth. DO NOT remove the lens protective cover frequently to avoid dust accumulating inside the lens cover, which can affect shooting quality.
4. Clean the lens with a lens cleaning pen, lens air blower, or lens cleaning cloth.
5. Clean the battery and battery compartment with a clean, dry cloth.
6. Make sure the quick-release slots on the camera are clear of dust and sand when attaching the Quick-Release Adapter Mount.

5.4 Battery Usage Warnings

1. DO NOT use non-DJI Osmo batteries. New batteries can be purchased at www.dji.com. DJI Osmo shall not be responsible for any fault or damage caused by the use of any non-DJI OSMO batteries.
2. Use the battery within the temperature range specified at <https://www.dji.com/osmo-action-5-pro/specs> . Use of the battery in a high-temperature environment can lead to a fire or explosion. Before using the battery in a low-temperature environment, it is recommended to charge the battery fully in a normal temperature environment. Charging the battery at the ideal temperature can prolong battery life.
3. Discharge and charge the battery completely once every three months to keep it in good condition.
4. The battery is designed to stop charging when it is fully charged. It is good practice to monitor the charging progress and disconnect the charger when battery is fully charged.
5. When the battery voltage is too low, the battery will enter low-power state. Charging the battery will exit low-power mode.
6. DO NOT store the battery for an extended period of time after fully discharging. Otherwise, the battery may over-discharge and cause irreparable damage to the battery cell.
7. Discharge the battery to 40-65% if it will not be used for 10 days or more. This can greatly extend the battery life.

5.5 Using Other Accessories (Not Included)

Support for DJI devices will be updated continuously. Visit <https://www.dji.com/osmo-action-5-pro> for a complete list.

Refer to the figures below to install.

Osmo 1.5m Extension Rod

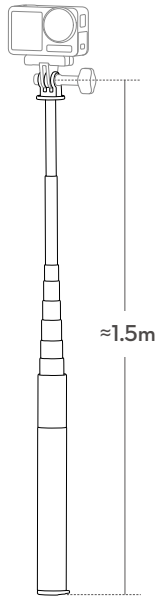

- DO NOT drop or strike the extension rod in any way when in use to avoid damage.
 - DO NOT shake the extension rod violently when installed with the camera to avoid damage.
 - Rinse with clean water to remove sand after underwater usage.
 - DO NOT use the extension rod during thunderstorms to avoid lightning strikes.
-

Osmo Magnetic Ball-Joint Adapter Mount

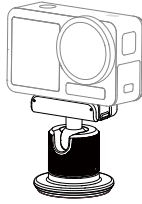

Osmo Action 60m Waterproof Case

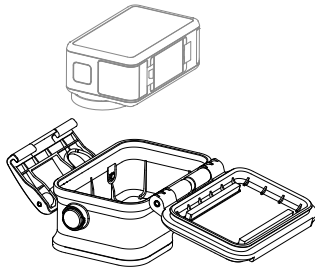

DJI Floating Handle

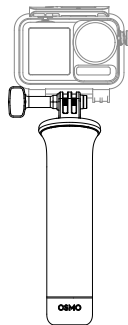

Osmo Action Suction Cup Mount

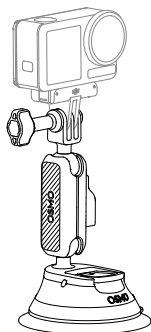

Osmo Action Helmet Chin Mount

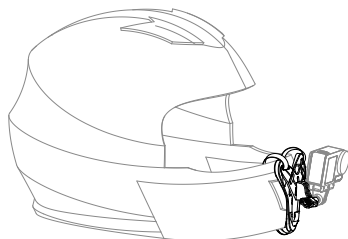

Osmo Action Chest Strap Mount

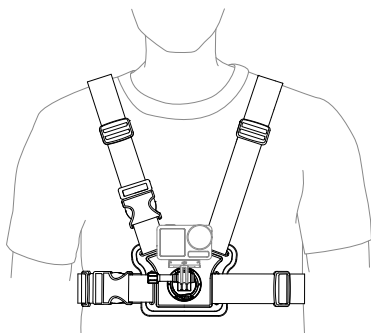

Osmo Action Handlebar Mount

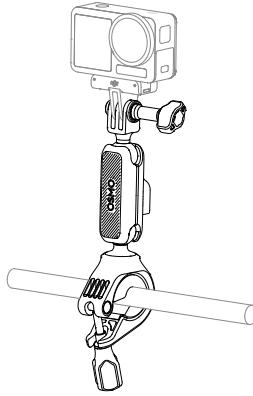

Osmo Action GPS Bluetooth Remote Controller

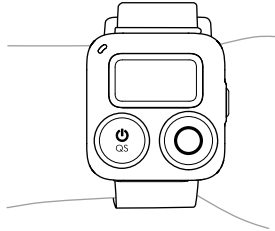

Osmo Action Multifunctional Charging Handle

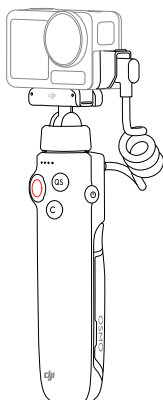

Osmo Action Cold Shoe Expansion Kit

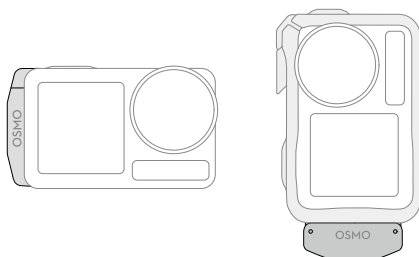

Specifications

6 Specifications

Visit the following website for specifications.

<https://www.dji.com/osmo-action-5-pro/specs>

DJI Support



Contact

DJI SUPPORT

This content is subject to change without prior notice.
Download the latest version from



<https://www.dji.com/osmo-action-5-pro/downloads>

If you have any questions about this document, please contact DJI by sending a message to DocSupport@dji.com.

DJI is a trademark of DJI. OSMO is a trademark of DJI OSMO.
Copyright © 2024 DJI All Rights Reserved.