

# Vostro 3520

## Service Manual

## Notes, cautions, and warnings

 **NOTE:** A NOTE indicates important information that helps you make better use of your product.

 **CAUTION:** A CAUTION indicates either potential damage to hardware or loss of data and tells you how to avoid the problem.

 **WARNING:** A WARNING indicates a potential for property damage, personal injury, or death.

<b>Chapter 1: Working inside your computer</b> .....	<b>6</b>
Safety instructions.....	6
Before working inside your computer.....	6
Safety precautions.....	7
Electrostatic discharge—ESD protection.....	7
ESD field service kit .....	8
Transporting sensitive components.....	9
After working inside your computer.....	9
BitLocker.....	9
<b>Chapter 2: Removing and installing components</b> .....	<b>10</b>
Recommended tools.....	10
Screw list.....	10
Major components of Vostro 3520.....	11
Secure Digital (SD) Card.....	13
Removing the Secure Digital card.....	13
Installing the Secure Digital card.....	15
Base cover.....	16
Removing the base cover.....	16
Installing the base cover.....	20
Battery.....	23
Rechargeable Li-ion battery precautions.....	23
Removing the 3-cell battery.....	24
Installing the 3-cell battery.....	25
Removing the 4-cell battery.....	26
Installing the 4-cell battery.....	28
Disconnecting the battery cable.....	29
Connecting the battery cable.....	30
M.2 solid-state drive.....	31
Removing the M.2 2230 solid state drive.....	31
Installing the M.2 2230 solid state drive.....	32
Removing the M.2 2280 solid state drive.....	33
Installing the M.2 2280 solid state drive.....	34
Wireless card.....	35
Removing the wireless card.....	35
Installing the wireless card.....	36
I/O board.....	38
Removing the Input/Output board.....	38
Installing the Input/Output board.....	39
I/O daughter board FFC.....	40
Removing the Input/Output daughterboard FFC.....	40
Installing the Input/Output daughter board FFC.....	41
Hard drive assembly.....	43
Removing the hard drive .....	43

Installing the hard drive.....	45
Memory modules.....	47
Removing the memory modules.....	47
Installing the memory modules.....	48
Speakers.....	49
Removing the speakers.....	49
Installing the speakers.....	49
Heat sink.....	50
Removing the heat sink.....	50
Installing the heat sink.....	51
Fan.....	52
Removing the fan.....	52
Installing the fan.....	53
Power-button board.....	54
Removing the power button.....	54
Installing the power button.....	55
Power button with fingerprint reader.....	56
Removing the power button with optional fingerprint reader.....	56
Installing the power button with optional fingerprint reader.....	57
Display assembly.....	58
Removing the display assembly.....	58
Installing the display assembly.....	63
Hinge caps.....	67
Removing the hinge caps.....	67
Installing the hinge caps .....	69
Display bezel.....	70
Removing the display bezel.....	70
Installing the display bezel .....	71
Hinges.....	73
Removing the hinges.....	73
Installing the hinges .....	75
Display panel.....	76
Removing the display panel.....	76
Installing the display panel.....	79
Camera module.....	83
Removing the camera module.....	83
Installing the camera module.....	84
eDP cable.....	85
Removing the eDP cable.....	85
Installing the eDP cable.....	86
Display cover and antenna assembly.....	88
Replacement of the display cover and antenna assembly.....	88
Touchpad.....	89
Removing the touchpad.....	89
Installing the touchpad.....	91
System board.....	92
Removing the system board.....	92
Installing the system board.....	95
Power-adaptor port.....	98
Removing the power-adaptor port.....	98













Installing the power-adaptor port.....	99
Palm-rest and keyboard assembly.....	100
Removing the palm-rest and keyboard assembly.....	100
Installing the palmrest and keyboard assembly.....	102
<b>Chapter 3: Drivers and downloads.....</b>	<b>104</b>
<b>Chapter 4: BIOS setup.....</b>	<b>105</b>
Entering BIOS setup program.....	105
Navigation keys.....	105
One Time Boot menu.....	105
System setup options.....	106
Updating the BIOS.....	110
Updating the BIOS in Windows.....	110
Updating the BIOS in Linux and Ubuntu.....	110
Updating the BIOS using the USB drive in Windows.....	110
Updating the BIOS from the F12 One-Time boot menu.....	111
System and setup password.....	111
Assigning a system setup password.....	112
Deleting or changing an existing system setup password.....	112
Clearing BIOS (System Setup) and System passwords.....	113
<b>Chapter 5: Troubleshooting.....</b>	<b>114</b>
Handling swollen rechargeable Li-ion batteries.....	114
Dell SupportAssist Pre-boot System Performance Check diagnostics.....	114
Running the SupportAssist Pre-Boot System Performance Check.....	115
Built-in self-test (BIST).....	115
M-BIST.....	115
LCD Power rail test (L-BIST).....	116
LCD Built-in Self Test (BIST).....	116
System-diagnostic lights.....	116
Recovering the operating system.....	118
Backup media and recovery options.....	118
Wi-Fi power cycle.....	118
Drain residual flea power (perform hard reset).....	119
<b>Chapter 6: Getting help and contacting Dell.....</b>	<b>120</b>

# Working inside your computer

## Safety instructions

Use the following safety guidelines to protect your computer from potential damage and to ensure your personal safety. Unless otherwise noted, each procedure included in this document assumes that you have read the safety information that shipped with your computer.

-  **WARNING:** Before working inside your computer, read the safety information that is shipped with your computer. For more safety best practices, see the Regulatory Compliance home page at [www.dell.com/regulatory\\_compliance](http://www.dell.com/regulatory_compliance).
-  **WARNING:** Disconnect your computer from all power sources before opening the computer cover or panels. After you finish working inside the computer, replace all covers, panels, and screws before connecting your computer to an electrical outlet.
-  **CAUTION:** To avoid damaging the computer, ensure that the work surface is flat, dry, and clean.
-  **CAUTION:** To avoid damaging the components and cards, handle them by their edges, and avoid touching the pins and the contacts.
-  **CAUTION:** You should only perform troubleshooting and repairs as authorized or directed by the Dell technical assistance team. Damage due to servicing that is not authorized by Dell is not covered by your warranty. See the safety instructions that is shipped with the product or at [www.dell.com/regulatory\\_compliance](http://www.dell.com/regulatory_compliance).
-  **CAUTION:** Before touching anything inside your computer, ground yourself by touching an unpainted metal surface, such as the metal at the back of the computer. While you work, periodically touch an unpainted metal surface to dissipate static electricity which could harm internal components.
-  **CAUTION:** When you disconnect a cable, pull it by its connector or its pull tab, not the cable itself. Some cables have connectors with locking tabs or thumbscrews that you must disengage before disconnecting the cable. When disconnecting cables, keep them evenly aligned to avoid bending the connector pins. When connecting cables, ensure that the ports and the connectors are correctly oriented and aligned.
-  **CAUTION:** Press and eject any installed card from the media-card reader.
-  **CAUTION:** Exercise caution when handling rechargeable Li-ion batteries in laptops. Swollen batteries should not be used and should be replaced and disposed properly.
-  **NOTE:** The color of your computer and certain components may appear differently than shown in this document.

## Before working inside your computer

### About this task

-  **NOTE:** The images in this document may differ from your computer depending on the configuration you ordered.

### Steps

1. Save and close all open files and exit all open applications.
2. Shut down your computer. For Windows operating system, click **Start** >  **Power** > **Shut down**.

 **NOTE:** If you are using a different operating system, see the documentation of your operating system for shut-down instructions.

3. Disconnect your computer and all attached devices from their electrical outlets.
4. Disconnect all attached network devices and peripherals, such as keyboard, mouse, and monitor from your computer.

 **CAUTION:** To disconnect a network cable, first unplug the cable from your computer and then unplug the cable from the network device.

5. Remove any media card and optical disc from your computer, if applicable.

## Safety precautions

The safety precautions chapter details the primary steps to be taken before performing any disassembly instructions.

Observe the following safety precautions before you perform any installation or break/fix procedures involving disassembly or reassembly:

- Turn off the system and all attached peripherals.
- Disconnect the system and all attached peripherals from AC power.
- Disconnect all network cables, telephone, and telecommunications lines from the system.
- Use an ESD field service kit when working inside any tablet/notebook to avoid electrostatic discharge (ESD) damage.
- After removing any system component, carefully place the removed component on an anti-static mat.
- Wear shoes with non-conductive rubber soles to reduce the chance of getting electrocuted.

## Standby power

Dell products with standby power must be unplugged before you open the case. Systems that incorporate standby power are essentially powered while turned off. The internal power enables the system to be remotely turned on (wake on LAN) and suspended into a sleep mode and has other advanced power management features.

Unplugging, pressing, and holding the power button for 15 seconds should discharge residual power in the system board.

## Bonding

Bonding is a method for connecting two or more grounding conductors to the same electrical potential. This is done through the use of a field service electrostatic discharge (ESD) kit. When connecting a bonding wire, ensure that it is connected to bare metal and never to a painted or non-metal surface. The wrist strap should be secure and in full contact with your skin, and ensure that you remove all jewelry such as watches, bracelets, or rings prior to bonding yourself and the equipment.

## Electrostatic discharge—ESD protection

ESD is a major concern when you handle electronic components, especially sensitive components such as expansion cards, processors, memory DIMMs, and system boards. Very slight charges can damage circuits in ways that may not be obvious, such as intermittent problems or a shortened product life span. As the industry pushes for lower power requirements and increased density, ESD protection is an increasing concern.

Due to the increased density of semiconductors used in recent Dell products, the sensitivity to static damage is now higher than in previous Dell products. For this reason, some previously approved methods of handling parts are no longer applicable.

Two recognized types of ESD damage are catastrophic and intermittent failures.

- **Catastrophic** – Catastrophic failures represent approximately 20 percent of ESD-related failures. The damage causes an immediate and complete loss of device functionality. An example of catastrophic failure is a memory DIMM that has received a static shock and immediately generates a "No POST/No Video" symptom with a beep code emitted for missing or nonfunctional memory.
- **Intermittent** – Intermittent failures represent approximately 80 percent of ESD-related failures. The high rate of intermittent failures means that most of the time when damage occurs, it is not immediately recognizable. The DIMM receives a static shock, but the tracing is merely weakened and does not immediately produce outward symptoms related to the damage. The weakened trace may take weeks or months to melt, and in the meantime may cause degradation of memory integrity, intermittent memory errors, etc.

The more difficult type of damage to recognize and troubleshoot is the intermittent (also called latent or "walking wounded") failure.

Perform the following steps to prevent ESD damage:

- Use a wired ESD wrist strap that is properly grounded. The use of wireless anti-static straps is no longer allowed; they do not provide adequate protection. Touching the chassis before handling parts does not ensure adequate ESD protection on parts with increased sensitivity to ESD damage.
- Handle all static-sensitive components in a static-safe area. If possible, use anti-static floor pads and workbench pads.
- When unpacking a static-sensitive component from its shipping carton, do not remove the component from the anti-static packing material until you are ready to install the component. Before unwrapping the anti-static packaging, ensure that you discharge static electricity from your body.
- Before transporting a static-sensitive component, place it in an anti-static container or packaging.

## ESD field service kit

The unmonitored Field Service kit is the most commonly used service kit. Each Field Service kit includes three main components: anti-static mat, wrist strap, and bonding wire.

### Components of an ESD field service kit

The components of an ESD field service kit are:

- **Anti-Static Mat** – The anti-static mat is dissipative and parts can be placed on it during service procedures. When using an anti-static mat, your wrist strap should be snug and the bonding wire should be connected to the mat and to any bare metal on the system being worked on. Once deployed properly, service parts can be removed from the ESD bag and placed directly on the mat. ESD-sensitive items are safe in your hand, on the ESD mat, in the system, or inside a bag.
- **Wrist Strap and Bonding Wire** – The wrist strap and bonding wire can be either directly connected between your wrist and bare metal on the hardware if the ESD mat is not required, or connected to the anti-static mat to protect hardware that is temporarily placed on the mat. The physical connection of the wrist strap and bonding wire between your skin, the ESD mat, and the hardware is known as bonding. Use only Field Service kits with a wrist strap, mat, and bonding wire. Never use wireless wrist straps. Always be aware that the internal wires of a wrist strap are prone to damage from normal wear and tear, and must be checked regularly with a wrist strap tester in order to avoid accidental ESD hardware damage. It is recommended to test the wrist strap and bonding wire at least once per week.
- **ESD Wrist Strap Tester** – The wires inside of an ESD strap are prone to damage over time. When using an unmonitored kit, it is a best practice to regularly test the strap prior to each service call, and at a minimum, test once per week. A wrist strap tester is the best method for doing this test. If you do not have your own wrist strap tester, check with your regional office to find out if they have one. To perform the test, plug the wrist-strap's bonding-wire into the tester while it is strapped to your wrist and push the button to test. A green LED is lit if the test is successful; a red LED is lit and an alarm sounds if the test fails.
- **Insulator Elements** – It is critical to keep ESD sensitive devices, such as plastic heat sink casings, away from internal parts that are insulators and often highly charged.
- **Working Environment** – Before deploying the ESD Field Service kit, assess the situation at the customer location. For example, deploying the kit for a server environment is different than for a desktop or portable environment. Servers are typically installed in a rack within a data center; desktops or portables are typically placed on office desks or cubicles. Always look for a large open flat work area that is free of clutter and large enough to deploy the ESD kit with additional space to accommodate the type of system that is being repaired. The workspace should also be free of insulators that can cause an ESD event. On the work area, insulators such as Styrofoam and other plastics should always be moved at least 12 inches or 30 centimeters away from sensitive parts before physically handling any hardware components
- **ESD Packaging** – All ESD-sensitive devices must be shipped and received in static-safe packaging. Metal, static-shielded bags are preferred. However, you should always return the damaged part using the same ESD bag and packaging that the new part arrived in. The ESD bag should be folded over and taped shut and all the same foam packing material should be used in the original box that the new part arrived in. ESD-sensitive devices should be removed from packaging only at an ESD-protected work surface, and parts should never be placed on top of the ESD bag because only the inside of the bag is shielded. Always place parts in your hand, on the ESD mat, in the system, or inside an anti-static bag.
- **Transporting Sensitive Components** – When transporting ESD sensitive components such as replacement parts or parts to be returned to Dell, it is critical to place these parts in anti-static bags for safe transport.

## ESD protection summary

It is recommended to use the traditional wired ESD grounding wrist strap and protective anti-static mat at all times when servicing Dell products. In addition, it is critical to keep sensitive parts separate from all insulator parts while performing service and that they use anti-static bags for transporting sensitive components.

## Transporting sensitive components

When transporting ESD sensitive components such as replacement parts or parts to be returned to Dell, it is critical to place these parts in anti-static bags for safe transport.

## After working inside your computer

### About this task

 **NOTE:** Leaving stray or loose screws inside your computer may severely damage your computer.

### Steps

1. Replace all screws and ensure that no stray screws remain inside your computer.
2. Connect any external devices, peripherals, or cables you removed before working on your computer.
3. Replace any media cards, discs, or any other parts that you removed before working on your computer.
4. Connect your computer and all attached devices to their electrical outlets.
5. Turn on your computer.

## BitLocker

 **CAUTION:** If BitLocker is not suspended before updating the BIOS, the next time you reboot the system it will not recognize the BitLocker key. You will then be prompted to enter the recovery key to progress, and the system will ask for this on each reboot. If the recovery key is not known this can result in data loss or an unnecessary operating system reinstall. For more information about this subject, see Knowledge Article: [updating the BIOS on Dell systems with BitLocker enabled](#).

The installation of the following components triggers BitLocker:

- Hard disk drive or solid state drive
- System board

# Removing and installing components

**NOTE:** The images in this document may differ from your computer depending on the configuration you ordered.

## Recommended tools

The procedures in this document may require the following tools:

- Phillips screwdriver #0
- Plastic scribe









## Screw list

**NOTE:** When removing screws from a component, it is recommended to note the screw type, the quantity of screws, and then place them in a screw storage box. This is to ensure that the correct number of screws and correct screw type is restored when the component is replaced.







**NOTE:** Some computers have magnetic surfaces. Ensure that the screws are not left attached to such surfaces when replacing a component.

**NOTE:** Screw color may vary with the configuration ordered.

**Table 1. Screw list**

Component	Screw type	Quantity	Screw image
Base cover	M2x5	6	
	Captive screw	2	
3-cell battery	M2x3	3	
4-cell battery	M2x3	4	
	M2x2 (OD=7)- to fix RF bracket	2	
M.2 2230 solid-state drive	M2x2 (OD=5)	1	
M.2 2280 solid-state drive	M2x2 (OD=5)	1	
Wireless card	M2x3.5	1	
I/O board	M2x3.5	2	

**Table 1. Screw list (continued)**

Component	Screw type	Quantity	Screw image
Hard-drive assembly Hard-drive bracket	M2x3.5 M3x3	4 4	
<b>i</b> <b>NOTE:</b> Systems with 11 <sup>th</sup> Generation Intel Core (or Tiger Lake) do not offer hard drive configuration.			
Heat sink	M2x3	4	
Fan	M2x5	2	
Power button with optional fingerprint reader	M2x2 (OD=5)	1	
Display assembly	M2.5x5	4	
System board	M2x3.5 M2x2 (OD=5)	4 1	
USB type-C bracket	M2x3.5	2	
Touchpad Touchpad bracket	M2x2 (OD=5) Big Head M2x2 (OD=5) Big Head	2 3	

## Major components of Vostro 3520

The following image shows the major components of Vostro 3520.

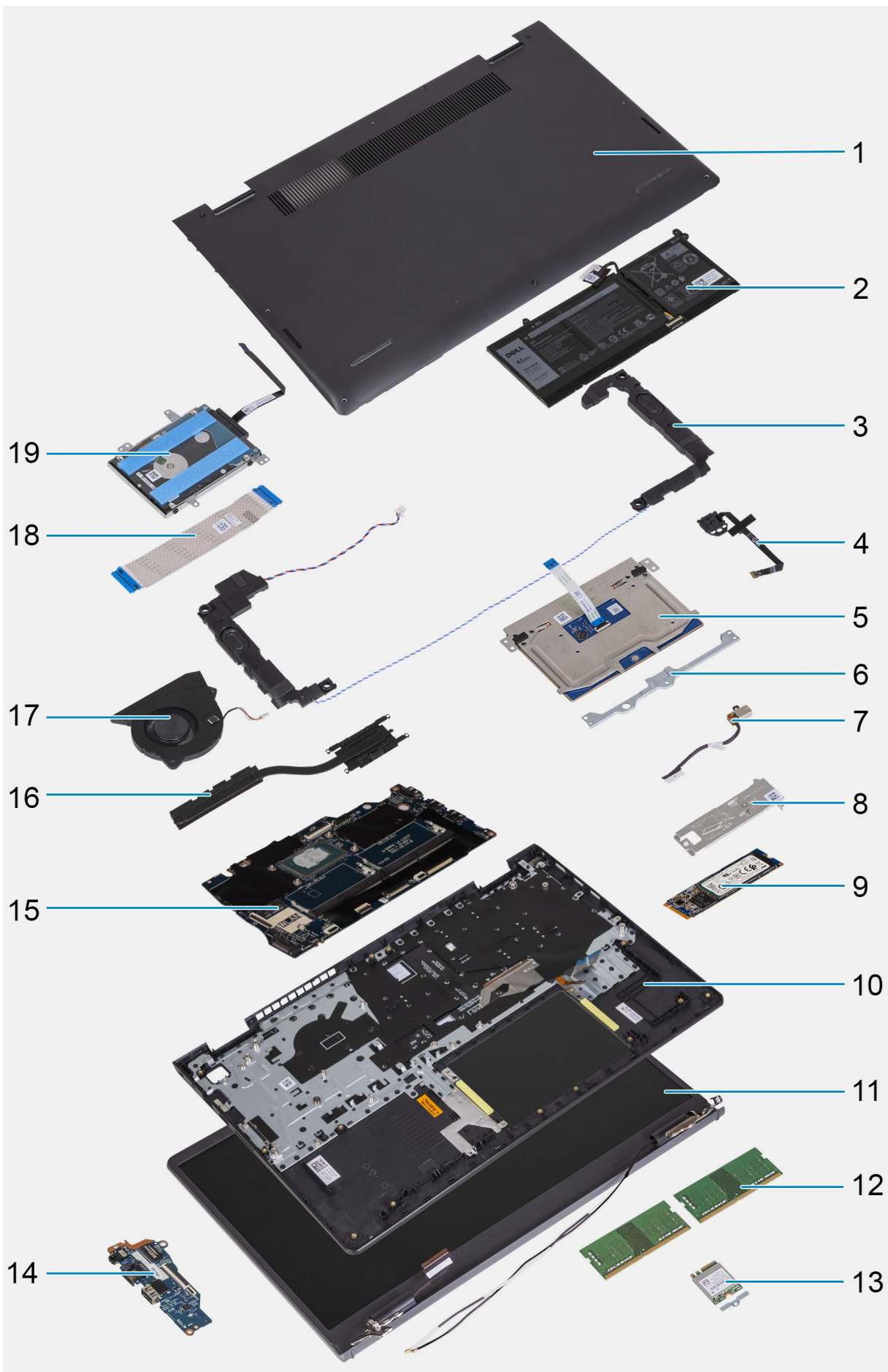



1. Base cover
3. Speakers
5. Touchpad
7. Power-adapter port
9. M.2 solid-state drive
11. Display assembly
13. Wireless card with bracket
15. System board
17. Fan
19. Hard drive
2. Battery
4. Power-button with optional fingerprint-reader
6. Touchpad bracket
8. M.2 solid-state drive thermal plate
10. Palm-rest and keyboard assembly
12. Memory modules
14. I/O board
16. Heat sink
18. I/O board FFC

 **NOTE:** Systems with 11<sup>th</sup> Generation Intel Core (or Tiger Lake) do not offer hard drive configuration.

 **NOTE:** Dell provides a list of components and their part numbers for the original system configuration purchased. These parts are available according to warranty coverages purchased by the customer. Contact your Dell sales representative for purchase options.

## Secure Digital (SD) Card

### Removing the Secure Digital card

#### Prerequisites

1. Follow the procedure in [Before working inside your computer](#).

## About this task

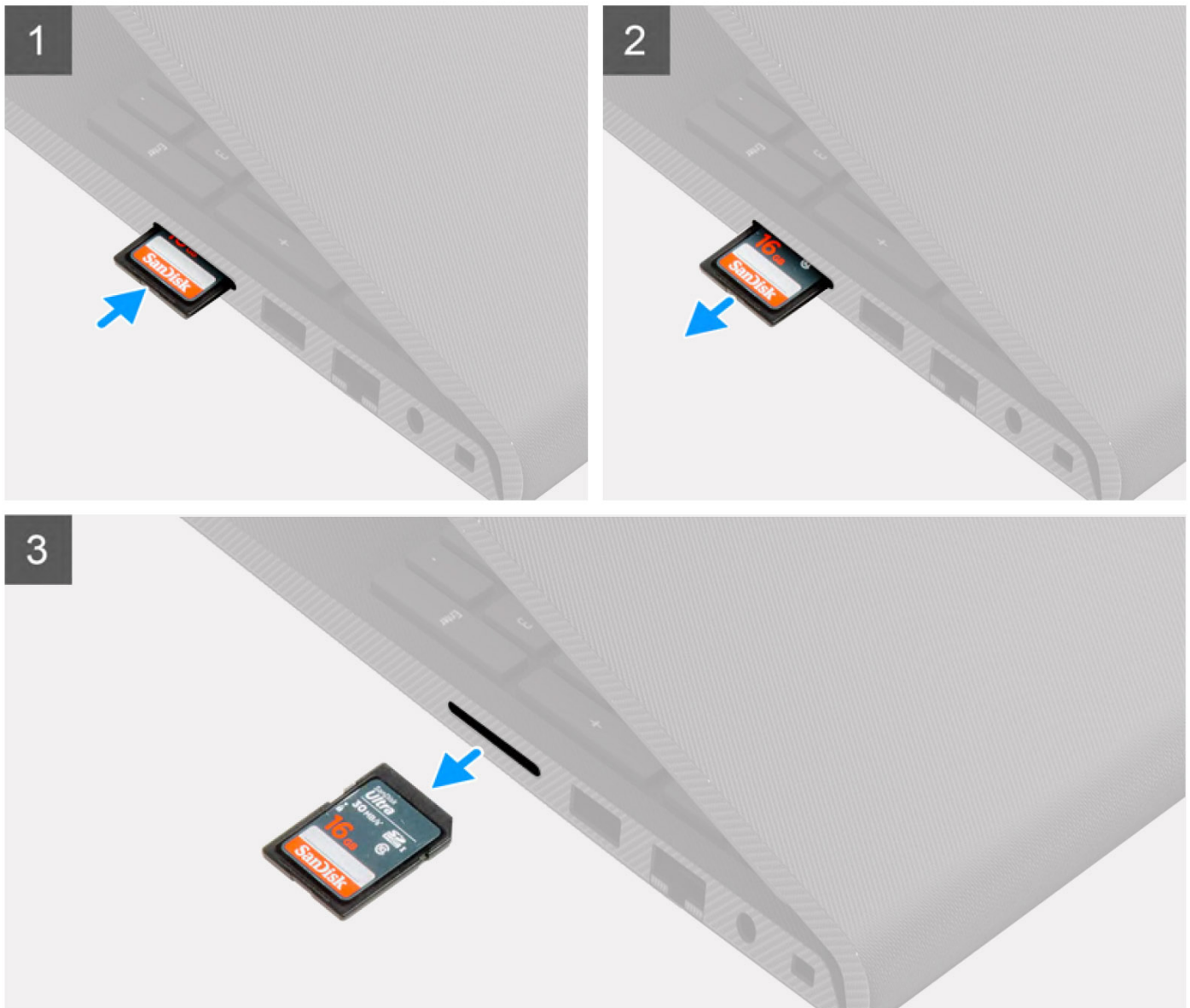

### Steps

1. Push the secure digital card to release it from the card slot.
2. Slide the secure digital card out of the computer.

# Installing the Secure Digital card

## Prerequisites

If you are replacing a component, remove the existing component before performing the installation procedure.

## About this task

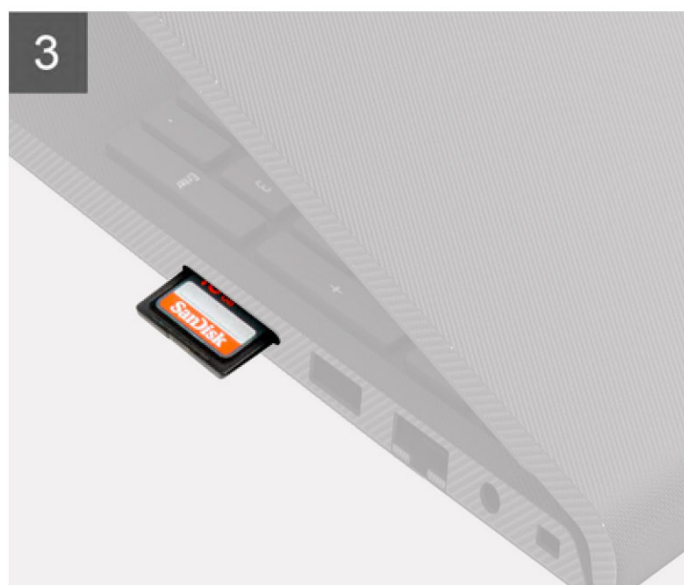
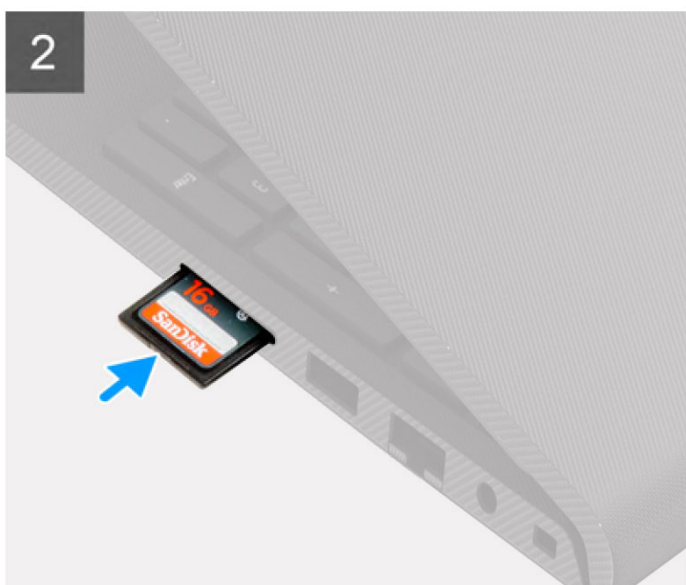

### Steps

Slide the secure digital into the slot until it clicks into place.

### Next steps

1. Follow the procedure in [After working inside your computer](#).

## Base cover

### Removing the base cover

#### Prerequisites

1. Follow the procedure in [Before working inside your computer](#).
2. Remove the [SD card](#).

#### About this task

 **NOTE:** Before removing the base cover, ensure that there is no SD card installed in the SD card slot on your computer.

The following images indicate the location of the base cover and provide a visual representation of the removal procedure.



**6x**  
M2x5



**2x**

**1**





2

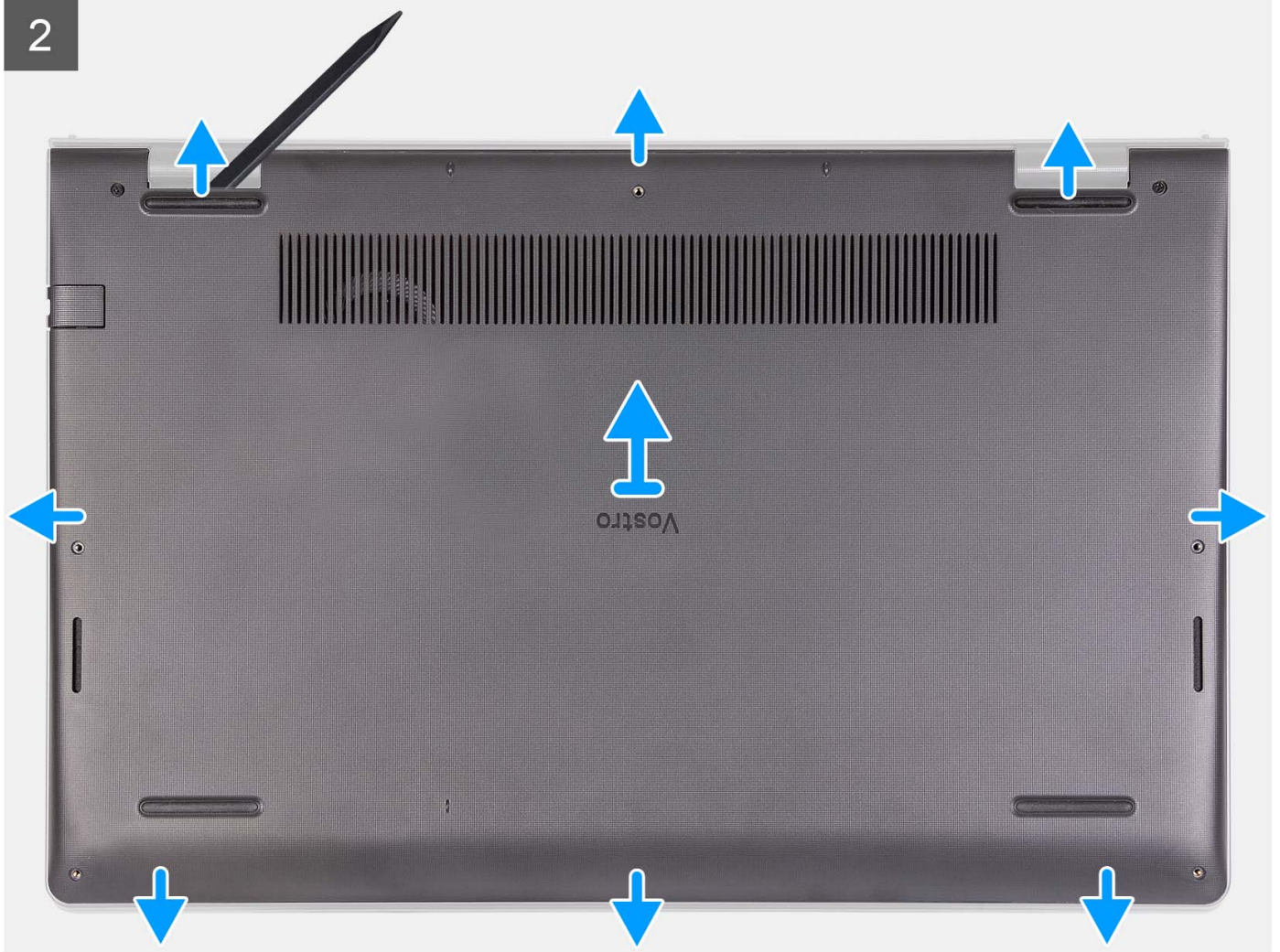

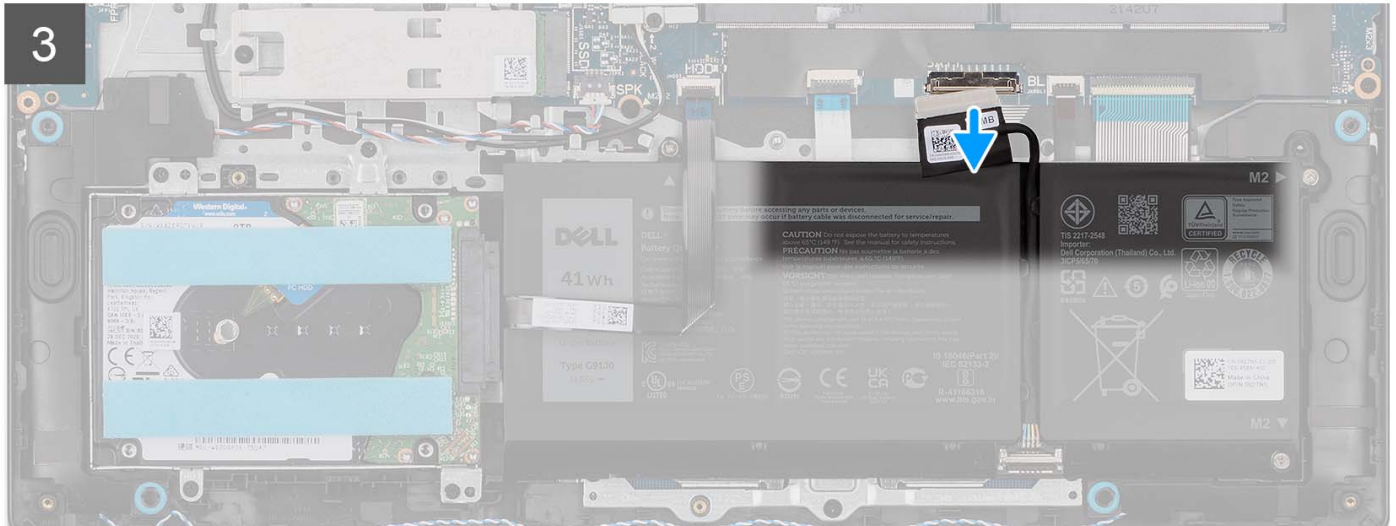
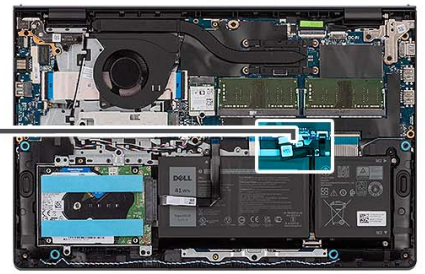
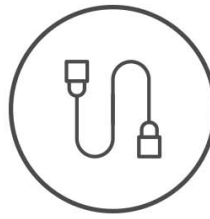



### Steps

1. Remove the six screws (M2x5) that secure the base cover to the palm-rest and keyboard assembly.
2. Loosen the two captive screws that secure the base cover to the palm-rest and keyboard assembly.
3. Using a plastic scribe, pry open the base cover from the recesses located in the U-shaped indents at the top edge of the base cover near the hinges.
4. Lift the base cover off the palm-rest and keyboard assembly.
5. Disconnect the battery cable from the system board.
6. Press and hold the power button for five seconds to ground the computer and drain the flea power.

## Installing the base cover

### Prerequisites

If you are replacing a component, remove the existing component before performing the installation process.

### About this task

The following images indicate the location of the base cover and provide a visual representation of the installation procedure.





6x  
M2x5



2x

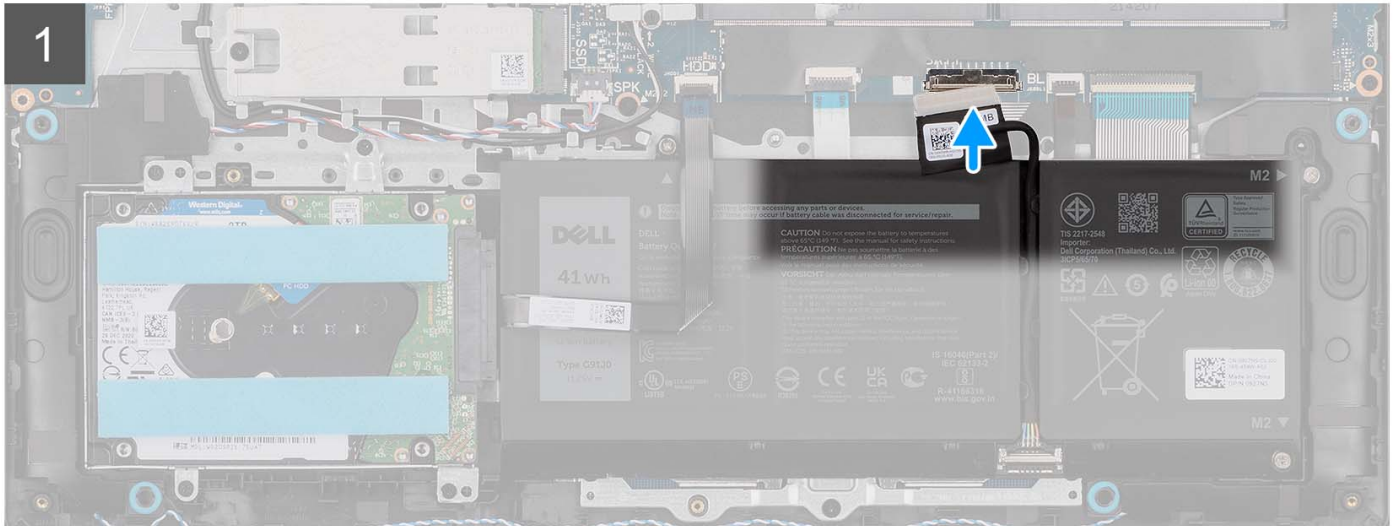
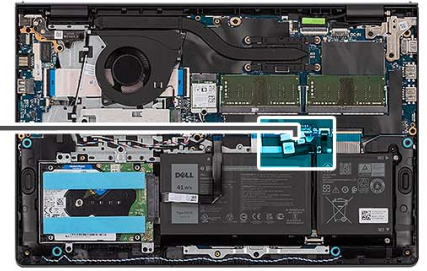
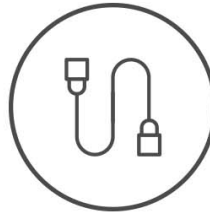

2

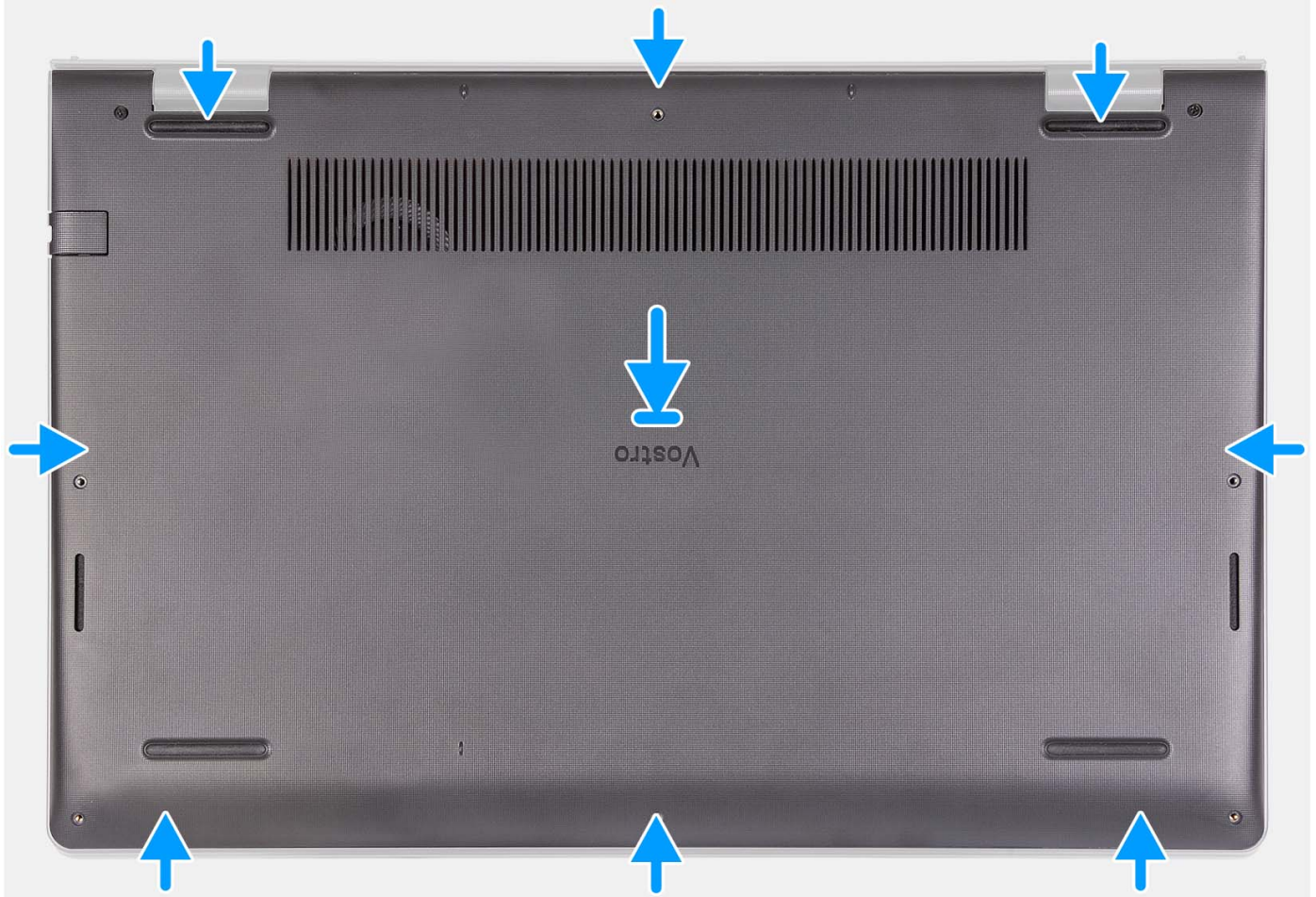



### Steps

1. Connect the battery cable to the connector on the system board.
2. Place and snap the base cover into place on the palm-rest and keyboard assembly.
3. Tighten the two captive screws that secure the base cover to the palm-rest and keyboard assembly.
4. Replace the six screws (M2x5) that secure the base cover to the palm-rest and keyboard assembly.

### Next steps

1. Install the [SD card](#).
2. Follow the procedure in [After working inside your computer](#).

## Battery

### Rechargeable Li-ion battery precautions

#### ⚠ CAUTION:

- Exercise caution when handling rechargeable Li-ion batteries.
- Discharge the battery completely before removing it. Disconnect the AC power adapter from the system and operate the computer solely on battery power—the battery is fully discharged when the computer no longer turns on when the power button is pressed.
- Do not crush, drop, mutilate, or penetrate the battery with foreign objects.
- Do not expose the battery to high temperatures, or disassemble battery packs and cells.
- Do not apply pressure to the surface of the battery.

- Do not bend the battery.
- Do not use tools of any kind to pry on or against the battery.
- Ensure any screws during the servicing of this product are not lost or misplaced, to prevent accidental puncture or damage to the battery and other system components.
- If the battery gets stuck inside your computer as a result of swelling, do not try to release it as puncturing, bending, or crushing a rechargeable Li-ion battery can be dangerous. In such an instance, contact Dell technical support for assistance. See [www.dell.com/contactdell](http://www.dell.com/contactdell).
- Always purchase genuine batteries from [www.dell.com](http://www.dell.com) or authorized Dell partners and resellers.
- Swollen batteries should not be used and should be replaced and disposed properly. For guidelines on how to handle and replace swollen rechargeable Li-ion batteries, see [Handling swollen rechargeable Li-ion batteries](#).

## Removing the 3-cell battery

### Prerequisites

1. Follow the procedure in [Before working inside your computer](#).
2. Remove the [SD card](#).
3. Remove the [base cover](#).

### About this task

The following image indicates the location of the 3-cell battery and provides a visual representation of the removal procedure.





**3x**  
M2x3

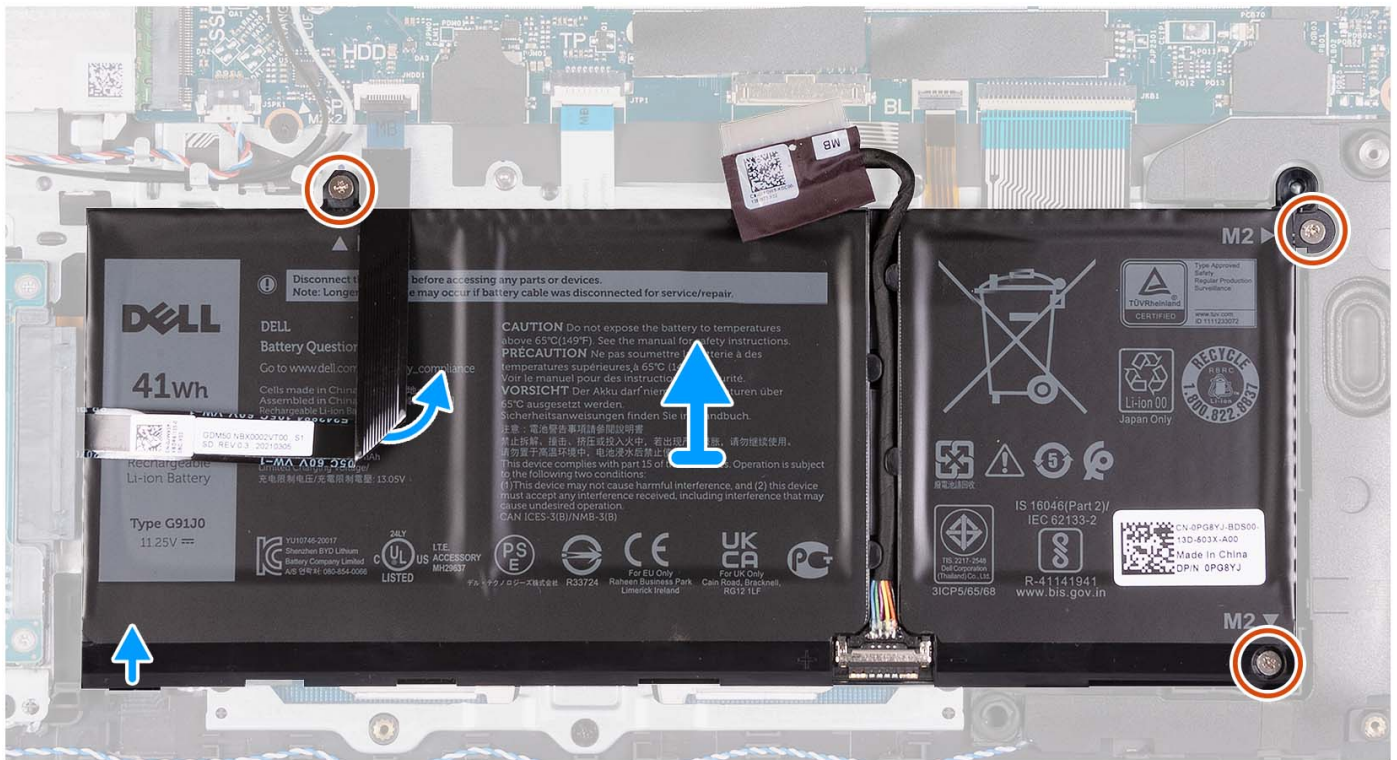
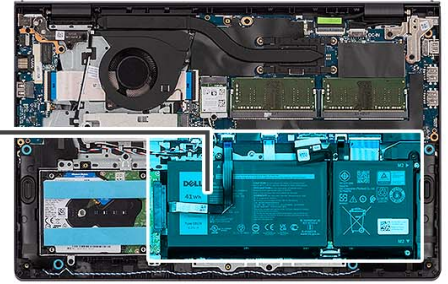
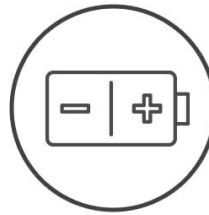

### Steps

1. Disconnect the battery cable from the system board, if applicable.
2. Remove the three (M2x3) screws that secure the battery to the palm-rest and keyboard assembly.
3. Peel the hard drive Flexible Flat Cable from the system board.

**NOTE:** This step is applicable only for systems shipped with a 2.5-inch hard drive.

4. Remove the battery from the palm-rest and keyboard assembly.

**CAUTION:** Carefully remove the battery so that battery does not tug on the hard drive Flexible Flat Cable.

## Installing the 3-cell battery

### Prerequisites

If you are replacing a component, remove the existing component before performing the installation process.

### About this task

The following image indicates the location of the 3-cell battery and provides a visual representation of the installation procedure.



3x  
M2x3

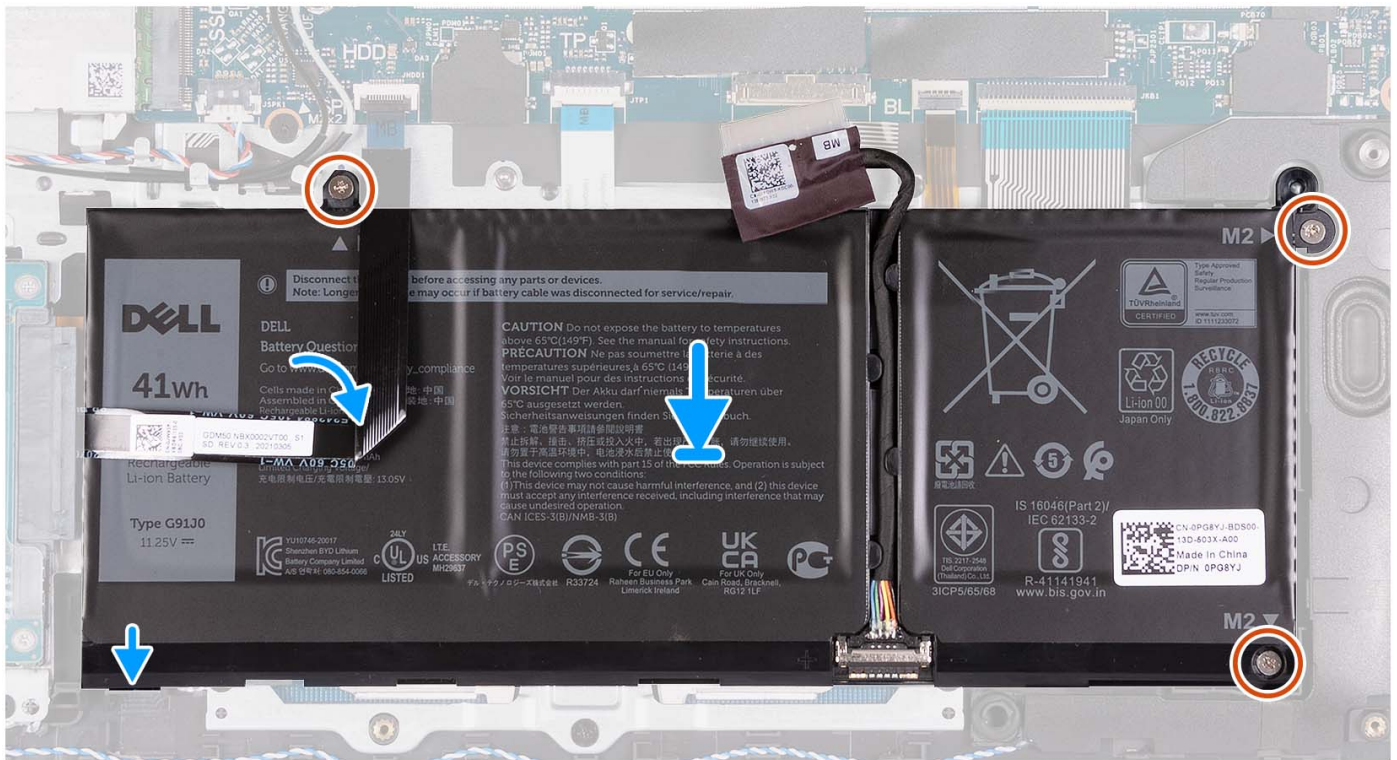
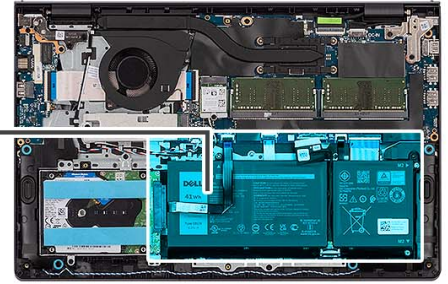
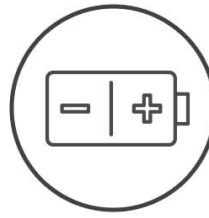

## Steps

1. Place the battery on the palm-rest and keyboard assembly.
2. Align the screw holes on the battery to the screw holes on the palm-rest and keyboard assembly.
3. Replace the three (M2x3) screws that secure the battery to the palm-rest and keyboard assembly.
4. Adhere the hard drive Flexible Flat Cable on to the battery and connect the cable to the system board.
5. Connect the battery cable to the connector on the system board.

## Next steps

1. Install the [base cover](#).
2. Install the [SD card](#).
3. Follow the procedure in [After working inside your computer](#).

## Removing the 4-cell battery

### Prerequisites

1. Follow the procedure in [Before working inside your computer](#).
2. Remove the [SD card](#).
3. Remove the [base cover](#).



## About this task

The following image indicates the location of the 4-cell battery and provides a visual representation of the removal procedure.



4x  
M2x3

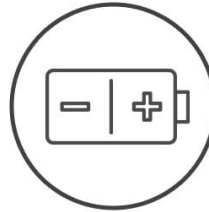

## Steps

1. Disconnect the battery cable from the system board, if applicable.
2. Remove the four (M2x3) screws that secure the battery to the palm-rest and keyboard assembly.
3. Remove the battery from the palm-rest and keyboard assembly.

**NOTE:** When replacing the 4-cell battery, use a scribe push upward through the bottom-left screw hole to remove the battery rubber stopper and transfer it to the new replacement 4-cell battery.

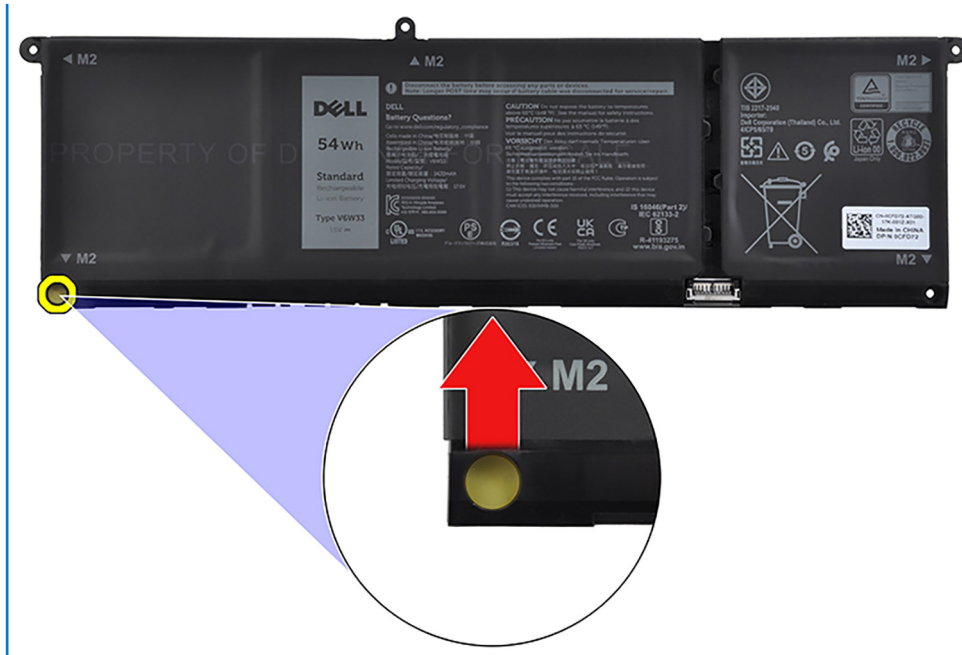

## Installing the 4-cell battery

### Prerequisites

If you are replacing a component, remove the existing component before performing the installation process.

### About this task

The following image indicates the location of the 4-cell battery and provides a visual representation of the installation procedure.





4x  
M2x3

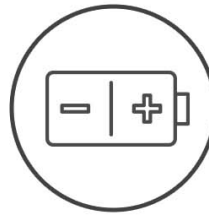

## Steps

1. Place the battery on the palm-rest and keyboard assembly.
2. Align the screw holes on the battery to the screw holes on the palm-rest and keyboard assembly.
3. Replace the four (M2x3) screws that secure the battery to the palm-rest and keyboard assembly.
4. Connect the battery cable to the connector on the system board.

**NOTE:** When replacing the 4-cell battery, use a scribe push upward through the bottom-left screw hole to remove the battery rubber stopper and transfer it to the new replacement 4-cell battery.

## Next steps

1. Install the [base cover](#).
2. Install the [SD card](#).
3. Follow the procedure in [After working inside your computer](#).

## Disconnecting the battery cable

### Prerequisites

1. Follow the procedure in [Before working inside your computer](#).
2. Remove the [SD card](#).
3. Remove the [base cover](#).

### About this task

The following images indicate the location of the battery cable and provide a visual representation of the removal procedure.

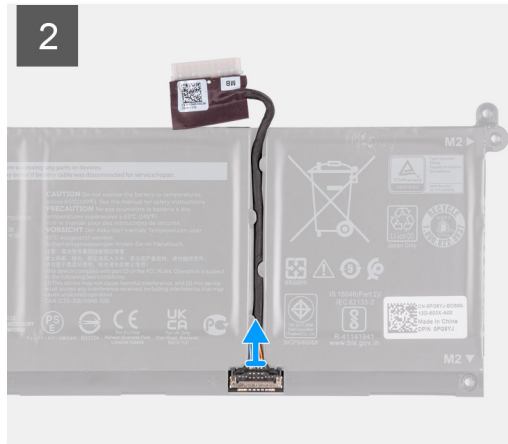
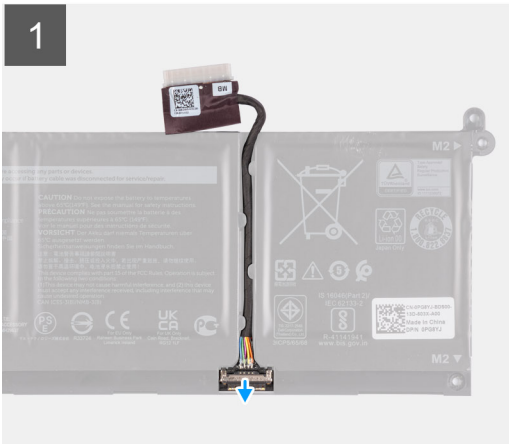

## Steps

1. Lift the latch on the battery cable.
2. Disconnect the battery cable from the connector on the battery.

## Connecting the battery cable

### Prerequisites

If you are replacing a component, remove the existing component before performing the installation process.

### About this task

The following images indicate the location of the battery cable and provide a visual representation of the installation procedure.

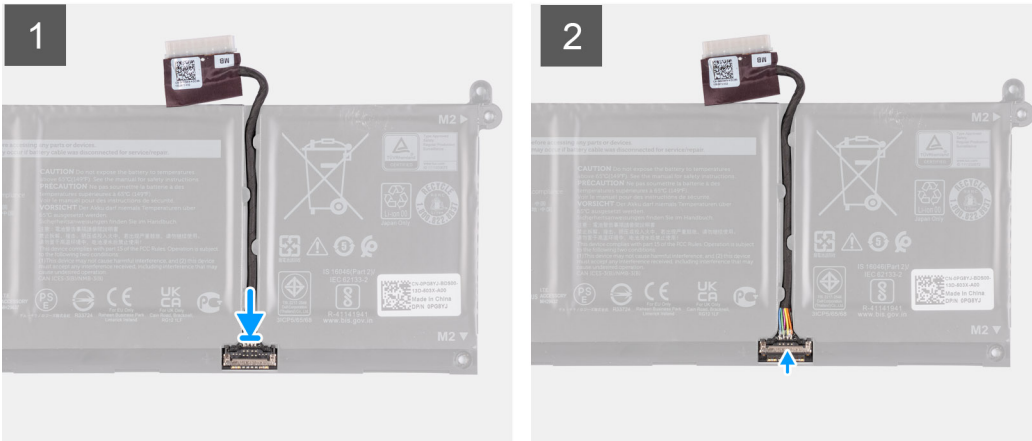

### Steps

1. Connect the battery cable to the connector on the battery.
2. Close the latch on the battery cable connector to secure it to the battery.

### Next steps

1. Install the [base cover](#).
2. Install the [SD card](#).
3. Follow the procedure in [After working inside your computer](#).

## M.2 solid-state drive

### Removing the M.2 2230 solid state drive

#### Prerequisites

1. Follow the procedure in [Before working inside your computer](#).
2. Remove the [SD card](#).
3. Remove the [base cover](#).

#### About this task

**NOTE:** This procedure applies only to computers shipped with an M.2 2230 solid state drive installed.

**NOTE:** The M.2 card installed on your computer depends on the configuration ordered. Supported card configurations on the M.2 card slot:

- M.2 2230 solid state drive
- M.2 2280 solid state drive

The following images indicate the location of the M.2 2230 solid state drive and provide a visual representation of the removal procedure.



1x  
M2x2

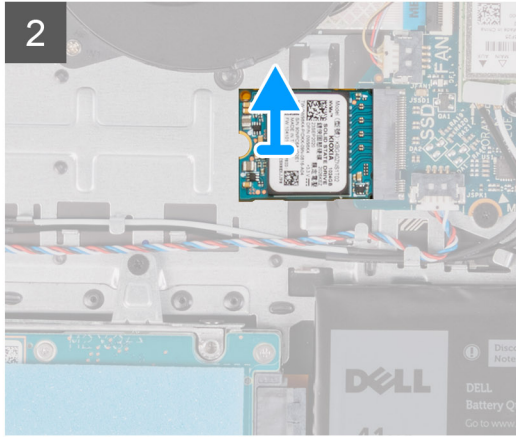
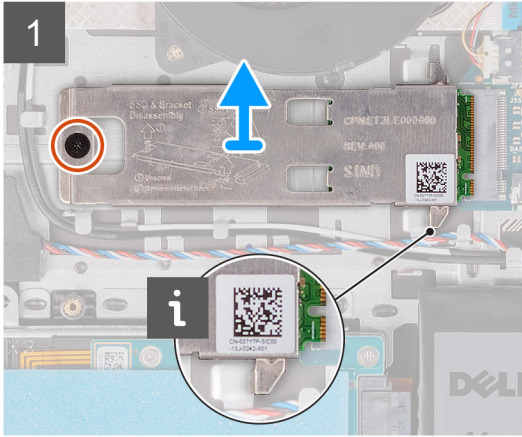
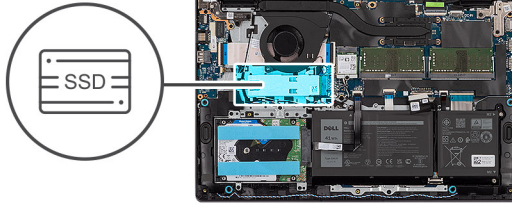

### Steps

1. Remove the (M2x2) screw that secures the M.2 thermal plate to the palm-rest and keyboard assembly.
2. Slide and lift the solid state drive thermal plate off the solid state drive.
3. Slide and remove the M.2 2230 solid state drive from the M.2 card slot on the system board.

## Installing the M.2 2230 solid state drive

### Prerequisites

If you are replacing a component, remove the existing component before performing the installation process.

### About this task

- i** **NOTE:** This procedure applies if you are installing a M.2 2230 solid state drive.
- i** **NOTE:** The M.2 card installed on your computer depends on the configuration ordered. Supported card configurations on the M.2 card slot:
  - M.2 2230 solid state drive
  - M.2 2280 solid state drive

The following images indicate the location of the M.2 2230 solid state drive and provide a visual representation of the installation procedure.

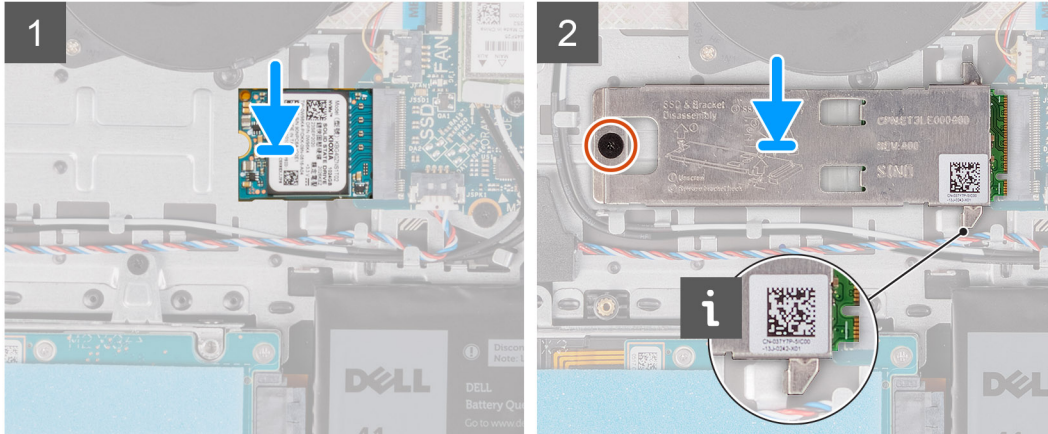
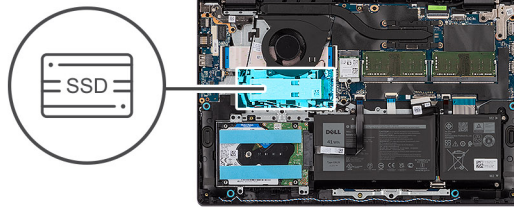

### Steps

1. Align the notch on the M.2 2230 solid state drive with the tab on the M.2 card slot on the system board.
2. Slide the M.2 2230 solid state drive into the M.2 card slot on the system board .
3. Place the M.2 thermal plate on the M.2 2230 solid state drive.
4. Align the screw holes on the M.2 thermal plate with the screw holes on the palm-rest and keyboard assembly.
5. Replace the (M2x2) screw that secures the M.2 thermal plate to the palm-rest and keyboard assembly.

### Next steps

1. Install the [base cover](#).
2. Install the [SD card](#).
3. Follow the procedure in [After working inside your computer](#).

## Removing the M.2 2280 solid state drive

### Prerequisites

1. Follow the procedure in [Before working inside your computer](#).
2. Remove the [SD card](#).
3. Remove the [base cover](#).

### About this task

**NOTE:** This procedure applies only to computers shipped with a M.2 2280 solid state drive installed.

**NOTE:** The M.2 card installed on your computer depends on the configuration ordered. Supported card configurations on the M.2 card slot:

- M.2 2230 solid state drive
- M.2 2280 solid state drive

The following images indicate the location of the M.2 2280 solid state drive and provide a visual representation of the removal procedure.



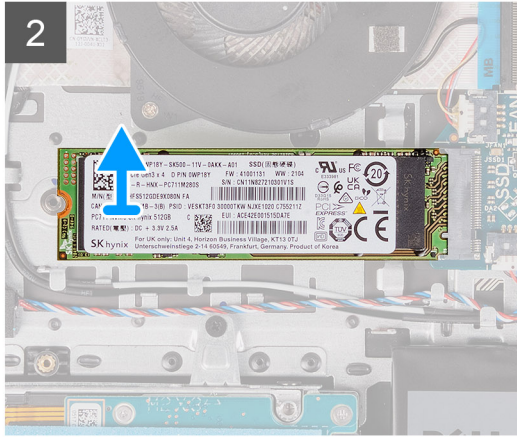
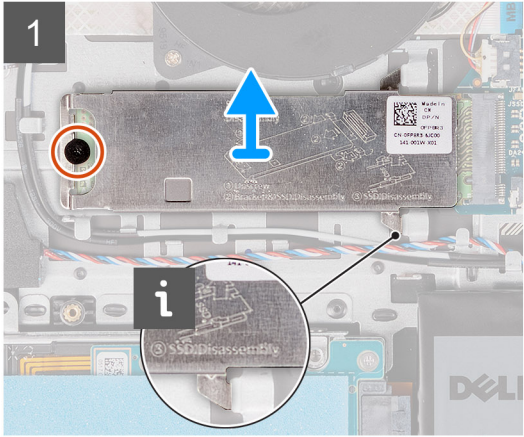
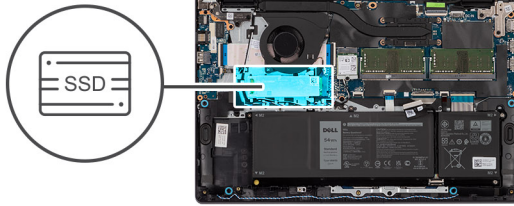

### Steps

1. Remove the (M2x2) screw that secures the M.2 thermal plate to the palm-rest and keyboard assembly.
2. Slide and lift the solid state drive thermal plate off the solid state drive.
3. Slide and remove the M.2 2280 solid state drive from the M.2 card slot on the system board.

## Installing the M.2 2280 solid state drive

### Prerequisites

If you are replacing a component, remove the existing component before performing the installation process.

### About this task

**i** **NOTE:** This procedure applies if you are installing a M.2 2280 solid state drive.

**i** **NOTE:** The M.2 card installed on your computer depends on the configuration ordered. Supported card configurations on the M.2 card slot:

- M.2 2230 solid state drive
- M.2 2280 solid state drive

The following images indicate the location of the M.2 2280 solid state drive and provide a visual representation of the installation procedure.



1x  
M2x2

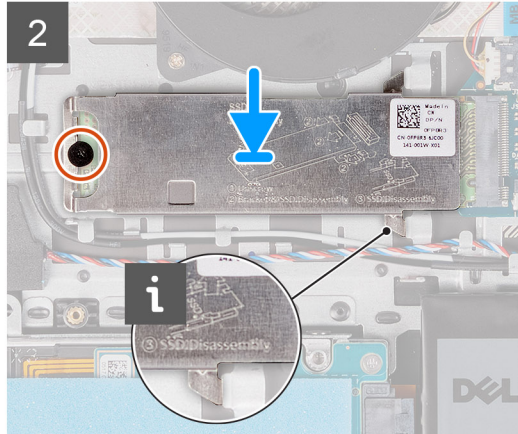
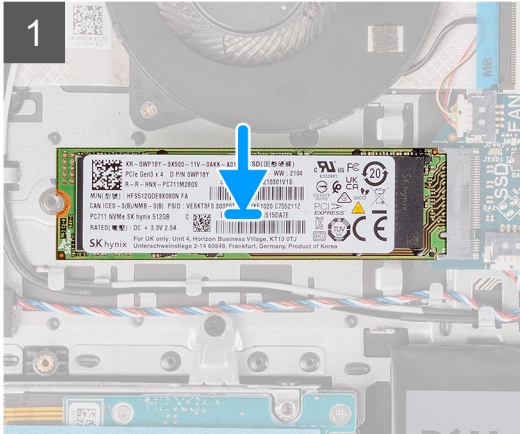
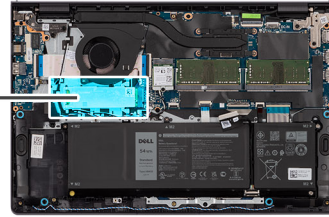

### Steps

1. Align the notch on the M.2 2280 solid state drive with the tab on the M.2 card slot on the system board.
2. Slide the M.2 2280 solid state drive into the M.2 card slot on the system board.
3. Place the M.2 thermal plate on the M.2 2280 solid state drive.
4. Align the screw holes on the M.2 thermal plate with the screw holes on the palm-rest and keyboard assembly.
5. Replace the (M2x2) screw that secures the M.2 thermal plate and the M.2 solid state drive to the palm-rest and keyboard assembly.

### Next steps

1. Install the [base cover](#).
2. Install the [SD card](#).
3. Follow the procedure in [After working inside your computer](#).

## Wireless card

### Removing the wireless card

#### Prerequisites

1. Follow the procedure in [Before working inside your computer](#).
2. Remove the [SD card](#).
3. Remove the [base cover](#).

#### About this task

The following images indicate the location of the wireless card and provide a visual representation of the removal procedure.



1x  
M2x3.5

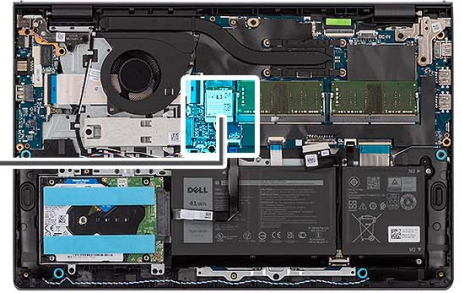

### Steps

1. Remove the screw (M2x3.5) that secures the wireless-card bracket to the system board.
2. Lift the wireless-card bracket from the wireless card.
3. Disconnect the antenna cables from the wireless card.
4. Slide and remove the wireless card from the WLAN slot on the system board.

## Installing the wireless card

### Prerequisites

If you are replacing a component, remove the existing component before performing the installation process.



**About this task**

The following images indicate the location of the wireless card and provide a visual representation of the installation procedure.



**1x**  
M2x3.5

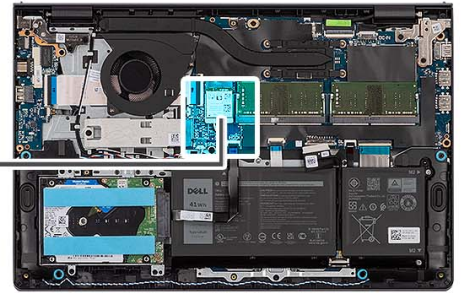

**Steps**

1. Connect the antenna cables to the wireless card.

The following table provides the antenna-cable color scheme for the wireless card supported by your computer.

**Table 2. Antenna-cable color scheme**

Connectors on the wireless card	Antenna-cable color	Silkscreen marking	
Main	White	MAIN	△ (white triangle)
Auxiliary	Black	AUX	▲ (black triangle)

- Slide the wireless card into the WLAN slot on the system board.
- Place the wireless-card bracket on the wireless card.
- Replace the screw (M2x3.5) that secures the wireless-card bracket to the system board.

**Next steps**

- Install the [base cover](#).
- Install the [SD card](#).
- Follow the procedure in [After working inside your computer](#).

## I/O board

### Removing the Input/Output board

**Prerequisites**

- Follow the procedure in [Before working inside your computer](#).
- Remove the [SD card](#).
- Remove the [base cover](#).

**About this task**

The following images indicate the location of the Input/Output board and provide a visual representation of the removal procedure.



2x  
M2x3.5

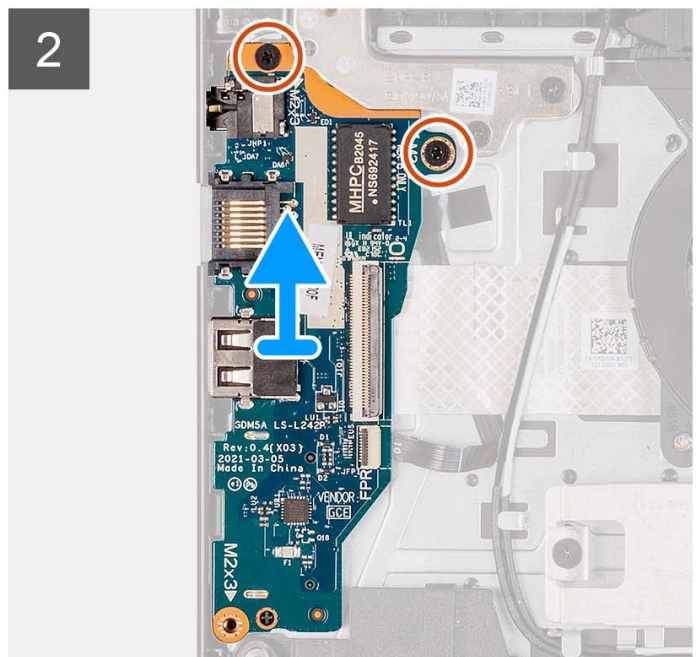
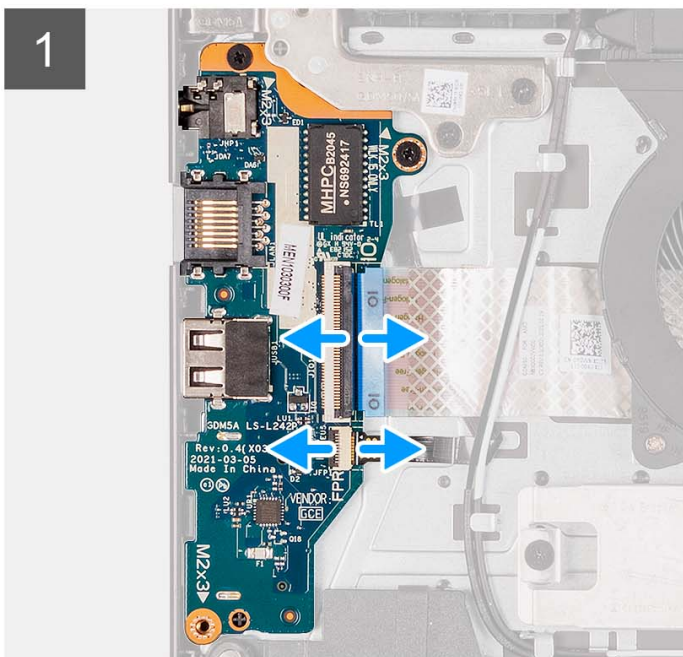

## Steps

1. Open the latch and disconnect the I/O board cable from the I/O board.
2. Open the latch and disconnect the fingerprint-reader board cable from the I/O board (if applicable).
3. Remove the two (M2x3.5) screws that secure the I/O board to the palm-rest and keyboard assembly.
4. Lift the I/O board off the palm-rest and keyboard assembly.

## Installing the Input/Output board

### Prerequisites

If you are replacing a component, remove the existing component before performing the installation process.

### About this task

The following images indicate the location of the I/O board and provide a visual representation of the installation procedure.



2x  
M2x3.5

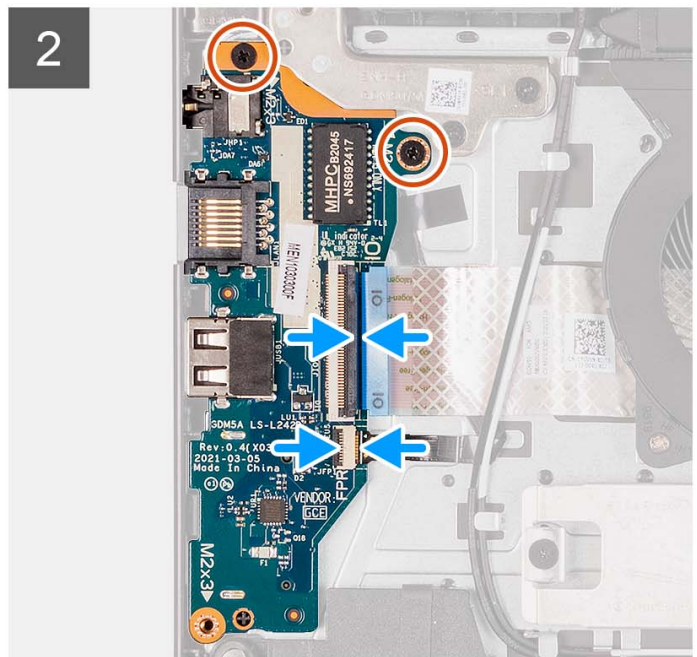
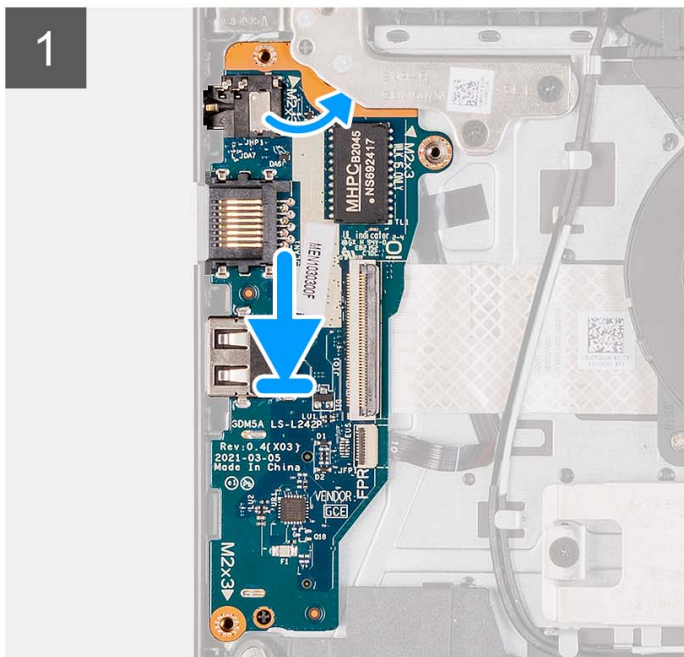

## Steps

1. Place the I/O board on the palm-rest and keyboard assembly.
2. Align the screw holes on the I/O board to the screw holes on the palm-rest and keyboard assembly.
3. Replace the two (M2x3.5) screws that secure the I/O board to the palm-rest and keyboard assembly.
4. Connect the fingerprint-reader board cable to the connector on the I/O board and close the latch (if applicable).
5. Connect the I/O board power cable to the connector on the I/O board and close the latch.

### Next steps

1. Install the [base cover](#).
2. Install the [SD card](#).
3. Follow the procedure in [After working inside your computer](#).

## I/O daughter board FFC

### Removing the Input/Output daughterboard FFC

#### Prerequisites

1. Follow the procedure in [Before working inside your computer](#).
2. Remove the [SD card](#).
3. Remove the [base cover](#).
4. Remove the [fan](#).

#### About this task

The following image indicates the location of the Input/Output daughter board FFC and provides a visual representation of the removal procedure in an aluminum chassis.

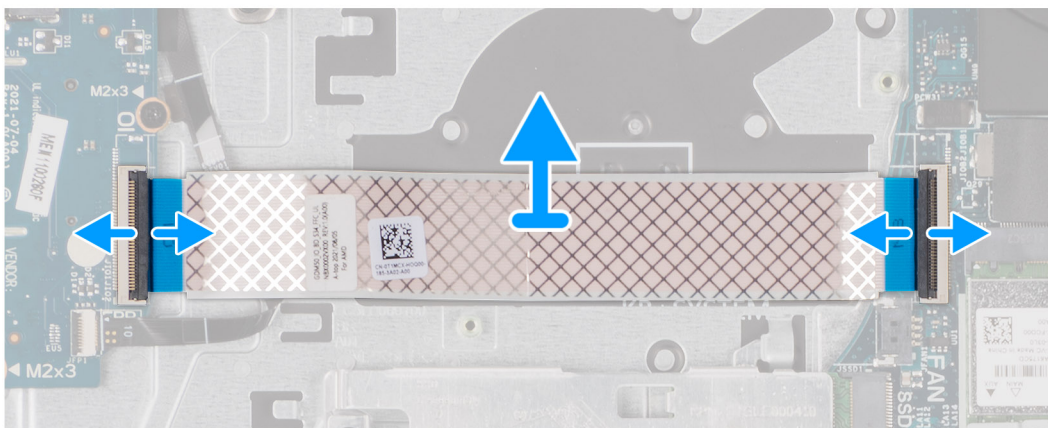
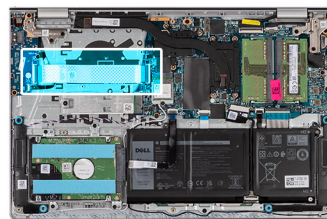

For systems shipped with a plastic chassis:



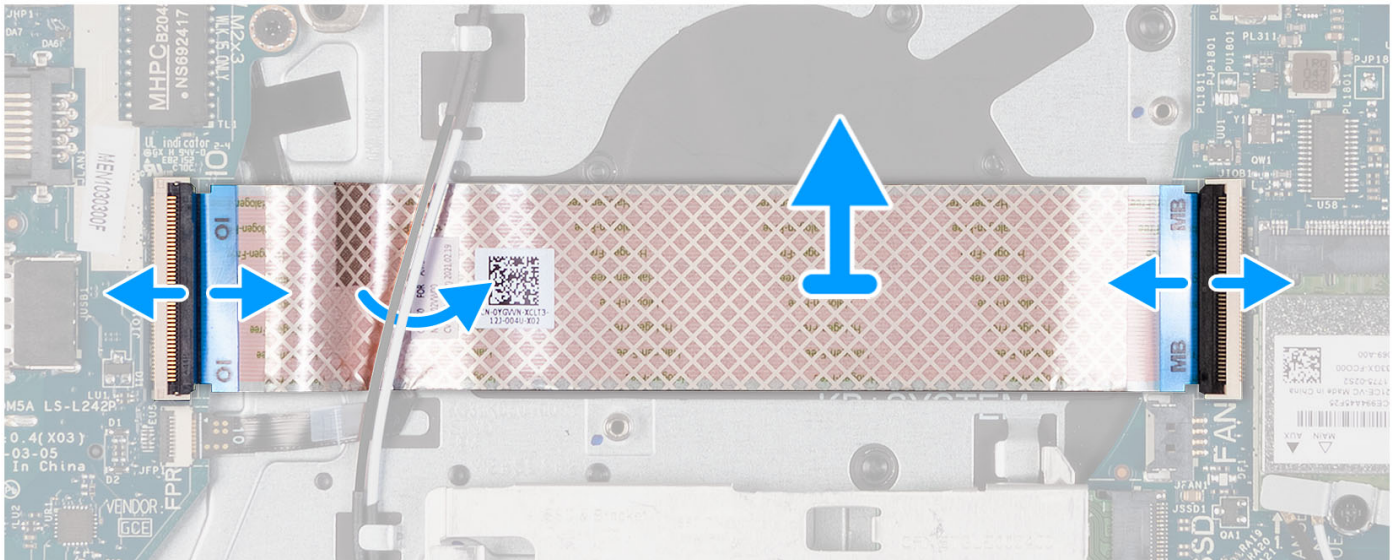
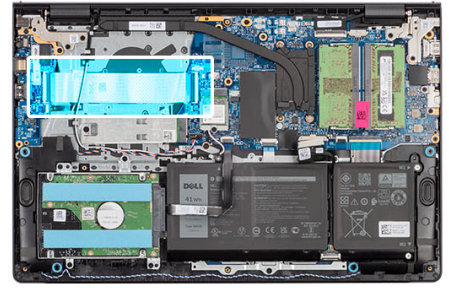

## Steps

1. Open the latch and disconnect the I/O daughter board cable from the I/O board.
2. Open the latch and disconnect the I/O daughter board cable from the system board.
3. Lift the I/O daughter board cable off the palm-rest and keyboard assembly.

**NOTE:** For systems shipped with a plastic chassis, slide the I/O daughter board cable underneath the wireless card antenna cables and lift off the palm-rest and keyboard assembly.

## Installing the Input/Output daughter board FFC

### Prerequisites

If you are replacing a component, remove the existing component before performing the installation process.

### About this task

The following images indicate the location of the I/O daughter board FFC and provide a visual representation of the installation procedure in a system shipped with aluminum chassis:



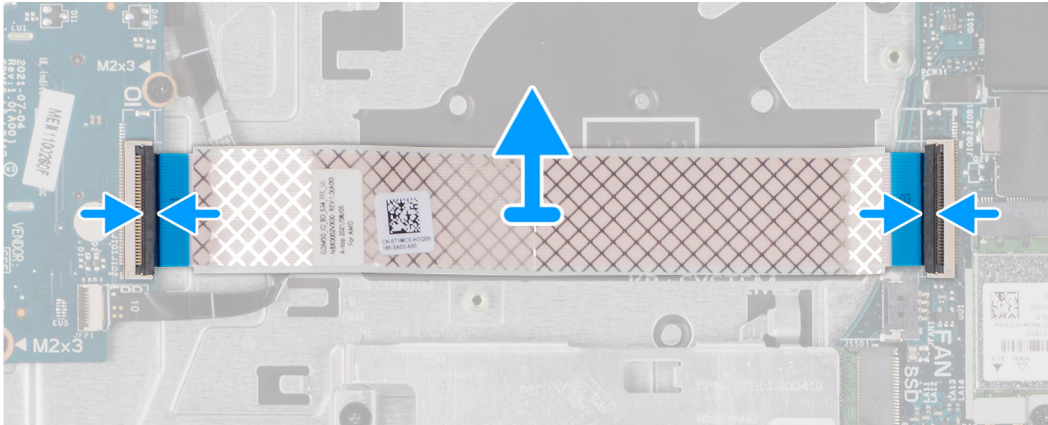
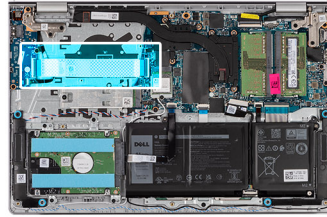

For systems shipped with a plastic chassis:

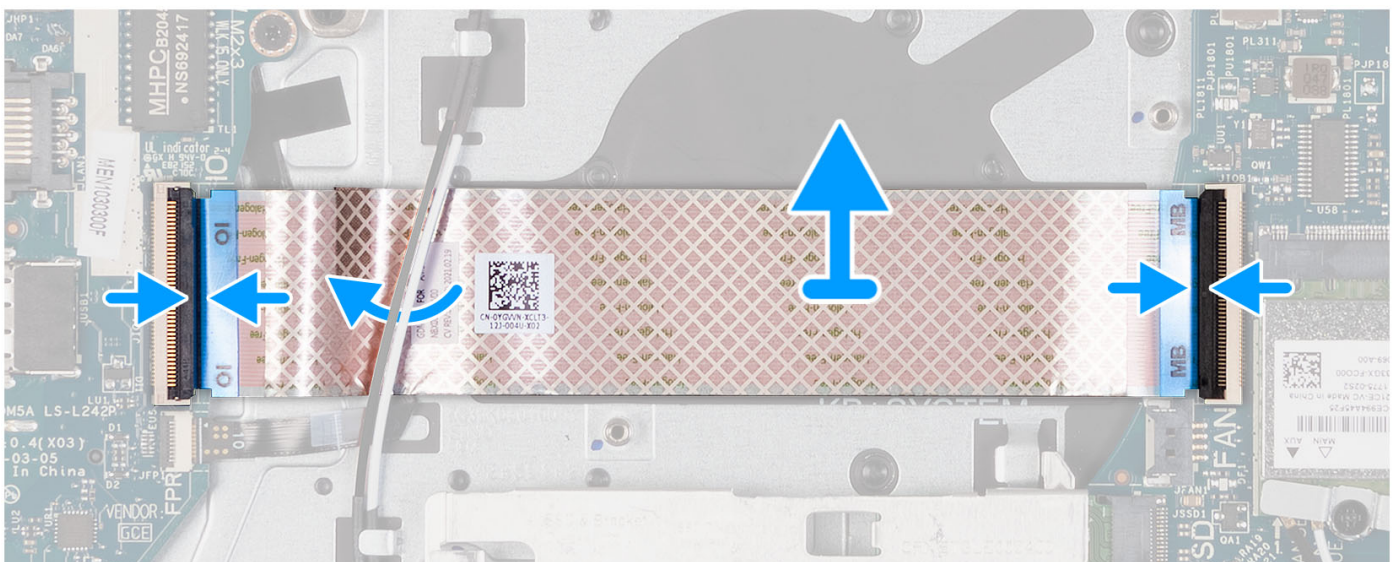
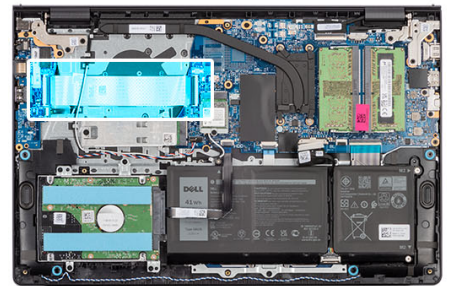

### Steps

1. Place the I/O daughter board FFC on the palm-rest and keyboard assembly.  
For systems shipped with a plastic chassis, slide and place the I/O daughter board FFC underneath the wireless card antenna cables on the palm-rest and keyboard assembly.

2. Connect the I/O daughter board FFC the connector on the I/O board.
3. Connect the I/O daughter board FFC the connector on the system board.

#### Next steps

1. Install the [fan](#).
2. Install the [base cover](#).
3. Install the [SD card](#).
4. Follow the procedure in [After working inside your computer](#).

## Hard drive assembly

### Removing the hard drive

#### Prerequisites

 **NOTE:** Systems with 11<sup>th</sup> Generation Intel Core (or Tiger Lake) do not offer hard drive configuration.

1. Follow the procedure in [Before working inside your computer](#).
2. Remove the [SD card](#).
3. Remove the [base cover](#).

#### About this task

The following images indicate the location of the hard drive and provide a visual representation of the removal procedure.

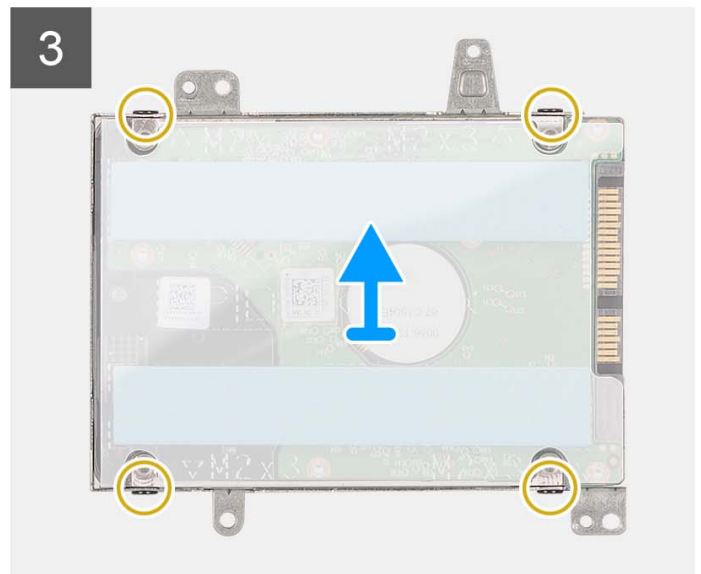
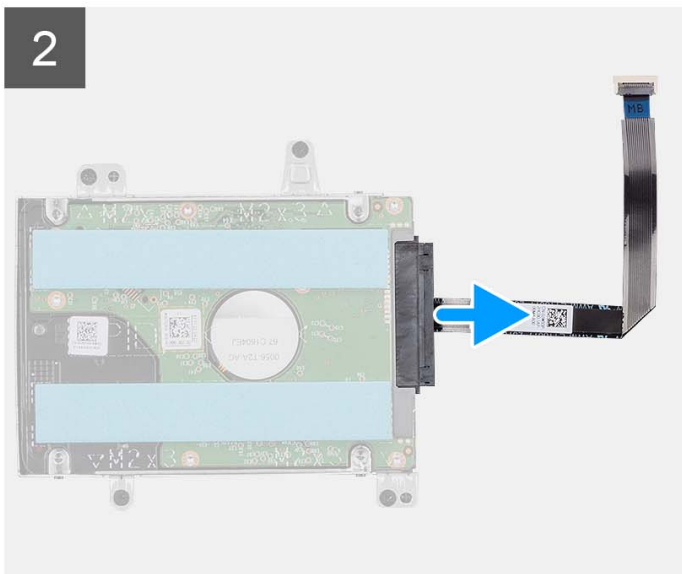
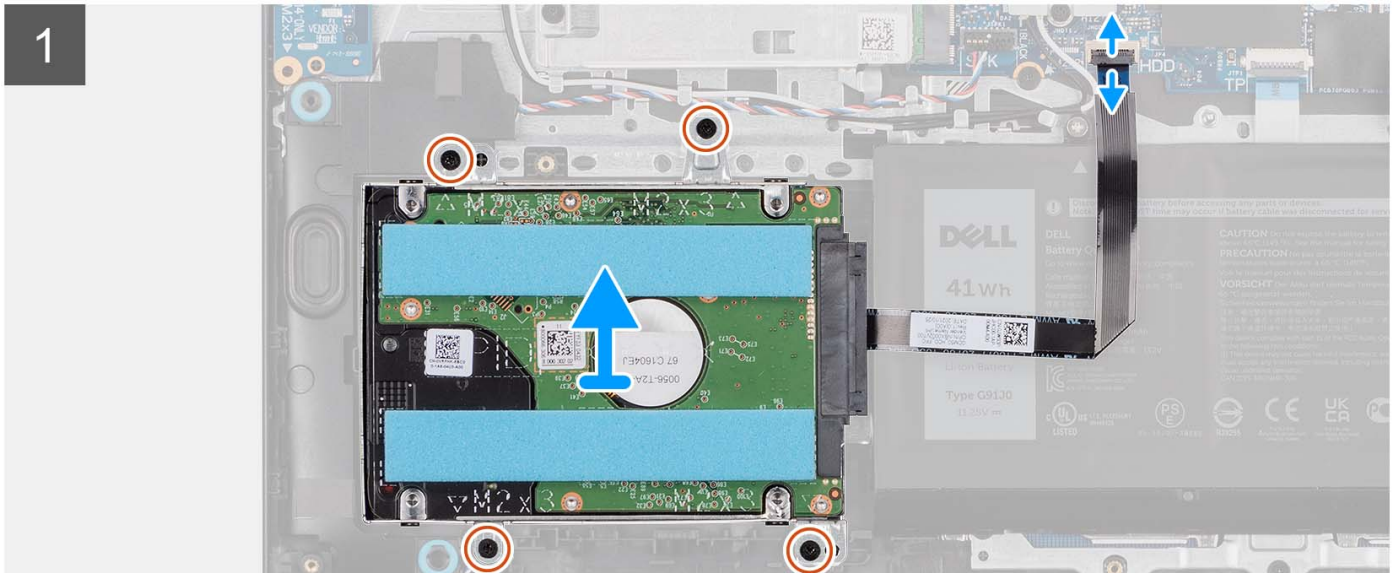
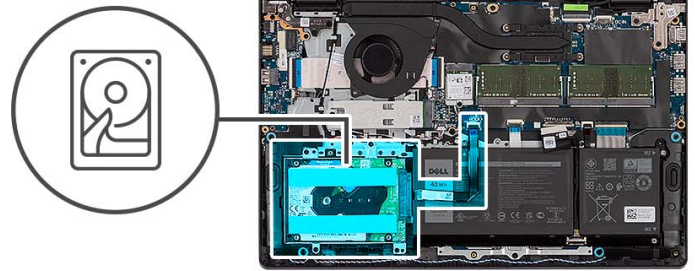

### Steps

1. Disconnect the hard drive cable from the system board.
2. Remove the four (M2x3.5) screws that secure the hard drive assembly to the palm-rest and keyboard assembly.
3. Lift the hard drive assembly and its cable from the palm-rest and keyboard assembly.
4. Disconnect the hard drive cable from the hard drive assembly.
5. Remove the four (M3x3) screws that secure the hard drive to the hard drive bracket.
6. Slide and remove the hard drive from the hard drive bracket.

# Installing the hard drive

## Prerequisites

 **NOTE:** Systems with 11<sup>th</sup> Generation Intel Core (or Tiger Lake) do not offer hard drive configuration.

If you are replacing a component, remove the existing component before performing the installation process.

## About this task

The following images indicate the location of the hard drive assembly and provide a visual representation of the installation procedure.



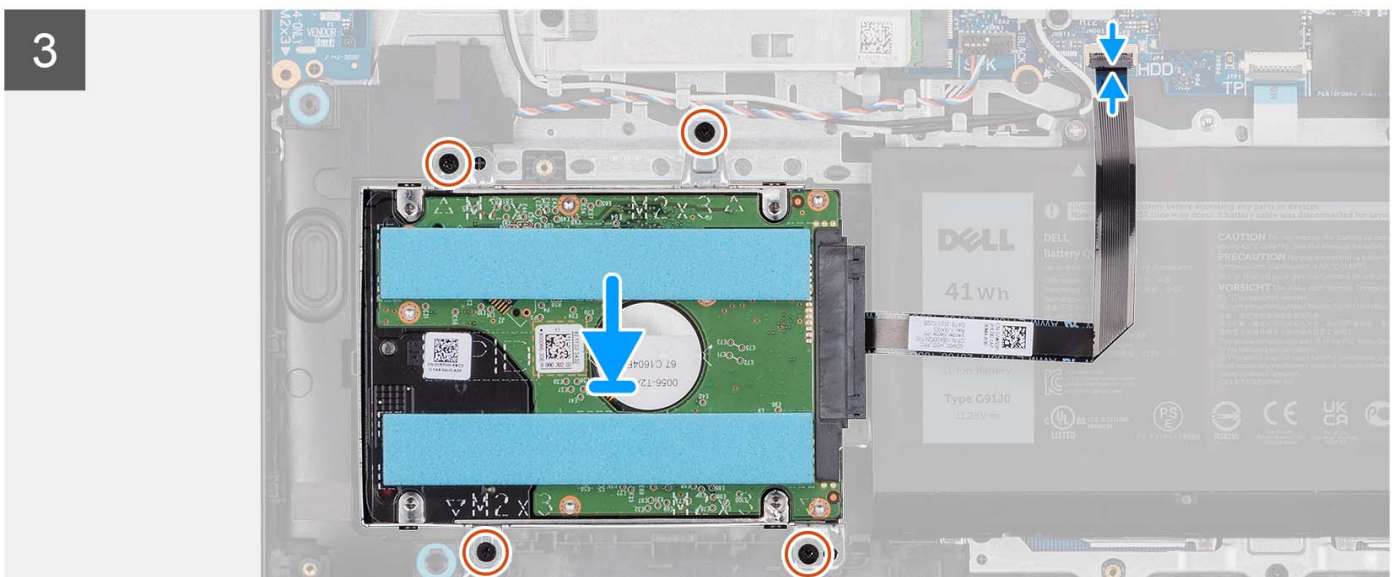
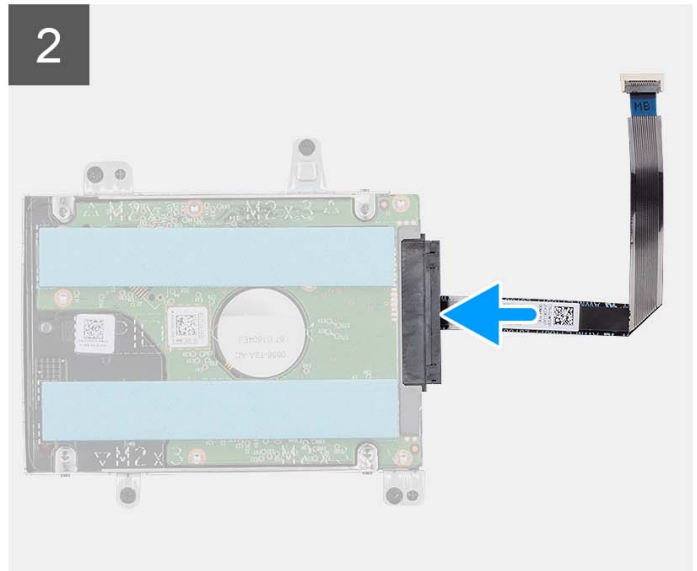
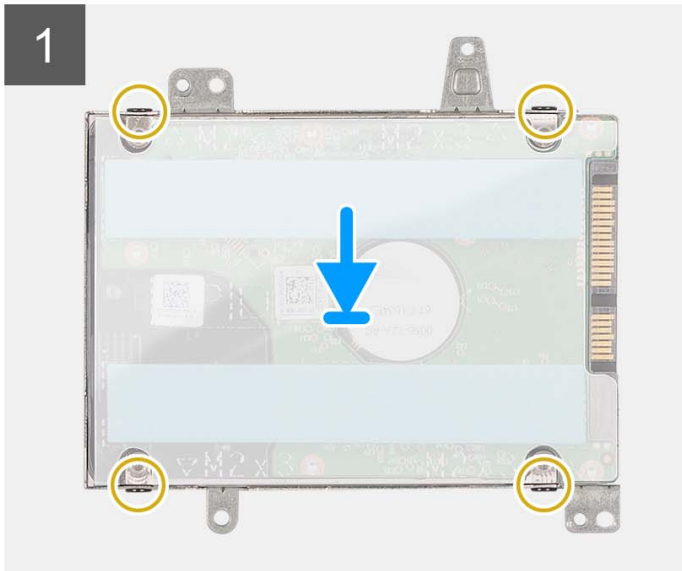
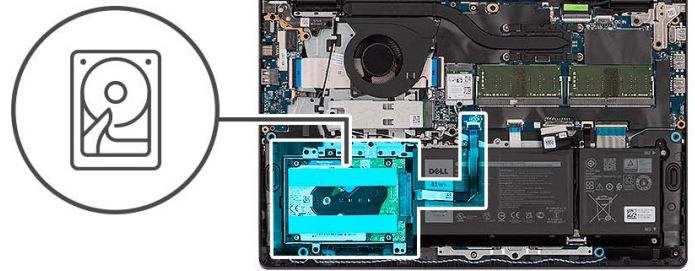

### Steps

1. Place and slide the hard drive into the hard-drive bracket.
2. Align the screw holes on the hard drive bracket with the screw holes on the hard drive.
3. Replace the four (M3x3) screws that secure the hard drive to the hard drive bracket.
4. Connect the hard drive cable to the hard drive assembly.
5. Place the hard drive assembly on the palm-rest and keyboard assembly.
6. Align the screw holes on the hard drive assembly to the screw holes on the palm-rest and keyboard assembly.
7. Replace the four (M2x3.5) screws that secure the hard drive assembly to the palm-rest and keyboard assembly.



8. Connect the hard drive cable to the connector on the system board.

### Next steps

1. Install the [base cover](#).
2. Install the [SD card](#).
3. Follow the procedure in [After working inside your computer](#).

## Memory modules

### Removing the memory modules

#### Prerequisites

1. Follow the procedure in [Before working inside your computer](#).
2. Remove the [SD card](#).
3. Remove the [base cover](#).

#### About this task

The following images indicate the location of the memory modules and provide a visual representation of the removal procedure.

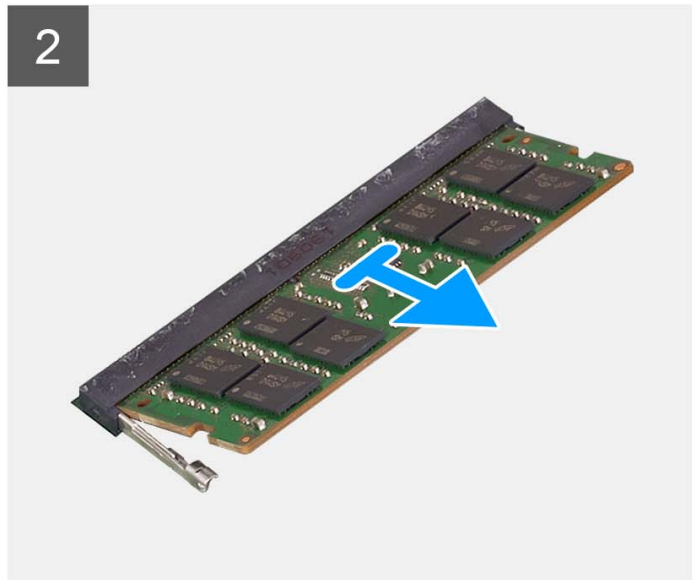
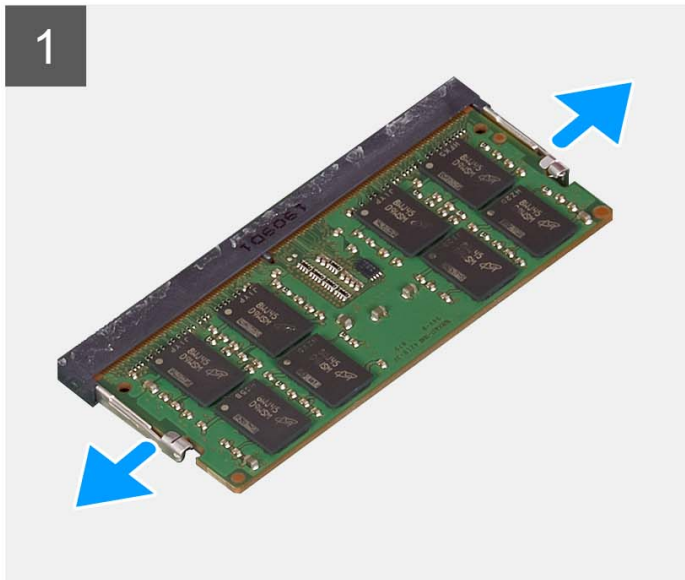
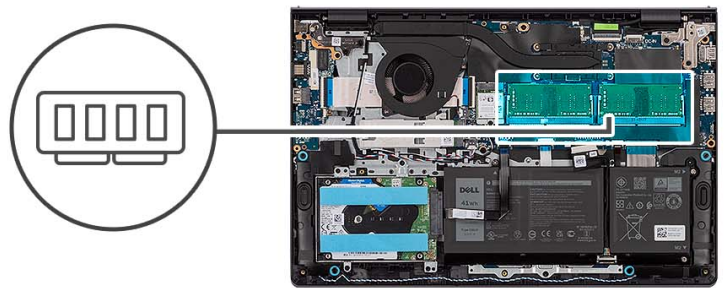

#### Steps

1. Using your fingertips, carefully spread apart the securing-clips on each end of the memory-module slot until the memory module pops-up.
2. Remove the memory module from the memory-module slot on the system board.

**NOTE:** Your computer may have up to two memory modules installed. Repeat steps 1 to 2 if there is a second memory module installed.

## Installing the memory modules

### Prerequisites

If you are replacing a component, remove the existing component before performing the installation process.

### About this task

The following images indicate the location of the memory modules and provide a visual representation of the installation procedure.

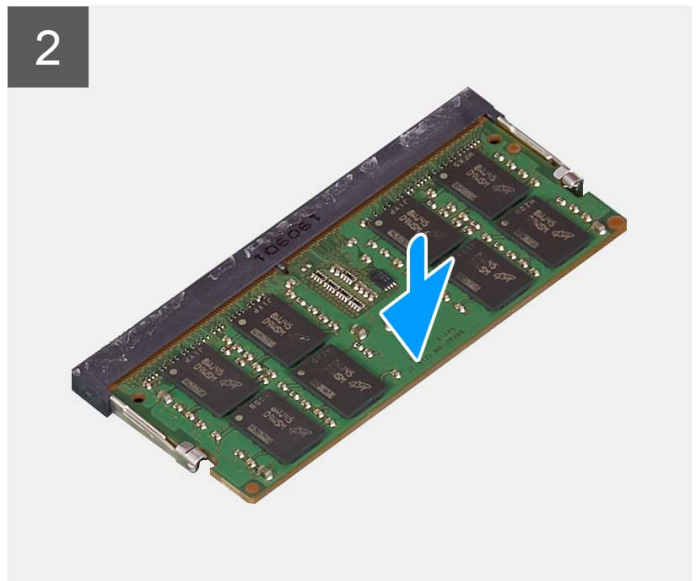
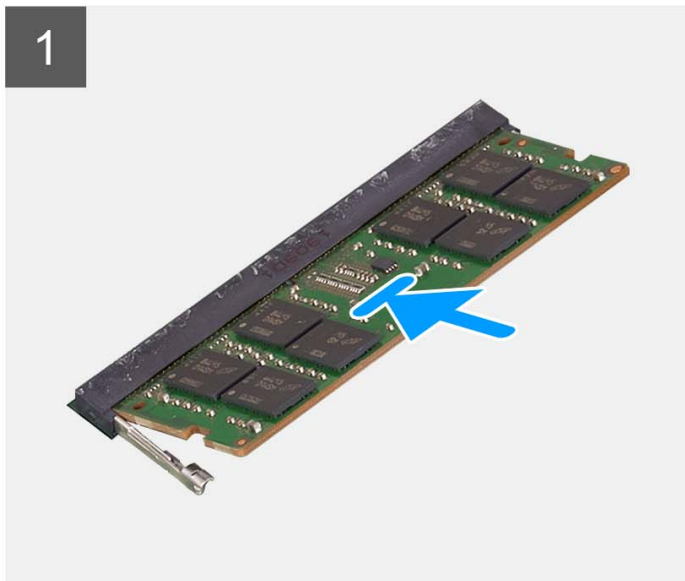
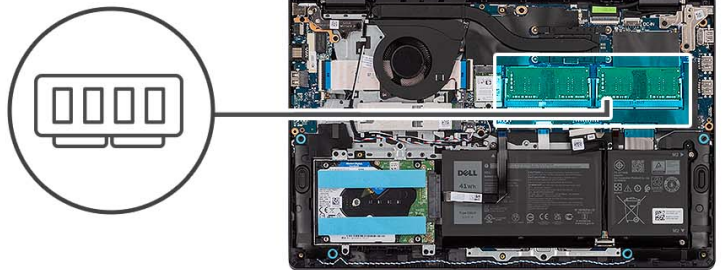

### Steps

1. Align the notch on the memory module with the tab on the memory-module slot on the system board.
2. Slide the memory module into the memory-module slot on the system board.
3. Press down on the memory module until the securing clips click, locking the memory module in place.

**NOTE:** Repeat steps 1 to 3 if there is a second memory module to be installed into your computer.

### Next steps

1. Install the [base cover](#).
2. Install the [SD card](#).
3. Follow the procedure in [After working inside your computer](#).

# Speakers

## Removing the speakers

### Prerequisites

1. Follow the procedure in [Before working inside your computer](#).
2. Remove the [SD card](#).
3. Remove the [base cover](#).

### About this task

The following images indicate the location of the speakers and provide a visual representation of the removal procedure.

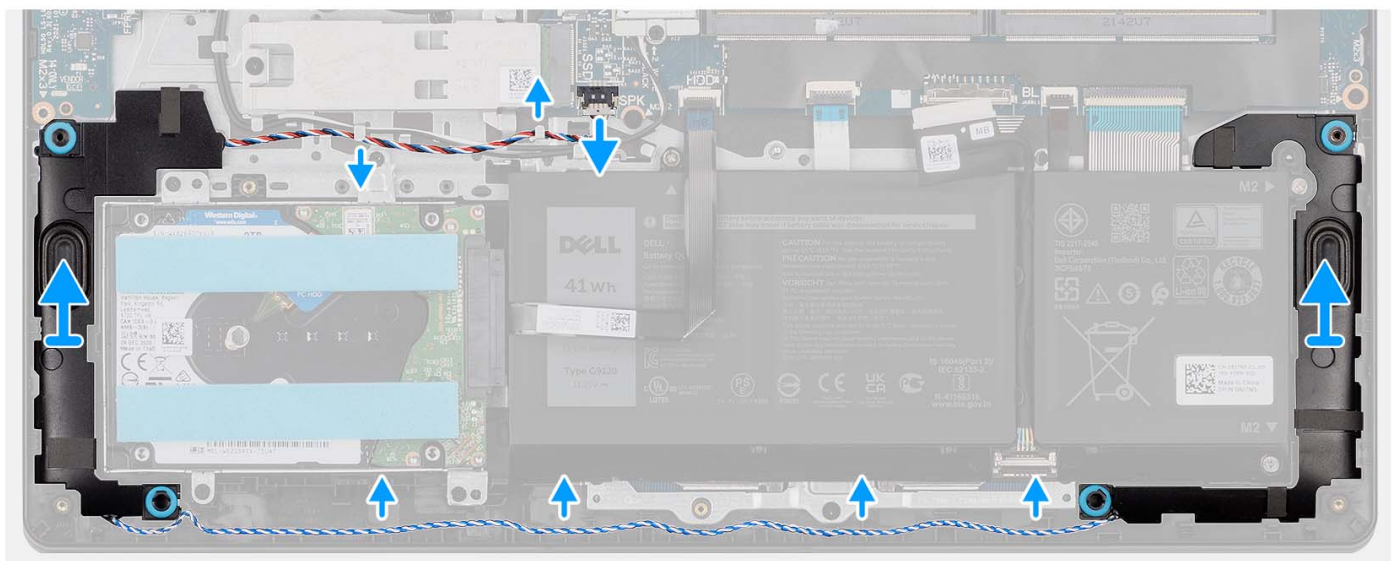
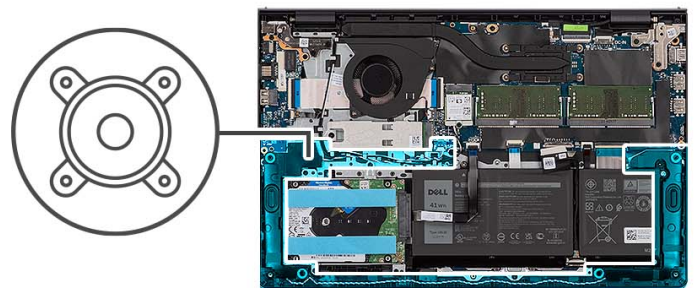

### Steps

1. Disconnect the speaker cable from the system board.
2. Unroute the speaker cable from the routing guides on the palm-rest and keyboard assembly.
3. Lift the speakers along with its cable from the palm-rest and keyboard assembly.

## Installing the speakers

### Prerequisites

If you are replacing a component, remove the existing component before performing the installation process.

## About this task

The following images indicate the location of the speakers and provide a visual representation of the installation procedure.

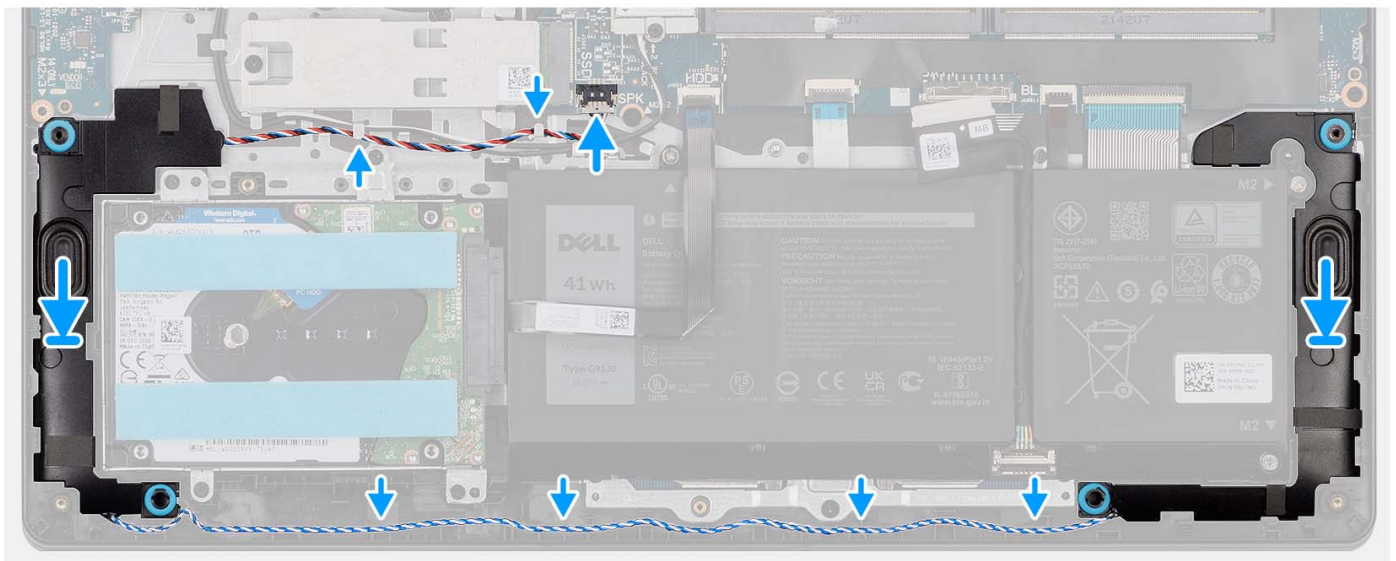
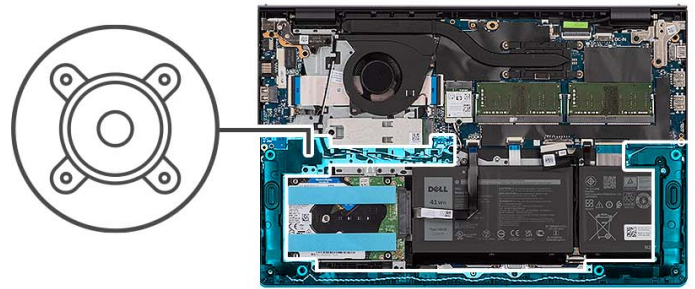

## Steps

1. Using the alignment posts, place the speakers on the palm-rest and keyboard assembly.

**NOTE:** Ensure that the alignment posts are threaded through the rubber grommets on the speaker.

2. Route the speaker cable through the routing guides on the palm-rest and keyboard assembly.
3. Connect the speaker cable to the system board.

## Next steps

1. Install the [base cover](#).
2. Install the [SD card](#).
3. Follow the procedure in [After working inside your computer](#).

# Heat sink

## Removing the heat sink

### Prerequisites

1. Follow the procedure in [Before working inside your computer](#).
2. Remove the [SD card](#).
3. Remove the [base cover](#).



### About this task

- NOTE:** The heat sink may become hot during normal operation. Allow sufficient time for the heat sink to cool before you touch it.
- NOTE:** For maximum cooling of the processor, do not touch the heat transfer areas on the heat sink. The oils in your skin can reduce the heat transfer capability of the thermal grease.

The following images indicate the location of the UMA heat sink and provide a visual representation of the removal procedure.

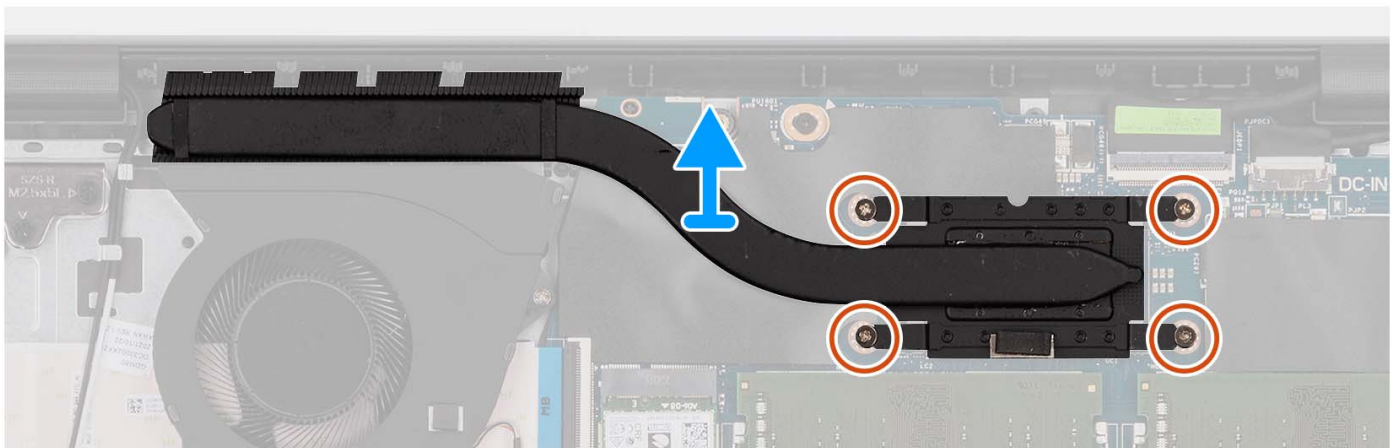
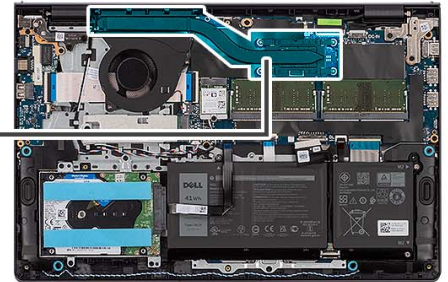

### Steps

- Loosen the four captive screws that secure the heat sink to the system board.
  - NOTE:** Loosen the captive screws in the reverse sequential order mentioned on the heat sink [4 > 3 > 2 > 1].
  - NOTE:** The number of screws varies depending on the configuration ordered.
- Lift the heat sink from the system board.

## Installing the heat sink

### Prerequisites

If you are replacing a component, remove the existing component before performing the installation process.

### About this task

- NOTE:** If either the system board or the heat sink is replaced, use the thermal grease provided in the kit to ensure that thermal conductivity is achieved.

The following images indicate the location of the UMA heat sink and provide a visual representation of the installation procedure.





**4x**  
M2x3

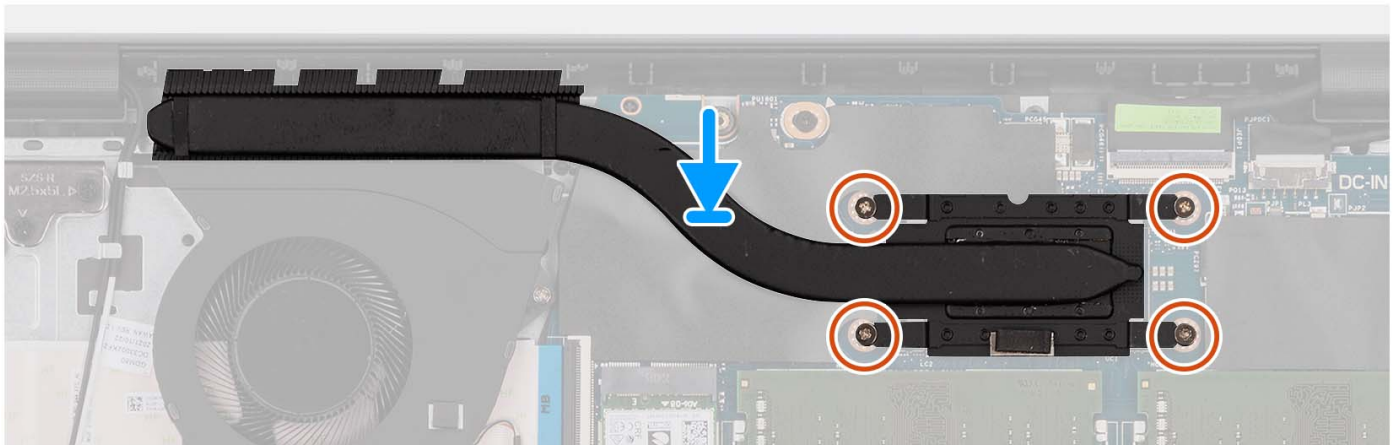
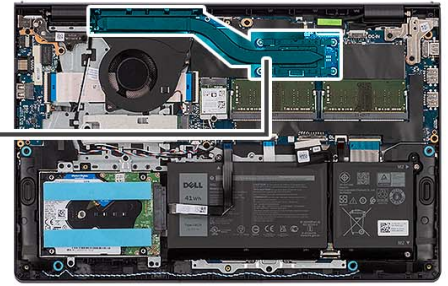

### Steps

1. Place the heat sink on the system board.
2. Tighten the four captive screws that secure the heat sink to the system board.
  - NOTE:** Tighten the captive screws in the sequential order mentioned on the heat sink [1 > 2 > 3 > 4].
  - NOTE:** The number of screws varies depending on the configuration ordered.

### Next steps

1. Install the [base cover](#).
2. Install the [SD card](#).
3. Follow the procedure in [After working inside your computer](#).

## Fan

### Removing the fan

#### Prerequisites

1. Follow the procedure in [Before working inside your computer](#).
2. Remove the [SD card](#).
3. Remove the [base cover](#).

#### About this task

The following images indicate the location of the fan and provide a visual representation of the removal procedure.



**2x**  
M2x5

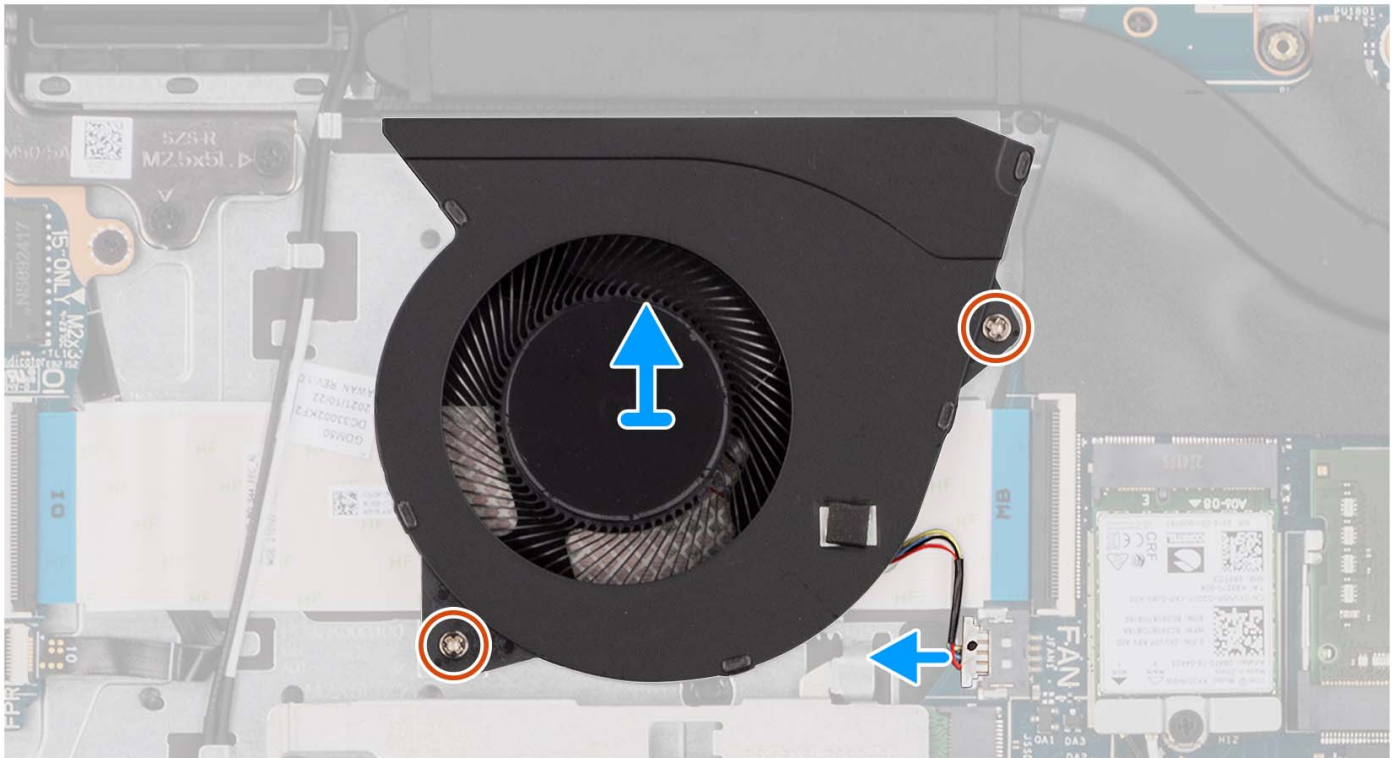
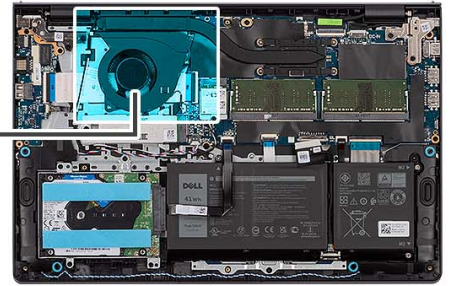
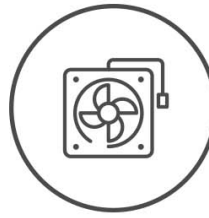

### Steps

1. Disconnect the fan cable from the system board.
2. Remove the two (M2x5) screws that secure the fan to the palm-rest and keyboard assembly.
3. Lift the fan from the palm-rest and keyboard assembly.

## Installing the fan

### Prerequisites

If you are replacing a component, remove the existing component before performing the installation process.

### About this task

The following images indicate the location of the fan and provide a visual representation of the installation procedure.



2x  
M2x5

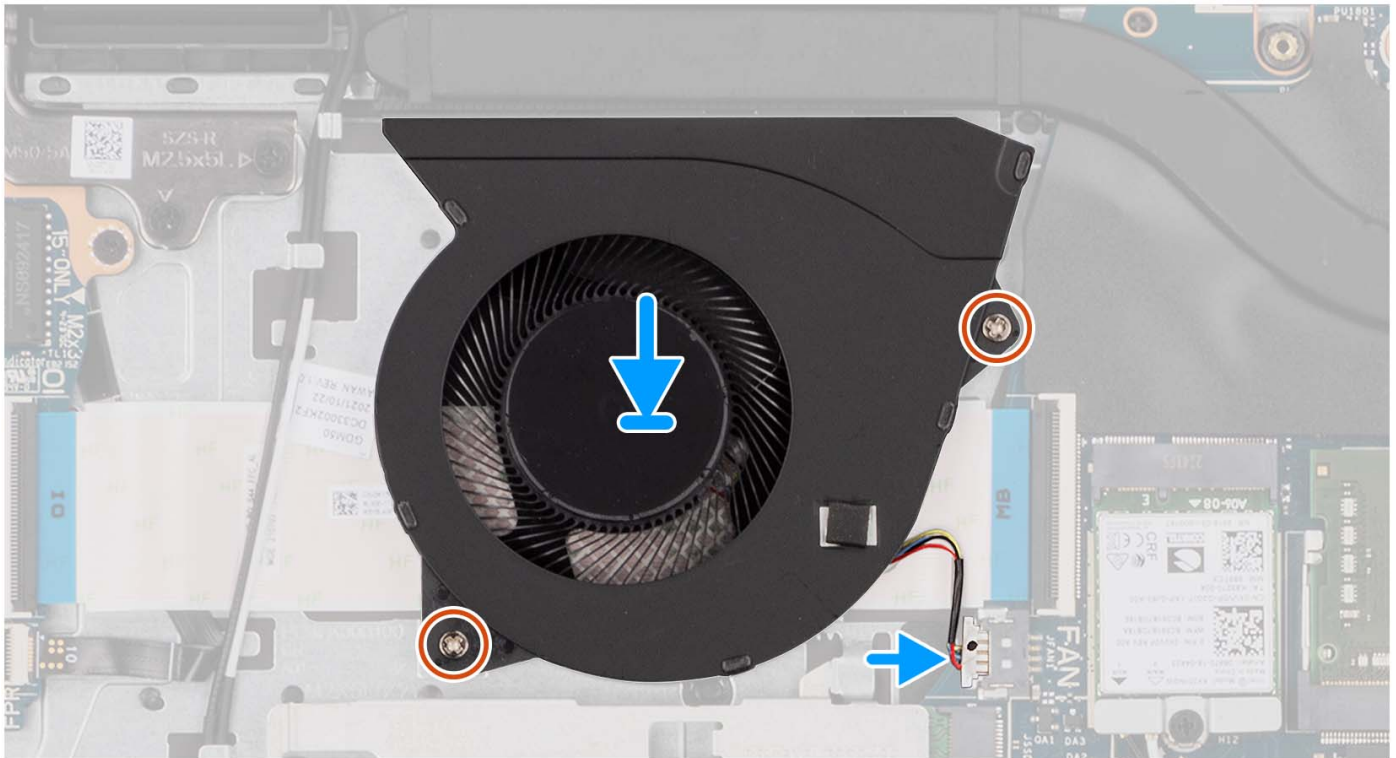
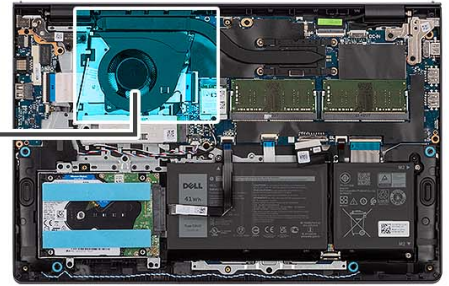
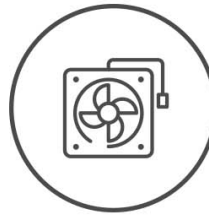

### Steps

1. Place the fan on the palm-rest and keyboard assembly.
2. Align the screw holes on the fan to the screw holes on the palm-rest and keyboard assembly.
3. Replace the two (M2x5) screws that secure the fan to the palm-rest and keyboard assembly.
4. Connect the fan cable to the connector on the system board.

### Next steps

1. Install the [base cover](#).
2. Install the [SD card](#).
3. Follow the procedure in [After working inside your computer](#).

## Power-button board

### Removing the power button

#### Prerequisites

1. Follow the procedure in [Before working inside your computer](#).
2. Remove the [SD card](#).

3. Remove the [base cover](#).
4. Remove the [wireless card](#).
5. Remove the [I/O board](#).
6. Remove the [display assembly](#).

### About this task

The following images indicate the location of the power button and provide a visual representation of the removal procedure.



**1x**  
M2x2

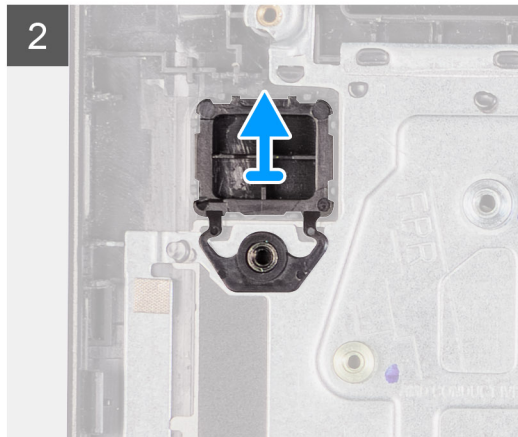
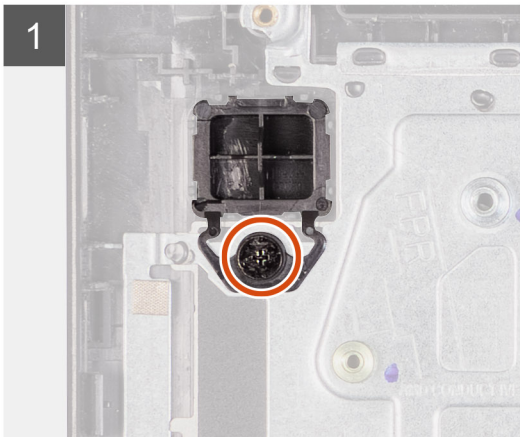
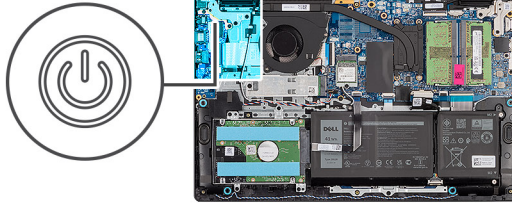

### Steps

1. Remove the single (M2x2) screw securing the power button to the palm-rest and keyboard assembly.
2. Remove the power button from the computer.

## Installing the power button

### Prerequisites

If you are replacing a component, remove the existing component before performing the installation procedure.

### About this task

The following images indicate the location of the power button and provide a visual representation of the installation procedure.





1x  
M2x2

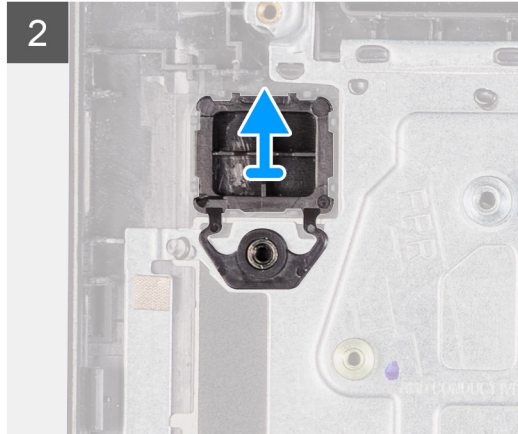
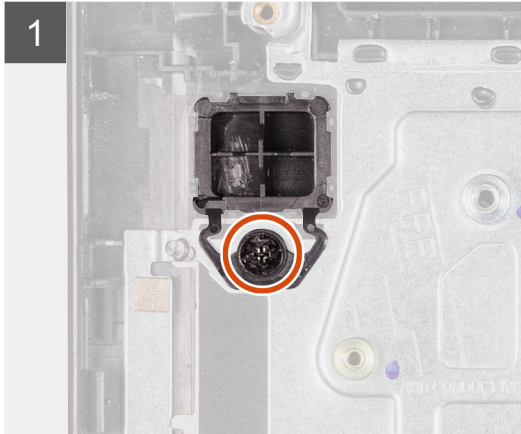
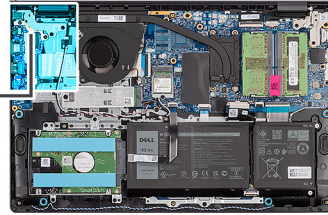

### Steps

1. Place the power-button board into the slot on the palm-rest and keyboard assembly.
2. Install the single (M2x2) screw to secure the power button to the palm-rest and keyboard assembly.

### Next steps

1. Install the [display assembly](#).
2. Install the [wireless card](#).
3. Install the [I/O board](#).
4. Install the [base cover](#).
5. Install the [SD card](#).
6. Follow the procedure in [After working inside your computer](#).

## Power button with fingerprint reader

### Removing the power button with optional fingerprint reader

#### Prerequisites

1. Follow the procedure in [Before working inside your computer](#).
2. Remove the [SD card](#).
3. Remove the [base cover](#).
4. Remove the [wireless card](#).
5. Remove the [I/O board](#).
6. Remove the [display assembly](#).

#### About this task

The following images indicate the location of the power button with optional fingerprint reader and provide a visual representation of the removal procedure.





1x  
M2x2

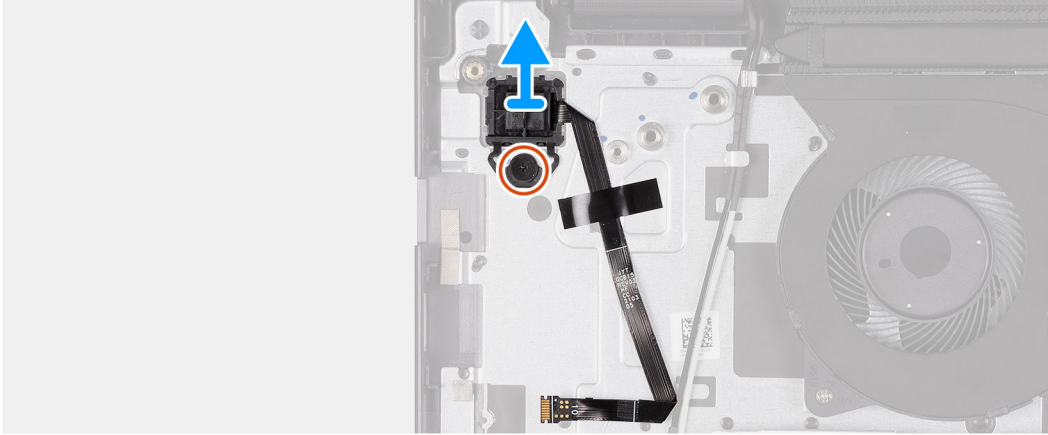
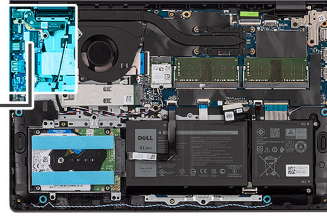

### Steps

1. Remove the (M2x2) screw that secures the power button to the palm-rest and keyboard assembly.
2. Peel the fingerprint reader Flexible Flat cable from the palm-rest and keyboard assembly.
3. Lift the power button with fingerprint reader, along with its cable, off the palm-rest and keyboard assembly.

## Installing the power button with optional fingerprint reader

### Prerequisites

If you are replacing a component, remove the existing component before performing the installation process.

### About this task

The following images indicate the location of the power button with optional fingerprint reader and provide a visual representation of the installation procedure.



1x  
M2x2

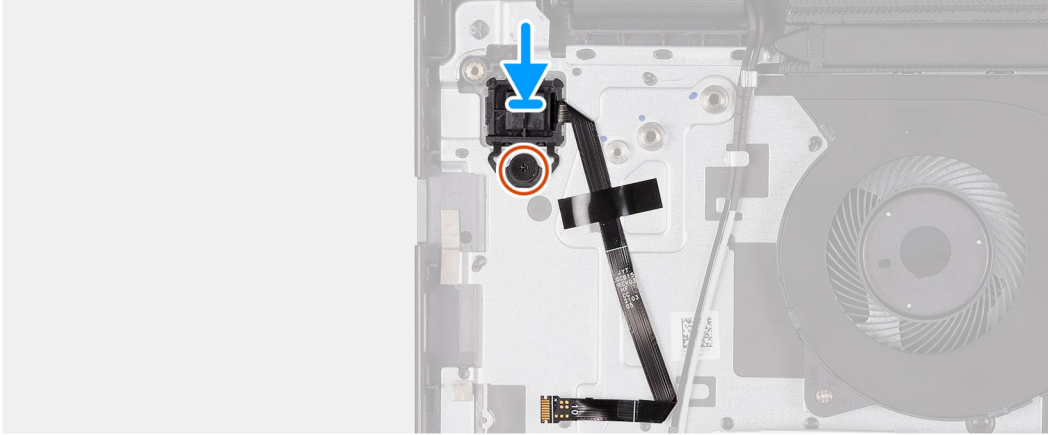
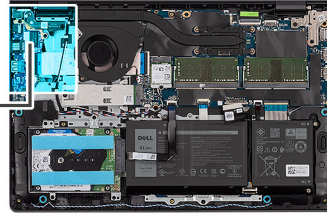

### Steps

1. Using the alignment posts, place the power button with fingerprint reader into its slot on the palm-rest and keyboard assembly.
2. Replace the (M2x2) screw that secures the power button with fingerprint reader to the palm-rest and keyboard assembly.
3. Adhere the fingerprint reader Flexible Flat cable to the palm-rest and keyboard assembly.

 **NOTE:** Fold and align the fingerprint reader Flexible Flat cable to the mark at the right of the power button, and align the white line on the Flexible Flat cable to the mark on the palm-rest and keyboard assembly.

### Next steps

1. Install the [display assembly](#).
2. Install the [wireless card](#).
3. Install the [I/O board](#).
4. Install the [base cover](#).
5. Install the [SD card](#).
6. Follow the procedure in [After working inside your computer](#).

## Display assembly

### Removing the display assembly

 **CAUTION:** The maximum operating angle for the display-panel hinge is 135 degrees.

### Prerequisites

1. Follow the procedure in [Before working inside your computer](#).
2. Remove the [SD card](#).
3. Remove the [base cover](#).
4. Remove the [wireless card](#).

### About this task

The following images indicate the location of the display assembly and provide a visual representation of the removal procedure.



4x  
M2.5x5

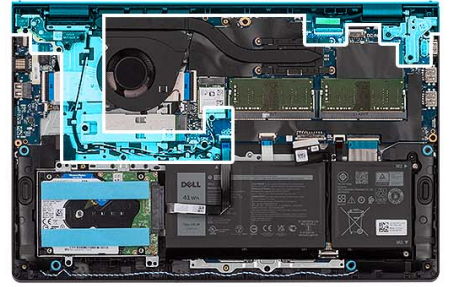

1

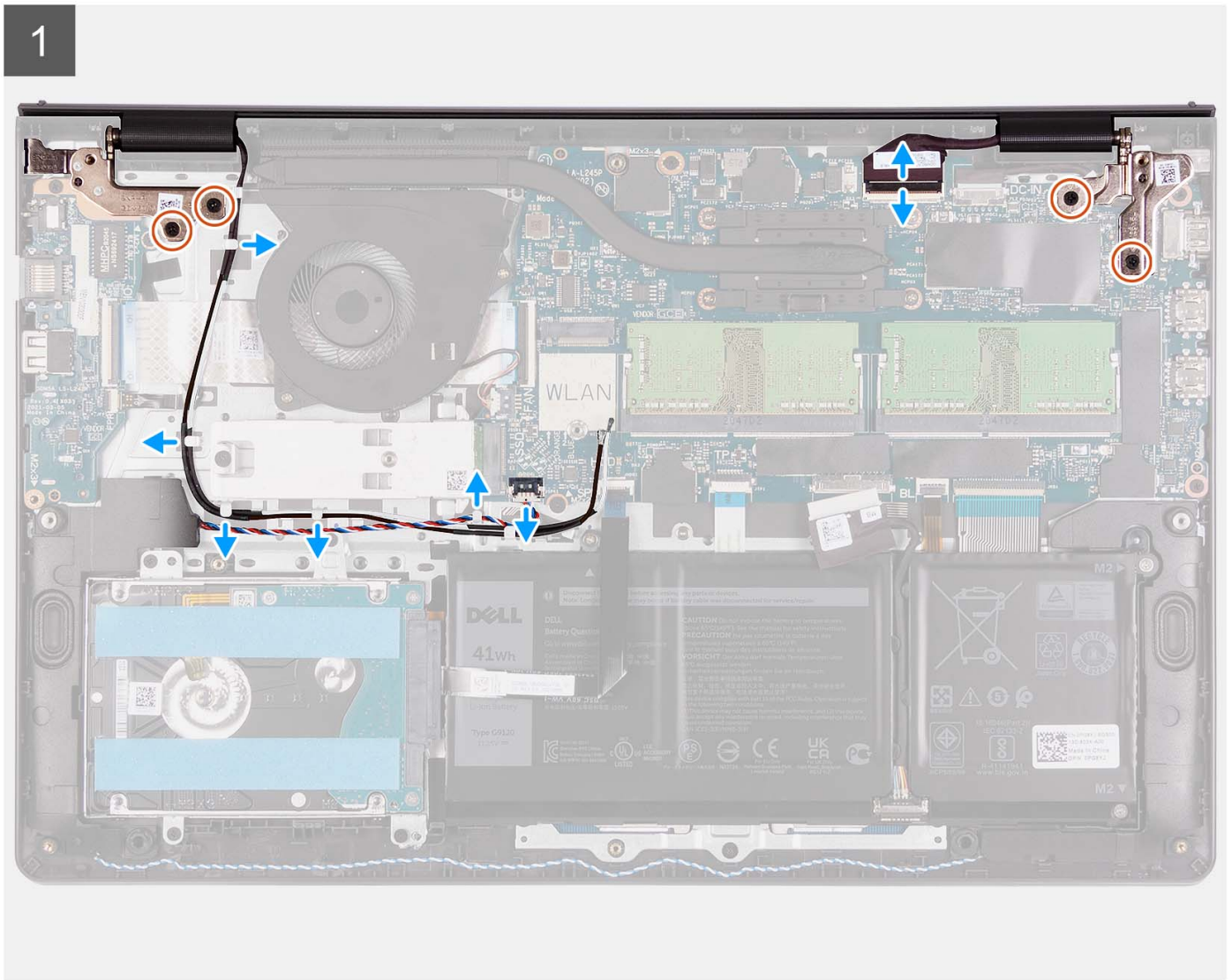

2

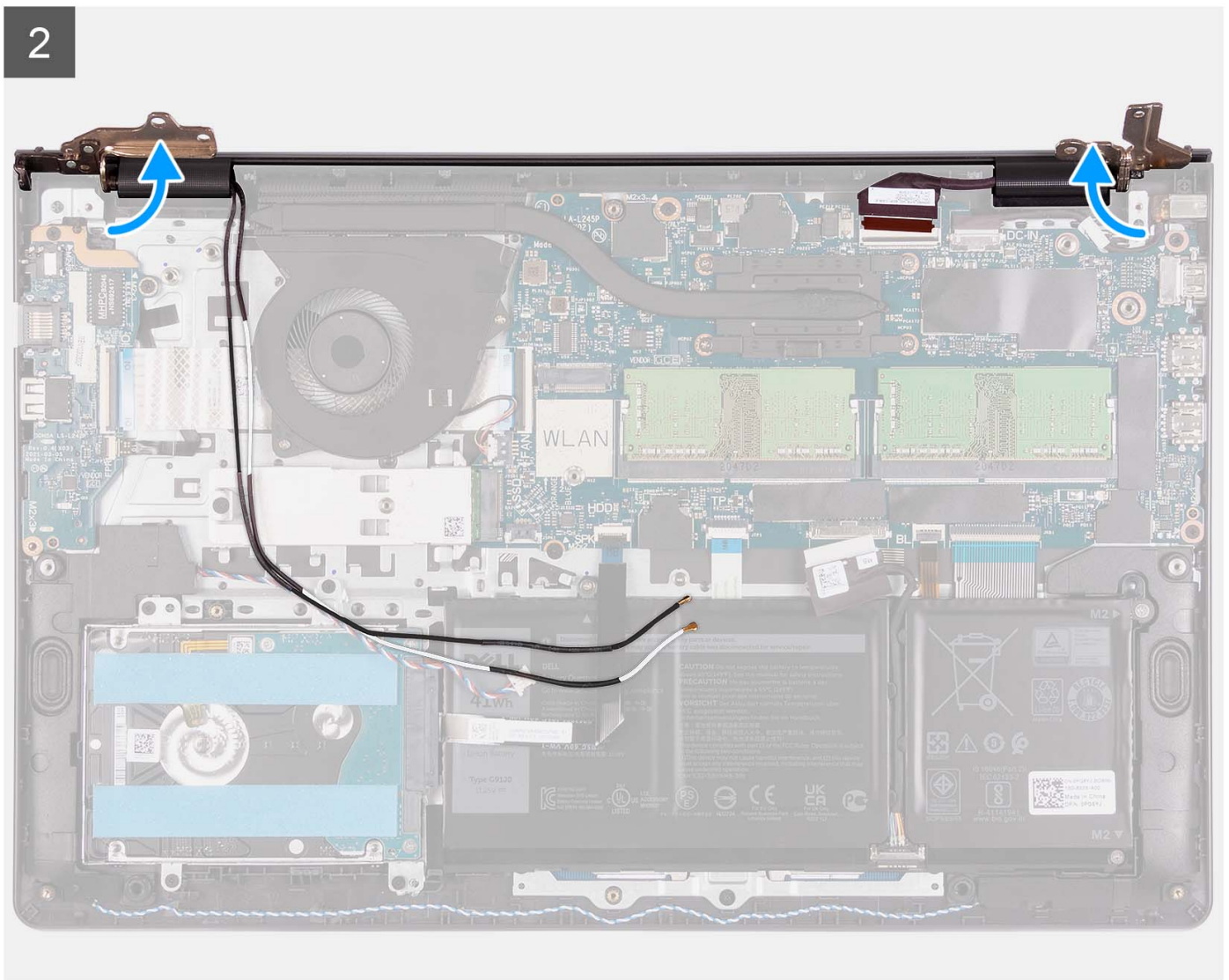



3





### Steps

1. Remove the four (M2.5x5) screws that secure the display hinges to the palm-rest and keyboard assembly.
2. Disconnect the display cable and the speaker cable from the system board (for systems with plastic chassis).  
**i** **NOTE:** Disconnect only the display cable from the system board for systems with aluminum chassis.
3. Unroute the speaker cable from the routing guides on the palm-rest and keyboard assembly.
4. Unroute the WLAN antenna cables from the routing guides on the palm-rest and keyboard assembly (for systems with plastic chassis).  
**i** **NOTE:** The procedure and images documented is for systems shipped with a plastic chassis. The same procedure is also applicable for system shipped with aluminum chassis, with the exception of the WLAN antenna cables. The WLAN

antennas are attached to the palm-rest assembly, therefore it is not required to disconnect and unrout the WLAN

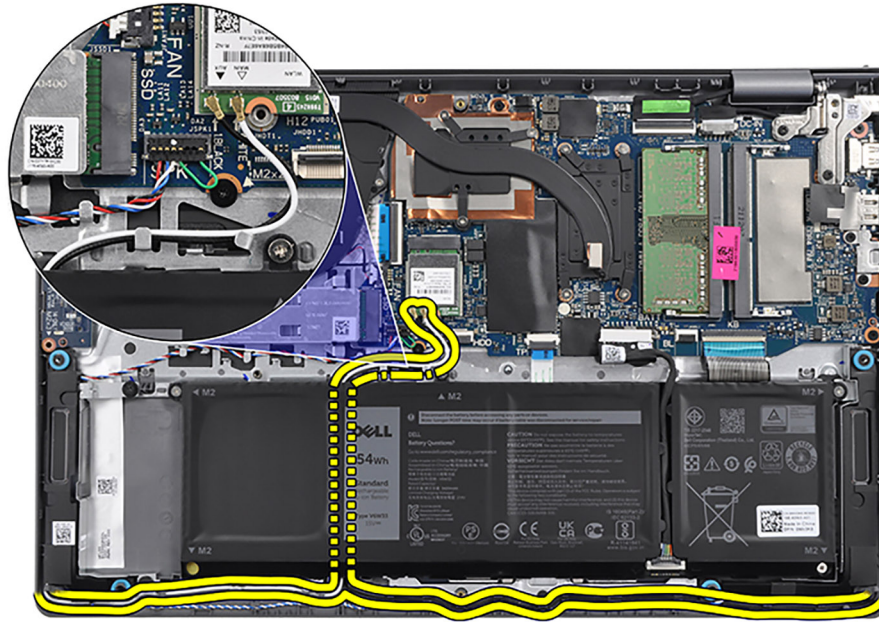

antenna cables.

5. Open the display hinges at an angle of 90 degrees, and place the system on a flat surface.
6. Remove the display assembly from the palm-rest and keyboard assembly.

## Installing the display assembly

**CAUTION:** The maximum operating angle for the display-panel hinge is 135 degrees.

### Prerequisites

If you are replacing a component, remove the existing component before performing the installation process.

### About this task

The following images indicate the location of the display assembly and provide a visual representation of the installation procedure.



**4x**  
M2.5x5

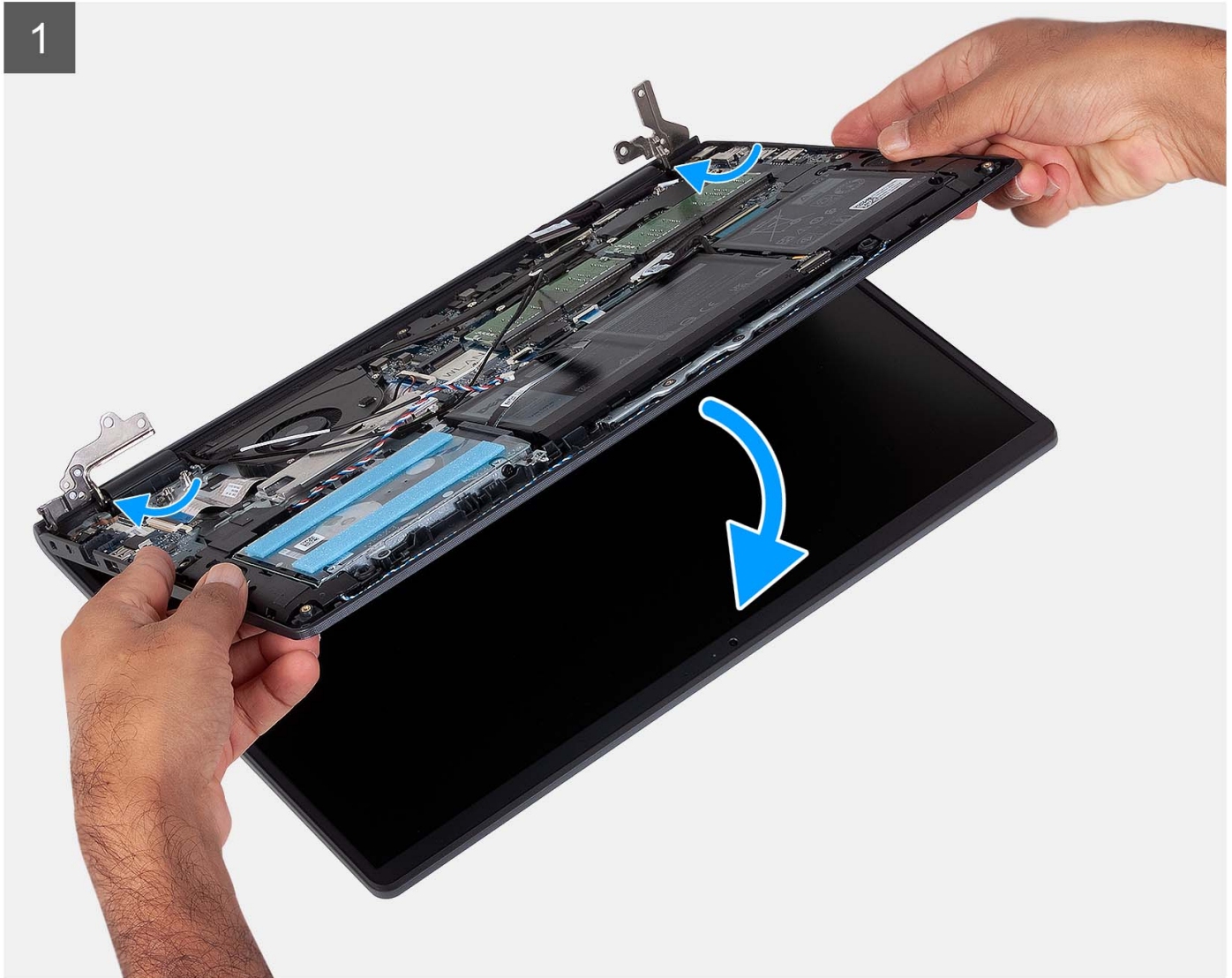
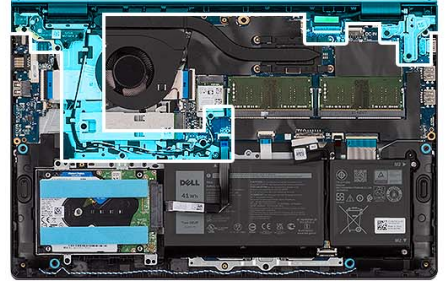



2

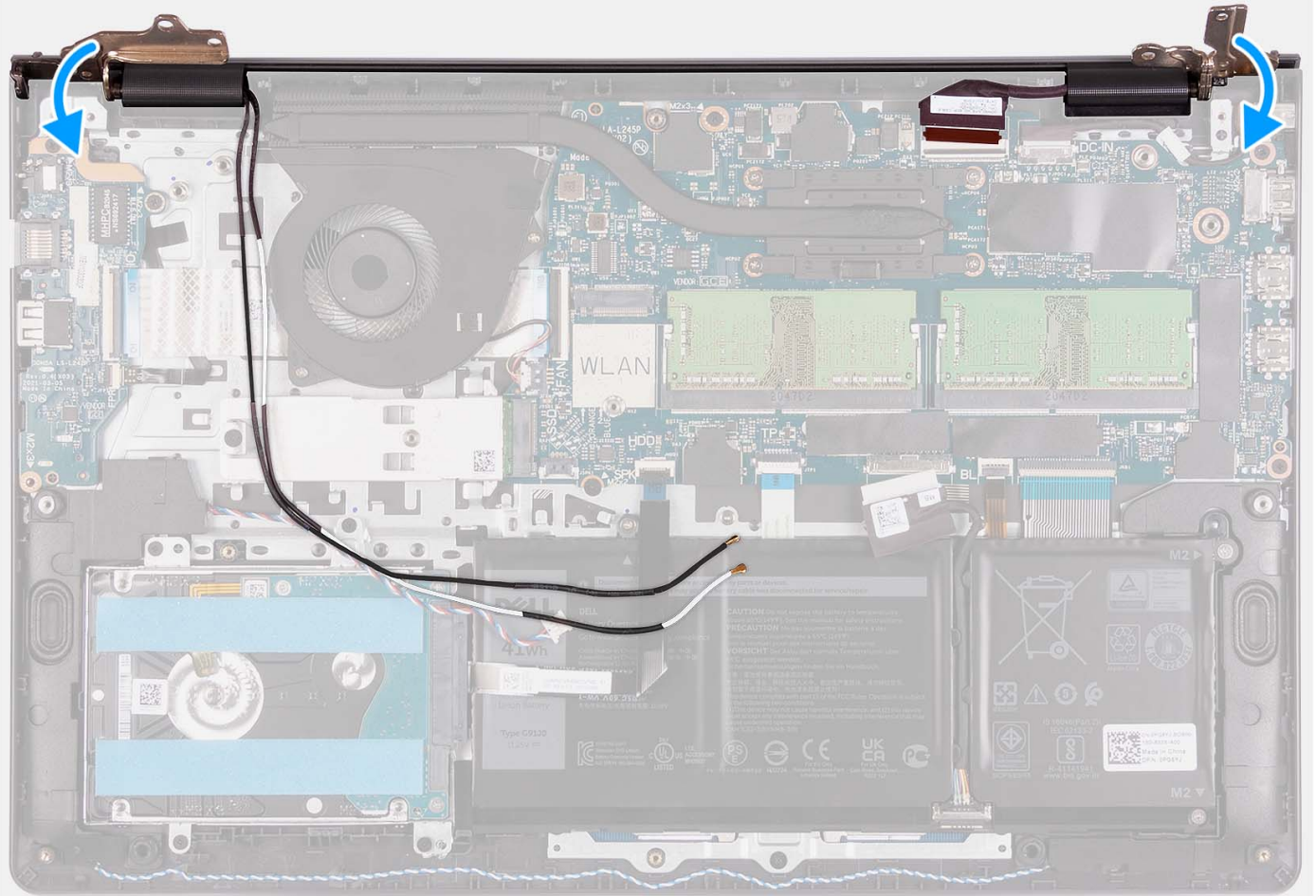

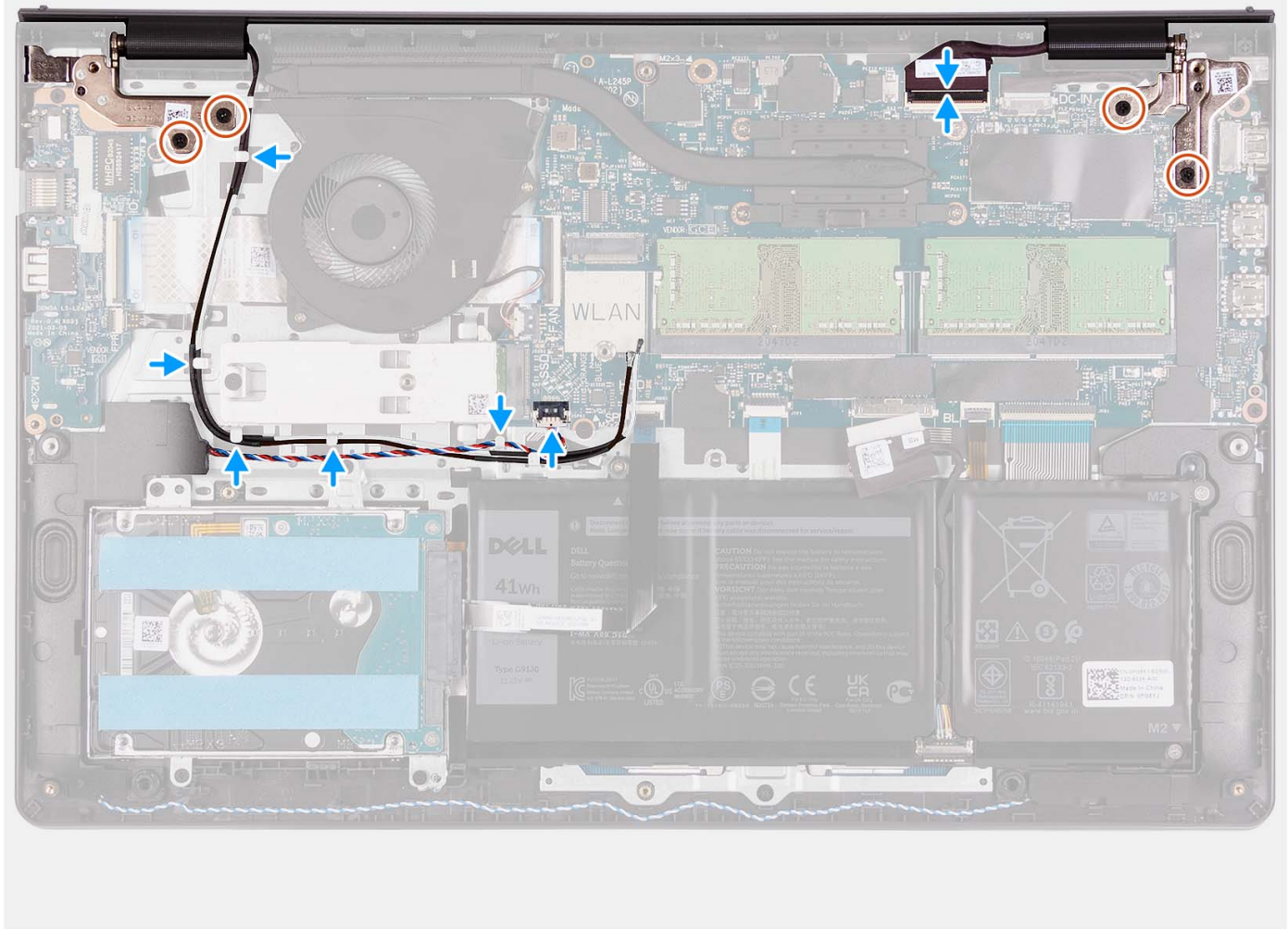

### Steps

1. Slide the display assembly at an angle, and place the display assembly on the palm-rest and keyboard assembly.
2. Gently press down on the display hinges to align the screw holes on the display hinges with the screw holes on the palm-rest and keyboard assembly.
3. Replace the four (M2.5x5) screws that secure the display hinges to the palm-rest and keyboard assembly.
4. Route the WLAN antenna cables through the routing guides on the palm-rest and keyboard assembly. Adhere the tape to the heat sink and fan to secure the cables in place.

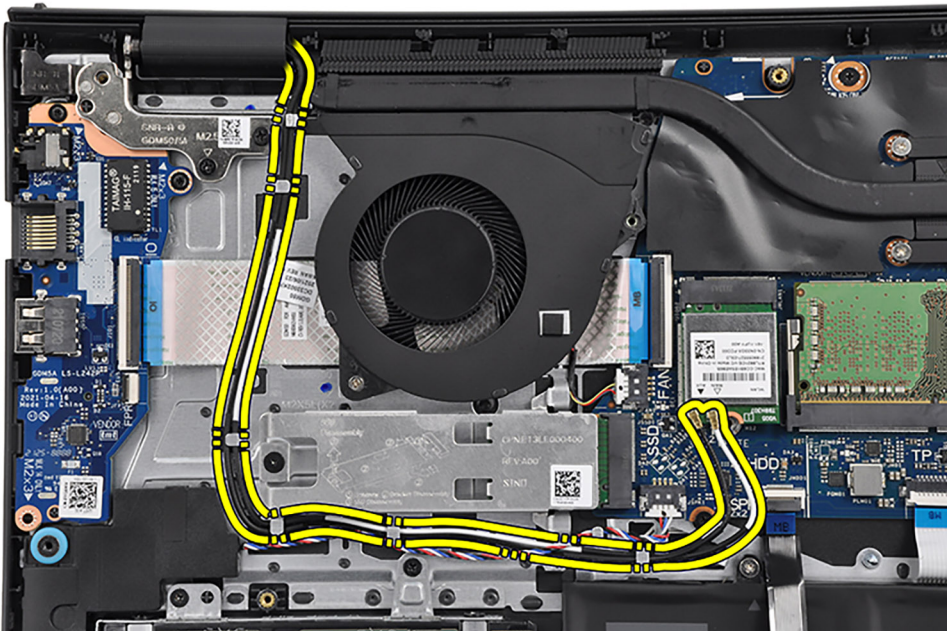

5. Route the speaker cable through the routing guides on the palm-rest and keyboard assembly.

**i** **NOTE:** Ensure to route the speaker cable over the WLAN antenna cables.

6. Connect the display cable to the connector on the system board.

#### Next steps

1. Install the [wireless card](#).
2. Install the [base cover](#).
3. Install the [SD card](#).
4. Follow the procedure in [After working inside your computer](#).

## Hinge caps

### Removing the hinge caps

#### Prerequisites

**i** **NOTE:** This procedure is applicable for systems with plastic chassis.

1. Follow the procedure in [Before working inside your computer](#).
2. Remove the [SD card](#).
3. Remove the [base cover](#).
4. Remove the [wireless card](#).
5. Remove the [display assembly](#).

#### About this task

The following images indicate the location of the hinge caps and provide a visual representation of the installation procedure.



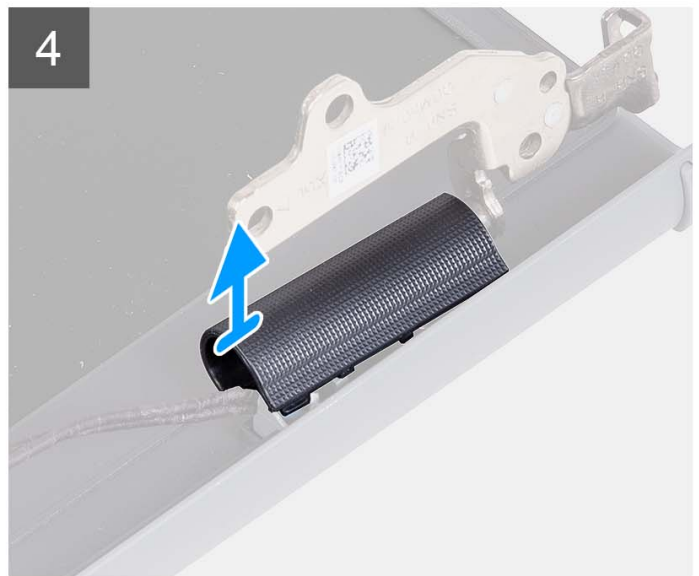
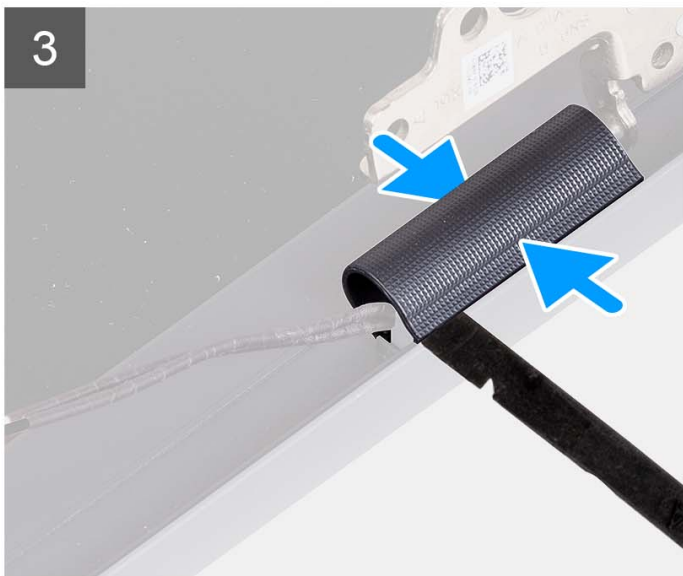
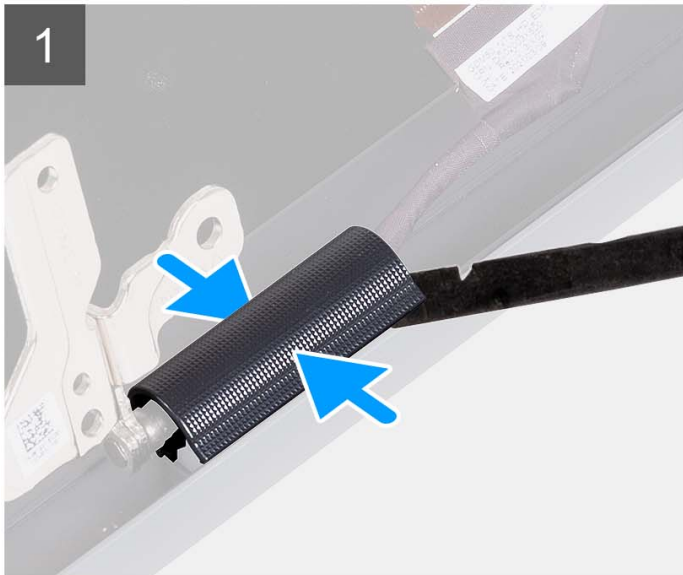
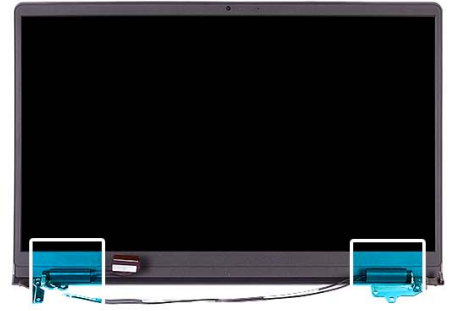

### Steps

**i** **NOTE:** Before removing the display hinge caps, open the display hinges to 90 degrees.

1. Pinch the left hinge cap in the center.
2. Using a plastic scribe pry the inner side of the left hinge cap and remove it from the left hinge.
3. Pinch the right hinge cap in the center.
4. Using a plastic scribe pry the inner side of the right hinge cap and remove it from the right hinge.



# Installing the hinge caps

## Prerequisites

If you are replacing a component, remove the existing component before performing the installation procedure.

**NOTE:** This procedure is applicable for systems with plastic chassis.

## About this task

The following images indicate the location of the hinge caps and provide a visual representation of the installation procedure.

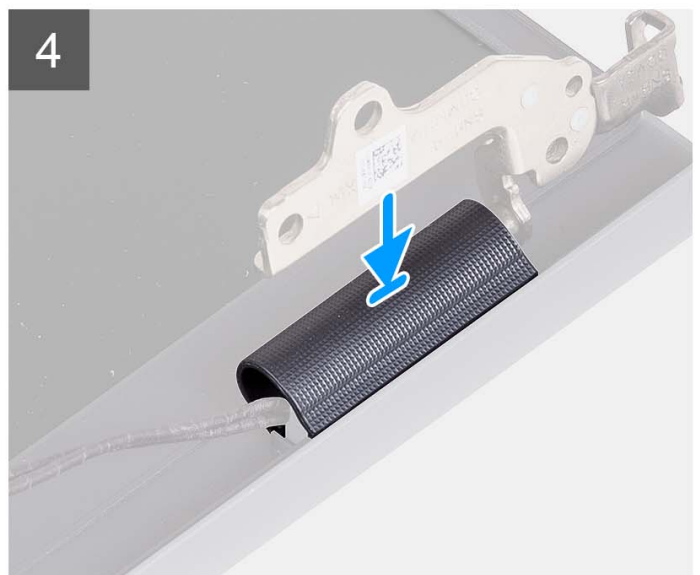
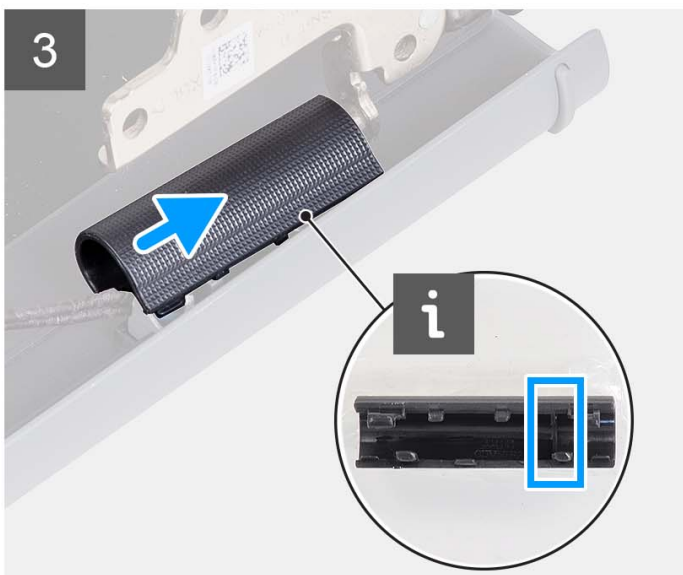
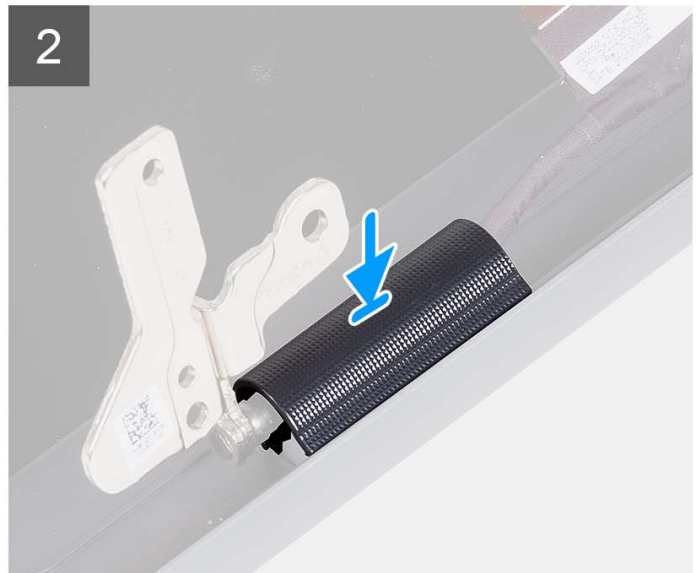
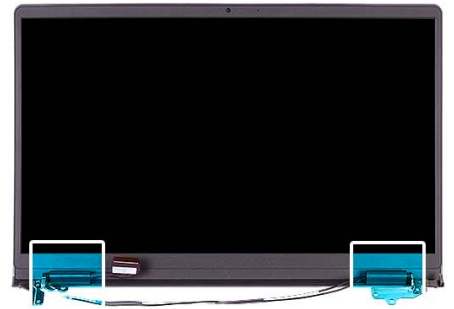

### Steps

1. Align the rib inside the left hinge cap to the outer sides.
2. Push the left hinge cap down until it clicks in place.
3. Align the rib inside the right hinge cap to the outer sides.
4. Push the right hinge cap down until it clicks in place.

### Next steps

1. Install the [display assembly](#).
2. Install the [wireless card](#).
3. Install the [base cover](#).
4. Install the [SD card](#).
5. Follow the procedure in [After working inside your computer](#).

## Display bezel

### Removing the display bezel

#### Prerequisites

 **NOTE:** This procedure is applicable for systems with plastic chassis.

1. Follow the procedure in [Before working inside your computer](#).
2. Remove the [SD card](#).
3. Remove the [base cover](#).
4. Remove the [wireless card](#).
5. Remove the [display assembly](#).
6. Remove the [hinge caps](#).

#### About this task

The following images indicate the location of the display bezel and provide a visual representation of the removal procedure.

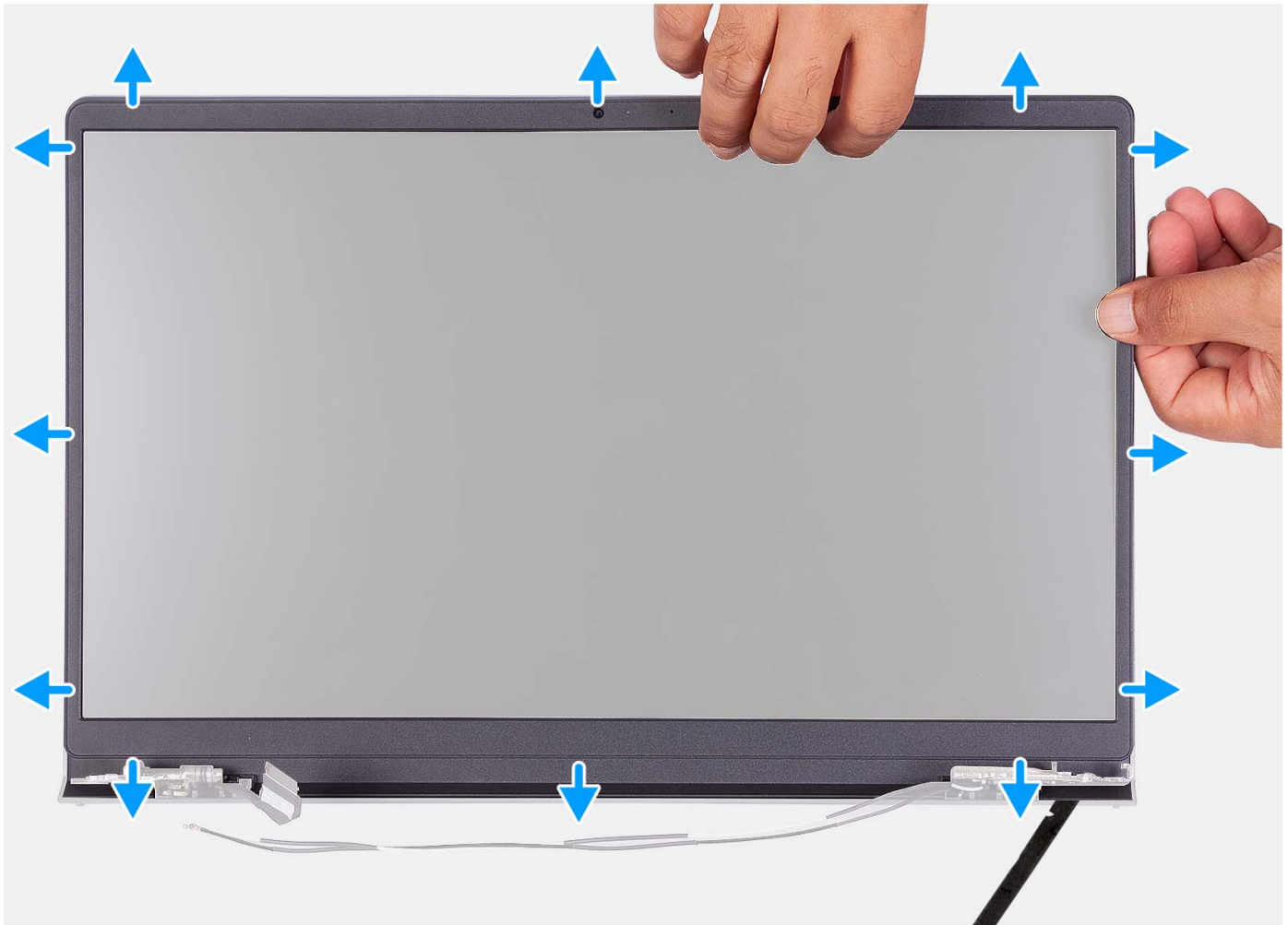

### Steps

1. Pry open the display bezel from the inner edge at the left and right sides of the display assembly.
2. Pry open the display bezel from the inner edge at the top side of the display assembly.
3. Continue to pry open the outer edge of the bottom side of the display bezel.
4. Pry open the display bezel from the inner edge at the bottom side of the display assembly.
5. Lift and remove the display bezel from the display assembly.

## Installing the display bezel

### Prerequisites

If you are replacing a component, remove the existing component before performing the installation procedure.

**NOTE:** This procedure is applicable for systems with plastic chassis.

### About this task

The following image indicates the location of the display bezel and provides a visual representation of the installation procedure.



### Steps

Align the display bezel with the display back-cover and antenna assembly, and then gently snap the display bezel into place.

### Next steps

1. Install the [hinge cap](#).
2. Install the [display assembly](#).
3. Install the [wireless card](#).
4. Install the [base cover](#).



5. Install the [SD card](#).
6. Follow the procedure in [After working inside your computer](#).

# Hinges

## Removing the hinges

### Prerequisites

 **NOTE:** This procedure is applicable for systems with a plastic chassis only.

1. Follow the procedure in [Before working inside your computer](#).
2. Remove the [SD card](#).
3. Remove the [base cover](#).
4. Remove the [wireless card](#).
5. Remove the [display assembly](#).
6. Remove the [hinge caps](#).
7. Remove the [display bezel](#).

### About this task

The following images indicate the location of the hinge caps and provide a visual representation of the installation procedure.



6x  
M2.5x3.8

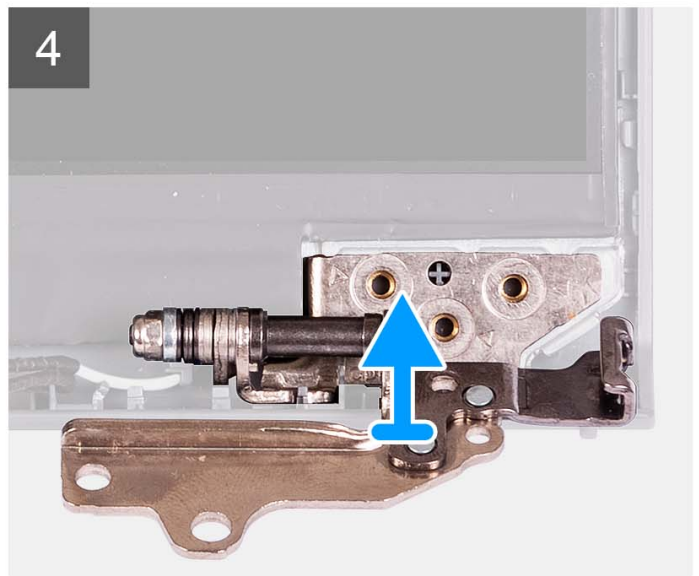
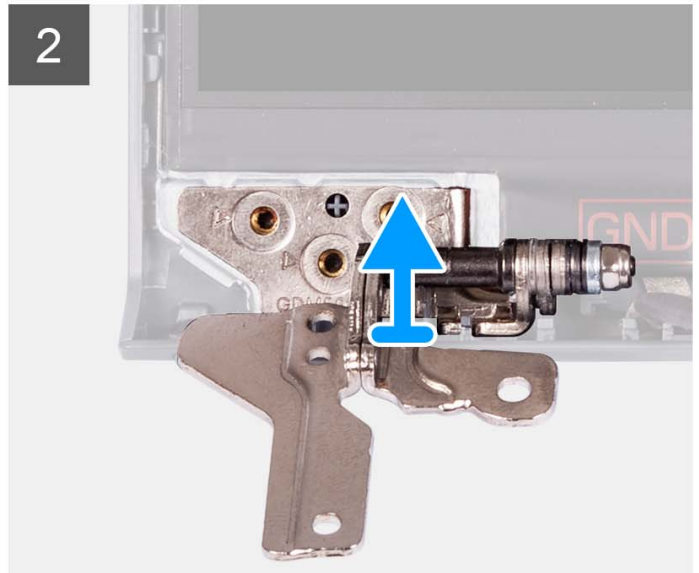

### Steps

1. Remove the three (M2.5x3.8) screws from the left hinge.
2. Lift and remove the left hinge from the display assembly.
3. Remove the three (M2.5x3.8) screws from the right hinge.
4. Lift and remove the right hinge from the display assembly.

## Installing the hinges

### Prerequisites

If you are replacing a component, remove the existing component before performing the installation procedure.

### About this task

The following images indicate the location of the hinges and provide a visual representation of the installation procedure.



**6x**  
M2.5x3.8

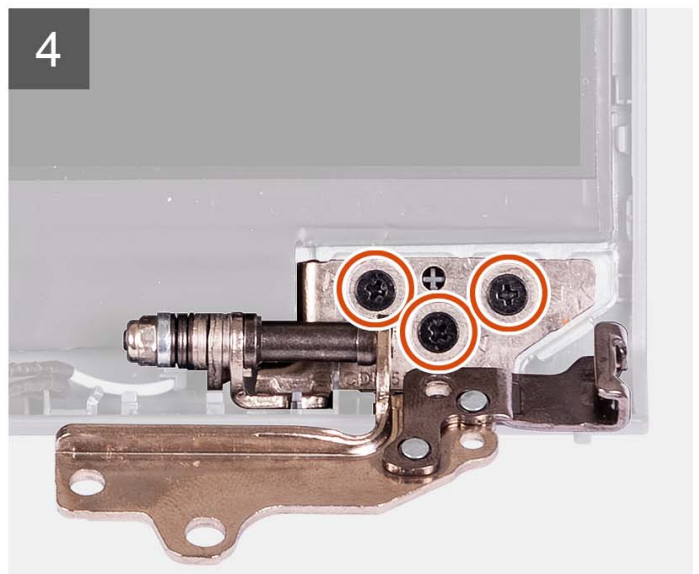
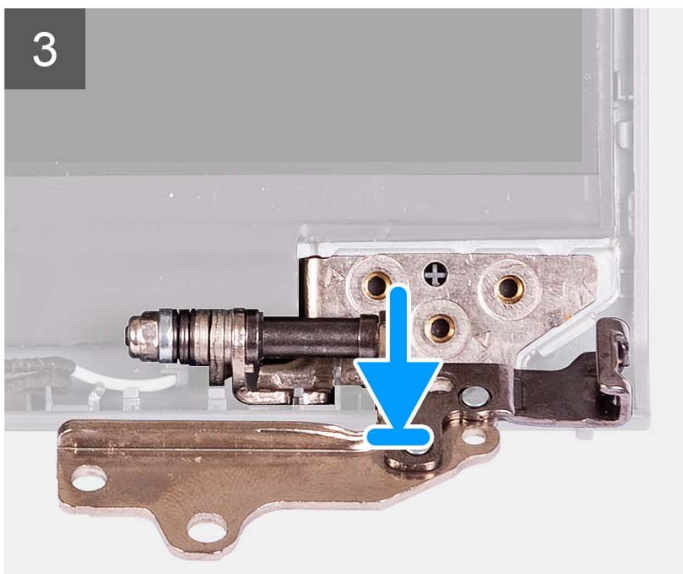
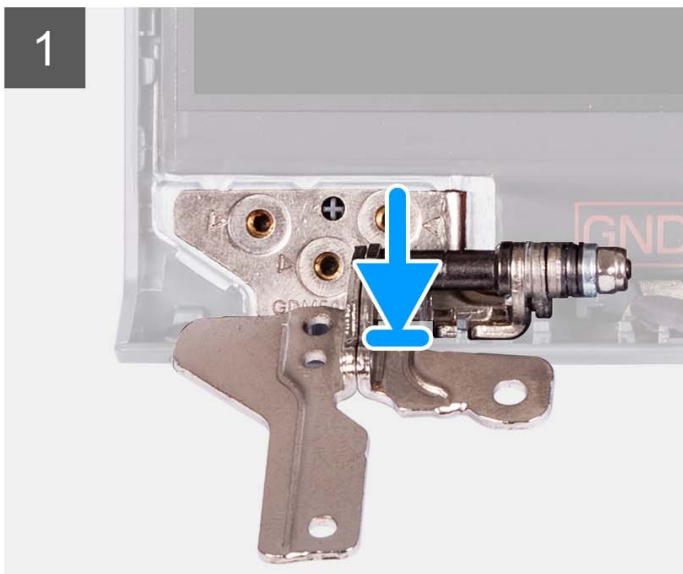

### Steps

1. Align and place the left hinge on the display assembly.
2. Install the three (M2.5x3.8) screws to secure the hinge to the display panel and back cover.
3. Align and place the right hinge on the display assembly.
4. Install the three (M2.5x3.8) screws to secure the hinge to the display panel and back cover.

### Next steps

1. Install the [display bezel](#).
2. Install the [hinge cap](#).
3. Install the [display assembly](#).
4. Install the [wireless card](#).
5. Install the [base cover](#).
6. Install the [SD card](#).
7. Follow the procedure in [After working inside your computer](#).

## Display panel

### Removing the display panel

#### Prerequisites

 **NOTE:** This procedure is applicable for systems with a plastic chassis only.

1. Follow the procedure in [Before working inside your computer](#).
2. Remove the [SD card](#).
3. Remove the [base cover](#).
4. Remove the [wireless card](#).
5. Remove the [display assembly](#).
6. Remove the [hinge caps](#).
7. Remove the [display bezel](#).
8. Remove the [hinges](#).

#### About this task

The following images indicate the location of the display panel and provide a visual representation of the removal procedure.



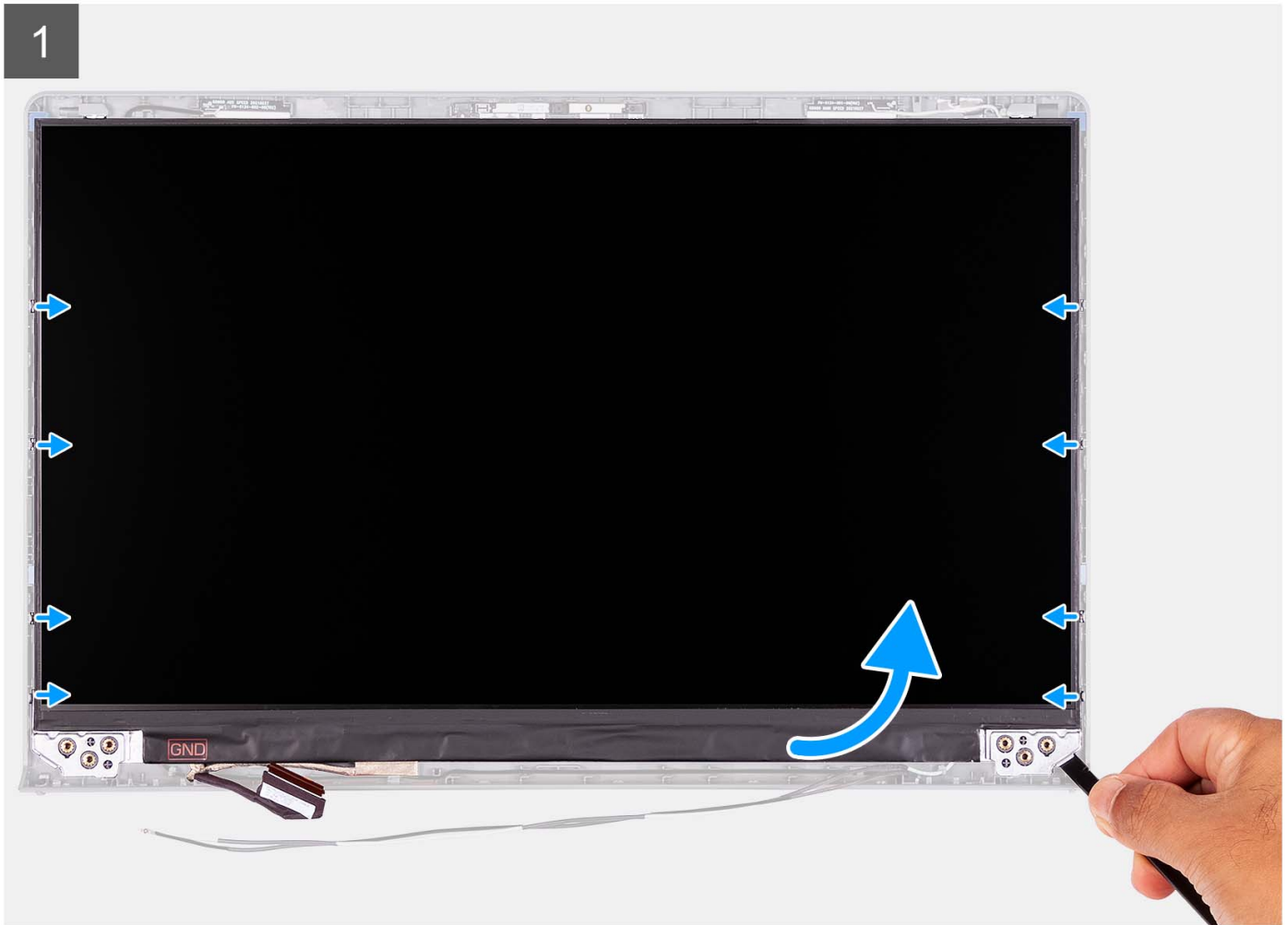

2





### Steps

1. Use a plastic scribe to pry the display panel from the bottom-right corner.
2. Gently start prying the display panel along the left and right sides of the display back-cover using your hands.
3. Lift the bottom side of the display panel and slide it downward to release the display brackets from the slots at the top side of the display cover.
4. Gently flip the display panel assembly forward, peel back the Mylar tape securing the display cable on the rear of the display panel.

**i** **NOTE:** Ensure that the panel has a clean and smooth surface to rest on to prevent damage.

5. Disconnect the display cable from the display panel assembly and lift the display panel away from the system.

**i** **NOTE:** Do not remove the metal brackets from the panel.

## Installing the display panel

### Prerequisites

If you are replacing a component, remove the existing component before performing the installation process.

**i** **NOTE:** This procedure is applicable for systems with a plastic chassis only.

### About this task

The following images indicate the location of the display panel and provide a visual representation of the installation procedure.

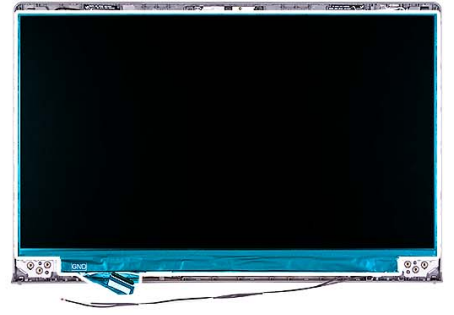



2





### Steps

1. Place the display panel and display assembly on a clean and flat surface.
2. Connect the display cable to the connector on the display panel and close the latch.
3. Adhere the tape to secure the display-cable connector latch to the display panel.
4. Lift and rotate the display panel, and then place the display panel on the display assembly.
5. Place the display bezel on the display assembly.
6. Align the tabs on the display bezel to the slots on the display assembly.
7. Press down on the display bezel and snap the display bezel in place.

### Next steps

1. Install the [hinges](#).
2. Install the [hinge caps](#).
3. Install the [display assembly](#).
4. Install the [wireless card](#).
5. Install the [base cover](#).
6. Install the [SD card](#).
7. Follow the procedure in [After working inside your computer](#).

# Camera module

## Removing the camera module

### Prerequisites

**i** **NOTE:** This procedure is applicable for systems with a plastic chassis only.

1. Follow the procedure in [Before working inside your computer](#).
2. Remove the [SD card](#).
3. Remove the [base cover](#).
4. Remove the [wireless card](#).
5. Remove the [display assembly](#).
6. Remove the [hinge caps](#).
7. Remove the [display bezel](#).
8. Remove the [hinges](#).
9. Remove the [display panel](#).

### About this task

The following images indicate the location of the camera module and provide a visual representation of the removal procedure.

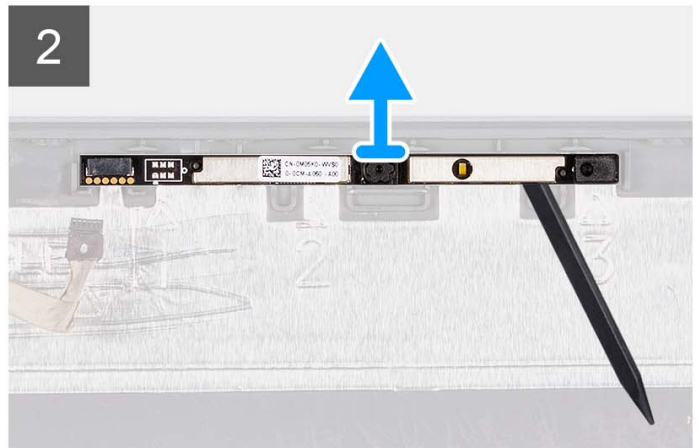
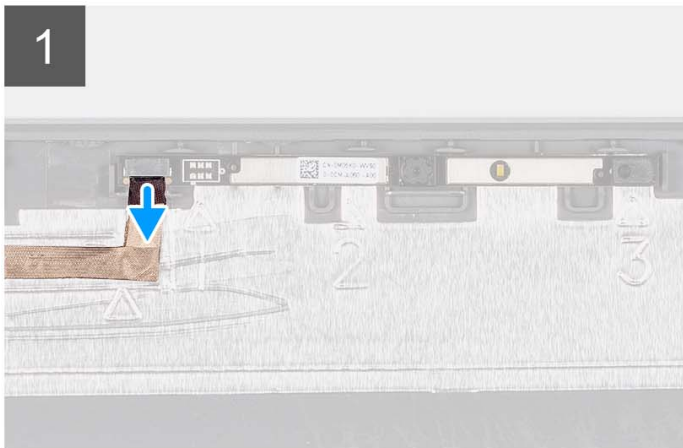
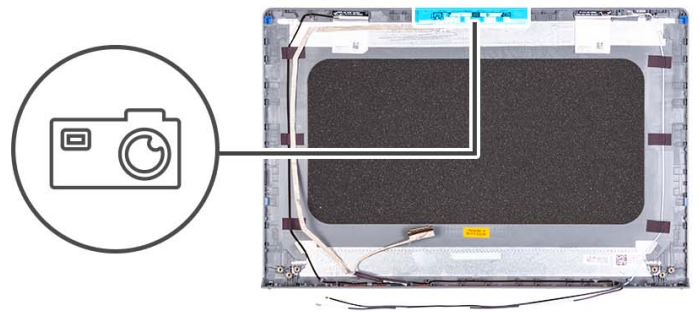

### Steps

1. Using the pull tab, disconnect the camera cable from the camera module.
2. Using a plastic scribe, pry the camera module from the display assembly.

**i** **NOTE:** Start prying the camera module in a sequential order 1>2>3 as indicated on the display back cover.

3. Lift the camera module from the display assembly.

# Installing the camera module

## Prerequisites

If you are replacing a component, remove the existing component before performing the installation process.

## About this task

The following images indicate the location of the camera module and provide a visual representation of the installation procedure.

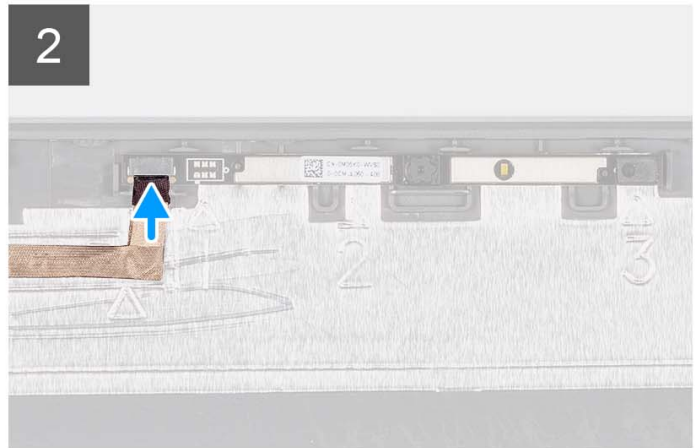
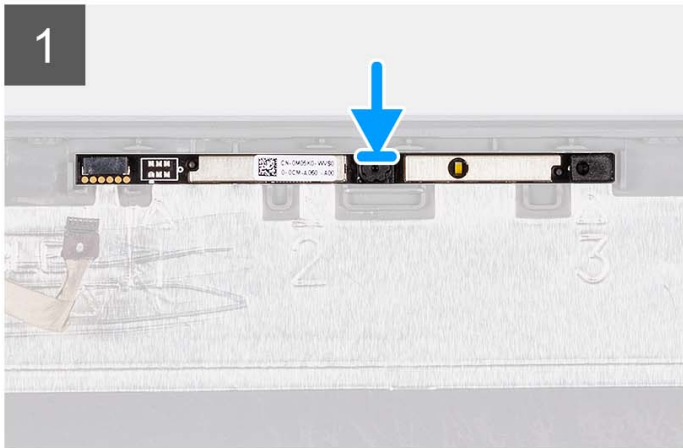
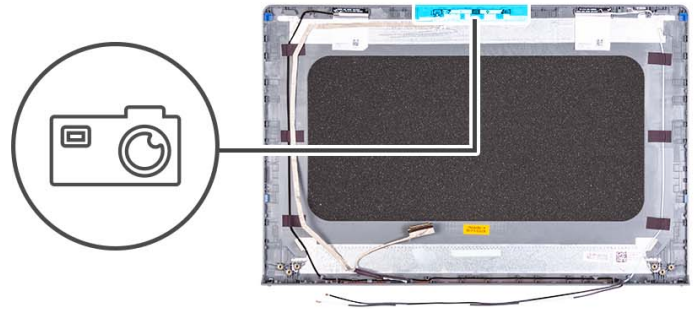

## Steps

1. Adhere the camera module in its slot on the display assembly.
2. Connect the camera cable to the camera module.

## Next steps

1. Install the [display panel](#).
2. Install the [hinges](#).
3. Install the [display bezel](#).
4. Install the [hinge caps](#).
5. Install the [display assembly](#).
6. Install the [wireless card](#).
7. Install the [base cover](#).
8. Install the [SD card](#).
9. Follow the procedure in [After working inside your computer](#).



# eDP cable

## Removing the eDP cable

### Prerequisites

 **NOTE:** The eDP cable removal procedure is applicable only for systems with plastic chassis.

1. Follow the procedure in [Before working inside your computer](#).
2. Remove the [SD card](#).
3. Remove the [base cover](#).
4. Remove the [wireless card](#).
5. Remove the [display assembly](#).
6. Remove the [hinge caps](#).
7. Remove the [display bezel](#).
8. Remove the [hinges](#).
9. Remove the [display panel](#).

### About this task

The following image indicates the location of the eDP cable and provides a visual representation of the removal procedure.





### Steps

1. Adhere the tape to securing the eDP cable to the display back cover.
2. Connect the eDP cable to the camera.

### Next steps

1. Install the [display panel](#).
2. Install the [hinges](#).
3. Install the [display bezel](#).
4. Install the [hinge caps](#).
5. Install the [display assembly](#).
6. Install the [wireless card](#).
7. Install the [base cover](#).
8. Install the [SD card](#).

9. Follow the procedure in [After working inside your computer](#).

## Display cover and antenna assembly

### Replacement of the display cover and antenna assembly

#### Prerequisites

**NOTE:** This procedure is applicable for systems shipped with a plastic chassis only.

1. Follow the procedure in [Before working inside your computer](#).
2. Remove the [SD card](#).
3. Remove the [base cover](#).
4. Remove the [wireless card](#).
5. Remove the [display assembly](#).
6. Remove the [hinge caps](#).
7. Remove the [display bezel](#).
8. Remove the [hinges](#).
9. Remove the [display panel](#).
10. Remove the [camera module](#).
11. Remove the [eDP cable](#).

**NOTE:** The display cover and antenna assembly cannot be further disassembled. If the WLAN antennas are malfunctioning and needs replacement, replace the entire display cover and antenna assembly.

#### About this task

The following image indicates the location of the display cover and antenna assembly and provides a visual representation of the removal procedure.





### Steps

After performing the pre-requisites, you are left with the display cover and antenna assembly.

## Touchpad

### Removing the touchpad

#### Prerequisites

1. Follow the procedure in [Before working inside your computer](#).
2. Remove the [SD card](#).
3. Remove the [base cover](#).
4. Remove the [3-cell battery](#) or [4-cell battery](#) (whichever applicable).

#### About this task

The following images indicate the location of the touchpad and provide a visual representation of the removal procedure.





**5x**  
M2x2

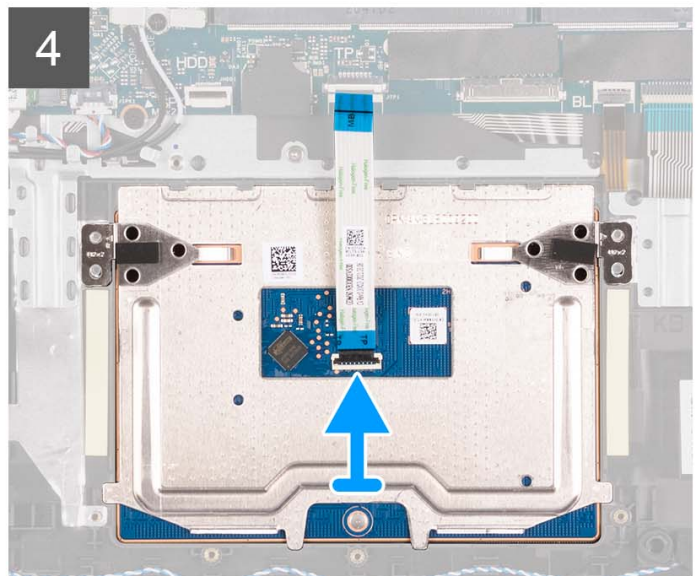
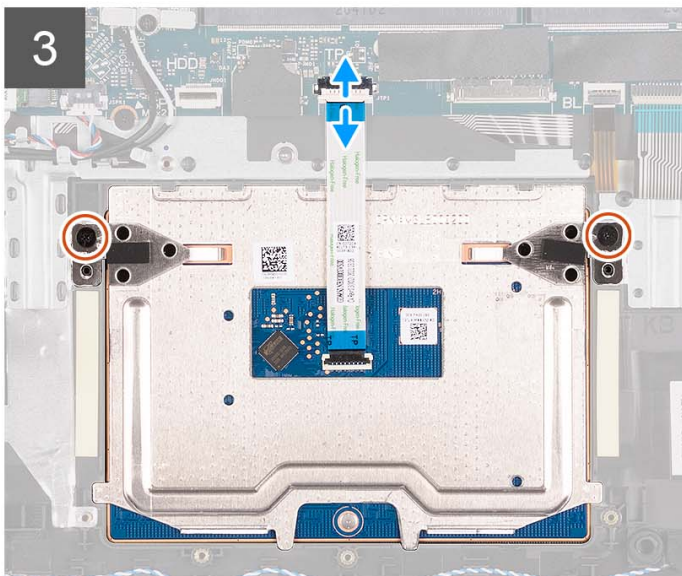
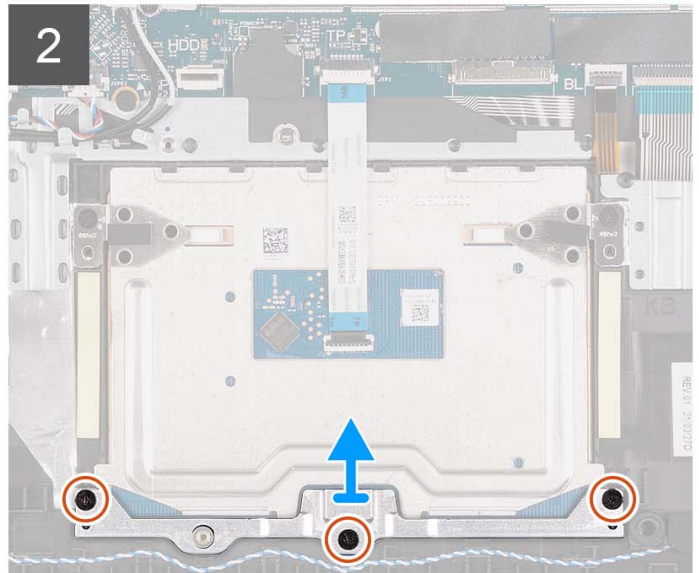
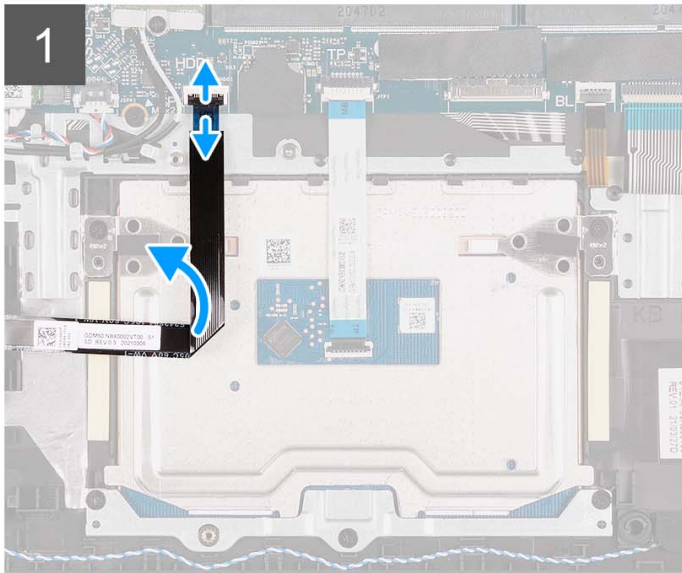
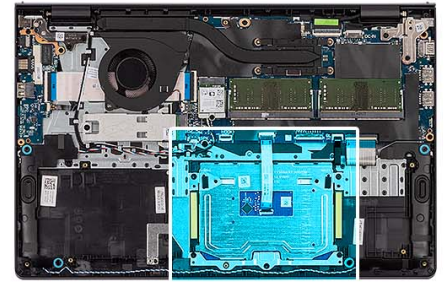

### Steps

1. Open the latch and disconnect the hard drive cable from the connector on the system board.
2. Remove the three (M2x2) screws that secure the touchpad bracket to the palm-rest and keyboard assembly.
3. Lift the touchpad bracket off the touchpad.
4. Open the latch and disconnect the touchpad Flexible Flat cable from the connector on the system board.
5. Remove the two screws (M2x2) that secure the touchpad to the palm-rest and keyboard assembly.
6. Lift the touchpad from the palm-rest and keyboard assembly.

# Installing the touchpad

## Prerequisites

If you are replacing a component, remove the existing component before performing the installation process.

## About this task

The following images indicate the location of the touchpad and provide a visual representation of the installation procedure.



5x  
M2x2

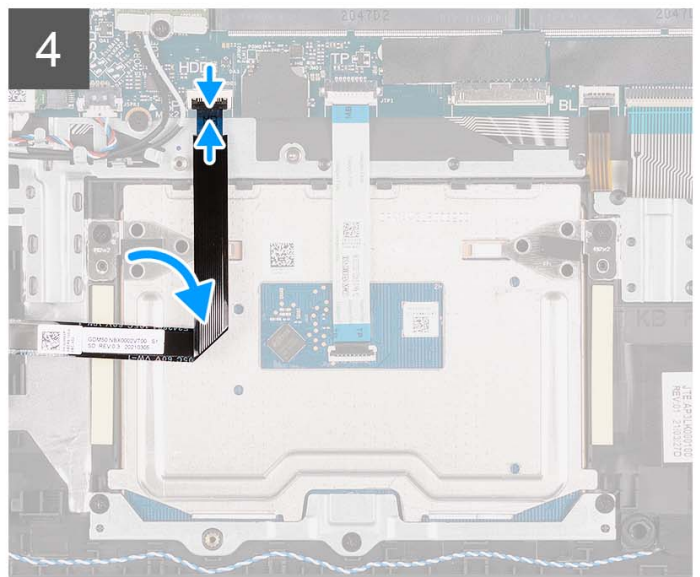
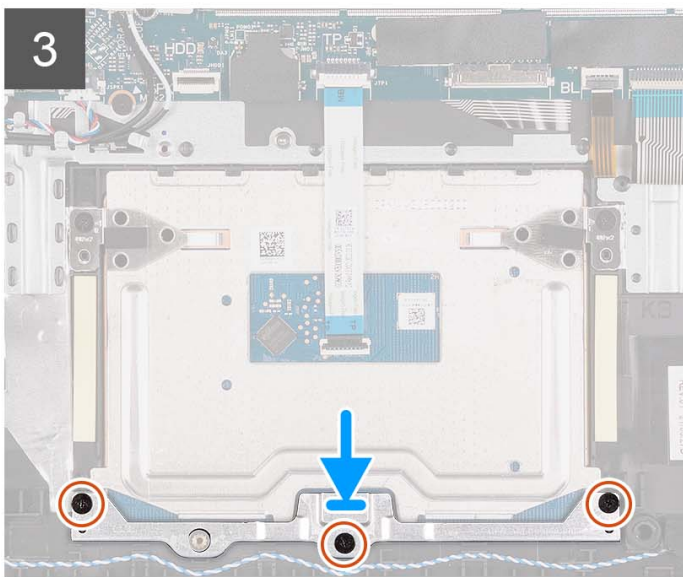
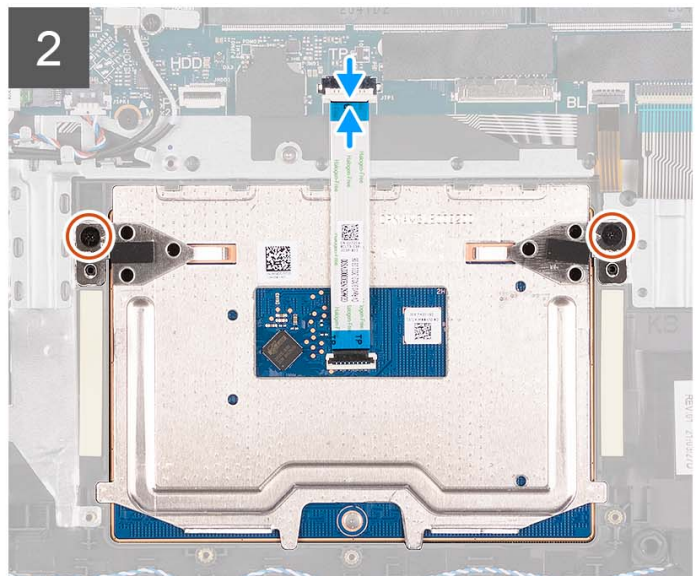
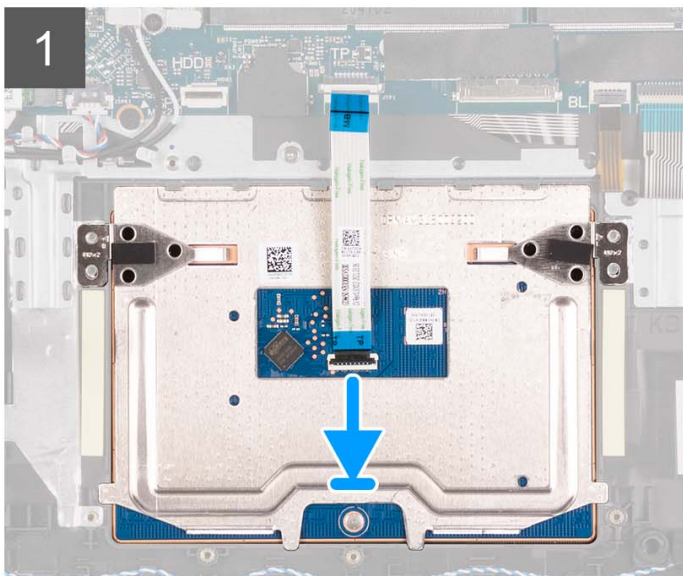
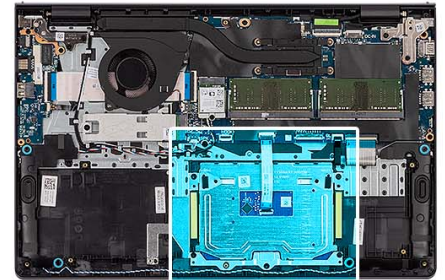



### Steps

1. Place the touchpad into its slot on the palm-rest and keyboard assembly.
2. Align the screw holes on the touchpad to the screw holes on the palm-rest and keyboard assembly.
3. Replace the two (M2x2) screws that secure the touchpad to the palm-rest and keyboard assembly.
4. Connect the touchpad Flexible Flat cable to the connector on the system board and close the latch.
5. Place the touchpad bracket on the touchpad.
6. Align the screw holes on the touchpad bracket to the screw holes on the palm-rest and keyboard assembly.
7. Replace the three (M2x2) screws that secure the touchpad bracket to the palm-rest and keyboard assembly.
8. Connect the hard drive cable to the connector on the system board.

### Next steps

1. Install the [3-cell battery](#) or [4-cell battery](#) (whichever applicable).
2. Install the [base cover](#).
3. Install the [SD card](#).
4. Follow the procedure in [After working inside your computer](#).

## System board

### Removing the system board

#### Prerequisites

1. Follow the procedure in [Before working inside your computer](#).
2. Remove the [SD card](#).
3. Remove the [base cover](#).
4. Remove the [3-cell battery](#) or [4-cell battery](#) (whichever applicable).
5. Remove the [M.2 2230 solid-state drive](#) or [M.2 2280 solid-state drive](#) (whichever applicable).
6. Remove the [memory modules](#).
7. Remove the [wireless card](#).
8. Remove the [fan](#).
9. Remove the [heat sink](#).
10. Remove the [display assembly](#).

#### About this task

The following image indicates the connectors on your system board.

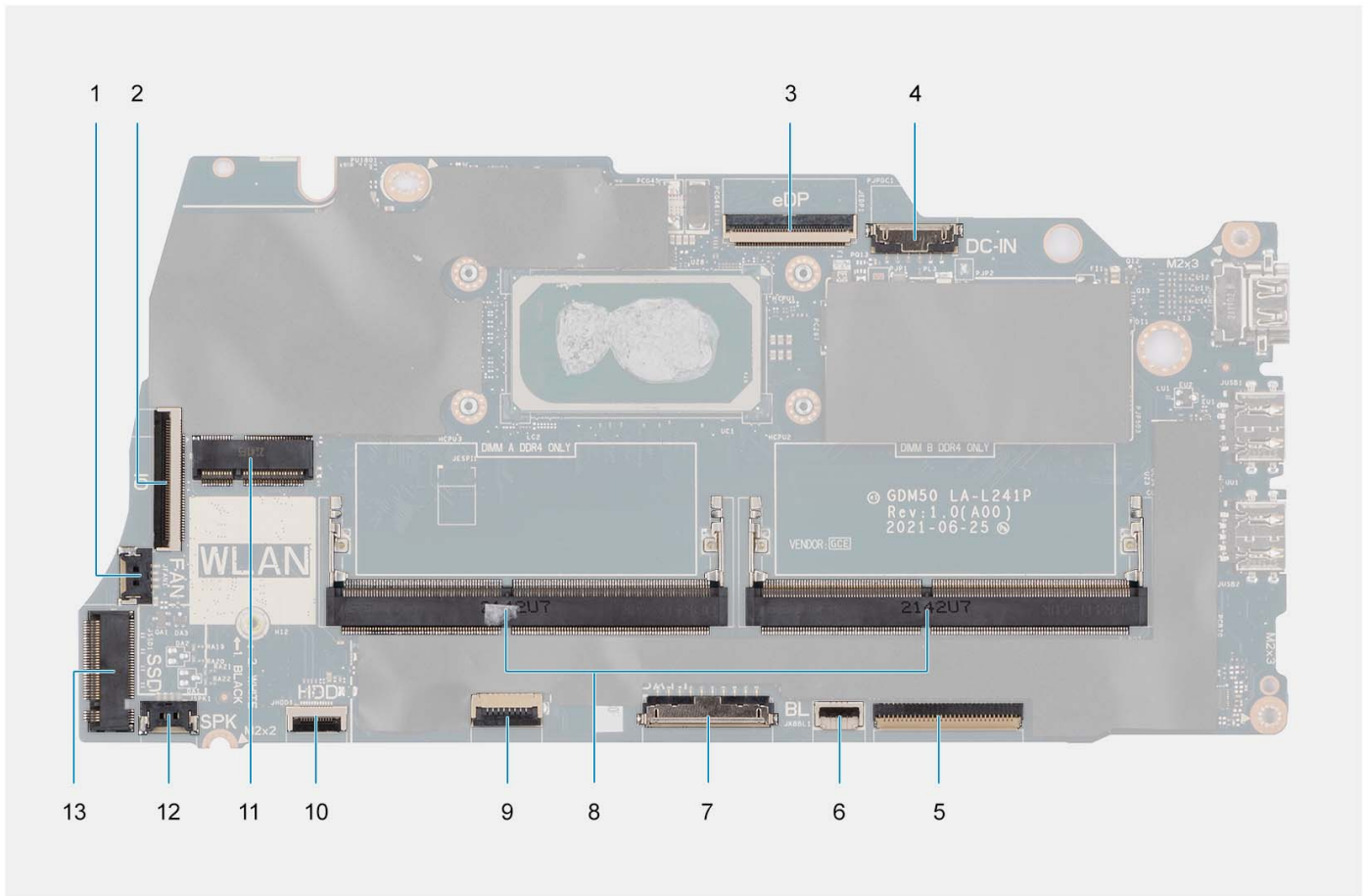

- |                                 |                                     |
|---------------------------------|-------------------------------------|
| 1. Fan connector                | 2. I/O board FFC connector          |
| 3. eDP connector                | 4. DC-in port connector             |
| 5. Keyboard FFC connector       | 6. Keyboard-backlight FFC connector |
| 7. Battery connector            | 8. Memory modules                   |
| 9. Touchpad FFC connector       | 10. Hard drive FFC connector        |
| 11. Wireless connector          | 12. Speaker cable connector         |
| 13. Solid-state drive connector |                                     |

The following images indicate the location of the system board and provide a visual representation of the removal procedure.



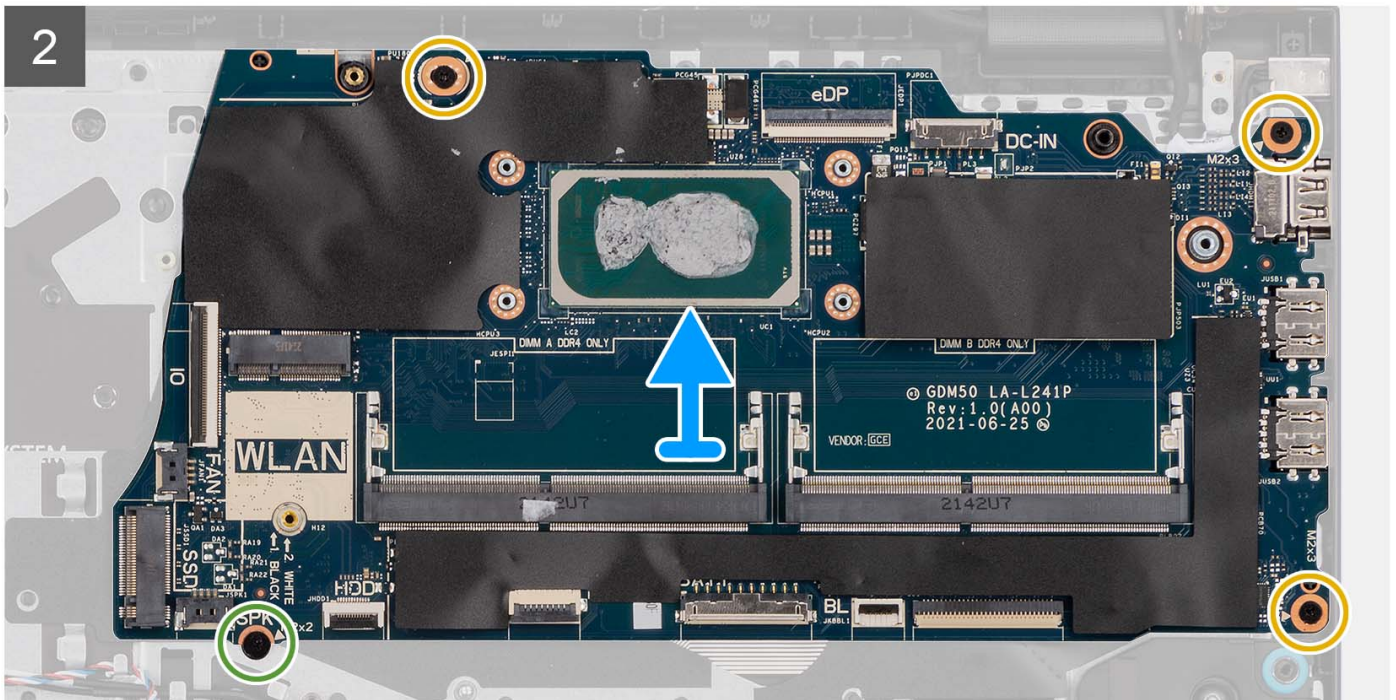
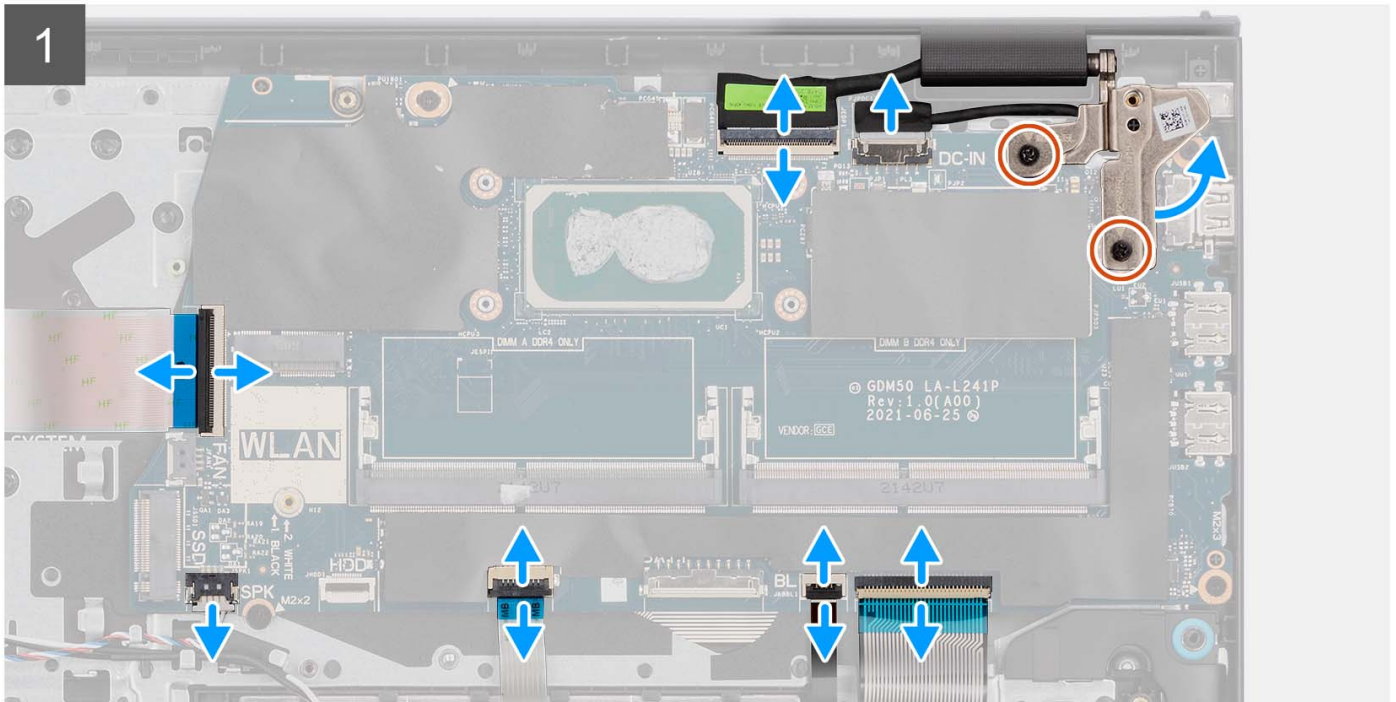
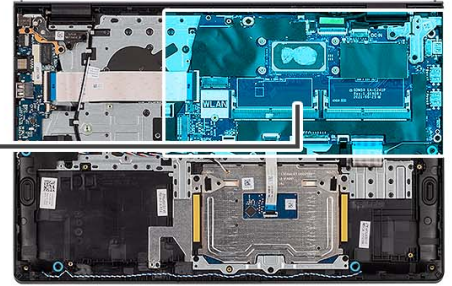

## Steps

1. Remove the two (M2.5x5) screws from the right hinge.
2. Pry open the right-display hinge at an angle of 90 degrees.
3. Disconnect the following cables from the system board:
  - a. I/O board Flexible Flat cable
  - b. Speaker cable
  - c. Hard drive Flexible Flat cable (for systems with 2.5-inch hard drive)
  - d. Touchpad Flexible Flat cable
  - e. Keyboard backlight Flexible Printed cable (for systems with backlit keyboard)
  - f. Keyboard Flexible Printed cable
  - g. Power adapter port cable
  - h. eDP cable
4. Remove the three (M2x3.5) screws and the single (M2x2) screw that secures the system board to the palm-rest assembly.
5. Carefully lift the system board away from the chassis.

**NOTE:** For systems shipped with a USB Type-C port, do not remove the type-C bracket that is secured to the system board.

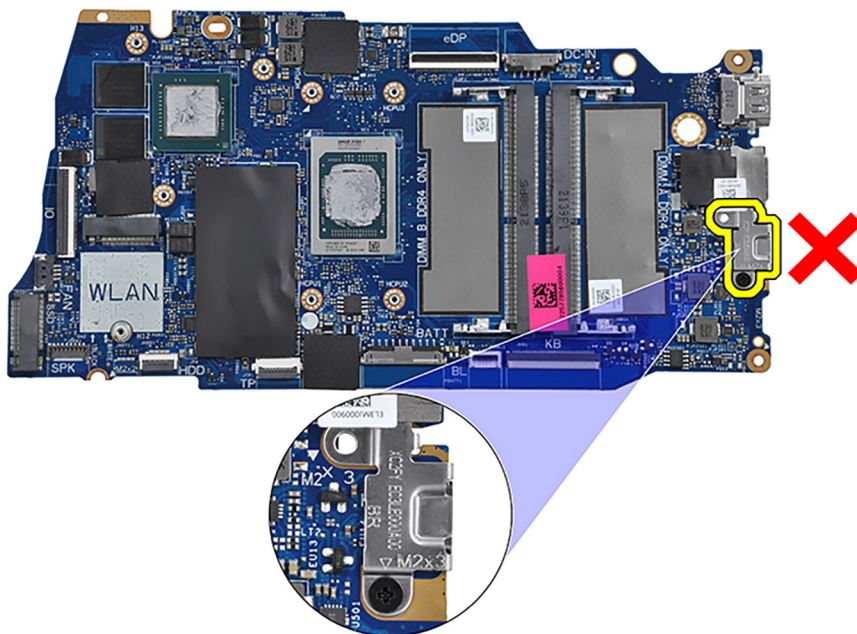

## Installing the system board

### Prerequisites

If you are replacing a component, remove the existing component before performing the installation process.

### About this task

The following image indicates the connectors on your system board.

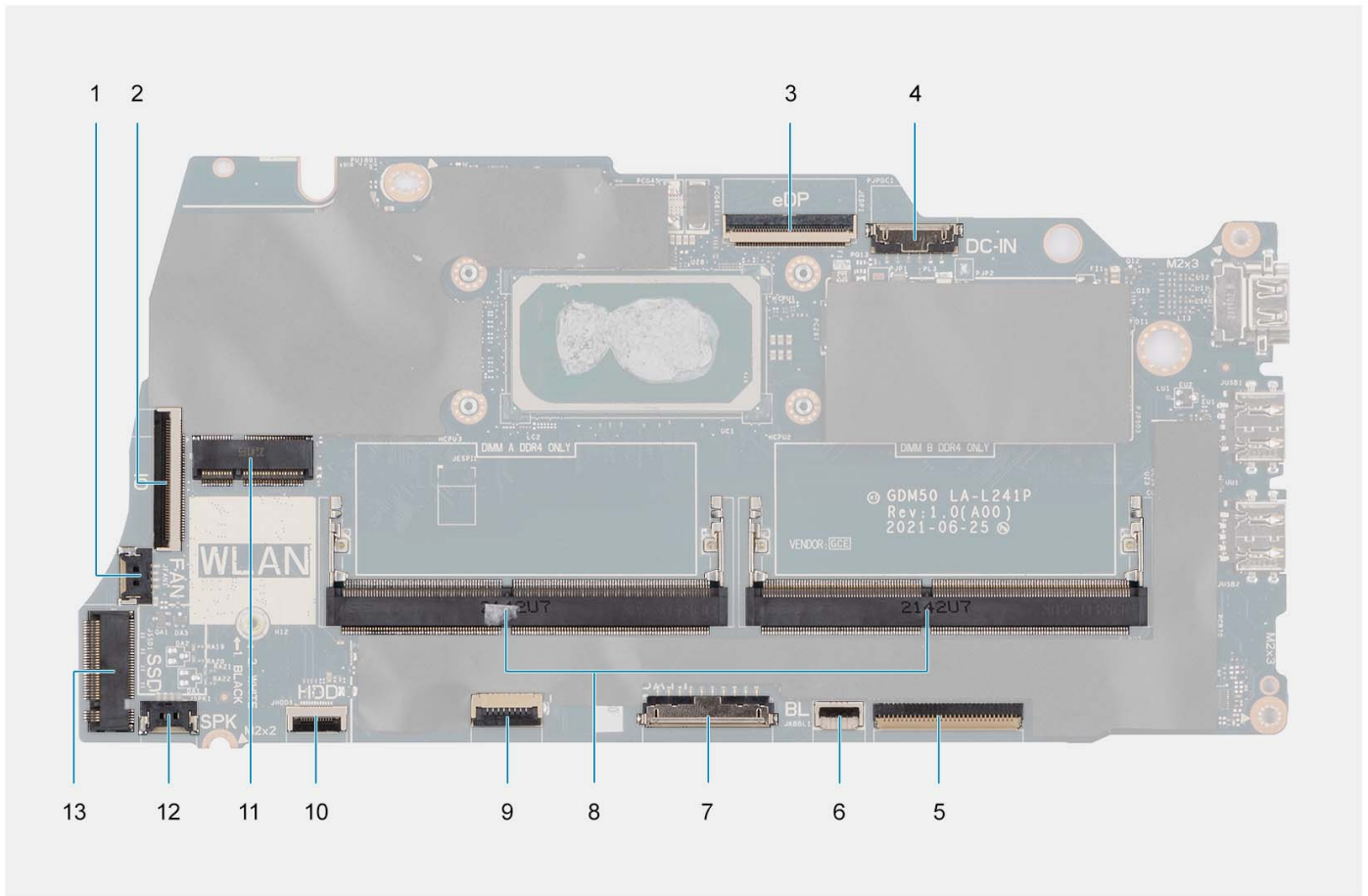

- |                                 |                                     |
|---------------------------------|-------------------------------------|
| 1. Fan connector                | 2. I/O board FFC connector          |
| 3. eDP connector                | 4. DC-in port connector             |
| 5. Keyboard FFC connector       | 6. Keyboard-backlight FFC connector |
| 7. Battery connector            | 8. Memory modules                   |
| 9. Touchpad FFC connector       | 10. Hard drive FFC connector        |
| 11. Wireless connector          | 12. Speaker cable connector         |
| 13. Solid-state drive connector |                                     |

The following images indicate the location of the system board and provide a visual representation of the installation procedure.





2x  
M2.5x5



3x  
M2x3.5



1x  
M2x2

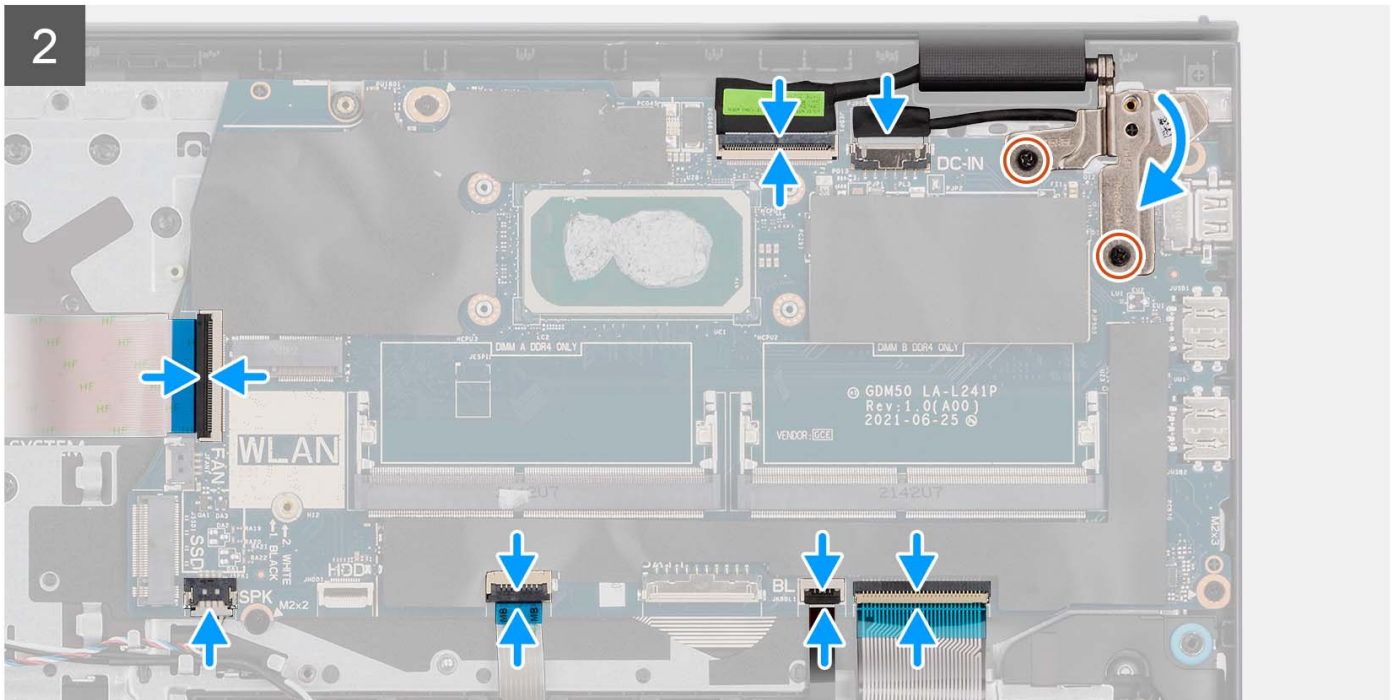
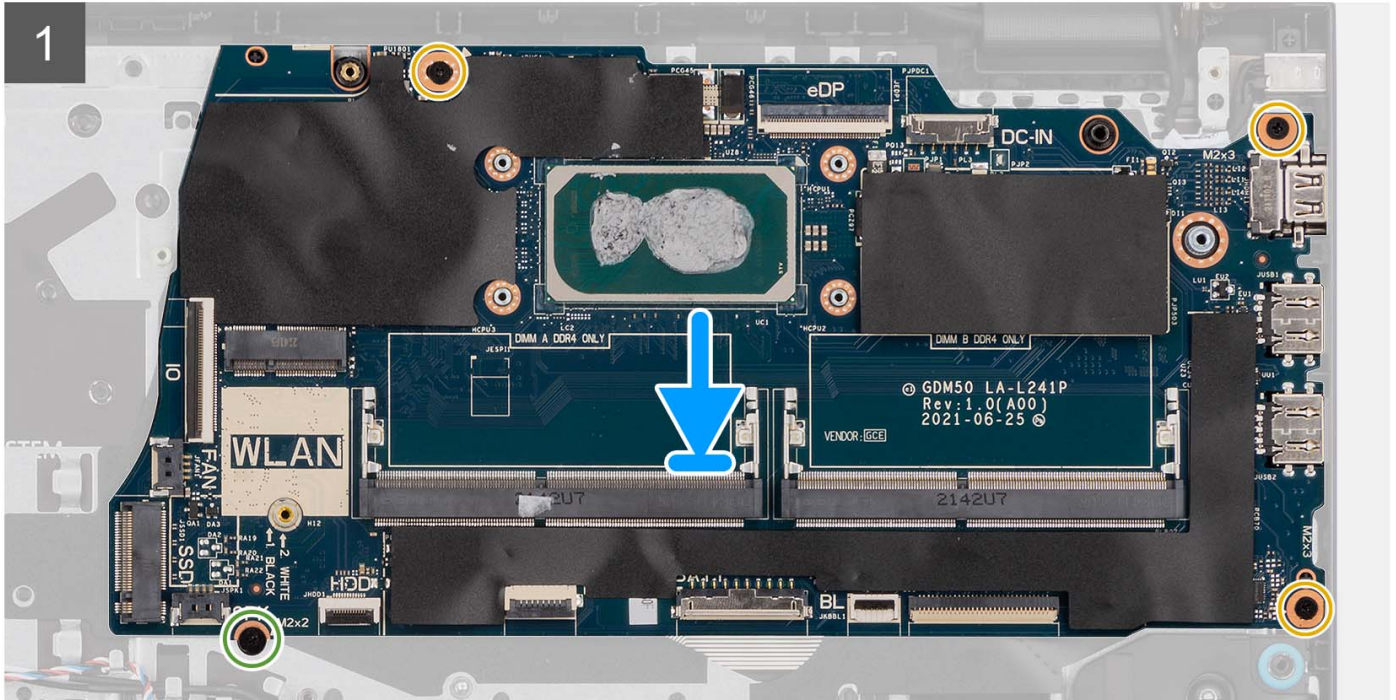
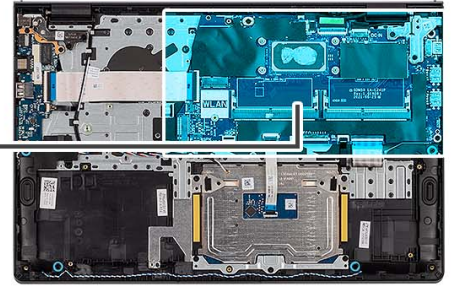



### Steps

1. Place the system board on the palm-rest and keyboard assembly.
2. Align the screw holes on the system board with the screw holes on the palm-rest assembly.
3. Replace the single (M2x2) screw that secures the system board to the palm-rest assembly.
4. Replace the three (M2x3.5) screws that secure the system board to the palm-rest assembly.
5. Connect the following cables to the system board:
  - a. I/O board Flexible Flat cable
  - b. Speaker cable
  - c. Hard drive Flexible Flat cable (for systems with 2.5-inch hard drive)
  - d. Touchpad Flexible Flat cable
  - e. Keyboard backlight Flexible Printed cable (for systems with backlit keyboard)
  - f. Keyboard Flexible Printed cable
  - g. Power adapter port cable
  - h. eDP cable
6. Close the right-display hinge and align the screw holes on the right-display hinge with the screw holes on the system board.
7. Replace the two (M2.5x5) screws to secure it to the palm-rest assembly.

### Next steps

1. Install the [display assembly](#).
2. Install the [heat sink](#).
3. Install the [fan](#).
4. Install the [wireless card](#).
5. Install the [memory modules](#).
6. Install the [M.2 2230 solid-state drive](#) or [M.2 2280 solid-state drive](#) (whichever applicable).
7. Install the [3-cell battery](#) or [4-cell battery](#) (whichever applicable).
8. Install the [base cover](#).
9. Install the [SD card](#).
10. Follow the procedure in [After working inside your computer](#).

## Power-adapter port

### Removing the power-adapter port

#### Prerequisites

1. Follow the procedure in [Before working inside your computer](#).
2. Remove the [SD card](#).
3. Remove the [base cover](#).
4. Remove the [display assembly](#).

#### About this task

The following images indicate the location of the power-adapter port and provide a visual representation of the removal procedure.



**2x**  
M2.5x5

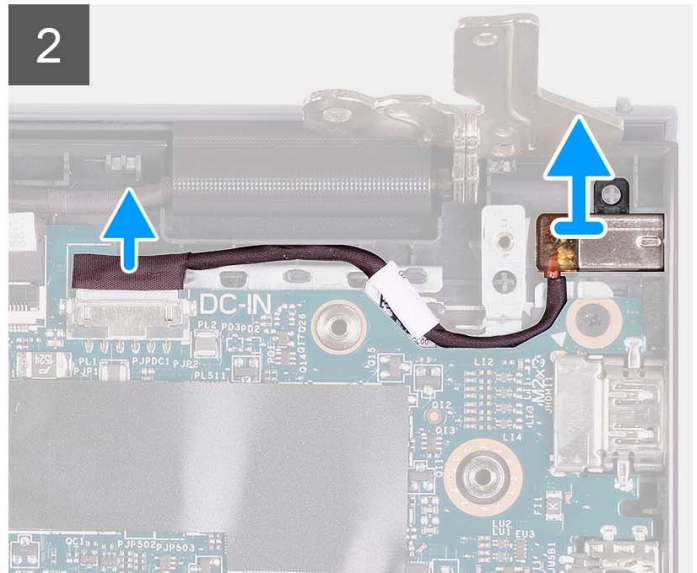
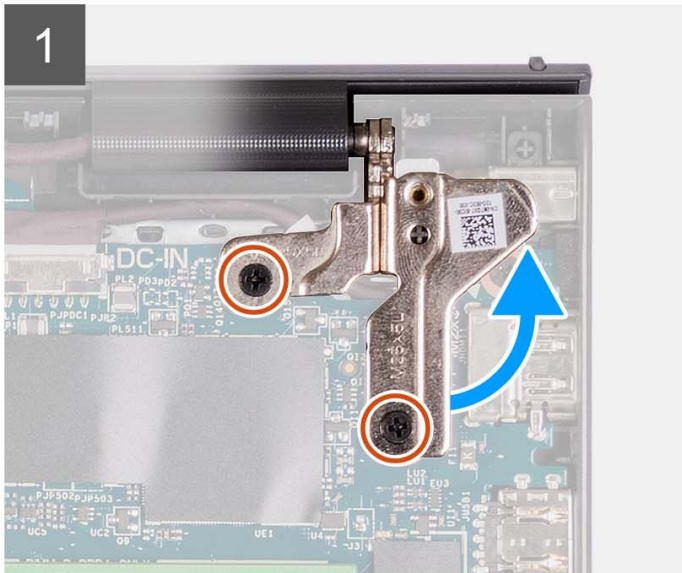
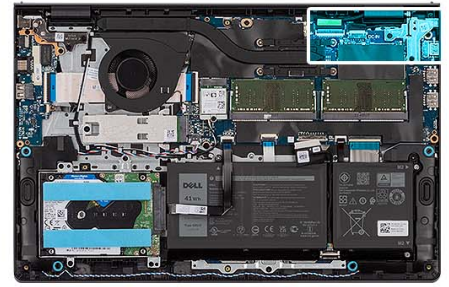

### Steps

1. Remove the two (M2.5x5) screws that secure the right hinge to the palm-rest and keyboard assembly.
2. Disconnect the power-adapter cable from the connector on the system board.
3. Lift the power-adapter port from its slot on the palm-rest and keyboard assembly.

## Installing the power-adapter port

### Prerequisites

If you are replacing a component, remove the existing component before performing the installation process.

### About this task

The following images indicate the location of the power-adapter port and provide a visual representation of the installation procedure.



**2x**  
M2.5x5

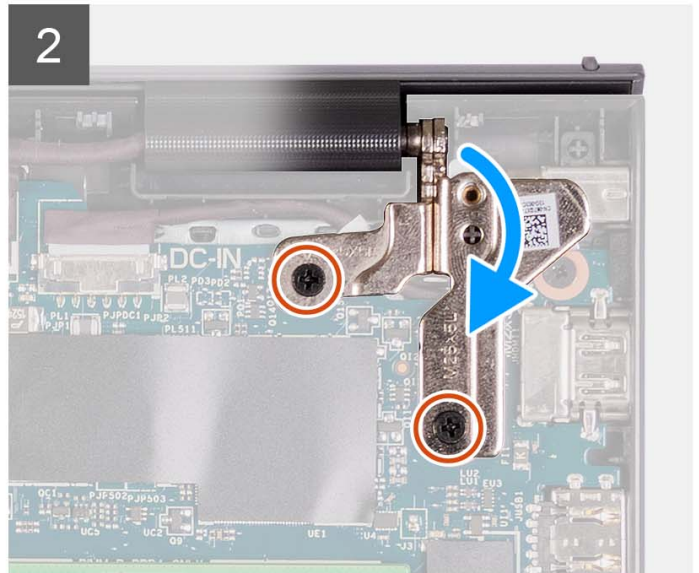
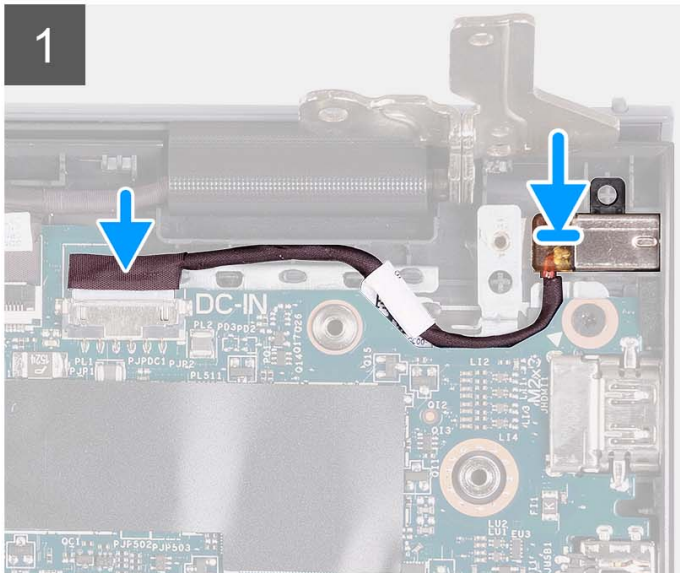

### Steps

1. Using the alignment post, place the power-adaptor port into its slot on the palm-rest and keyboard assembly.
2. Connect the power-adaptor port cable to the connector on the system board.
3. Fold the right hinge down and install the two (M2.5x5) screws to secure it to the palm-rest and keyboard assembly.

### Next steps

1. Install the [display assembly](#).
2. Install the [base cover](#).
3. Install the [SD card](#).
4. Follow the procedure in [After working inside your computer](#).

## Palm-rest and keyboard assembly

### Removing the palm-rest and keyboard assembly

#### Prerequisites

1. Follow the procedure in [Before working inside your computer](#).
2. Remove the [SD card](#).
3. Remove the [base cover](#).
4. Remove the [3-cell battery](#) or [4-cell battery](#) (whichever applicable).
5. Remove the [M.2 2230 solid-state drive](#) or [M.2 2280 solid-state drive](#) (whichever applicable).
6. Remove the [memory modules](#).
7. Remove the [wireless card](#).



8. Remove the [speakers](#).
9. Remove the [fan](#).
10. Remove the [heat sink](#).
11. Remove the [I/O board](#).
12. Remove the [hard drive assembly](#).
13. Remove the [touchpad](#).
14. Remove the [display assembly](#).
15. Remove the [power-adapter port](#).
16. Remove the [power button](#) or [power button with optional FPR](#).
17. Remove the [system board](#).

**i** **NOTE:** The system board can be removed along with the heat sink.

### About this task

**i** **NOTE:** The following image shows the palm-rest for aluminum chassis which has WLAN antennas attached to it.

The following image indicates the location of the palm-rest and keyboard assembly and provides a visual representation of the removal procedure.

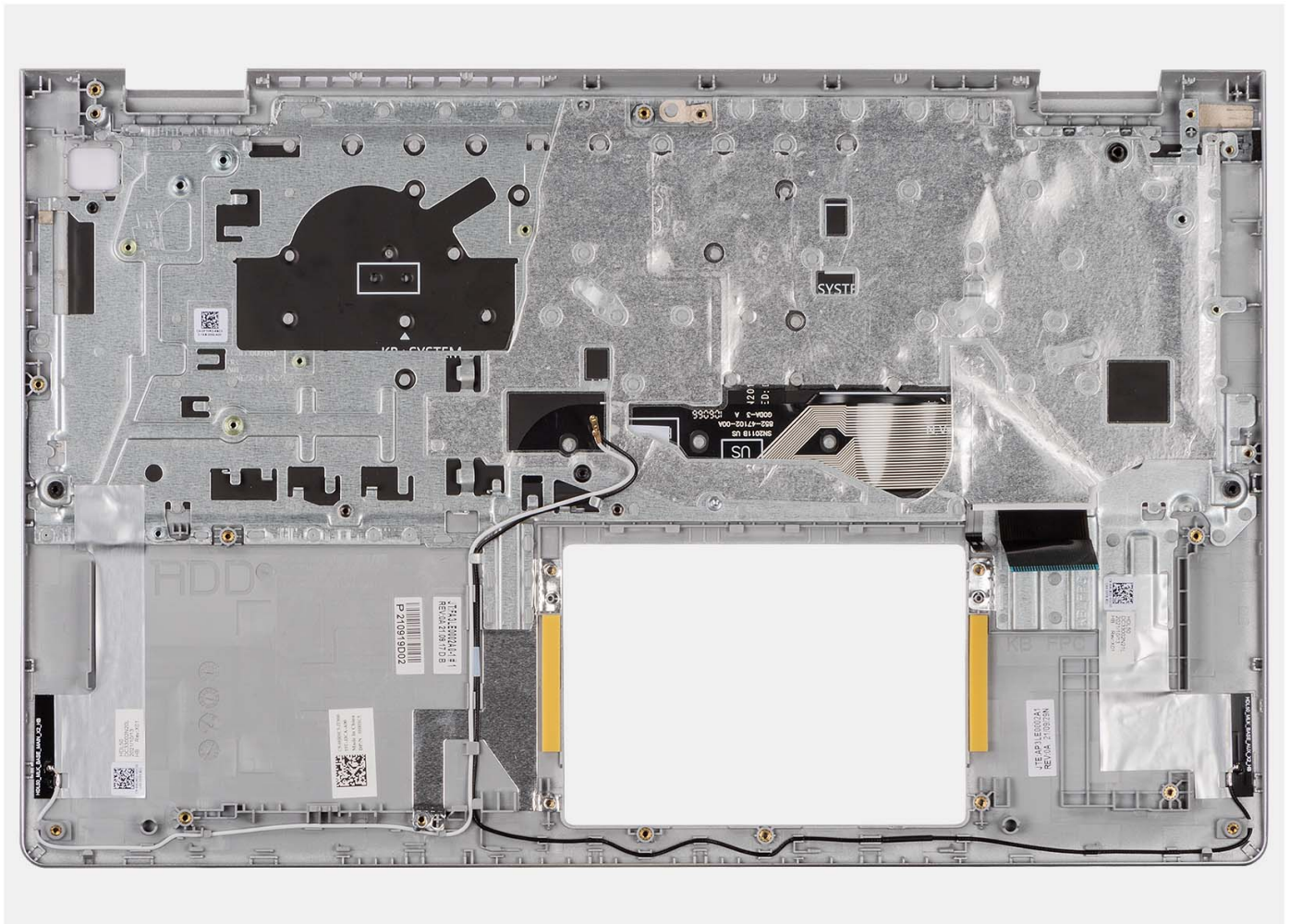

**i** **NOTE:**

For systems with an aluminum chassis, both the left and right RF metal brackets **MUST** be transferred to the replacement palm-rest.



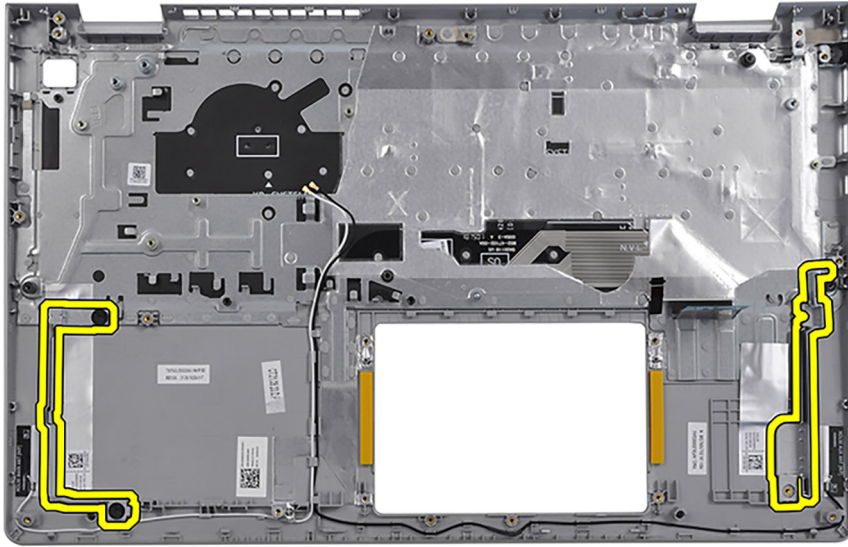

### Steps

After performing the pre-requisites, you are left with the palm-rest and keyboard assembly.

## Installing the palmrest and keyboard assembly

### Prerequisites

If you are replacing a component, remove the existing component before performing the installation process.

### About this task

The following image indicates the location of the palmrest and keyboard assembly and provides a visual representation of the installation procedure.

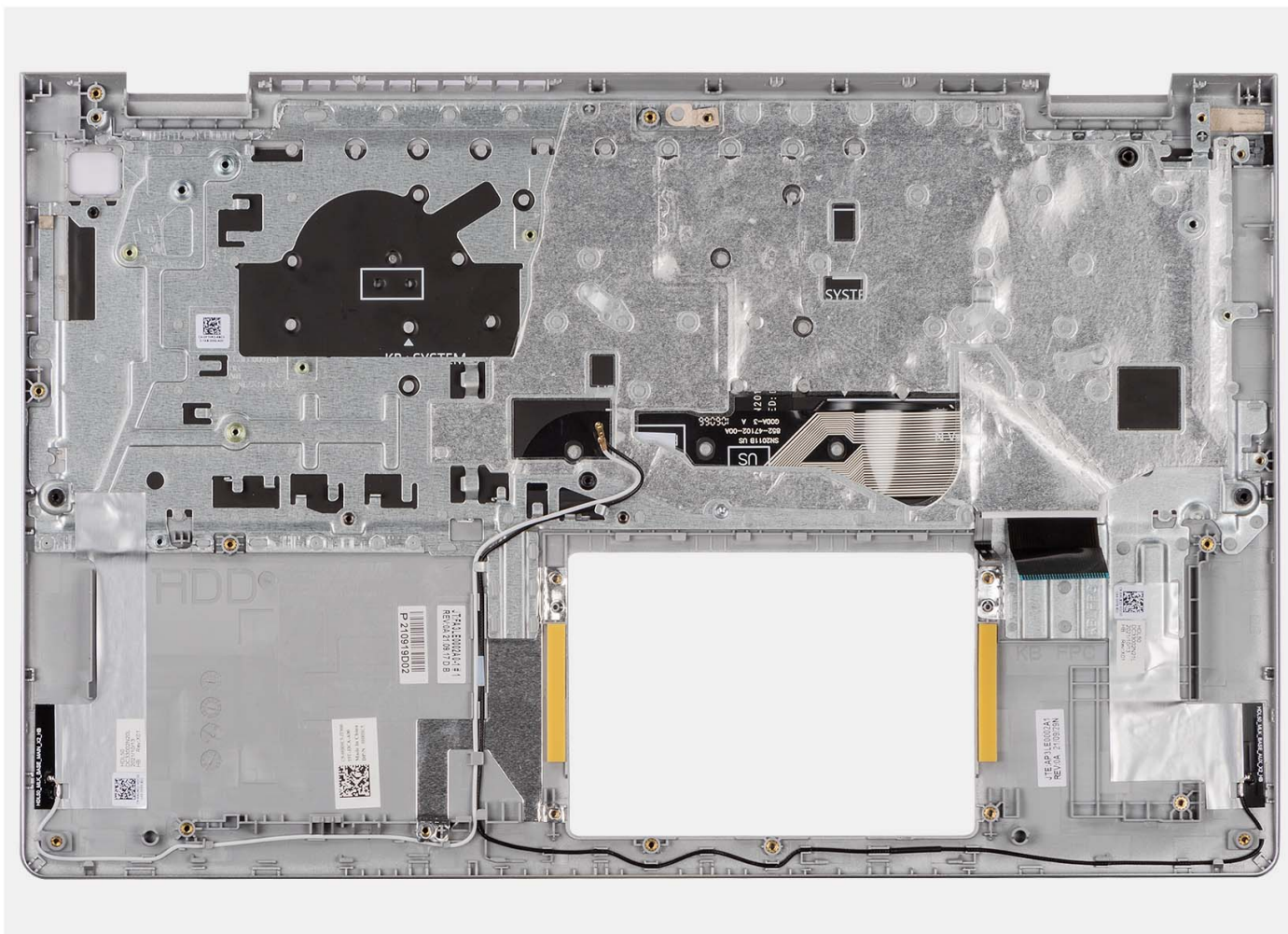

## Steps

Place the palm-rest and keyboard assembly on a flat and clean surface and perform the post-requisites to install the palm-rest and keyboard assembly.

## Next steps

1. Install the [system board](#).
2. Install the [power button](#) or [power button with optional FPR](#).
3. Install the [power-adapter port](#).
4. Install the [display assembly](#).
5. Install the [touchpad](#).
6. Install the [hard drive assembly](#).
7. Install the [I/O board](#).
8. Install the [heat sink](#).
9. Install the [fan](#).
10. Install the [speakers](#).
11. Install the [wireless card](#).
12. Install the [memory modules](#).
13. Install the [M.2 2230 solid-state drive](#) or [M.2 2280 solid-state drive](#) (whichever applicable).
14. Install the [3-cell battery](#) or [4-cell battery](#) (whichever applicable).
15. Install the [base cover](#).
16. Install the [SD card](#).
17. Follow the procedure in [After working inside your computer](#).

## Drivers and downloads

When troubleshooting, downloading or installing drivers it is recommended that you read the Dell Knowledge Base article, Drivers and Downloads FAQ [000123347](#).

# BIOS setup

**CAUTION:** Unless you are an expert computer user, do not change the settings in the BIOS Setup program. Certain changes can make your computer work incorrectly.

**NOTE:** Depending on the computer and its installed devices, the items listed in this section may or may not be displayed.

**NOTE:** Before you change BIOS Setup program, it is recommended that you write down the BIOS Setup program screen information for future reference.

Use the BIOS Setup program for the following purposes:

- Get information about the hardware installed in your computer, such as the amount of RAM and the size of the hard drive.
- Change the system configuration information.
- Set or change a user-selectable option, such as the user password, type of hard drive installed, and enabling or disabling base devices.

## Entering BIOS setup program

### About this task

Turn on (or restart) your computer and press F2 immediately.

## Navigation keys

**NOTE:** For most of the System Setup options, changes that you make are recorded but do not take effect until you restart the system.

**Table 3. Navigation keys**

Keys	Navigation
Up arrow	Moves to the previous field.
Down arrow	Moves to the next field.
Enter	Selects a value in the selected field (if applicable) or follow the link in the field.
Spacebar	Expands or collapses a drop-down list, if applicable.
Tab	Moves to the next focus area. <b>NOTE:</b> For the standard graphics browser only.
Esc	Moves to the previous page until you view the main screen. Pressing Esc in the main screen displays a message that prompts you to save any unsaved changes and restarts the system.

## One Time Boot menu

To enter **One Time Boot menu**, turn on your computer, and then press F12 immediately.

**NOTE:** It is recommended to shutdown the computer if it is on.



The one-time boot menu displays the devices that you can boot from including the diagnostic option. The boot menu options are:

- Removable Drive (if available)
- STXXXX Drive (if available)
- **i** **NOTE:** XXX denotes the SATA drive number.
- Optical Drive (if available)
- SATA Hard Drive (if available)
- Diagnostics

The boot sequence screen also displays the option to access the System Setup screen.

## System setup options

**i** **NOTE:** Depending on your computer and its installed devices, the items listed in this section may or may not appear.

**Table 4. System setup options—Main menu**

<b>Main</b>	
System Time	Displays the current time in hh:mm:ss format.
System Date	Displays the current date in mm/dd/yyyy format.
BIOS Version	Displays the BIOS version.
Product Name	Displays the model number of your computer.
Service Tag	Displays the service tag of your computer.
Asset Tag	Displays the asset tag of your computer.
CPU Type	Displays the processor type.
CPU Speed	Displays the processor speed.
CPU ID	Displays the processor identification code.
<b>CPU Cache</b>	
L1 Cache	Displays the processor L1 cache size.
L2 Cache	Displays the processor L2 cache size.
L3 Cache	Displays the processor L3 cache size.
First HDD	Displays the type of hard drive installed.
M.2 PCIe SSD	Displays the PCIe SSD information connected to the M.2 slot.
AC Adapter Type	Displays the type of AC adapter.
System Memory	Displays the size of memory installed.
Memory Speed	Displays the speed of memory.
Keyboard Type	Displays the type of keyboard installed on the computer.

**Table 5. System setup options—Advanced menu**

<b>Advanced</b>	
Integrated NIC	Enables or disables the on-board LAN controller. Default: Enabled
USB Emulation	Enables or disables the USB emulation feature. This feature defines how the BIOS, in the absence of a USB-aware operating system, handles USB devices. USB emulation is always enabled during POST.

**Table 5. System setup options—Advanced menu (continued)**

<b>Advanced</b>	
	<p> <b>NOTE:</b> You cannot boot any type of USB device (floppy, hard drive, or memory key) when this option is off.</p> <p>Default: Enabled</p>
USB PowerShare	<p>Enables or disables the USB PowerShare feature. This feature</p> <p><b>allows the user to charge USB devices cellular phones, portable music players, and so on</b> when the system is on battery power.</p> <p>Default: Enabled</p>
SATA Operation	<p>Allows you to configure the operating mode of the integrated SATA hard drive controller.</p> <p>Default: AHCI</p>
Adapter Warnings	<p>Allows you to choose if the computer should display warning messages when you use AC adapters that are not supported by your computer.</p> <p>Default: Enabled</p>
Function Key Behavior	<p>Allows you to set function key or multimedia key as the default function key behavior.</p> <p>Default: Multimedia key</p>
Keyboard Illumination	<p>Selects the operating mode of the keyboard illumination feature.</p> <p>Default: Dim</p>
Keyboard Backlight with AC	<p>Selects the timeout value for the keyboard backlight when an AC adapter is plugged into the computer.</p> <p>Default: 1 minute</p>
Keyboard Backlight with Battery	<p>Selects the timeout value for the keyboard backlight when the computer is running on battery power.</p> <p>Default: 1 minute</p>
Battery Health	<p>Displays the battery health.</p>
Camera	<p>Enables or disables the camera.</p> <p>Default: Enabled</p>
Battery Charge Configuration	<p>Set the battery charge settings with a preselected custom charge start and stop.</p> <p>Default: Adaptive</p>
Advanced Battery Charge Configuration	<p>Enable Advanced Battery Charge Configuration from the beginning of the day to a specified work period.</p> <p>Default: Disabled</p>
IPv4 HTTP Support	<p>Default: Disabled</p>
IPv6 HTTP Support	<p>Default: Disabled</p>
<b>Power Option</b>	
<b>Maintenance</b>	
Data Wipe on next boot	<p>Enables or disables data wipe on the next boot.</p> <p>Default: Disabled</p>

**Table 5. System setup options—Advanced menu (continued)**

<b>Advanced</b>	
BIOS Recovery from Hard Drive	Enables the user to recover from certain corrupted BIOS conditions from a recovery file on the user primary hard drive or an external USB key.
BIOS Auto-Recovery	Enables BIOS to automatically recover BIOS without user actions. Default: Disabled
<b>SupportAssist System Resolution</b>	
Auto OS Recovery Threshold	Controls the automatic boot flow for SupportAssist System Resolution Console and for the Dell OS Recovery tool. Default: 2
SupportAssist OS Recovery	Enables or disables the boot flow for the SupportAssist OS Recovery tool in the even of certain system errors. Default: Disabled
CPU TCC offset	Default: (0)

**Table 6. System setup options—Security menu**

<b>Security</b>	
Admin Password Status	Displays if the administrator password is clear or set. Default: Not Set
System Password Status	Displays if the system password is clear or set. Default: Not Set
<b>Asset Tag</b>	
Admin Password	Set your system’s Asset Tag. Allows you to set the administrator password. The administrator password controls access to the system setup utility.
System Password	Allows you to set the system password. The system password controls access to the computer at boot.
HDD Password	Allows you to set the HDD password. The HDD password controls access to the computers HDD.
Password Change	Allows you to permit or deny system password or HDD password changes. Default: Permitted
Absolute®	Allows you to track your computer Default: enabled For additional security, Dell Technologies recommends keeping the <b>Absolute</b> option enabled.
Absolute® Status	Allows you to activate or deactivate the Absolute® feature Displays if the system password is clear or set. Default: Deactivate
WINDOWS SMM SECURITY MITIGATIONS TABLE (WSMT)	Enables or disables configuration of platform features on Dell Client Systems with WSMT-enabled BIOS. Default: Enabled For additional security, Dell Technologies recommends keeping the <b>WINDOWS SMM SECURITY MITIGATIONS TABLE (WSMT)</b> option enabled.

**Table 6. System setup options—Security menu (continued)**

<b>Security</b>	
Firmware TPM	<p>Enable or disable the firmware TPM.</p> <p>Default: Enabled</p> <p>For additional security, Dell Technologies recommends keeping <b>Firmware TPM</b> enabled to allow these security technologies to fully function.</p>
PPI Bypass for Clear Command	<p>Allows you to control the TPM Physical Presence Interface (PPI). When enabled, this setting will allow the OS to skip BIOS PPI user prompts when issuing the Clear command. Changes to this setting take effect immediately.</p> <p>Default: Disabled</p> <p>For additional security, Dell Technologies recommends keeping the <b>PPI Bypass for Clear Command</b> option enabled.</p>
TPM Security	<p>TPM 2.0 Security options.</p>
UEFI Firmware Capsule Updates	<p>Enables or disables BIOS updates through UEFI capsule update packages.</p> <p>Default: Enabled</p> <p>For additional security, Dell Technologies recommends keeping the <b>UEFI Firmware Capsule Updates</b> option enabled.</p>
Secure Boot	<p>Enables or disables Secure Boot.</p> <p>Default: Enabled</p> <p>For additional security, Dell Technologies recommends keeping the <b>Secure Boot</b> option enabled.</p>

**Table 7. System setup options—Boot menu**

<b>Boot</b>	
File Browser Add Boot Option	Allows you to add boot options.

**Table 8. System setup options—Exit menu**

<b>Exit</b>	
Exit Saving Changes	Allows you to exit system setup and save your changes.
Save Change Without Exit	Allows you to save your changes without exiting the BIOS setup.
Exit Discarding Changes	Allows you to exit the BIOS setup without saving the changes.
Load Optimal Defaults	Allows you to restore default values for all system setup options.
Discard Changes	Allows you to load previous values for all system setup options.



# Updating the BIOS

## Updating the BIOS in Windows

### About this task

 **CAUTION:** If BitLocker is not suspended before updating the BIOS, the next time you reboot the system it will not recognize the BitLocker key. You will then be prompted to enter the recovery key to progress and the system will ask for this on each reboot. If the recovery key is not known this can result in data loss or an unnecessary operating system re-install. For more information on this subject, search in the Knowledge Base Resource at [www.dell.com/support](http://www.dell.com/support).

### Steps

1. Go to [www.dell.com/support](http://www.dell.com/support).
2. Click **Product support**. In the **Search support** box, enter the Service Tag of your computer, and then click **Search**.  
 **NOTE:** If you do not have the Service Tag, use the SupportAssist feature to automatically identify your computer. You can also use the product ID or manually browse for your computer model.
3. Click **Drivers & Downloads**. Expand **Find drivers**.
4. Select the operating system installed on your computer.
5. In the **Category** drop-down list, select **BIOS**.
6. Select the latest version of BIOS, and click **Download** to download the BIOS file for your computer.
7. After the download is complete, browse the folder where you saved the BIOS update file.
8. Double-click the BIOS update file icon and follow the on-screen instructions.  
For more information, search in the Knowledge Base Resource at [www.dell.com/support](http://www.dell.com/support).

## Updating the BIOS in Linux and Ubuntu

To update the system BIOS on a computer that is installed with Linux or Ubuntu, see the knowledge base article [000131486](https://www.dell.com/support/000131486) at [www.dell.com/support](http://www.dell.com/support).

## Updating the BIOS using the USB drive in Windows

### About this task

 **CAUTION:** If BitLocker is not suspended before updating the BIOS, the next time you reboot the system it will not recognize the BitLocker key. You will then be prompted to enter the recovery key to progress and the system will ask for this on each reboot. If the recovery key is not known this can result in data loss or an unnecessary operating system re-install. For more information on this subject, search in the Knowledge Base Resource at [www.dell.com/support](http://www.dell.com/support).

### Steps

1. Follow the procedure from step 1 to step 6 in [Updating the BIOS in Windows](#) to download the latest BIOS setup program file.
2. Create a bootable USB drive. For more information, search in the Knowledge Base Resource at [www.dell.com/support](http://www.dell.com/support).
3. Copy the BIOS setup program file to the bootable USB drive.
4. Connect the bootable USB drive to the computer that needs the BIOS update.
5. Restart the computer and press **F12**.
6. Select the USB drive from the **One Time Boot Menu**.
7. Type the BIOS setup program filename and press **Enter**.  
The **BIOS Update Utility** appears.
8. Follow the on-screen instructions to complete the BIOS update.

# Updating the BIOS from the F12 One-Time boot menu

Update your computer BIOS using the BIOS update.exe file that is copied to a FAT32 USB drive and booting from the F12 One-Time boot menu.

## About this task

**CAUTION:** If BitLocker is not suspended before updating the BIOS, the next time you reboot the system it will not recognize the BitLocker key. You will then be prompted to enter the recovery key to progress and the system will ask for this on each reboot. If the recovery key is not known this can result in data loss or an unnecessary operating system re-install. For more information on this subject, search in the Knowledge Base Resource at [www.dell.com/support](http://www.dell.com/support).

## BIOS Update

You can run the BIOS update file from Windows using a bootable USB drive or you can also update the BIOS from the F12 One-Time boot menu on the computer.

Most of the Dell computers built after 2012 have this capability, and you can confirm by booting your computer to the F12 One-Time Boot Menu to see if BIOS FLASH UPDATE is listed as a boot option for your computer. If the option is listed, then the BIOS supports this BIOS update option.

**NOTE:** Only computers with BIOS Flash Update option in the F12 One-Time boot menu can use this function.

## Updating from the One-Time boot menu

To update your BIOS from the F12 One-Time boot menu, you need the following:

- USB drive formatted to the FAT32 file system (key does not have to be bootable)
- BIOS executable file that you downloaded from the Dell Support website and copied to the root of the USB drive
- AC power adapter that is connected to the computer
- Functional computer battery to flash the BIOS

Perform the following steps to perform the BIOS update flash process from the F12 menu:

**CAUTION:** Do not turn off the computer during the BIOS update process. The computer may not boot if you turn off your computer.

## Steps

1. From a turn off state, insert the USB drive where you copied the flash into a USB port of the computer.
2. Turn on the computer and press F12 to access the One-Time Boot Menu, select BIOS Update using the mouse or arrow keys then press Enter.  
The flash BIOS menu is displayed.
3. Click **Flash from file**.
4. Select external USB device.
5. Select the file and double-click the flash target file, and then click **Submit**.
6. Click **Update BIOS**. The computer restarts to flash the BIOS.
7. The computer will restart after the BIOS update is completed.

# System and setup password

Table 9. System and setup password

Password type	Description
System password	Password that you must enter to log in to your system.
Setup password	Password that you must enter to access and make changes to the BIOS settings of your computer.

You can create a system password and a setup password to secure your computer.

 **CAUTION:** The password features provide a basic level of security for the data on your computer.

 **CAUTION:** Anyone can access the data that is stored on your computer if it is not locked and left unattended.

 **NOTE:** System and setup password feature is disabled.

## Assigning a system setup password

### Prerequisites

You can assign a new **System or Admin Password** only when the status is in **Not Set**.

### About this task

To enter the system setup, press F12 immediately after a power-on or reboot.

### Steps

1. In the **System BIOS** or **System Setup** screen, select **Security** and press Enter.  
The **Security** screen is displayed.
2. Select **System/Admin Password** and create a password in the **Enter the new password** field.  
Use the following guidelines to assign the system password:
  - A password can have up to 32 characters.
  - At least one special character: ! " # \$ % & ' ( ) \* + , - . / : ; < = > ? @ [ \ ] ^ \_ ` { | }
  - Numbers 0 through 9.
  - Upper case letters from A to Z.
  - Lower case letters from a to z.
3. Type the system password that you entered earlier in the **Confirm new password** field and click **OK**.
4. Press Esc and save the changes as prompted by the pop-up message.
5. Press Y to save the changes.  
The computer restarts.

## Deleting or changing an existing system setup password

### Prerequisites

Ensure that the **Password Status** is Unlocked (in the System Setup) before attempting to delete or change the existing System and/or Setup password. You cannot delete or change an existing System or Setup password, if the **Password Status** is Locked.

### About this task

To enter the System Setup, press F12 immediately after a power-on or reboot.

### Steps

1. In the **System BIOS** or **System Setup** screen, select **System Security** and press Enter.  
The **System Security** screen is displayed.
2. In the **System Security** screen, verify that **Password Status** is **Unlocked**.
3. Select **System Password**, update, or delete the existing system password, and press Enter or Tab.
4. Select **Setup Password**, update, or delete the existing setup password, and press Enter or Tab.  
 **NOTE:** If you change the System and/or Setup password, reenter the new password when prompted. If you delete the System and/or Setup password, confirm the deletion when prompted.
5. Press Esc and a message prompts you to save the changes.
6. Press Y to save the changes and exit from System Setup.  
The computer restarts.

# Clearing BIOS (System Setup) and System passwords

## About this task

To clear the system or BIOS passwords, contact Dell technical support as described at [www.dell.com/contactdell](http://www.dell.com/contactdell).

 **NOTE:** For information on how to reset Windows or application passwords, refer to the documentation accompanying Windows or your application.



# Troubleshooting

## Handling swollen rechargeable Li-ion batteries

Like most laptops, Dell laptops use Lithium-ion batteries. One type of Lithium-ion battery is the rechargeable Li-ion battery. Rechargeable Li-ion batteries have increased in popularity in recent years and have become standard in the electronics industry due to customer preferences for a slim form factor (especially with newer ultra-thin laptops) and long battery life. Inherent to rechargeable Li-ion battery technology is the potential for swelling of the battery cells.

Swollen battery may impact the performance of the laptop. To prevent possible further damage to the device enclosure or internal components leading to malfunction, discontinue the use of the laptop and discharge it by disconnecting the AC adapter and letting the battery drain.

Swollen batteries should not be used and should be replaced and disposed of properly. We recommend contacting Dell product support for options to replace a swollen battery under the terms of the applicable warranty or service contract, including options for replacement by a Dell authorized service technician.

The guidelines for handling and replacing rechargeable Li-ion batteries are as follows:

- Exercise caution when handling rechargeable Li-ion batteries.
- Discharge the battery before removing it from the system. To discharge the battery, unplug the AC adapter from the system and operate the system only on battery power. When the system will no longer power on when the power button is pressed, the battery is fully discharged.
- Do not crush, drop, mutilate, or penetrate the battery with foreign objects.
- Do not expose the battery to high temperatures, or disassemble battery packs and cells.
- Do not apply pressure to the surface of the battery.
- Do not bend the battery.
- Do not use tools of any type to pry on or against the battery.
- If a battery gets stuck in a device as a result of swelling, do not try to free it as puncturing, bending, or crushing a battery can be dangerous.
- Do not attempt to reassemble a damaged or swollen battery into a laptop.
- Swollen batteries that are covered under warranty should be returned to Dell in an approved shipping container (provided by Dell)—this is to comply with transportation regulations. Swollen batteries that are not covered under warranty should be disposed of at an approved recycling center. Contact Dell product support at <https://www.dell.com/support> for assistance and further instructions.
- Using a non-Dell or incompatible battery may increase the risk of fire or explosion. Replace the battery only with a compatible battery purchased from Dell that is designed to work with your Dell computer. Do not use a battery from other computers with your computer. Always purchase genuine batteries from <https://www.dell.com> or otherwise directly from Dell.

Rechargeable Li-ion batteries can swell for various reasons such as age, number of charge cycles, or exposure to high heat. For more information on how to improve the performance and lifespan of the laptop battery and to minimize the possibility of occurrence of the issue, search Dell Laptop Battery in the Knowledge Base Resource at [www.dell.com/support](http://www.dell.com/support).

## Dell SupportAssist Pre-boot System Performance Check diagnostics

### About this task

SupportAssist diagnostics (also known as system diagnostics) performs a complete check of your hardware. The Dell SupportAssist Pre-boot System Performance Check diagnostics is embedded with the BIOS and is launched by the BIOS internally. The embedded system diagnostics provides a set of options for particular devices or device groups allowing you to:

- Run tests automatically or in an interactive mode
- Repeat tests
- Display or save test results

- Run thorough tests to introduce additional test options to provide extra information about the failed device(s)
- View status messages that inform you if tests are completed successfully
- View error messages that inform you of problems encountered during testing

**NOTE:** Some tests for specific devices require user interaction. Always ensure that you are present at the computer terminal when the diagnostic tests are performed.

For more information, see <https://www.dell.com/support/kbdoc/000180971>.

## Running the SupportAssist Pre-Boot System Performance Check

### Steps

1. Turn on your computer.
2. As the computer boots, press the F12 key as the Dell logo appears.
3. On the boot menu screen, select the **Diagnostics** option.
4. Click the arrow at the bottom left corner.  
Diagnostics front page is displayed.
5. Click the arrow in the lower-right corner to go to the page listing.  
The items detected are listed.
6. To run a diagnostic test on a specific device, press Esc and click **Yes** to stop the diagnostic test.
7. Select the device from the left pane and click **Run Tests**.
8. If there are any issues, error codes are displayed.  
Note the error code and validation number and contact Dell.

## Built-in self-test (BIST)

### M-BIST

M-BIST (Built In Self-Test) is the system board's built-in self-test diagnostics tool that improves the diagnostics accuracy of system board embedded controller (EC) failures.

**NOTE:** M-BIST can be manually initiated before POST (Power On Self Test).

### How to run M-BIST

**NOTE:** M-BIST must be initiated on the system from a power-off state either connected to AC power or with battery only.

1. Press and hold both the **M** key on the keyboard and the **power button** to initiate M-BIST.
2. With both the **M** key and the **power button** held down, the battery indicator LED may exhibit two states:
  - a. OFF: No fault detected with the system board
  - b. AMBER: Indicates a problem with the system board
3. If there is a failure with the system board, the battery status LED will flash one of the following error codes for 30 seconds:

**Table 10. LED error codes**

Blinking Pattern		Possible Problem
Amber	White	
2	1	CPU Failure
2	8	LCD Power Rail Failure
1	1	TPM Detection Failure
2	4	Memory/RAM failure

4. If there is no failure with the system board, the LCD will cycle through the solid color screens described in the LCD-BIST section for 30 seconds and then power off.

## LCD Power rail test (L-BIST)

L-BIST is an enhancement to the single LED error code diagnostics and is automatically initiated during POST. L-BIST will check the LCD power rail. If there is no power being supplied to the LCD (that is if the L-BIST circuit fails), the battery status LED will flash either an error code [2,8] or an error code [2,7].

**NOTE:** If L-BIST fails, LCD-BIST cannot function as no power will be supplied to the LCD.

### How to invoke L-BIST Test:

1. Press the power button to start the system.
2. If the system does not start up normally, look at the battery status LED:
  - If the battery status LED flashes an error code [2,7], the display cable may not be connected properly.
  - If the battery status LED flashes an error code [2,8], there is a failure on the LCD power rail of the system board, hence there is no power supplied to the LCD.
3. For cases, when a [2,7] error code is shown, check to see if the display cable is properly connected.
4. For cases when a [2,8] error code is shown, replace the system board.

## LCD Built-in Self Test (BIST)

Dell laptops have a built-in diagnostic tool that helps you determine if the screen abnormality you are experiencing is an inherent problem with the LCD (screen) of the Dell laptop or with the video card (GPU) and PC settings.

When you notice screen abnormalities like flickering, distortion, clarity issues, fuzzy or blurry image, horizontal or vertical lines, color fade etc., it is always a good practice to isolate the LCD (screen) by running the Built-In Self Test (BIST).

### How to invoke LCD BIST Test

1. Power off the Dell laptop.
2. Disconnect any peripherals that are connected to the laptop. Connect only the AC adapter (charger) to the laptop.
3. Ensure that the LCD (screen) is clean (no dust particles on the surface of the screen).
4. Press and hold **D** key and **Power on** the laptop to enter LCD built-in self test (BIST) mode. Continue to hold the D key, until the system boots up.
5. The screen will display solid colors and change colors on the entire screen to white, black, red, green, and blue twice.
6. Then it will display the colors white, black and red.
7. Carefully inspect the screen for abnormalities (any lines, fuzzy color or distortion on the screen).
8. At the end of the last solid color (red), the system will shut down.

**NOTE:** Dell SupportAssist Pre-boot diagnostics upon launch, initiates an LCD BIST first, expecting a user intervention confirm functionality of the LCD.

## System-diagnostic lights

This section lists the system-diagnostic lights of your Vostro 3520.

**Table 11. System-diagnostic lights**

Blinking pattern		Problem description	Suggested resolution
Amber	White		
2	1	CPU failure	<ul style="list-style-type: none"><li>• Run the Dell Support Assist/Dell Diagnostics tool.</li><li>• If problem persists, replace the system board.</li></ul>

**Table 11. System-diagnostic lights (continued)**

Blinking pattern		Problem description	Suggested resolution
Amber	White		
2	2	System board failure (included BIOS corruption or ROM error)	<ul style="list-style-type: none"> <li>Flash latest BIOS version</li> <li>If problem persists, replace the system board.</li> </ul>
2	3	No memory/RAM detected	<ul style="list-style-type: none"> <li>Confirm that the memory module is installed properly.</li> <li>If problem persists, replace the memory module.</li> </ul>
2	4	Memory/RAM failure	<ul style="list-style-type: none"> <li>Reset and swap memory modules among the slots.</li> <li>If problem persists, replace the memory module.</li> </ul>
2	5	Invalid memory installed	<ul style="list-style-type: none"> <li>Reset and swap memory modules among the slots.</li> <li>If problem persists, replace the memory module.</li> </ul>
2	6	System board/Chipset Error	Replace the system board.
2	7	LCD failure (SBIOS message)	Replace the LCD module.
2	8	LCD failure (EC detection of power rail failure)	Replace the system board.
3	1	CMOS battery failure	<ul style="list-style-type: none"> <li>Reset the main battery connection.</li> <li>If problem persists, replace the main battery.</li> </ul>
3	2	PCI or Video card/chip failure	Replace the system board.
3	3	BIOS Recovery image not found	<ul style="list-style-type: none"> <li>Flash latest BIOS version</li> <li>If problem persists, replace the system board.</li> </ul>
3	4	BIOS Recovery image found but invalid	<ul style="list-style-type: none"> <li>Flash latest BIOS version</li> <li>If problem persists, replace the system board.</li> </ul>
3	5	Power rail failure	Replace the system board.
3	6	Flash corruption detected by SBIOS.	<ul style="list-style-type: none"> <li>Press power button for over 25 seconds to do RTC reset. If problem persists, replace the system board.</li> <li>Disconnect all power source (AC, battery, coin cell) and drain flea power by pressing and holding down power button 3~5 seconds to ensure all power are drained.</li> </ul>



**Table 11. System-diagnostic lights (continued)**

Blinking pattern		Problem description	Suggested resolution
Amber	White		
			<ul style="list-style-type: none"> <li>• Run "BIOS recovery from USB", and the instructions are in the website <a href="#">Dell support</a>.</li> <li>• If problem persists, replace the system board.</li> </ul>

**NOTE:** Blinking 3-3-3 LEDs on Lock LED (Caps-Lock or Num-Lock), Power button LED (without Fingerprint reader), and Diagnostic LED indicates failure to provide input during LCD panel test on Dell SupportAssist Pre-boot System Performance. Check diagnostics.

## Recovering the operating system

When your computer is unable to boot to the operating system even after repeated attempts, it automatically starts Dell SupportAssist OS Recovery.

Dell SupportAssist OS Recovery is a standalone tool that is preinstalled in all Dell computers installed with Windows operating system. It consists of tools to diagnose and troubleshoot issues that may occur before your computer boots to the operating system. It enables you to diagnose hardware issues, repair your computer, back up your files, or restore your computer to its factory state.

You can also download it from the Dell Support website to troubleshoot and fix your computer when it fails to boot into their primary operating system due to software or hardware failures.

For more information about the Dell SupportAssist OS Recovery, see *Dell SupportAssist OS Recovery User's Guide* at [www.dell.com/serviceabilitytools](http://www.dell.com/serviceabilitytools). Click **SupportAssist** and then, click **SupportAssist OS Recovery**.

## Backup media and recovery options

It is recommended to create a recovery drive to troubleshoot and fix problems that may occur with Windows. Dell proposes multiple options for recovering Windows operating system on your Dell PC. For more information, see [Dell Windows Backup Media and Recovery Options](#).

## Wi-Fi power cycle

### About this task

If your computer is unable to access the Internet due to Wi-Fi connectivity issues a Wi-Fi power cycle procedure may be performed. The following procedure provides the instructions on how to conduct a Wi-Fi power cycle:

**NOTE:** Some ISPs (Internet Service Providers) provide a modem/router combo device.

### Steps

1. Turn off your computer.
2. Turn off the modem.
3. Turn off the wireless router.
4. Wait for 30 seconds.
5. Turn on the wireless router.
6. Turn on the modem.
7. Turn on your computer.

# Drain residual flea power (perform hard reset)

## About this task

Flea power is the residual static electricity that remains in the computer even after it has been powered off and the battery is removed.

For your safety, and to protect the sensitive electronic components in your computer, you are requested to drain residual flea power before removing or replacing any components in your computer.

Draining residual flea power, also known as a performing a "hard reset", is also a common troubleshooting step if your computer does not power on or boot into the operating system.

## To drain residual flea power (perform a hard reset)

### Steps

1. Turn off your computer.
2. Disconnect the power adapter from your computer.
3. Remove the base cover.
4. Remove the battery.
5. Press and hold the power button for 20 seconds to drain the flea power.
6. Install the battery.
7. Install the base cover.
8. Connect the power adapter to your computer.
9. Turn on your computer.



 **NOTE:** For more information about performing a hard reset, search in the Knowledge Base Resource at [www.dell.com/support](http://www.dell.com/support).

# Getting help and contacting Dell

## Self-help resources

You can get information and help on Dell products and services using these self-help resources:

**Table 12. Self-help resources**

Self-help resources	Resource location
Information about Dell products and services	<a href="http://www.dell.com">www.dell.com</a>
My Dell app	
Tips	
Contact Support	In Windows search, type <code>Contact Support</code> , and press Enter.
Online help for operating system	<a href="http://www.dell.com/support/windows">www.dell.com/support/windows</a> <a href="http://www.dell.com/support/linux">www.dell.com/support/linux</a>
Access top solutions, diagnostics, drivers and downloads, and learn more about your computer through videos, manuals and documents.	Your Dell computer is uniquely identified by a Service Tag or Express Service Code. To view relevant support resources for your Dell computer, enter the Service Tag or Express Service Code at <a href="http://www.dell.com/support">www.dell.com/support</a> .  For more information on how to find the Service Tag for your computer, see <a href="#">Locate the Service Tag on your computer</a> .
Dell knowledge base articles for a variety of computer concerns	<ol style="list-style-type: none"> <li>1. Go to <a href="http://www.dell.com/support">www.dell.com/support</a>.</li> <li>2. On the menu bar at the top of the Support page, select <b>Support &gt; Knowledge Base</b>.</li> <li>3. In the Search field on the Knowledge Base page, type the keyword, topic, or model number, and then click or tap the search icon to view the related articles.</li> </ol>

## Contacting Dell

To contact Dell for sales, technical support, or customer service issues, see [www.dell.com/contactdell](http://www.dell.com/contactdell).

 **NOTE:** Availability varies by country/region and product, and some services may not be available in your country/region.

 **NOTE:** If you do not have an active Internet connection, you can find contact information about your purchase invoice, packing slip, bill, or Dell product catalog.