

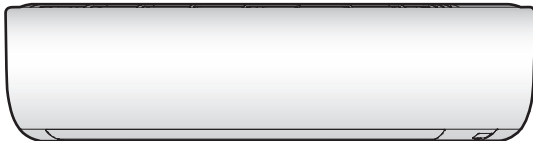

Installation manual

Daikin room air conditioner



FTXP50M2V1B
FTXP60M2V1B
FTXP71M2V1B

FTXF50D2V1B
FTXF60D2V1B
FTXF71D2V1B

FTXF50A2V1B
FTXF60A2V1B
FTXF71A2V1B

ATXF50A2V1B
ATXF60A2V1B
ATXF71A2V1B

CE - DECLARACIONE DE CONFORMIDAD
 CE - KONFORMITÄTSEKLERÄRNING
 CE - DICHAIRAZIONE DI CONFORMITA
 CE - ΔΗΛΩΣΗ ΣΥΜΠΛΗΡΩΣΗΣ
 CE - CONFORMITÄTSEKLERÄRUNG

Daikin Industries Czech Republic s.r.o.

- 01 (en) déclare sous sa seule responsabilité que le modèle de conditionnement d'air est conforme à la déclaration relative.
- 02 (en) erklärt auf seine alleinige Verantwortung, dass die Modelle der Klimaanlage für die diese Erklärung bestimmt ist.
- 03 (en) déclare sous sa seule responsabilité que les appareils d'air conditionné vérifiés par la présente déclaration.
- 04 (en) verklaart hierbij op zijn eigen oorspronkelijke verantwoordelijkheid dat de airconditioning units waaraan deze verklaring betrekking heeft.
- 05 (en) déclare sous sa seule responsabilité que les modèles de air conditionné ont été conçus et fabriqués conformément à la déclaration.
- 06 (en) δηλώνω με αποκλειστική μου ευθύνη ότι η περίληψη αυτής της δήλωσης συμplies αφορά μοντέλα που έχουν σχεδιαστεί και κατασκευαστεί σύμφωνα με τα στοιχεία που περιλαμβάνονται στην παρούσα δήλωση.
- 07 (en) déclare sous sa seule responsabilité que les modèles de air conditionné ont été conçus et fabriqués conformément à la déclaration.

FTXP60M2V1B, FTXP60M2V1B, FTXP71M2V1B,

- 01 are in conformity with the following standard(s) or other normative document(s), provided that these are used in accordance with our instructions:
- 02 werden (Anweisungs) Norm(en) oder einem anderen Normdokument oder Dokumenten entsprechend, unter der Voraussetzung, dass sie gemäß unserer Anweisungen eingesetzt werden.
- 03 sont conformes à l(ux) norme(s) ou autre(s) document(s) normatifs, pour autant qu'ils soient utilisés conformément à nos instructions.
- 04 conform de volgende norm(en) / één of meer andere bindende documenten zijn, op voorwaarde dat ze worden gebruikt overeenkomstig onze instructies.
- 05 están en conformidad con la(s) siguiente(s) norma(s) u otro(s) documento(s) normativo(s), siempre que sean utilizados de acuerdo con nuestras instrucciones.
- 06 sono conformi all(elle) seguente(s) standard(i) o altro(i) documento(i) a carattere normativo, a patto che vengano usati in conformità alle nostre istruzioni.
- 07 είναι σύμφωνα με το(α) ακόλουθο(α) πρότυπο(α) ή άλλο(α) έγγραφο(α) κανονιστικό, υπό την προϋπόθεση ότι χρησιμοποιούνται σύμφωνα με τις οδηγίες μας.

EN60335-2-40,

- 01 gemäß den provisions of:
- 02 enligt den Vorkrifter för:
- 03 conformément aux stipulations des:
- 04 overeenkomstig de bepalingen van:
- 05 σύμφωνα με τις διατάξεις των:
- 06 secondo le prescrizioni per:
- 07 με την προϋπόθεση των οδηγιών μας.
- 08 de acuerdo con el previso etc.
- 09 в соответствии с положениями:

- 01 Not* as set out in <A> and judged positively by
- 02 Hinweis* according to the certificate <C>
- 03 Remark* bei der defini dans <A> et évalué positivement par
- 04 Remark* zoals vermeld in <A> en positief beoordeeld door
- 05 Not* como se establece en <A> y es valorado positivamente por
- 06 Not* in una prevección.
- 07 Zjeplivon* potvrdení generál.Zertifikat <C>
- 08 Not* potvrdení generál.Zertifikat <C>
- 09 Priměvené* zoals vermeld in <A> en positief beoordeeld door
- 10 Remark* como se establece en <A> y es valorado positivamente por

- 07** H DČz** je autorizován k vyplnění technické konstrukční soubory.
- 08** A DČz** está autorizada a completar el documento técnico de fábrica.
- 09** Компания DČz** уполномочена составлять техническую документацию.
- 10** DČz** er autoriseret til at udarbejde de tekniske konstruktionsfil.
- 11** DČz** er bemyndiget att sammanställa de tekniska konstruktionsfilen.
- 12** DČz** har tillåtelse till å komplettera den tekniska konstruktionsfilen.

***DČz = Daikin Industries Czech Republic s.r.o.

CE - ERKLÄRUNG OM SÄMVISAR
 CE - MĚŘENÍ V OBLASTI KVALITATIVNÍ
 CE - ЛІЦЕНЗІЯ НА ВИРОБНИЦТВО
 CE - PROHLÁŠENÍ SHODY
 CE - FORSKÄRAN OM ÖVERENSSTÄMMELSE

- 08 (en) заявляет, несомненно под свою ответственность, что модели кондиционеров воздуха, ч, которых относятся настоящее заявление.
- 09 соответствуют следующим стандартам или другим нормативным документам, при условии их использования согласно нашим инструкциям.
- 10 (en) overholder følgende standard(er) eller andet/andre tekniske dokument(er), forudsat at disse anvendes i henhold til vore instruktioner.
- 11 respektive utövning av tillhör överensstämmelse med och följer följande standard(er) eller andra normativa dokument, under förutsättning att användning sker överensstämmelse med våra instruktioner.
- 12 respektive utstyri er i överensstemmelse med følgende standard(er) eller andre normgende dokument(er), under forutsætning at, at disse bruges i henhold til vore instruktioner.
- 13 vastavastat seuraavien standardien ja muiden ohjeellisten dokumenttien vaatimuksia edellyttäen, että niitä käytetään ohjeemme mukaisesti.
- 14 są zgodzący się z niniejszymi wytycznymi w sprawie użytkowania, obowiązującymi w odniesieniu do normatywnych dokumentów.
- 15 u skladu są z następującymi standardami i/lub innymi normatywnymi dokumentami, za przedpokład, że są používajúci v súlade s našimi navodami.

- 08 es-tu en conformitate cu (a) următorul (e) document(e) normativ(e), în condițiile în care acestea sunt utilizate în conformitate cu acordul cu și cu toate instrucțiunile.
- 09 conformez următoarelor standarde sau altor documente normative, în condițiile în care acestea sunt utilizate în conformitate cu acordul cu și cu toate instrucțiunile.
- 10 overholder følgende standard(er) eller andet/andre tekniske dokument(er), forudsat at disse anvendes i henhold til vore instruktioner.
- 11 respektive utövning av tillhör överensstämmelse med och följer följande standard(er) eller andra normativa dokument, under förutsättning att användning sker överensstämmelse med våra instruktioner.
- 12 respektive utstyri er i överensstemmelse med følgende standard(er) eller andre normgende dokument(er), under forutsætning at, at disse bruges i henhold til vore instruktioner.
- 13 vastavastat seuraavien standardien ja muiden ohjeellisten dokumenttien vaatimuksia edellyttäen, että niitä käytetään ohjeemme mukaisesti.
- 14 są zgodzący się z niniejszymi wytycznymi w sprawie użytkowania, obowiązującymi w odniesieniu do normatywnych dokumentów.
- 15 u skladu są z następującymi standardami i/lub innymi normatywnymi dokumentami, za przedpokład, że są používajúci v súlade s našimi navodami.

**Low Voltage 2014/35/EU
 Electromagnetic Compatibility 2014/30/EU
 Machinery 2006/42/EC**

- 16 Megjegyzés* a) / <A> alapján, a) / igazolta a megfelelést, a) / <C> tanúsítvány szerint.
- 17 Uvaga* spondel' tehnikomir / <A> og gjensvar positivt bekræftede at tilgæ Serifikat <C>
- 18 Not* jotta on esitettyä asetuksissa <A> ja jotta on hyväksyttyä Serifikatoin <C> mukaisesti.
- 19 Opomba* jak bylo uvedeno v <A> a pozitivne zjeleno v skladu s osvedčením <C>
- 20 Märkus* kako je izloženo u <A> pozitivno ocijenjeno od strane prema Certifikatu <C>

- 13** DČz** on valtuutettu laatimaan tekniikan asiantuntijien.
- 14** Společnost DČz** má oprávnění ke kompletní souhrnné technické konstrukci.
- 15** DČz** er ovårdet til at udarbejde de tekniske konstruktionsfil.
- 16** ADČz** je poveren za zbiranje in nastavljanje dokumentacije konstrukcijske fil.
- 17** DČz** má povolenie na zberanie a opracovanie dokumentácie konstrukcijskej.
- 18** DČz** este autorizat să completeze Dosarul Tehnic de construcție.

CE - IZJAVA O SKLADNOSTI
 CE - VASTAVASTÄKLAARAVUS
 CE - ДЕКЛАРАЦІЯ ПРО СІМВІДНІСТЬ
 CE - DECLARAȚIE DE CONFORMITATE

- 17 (en) déclare que les modèles de conditionnement d'air sont conformes à la déclaration relative.
- 18 (en) erklärt auf seine alleinige Verantwortung, dass die Modelle der Klimaanlage für die diese Erklärung bestimmt ist.
- 19 (en) déclare sous sa seule responsabilité que les appareils d'air conditionné vérifiés par la présente déclaration.
- 20 (en) verklaart hierbij op zijn eigen oorspronkelijke verantwoordelijkheid dat de airconditioning units waaraan deze verklaring betrekking heeft.
- 21 (en) déclare sous sa seule responsabilité que les modèles de air conditionné ont été conçus et fabriqués conformément à la déclaration.
- 22 (en) δηλώνω με αποκλειστική μου ευθύνη ότι η περίληψη αυτής της δήλωσης συμplies αφορά μοντέλα που έχουν σχεδιαστεί και κατασκευαστεί σύμφωνα με τα στοιχεία που περιλαμβάνονται στην παρούσα δήλωση.
- 23 (en) déclare sous sa seule responsabilité que les modèles de air conditionné ont été conçus et fabriqués conformément à la déclaration.
- 24 (en) δηλώνω με αποκλειστική μου ευθύνη ότι η περίληψη αυτής της δήλωσης συμplies αφορά μοντέλα που έχουν σχεδιαστεί και κατασκευαστεί σύμφωνα με τα στοιχεία που περιλαμβάνονται στην παρούσα δήλωση.

- 18 megjelöltek az alábbi szabvány(ok)nak vagy egyéb tárgyalt dokumentum(ok)nak, az azokat előírás szerint használták.
- 19 megfelelnek az alábbi szabvány(ok)nak vagy egyéb tárgyalt dokumentum(ok)nak, az azokat előírás szerint használták.
- 20 on vastavastat seuraaville standardeille ja/vai teille normatiivisille dokumenteille, kun neidä käytetään vastavasti meidän ohjeidemme mukaisesti.
- 21 соответствуют следующим стандартам или другим нормативным документам, при условии, что они используются в соответствии с нашими инструкциями.
- 22 ad, ja tehtiä alibiäsiä rääkäläjä määrittämien, alibiä esiköösämien standardien in olemu normatiivni dokumentienin.
- 23 ad, ja tehtiä alibiäsiä rääkäläjä määrittämien, alibiä esiköösämien standardien in olemu normatiivni dokumentienin.
- 24 su i zrobie z następującymi normami (albo innymi normatywnymi dokumentami), za przedpokład, że są používajúci v súlade s našimi navodami.
- 25 ürünü, laimatinlamza gere kulanımına koşulları asgari standartlar ve norm belirlenen beğenilerle uyumludur.

- 01 Directives as amended.
- 02 Direktiven, med senere ændringer.
- 03 Direktives, leies que modifiées.
- 04 Richtlijnen, zoals gewijzigd.
- 05 Directives, sau în amendament.
- 06 Directives, como de modifica.
- 07 Ohjeet, muutokset ja lisäohjeet.
- 08 Directives, conforme alterations etc.
- 09 Директива со всеми поправками.
- 10 Direktiven, med senere ændringer.
- 11 Direktive, med frelagna ändringar.
- 12 Direktives, leies que modifiées.
- 13 Richtlijnen, zoals gewijzigd.
- 14 in vianen zrobie.
- 15 Spiegata, kako je izmjenjeno.
- 16 irányelvények és módosítások rendelkezései.
- 17 z późniejszych uaktężeń i polemelek.

- 21 Zabeuravast* kato e ispovaleno e <A> y osuveno poroqumeno ot certifikatu Serifikavara <C>
- 22 Pastaba* kaptusite <A> y kapi legiamai nusprasta pagal Serifikata <C>
- 23 Pzīmēs* ka norādīts <A> un atbilstoš pozitīvajam vērtējumam sakarā ar serifikatu <C>
- 24 Poznamka* kako je oobčeno v <A> a pozitivno zjeleno v skladu s osvedčením <C>
- 25 Not* ragu on naldado dokumentis <A> ja heals kildelud jarg vastavali serifikatila <C>

- 19** DČz** je pooblaščen za sestavo datoteke s tehnično mapo.
- 20** DČz** on valtuutettu laatimaan tekniikan asiantuntijien.
- 21** DČz** er ovårdet til at udarbejde de tekniske konstruktionsfil.
- 22** DČz** je poveren za zbiranje in nastavljanje dokumentacije konstrukcijske fil.
- 23** DČz** má povolenie na zberanie a opracovanie dokumentácie konstrukcijskej.
- 24** Spoločnosť DČz** je oprávnená vyvíjať súbor technickej konštrukcie.
- 25** DČz** je autorizován k vyplnění technické konstrukční soubory.



Yasuto Hiraoka
 Managing Director
 Pilsen, 3rd of December 2018

DAIKIN INDUSTRIES CZECH REPUBLIC s.r.o.
 U Nové Hospody 1/1155, 301 00 Plzeň Skvrňany,
 Czech Republic

Table of contents

1	About the documentation	7
1.1	About this document.....	7
2	Specific installer safety instructions	7
3	About the box	8
3.1	Indoor unit	8
3.1.1	To remove the accessories from the indoor unit.....	8
4	About the unit	9
5	Unit installation	9
5.1	Preparing the installation site	9
5.1.1	Installation site requirements of the indoor unit	9
5.2	Mounting the indoor unit.....	9
5.2.1	To install the mounting plate	9
5.2.2	To drill a wall hole	9
5.2.3	To remove the pipe port cover	10
5.3	Connecting the drain piping.....	10
5.3.1	To connect the piping on right side, right-back, or right-bottom.....	10
5.3.2	To connect the piping on left side, left-back, or left-bottom	10
5.3.3	To check for water leaks	10
6	Piping installation	11
6.1	Preparing refrigerant piping	11
6.1.1	Refrigerant piping requirements.....	11
6.1.2	Refrigerant piping insulation	11
6.2	Connecting the refrigerant piping	11
6.2.1	To connect the refrigerant piping to the indoor unit	11
7	Electrical installation	11
7.1	Specifications of standard wiring components	12
7.2	To connect the electrical wiring to the indoor unit	12
7.3	To connect optional accessories (wired user interface, central user interface, wireless adapter, etc.)	12
8	Finishing the indoor unit installation	13
8.1	To insulate the drain piping, refrigerant piping and interconnection cable	13
8.2	To pass the pipes through the wall hole.....	13
8.3	To fix the unit on the mounting plate	13
9	Commissioning	13
9.1	Checklist before commissioning	13
9.2	To perform a test run.....	14
9.2.1	To perform a test run in winter season	14
10	Disposal	14
11	Technical data	14
11.1	Wiring diagram	14
11.1.1	Unified wiring diagram legend.....	14

1 About the documentation

1.1 About this document



INFORMATION

Make sure that the user has the printed documentation and ask him/her to keep it for future reference.

Target audience

Authorised installers



INFORMATION

This appliance is intended to be used by expert or trained users in shops, in light industry, and on farms, or for commercial and household use by lay persons.



WARNING

Make sure installation, servicing, maintenance, repair and applied materials follow the instructions from Daikin and, in addition, comply with applicable legislation and are performed by qualified persons only. In Europe and areas where IEC standards apply, EN/IEC 60335-2-40 is the applicable standard.

Documentation set

This document is part of a documentation set. The complete set consists of:

General safety precautions:

- Safety instructions that you **MUST** read before installing
- Format: Paper (in the box of the indoor unit)

Indoor unit installation manual:

- Installation instructions
- Format: Paper (in the box of the indoor unit)

Installer reference guide:

- Preparation of the installation, good practices, reference data,...
- Format: Digital files on <http://www.daikineurope.com/support-and-manuals/product-information/>

Latest revisions of the supplied documentation may be available on the regional Daikin website or via your dealer.

The original documentation is written in English. All other languages are translations.

Technical engineering data

- A **subset** of the latest technical data is available on the regional Daikin website (publicly accessible).
- The **full set** of latest technical data is available on the Daikin Business Portal (authentication required).

2 Specific installer safety instructions

Always observe the following safety instructions and regulations.

Unit installation (see "**5 Unit installation**" [▶ 9])



WARNING

Installation shall be done by an installer, the choice of materials and installation shall comply with the applicable legislation. In Europe, EN378 is the applicable standard.



WARNING

The appliance shall be stored so as to prevent mechanical damage and in a well-ventilated room without continuously operating ignition sources (e.g. open flames, an operating gas appliance, or an operating electric heater). The room size shall be as specified in the General safety precaution.



CAUTION

For walls containing a metal frame or a metal board, use a wall embedded pipe and wall cover in the feed-through hole to prevent possible heat, electrical shock, or fire.

3 About the box

Piping installation (see "6 Piping installation" [p 11])

CAUTION

Piping and joints of a split system shall be made with permanent joints when inside an occupied space except joints directly connecting the piping to the indoor units.

DANGER: RISK OF BURNING/SCALDING

CAUTION

- Use the flare nut fixed to the unit.
- To prevent gas leakage, apply refrigeration oil ONLY to the inside of the flare. Use refrigeration oil for R32.
- Do NOT reuse joints.

CAUTION

- Do NOT use mineral oil on flared part.
- NEVER install a drier to this R32 unit to guarantee its lifetime. The drying material may dissolve and damage the system.

CAUTION

- Incomplete flaring may cause refrigerant gas leakage.
- Do NOT re-use flares. Use new flares to prevent refrigerant gas leakage.
- Use flare nuts that are included with the unit. Using different flare nuts may cause refrigerant gas leakage.

Electrical installation (see "7 Electrical installation" [p 11])

DANGER: RISK OF ELECTROCUTION

WARNING

ALWAYS use multicore cable for power supply cables.

WARNING

- All wiring MUST be performed by an authorised electrician and MUST comply with the applicable legislation.
- Make electrical connections to the fixed wiring.
- All components procured on-site and all electrical construction MUST comply with the applicable legislation.

WARNING

- If the power supply has a missing or wrong N-phase, equipment might break down.
- Establish proper earthing. Do NOT earth the unit to a utility pipe, surge absorber, or telephone earth. Incomplete earthing may cause electrical shock.
- Install the required fuses or circuit breakers.
- Secure the electrical wiring with cable ties so that the cables do NOT come in contact with sharp edges or piping, particularly on the high-pressure side.
- Do NOT use taped wires, stranded conductor wires, extension cords, or connections from a star system. They can cause overheating, electrical shock or fire.
- Do NOT install a phase advancing capacitor, because this unit is equipped with an inverter. A phase advancing capacitor will reduce performance and may cause accidents.

WARNING

Use an all-pole disconnection type breaker with at least 3 mm between the contact point gaps that provide full disconnection under overvoltage category III.

WARNING

If the supply cord is damaged, it MUST be replaced by the manufacturer, its service agent or similarly qualified persons in order to avoid a hazard.

WARNING

Do NOT connect the power supply to the indoor unit. This could result in electrical shock or fire.

WARNING

- Do NOT use locally purchased electrical parts inside the product.
- Do NOT branch the power supply for the drain pump, etc. from the terminal block. This could result in electrical shock or fire.

WARNING

Keep the interconnection wiring away from copper pipes without thermal insulation as such pipes will be very hot.

3 About the box

3.1 Indoor unit

INFORMATION

The following figures are just examples and may NOT completely match your system layout.

- At delivery, the unit MUST be checked for damage. Any damage MUST be reported immediately to the claims agent of the carrier.
- Bring the packed unit as close as possible to its final installation position to prevent damage during transport.

3.1.1 To remove the accessories from the indoor unit

1 Remove:

- the accessory bag located at the bottom of the package,
- the mounting plate attached to the back of the indoor unit.

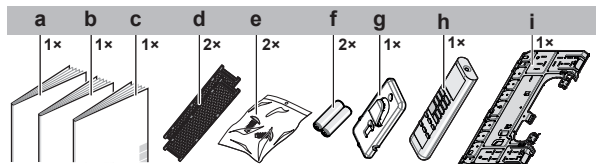

- a Installation manual
- b Operation manual
- c General safety precautions
- d Titanium apatite deodorising and silver particle filter (only for FTXP)
- e Indoor unit fixing screw (M4×12L). Refer to "8.3 To fix the unit on the mounting plate" [p 13].
- f Dry battery AAA.LR03 (alkaline) for user interface
- g User interface holder
- h User interface
- i Mounting plate

4 About the unit



WARNING: MILDLY FLAMMABLE MATERIAL

The refrigerant inside this unit is mildly flammable.

5 Unit installation



INFORMATION

If you are not sure how to open or close parts of the unit (front panel, electrical wiring box, front grille...) refer to the installer reference guide of the unit for opening and closing procedures.



WARNING

Installation shall be done by an installer, the choice of materials and installation shall comply with the applicable legislation. In Europe, EN378 is the applicable standard.

- **Drainage.** Make sure condensation water can be evacuated properly.
- **Wall insulation.** When conditions in the wall exceed 30°C and a relative humidity of 80%, or when fresh air is inducted into the wall, then additional insulation is required (minimum 10 mm thickness, polyethylene foam).
- **Wall strength.** Check whether the wall or the floor is strong enough to support the weight of the unit. If there is a risk, reinforce the wall or the floor before installing the unit.
- **Spacing.** Install the unit at least 1.8 m from the floor and keep the following requirements in mind for distances from the walls and the ceiling:

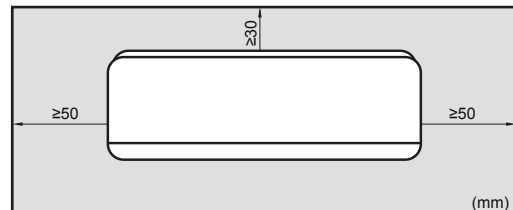

5.1 Preparing the installation site



WARNING

The appliance shall be stored so as to prevent mechanical damage and in a well-ventilated room without continuously operating ignition sources (e.g. open flames, an operating gas appliance, or an operating electric heater). The room size shall be as specified in the General safety precaution.

5.1.1 Installation site requirements of the indoor unit



INFORMATION

The sound pressure level is less than 70 dBA.

- **Air flow.** Make sure nothing blocks the air flow.

5.2 Mounting the indoor unit

5.2.1 To install the mounting plate

- 1 Install the mounting plate temporarily.
- 2 Level the mounting plate.
- 3 Mark the centres of the drilling points on the wall using a tape measure. Position the end of tape measure at symbol "▷".
- 4 Finish the installation by securing the mounting plate on the wall using M4×25L screws (field supply).



INFORMATION

The removed pipe port cover can be kept in the mounting plate pocket.

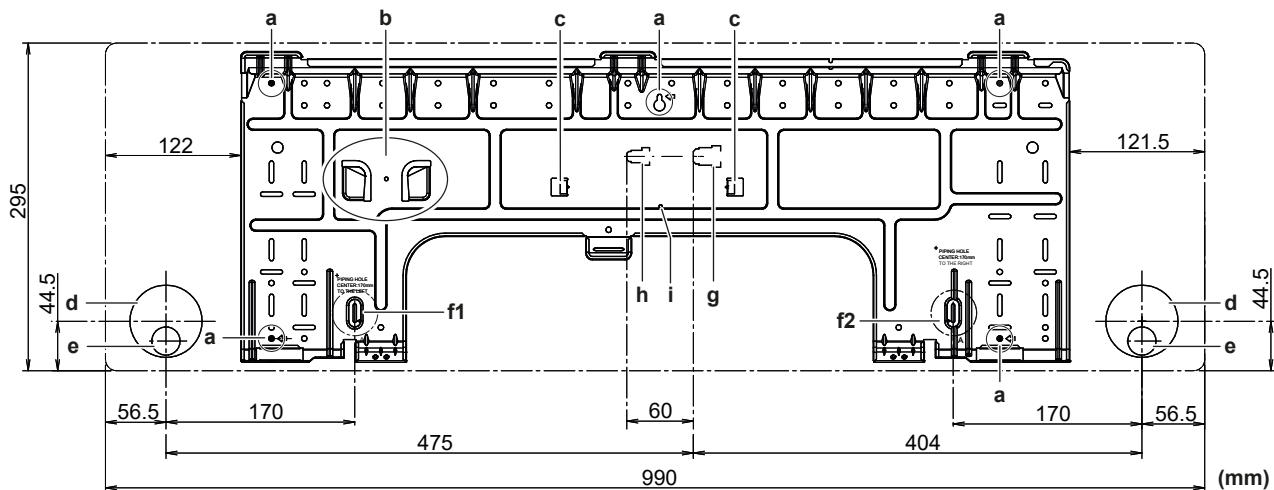

- a Recommended mounting plate fixing spots
- b Pocket for the pipe port cover
- c Tabs for placing a spirit level
- d Through-the-wall hole Ø65 mm
- e Drain hose position

- f1 Measure point for piping hole center "▷" (to left)
- f2 Measure point for piping hole center "▷" (to right)
- g Gas pipe end
- h Liquid pipe end
- i Center of the unit

5.2.2 To drill a wall hole



CAUTION

For walls containing a metal frame or a metal board, use a wall embedded pipe and wall cover in the feed-through hole to prevent possible heat, electrical shock, or fire.



NOTICE

Be sure to seal the gaps around the pipes with sealing material (field supply), in order to prevent water leakage.

- 1 Bore a 65 mm large feed-through hole in the wall with a downward slope towards the outside.
- 2 Insert a wall embedded pipe into the hole.

5 Unit installation

- 3 Insert a wall cover into the wall pipe.

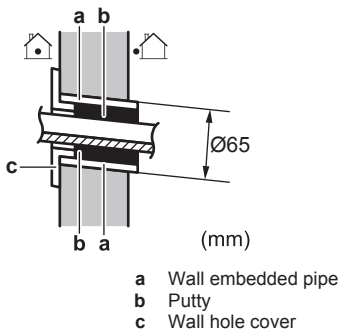

- 4 After completing wiring, refrigerant piping and drain piping, do NOT forget to seal the gap with putty.

5.2.3 To remove the pipe port cover

i INFORMATION

To connect the piping on right-side, right-bottom, left-side or left-bottom, the pipe port cover MUST be removed.

- 1 Cut off the pipe port cover from inside the front grille using a coping saw.

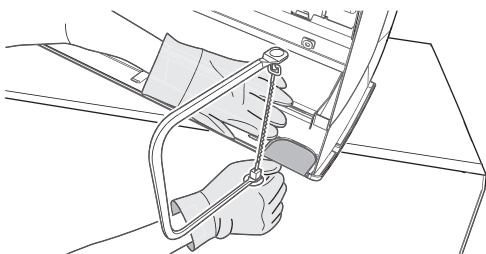

- 2 Remove any burrs along the cut section using a half round needle file.

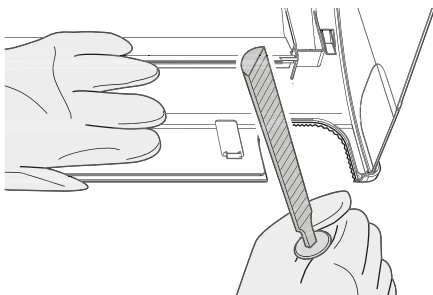

! NOTICE

Do NOT use nippers to remove the pipe port cover, as this would damage the front grille.

5.3 Connecting the drain piping

5.3.1 To connect the piping on right side, right-back, or right-bottom

i INFORMATION

The factory default is right-side piping. For left-side piping, remove the piping from the right side and install it on the left side.

- 1 Attach the drain hose with adhesive vinyl tape to the bottom of the refrigerant pipes.
- 2 Wrap the drain hose and the refrigerant pipes together using insulation tape.

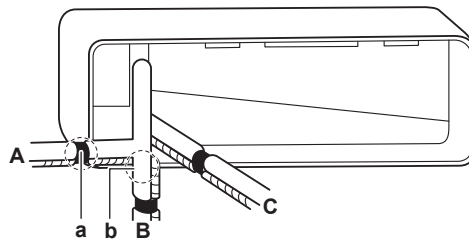

- A Right-side piping
- B Right-bottom piping
- C Right-back piping
- a Remove the pipe port cover here for right side piping
- b Remove the pipe port cover here for right-bottom piping

5.3.2 To connect the piping on left side, left-back, or left-bottom

i INFORMATION

The factory default is right-side piping. For left-side piping, remove the piping from the right side and install it on the left side.

- 1 Remove the insulation fixing screw on the right side and remove the drain hose.
- 2 Remove the drain plug on the left side and attach it to the right side.

! NOTICE

Do NOT apply lubricating oil (refrigerant oil) to the drain plug when inserting it. The drain plug may deteriorate and cause drain leakage from the plug.

- 3 Insert the drain hose on the left side and do not forget to tighten it with the fixing screw; otherwise water leakage may occur.

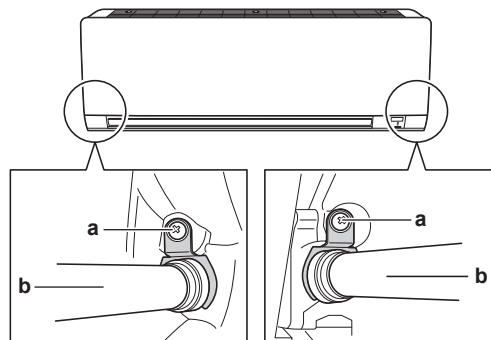

- a Insulation fixing screw
- b Drain hose

- 4 Attach the drain hose to the refrigerant piping bottom side using adhesive vinyl tape.

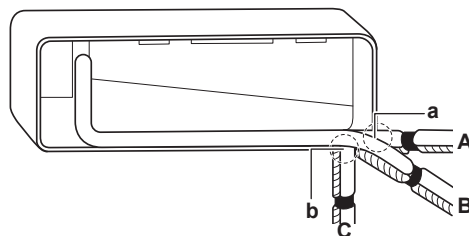

- A Left-side piping
- B Left-back piping
- C Left-bottom piping
- a Remove the pipe port cover here for left-side piping
- b Remove the pipe port cover here for left-bottom piping

5.3.3 To check for water leaks

- 1 Remove the air filters.

- Gradually pour approximately 1 l of water in the drain pan, and check for water leaks.

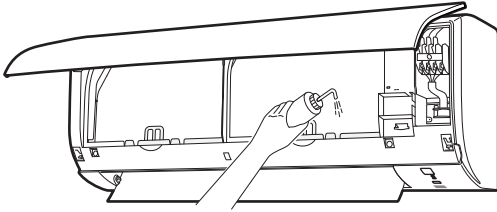

6 Piping installation

6.1 Preparing refrigerant piping

6.1.1 Refrigerant piping requirements



CAUTION

Piping and joints of a split system shall be made with permanent joints when inside an occupied space except joints directly connecting the piping to the indoor units.



NOTICE

The piping and other pressure-containing parts shall be suitable for refrigerant. Use phosphoric acid deoxidised seamless copper for refrigerant.

- Foreign materials inside pipes (including oils for fabrication) must be ≤ 30 mg/10 m.

Refrigerant piping diameter

Use the same diameters as the connections on the outdoor units:

Pipe outer diameter (mm)	
Liquid piping	Gas piping
Ø6.4	Ø12.7

Refrigerant piping material

- Piping material:** Phosphoric acid deoxidised seamless copper.
- Flare connections:** Only use annealed material.
- Piping temper grade and thickness:**

Outer diameter (Ø)	Temper grade	Thickness (t) ^(a)	
6.4 mm (1/4")	Annealed (O)	≥0.8 mm	
12.7 mm (1/2")			

^(a) Depending on the applicable legislation and the maximum working pressure of the unit (see "PS High" on the unit name plate), larger piping thickness might be required.

6.1.2 Refrigerant piping insulation

- Use polyethylene foam as insulation material:
 - with a heat transfer rate between 0.041 and 0.052 W/mK (0.035 and 0.045 kcal/mh°C)
 - with a heat resistance of at least 120°C
- Insulation thickness

Pipe outer diameter (Ø _p)	Insulation inner diameter (Ø _i)	Insulation thickness (t)
6.4 mm (1/4")	8~10 mm	≥10 mm
12.7 mm (1/2")	14~16 mm	≥13 mm

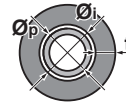

If the temperature is higher than 30°C and the humidity is higher than RH 80%, the thickness of the insulation materials should be at least 20 mm to prevent condensation on the surface of the insulation.

6.2 Connecting the refrigerant piping



DANGER: RISK OF BURNING/SCALDING

6.2.1 To connect the refrigerant piping to the indoor unit



WARNING: MILDLY FLAMMABLE MATERIAL

The refrigerant inside this unit is mildly flammable.

- Pipe length.** Keep refrigerant piping as short as possible.
 - Connect refrigerant piping to the unit using **flare connections**.
 - Insulate** the refrigerant piping, interconnection cable and drain hose on the indoor unit as follows:

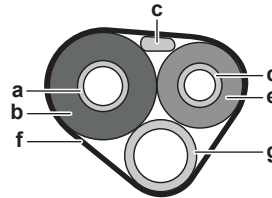

- a Gas pipe
- b Gas pipe insulation
- c Interconnection cable
- d Liquid pipe
- e Liquid pipe insulation
- f Finishing tape
- g Drain hose



NOTICE

Make sure to insulate all refrigerant piping. Any exposed piping might cause condensation.

7 Electrical installation



DANGER: RISK OF ELECTROCUTION



WARNING

ALWAYS use multicore cable for power supply cables.



WARNING

Use an all-pole disconnection type breaker with at least 3 mm between the contact point gaps that provide full disconnection under overvoltage category III.



WARNING

If the supply cord is damaged, it MUST be replaced by the manufacturer, its service agent or similarly qualified persons in order to avoid a hazard.



WARNING

Do NOT connect the power supply to the indoor unit. This could result in electrical shock or fire.

7 Electrical installation

WARNING

- Do NOT use locally purchased electrical parts inside the product.
- Do NOT branch the power supply for the drain pump, etc. from the terminal block. This could result in electrical shock or fire.

WARNING

Keep the interconnection wiring away from copper pipes without thermal insulation as such pipes will be very hot.

7.1 Specifications of standard wiring components

Component	
Interconnection cable (indoor↔outdoor)	4-core cable 1.5 mm ² ~2.5 mm ² and applicable for 220~240 V H05RN-F (60245 IEC 57)

7.2 To connect the electrical wiring to the indoor unit

Electrical work should be carried out in accordance with the installation manual and the national electrical wiring rules or code of practice.

- Set the indoor unit on the mounting plate hooks. Use the "△" marks as a guide.

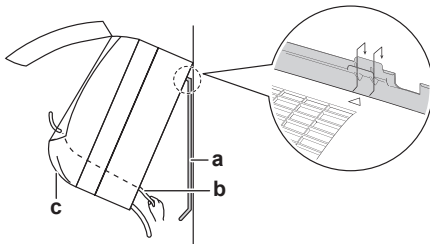

- a Mounting plate (accessory)
- b Interconnection cable
- c Wire guide

- Open the front panel, and then the service cover. Refer to the Installer reference guide for opening procedure.
- Pass the interconnection cable from the outdoor unit through the feed-through wall hole, through the back of the indoor unit and through the front side.

Note: In case the interconnection cable was stripped in advance, cover the ends with insulating tape.

- Bend the end of the cable up.

NOTICE

- Be sure to keep the power line and transmission line apart from each other. Transmission wiring and power supply wiring may cross, but may NOT run parallel.
- In order to avoid any electrical interference the distance between both wirings should ALWAYS be at least 50 mm.

WARNING

Provide adequate measures to prevent that the unit can be used as a shelter by small animals. Small animals that make contact with electrical parts can cause malfunctions, smoke or fire.

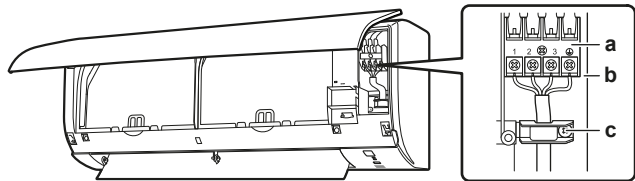

- a Terminal block
- b Electrical component block
- c Cable clamp

- Strip the wire ends approximately 15 mm.
- Match wire colours with terminal numbers on the indoor unit terminal blocks and firmly screw the wires to the corresponding terminals.
- Connect the earth wire to the corresponding terminal.
- Firmly fix the wires with the terminal screws.
- Pull the wires to make sure that they are securely attached, then retain the wires with the wire retainer.
- Shape the wires so that the service cover fits securely, then close the service cover.

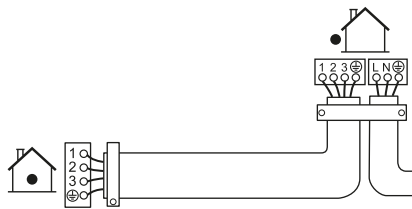

7.3 To connect optional accessories (wired user interface, central user interface, wireless adapter, etc.)

- Remove the electrical wiring box cover.
- Attach the connection cable to the S21 connector and pull the wire harness as shown in the following figure.

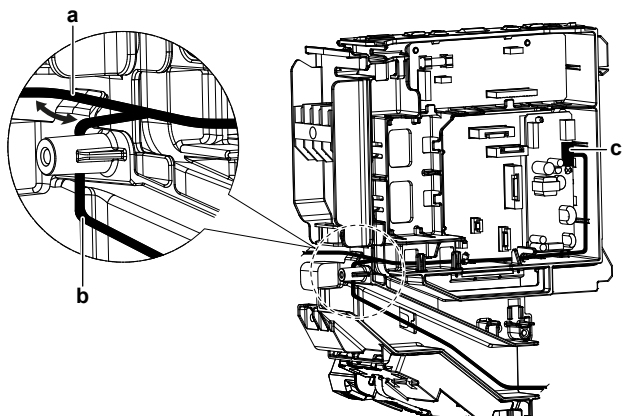

- a S21 wire harness routing for wireless adapter
- b S21 wire harness routing for other applications
- c S21 connector

- Put the electrical wiring box cover back and pull the wire harness around it as shown in the previous figure.

8 Finishing the indoor unit installation

8.1 To insulate the drain piping, refrigerant piping and interconnection cable

- 1 After the drain piping, refrigerant piping and the electrical wiring are finished. Wrap refrigerant pipes, interconnection cable and drain hose together using insulation tape. Overlap at least half the width of the tape with each turn.

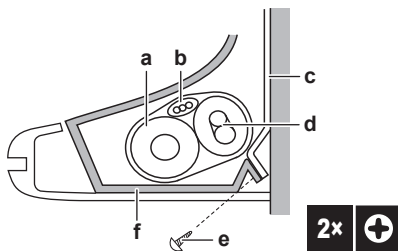

- a Drain hose
- b Interconnection cable
- c Mounting plate (accessory)
- d Refrigerant piping
- e Indoor unit fixing screw M4×12L (accessory)
- f Bottom frame

8.2 To pass the pipes through the wall hole

- 1 Shape the refrigerant pipes along the pipe path marking on the mounting plate.

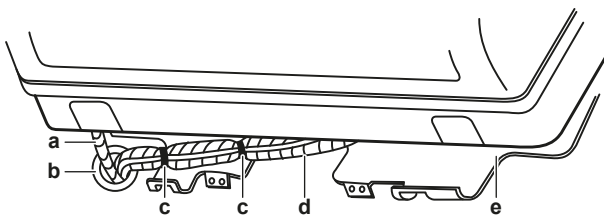

- a Drain hose
- b Caulk this hole with putty or caulking material
- c Adhesive vinyl tape
- d Insulation tape
- e Mounting plate (accessory)

NOTICE

- Do NOT bend refrigerant pipes.
- Do NOT push the refrigerant pipes onto the bottom frame or the front grille.

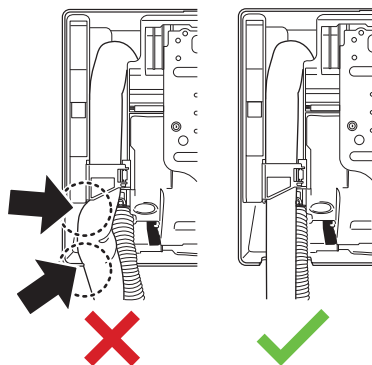

- 2 Pass the drain hose and refrigerant pipes through the wall hole.

8.3 To fix the unit on the mounting plate

- 1 Set the indoor unit on the mounting plate hooks. Use the "△" marks as a guide.

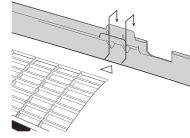

- 2 Press the bottom frame of the unit with both hands to set it on the bottom hooks of the mounting plate. Make sure that the wires do NOT get squeezed anywhere.

Note: Take care that the interconnection cable does NOT get caught in the indoor unit.

- 3 Press the bottom edge of the indoor unit with both hands until it is firmly caught by the mounting plate hooks.
- 4 Secure the indoor unit to the mounting plate using 2 indoor unit fixing screws M4×12L (accessory).

9 Commissioning



NOTICE

General commissioning checklist. Next to the commissioning instructions in this chapter, a general commissioning checklist is also available on the Daikin Business Portal (authentication required).

The general commissioning checklist is complementary to the instructions in this chapter and can be used as a guideline and reporting template during the commissioning and hand-over to the user.



NOTICE

ALWAYS operate the unit with thermistors and/or pressure sensors/switches. If NOT, burning of the compressor might be the result.

9.1 Checklist before commissioning

After the installation of the unit, first check the items listed below. Once all checks are fulfilled, the unit MUST be closed. Power-up the unit after it is closed.

<input type="checkbox"/>	You read the complete installation instructions, as described in the installer reference guide .
<input type="checkbox"/>	The indoor units are properly mounted.
<input type="checkbox"/>	The outdoor unit is properly mounted.
<input type="checkbox"/>	Air inlet/outlet Check that the air inlet and outlet of the unit is NOT obstructed by paper sheets, cardboard, or any other material.
<input type="checkbox"/>	There are NO missing phases or reversed phases .
<input type="checkbox"/>	The refrigerant pipes (gas and liquid) are thermally insulated.
<input type="checkbox"/>	Drainage Make sure drainage flows smoothly. Possible consequence: Condensate water might drip.
<input type="checkbox"/>	The system is properly earthed and the earth terminals are tightened.

10 Disposal

<input type="checkbox"/>	The fuses or locally installed protection devices are installed according to this document, and have NOT been bypassed.
<input type="checkbox"/>	The power supply voltage matches the voltage on the identification label of the unit.
<input type="checkbox"/>	The specified wires are used for the interconnection cable .
<input type="checkbox"/>	The indoor unit receives the signals of the user interface .
<input type="checkbox"/>	There are NO loose connections or damaged electrical components in the switch box.
<input type="checkbox"/>	The insulation resistance of the compressor is OK.
<input type="checkbox"/>	There are NO damaged components or squeezed pipes on the inside of the indoor and outdoor units.
<input type="checkbox"/>	There are NO refrigerant leaks .
<input type="checkbox"/>	The correct pipe size is installed and the pipes are properly insulated.
<input type="checkbox"/>	The stop valves (gas and liquid) on the outdoor unit are fully open.

9.2 To perform a test run

Prerequisite: Power supply MUST be in the specified range.

Prerequisite: Test run may be performed in cooling or heating mode.







Prerequisite: Test run should be performed in accordance with the operation manual of the indoor unit to make sure that all functions and parts are working properly.

- 1 In cooling mode, select the lowest programmable temperature. In heating mode, select the highest programmable temperature. Test run can be disabled if necessary.
- 2 When the test run is finished, set the temperature to a normal level. In cooling mode: 26~28°C, in heating mode: 20~24°C.
- 3 The system stops operating 3 minutes after the unit is turned OFF.

9.2.1 To perform a test run in winter season

When operating the air conditioner in **Cooling** mode in winter, set it to test run operation using the following method.





For FTXP and ATXP units

- 1 Press , , and  simultaneously.
- 2 Press .
- 3 Select **7**.
- 4 Press .
- 5 Press  to switch the system on.

Result: Test run operation will stop automatically after about 30 minutes.

- 6 To stop operation, press .

For FTXF and ATXF units

- 1 Press  to switch the system on.
- 2 Press the centre of , , and  simultaneously.
- 3 Press  twice.

Result: **7** will appear on the display. Test run operation is selected. Test run operation will stop automatically after about 30 minutes.

- 4 To stop operation, press .



INFORMATION

Some of the functions CANNOT be used in the test run operation mode.

If a power failure occurs during operation, the system automatically restarts immediately after power is restored.

10 Disposal



NOTICE

Do NOT try to dismantle the system yourself: dismantling of the system, treatment of the refrigerant, oil and other parts MUST comply with applicable legislation. Units MUST be treated at a specialised treatment facility for reuse, recycling and recovery.

11 Technical data

















- A **subset** of the latest technical data is available on the regional Daikin website (publicly accessible).
- The **full set** of latest technical data is available on the Daikin Business Portal (authentication required).

11.1 Wiring diagram

The wiring diagram is delivered with the unit, located inside of the outdoor unit (bottom side of the top plate).

11.1.1 Unified wiring diagram legend

For applied parts and numbering, refer to the wiring diagram on the unit. Part numbering is by Arabic numbers in ascending order for each part and is represented in the overview below by "" in the part code.

Symbol	Meaning	Symbol	Meaning
	Circuit breaker		Protective earth
			Protective earth (screw)
	Connector		Rectifier
	Earth		Relay connector
	Field wiring		Short-circuit connector
	Fuse		Terminal
	Indoor unit		Terminal strip
	Outdoor unit		Wire clamp
	Residual current device		

Symbol	Colour	Symbol	Colour
BLK	Black	ORG	Orange
BLU	Blue	PNK	Pink
BRN	Brown	PRP, PPL	Purple
GRN	Green	RED	Red
GRY	Grey	WHT	White
		YLW	Yellow

Symbol	Meaning
A*P	Printed circuit board
BS*	Pushbutton ON/OFF, operation switch
BZ, H*O	Buzzer
C*	Capacitor
AC*, CN*, E*, HA*, HE*, HL*, HN*, HR*, MR*_A, MR*_B, S*, U, V, W, X*A, K*R_*, NE	Connection, connector
D*, V*D	Diode
DB*	Diode bridge
DS*	DIP switch
E*H	Heater
FU*, F*U, (for characteristics, refer to PCB inside your unit)	Fuse
FG*	Connector (frame ground)
H*	Harness
H*P, LED*, V*L	Pilot lamp, light emitting diode
HAP	Light emitting diode (service monitor green)
HIGH VOLTAGE	High voltage
IES	Intelligent eye sensor
IPM*	Intelligent power module
K*R, KCR, KFR, KHuR, K*M	Magnetic relay
L	Live
L*	Coil
L*R	Reactor
M*	Stepper motor
M*C	Compressor motor
M*F	Fan motor
M*P	Drain pump motor
M*S	Swing motor
MR*, MRCW*, MRM*, MRN*	Magnetic relay
N	Neutral
n=*, N=*	Number of passes through ferrite core
PAM	Pulse-amplitude modulation
PCB*	Printed circuit board
PM*	Power module
PS	Switching power supply
PTC*	PTC thermistor
Q*	Insulated gate bipolar transistor (IGBT)
Q*C	Circuit breaker
Q*DI, KLM	Earth leak circuit breaker
Q*L	Overload protector
Q*M	Thermo switch
Q*R	Residual current device
R*	Resistor
R*T	Thermistor
RC	Receiver
S*C	Limit switch
S*L	Float switch
S*NG	Refrigerant leak detector
S*NPH	Pressure sensor (high)
S*NPL	Pressure sensor (low)
S*PH, HPS*	Pressure switch (high)

Symbol	Meaning
S*PL	Pressure switch (low)
S*T	Thermostat
S*RH	Humidity sensor
S*W, SW*	Operation switch
SA*, F1S	Surge arrester
SR*, WLU	Signal receiver
SS*	Selector switch
SHEET METAL	Terminal strip fixed plate
T*R	Transformer
TC, TRC	Transmitter
V*, R*V	Varistor
V*R	Diode bridge, Insulated-gate bipolar transistor (IGBT) power module
WRC	Wireless remote controller
X*	Terminal
X*M	Terminal strip (block)
Y*E	Electronic expansion valve coil
Y*R, Y*S	Reversing solenoid valve coil
Z*C	Ferrite core
ZF, Z*F	Noise filter

ERC



DAIKIN INDUSTRIES CZECH REPUBLIC s.r.o.

U Nové Hospody 1/1155, 301 00 Plzeň Skvrňany, Czech Republic

DAIKIN EUROPE N.V.

Zandvoordestraat 300, B-8400 Oostende, Belgium

Copyright 2021 Daikin

3P512025-10U 2021.07