

DAIKIN

Installer reference guide

R32 Split series

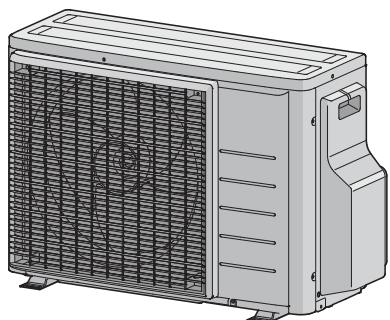

**2MXM40M4V1B
2MXM50M3V1B9
2AMXM40M4V1B
2AMXM50M4V1B
2AMXF40A2V1B
2AMXF50A2V1B
2MXF40A2V1B
2MXF50A2V1B**

Installer reference guide
R32 Split series

English

Table of contents

1	General safety precautions	3	6.6	Charging refrigerant	17
1.1	About the documentation	3	6.6.1	About charging refrigerant	17
1.1.1	Meaning of warnings and symbols	3	6.6.2	Precautions when charging refrigerant	17
1.2	For the installer	3	6.6.3	About the refrigerant	17
1.2.1	General	3	6.6.4	To determine the additional refrigerant amount	18
1.2.2	Installation site	3	6.6.5	To determine the complete recharge amount	18
1.2.3	Refrigerant	5	6.6.6	To charge additional refrigerant	18
1.2.4	Brine	6	6.6.7	To fix the fluorinated greenhouse gases label	18
1.2.5	Water	6	6.7	Connecting the electrical wiring	18
1.2.6	Electrical	6	6.7.1	About connecting the electrical wiring	18
2	About the documentation	7	6.7.2	Precautions when connecting the electrical wiring	19
2.1	About this document	7	6.7.3	Guidelines when connecting the electrical wiring	19
2.2	Installer reference guide at a glance	7	6.7.4	Specifications of standard wiring components	20
3	About the box	7	6.7.5	To connect the electrical wiring on the outdoor unit	20
3.1	Overview: About the box	7	6.8	Finishing the outdoor unit installation	20
3.2	Outdoor unit	7	6.8.1	To finish the outdoor unit installation	20
3.2.1	To unpack the outdoor unit	7	6.8.2	About ECONO mode prohibition setting	21
3.2.2	To remove the accessories from the outdoor unit	8	6.8.3	About night quiet mode	21
4	About the units and options	8	6.8.4	About heat mode lock	21
4.1	Overview: About the units and options	8	6.8.5	About standby electricity saving function	21
4.2	Identification	8	6.8.6	To close the outdoor unit	22
4.2.1	Identification label: Outdoor unit	8	7	Commissioning	22
5	Preparation	8	7.1	Overview: Commissioning	22
5.1	Overview: Preparation	8	7.2	Precautions when commissioning	22
5.2	Preparing the installation site	8	7.3	Checklist before commissioning	22
5.2.1	Installation site requirements of the outdoor unit	9	7.4	Checklist during commissioning	22
5.2.2	Additional installation site requirements of the outdoor unit in cold climates	10	7.5	Trial operation and testing	22
5.2.3	Refrigerant piping length and height difference	10	7.5.1	To perform a test run	23
5.3	Preparing refrigerant piping	10	7.6	Starting up the outdoor unit	23
5.3.1	Refrigerant piping requirements	10	7.7	Fault diagnosis using LED on outdoor unit PCB	23
5.3.2	Refrigerant piping insulation	11	8	Hand-over to the user	23
5.4	Preparing electrical wiring	11	9	Maintenance and service	23
5.4.1	About preparing electrical wiring	11	9.1	Overview: Maintenance and service	23
6	Installation	11	9.2	Maintenance safety precautions	23
6.1	Overview: Installation	11	9.3	Checklist for yearly maintenance of the outdoor unit	23
6.2	Opening the unit	11	9.4	About the compressor	23
6.2.1	About opening the unit	11	10	Troubleshooting	24
6.2.2	To open the outdoor unit	11	10.1	Overview: Troubleshooting	24
6.3	Mounting the outdoor unit	12	10.2	Precautions when troubleshooting	24
6.3.1	About mounting the outdoor unit	12	10.3	Solving problems based on symptoms	24
6.3.2	Precautions when mounting the outdoor unit	12	10.3.1	Symptom: Indoor units fall, vibrate or make noise	24
6.3.3	To provide the installation structure	12	10.3.2	Symptom: The unit is NOT heating or cooling as expected	24
6.3.4	To install the outdoor unit	12	10.3.3	Symptom: Water leakage	24
6.3.5	To provide drainage	12	10.3.4	Symptom: Electrical leakage	24
6.3.6	To prevent the outdoor unit from falling over	13	10.3.5	Symptom: Unit does NOT function or burn damage	24
6.4	Connecting the refrigerant piping	13	11	Disposal	24
6.4.1	About connecting the refrigerant piping	13	11.1	Overview: Disposal	24
6.4.2	Precautions when connecting the refrigerant piping	13	11.2	To pump down	25
6.4.3	Guidelines when connecting the refrigerant piping	14	11.3	To start and stop forced cooling	25
6.4.4	Pipe bending guidelines	14	11.3.1	To start and stop forced cooling using the indoor unit ON/OFF switch	25
6.4.5	To flare the pipe end	14	11.3.2	To start and stop forced cooling using the indoor unit user interface	25
6.4.6	Connections between outdoor and indoor unit using reducers	14	12	Technical data	25
6.4.7	Using the stop valve and service port	15	12.1	Wiring diagram	25
6.4.8	To connect the refrigerant piping to the outdoor unit	16	12.1.1	Unified wiring diagram legend	25
6.5	Checking the refrigerant piping	16	12.2	Piping diagram: Outdoor unit	26
6.5.1	About checking the refrigerant piping	16	13	Glossary	27
6.5.2	Precautions when checking the refrigerant piping	16			
6.5.3	To check for leaks	16			
6.5.4	To perform vacuum drying	16			

1 General safety precautions

1.1 About the documentation

- The original documentation is written in English. All other languages are translations.
- The precautions described in this document cover very important topics, follow them carefully.
- The installation of the system, and all activities described in the installation manual and in the installer reference guide **MUST** be performed by an authorised installer.

1.1.1 Meaning of warnings and symbols

 **DANGER**
Indicates a situation that results in death or serious injury.

 **DANGER: RISK OF ELECTROCUTION**
Indicates a situation that could result in electrocution.

 **DANGER: RISK OF BURNING**
Indicates a situation that could result in burning because of extreme hot or cold temperatures.

 **DANGER: RISK OF EXPLOSION**
Indicates a situation that could result in explosion.



 **WARNING**
Indicates a situation that could result in death or serious injury.

 **WARNING: FLAMMABLE MATERIAL**

 **CAUTION**
Indicates a situation that could result in minor or moderate injury.

 **NOTICE**
Indicates a situation that could result in equipment or property damage.

 **INFORMATION**
Indicates useful tips or additional information.

Symbol	Explanation
	Before installation, read the installation and operation manual, and the wiring instruction sheet.
	Before performing maintenance and service tasks, read the service manual.
	For more information, see the installer and user reference guide.

1.2 For the installer

1.2.1 General

If you are NOT sure how to install or operate the unit, contact your dealer.

 **NOTICE**
Improper installation or attachment of equipment or accessories could result in electric shock, short-circuit, leaks, fire or other damage to the equipment. Only use accessories, optional equipment and spare parts made or approved by Daikin.

 **WARNING**
Make sure installation, testing and applied materials comply with applicable legislation (on top of the instructions described in the Daikin documentation).

 **CAUTION**
Wear adequate personal protective equipment (protective gloves, safety glasses,...) when installing, maintaining or servicing the system.

 **WARNING**
Tear apart and throw away plastic packaging bags so that nobody, especially children, can play with them. Possible risk: suffocation.

 **DANGER: RISK OF BURNING**

- Do NOT touch the refrigerant piping, water piping or internal parts during and immediately after operation. It could be too hot or too cold. Give it time to return to normal temperature. If you must touch it, wear protective gloves.
- Do NOT touch any accidental leaking refrigerant.

 **WARNING**
Provide adequate measures to prevent that the unit can be used as a shelter by small animals. Small animals that make contact with electrical parts can cause malfunctions, smoke or fire.

 **CAUTION**
Do NOT touch the air inlet or aluminium fins of the unit.

 **NOTICE**

- Do NOT place any objects or equipment on top of the unit.
- Do NOT sit, climb or stand on the unit.

 **NOTICE**
Works executed on the outdoor unit are best done under dry weather conditions to avoid water ingress.

In accordance with the applicable legislation, it might be necessary to provide a logbook with the product containing at least: information on maintenance, repair work, results of tests, stand-by periods,...

Also, at least, following information **MUST** be provided at an accessible place at the product:

- Instructions for shutting down the system in case of an emergency
- Name and address of fire department, police and hospital
- Name, address and day and night telephone numbers for obtaining service

In Europe, EN378 provides the necessary guidance for this logbook.

1.2.2 Installation site

- Provide sufficient space around the unit for servicing and air circulation.
- Make sure the installation site withstands the weight and vibration of the unit.

1 General safety precautions

- Make sure the area is well ventilated. Do NOT block any ventilation openings.
- Make sure the unit is level.

Do NOT install the unit in the following places:

- In potentially explosive atmospheres.
- In places where there is machinery that emits electromagnetic waves. Electromagnetic waves may disturb the control system, and cause malfunction of the equipment.
- In places where there is a risk of fire due to the leakage of flammable gases (example: thinner or gasoline), carbon fibre, ignitable dust.
- In places where corrosive gas (example: sulphurous acid gas) is produced. Corrosion of copper pipes or soldered parts may cause the refrigerant to leak.

Instructions for equipment using R32 refrigerant

If applicable.



WARNING

- Do NOT pierce or burn.
- Do NOT use means to accelerate the defrosting process or to clean the equipment, other than those recommended by the manufacturer.
- Be aware that R32 refrigerant does NOT contain an odour.



WARNING

The appliance shall be stored so as to prevent mechanical damage and in a well-ventilated room without continuously operating ignition sources (example: open flames, an operating gas appliance or an operating electric heater) and have a room size as specified below.



NOTICE

- Do NOT re-use joints which have been used already.
- Joints made in installation between parts of refrigerant system shall be accessible for maintenance purposes.



WARNING

Make sure installation, servicing, maintenance and repair comply with instructions from Daikin and with applicable legislation (for example national gas regulation) and are executed only by authorised persons.

Installation space requirements



NOTICE

- Pipework shall be protected from physical damage.
- Installation of pipework shall be kept to a minimum.



WARNING

If appliances contain R32 refrigerant, the floor area of the room in which the appliances are installed, operated and stored MUST be larger than the minimum floor area defined in table below A (m²). This applies to:

- Indoor units **without** a refrigerant leakage sensor; in case of indoor units **with** refrigerant leakage sensor, consult the installation manual
- Outdoor units installed or stored indoors (e.g. winter garden, garage, machinery room)
- Pipework in unventilated spaces

To determine the minimum floor area

- 1 Determine the total refrigerant charge in the system (= factory refrigerant charge ① + ② additional refrigerant amount charged).

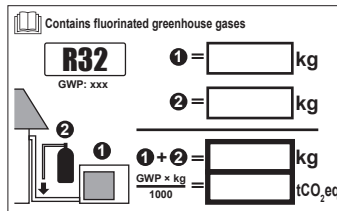

- 2 Determine which graph or table to use.

- For indoor units: Is the unit ceiling-mounted, wall-mounted or floor-standing?
- For outdoor units installed or stored indoors, and field piping in unventilated spaces, this depends on the installation height:

If the installation height is...	Then use the graph or table for...
<1.8 m	Floor-standing units
1.8 ≤ x < 2.2 m	Wall-mounted units
≥ 2.2 m	Ceiling-mounted units

- 3 Use the graph or table to determine the minimum floor area.

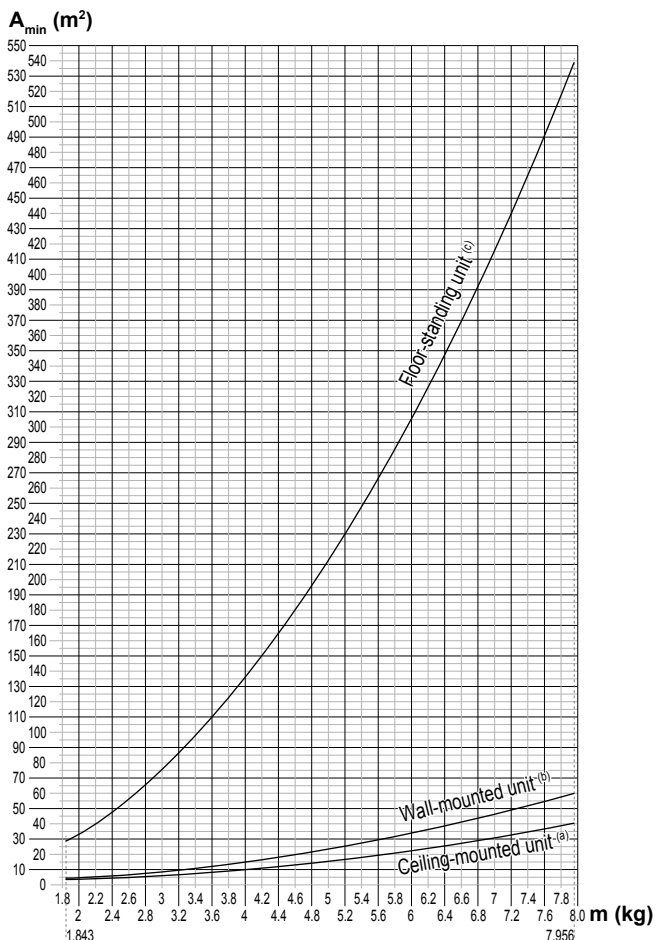

Ceiling-mounted unit ^(a)	Wall-mounted unit ^(b)	Floor-standing unit ^(c)
m (kg) — A _{min} (m ²)	m (kg) — A _{min} (m ²)	m (kg) — A _{min} (m ²)
≤1.842 — —	≤1.842 — —	≤1.842 — —
1.843 — 3.64	1.843 — 4.45	1.843 — 28.9
2.0 — 3.95	2.0 — 4.83	2.0 — 34.0
2.2 — 4.34	2.2 — 5.31	2.2 — 41.2
2.4 — 4.74	2.4 — 5.79	2.4 — 49.0
2.6 — 5.13	2.6 — 6.39	2.6 — 57.5
2.8 — 5.53	2.8 — 7.41	2.8 — 66.7
3.0 — 5.92	3.0 — 8.51	3.0 — 76.6
3.2 — 6.48	3.2 — 9.68	3.2 — 87.2
3.4 — 7.32	3.4 — 10.9	3.4 — 98.4
3.6 — 8.20	3.6 — 12.3	3.6 — 110
3.8 — 9.14	3.8 — 13.7	3.8 — 123
4.0 — 10.1	4.0 — 15.1	4.0 — 136
4.2 — 11.2	4.2 — 16.7	4.2 — 150
4.4 — 12.3	4.4 — 18.3	4.4 — 165
4.6 — 13.4	4.6 — 20.0	4.6 — 180
4.8 — 14.6	4.8 — 21.8	4.8 — 196
5.0 — 15.8	5.0 — 23.6	5.0 — 213
5.2 — 17.1	5.2 — 25.6	5.2 — 230
5.4 — 18.5	5.4 — 27.6	5.4 — 248
5.6 — 19.9	5.6 — 29.7	5.6 — 267
5.8 — 21.3	5.8 — 31.8	5.8 — 286
6.0 — 22.8	6.0 — 34.0	6.0 — 306
6.2 — 24.3	6.2 — 36.4	6.2 — 327
6.4 — 25.9	6.4 — 38.7	6.4 — 349
6.6 — 27.6	6.6 — 41.2	6.6 — 371
6.8 — 29.3	6.8 — 43.7	6.8 — 394
7.0 — 31.0	7.0 — 46.3	7.0 — 417
7.2 — 32.8	7.2 — 49.0	7.2 — 441
7.4 — 34.7	7.4 — 51.8	7.4 — 466
7.6 — 36.6	7.6 — 54.6	7.6 — 492
7.8 — 38.5	7.8 — 57.5	7.8 — 518
7.956 — 40.1	7.956 — 59.9	7.956 — 539

- m** Total refrigerant charge in the system
A_{min} Minimum floor area
(a) Ceiling-mounted unit (= Ceiling-mounted unit)
(b) Wall-mounted unit (= Wall-mounted unit)
(c) Floor-standing unit (= Floor-standing unit)

1.2.3 Refrigerant

If applicable. See the installation manual or installer reference guide of your application for more information.



NOTICE

Make sure refrigerant piping installation complies with applicable legislation. In Europe, EN378 is the applicable standard.



NOTICE

Make sure the field piping and connections are NOT subjected to stress.



WARNING

During tests, NEVER pressurize the product with a pressure higher than the maximum allowable pressure (as indicated on the nameplate of the unit).



WARNING

Take sufficient precautions in case of refrigerant leakage. If refrigerant gas leaks, ventilate the area immediately. Possible risks:

- Excessive refrigerant concentrations in a closed room can lead to oxygen deficiency.
- Toxic gas may be produced if refrigerant gas comes into contact with fire.



DANGER: RISK OF EXPLOSION

Pump down – Refrigerant leakage. If you want to pump down the system, and there is a leak in the refrigerant circuit:

- Do NOT use the unit's automatic pump down function, with which you can collect all refrigerant from the system into the outdoor unit. **Possible consequence:** Self-combustion and explosion of the compressor because of air going into the operating compressor.
- Use a separate recovery system so that the unit's compressor does NOT have to operate.



WARNING

ALWAYS recover the refrigerant. Do NOT release them directly into the environment. Use a vacuum pump to evacuate the installation.



NOTICE

After all the piping has been connected, make sure there is no gas leak. Use nitrogen to perform a gas leak detection.



NOTICE



- To avoid compressor breakdown, do NOT charge more than the specified amount of refrigerant.
- When the refrigerant system is to be opened, refrigerant MUST be treated according to the applicable legislation.



WARNING

Make sure there is no oxygen in the system. Refrigerant may only be charged after performing the leak test and the vacuum drying.

- In case recharge is required, see the nameplate of the unit. It states the type of refrigerant and necessary amount.
- The unit is factory charged with refrigerant and depending on pipe sizes and pipe lengths some systems require additional charging of refrigerant.
- Only use tools exclusively for the refrigerant type used in the system, this to ensure pressure resistance and prevent foreign materials from entering into the system.
- Charge the liquid refrigerant as follows:

If	Then
A siphon tube is present (i.e., the cylinder is marked with "Liquid filling siphon attached")	Charge with the cylinder upright. 
A siphon tube is NOT present	Charge with the cylinder upside down. 

- Open refrigerant cylinders slowly.
- Charge the refrigerant in liquid form. Adding it in gas form may prevent normal operation.

1 General safety precautions

CAUTION

When the refrigerant charging procedure is done or when pausing, close the valve of the refrigerant tank immediately. If the valve is NOT closed immediately, remaining pressure might charge additional refrigerant.
Possible consequence: Incorrect refrigerant amount.

1.2.4 Brine

If applicable. See the installation manual or installer reference guide of your application for more information.

WARNING

The selection of the brine MUST be in accordance with the applicable legislation.

WARNING

Take sufficient precautions in case of brine leakage. If brine leaks, ventilate the area immediately and contact your local dealer.

WARNING

The ambient temperature inside the unit can get much higher than that of the room, e.g. 70°C. In case of a brine leak, hot parts inside the unit can create a hazardous situation.

WARNING

The use and installation of the application MUST comply with the safety and environmental precautions specified in the applicable legislation.

1.2.5 Water

If applicable. See the installation manual or installer reference guide of your application for more information.

NOTICE

Make sure water quality complies with EU directive 98/83 EC.

1.2.6 Electrical

DANGER: RISK OF ELECTROCUTION

- Turn OFF all power supply before removing the switch box cover, connecting electrical wiring or touching electrical parts.
- Disconnect the power supply for more than 1 minute, and measure the voltage at the terminals of main circuit capacitors or electrical components before servicing. The voltage MUST be less than 50 V DC before you can touch electrical components. For the location of the terminals, see the wiring diagram.
- Do NOT touch electrical components with wet hands.
- Do NOT leave the unit unattended when the service cover is removed.

WARNING

If NOT factory installed, a main switch or other means for disconnection, having a contact separation in all poles providing full disconnection under overvoltage category III condition, MUST be installed in the fixed wiring.

WARNING

- ONLY use copper wires.
- Make sure the field wiring complies with the applicable legislation.
- All field wiring MUST be performed in accordance with the wiring diagram supplied with the product.
- NEVER squeeze bundled cables and make sure they do NOT come in contact with the piping and sharp edges. Make sure no external pressure is applied to the terminal connections.
- Make sure to install earth wiring. Do NOT earth the unit to a utility pipe, surge absorber, or telephone earth. Incomplete earth may cause electrical shock.
- Make sure to use a dedicated power circuit. NEVER use a power supply shared by another appliance.
- Make sure to install the required fuses or circuit breakers.
- Make sure to install an earth leakage protector. Failure to do so may cause electric shock or fire.
- When installing the earth leakage protector, make sure it is compatible with the inverter (resistant to high frequency electric noise) to avoid unnecessary opening of the earth leakage protector.

CAUTION

When connecting the power supply, the earth connection must be made before the current-carrying connections are established. When disconnecting the power supply, the current-carrying connections must be separated before the earth connection is. The length of the conductors between the power supply stress relief and the terminal block itself must be as such that the current-carrying wires are tightened before the earth wire is in case the power supply is pulled loose from the stress relief.

NOTICE

Precautions when laying power wiring:



- Do NOT connect wiring of different thicknesses to the power terminal block (slack in the power wiring may cause abnormal heat).
- When connecting wiring which is the same thickness, do as shown in the figure above.
- For wiring, use the designated power wire and connect firmly, then secure to prevent outside pressure being exerted on the terminal board.
- Use an appropriate screwdriver for tightening the terminal screws. A screwdriver with a small head will damage the head and make proper tightening impossible.
- Over-tightening the terminal screws may break them.

Install power cables at least 1 metre away from televisions or radios to prevent interference. Depending on the radio waves, a distance of 1 metre may not be sufficient.



WARNING

- After finishing the electrical work, confirm that each electrical component and terminal inside the electrical components box is connected securely.
- Make sure all covers are closed before starting up the unit.



NOTICE

Only applicable if the power supply is three-phase, and the compressor has an ON/OFF starting method.

If there exists the possibility of reversed phase after a momentary black out and the power goes on and off while the product is operating, attach a reversed phase protection circuit locally. Running the product in reversed phase can break the compressor and other parts.

2 About the documentation

2.1 About this document

Target audience

Authorised installers



INFORMATION

This appliance is intended to be used by expert or trained users in shops, in light industry, and on farms, or for commercial and household use by lay persons.



WARNING

Make sure installation, servicing, maintenance, repair and applied materials follow the instructions from Daikin and, in addition, comply with applicable legislation and are performed by qualified persons only. In Europe and areas where IEC standards apply, EN/IEC 60335-2-40 is the applicable standard.

Documentation set

This document is part of a documentation set. The complete set consists of:

- **General safety precautions:**
 - Safety instructions that you MUST read before installing
 - Format: Paper (in the box of the outdoor unit)
- **Outdoor unit installation manual:**
 - Installation instructions
 - Format: Paper (in the box of the outdoor unit)
- **Installer reference guide:**
 - Preparation of the installation, reference data,...
 - Format: Digital files on <http://www.daikineurope.com/support-and-manuals/product-information/>

Latest revisions of the supplied documentation may be available on the regional Daikin website or via your dealer.

The original documentation is written in English. All other languages are translations.

Technical engineering data

- A **subset** of the latest technical data is available on the regional Daikin website (publicly accessible).
- The **full set** of latest technical data is available on the Daikin Business Portal (authentication required).

2.2 Installer reference guide at a glance

Chapter	Description
General safety precautions	Safety instructions that you MUST read before installing
About the documentation	What documentation exists for the installer
About the box	How to unpack the units and remove their accessories
About the unit	How to identify the unit
Preparation	What to do and know before going on-site
Installation	What to do and know to install the system
Commissioning	What to do and know to commission the system after it is configured
Hand-over to the user	What to give and explain to the user
Maintenance and service	How to maintain and service the units
Troubleshooting	What to do in case of problems
Disposal	How to dispose of the system
Technical data	Specifications of the system
Glossary	Definition of terms

3 About the box

3.1 Overview: About the box

This chapter describes what you have to do after the boxes with the outdoor and indoor unit are delivered on-site.

Keep the following in mind:

- At delivery, the unit MUST be checked for damage. Any damage MUST be reported immediately to the claims agent of the carrier.
- Bring the packed unit as close as possible to its final installation position to prevent damage during transport.
- Prepare the path along which you want to bring the unit inside in advance.

3.2 Outdoor unit

3.2.1 To unpack the outdoor unit

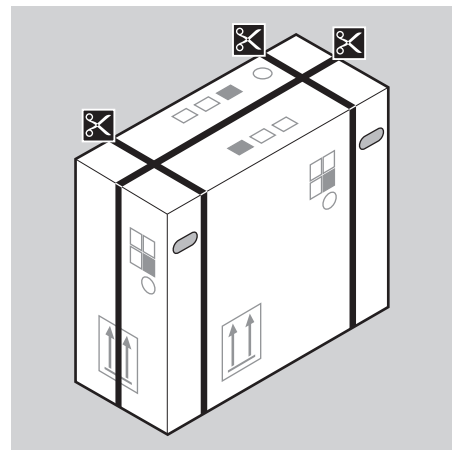

4 About the units and options

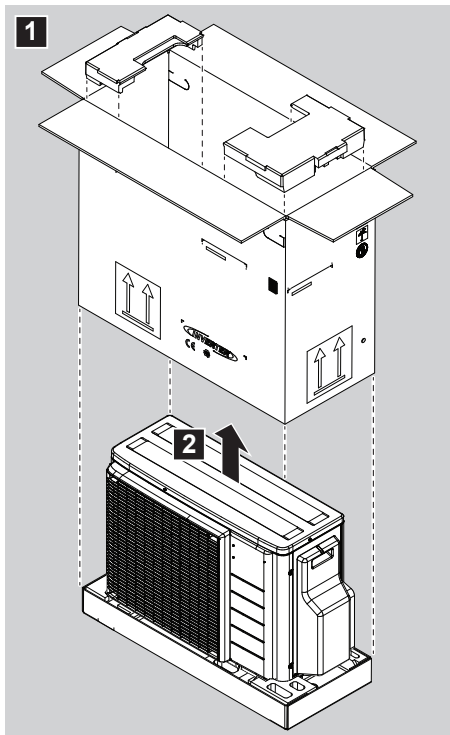

3.2.2 To remove the accessories from the outdoor unit

- 1 Lift the outdoor unit.

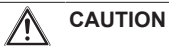

Only handle the outdoor unit as follows:

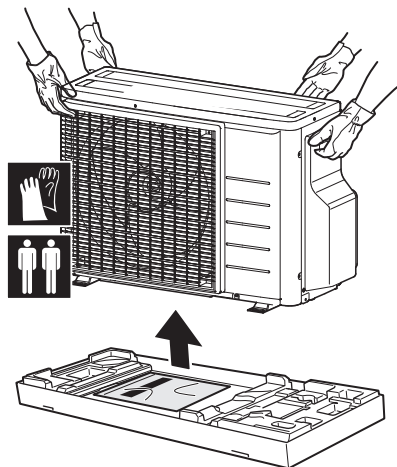

- 2 Remove the accessories at the bottom of the package.

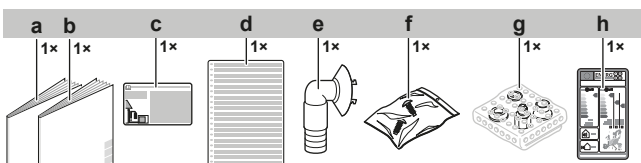

- a Outdoor unit installation manual
- b General safety precautions
- c Fluorinated greenhouse gases label
- d Multilingual fluorinated greenhouse gases label
- e Drain socket
- f Screw bag (for fixing wire retainer)
- g Reducer assembly
- h Energy label

4 About the units and options

4.1 Overview: About the units and options

This chapter contains information about:

- Identification of the outdoor unit

4.2 Identification



NOTICE

When installing or servicing several units at the same time, make sure NOT to switch the service panels between different models.

4.2.1 Identification label: Outdoor unit

Location

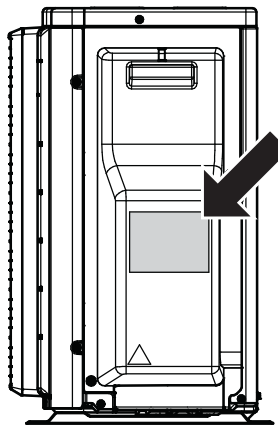

5 Preparation

5.1 Overview: Preparation

This chapter describes what you have to do and know before going on-site.

It contains information about:

- Preparing the installation site
- Preparing the refrigerant piping
- Preparing the electrical wiring

5.2 Preparing the installation site

Do NOT install the unit in places often used as work place. In case of construction works (e.g. grinding works) where a lot of dust is created, the unit MUST be covered.

Choose an installation location with sufficient space for carrying the unit in and out of the site.

- Choose a location where the hot/cold air discharged from the unit or the operation noise, will NOT disturb anyone.



WARNING

Do NOT install the air conditioner at any place where flammable gas may leak out. If the gas leaks out and stays around the air conditioner, a fire may break out.

- Install units, power cables and communication wiring at least 3 m away from televisions or radios to prevent interference. Depending on the radio waves, a distance of 3 m may not be sufficient.

- Objects placed under the unit may be damaged by water from the drain.



WARNING

If appliances contain R32 refrigerant, then the floor area of the room in which the appliances are installed, operated and stored must be larger than the minimum floor area. This applies to:

- Indoor units **without** refrigerant leakage sensor; in case of indoor units **with** refrigerant leakage sensor, consult the installation manual
- Outdoor units installed or stored indoors (example: winter garden, garage, machinery room)
- Field piping in unventilated spaces



WARNING

The appliance shall be stored in a room without continuously operating ignition sources (example: open flames, an operating gas appliance or an operating electric heater).

5.2.1 Installation site requirements of the outdoor unit



INFORMATION

Also read the following requirements:

- General installation site requirements. See the "General safety precautions" chapter.
- Refrigerant piping requirements (length, height difference). See further in this "Preparation" chapter.

Mind the following spacing guidelines:

- Wall facing 1 side:

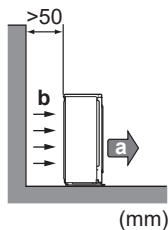
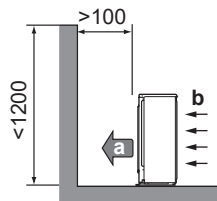

- Wall facing 2 sides:

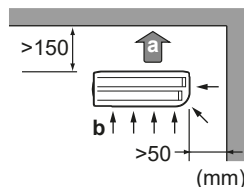
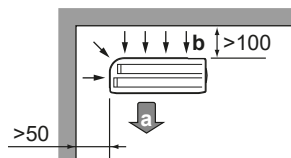

- Wall facing 3 sides:

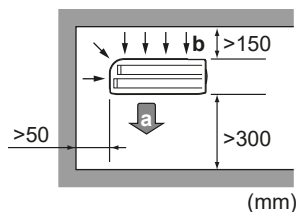

a Air outlet
b Air inlet

Allow 300 mm of work space below the ceiling surface and 250 mm for piping and electrical servicing.

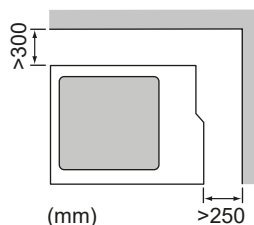

NOTICE

- Do NOT stack the units on each other.
- Do NOT hang the unit on a ceiling.

Strong winds (≥ 18 km/h) blowing against the outdoor unit's air outlet causes short circuit (suction of discharge air). This may result in:

- deterioration of the operational capacity;
- frequent frost acceleration in heating operation;
- disruption of operation due to decrease of low pressure or increase of high pressure;
- a broken fan (if a strong wind blows continuously on the fan, it may start rotating very fast, until it breaks).

It is recommended to install a baffle plate when the air outlet is exposed to wind.

It is recommended to install the outdoor unit with the air inlet facing the wall and NOT directly exposed to the wind.

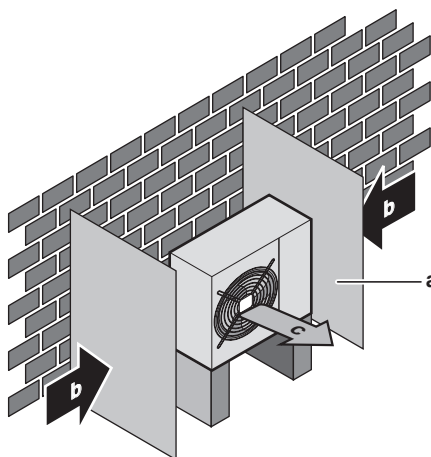

a Baffle plate
b Prevailing wind direction
c Air outlet

Do NOT install the unit in the following places:

- Sound sensitive areas (e.g. near a bedroom), so that the operation noise will cause no trouble.
Note: If the sound is measured under actual installation conditions, the measured value might be higher than the sound pressure level mentioned in Sound spectrum in the data book due to environmental noise and sound reflections.



INFORMATION

The sound pressure level is less than 70 dBA.

- In places where a mineral oil mist, spray or vapour may be present in the atmosphere. Plastic parts may deteriorate and fall off or cause water leakage.

It is NOT recommended to install the unit in the following places because it may shorten the life of the unit:

- Where the voltage fluctuates a lot
- In vehicles or vessels
- Where acidic or alkaline vapour is present

5 Preparation

Seaside installation. Make sure the outdoor unit is NOT directly exposed to sea winds. This is to prevent corrosion caused by high levels of salt in the air, which might shorten the life of the unit.

Install the outdoor unit away from direct sea winds.

Example: Behind the building.

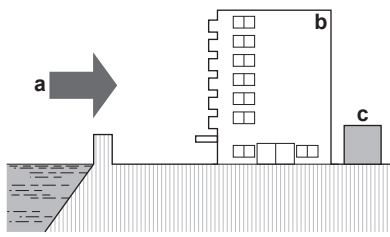

If the outdoor unit is exposed to direct sea winds, install a windbreaker.

- Height of windbreaker $\geq 1.5 \times$ height of outdoor unit
- Mind the service space requirements when installing the windbreaker.

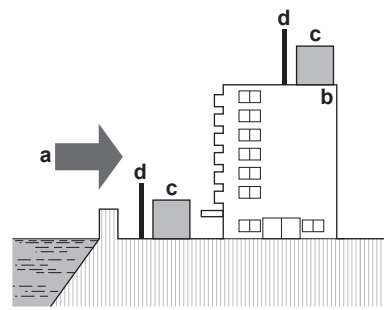

- a Sea wind
- b Building
- c Outdoor unit
- d Windbreaker

The outdoor unit is designed for outdoor installation only, and for ambient temperatures within the following ranges:

Cooling mode	Heating mode
-10~46°C DB	-15~24°C DB

5.2.2 Additional installation site requirements of the outdoor unit in cold climates

Protect the outdoor unit against direct snowfall and take care that the outdoor unit is NEVER snowed up.

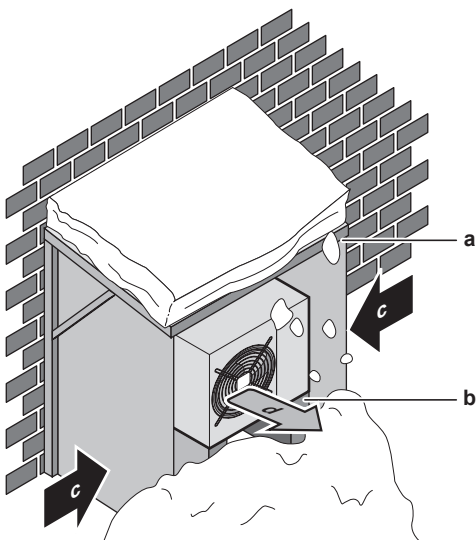

- a Snow cover or shed
- b Pedestal

- c Prevailing wind direction
- d Air outlet

It is recommended to provide at least 150 mm of free space below the unit (300 mm for heavy snowfall areas). Additionally, make sure the unit is positioned at least 100 mm above the maximum expected level of snow. If necessary, construct a pedestal. See "6.3 Mounting the outdoor unit" [p 12] for more details.

In heavy snowfall areas it is very important to select an installation site where the snow will NOT affect the unit. If lateral snowfall is possible, make sure that the heat exchanger coil is NOT affected by the snow. If necessary, install a snow cover or shed and a pedestal.

5.2.3 Refrigerant piping length and height difference

The shorter the refrigerant piping, the better the performance of the system.

The piping length and height differences must comply with the following requirements.

Model	Minimum required space
Class 40	1.2 m ²
Class 50	1.8 m ²

Shortest allowable length per room is 3 m.

Refrigerant piping length to each indoor unit	≤20 m
Refrigerant piping total length	≤30 m

	Height difference outdoor-indoor	Height difference indoor-indoor
Outdoor unit installed higher than indoor unit	≤15 m	≤7.5 m
Outdoor unit installed lower than at least 1 indoor unit	≤7.5 m	≤15 m

5.3 Preparing refrigerant piping

5.3.1 Refrigerant piping requirements

i INFORMATION

Also read the precautions and requirements in the "General safety precautions" chapter.

- **Piping material:** Phosphoric acid deoxidised seamless copper.
- **Piping diameter:**

Class 40	
Liquid piping	2× Ø6.4 mm (1/4")
Gas piping	2× Ø9.5 mm (3/8")

Class 50	
Liquid piping	2× Ø6.4 mm (1/4")
Gas piping	1× Ø9.5 mm (3/8") 1× Ø12.7 mm (1/2")

- **Piping temper grade and thickness:**

Outer diameter (Ø)	Temper grade	Thickness (t) ^(a)	
6.4 mm (1/4")	Annealed (O)	≥0.8 mm	
9.5 mm (3/8")			
12.7 mm (1/2")			

^(a) Depending on the applicable legislation and the unit's maximum working pressure (see "PS High" on the unit name plate), larger piping thickness might be required.

Usage of reducers might be required based on the indoor unit. See "6.4.6 Connections between outdoor and indoor unit using reducers" [▶ 14] for more information.

5.3.2 Refrigerant piping insulation

- Use polyethylene foam as insulation material:
 - with a heat transfer rate between 0.041 and 0.052 W/mK (0.035 and 0.045 kcal/mh°C)
 - with a heat resistance of at least 120°C
- Insulation thickness

Pipe outer diameter (Ø _p)	Insulation inner diameter (Ø _i)	Insulation thickness (t)
6.4 mm (1/4")	8~10 mm	≥10 mm
9.5 mm (3/8")	12~15 mm	≥13 mm
12.7 mm (1/2")	14~16 mm	≥13 mm

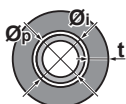

If the temperature is higher than 30°C and the humidity is higher than RH 80%, the thickness of the insulation materials should be at least 20 mm to prevent condensation on the surface of the insulation.

5.4 Preparing electrical wiring

5.4.1 About preparing electrical wiring



INFORMATION

Also read the precautions and requirements in the "General safety precautions" chapter.



WARNING

- If the power supply has a missing or wrong N-phase, equipment might break down.
- Establish proper earthing. Do NOT earth the unit to a utility pipe, surge absorber, or telephone earth. Incomplete earthing may cause electrical shock.
- Install the required fuses or circuit breakers.
- Secure the electrical wiring with cable ties so that the cables do NOT come in contact with sharp edges or piping, particularly on the high-pressure side.
- Do NOT use taped wires, stranded conductor wires, extension cords, or connections from a star system. They can cause overheating, electrical shock or fire.
- Do NOT install a phase advancing capacitor, because this unit is equipped with an inverter. A phase advancing capacitor will reduce performance and may cause accidents.



WARNING

- All wiring MUST be performed by an authorised electrician and MUST comply with the applicable legislation.
- Make electrical connections to the fixed wiring.
- All components procured on-site and all electrical construction MUST comply with the applicable legislation.



WARNING

The backup heater MUST have a dedicated power supply and MUST be protected by the safety devices required by the applicable legislation.



WARNING

ALWAYS use multicore cable for power supply cables.

6 Installation



WARNING

Installation shall be done by an installer, the choice of materials and installation shall comply with the applicable legislation. In Europe, EN378 is the applicable standard.

6.1 Overview: Installation

This chapter describes what you have to do and know on-site to install the system.

Typical workflow

Installation typically consists of the following stages:

- Mounting the outdoor unit.
- Connecting the refrigerant piping.
- Checking the refrigerant piping.
- Charging refrigerant.
- Connecting the electrical wiring.
- Finishing the outdoor installation.



INFORMATION

For installation of the indoor unit (mounting the indoor unit, connecting the refrigerant piping to the indoor unit, connecting the electrical wiring to the indoor unit ...), see the installation manual of the indoor unit.



INFORMATION

Depending on the units and/or the installation conditions, it might be necessary to connect electrical wiring before you can charge refrigerant.



INFORMATION

It is NOT possible to connect an indoor unit of 1 room only. Be sure to connect indoor units of at least 2 rooms.

6.2 Opening the unit

6.2.1 About opening the unit

At certain times, you have to open the unit. **Example:**

- When connecting the refrigerant piping
- When connecting the electrical wiring
- When maintaining or servicing the unit



DANGER: RISK OF ELECTROCUTION

Do NOT leave the unit unattended when the service cover is removed.

6.2.2 To open the outdoor unit



DANGER: RISK OF ELECTROCUTION



DANGER: RISK OF BURNING

6 Installation

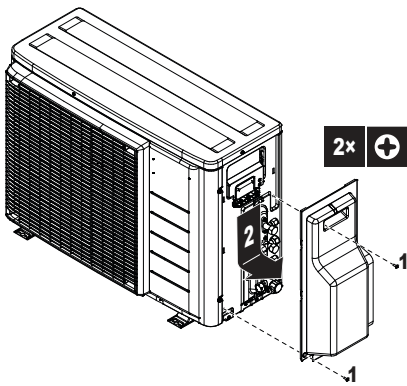

6.3 Mounting the outdoor unit

6.3.1 About mounting the outdoor unit

When

The outdoor and indoor unit must be mounted before the refrigerant piping can be connected.

Typical workflow

Mounting the outdoor unit typically consists of the following stages:

- 1 Providing the installation structure.
- 2 Installing the outdoor unit.
- 3 Providing drainage.

6.3.2 Precautions when mounting the outdoor unit



INFORMATION

Also read the precautions and requirements in the following chapters:

- General safety precautions
- Preparation

6.3.3 To provide the installation structure

Check the strength and level of the installation ground so that the unit will not cause any operating vibration or noise.

Use a vibration-proof rubber (field supply) in cases where vibrations may be transmitted to the building.

The unit may be installed directly on a concrete veranda or another solid surface as long as it provides proper drainage.

Fix the unit securely by means of foundation bolts in accordance with the foundation drawing.

Prepare 4 sets of M8 or M10 anchor bolts, nuts and washers (field supply).

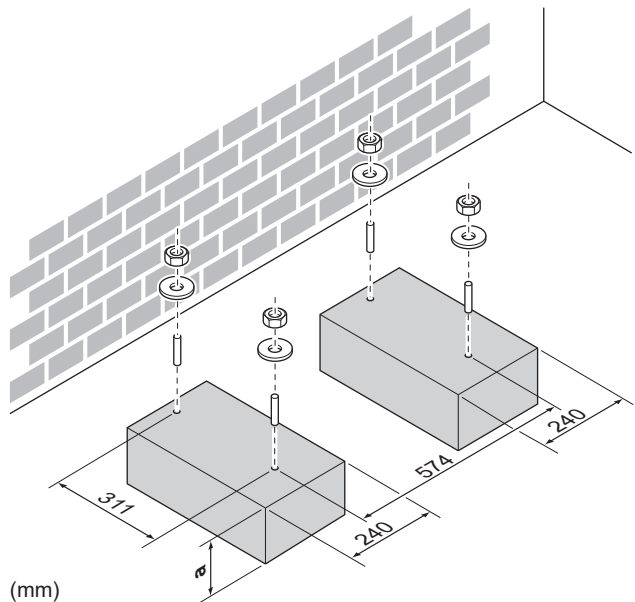
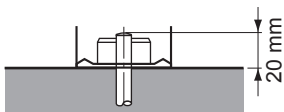

a 100 mm above expected level of snow

6.3.4 To install the outdoor unit

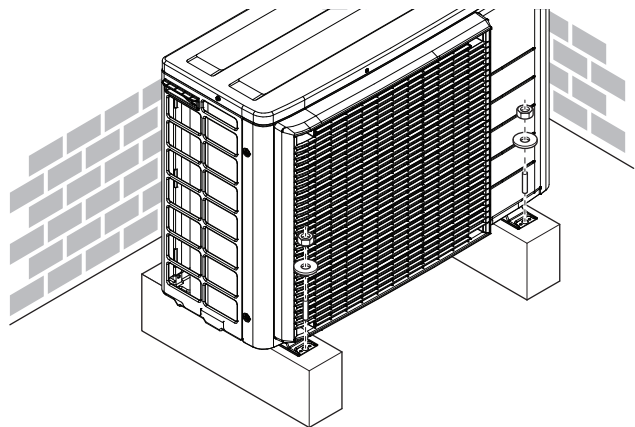

6.3.5 To provide drainage

- Make sure that condensation water can be evacuated properly.
- Install the unit on a base to make sure that there is proper drainage in order to avoid ice accumulation.
- Prepare a water drainage channel around the foundation to drain waste water away from the unit.
- Avoid drain water flowing over the footpath, so that it does NOT become slippery in case of ambient freezing temperatures.
- If you install the unit on a frame, install a waterproof plate within 150 mm of the bottom side of the unit in order to prevent water from getting into the unit and to avoid drain water dripping (see the following figure).

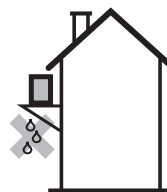

NOTICE

If the unit is installed in a cold climate, take adequate measures so that the evacuated condensate CANNOT freeze.

**NOTICE**

If the drain holes of the outdoor unit are blocked up by a mounting base or floor surface, place additional foot bases ≤30 mm under the outdoor unit's feet.

**INFORMATION**

For information on the available options, contact your dealer.

- 1 Use a drain plug for drainage.
- 2 Use a Ø16 mm hose (field supply).

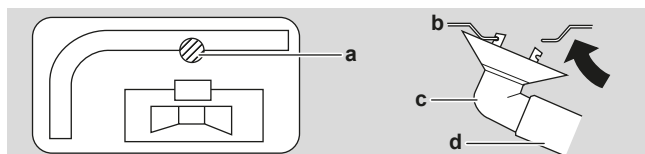

- a Drain port
- b Bottom frame
- c Drain plug
- d Hose (field supply)

6.3.6 To prevent the outdoor unit from falling over

In case the unit is installed in places where strong wind can tilt the unit, take following measure:

- 1 Prepare 2 cables as indicated in the following illustration (field supply).
- 2 Place the 2 cables over the outdoor unit.
- 3 Insert a rubber sheet between the cables and the outdoor unit to prevent the cables from scratching the paint (field supply).
- 4 Attach the ends of the cables and tighten them.

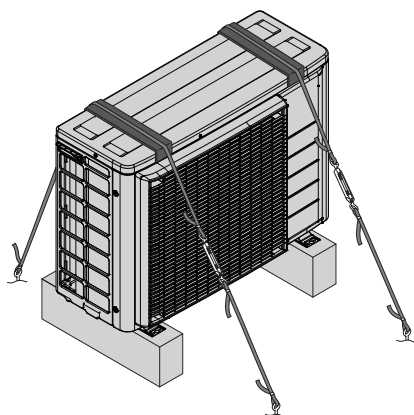

6.4 Connecting the refrigerant piping

**CAUTION**

- No brazing or welding on site for units with R32 refrigerant charge during shipment.
- During installation of the refrigeration system, joining of parts with at least one part charged shall be performed taking into account the following requirements:
 - ⇒ inside occupied spaces non permanent joints are not allowed for R32 refrigerant except for site made joints directly connecting the indoor unit to piping. Site made joints directly connecting piping to indoor units shall be of non permanent type.

**CAUTION**

Do NOT connect the embedded branch piping and the outdoor unit when only carrying out piping work without connecting the indoor unit in order to add another indoor unit later.

6.4.1 About connecting the refrigerant piping

Before connecting the refrigerant piping

Make sure the outdoor and indoor unit are mounted.

Typical workflow

Connecting the refrigerant piping involves:

- Connecting the refrigerant piping to the indoor unit
- Connecting the refrigerant piping to the outdoor unit
- Insulating the refrigerant piping
- Keeping in mind the guidelines for:
 - Pipe bending
 - Flaring pipe ends
 - Using the stop valves

6.4.2 Precautions when connecting the refrigerant piping

**INFORMATION**

Also read the precautions and requirements in the following chapters:

- General safety precautions
- Preparation

**DANGER: RISK OF BURNING****CAUTION**

- Do NOT use mineral oil on flared part.
- Do NOT reuse piping from previous installations.
- NEVER install a drier to this R32 unit to guarantee its lifetime. The drying material may dissolve and damage the system.

**CAUTION**

- Use the flare nut fixed to the main unit.
- To prevent gas leakage, apply refrigeration oil only to the inside of the flare. Use refrigeration oil for R32.
- Do NOT reuse joints.

**NOTICE**

Take the following precautions on refrigerant piping into account:

- Avoid anything but the designated refrigerant to get mixed into the refrigerant cycle (e.g. air).
- Only use R32 when adding refrigerant.
- Only use installation tools (e.g. manifold gauge set) that are exclusively used for R32 installations to withstand the pressure and to prevent foreign materials (e.g. mineral oils and moisture) from mixing into the system.
- Install the piping so that the flare is NOT subjected to mechanical stress.
- Protect the piping as described in the following table to prevent dirt, liquid or dust from entering the piping.
- Use caution when passing copper tubes through walls (see figure below).

6 Installation

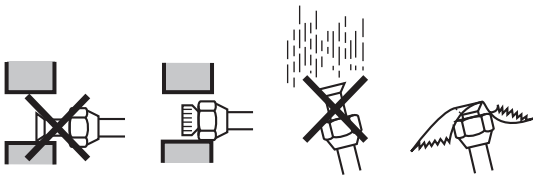

Unit	Installation period	Protection method
Outdoor unit	>1 month	Pinch the pipe
	<1 month	Pinch or tape the pipe
Indoor unit	Regardless of the period	

INFORMATION

Do NOT open the refrigerant stop valve before checking the refrigerant piping. When you need to charge additional refrigerant it is recommended to open the refrigerant stop valve after charging.

WARNING

Connect the refrigerant piping securely before running the compressor. If the refrigerant piping is NOT connected and the stop valve is open when the compressor is run, air will be sucked in. This will cause abnormal pressure in the refrigeration cycle, which may result in equipment damage and even injury.

NOTICE

Even if the stop valve is fully closed, the refrigerant may slowly leak out. Do NOT leave the flare nut removed for long period of time.

6.4.3 Guidelines when connecting the refrigerant piping

Take the following guidelines into account when connecting pipes:

- Coat the flare inner surface with ether oil or ester oil when connecting a flare nut. Tighten 3 or 4 turns by hand, before tightening firmly.



- ALWAYS use 2 wrenches together when loosening a flare nut.
- ALWAYS use a spanner and torque wrench together to tighten the flare nut when connecting the piping. This to prevent nut cracking and leaks.

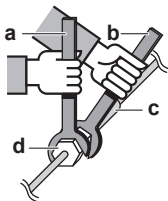

- a Torque wrench
- b Spanner
- c Piping union
- d Flare nut

Piping size (mm)	Tightening torque (N•m)	Flare dimensions (A) (mm)	Flare shape (mm)
∅6.4	15~17	8.7~9.1	
∅9.5	33~39	12.8~13.2	
∅12.7	50~60	16.2~16.6	

6.4.4 Pipe bending guidelines

Use a pipe bender for bending. All pipe bends should be as gentle as possible (bending radius should be 30~40 mm or larger).

6.4.5 To flare the pipe end

CAUTION

- Incomplete flaring may cause refrigerant gas leakage.
- Do NOT re-use flares. Use new flares to prevent refrigerant gas leakage.
- Use flare nuts that are included with the unit. Using different flare nuts may cause refrigerant gas leakage.

- Cut the pipe end with a pipe cutter.
- Remove burrs with the cut surface facing down so that the chips do NOT enter the pipe.

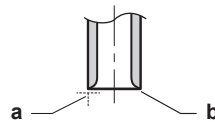

- a Cut exactly at right angles.
- b Remove burrs.

- Remove the flare nut from the stop valve and put the flare nut on the pipe.
- Flare the pipe. Set exactly at the position as shown in the following figure.



	Flare tool for R32 (clutch type)	Conventional flare tool	
		Clutch type (Ridgid-type)	Wing nut type (Imperial-type)
A	0~0.5 mm	1.0~1.5 mm	1.5~2.0 mm

- Check that the flaring is properly made.

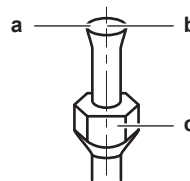

- a Flare's inner surface MUST be flawless.
- b The pipe end MUST be evenly flared in a perfect circle.
- c Make sure the flare nut is fitted.

6.4.6 Connections between outdoor and indoor unit using reducers

Total indoor unit capacity class that can be connected to this outdoor unit:

Outdoor unit	Total indoor unit capacity class
2MXM40, 2AMXM40, 2AMXF40, 2MXF40	≤6.0 kW
2MXM50, 2AMXM50, 2AMXF50, 2MXF50	≤8.5 kW

Port	Class	Reducer
2MXM40, 2AMXM40		
A	15, 20, 25, 35	—
B	15, 20, 25, 35	—
2AMXF40		

Port	Class	Reducer
A	25, 35	—
B	25, 35	—
2MXF40		
A	20, 25, 35	—
B	20, 25, 35	—
2MXM50, 2AMXM50		
A	15, 20, 25, 35, 42 ^(a)	—
B	15, 20, 25, 35	1+2
	42, 50	—
2AMXF50		
A	25, 35	—
B	25, 35	1+2
2MXF50		
A	20, 25, 35	—
B	20, 25, 35	1+2

^(a) Use optional accessory.

Reducer type	Connection
1	Ø12.7 mm → Ø9.5 mm
2	Ø12.7 mm → Ø9.5 mm

Connection example:

- Connecting a Ø9.5 mm pipe to a Ø12.7 mm gas pipe connection port

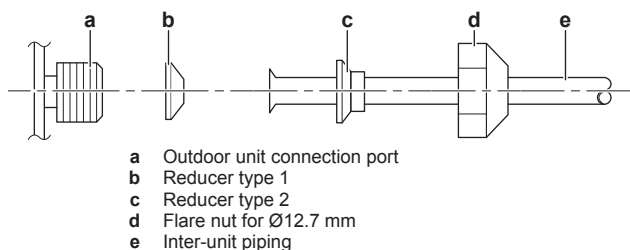

Coat the threaded connection port of the outdoor unit where the flare nut comes in with refrigeration oil.



NOTICE

Use an appropriate wrench to avoid damaging the connection thread by overtightening the flare nut. Be careful NOT to overtighten the nut, or the smaller pipe may be damaged (about 2/3-1× the normal torque).

6.4.7 Using the stop valve and service port

To handle the stop valve

Take the following guidelines into account:

- The stop valves are factory closed.
- The following figure shows the stop valve parts required when handling the valve.

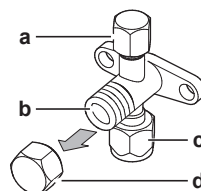

- a Service port and service port cap
- b Valve stem
- c Field piping connection
- d Stem cap

- Keep both stop valves open during operation.
- Do NOT apply excessive force to the valve stem. Doing so may break the valve body.
- ALWAYS make sure to secure the stop valve with a spanner, then loosen or tighten the flare nut with a torque wrench. Do NOT place the spanner on the stem cap, as this could cause a refrigerant leak.

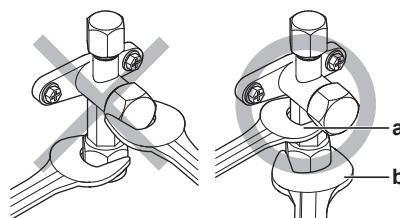

- a Spanner
- b Torque wrench

- When it is expected that the operating pressure will be low (e.g. when cooling will be performed while the outside air temperature is low), sufficiently seal the flare nut in the stop valve on the gas line with silicon sealant to prevent freezing.

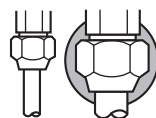

Silicon sealant; make sure there is no gap.

To open/close the stop valve

- Remove the stop valve cover.
- Insert a hexagon wrench (liquid side: 4 mm, gas side: 6 mm) into the valve stem and turn the valve stem:

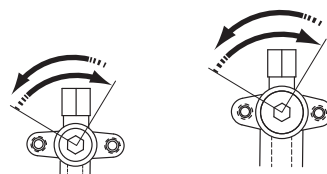

Counterclockwise to open.
Clockwise to close.

- When the stop valve CANNOT be turned any further, stop turning.
- Install the stop valve cover.

Result: The valve is now open/closed.

To handle the stem cap

- The stem cap is sealed where indicated with the arrow. Do NOT damage it.

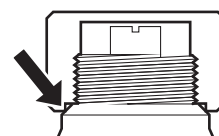

- After handling the stop valve, tighten the stem cap, and check for refrigerant leaks.

6 Installation

Stem cap	Piping Ø (mm)	Tightening torque (N·m)
Liquid side	6.4	22~28
Gas side	9.5	33~39
	12.7	49~59

To handle the service cap

- ALWAYS use a charge hose equipped with a valve depressor pin, since the service port is a Schrader type valve.
- After handling the service port, tighten the service port cap, and check for refrigerant leaks.

Item	Tightening torque (N·m)
Service port cap	11~14

6.4.8 To connect the refrigerant piping to the outdoor unit

- **Piping length.** Keep field piping as short as possible.
- **Piping protection.** Protect the field piping against physical damage.

- 1 Connect the liquid refrigerant connection from the indoor unit to the liquid stop valve of the outdoor unit.

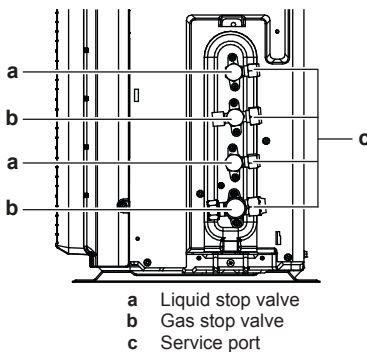

- 2 Connect the gas refrigerant connection from the indoor unit to the gas stop valve of the outdoor unit.

NOTICE

It is recommended that the refrigerant piping between indoor and outdoor unit is installed in a ducting or the refrigerant piping is wrapped with finishing tape.

6.5 Checking the refrigerant piping

6.5.1 About checking the refrigerant piping

The outdoor unit's **internal** refrigerant piping has been factory tested for leaks. You only have to check the outdoor unit's **external** refrigerant piping.

Before checking the refrigerant piping

Make sure the refrigerant piping is connected between the outdoor unit and the indoor unit.

Typical workflow

Checking the refrigerant piping typically consists of the following stages:

- 1 Checking for leaks in the refrigerant piping.
- 2 Performing vacuum drying to remove all moisture, air or nitrogen from the refrigerant piping.

If there is a possibility of moisture being present in the refrigerant piping (for example, water may have entered the piping), first carry out the vacuum drying procedure below until all moisture has been removed.

6.5.2 Precautions when checking the refrigerant piping

INFORMATION

Also read the precautions and requirements in the following chapters:

- General safety precautions
- Preparation

NOTICE

Use a 2-stage vacuum pump with a non-return valve that can evacuate to a gauge pressure of -100.7 kPa (-1.007 bar)(5 Torr absolute). Make sure the pump oil does not flow oppositely into the system while the pump is not working.

NOTICE

Use this vacuum pump for R32 exclusively. Using the same pump for other refrigerants may damage the pump and the unit.

NOTICE

- Connect the vacuum pump to the service port of the gas stop valve.
- Make sure that the gas stop valve and liquid stop valve are firmly closed before performing the leak test or vacuum drying.

6.5.3 To check for leaks

NOTICE

Do NOT exceed the unit's maximum working pressure (see "PS High" on the unit name plate).

NOTICE

Make sure to use a recommended bubble test solution from your wholesaler. Do not use soap water, which may cause cracking of flare nuts (soap water may contain salt, which absorbs moisture that will freeze when the piping gets cold), and/or lead to corrosion of flared joints (soap water may contain ammonia which causes a corrosive effect between the brass flare nut and the copper flare).

- 1 Charge the system with nitrogen gas up to a gauge pressure of at least 200 kPa (2 bar). It is recommended to pressurize to 3000 kPa (30 bar) in order to detect small leaks.
- 2 Check for leaks by applying the bubble test solution to all connections.
- 3 Discharge all nitrogen gas.

6.5.4 To perform vacuum drying

Connect the vacuum pump and manifold as follows:

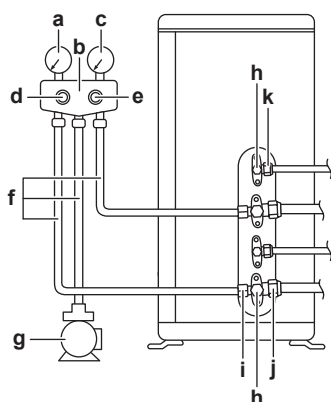

- a Low pressure gauge
- b Gauge manifold
- c High pressure gauge
- d Low-pressure valve (Lo)
- e High-pressure valve (Hi)
- f Charging hoses
- g Vacuum pump
- h Valve caps
- i Service port
- j Gas stop valve
- k Liquid stop valve

**NOTICE**

Connect the vacuum pump to **both** the service ports of the gas stop valves.

- Vacuum the system until the pressure on the manifold indicates -0.1 MPa (-1 bar).
- Leave as is for 4-5 minutes and check the pressure:

If the pressure...	Then...
Does not change	There is no moisture in the system. This procedure is finished.
Increases	There is moisture in the system. Go to the next step.

- Vacuum the system for at least 2 hours to a manifold pressure of -0.1 MPa (-1 bar).
- After turning the pump OFF, check the pressure for at least 1 hour.
- If you do NOT reach the target vacuum or CANNOT maintain the vacuum for 1 hour, do the following:
 - Check for leaks again.
 - Perform vacuum drying again.

**NOTICE**

Be sure to open the gas stop valve after piping installation and vacuuming. Running the system with the valve closed, the compressor may break down.

**INFORMATION**

After opening the stop valve, it is possible that the pressure in the refrigerant piping does NOT increase. This might be caused by e.g. the closed state of the expansion valve in the outdoor unit circuit, but does NOT present any problem for correct operation of the unit.

6.6 Charging refrigerant

6.6.1 About charging refrigerant

The outdoor unit is factory charged with refrigerant, but in some cases the following might be necessary:

What	When
Charging additional refrigerant	When the total liquid piping length is more than specified (see later).
Completely recharging refrigerant	Example: <ul style="list-style-type: none"> When relocating the system. After a leak.

Charging additional refrigerant

Before charging additional refrigerant, make sure the outdoor unit's **external** refrigerant piping is checked (leak test, vacuum drying).

**INFORMATION**

Depending on the units and/or the installation conditions, it might be necessary to connect electrical wiring before you can charge refrigerant.

Typical workflow – Charging additional refrigerant typically consists of the following stages:

- Determining if and how much you have to charge additionally.
- If necessary, charging additional refrigerant.
- Filling in the fluorinated greenhouse gases label, and fixing it to the inside of the outdoor unit.

Completely recharging refrigerant

Before completely recharging refrigerant, make sure the following is done:

- All refrigerant is recovered from the system.
- The outdoor unit's **external** refrigerant piping is checked (leak test, vacuum drying).
- Vacuum drying on the outdoor unit's **internal** refrigerant piping is performed.

**NOTICE**

Before completely recharging, perform vacuum drying on the outdoor unit's **internal** refrigerant piping as well.

Typical workflow – Completely recharging refrigerant typically consists of the following stages:

- Determining how much refrigerant to charge.
- Charging refrigerant.
- Filling in the fluorinated greenhouse gases label, and fixing it to the inside of the outdoor unit.

6.6.2 Precautions when charging refrigerant

**INFORMATION**

Also read the precautions and requirements in the following chapters:

- General safety precautions
- Preparation

6.6.3 About the refrigerant

This product contains fluorinated greenhouse gases. Do NOT vent gases into the atmosphere.

Refrigerant type: R32

Global warming potential (GWP) value: 675

6 Installation



NOTICE

Applicable legislation on **fluorinated greenhouse gases** requires that the refrigerant charge of the unit is indicated both in weight and CO₂ equivalent.

Formula to calculate the quantity in CO₂ equivalent tonnes: GWP value of the refrigerant × total refrigerant charge [in kg] / 1000

Please contact your installer for more information.



WARNING: FLAMMABLE MATERIAL

The refrigerant inside this unit is mildly flammable.



WARNING

The appliance shall be stored in a room without continuously operating ignition sources (example: open flames, an operating gas appliance or an operating electric heater).



WARNING

- Do NOT pierce or burn refrigerant cycle parts.
- Do NOT use cleaning materials or means to accelerate the defrosting process other than those recommended by the manufacturer.
- Be aware that the refrigerant inside the system is odourless.



WARNING

The refrigerant inside the unit is mildly flammable, but normally does NOT leak. If the refrigerant leaks in the room and comes in contact with fire from a burner, a heater, or a cooker, this may result in fire, or the formation of a harmful gas.

Turn off any combustible heating devices, ventilate the room, and contact the dealer where you purchased the unit.

Do NOT use the unit until a service person confirms that the part from which the refrigerant leaked has been repaired.

6.6.4 To determine the additional refrigerant amount

If the total liquid piping length is...	Then...
≤20 m	Do NOT add additional refrigerant.
>20 m	R=(total length (m) of liquid piping–20 m)×0.020 R=Additional charge (kg) (rounded in units of 0.1 kg)



INFORMATION

Piping length is the one-way length of liquid piping.

6.6.5 To determine the complete recharge amount



INFORMATION

If a complete recharge is necessary, the total refrigerant charge is: the factory refrigerant charge (see unit name plate) + the determined additional amount.

6.6.6 To charge additional refrigerant



WARNING

- Only use R32 as refrigerant. Other substances may cause explosions and accidents.
- R32 contains fluorinated greenhouse gases. Its global warming potential (GWP) value is 675. Do NOT vent these gases into the atmosphere.
- When charging refrigerant, ALWAYS use protective gloves and safety glasses.



CAUTION

To avoid compressor breakdown, do NOT charge more than the specified amount of refrigerant.

Prerequisite: Before charging refrigerant, make sure the refrigerant piping is connected and checked (leak test and vacuum drying).

- Connect the refrigerant cylinder to the service port.
- Charge the additional refrigerant amount.
- Open the gas stop valve.

6.6.7 To fix the fluorinated greenhouse gases label

- Fill in the label as follows:

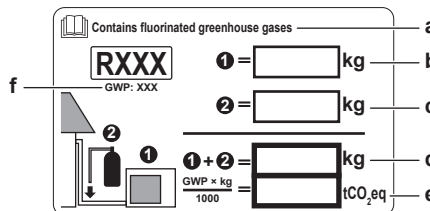

- If a multilingual fluorinated greenhouse gases label is delivered with the unit (see accessories), peel off the applicable language and stick it on top of a.
- Factory refrigerant charge: see unit name plate
- Additional refrigerant amount charged
- Total refrigerant charge
- Quantity of fluorinated greenhouse gases** of the total refrigerant charge expressed as tonnes CO₂ equivalent.
- GWP = Global warming potential



NOTICE

Applicable legislation on **fluorinated greenhouse gases** requires that the refrigerant charge of the unit is indicated both in weight and CO₂ equivalent.

Formula to calculate the quantity in CO₂ equivalent tonnes: GWP value of the refrigerant × total refrigerant charge [in kg] / 1000

Use the GWP value mentioned on the refrigerant charge label. That GWP is based on the current legislation on fluorinated greenhouse gases. The GWP mentioned in the manual might be outdated.

- Fix the label on the inside of the outdoor unit near the gas and liquid stop valves.

6.7 Connecting the electrical wiring

6.7.1 About connecting the electrical wiring

Before connecting the electrical wiring

Make sure:

- The refrigerant piping is connected and checked
- The water piping is connected

Typical workflow

Connecting the electrical wiring typically consists of the following stages:

- 1 Making sure the power supply system complies with the electrical specifications of the units.
- 2 Connecting the electrical wiring to the outdoor unit.
- 3 Connecting the electrical wiring to the indoor unit.
- 4 Connecting the main power supply.

6.7.2 Precautions when connecting the electrical wiring

i INFORMATION

Also read the precautions and requirements in the following chapters:

- General safety precautions
- Preparation

i INFORMATION

Appliance shall be installed in accordance with national wiring regulations.

⚡ DANGER: RISK OF ELECTROCUTION

! WARNING

ALWAYS use multicore cable for power supply cables.

! WARNING

Use an all-pole disconnection type breaker with at least 3 mm between the contact point gaps that provide full disconnection under overvoltage category III.

! WARNING

If the supply cord is damaged, it MUST be replaced by the manufacturer, its service agent or similarly qualified persons in order to avoid a hazard.

! WARNING

Do NOT connect the power supply to the indoor unit. This could result in electrical shock or fire.

! WARNING

- Do NOT use locally purchased electrical parts inside the product.
- Do NOT branch the power supply for the drain pump, etc. from the terminal block. This could result in electrical shock or fire.

! WARNING

Keep the interconnection wiring away from copper pipes without thermal insulation as such pipes will be very hot.

⚡ DANGER: RISK OF ELECTROCUTION

All electrical parts (including thermistors) are powered by the power supply. Do not touch them with bare hands.

⚡ DANGER: RISK OF ELECTROCUTION

Disconnect the power supply for more than 10 minutes, and measure the voltage at the terminals of main circuit capacitors or electrical components before servicing. The voltage MUST be less than 50 V DC before you can touch electrical components. For the location of the terminals, see the wiring diagram.

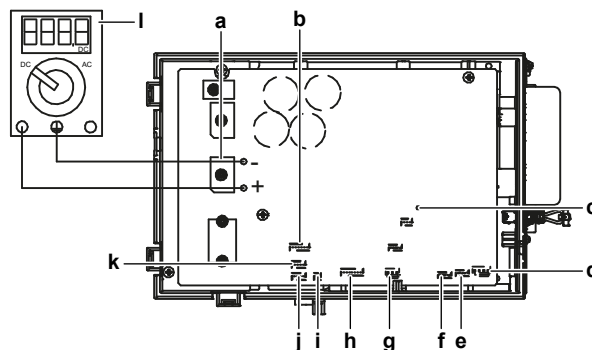

- a DB1 diode bridge
- b S90 thermistor lead wire
- c LED A
- d S40 thermal overload relay lead wire
- e S20 (white) room A electronic expansion valve coil
- f S21 (red) room B electronic expansion valve coil
- g S80 (white) 4-way valve lead wire connector
- h S70 fan motor lead wire
- i S99 heating lock
- j S91 (red) liquid thermistor lead wire
- k S92 (white) gas thermistor lead wire
- l Multimeter (DC voltage range)

6.7.3 Guidelines when connecting the electrical wiring

Keep the following in mind:

- If stranded conductor wires are used, install a round crimp-style terminal on the end of the wire. Place the round crimp-style terminal on the wire up to the covered part and fasten the terminal with the appropriate tool.

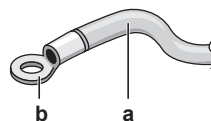

- a Stranded conductor wire
- b Round crimp-style terminal

- Use the following methods for installing wires:

Wire type	Installation method
Single-core wire	<p>a Curled single-core wire</p> <p>b Screw</p> <p>c Flat washer</p>
Stranded conductor wire with round crimp-style terminal	<p>a Terminal</p> <p>b Screw</p> <p>c Flat washer</p> <p>O Allowed</p> <p>X NOT allowed</p>

6 Installation

Tightening torques

Item	Tightening torque (N•m)
M4 (X1M)	1.2
M4 (earth)	

- The earth wire between the wire retainer and the terminal must be longer than the other wires.

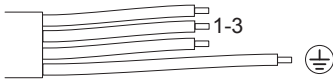

6.7.4 Specifications of standard wiring components

Component		
Power supply cable	Voltage	220~240 V
	Phase	1~
	Frequency	50 Hz
	Wire type	3-core cable 2.5 mm ² H05RN-F (60245 IEC 57) H07RN-F (60245 IEC 66)
	3-core cable 4.0 mm ² H07RN-F (60245 IEC 66)	
Interconnection cable (indoor↔outdoor)	4-core cable 1.5 mm ² or 2.5 mm ² and applicable for 220~240 V H05RN-F (60245 IEC 57)	
Recommended circuit breaker	16 A	
Earth leakage circuit breaker	MUST comply with applicable legislation	

6.7.5 To connect the electrical wiring on the outdoor unit

- Remove the switch box cover (2 screws).

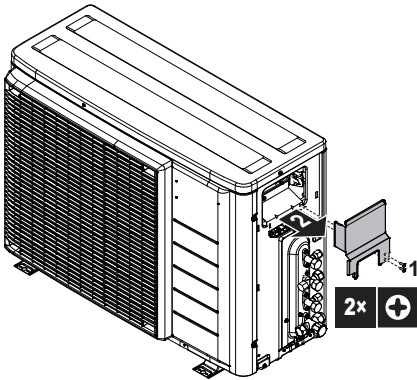

- Strip insulation (20 mm) from the wires.

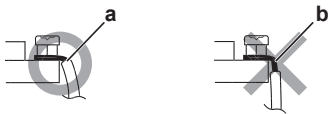

- Strip wire end to this point
- Excessive strip length may cause electrical shock or leakage.

- Connect the wires between the indoor and outdoor units so that the terminal numbers match. Make sure to match the symbols for piping and wiring.
- Make sure to connect correct wiring to correct room (A to A, B to B).

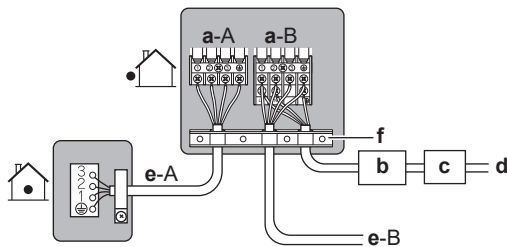

- Terminal for room (A, B)
- Circuit breaker
- Earth leakage circuit breaker
- Power supply wire
- Interconnection wire for room (A, B)
- Wire retainer

- Tighten the terminal screws securely using a Phillips screwdriver.
- Check that the wires do not disconnect by pulling them lightly.
- Firmly secure the wire retainer to avoid external stress on wire terminations.
- Pass the wiring through the cutout on the bottom of the protection plate.
- Make sure the electrical wiring does not contact with the gas piping.

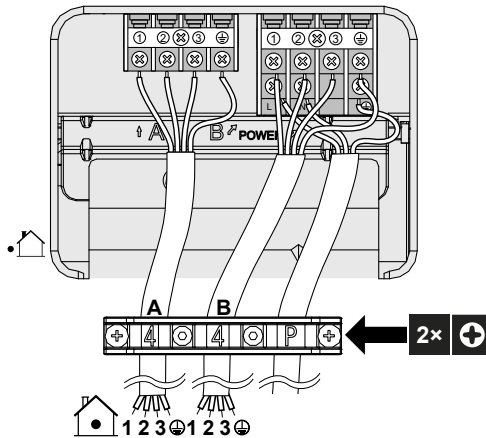

- Reattach the switch box cover and the service cover.

6.8 Finishing the outdoor unit installation

6.8.1 To finish the outdoor unit installation



NOTICE

It is recommended that the refrigerant piping between indoor and outdoor unit is installed in a ducting or the refrigerant piping is wrapped with finishing tape.

- Insulate and fix the refrigerant piping and interconnection cable as follows:

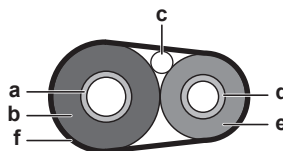

- Gas pipe
- Gas pipe insulation
- Interconnection cable
- Liquid pipe
- Liquid pipe insulation
- Finishing tape

- Install the service cover.

6.8.2 About ECONO mode prohibition setting

This setting disables the input control signal from the user interface. Use this setting when you wish to block reception of input controls (cooling/heating) from indoor unit user interfaces.

To turn on ECONO mode prohibition setting

Prerequisite: The main power supply MUST be turned off.

- 1 Remove the top plate of the outdoor unit (2 screws on sides)
- 2 Remove the electric box cover by sliding it. Be careful not to bend the electric box hook.
- 3 Cut the jumper (J23).

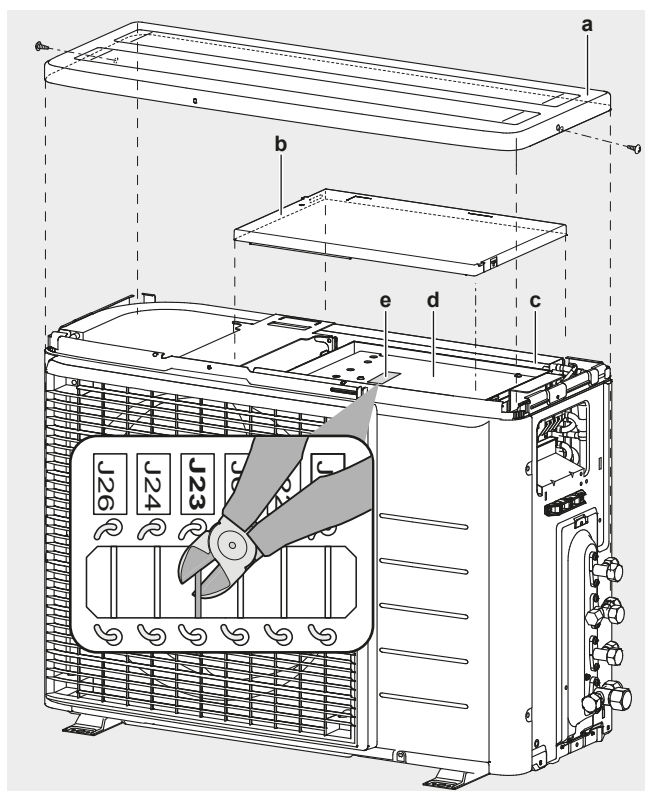

- a Top plate
- b Electric box cover
- c Electric box
- d PCB
- e PCB jumpers

- 4 Reinstall the electric box cover and the top plate in reverse order and turn on the main power supply.

6.8.3 About night quiet mode

The night quiet mode function makes the outdoor unit run more quietly at nighttime. This will reduce the cooling capacity of the unit. Explain Night quiet mode to the customer and confirm if customer wants to use this mode.

To turn on the night quiet mode

Prerequisite: The main power supply MUST be turned off.

- 1 Remove the top plate and the electric box cover of the outdoor unit (see "To turn on ECONO mode prohibition setting" [▶ 21])
- 2 Cut the jumper J6.

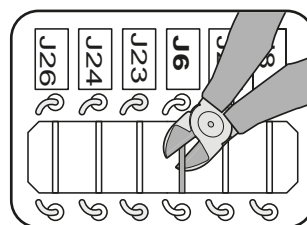

- 3 Reinstall the top plate and the electric box cover.



CAUTION

When reinstalling the electric box cover, be careful not to pinch the fan motor lead wire.

6.8.4 About heat mode lock

Heat mode lock limits the unit to heat operation.

To turn on heat mode lock

- 1 Remove the top plate (2 screws) and the front plate (8 screws).
- 2 To set heat mode lock remove the S99 connector.
- 3 To reset the heat pump mode (cooling/heating), plug the connector back.

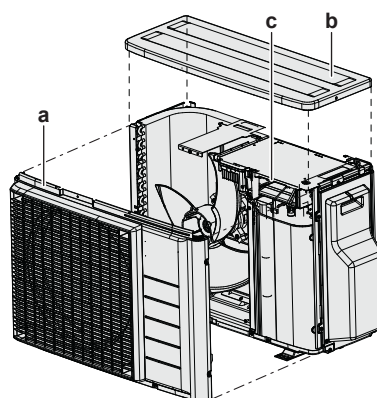

- a Front plate
- b Top plate
- c S99 connector

Mode	S99 connector
Heat pump (cooling, heating)	Connected
Heating only	Disconnected

- 4 Reinstall the top plate and the front plate.



INFORMATION

Forced operation is also available in heating mode.

6.8.5 About standby electricity saving function

The standby electricity saving function:

- turns OFF the power supply to the outdoor unit and,
- turns ON the standby electricity saving mode on the indoor unit.

The standby electricity saving function works with following units:

FTXM, FTXP, FTXJ, FVXM, ATXF

If another indoor unit is used, the connector for standby electric saving must be plugged in.

The standby electricity saving function is turned off before shipping.

To turn on standby electricity saving function

Prerequisite: The main power supply MUST be turned off.

- 1 Remove the service cover.
- 2 Disconnect the selective standby electricity saving connector.

7 Commissioning

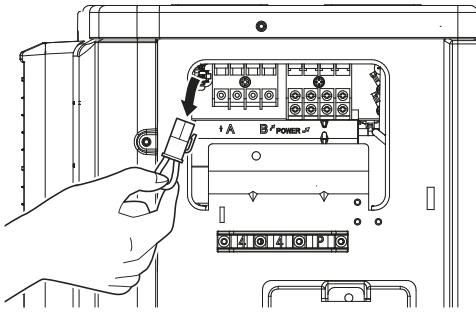

- 3 Turn on the main power supply.

6.8.6 To close the outdoor unit

- 1 Close the switch box cover.
- 2 Close the service cover.



NOTICE

When closing the outdoor unit cover, make sure that the tightening torque does NOT exceed 4.1 N·m.

7 Commissioning



NOTICE

General commissioning checklist. Next to the commissioning instructions in this chapter, a general commissioning checklist is also available on the Daikin Business Portal (authentication required).

The general commissioning checklist is complementary to the instructions in this chapter and can be used as a guideline and reporting template during the commissioning and hand-over to the user.

7.1 Overview: Commissioning

This chapter describes what you have to do and know to commission the system after it is installed.

Typical workflow

Commissioning typically consists of the following stages:

- 1 Checking the "Checklist before commissioning".
- 2 Performing a test run for the system.

7.2 Precautions when commissioning



INFORMATION

During the first running period of the unit, the required power may be higher than stated on the nameplate of the unit. This phenomenon is caused by the compressor, that needs a continuous run time of 50 hours before reaching smooth operation and stable power consumption.



NOTICE

ALWAYS operate the unit with thermistors and/or pressure sensors/switches. If NOT, burning of the compressor might be the result.



NOTICE

ALWAYS complete the refrigerant piping of the unit before operating. If NOT, the compressor will break.

7.3 Checklist before commissioning

After the installation of the unit, first check the items listed below. Once all checks are fulfilled, the unit must be closed. Power-up the unit after it is closed.

<input type="checkbox"/>	The indoor unit is properly mounted.
<input type="checkbox"/>	The outdoor unit is properly mounted.
<input type="checkbox"/>	The system is properly earthed and the earth terminals are tightened.
<input type="checkbox"/>	The power supply voltage matches the voltage on the identification label of the unit.
<input type="checkbox"/>	There are NO loose connections or damaged electrical components in the switch box.
<input type="checkbox"/>	There are NO damaged components or squeezed pipes on the inside of the indoor and outdoor units.
<input type="checkbox"/>	There are NO refrigerant leaks .
<input type="checkbox"/>	The refrigerant pipes (gas and liquid) are thermally insulated.
<input type="checkbox"/>	The correct pipe size is installed and the pipes are properly insulated.
<input type="checkbox"/>	The stop valves (gas and liquid) on the outdoor unit are fully open.
<input type="checkbox"/>	Drainage Make sure drainage flows smoothly. Possible consequence: Condensate water might drip.
<input type="checkbox"/>	The indoor unit receives the signals of the user interface .
<input type="checkbox"/>	The specified wires are used for the interconnection cable .
<input type="checkbox"/>	The fuses, circuit breakers , or locally installed protection devices are installed according to this document, and have NOT been bypassed.
<input type="checkbox"/>	Check if marks (room A~E) on the wiring and piping match for each indoor unit.
<input type="checkbox"/>	Check if the priority room setting is set for 2 or more rooms. Keep in mind that the DHW generator for Multi or the Hybrid for Multi shall not be selected as the priority room.

7.4 Checklist during commissioning

<input type="checkbox"/>	To perform a wiring check .
<input type="checkbox"/>	To perform an air purge .
<input type="checkbox"/>	To perform a test run .

7.5 Trial operation and testing

<input type="checkbox"/>	Before starting the test run, measure the voltage at the primary side of the safety breaker .
<input type="checkbox"/>	The piping and wiring work match.
<input type="checkbox"/>	The stop valves (gas and liquid) on the outdoor unit are fully open.

Initialization of the Multi system can take several minutes depending on the number of indoor units and options used.

7.5.1 To perform a test run

Prerequisite: Power supply MUST be in the specified range.

Prerequisite: Test run operation may be done in cooling or heating mode.

Prerequisite: Test run should be done in accordance with the operation manual of the indoor unit to make sure that all functions and parts are working properly.

- 1 In cooling mode, select the lowest programmable temperature. In heating mode, select the highest programmable temperature.
- 2 Measure the temperature at the indoor unit inlet and outlet after running the unit for about 20 minutes. The difference should be more than 8°C (cooling) or 15°C (heating).
- 3 First check operation of each unit individually, then check simultaneous operation of all indoor units. Check both heating and cooling operation.
- 4 When test run is finished, set the temperature to a normal level. In cooling mode: 26~28°C, in heating mode: 20~24°C.



INFORMATION

- Test run can be disabled if necessary.
- After the unit is turned OFF, it cannot be started again for 3 minutes.
- During cooling operation, frost may form on the gas stop valve or other parts. This is normal.



INFORMATION

- Even if the unit is turned OFF, it consumes electricity.
- When the power turns back on after a power break, the previously selected mode will be resumed.

7.6 Starting up the outdoor unit

See the indoor unit installation manual for configuration and commissioning of the system.

7.7 Fault diagnosis using LED on outdoor unit PCB

LED is...	Diagnosis
flashing	Normal. <ul style="list-style-type: none"> ▪ Check the indoor unit.
ON	<ul style="list-style-type: none"> ▪ Turn the power OFF and back ON, and check the LED within approximately 3 minutes. If the LED is ON again, the outdoor unit PCB is faulty.
OFF	<ol style="list-style-type: none"> 1 Supply voltage (for power saving). 2 Power supply fault. 3 Turn the power OFF and back ON, and check the LED within approximately 3 minutes. If the LED is OFF again, the outdoor unit PCB is faulty.

8 Hand-over to the user

Once the test run is finished and the unit operates properly, please make sure the following is clear for the user:

- Make sure that the user has the printed documentation and ask him/her to keep it for future reference. Inform the user that he can find the complete documentation at the URL mentioned earlier in this manual.

- Explain the user how to properly operate the system and what to do in case of problems.
- Show the user what to do for the maintenance of the unit.

9 Maintenance and service



NOTICE

General maintenance/inspection checklist. Next to the maintenance instructions in this chapter, a general maintenance/inspection checklist is also available on the Daikin Business Portal (authentication required).

The general maintenance/inspection checklist is complementary to the instructions in this chapter and can be used as a guideline and reporting template during maintenance.



NOTICE

Maintenance MUST be done by an authorized installer or service agent.

We recommend performing maintenance at least once a year. However, applicable legislation might require shorter maintenance intervals.



NOTICE

Applicable legislation on **fluorinated greenhouse gases** requires that the refrigerant charge of the unit is indicated both in weight and CO₂ equivalent.

Formula to calculate the quantity in CO₂ equivalent tonnes: GWP value of the refrigerant × total refrigerant charge [in kg] / 1000

9.1 Overview: Maintenance and service

This chapter contains information about:

- Maintenance safety precautions
- The yearly maintenance of the outdoor unit

9.2 Maintenance safety precautions



DANGER: RISK OF ELECTROCUTION



DANGER: RISK OF BURNING



NOTICE: Risk of electrostatic discharge

Before performing any maintenance or service work, touch a metal part of the unit in order to eliminate static electricity and to protect the PCB.

9.3 Checklist for yearly maintenance of the outdoor unit

Check the following at least once a year:

- Heat exchanger
The heat exchanger of the outdoor unit can get blocked up due to dust, dirt, leaves, etc. It is recommended to clean the heat exchanger yearly. A blocked heat exchanger can lead to too low pressure or too high pressure leading to worse performance.

9.4 About the compressor

When servicing the compressor keep in mind following precautions:

10 Troubleshooting



DANGER: RISK OF ELECTROCUTION

- Use this compressor on a grounded system only.
- Turn the power off before servicing the compressor.
- Reattach the switch box cover and service lid after servicing.



CAUTION

Always wear safety goggles and protective gloves.



DANGER: RISK OF EXPLOSION

- Use a pipe cutter to remove the compressor.
- Do NOT use the brazing torch.
- Use approved refrigerants and lubricants only.



DANGER: RISK OF BURNING

Do NOT touch the compressor with bare hands.

10 Troubleshooting

10.1 Overview: Troubleshooting

This chapter describes what you have to do in case of problems.

It contains information about solving problems based on symptoms.

Before troubleshooting

Carry out a thorough visual inspection of the unit and look for obvious defects such as loose connections or defective wiring.

10.2 Precautions when troubleshooting



WARNING

- When carrying out an inspection on the switch box of the unit, ALWAYS make sure that the unit is disconnected from the mains. Turn off the respective circuit breaker.
- When a safety device was activated, stop the unit and find out why the safety device was activated before resetting it. NEVER shunt safety devices or change their values to a value other than the factory default setting. If you are unable to find the cause of the problem, call your dealer.



DANGER: RISK OF ELECTROCUTION



WARNING

Prevent hazards due to inadvertent resetting of the thermal cut-out: power to this appliance MUST NOT be supplied through an external switching device, such as a timer, or connected to a circuit that is regularly turned ON and OFF by the utility.



DANGER: RISK OF BURNING

10.3 Solving problems based on symptoms

10.3.1 Symptom: Indoor units fall, vibrate or make noise

Possible causes	Corrective action
The indoor units are not installed securely	Install the indoor units securely.

10.3.2 Symptom: The unit is NOT heating or cooling as expected

Possible causes	Corrective action
Wrong connection of the electrical wires	Connect the electrical wires correctly.
Gas leakage	Check for gas leakage.
Marks on the wiring and piping do NOT match	Marks on the wiring and piping (room A, room B, room C, room D, room E) for each indoor unit MUST match.

10.3.3 Symptom: Water leakage

Possible causes	Corrective action
Incomplete thermal insulation (gas and liquid piping, indoor portions of the drain hose extension)	Make sure the thermal insulation of the piping and the drain hose is complete.
Improperly connected drainage	Secure the drainage.

10.3.4 Symptom: Electrical leakage

Possible causes	Corrective action
The unit is NOT earthed correctly	Check and correct the connection of the earth wiring.

10.3.5 Symptom: Unit does NOT function or burn damage

Possible causes	Corrective action
The wiring was NOT performed in accordance with the specifications	Correct the wiring.

11 Disposal



NOTICE

Do NOT try to dismantle the system yourself: dismantling of the system, treatment of the refrigerant, oil and other parts MUST comply with applicable legislation. Units MUST be treated at a specialised treatment facility for reuse, recycling and recovery.

11.1 Overview: Disposal

Typical workflow

Disposing of the system typically consists of the following stages:

- Pumping down the system.
- Bringing the system to a specialized treatment facility.



INFORMATION

For more details, see the service manual.

11.2 To pump down

Example: To protect the environment, pump down when relocating the unit or when disposing of the unit.



DANGER: RISK OF EXPLOSION

Pump down – Refrigerant leakage. If you want to pump down the system, and there is a leak in the refrigerant circuit:

- Do NOT use the unit's automatic pump down function, with which you can collect all refrigerant from the system into the outdoor unit. **Possible consequence:** Self-combustion and explosion of the compressor because of air going into the operating compressor.
- Use a separate recovery system so that the unit's compressor does NOT have to operate.



NOTICE

During pump down operation, stop the compressor before removing the refrigerant piping. If the compressor is still running and the stop valve is open during pump down, air will be sucked into the system. Compressor breakdown or damage to the system can result due to abnormal pressure in the refrigerant cycle.

Pump down operation will extract all refrigerant from the system into the outdoor unit.

- Remove the valve cap from the liquid stop valve and the gas stop valve.
- Carry out forced cooling. See "11.3 To start and stop forced cooling" [p. 25].
- After 5 to 10 minutes (after only 1 or 2 minutes in case of very low ambient temperatures (<math><-10^{\circ}\text{C}</math>)), close the liquid stop valve with a hexagonal wrench.
- Check on the manifold if the vacuum is reached.
- After 2-3 minutes, close the gas stop valve and stop forced cooling.

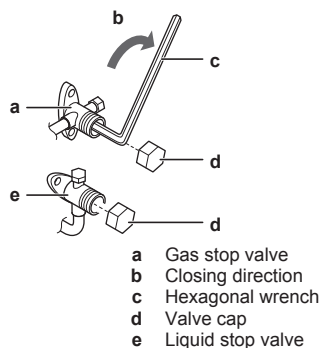

11.3 To start and stop forced cooling

There are 2 methods to perform forced cooling.

- Method 1.** Using the indoor unit ON/OFF switch (if present on the indoor unit).
- Method 2.** Using the indoor unit user interface.

11.3.1 To start and stop forced cooling using the indoor unit ON/OFF switch

- Press the ON/OFF switch for at least 5 seconds.

Result: Operation will start.



INFORMATION

Forced cooling stops automatically after 15 minutes.

- To stop operation sooner, press the ON/OFF switch.

11.3.2 To start and stop forced cooling using the indoor unit user interface

- Set the operation mode to **cooling**. Refer to "To perform a test run" in the installation manual of the indoor unit.

12 Technical data

- A **subset** of the latest technical data is available on the regional Daikin website (publicly accessible).
- The **full set** of latest technical data is available on the Daikin Business Portal (authentication required).

12.1 Wiring diagram

12.1.1 Unified wiring diagram legend

For applied parts and numbering, refer to the wiring diagram on the unit. Part numbering is by Arabic numbers in ascending order for each part and is represented in the overview below by "*" in the part code.

Symbol	Meaning	Symbol	Meaning
	Circuit breaker		Protective earth
	Connection		Protective earth (screw)
	Connector		Rectifier
	Earth		Relay connector
	Field wiring		Short-circuit connector
	Fuse		Terminal
	Indoor unit		Terminal strip
	Outdoor unit		Wire clamp

Symbol	Colour	Symbol	Colour
BLK	Black	ORG	Orange
BLU	Blue	PNK	Pink
BRN	Brown	PRP, PPL	Purple
GRN	Green	RED	Red
GRY	Grey	WHT	White
		YLW	Yellow

Symbol	Meaning
A*P	Printed circuit board
BS*	Pushbutton ON/OFF, operation switch
BZ, H*C	Buzzer
C*	Capacitor
AC*, CN*, E*, HA*, HE*, HL*, HN*, HR*, MR*_A, MR*_B, S*, U, V, W, X*A, K*R_*	Connection, connector
D*, V*D	Diode
DB*	Diode bridge
DS*	DIP switch
E*H	Heater
FU*, F*U, (for characteristics, refer to PCB inside your unit)	Fuse
FG*	Connector (frame ground)

12 Technical data

Symbol	Meaning
H*	Harness
H*P, LED*, V*L	Pilot lamp, light emitting diode
HAP	Light emitting diode (service monitor green)
HIGH VOLTAGE	High voltage
IES	Intelligent eye sensor
IPM*	Intelligent power module
K*R, KCR, KFR, KHuR, K*M	Magnetic relay
L	Live
L*	Coil
L*R	Reactor
M*	Stepper motor
M*C	Compressor motor
M*F	Fan motor
M*P	Drain pump motor
M*S	Swing motor
MR*, MRCW*, MRM*, MRN*	Magnetic relay
N	Neutral
n=*, N=*	Number of passes through ferrite core
PAM	Pulse-amplitude modulation
PCB*	Printed circuit board
PM*	Power module
PS	Switching power supply
PTC*	PTC thermistor
Q*	Insulated gate bipolar transistor (IGBT)
Q*DI	Earth leak circuit breaker
Q*L	Overload protector
Q*M	Thermo switch
R*	Resistor
R*T	Thermistor
RC	Receiver
S*C	Limit switch
S*L	Float switch
S*NPH	Pressure sensor (high)

Symbol	Meaning
S*NPL	Pressure sensor (low)
S*PH, HPS*	Pressure switch (high)
S*PL	Pressure switch (low)
S*T	Thermostat
S*RH	Humidity sensor
S*W, SW*	Operation switch
SA*, F1S	Surge arrester
SR*, WLU	Signal receiver
SS*	Selector switch
SHEET METAL	Terminal strip fixed plate
T*R	Transformer
TC, TRC	Transmitter
V*, R*V	Varistor
V*R	Diode bridge
WRC	Wireless remote controller
X*	Terminal
X*M	Terminal strip (block)
Y*E	Electronic expansion valve coil
Y*R, Y*S	Reversing solenoid valve coil
Z*C	Ferrite core
ZF, Z*F	Noise filter
A*P	Printed circuit board
BS*	Pushbutton ON/OFF, operation switch
BZ, H*C	Buzzer
C*	Capacitor
AC*, CN*, E*, HA*, HE*, HL*, HN*, HR*, MR*_A, MR*_B, S*, U, V, W, X*A, K*R_*	Connection, connector

12.2 Piping diagram: Outdoor unit

Component PED category classification:

- High pressure switches: category IV
- Compressor: category II
- Other components: refer to PED article 4, paragraph 3

2MXM50, 2AMXM50, 2AMXF50, 2MXF50

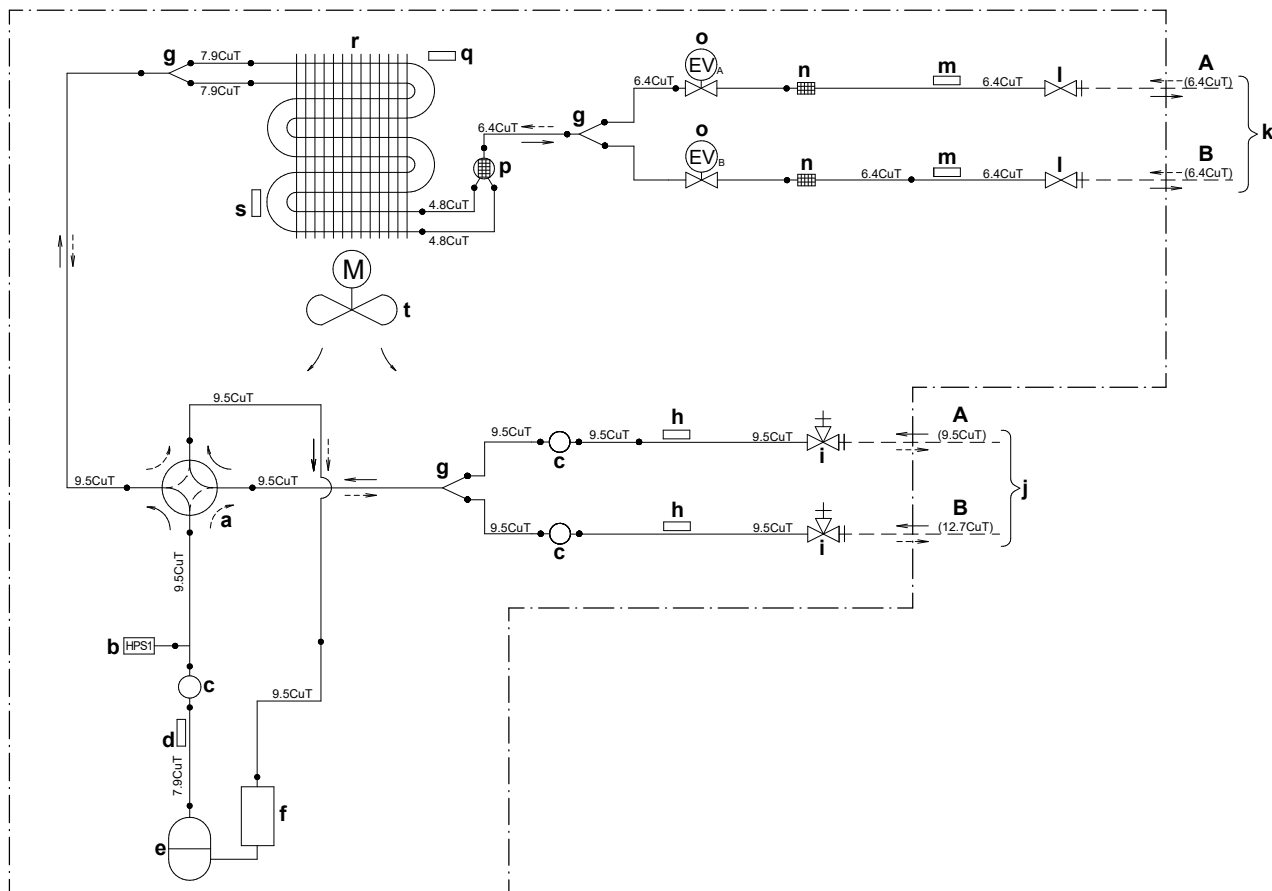

- A** Room A
- B** Room B
- a** 4-way valve ON: heating
- b** High pressure switch with automatic reset
- c** Muffler
- d** Discharge pipe thermistor
- e** Compressor
- f** Accumulator
- g** Branch pipe
- h** Thermistor (gas)
- i** Gas stop valve
- j** Field piping (gas)
- k** Field piping (liquid)
- l** Liquid stop valve
- m** Thermistor (liquid)
- n** Filter
- o** Motor-operated valve
- p** Muffler
- q** Outdoor air temperature thermistor
- r** Heat exchanger
- M** Fan motor
- Refrigerant flow: cooling
- - - Refrigerant flow: heating

13 Glossary

Dealer

Sales distributor for the product.

Authorised installer

Technical skilled person who is qualified to install the product.

User

Person who is owner of the product and/or operates the product.

Applicable legislation

All international, European, national and local directives, laws, regulations and/or codes that are relevant and applicable for a certain product or domain.

Service company

Qualified company which can perform or coordinate the required service to the product.

Installation manual

Instruction manual specified for a certain product or application, explaining how to install, configure and maintain it.

Operation manual

Instruction manual specified for a certain product or application, explaining how to operate it.

Maintenance instructions

Instruction manual specified for a certain product or application, which explains (if relevant) how to install, configure, operate and/or maintain the product or application.

Accessories

Labels, manuals, information sheets and equipment that are delivered with the product and that need to be installed according to the instructions in the accompanying documentation.

Optional equipment

Equipment made or approved by Daikin that can be combined with the product according to the instructions in the accompanying documentation.

Field supply

Equipment NOT made by Daikin that can be combined with the product according to the instructions in the accompanying documentation.

ERC

DAIKIN INDUSTRIES CZECH REPUBLIC s.r.o.
U Nové Hospody 1/1155, 301 00 Plzeň Skvrňany, Czech Republic

DAIKIN EUROPE N.V.
Zandvoordestraat 300, B-8400 Oostende, Belgium

Copyright 2019 Daikin

4P600463-2 2019.10