

HD Pan & Tilt Wi-Fi Camera

Quick Start Guide

Schnellinstallationsanleitung

Guide de démarrage rapide

Guía de inicio rápido

Guida di avvio rapida

Beknopte handleiding

Skrócona instrukcja obsługi

Stručná úvodní příručka

Gyors kezdési útmutató

Hurtigstartguide

Hurtig startvejledning

Pikaopas

Snabbstartsguide

Guia Iniciação Rápida

Οδηγός γρήγορης εκκίνησης

Vodič za brzi početak

Priročnik za hitro uporabo

Ghid de pornire rapidă

DCS-8515LH



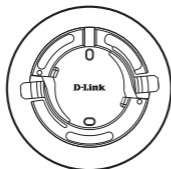
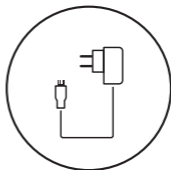

1

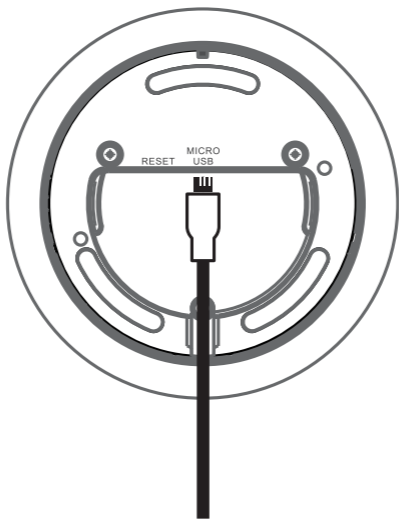

Plug the included USB power adapter into the power port on the bottom of the camera, making sure to route the cable appropriately.

2

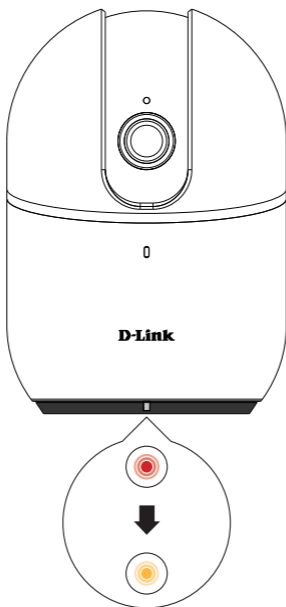

Once the camera has powered up, it will rotate left and right, up and down to calibrate itself. Wait until the LED at the front changes from red to blinking orange.

3



Scan the QR code above to download the **mydlink** app for your Android or iOS device.

4



New Users:

Tap **Sign Up** to register for a mydlink account, then tap **Add a Device** to install your camera. Continue to follow the onscreen instructions.

OR



Existing Users:

Sign in using your mydlink account and tap the icon at the top-left, then tap **Add a Device** to start the setup wizard. Continue to follow the onscreen instructions.

5

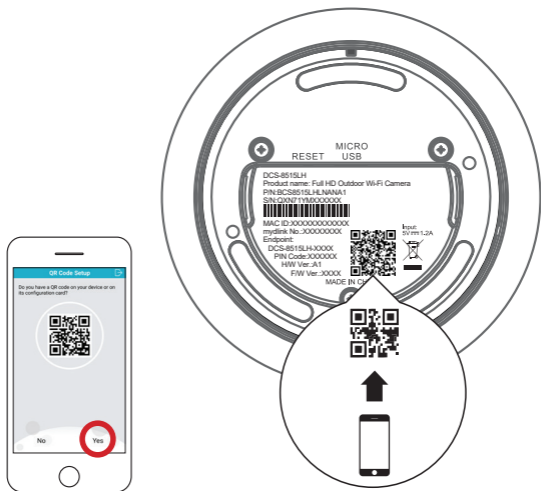

When prompted, select "Yes" to scan the QR code on the bottom of the camera, then continue to follow the onscreen instructions to complete the setup process.

6

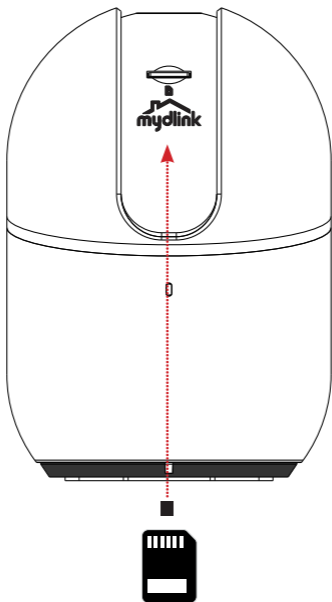

Please move the lens part up to unhide the SD card slot. Where a microSD card can be inserted in order to save video recordings.

Note: Please use the mydlink app to tilt the camera up to reveal the slot.



Minimum Requirements

To install this product, you will need:

- An 802.11 g/n wireless router
- An Internet connection
- The latest version of the mydlink app from the App Store or Google Play. Please refer to the app's store page to check whether your device is compatible.
- An e-mail account (required to register for mydlink service)



Camera Mounting Instructions

Step 1:

Place the mount at the desired location, assuring that location of the power cord thread is also at the desired location. Use a pencil to mark the holes.

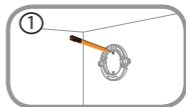

Step 2:

Using a 6 mm drill bit, drill two 25 mm deep holes over the pencil marks. For a plaster, drywall, or concrete wall, insert the plastic anchors to support the screws first.

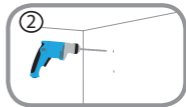

Step 3:

Place the mount over the holes that are in the wall. Make sure to align the mount holes with the holes in the wall. Use the supplied screws to attach the mount to the surface of the wall.

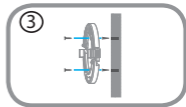

Step 4:

Align the bottom of the camera to the threads on the mount. Assure that the camera is securely snapped into place.

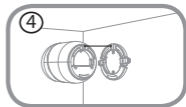







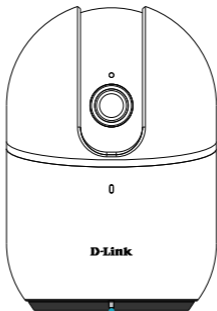

Camera LED Information

DCS-8515LH



Status LED

-  System booting / Factory resetting
-  Firmware updating
-  Bluetooth enabled
-  BLE pairing / Ready for setup
-  Wireless connected
-  Data is being transferred

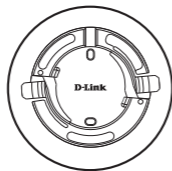
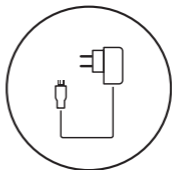

1

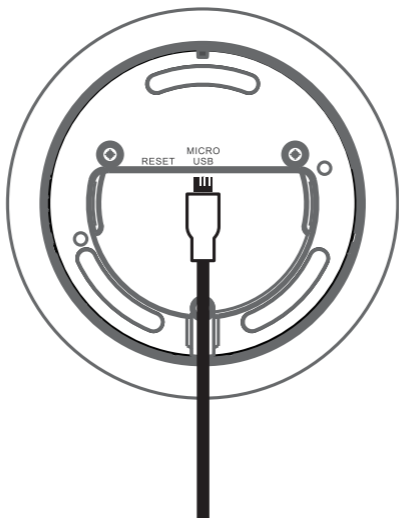

Stecken Sie das mitgelieferte USB-Netzteil in den Stromanschluss auf der Unterseite der Kamera und achten Sie auf eine richtige Kabelführung.

2



Sobald die Kamera gestartet wurde, dreht sie sich nach links und rechts, oben und unten, um sich selbst zu kalibrieren. Warten Sie, bis die LED auf der Vorderseite von Rot zu orange blinkend wechselt.

3



Scannen Sie den QR-Code oben, um die **mydlink**-App für Ihr Android- oder iOS-Gerät herunterzuladen.

4



Neue Benutzer: Tippen Sie auf **Sign up (Registrieren)**, um ein neues mydlink-Konto zu registrieren, tippen Sie dann auf **Add a Device (ein Gerät hinzufügen)**, um Ihre Kamera zu installieren. Befolgen Sie dann die Anweisungen auf dem Bildschirm.

ODER



Bestehende Benutzer: Melden Sie sich mit Ihrem mydlink-Konto an und tippen Sie auf das Symbol oben links, tippen Sie dann auf **Add a Device (ein Gerät hinzufügen)**, um den Setup-Assistenten zu starten. Befolgen Sie dann die Anweisungen auf dem Bildschirm.

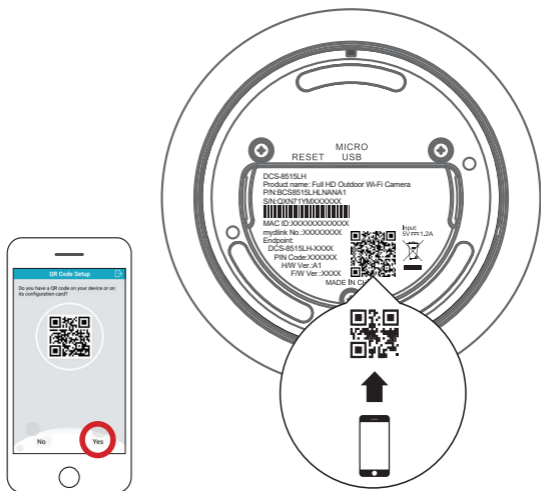

Bei Aufforderung wählen Sie YES (JA), um den QR-Code auf der Unterseite der Kamera zu scannen. Dann befolgen Sie die Anweisungen auf dem Bildschirm, um den Einrichtungsvorgang abzuschließen.

6

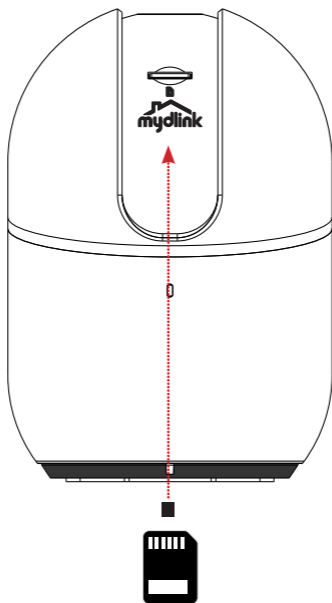

Bewegen Sie das Objektiv nach oben, um den SD-Karteneinschub freizulegen. Wo eine microSD-Karte eingesetzt werden kann, um Videoaufnahmen zu speichern.

Anmerkung: Verwenden Sie die mydlink-App, um die Kamera nach oben zu neigen und den Steckplatz freizugeben.



Mindestanforderungen

Zur Installation dieses Produkts benötigen Sie:

- Einen 802.11 g/n Wireless Router
- Eine Internetverbindung
- Die neuste Version der mydlink App aus dem App Store oder Google Play. Auf der Seite des mobilen App Store können Sie überprüfen, ob Ihr Gerät kompatibel ist.
- Ein E-Mail-Konto (erforderlich für die Registrierung für den mydlink-Service)



Anweisungen zur Kameramontage

Schritt 1:

Platzieren Sie die Halterung an der gewünschten Position und achten Sie darauf, dass auch die Position der Stromkabelführung korrekt ist. Verwenden Sie einen Stift, um die Bohrlöcher zu markieren.

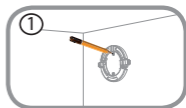

Schritt 2:

Verwenden Sie einen 6 mm Bohrer und bohren Sie zwei 25 mm tiefe Löcher auf den Stiftmarkierungen. Setzen Sie bei einer Gips-, Trockenbau- oder Betonwand Dübel ein, um die Schrauben zu halten.

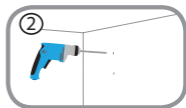

Schritt 3:

Setzen Sie die Halterung über die Löcher in der Wand. Richten Sie die Löcher der Halterung genau an den Löchern in der Wand aus. Verwenden Sie die mitgelieferten Schrauben, um die Halterung an der Wand anzubringen.

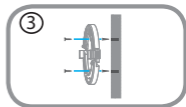

Schritt 4:

Richten Sie die Unterseite der Kamera an den Gewinden der Halterung aus. Achten Sie darauf, dass die Kamera fest einrastet.

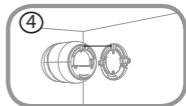







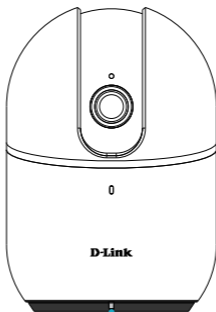

Kamera-LED-Informationen

DCS-8515LH



Status-LED

-  Systemstart/Zurücksetzen auf Werkseinstellungen
-  Firmware wird aktualisiert
-  Bluetooth aktiviert
-  BLE-Kopplung/Bereit für Setup
-  Drahtlos verbunden
-  Daten werden übertragen

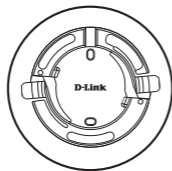
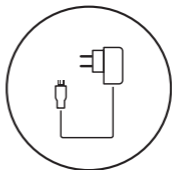

1

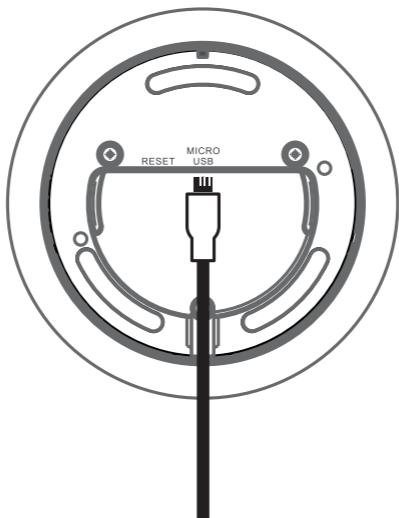

Branchez l'adaptateur secteur USB fourni sur le port d'alimentation situé sous la caméra, en veillant à acheminer le câble correctement.

2



Une fois que la caméra sous tension, elle pivote à gauche, à droite et à gauche pour se calibrer. Patientez jusqu'à ce que la LED située à l'avant passe du rouge à l'orange clignotant.

3



Scannez le code QR ci-dessus pour télécharger l'application **mydlink** pour votre périphérique Android ou iOS.

4



Nouveaux utilisateurs : Appuyez sur **Sign Up** (S'inscrire) pour enregistrer un compte mydlink, puis appuyez sur **Add a Device** (Ajouter un périphérique) pour installer votre caméra. Continuez en suivant les instructions à l'écran.

OU



Utilisateurs existants : Connectez-vous à l'aide de votre compte mydlink et appuyez sur l'icône en haut à gauche, puis appuyez sur **Add a Device** (Ajouter un périphérique) pour lancer l'assistant d'installation. Continuez en suivant les instructions à l'écran.

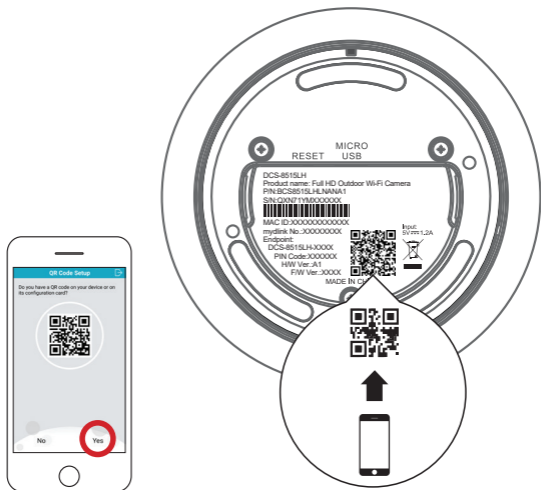

Lorsque vous y êtes invité, sélectionnez « Yes » (Oui) pour numériser le code QR au bas de la caméra, puis continuez à suivre les instructions à l'écran pour terminer le processus de configuration.

6

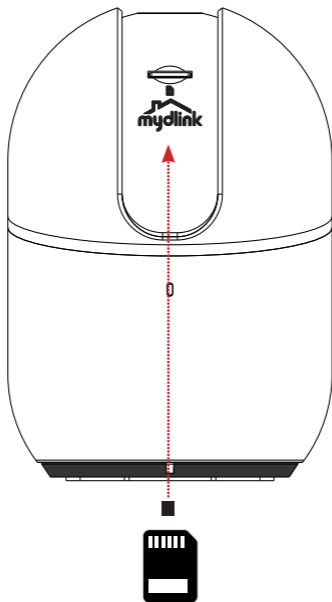

Déplacez la partie de l'objectif vers le haut pour révéler l'emplacement de la carte SD. Où une carte microSD peut être insérée afin de sauvegarder des enregistrements vidéo.

Remarque : Utilisez l'application mydlink pour incliner la caméra vers le haut pour révéler la fente.



Exigences minimales

Pour installer ce produit, vous avez besoin :

- D'un routeur sans fil 802.11 g/n
- D'une connexion Internet
- De la dernière version de l'application mydlink sur l'App Store ou Google Play. Veuillez vous reporter à la page de l'application de la boutique pour vérifier si votre appareil est compatible.
- Un compte de messagerie (requis pour s'inscrire au service mydlink)



Instructions de montage de la caméra

Étape 1 :

Placez le support à l'emplacement souhaité, en veillant à ce que l'emplacement du filetage du cordon d'alimentation se trouve également à l'emplacement souhaité. Utilisez un crayon pour marquer les trous.

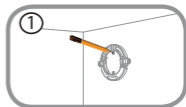

Étape 2 :

Utilisez un foret de 6 mm, percez des trous de 25 mm de profondeur sur les marques au crayon. Pour du plâtre, une cloison sèche ou un mur en béton, insérez d'abord des chevilles en plastique pour soutenir les vis.

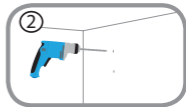

Étape 3 :

Placez le support sur les trous dans le mur. Assurez-vous de bien aligner les trous du support de la caméra avec les trous dans le mur. Utilisez les vis fournies pour fixer le support sur la surface du mur.

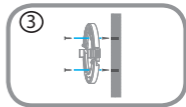

Étape 4 :

Alignez le bas de la caméra sur le filetage de la monture. Assurez-vous que la caméra est bien enclenchée.

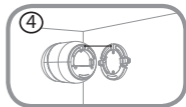





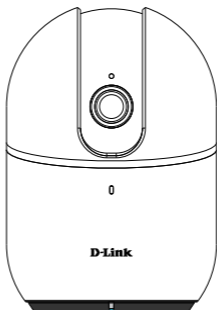



Informations sur la LED de la caméra DCS-8515LH



Voyant d'état

-  Démarrage du système / réinitialisation d'usine
-  Miss à jour du microprogramme
-  Bluetooth activé
-  Jumelage BLE / prêt pour la configuration
-  Connexion sans fil établie
-  Des données sont en cours de transfert

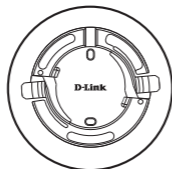
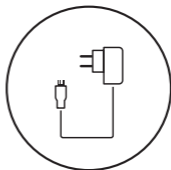

1

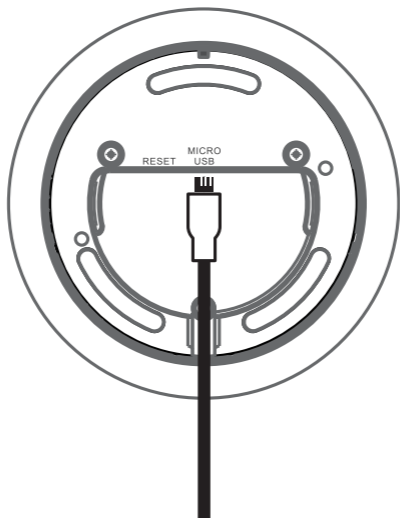

Enchufe el adaptador de alimentación USB que se incluye en el puerto de alimentación situado en la parte inferior de la cámara, asegurándose de dirigir correctamente el cable.

2



Una vez encendida la cámara, girará a izquierda y derecha, arriba y abajo, para calibrarse. Espere a que el LED de la parte delantera cambie de rojo a naranja intermitente.

3



Lea el código QR anterior para descargar la aplicación **mydlink** para su dispositivo Android o iOS.

4



Usuarios nuevos: Pulse **Registrarse** para registrarse en una cuenta mydlink y pulse **Añadir un dispositivo** para instalar su cámara. Continúe para seguir las instrucciones en pantalla.

o bien



Usuarios existentes: Inicie sesión con su cuenta mydlink y pulse el icono situado en el vértice superior izquierdo; a continuación, pulse **Añadir un dispositivo** para comenzar el asistente de configuración. Continúe para seguir las instrucciones en pantalla.

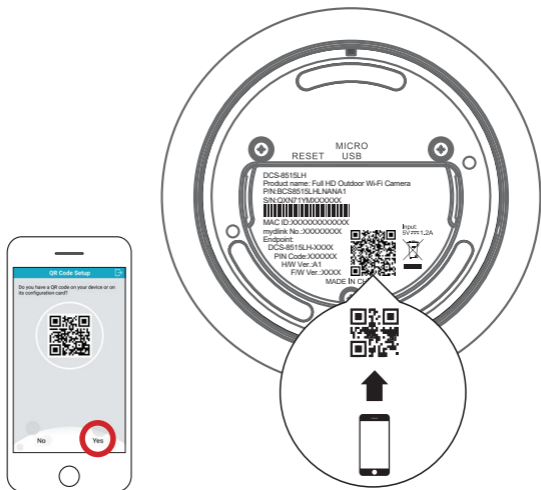

Cuando se le indique, seleccione "Sí" para leer el código QR situado en la parte inferior de la cámara; a continuación, siga las instrucciones en pantalla para completar el proceso de instalación.

6

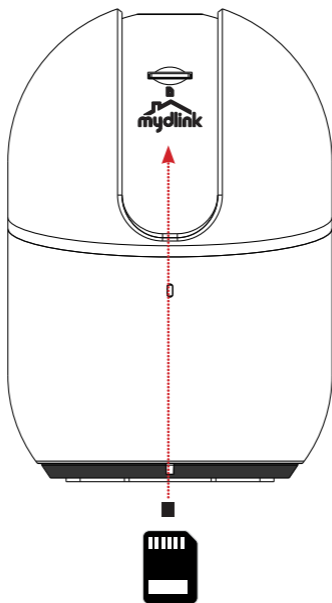

Mueva la pieza del objetivo hacia arriba para dejar de ocultar la ranura de tarjeta SD. Donde se puede insertar una tarjeta microSD para guardar grabaciones de vídeo.

Nota: Use la aplicación mydlink para inclinar la cámara hacia arriba y descubrir la ranura.



Requisitos mínimos

Para instalar este producto, necesitará:

- Un router inalámbrico 802.11 g/n
- Una conexión a Internet
- La versión más reciente de la aplicación mydlink de App Store o Google Play. Consulte la página del almacén de aplicaciones para comprobar si el dispositivo es compatible.
- Una cuenta de correo electrónico (necesaria para registrar el servicio mydlink)



Instrucciones de montaje de la cámara

ESPAÑOL

Paso 1:

Coloque la montura en la ubicación que desee, asegurándose de que la ubicación del hilo del cable de alimentación también se encuentre en la ubicación deseada. Utilice un lápiz para marcar los orificios.

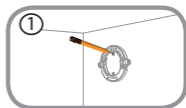

Paso 2:

Con una broca de 6 mm, practique dos agujeros de 25 mm de profundidad sobre las marcas del lápiz. Para una pared de yeso, pladur u hormigón, inserte tacos de plástico primero para apoyar los tornillos.

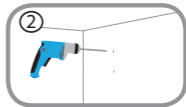

Paso 3:

Coloque la montura sobre los orificios situados en la pared. Asegúrese de alinear los orificios de la montura con los orificios de la pared. Utilice los tornillos suministrados para acoplar la montura a la superficie de la pared.

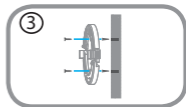

Paso 4:

Alinee la parte inferior de la cámara con los hilos de la montura. Asegúrese de que la cámara se fija correctamente a su lugar.

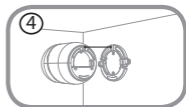







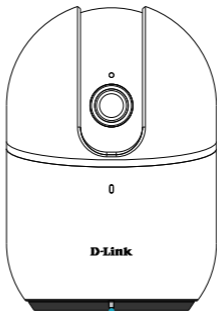

Información de la cámara LED

DCS-8515LH



LED de estado

-  Arranque del sistema / Reinicio de fábrica
-  Actualización de firmware
-  Bluetooth habilitado
-  Emparejamiento BLE / Listo para la instalación
-  Conexión inalámbrica realizada
-  Se están transmitiendo datos

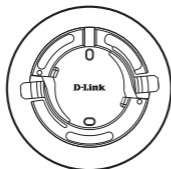
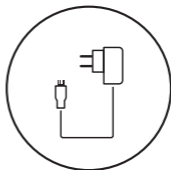

1

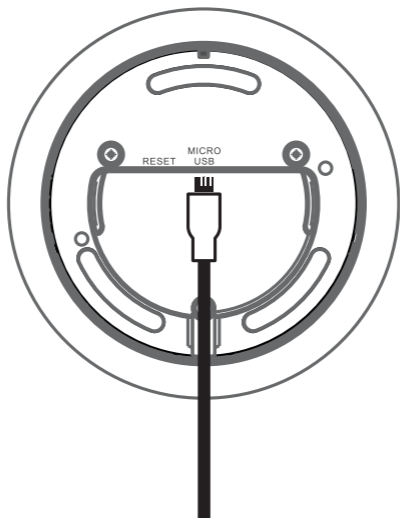

Collegare l'adattatore di alimentazione USB fornito alla porta di alimentazione, alla base della telecamera, ruotando correttamente il cavo.

2

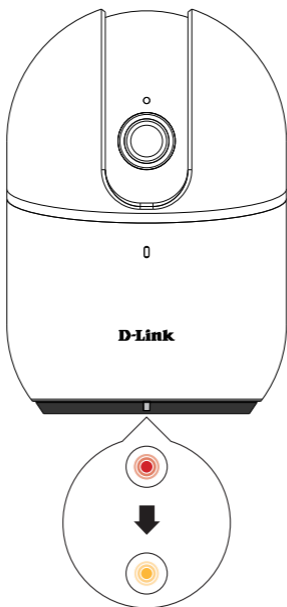

Dopo l'accensione, la telecamera ruoterà a destra e a sinistra e in alto e in basso per la calibrazione. Attendere fino a quando il LED sulla parte anteriore cambia da rosso ad arancione lampeggiante.

3



Scansionare il codice QR indicato sopra per scaricare la app **mydlink** per il dispositivo Android o iOS.

4



Nuovi utenti: Toccare **Registrati** per registrare un account mydlink, quindi toccare **Aggiungi un dispositivo** per installare la camera. Continuare seguendo le istruzioni sulla schermata.

OPPURE



Utenti esistenti: Accedere utilizzando l'account mydlink e toccare l'icona in alto a sinistra, quindi toccare **Aggiungi dispositivo** per avviare la procedura guidata di configurazione. Continuare seguendo le istruzioni sulla schermata.

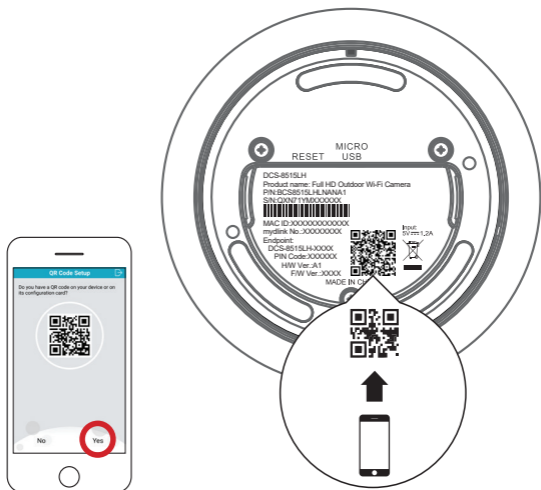

Quando richiesto, selezionare "Sì" per scansionare il codice QR alla base della telecamera, quindi continuare a seguire le istruzioni su schermo per completare il processo di configurazione.

6

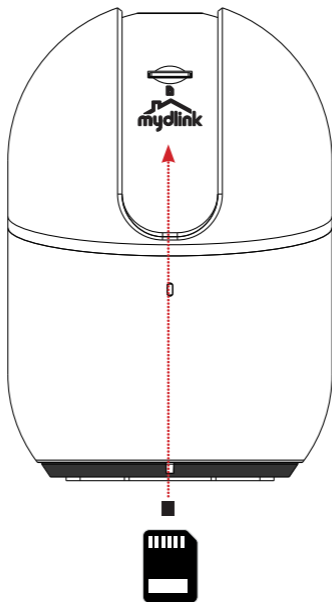

Spostare la parte dell'obiettivo in alto per mostrare lo slot della scheda SD. Posizione in cui inserire una scheda microSD per salvare le registrazioni video.

Nota: usare l'app mydlink per inclinare la camera fino a vedere lo slot.



Requisiti minimi

Per installare questo prodotto, è necessario:

- Un router wireless 802.11 g/n
- Una connessione a Internet
- L'ultima versione dell'app mydlink da App Store o Google Play. Per verificare la compatibilità del dispositivo, fare riferimento alla pagina dello store dell'app per dispositivi mobili.
- Account e-mail (necessario per la registrazione al servizio mydlink)



Istruzioni per il montaggio della videocamera

Fase 1:

Posizionare il montaggio sul punto desiderato, verificando anche la posizione della filettatura del cavo di alimentazione. Usare una matita per contrassegnare i fori.

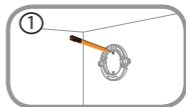

Fase 2:

Utilizzando un trapano con punta da 6 mm, fare due fori di 25 mm di profondità in corrispondenza dei segni con la matita. Su pareti in intonaco, cartongesso o calcestruzzo, inserire gli ancoraggi in plastica per sostenere le viti.

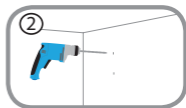

Fase 3:

Collocare la base di montaggio sui fori praticati sulla parete. Allineare i fori della base di montaggio con i fori sulla parete. Utilizzare le viti fornite per fissare la base di montaggio alla superficie della parete.

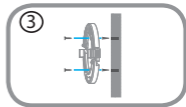

Fase 4:

Allineare la base della telecamera alle filettature sul montaggio. Verificare che la telecamera sia inserita correttamente in posizione.

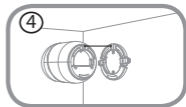





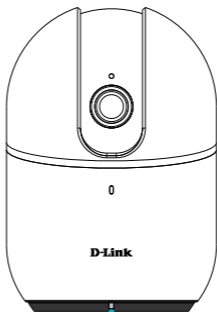



Informazioni LED videocamera DCS-8515LH



LED di stato

-  Avvio di sistema/Ripristino di fabbrica
-  Aggiornamento firmware
-  Bluetooth abilitato
-  Associazione BLE / Pronto per la configurazione
-  Wireless connesso
-  Trasferimento dati in corso

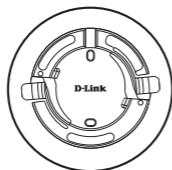
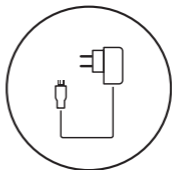

1

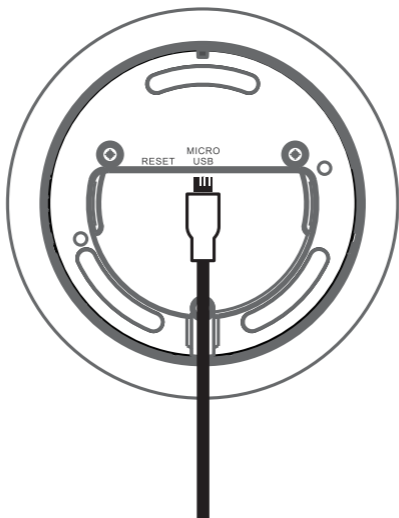

Sluit de meegeleverde USB-voedingsadapter aan op de voedingsuitgang onderaan op de camera en zorg ervoor dat de kabel goed geplaatst is.

2

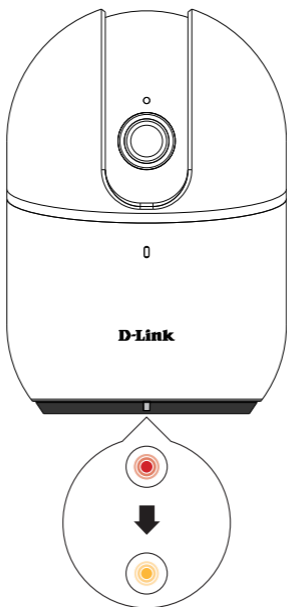

Zodra de camera is ingeschakeld, zal hij naar links, rechts, boven en onder draaien om zich te calibreren. Wacht tot het ledlampje aan de voorkant van rood naar oranje knippert.

3



Scan de bovenstaande QR-code om de **mydlink**-app voor uw Android- of iOS-apparaat te downloaden.

4



Nieuwe gebruikers: Tik op **Registreren** om een mydlink-account te registreren en tik vervolgens op **Apparaat toevoegen** om uw camera te installeren. Volg de instructies op het scherm.

OF



Bestaande gebruikers: Meld u aan met uw mydlink-account, tik linksboven op het pictogram en vervolgens op **Apparaat toevoegen** om de installatiewizard te starten. Volg de instructies op het scherm.

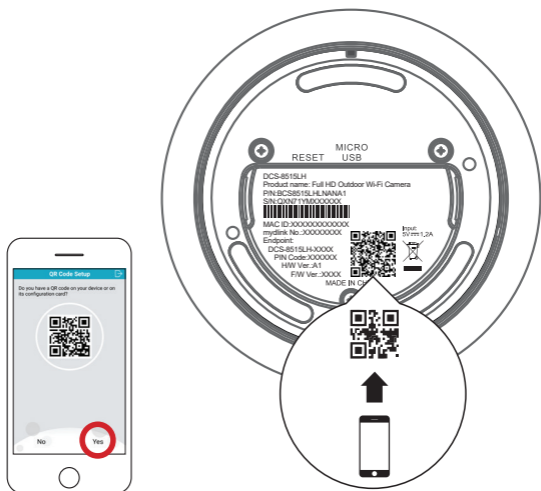

Wanneer u daarom wordt gevraagd, selecteert u "Ja" om de QR-code op de onderkant van de camera te scannen. Volg vervolgens de scherm instructies om het installatieproces te voltooien.

6

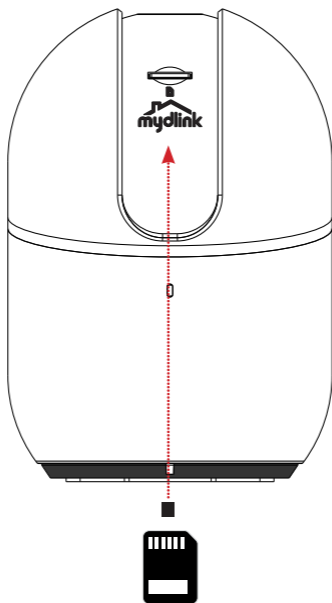

Duw het lensgedeelte omhoog om de SD-kaartsleuf zichtbaar te maken. Waarin een microSD-kaart kan worden ingestoken om video-opnames op te slaan.

Opmerking: gebruik de mydlink app om de camera omhoog te kantelen en de sleuf zichtbaar te maken.



Minimale vereisten

Om dit product te installeren hebt u het volgende nodig:

- een 802.11 g/n draadloze router;
- een internetverbinding;
- de laatste versie van de mydlink app uit de App Store of Google Play. Raadpleeg de pagina in de app-store om te controleren of uw apparaat compatibel is;
- een e-mailaccount (nodig om te registreren voor de mydlink-service)



Cameramontage-instructies

Stap 1:

Plaats de basisplaat op de gewenste locatie en zorg ervoor dat de voedingskabeluiteinde zich op de gewenste plaats bevindt. Gebruik een potlood om de gaten te markeren.

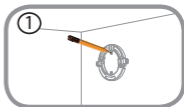

Stap 2:

Boor met een 6 mm-boortje twee 25 mm diepe gaten ter hoogte van de potloodmarkeringen. In bepleisterde wanden, gipsplaten of betonnen wanden plaatst u eerst kunststof schroefpluggen.

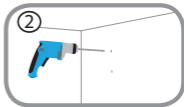

Stap 3:

Plaats de basisplaat over de gaten in de wand. Plaats de openingen in de basisplaat in het verlengde van de gaten in de wand. Gebruik de meegeleverde schroeven om de basisplaat op het wandoppervlak te bevestigen.

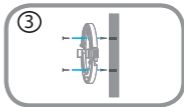

Stap 4:

Lijn de onderkant van de camera uit met de uitsparingen in de basisplaat. Zorg ervoor dat de camera stevig op zijn plaats zit.

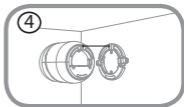





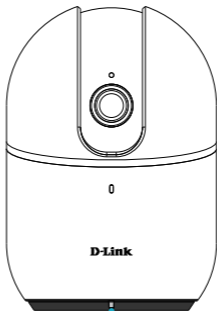



Informatie over het cameraledlampje DCS-8515LH



Statusledlampje

-  Systeem booten / fabrieksinstellingen terugzetten
-  Firmware wordt bijgewerkt
-  Bluetooth ingeschakeld
-  BLE pairing / Gereed voor installatie
-  Draadloos verbonden
-  Gegevens worden overgedragen

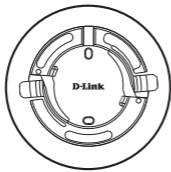
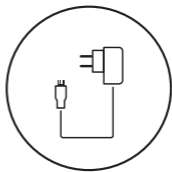

1

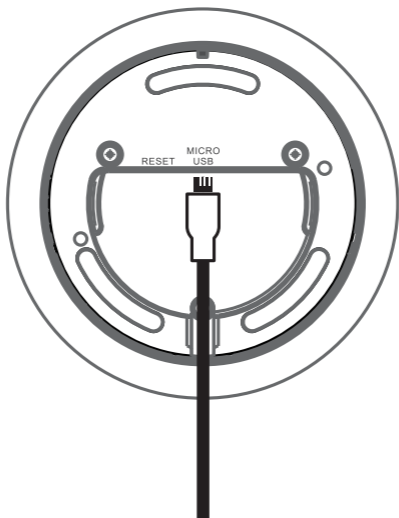

Podłącz dołączony w zestawie zasilacz USB do gniazda zasilania u dołu kamery, sprawdzając prawidłowe prowadzenie kabla.

2

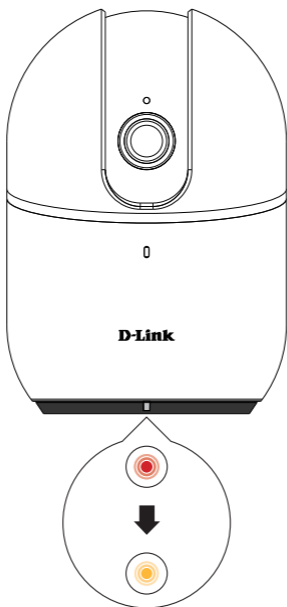

Po włączeniu kamera wykona obrót w prawo i w lewo oraz w górę i w dół w celu kalibracji. Poczekaj aż dioda LED z przodu zmieni światło z czerwonego na migające pomarańczowe.

3



Zeskanuj powyższy kod QR, aby pobrać aplikację **mydlink** na swoje urządzenie z systemem Android lub iOS.

4



Nowi użytkownicy: Dotknij **Zarejestruj się**, aby zarejestrować nowe konto mydlink, następnie dotknij **Dodaj urządzenie**, aby zainstalować swoją kamerę. Postępuj zgodnie z instrukcjami wyświetlanymi na ekranie.

LUB



Bieżący użytkownicy: Zaloguj się, używając swojego konta mydlink, i dotknij ikonę z lewej strony u góry, a następnie dotknij **Dodaj urządzenie**, aby uruchomić kreatora konfiguracji. Postępuj zgodnie z instrukcjami wyświetlanymi na ekranie.

5

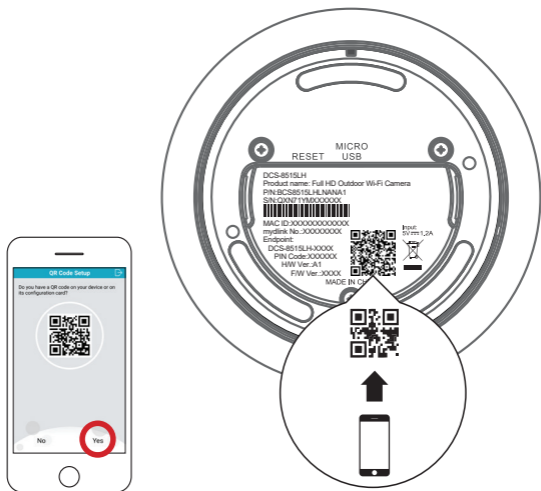

POLSKI

Po wyświetleniu monitu wybierz przycisk „Tak”, aby zeskanować kod QR u dołu kamery, następnie dokończ proces konfiguracji, wykonując wyświetlane instrukcje.

6

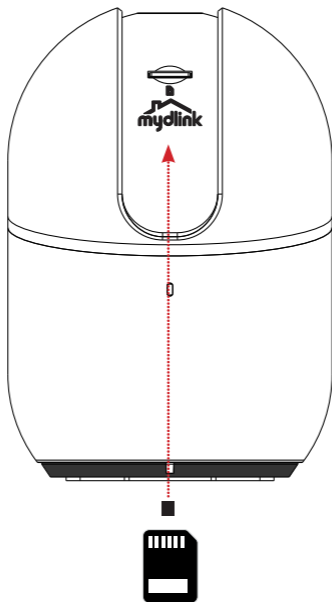

Przesuń obiektyw w górę, aby odsłonić gniazdo karty SD. Gniazdo na kartę microSD, na której można zapisywać nagrania wideo.

Uwaga: Użyj aplikacji mydlink w celu pochylenia kamery i odsłonięcia gniazda.



Wymagania minimalne

Do zainstalowania tego produktu potrzebne są:

- Router bezprzewodowy 802.11 ac/g/n
- Połączenie internetowe
- Najnowsza wersja aplikacji mydlink z serwisu App Store lub Google Play. Zgodność swojego urządzenia możesz sprawdzić na stronie aplikacji w sklepie.
- Konto poczty e-mail (wymagane do rejestracji w usłudze mydlink)



Instrukcja montażu kamery

Krok 1:

Przyłóż uchwyt montażowy w żądanym miejscu, upewniając się, że przebieg przewodu zasilającego jest zorientowany właściwie. Zaznacz otwory ołówkiem.

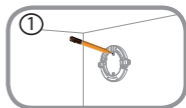

Krok 2:

Przy użyciu wiertła o średnicy 6 mm wywierć w oznaczonych ołówkiem miejscach dwa otwory na głębokość 25 mm. W przypadku ścian murowanych, z płyt gipsowo-kartonowych lub betonowych włóż w wywiercone otwory kołki z tworzywa sztucznego w celu wkręcenia w nie wkrętów.

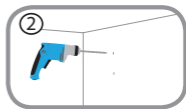

Krok 3:

Przyłóż uchwyt montażowy do otworów w ścianie. Wyrównaj otwory w uchwycie z otworami w ścianie. Użyj dostarczonych wkrętów w celu przykręcenia uchwytu do ściany.

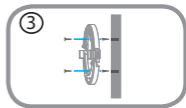

Krok 4:

Wyrównaj spód kamery z otworami w podstawie. Sprawdź, czy kamera jest bezpiecznie zamocowana.

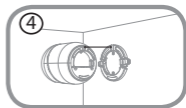





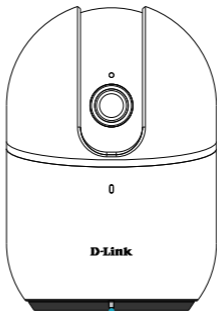



Kontrolki LED kamery DCS-8515LH



Dioda LED stanu

-  Uruchamianie systemu / resetowanie do ustawień fabrycznych
-  Aktualizacja firmware
-  Włączona komunikacja Bluetooth
-  Parowanie BLE / gotowość do konfiguracji
-  Połączono z siecią bezprzewodową
-  Transfer danych

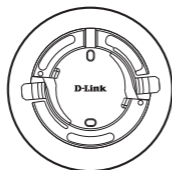
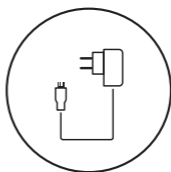

1

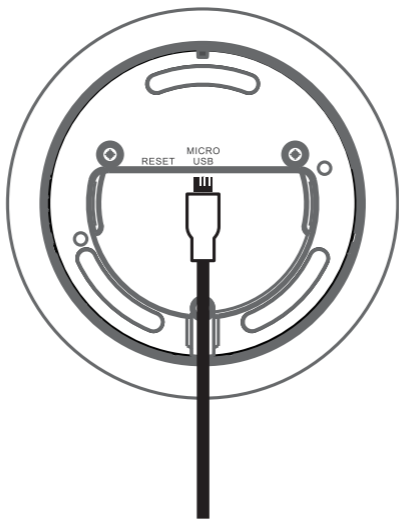

Zapojte příložený USB napájecí adaptér do napájecího portu na spodní straně kamery a ujistěte se, zda je kabel správně nasměrováný.

2



Jakmile kameru zapnete, bude se otáčet doleva a doprava a nahoru a dolů za účelem kalibrace. Vyčkejte, dokud LED kontrolka vpředu nepřestane svítit červeně a začne blikat oranžově.

3



Naskenováním QR kódů výše si stáhněte aplikaci **mydlink** pro zařízení Android nebo iOS.

4



Noví uživatelé: Klepnutím na tlačítko **Registrovat** si vytvoříte účet mydlink, poté klepnutím na možnost **Přidat zařízení** nainstalujete kameru. Pokračujte podle pokynů na obrazovce.

NEBO



Stávající uživatelé: Přihlaste se prostřednictvím svého účtu mydlink a klepněte na ikonu vlevo nahoře, poté kliknutím na možnost **Přidat zařízení** spustíte průvodce nastavením. Pokračujte podle pokynů na obrazovce.

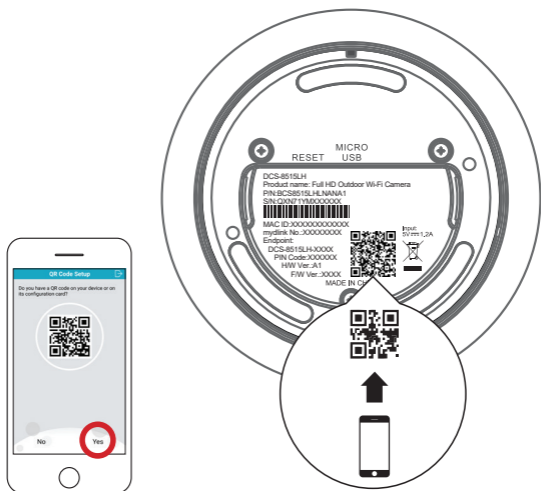

Při vyzvání vyberte možnost „Ano“ a naskenujte QR kód na spodní části kamery, poté pokračujte podle pokynů na obrazovce a dokončete proces nastavení.

6

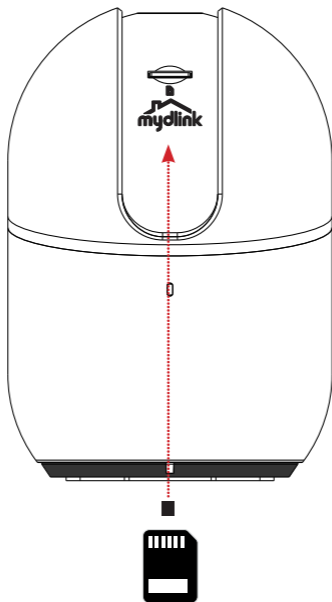

Přesunutím části objektivu nahoru odkryjete slot SD karty. Kde lze vložit kartu microSD pro ukládání videozáznamů.

Poznámka: Pomocí aplikace mydlink nakloníte kameru směrem nahoru, abyste slot zpřístupnili.



Minimální požadavky

Pro instalaci tohoto produktu budete potřebovat:

- Wi-fi router 802.11 g/n
- Připojení k internetu
- Nejnovější verzi aplikace mydlink z obchodu App Store nebo Google Play. Kompatibilitu svého zařízení ověříte na stránce obchodu aplikace.
- E-mailový účet (potřebný k registraci služby mydlink)



Pokyny k montáži kamery

Krok č. 1:

Umístěte držák do požadovaného místa a ujistěte se, že je umístění napájecí šňůry rovněž na požadovaném místě. Označte otvory pomocí tužky.

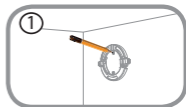

Krok č. 2:

Pomocí vrtáku o velikosti 6 mm vyvrtejte na značkách dva otvory o hloubce 25mm. V případě omítky, sádkkartonu nebo betonové zdi vložte nejdříve plastové hmoždinky pro zajištění vrutů.

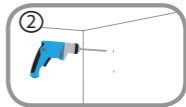

Krok č. 3:

Umístěte držák nad otvory ve zdi. Zarovnejte otvory držáku s vyvrtanými otvory ve zdi. Pomocí dodaných šroubů připevněte držák ke stěně.

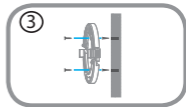

Krok č. 4:

Zadní část kamery zarovnejte s úchyty držáku. Ujistěte se, že kamera bezpečně zaklapne na místo.

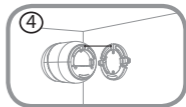





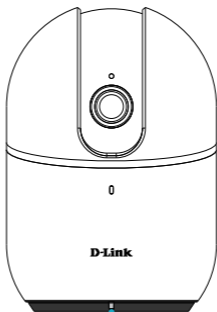



Informace o LED kontrolce kamery DCS-8515LH



Stavová LED kontrolka

-  Načítání systému / obnovení výchozího nastavení
-  Aktualizace firmwaru
-  Připojení přes Bluetooth je povoleno
-  Párování BLE / Připraveno k nastavení
-  Bezdrátová síť je připojená
-  Data se přenášejí

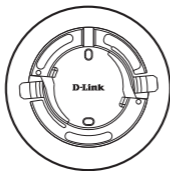
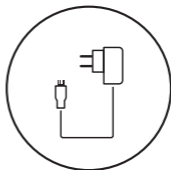

1

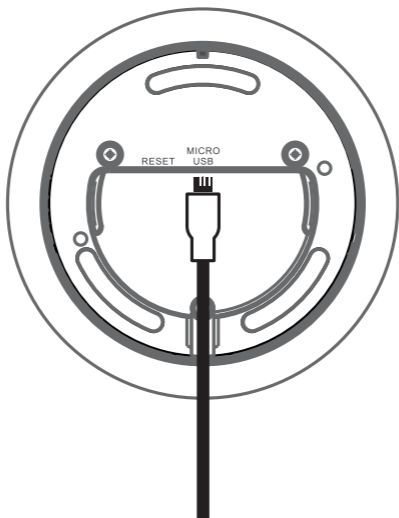

Ügyelve a kábel megfelelő vezetására dugja a mellékelt USB hálózati adapter kábelének a csatlakozódugóját a kamera alján található tápellátás csatlakozóajzatba.

2

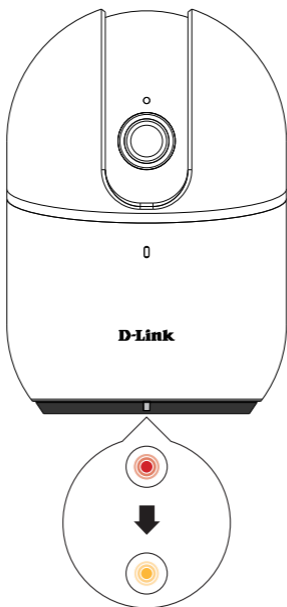

A kamera bekapcsolása után az balra és jobbra, fel- és lefelé fordul a kalibrálása elvégzésére. Várjon, amíg pirosról villogó narancsszínűre változik az elől található LED.

3



Olvassa be a fenti QR-kódot a **mydlink** alkalmazás Android vagy iOS eszközére való letöltéséhez.

4



Új felhasználók: Koppintson a **Regisztráció** gombra egy mydlink fiók regisztrálásához, majd koppintson az **Eszköz hozzáadása** menüpontra a Beállítás varázsló indításához. Hajtsa végre a megjelenő utasításokat.

VAGY



Meglévő felhasználók: Jelentkezzen be a mydlink fiókjába, kattintson a bal felső sarokban található ikonra, ezután koppintson az **Eszköz hozzáadása** menüpontra a Beállítás varázsló indításához. Hajtsa végre a megjelenő utasításokat.

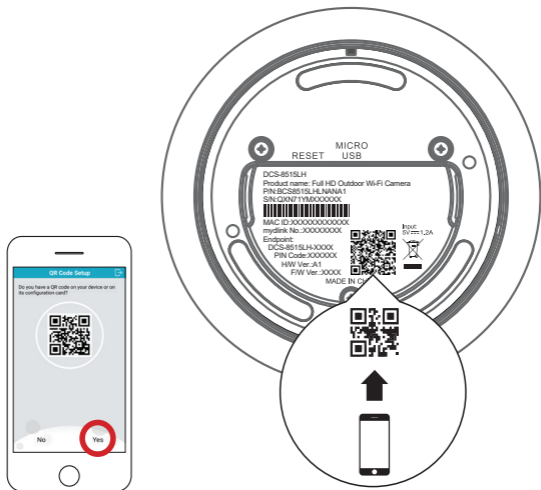

A kérés megjelenésekor válassza ki az „Igen” beállítást a kamera alján található QR-kód beolvasásához, majd a megjelenő utasítások végrehajtásával fejezze be az eljárást.

6

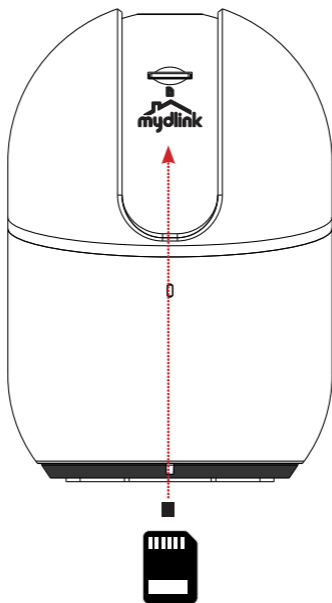

Az objektívet fölfelé mozgatva felfedheti az SD-kártya nyílását. Ahova microSD-kártya helyezhető be a videofelvételek mentéséhez.

Megjegyzés: Használja a mydlink alkalmazást a kamera fölfelé döntéséhez, hogy az aljzat láthatóvá váljon.



Minimális követelmények

A következők szükségesek e termék letöltéséhez:

- 802.11 g/n vezeték nélküli útválasztó
- Internetkapcsolat
- Az App Store vagy Google Play webáruházból származó legújabb mydlink alkalmazás verzió. Nézze meg az alkalmazásáruház weboldalát annak ellenőrzésére, hogy kompatibilis-e az eszköze.
- E-mail fiók (a mydlink szolgáltatásba regisztráláshoz szükséges)



Kamera felszerelési útmutatások

1. lépés:

Ügyelve arra, hogy a hálózati csatlakozóaljzat is legyen a közelben, tegye a tartót a kívánt helyre. Ceruzával jelölje be a furatok helyeit.

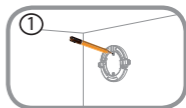

2. lépés:

6 mm-es fúrófej használatával fúrjon két 25 mm mély lyukat a ceruzajelzéseknél. Vakolt, gipszkarton vagy betonfal esetén először műanyagtipliket helyezzen el a csavarok tartására.

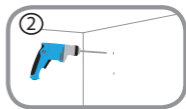

3. lépés:

Tegye a tartót a falban lévő lyukak fölé. Ügyeljen arra, hogy egy vonalban legyenek a rögzítőfuratok a falban lévő furatokkal. A mellékelt csavarokkal rögzítse az tartót a falra.

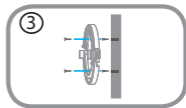

4. lépés:

Igazítsa a kamera alját a tartó meneteihez. Ügyeljen arra, hogy a kamera a helyére kattanjon.

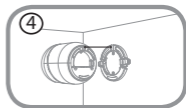



Kamera LED-információk

DCS-8515LH

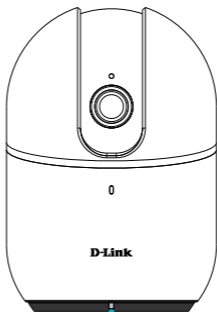

Állapot LED

-  Rendszerindítás/gyári alapbeállítás
-  Belső vezérlőprogram frissítése
-  Bluetooth engedélyezve
-  Bluetooth párosítás/beállításra kész
-  Vezeték nélkül kapcsolódva
-  Adatátvitel folyamatban

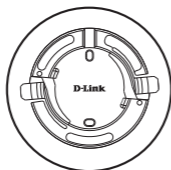
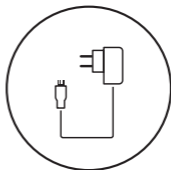

1

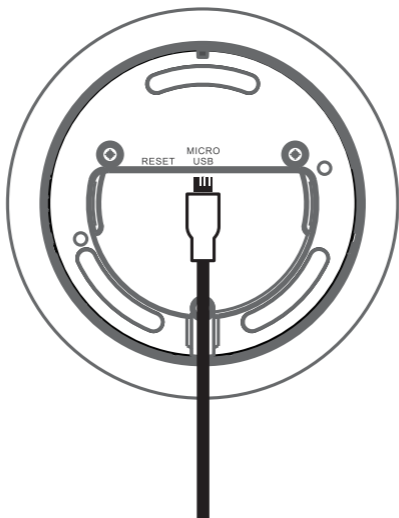

Koble til den vedlagte USB-adapteren i strømporten på undersiden av kameraet, og forsikre deg om at kabelen er ordentlig tilkoblet.

2

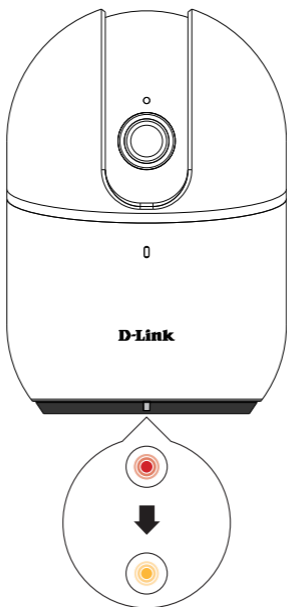

Når kameraet er slått på, roterer det til venstre og høyre og deretter opp og ned for å kalibrere seg selv. Vent til LED-indikatoren på fremsiden endrer farge fra rødt til blinkende oransje.

3



NORSK

Skann QR-koden ovenfor for å laste ned **mydlink**-appen på Android- eller iOS-enheten din.

4



Nye brukere: Trykk på **Registrer deg** for å opprette en mydlink-konto, og trykk deretter på **Legg til en enhet** for å installere kameraet ditt. Fortsett å følge instruksjonene på skjermen.

ELLER



Eksisterende brukere: Logg inn med mydlink-kontoen din og trykk på ikonet øverst til venstre. Trykk deretter på **Legg til en enhet** for å starte installasjonsveiviseren. Fortsett å følge instruksjonene på skjermen.

5

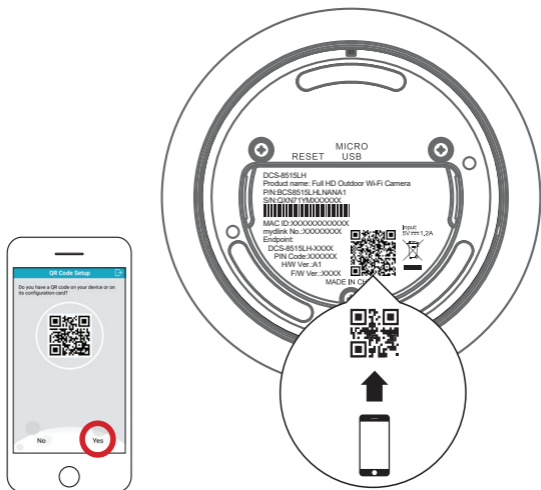

NORSK

Når du blir bedt om det, velger du «Ja» for å skanne QR-koden på undersiden av kameraet. Deretter følger du instruksjonene på skjermen for å fullføre konfigureringen.

6

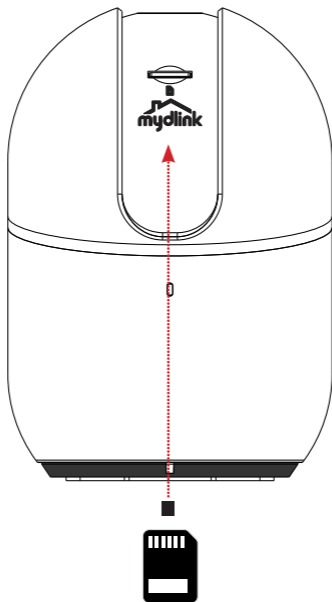

Flytt objektivdelen oppover for å avdekke SD-kortsporet. Hvor et microSD-kort kan settes inn for å lagre videoopptak.

Merk: Bruk mydlink-appen til å vende kameraet opp for å avdekke sporet.



Minstekrav

For å installere dette produktet trenger du følgende:

- En trådløs ruter av typen 802.11 g/n
- En Internett-tilkobling
- Den siste versjonen av mydlink-appen fra App Store eller Google Play. Se appens butikkside for å sjekke om enheten din er kompatibel.
- En e-postkonto (som kreves for å registrere seg for mydlink-tjenesten)



Instruksjoner for montering av kamera

Trinn 1:

Plasser monteringsfestet på ønsket sted og kontroller at hullet for strømledningen også er på riktig sted. Bruk en blyant til å merke hullene.

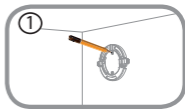

Trinn 2:

Ved hjelp av en drillbit på 6 mm borer du to 25 mm dype hull over blyantmerkene. Ved gipsvegger, tørrmur eller betongvegger setter du først inn skrueforankringene.

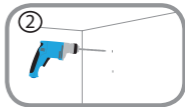

Trinn 3:

Plasser monteringsfestet over hullene i vegg. Sørg for å rette inn hullene i monteringsfestet med hullene i vegg. Bruk de vedlagte skruene til å feste monteringsfestet til veggens overflate.

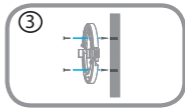

Trinn 4:

Rett inn undersiden av kameraet med hullene på monteringsfestet. Sørg for at kameraet festet trygt.

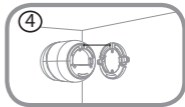





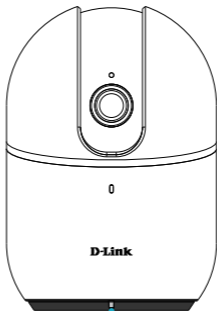



Informasjon om kameraets LED-indikatorer DCS-8515LH



Status-LED

-  Systemet starter opp / Tilbakestill til fabrikkinnstillinger
-  Oppdaterer fastvare
-  Bluetooth er aktivert
-  BLE-tilkobling / Klar til konfigurering
-  Trådløs tilkobling
-  Data blir overført

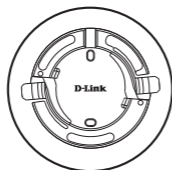
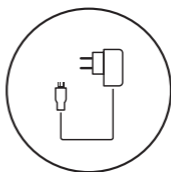

1

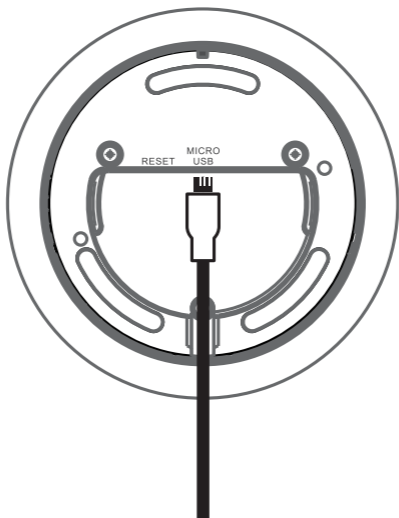

Sæt den medfølgende USB-strømadapter til strømstikket på bunden af kameraet og sørg for, at kablet er ført ordentligt.

2

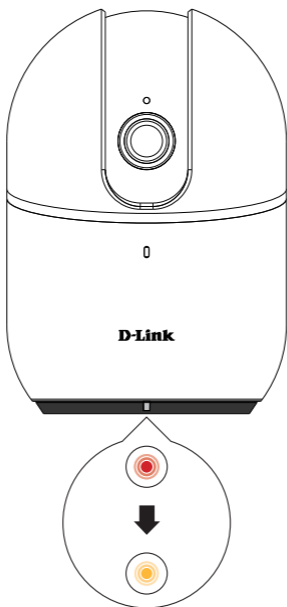

Når kameraet er tændt, vil det rotere mod venstre og højre, og bevæge sig op og ned for at kalibrere sig selv. Vent, indtil LED-lampen på forsiden skifter fra rødt til at blinke orange.

3



Scan QR-koden ovenfor for at downloade **mydlink**-appen til din Android- eller iOS-enhed.

4



Nye brugere: Tryk på **Tilmeld dig** for at oprette en mydlink-konto, og tryk så på **Tilføj en enhed** for at installere dit kamera. Fortsæt ved at følge anvisningerne på skærmen.

DANSK

ELLER



Eksisterende brugere: Log ind med din mydlink-konto og tryk på ikonet øverst til venstre, og tryk så på **Tilføj en enhed** for at starte indstillingsguiden. Fortsæt ved at følge anvisningerne på skærmen.

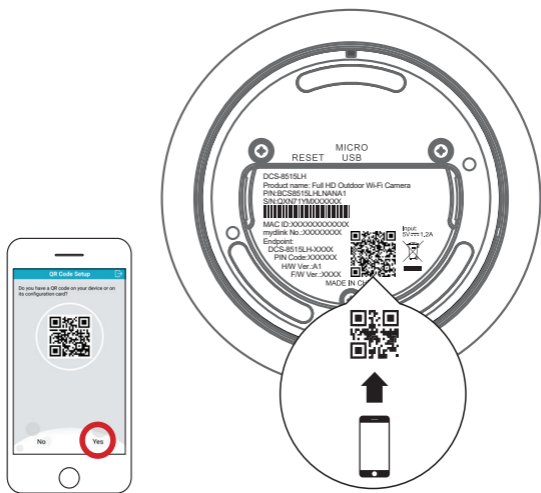

Når du bliver spurgt, så svar "Yes" for at scanne QR-koden på bunden af kameraet, og fortsæt så med at følge anvisningerne på skærmen for at færdiggøre opsætningsprocessen.

6

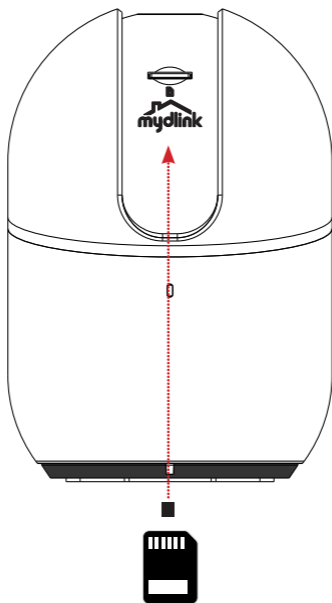

Flyt venligst linsen lidt op for at åbne ind til SD-kortspalten. Hvor et microSD-kort kan indsættes for at gemme videooptagelser.

Bemærk: Brug mydlink-app'en for at vippe kameraet op for at se korttrillen.



Mindstekrav

For at installere dette produkt har du brug for:

- En 802.11 g/n trådløs router
- En internetforbindelse
- Se nyeste version af mydlink-appen fra App Store eller Google Play. se siden om appen for at se, om din enhed er kompatibel.
- En e-mail-konto (nødvendig for at registrere hos mydlink-tjenesten)



Instruktion til montering af kamera

Trin 1:

Placer beslaget på det ønskede sted, og sørg for, at hullet til strømledningen er placeret det ønskede sted. Marker hullerne med en blyant.

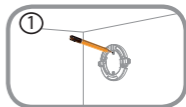

Trin 2:

Brug et 6 mm bor, bor to 25 mm dybe huller over blyantmarkeringerne. Ved vægge af puds eller beton skal der isættes plugs til at holde skruerne.

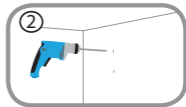

Trin 3:

Placer beslaget over hullerne i væggen. Sørg for at rette monteringshullerne ind efter hullerne i væggen. Brug de medfølgende skruer til at fastgøre beslaget til væggen.

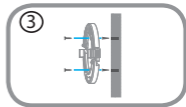

Trin 4:

Ret bunden af kameraet ind efter gevindhullerne på beslaget. Sørg for, at kameraet klikker på plades og sidder sikkert.

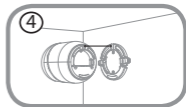





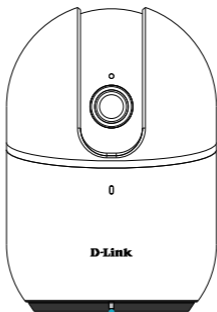



LED-oplysninger på kameraet DCS-8515LH



Status-LED

-  Genstart af system / gendannelse af fabriksindstillinger
-  Firmware opdaterer
-  Bluetooth aktiveret
-  BLE-parring / klar til opsætning
-  Trådløs forbundet
-  Der overføres data

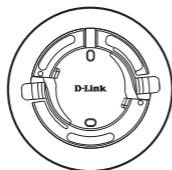
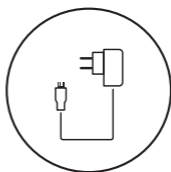

1

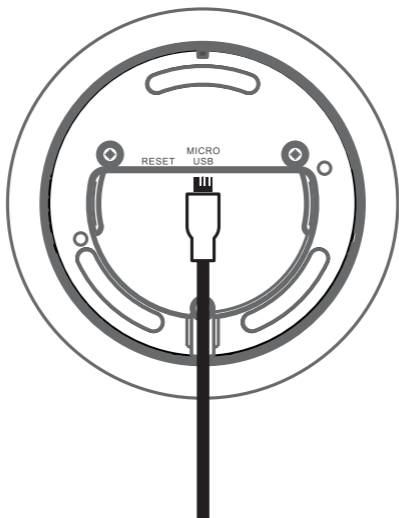

Kytke mukana toimitettu USB-virtasovitin kameran pohjassa olevaan porttiin ja varmista, että reitität kaapelin oikein.

2



Kun kamera on käynnistynyt, se kalibroi itsensä pyörimällä vasemmalle ja oikealle, ylös ja alas. Odota, kunnes edessä oleva merkkivalo muuttuu punaisesta oranssina vilkkuvaksi.

3



Lataa **mydlink**-sovellus Android- tai iOS-laitteellesi skannaamalla yläpuolella oleva QR-koodi.

4



Uudet käyttäjät: Rekisteröi mydlink-tili napauttamalla **Rekisteröidy**-painiketta ja asenna sitten kamerasi napauttamalla **Lisää laite**-painiketta. Jatka noudattamalla näytöllä olevia ohjeita.

VAIHTOEHTOISESTI



Olemissa olevat käyttäjät: Kirjaudu sisään mydlink-tilillesi ja napauta - vasemman ylläkulman kuvaketta ja sen jälkeen **Lisää laite**-painiketta, jolloin ohjattu asennustoiminto alkaa. Jatka noudattamalla näytöllä olevia ohjeita.

5

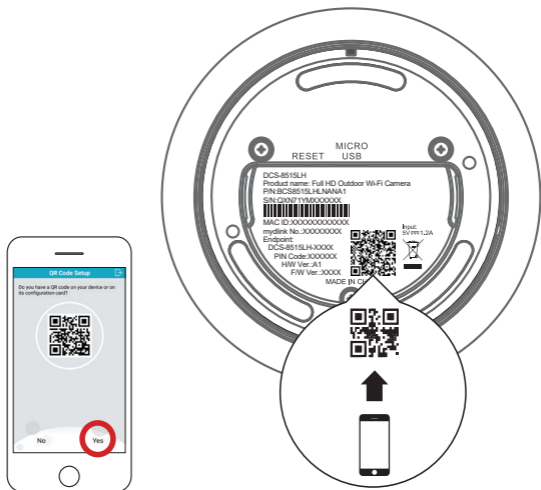

SUOMI

Kun näet kehotteen, skanna QR-koodin kameran pohjassa olevasta QR-koodista valitsemalla Kyllä ja suorita asetusprosessi loppuun näytöllä näkyvien ohjeiden avulla.

6

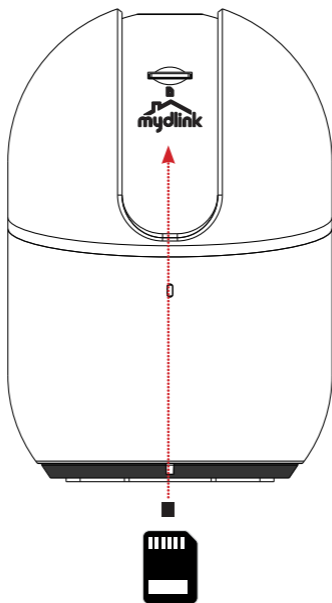

Siirrä linssiosaa ylöspäin, jotta SD-korttipaikka tulee esiin. Tähän voidaan asettaa microSD-kortti videotallenteiden tallentamista varten.

Huomautus: käytä mydlink-sovellusta kameran kallistamiseen ylöspäin, jotta rako tulee näkyviin.



Vähimmäisvaatimukset

Tämän tuotteen asentamiseen tarvittavat seuraavat:

- Langaton 802.11 g/n -reititin
- Internet-yhteys
- Viimeisin mydlink-sovellus App Store- tai Google Play -palvelusta. Katso sovelluksen sivulta, onko laitteesi yhteensopiva.
- Sähköpostitili (vaaditaan mydlink-palveluun rekisteröitymiseen)



Kameran asennusohjeet

1. vaihe:

Aseta teline haluttuun paikkaan ja varmista myös, että virtajohdon kierre on halutussa paikassa. Merkitse reikien paikat lyijykynällä.

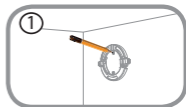

2. vaihe:

Käytä 6 mm:n poranterää ja poraa kaksi 25 mm:n reikää lyijykynällä tehtyjen merkkien kohtaan. Jos poraat reiät kipsi-, laastitta tehtyyn tai betoniseinään, aseta muoviankkurit reikiin ruuvien tueksi ennen ruuvien kiinnittämistä.

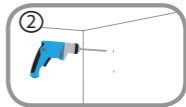

3. vaihe:

Aseta teline seinässä olevien reikien päälle. Varmista, että kohdistat kiinnitysreiät seinässä oleviin reikiin. Kiinnitä teline seinään mukana toimitettujen ruuvien avulla.

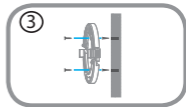

4. vaihe:

Kohdista kameran pohja telineen kierteisiin. Varmista, että kamera asettuu tukevasti paikoilleen.

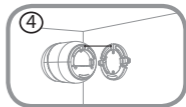







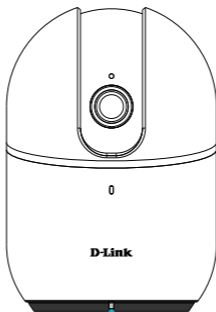

Kameran LED-valon tiedot

DCS-8515LH



Tilan merkkivalo

-  Järjestelmä käynnistyy/tehdasasetusten palautus
-  Laiteohjelmistoa päivitetään
-  Bluetooth käytössä
-  BLE-laiteparin muodostus/valmis asetukseen
-  Langaton yhteys muodostettu
-  Tietoja siirretään

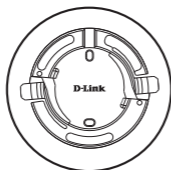
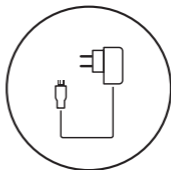

1

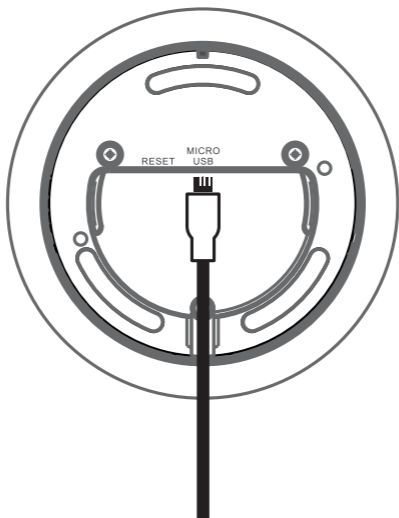

Anslut den medföljande USB-strömadaptern till strömuttaget på undersidan av kameran, se till att kabeln är rätt dragen.

2

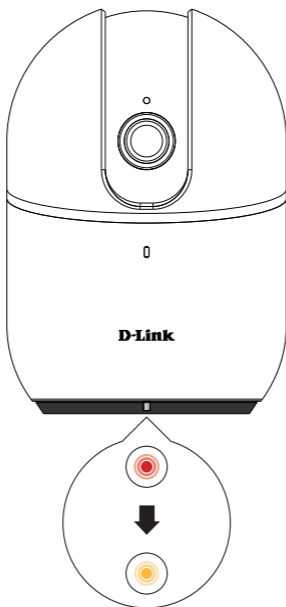

När kameran är fulladdad roterar den åt vänster och höger, upp och ner för att kalibrera sig själv. Vänta tills lysdioden på framsidan ändras från rött till blinkande orange.

3



Skanna QR-koden ovan för att ladda ner appen **mydlink** för din Android- eller iOS-enhet.

4



Nya användare: Tryck på **Registrera** för att registrera för ett mydlink-konto och tryck sedan på **Lägg till en enhet** för att installera din kamera. Fortsätt att följa anvisningarna på skärmen.

ELLER



Befintliga användare: Logga in genom att använda ditt mydlink-konto och tryck på ikonen uppe till vänster, tryck sedan på **Lägg till en enhet** för att starta installationsguiden. Fortsätt att följa anvisningarna på skärmen.

5

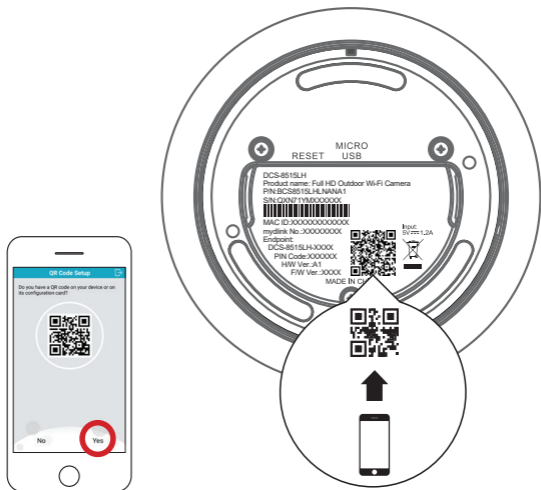

När du uppmanas väljer du "Ja" för att skanna QR-koden längst ner på kameran och fortsätt följa anvisningarna på skärmen för att slutföra installationen.

6

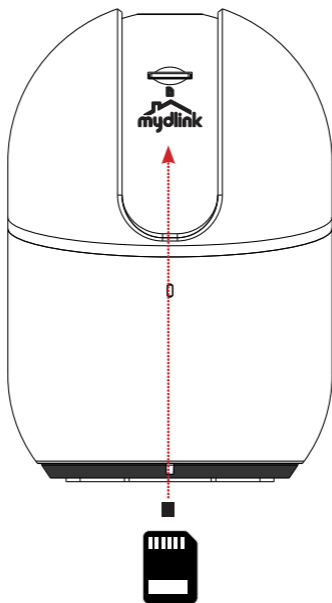

Flytta upp linsdelen för att dölja SD-kortplatsen. Där ett microSD-kort kan sättas in för att spara videoinspelningar.

Obs: Använd mydlink-appen för att luta kameran uppåt för att komma åt facket.



Minimikrav

För att installera den här produkten behöver du:

- En 802.11 g/n trådlös router
- En internetanslutning
- Den senaste versionen av appen mydlink från App Store eller Google Play.
Se appens sida i butiken för att se om din enhet är kompatibel.
- Ett e-postkonto (krävs för att registrera mydlink-tjänster)



Instruktioner för montering av kamera

Steg 1:

Placera monteringsstycket på lämplig plats, se till att platsen för nätsladden också är på önskad plats. Använd en blyertspenna för att markera hålen.

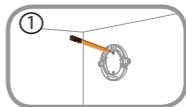

Steg 2:

Använd en 6 mm borrkrona och borra två 25 mm djupa hål över märkena som gjordes med blyertspennan. I puts-, gips- eller betongvägg ska plastpluggarna först sättas i för att ge stöd till skruvarna.

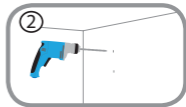

Steg 3:

Placera monteringsstycket över hålen som finns i väggen. Var noga med att justera monteringsstyckets hål mot hålen i väggen. Använd de medföljande skruvarna för att fästa monteringsstycket till väggens yta.

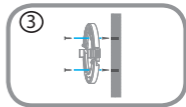

Steg 4:

Justera baksidan av kameran till gängorna på monteringsstycket. Kontrollera så att kameran har klickat fast ordentligt.

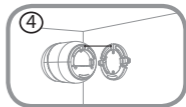



Information om kamerans lysdiod DCS-8515LH

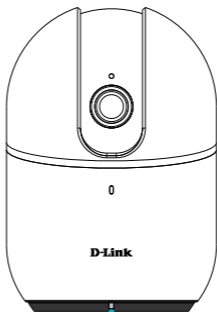

Statuslysdiod

-  Systemstart/fabriksåterställning
-  Uppdatering av inbyggd programvara
-  Bluetooth aktiverad
-  BLE-parkoppling/klar för installation
-  Trådlöst ansluten
-  Data överförs

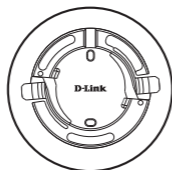
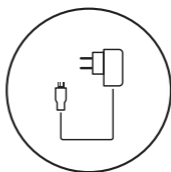

1

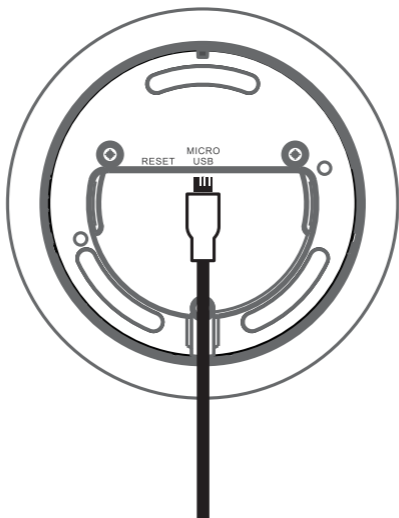

Ligue o adaptador de corrente USB incluído na porta de alimentação na parte inferior da câmara e certifique-se de que o cabo fica adequadamente encaminhado.

2

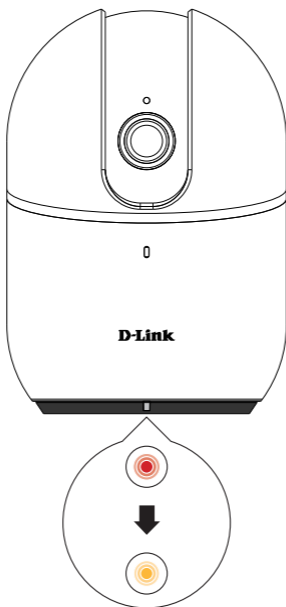

Depois de ligada, a câmara roda para a esquerda e para a direita, para cima e para baixo, para se auto-calibrar. Aguarde até que o LED (na frente) mude de vermelho para laranja intermitente.

3



Digitalize o código QR acima para descarregar a aplicação **mydlink** para o seu dispositivo Android ou iOS.

4



Novos utilizadores: Toque em **Inscriver-se** para se registar numa conta mydlink e depois toque em **Adicionar um Dispositivo** para instalar a sua câmara. Continue a seguir as instruções no ecrã.

OU



Utilizadores existentes: Inicie a sessão usando a sua conta mydlink e toque no ícone no canto superior esquerdo. De seguida, toque em **Adicionar um Dispositivo** para iniciar o assistente de configuração. Continue a seguir as instruções no ecrã.

5

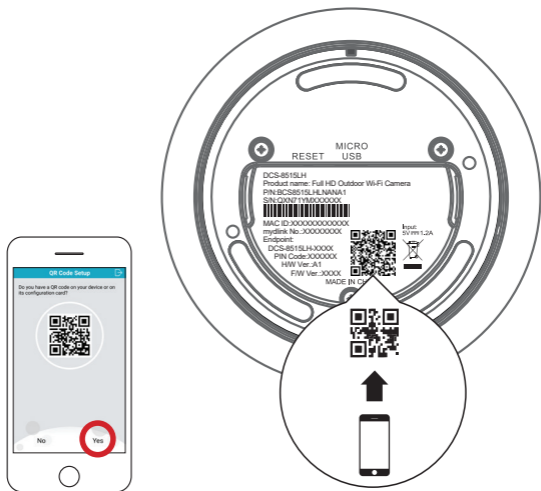

PORTUGUÊS

Quando solicitado, selecione "Sim" para digitalizar o código QR na parte inferior da câmara e depois continue a seguir as instruções no ecrã para concluir o processo de configuração.

6

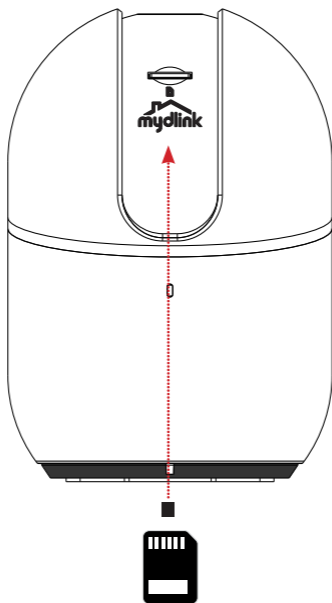

Mova a parte da lente para cima para revelar a ranhura para o cartão SD. Onde pode ser inserido um cartão microSD para guardar gravações vídeo.
Nota: Use a aplicação mydlink para inclinar a câmara para cima para mostrar a ranhura.



Requisitos mínimos

Para instalar este produto, é necessário:

- Um router 802.11 g/n sem fios
- Uma ligação à Internet
- A versão mais recente da aplicação mydlink da App Store ou Google Play. Consulte a página da App Store para verificar se o seu dispositivo é compatível.
- Conta de e-mail (necessária para o registo no serviço mydlink)



Instruções para a montagem da Câmara

Passo 1:

Posicione o suporte no local desejado, garantindo que o cabo de corrente também fica no local desejado. Use um lápis ou caneta para marcar os orifícios.

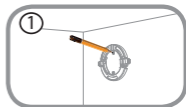

Passo 2:

Com uma broca de 6 mm, perfure dois orifícios com 25 mm de profundidade nas marcas do lápis/caneta. Para paredes de estuque, placas de gesso ou betão, introduza primeiro as buchas plásticas para suportar os parafusos.

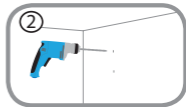

Passo 3:

Coloque o suporte por cima dos orifícios que fez na parede. Certifique-se de que os orifícios no suporte coincidem com os da parede. Use os parafusos fornecidos para apertar o suporte na superfície da parede.

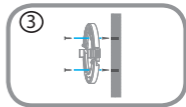

Passo 4:

Alinhe a parte inferior da câmara com os encaixes no suporte. Certifique-se de que a câmara encaixa com segurança na devida posição.

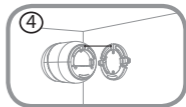





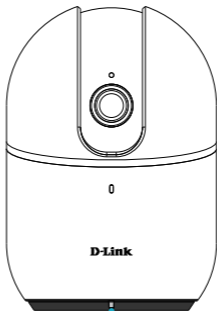



Informação de LED da Câmara DCS-8515LH



LED de estado

-  Arranque do sistema / Reposição das definições de origem
-  Atualização de Firmware
-  Bluetooth ativado
-  Emparelhamento de BLE / Pronto para configurar
-  Ligação sem fios
-  Dados a serem transferidos

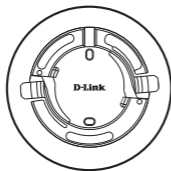
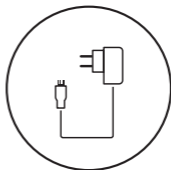

1

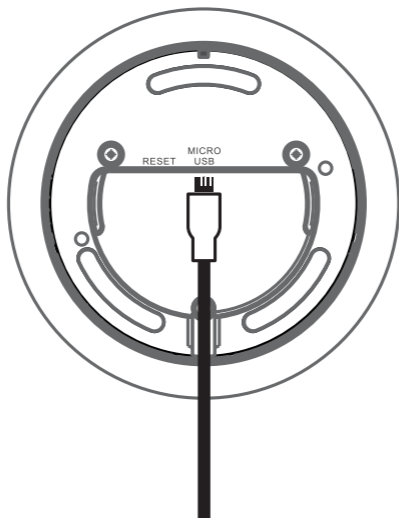

Συνδέστε τον παρεχόμενο προσαρμογέα ρεύματος USB στη θύρα παροχής ρεύματος στην κάτω πλευρά της κάμερας, φροντίζοντας να διευθετήσετε σωστά το καλώδιο.

2

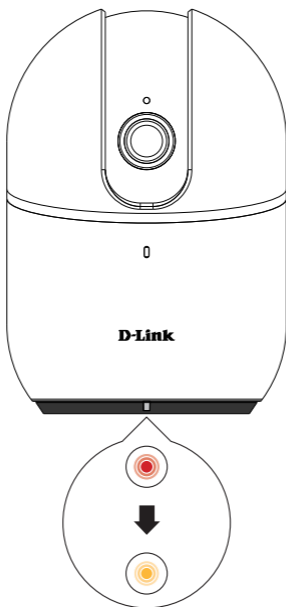

Μόλις ενεργοποιηθεί η κάμερα, θα περιστραφεί προς τα αριστερά, δεξιά, επάνω και κάτω για να βαθμονομηθεί. Περιμένετε μέχρι η ένδειξη LED στην εμπρός πλευρά να αλλάξει από κόκκινη σε αναλάμπουσα πορτοκαλί.

3



Σαρώστε τον παραπάνω κωδικό QR για να πραγματοποιήσετε λήψη της εφαρμογής **mydlink** για τη συσκευή σας, Android ή iOS.

4



Νέοι χρήστες: Πατήστε **Εγγραφή** για να εγγραφείτε για έναν λογαριασμό mydlink και κατόπιν πατήστε **Προσθήκη συσκευής** για να εγκαταστήσετε την κάμερα. Συνεχίστε ακολουθώντας τις οδηγίες στην οθόνη.

Ή



Υπάρχοντες χρήστες: Συνδεθείτε χρησιμοποιώντας τον λογαριασμό σας mydlink και πατήστε το εικονίδιο επάνω αριστερά. κατόπιν πατήστε **Προσθήκη συσκευής** για να ξεκινήσετε τον οδηγό διαμόρφωσης. Συνεχίστε ακολουθώντας τις οδηγίες στην οθόνη.

5

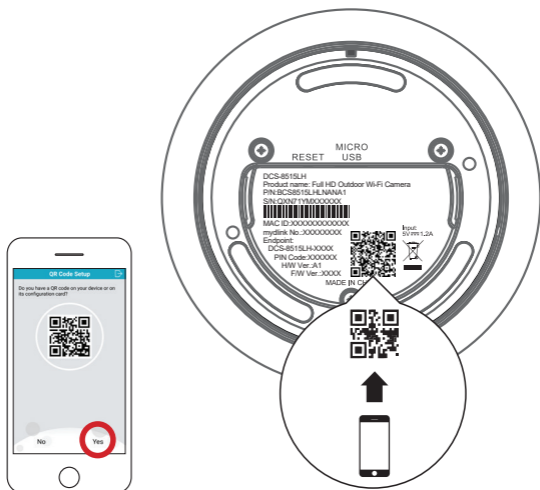

Όταν σας ζητηθεί, επιλέξτε "Ναι" για να σαρώσετε τον κωδικό QR στην κάτω πλευρά της κάμερας και κατόπιν συνεχίστε ακολουθώντας τις οδηγίες στην οθόνη για να ολοκληρώσετε τη διαδικασία διαμόρφωσης.

6

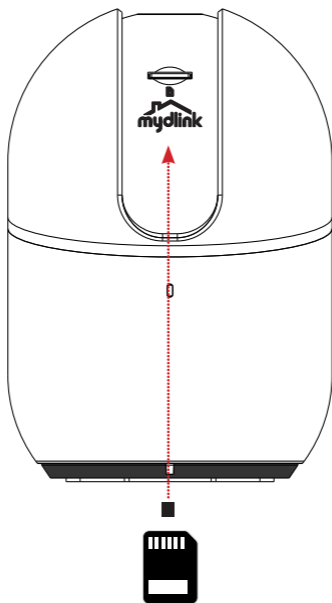

Μετακινήστε το μέρος με τον φακό προς τα επάνω για να αποκαλύψετε την υποδοχή καρτών SD. Θέση στην οποία μπορεί να εισαχθεί μια κάρτα microSD για την αποθήκευση εγγραφών βίντεο.

Σημείωση: Χρησιμοποιήστε την εφαρμογή mydlink για να στρέψετε την κάμερα προς τα επάνω ώστε να αποκαλυφθεί η υποδοχή.



Ελάχιστες απαιτήσεις

Για να εγκαταστήσετε αυτό το προϊόν, θα χρειαστείτε:

- Ασύρματο δρομολογητή 802.11 g/n
- Σύνδεση Internet
- Την πιο πρόσφατη έκδοση της εφαρμογής mydlink από το App Store ή το Google Play. Ανατρέξτε στη σελίδα του καταστήματος εφαρμογών για να ελέγξετε εάν είναι συμβατή η συσκευή σας.
- Λογαριασμό e-mail (απαιτείται για την εγγραφή στην υπηρεσία mydlink)



Οδηγίες τοποθέτησης της κάμερας

Βήμα 1:

Τοποθετήστε το πλαίσιο στην επιθυμητή θέση και βεβαιωθείτε ότι η αυλάκωση για το καλώδιο ρεύματος βρίσκεται επίσης στη σωστή θέση. Χρησιμοποιήστε ένα μολύβι για να σημειώσετε τις θέσεις των οπών.

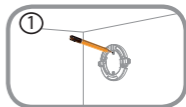

Βήμα 2:

Χρησιμοποιώντας ένα τρυπάνι με μύτη 6 χιλ., ανοίξτε δύο οπές βάθους 25 χιλ. στις θέσεις που σημειώσατε με το μολύβι. Για τοιχοποιία με σοβά, γυψοσανίδα ή σκυρόδεμα, εισάγετε πρώτα τα πλαστικά ούπα για να στηρίξετε τις βίδες.

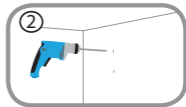

Βήμα 3:

Τοποθετήστε το πλαίσιο επάνω από τις οπές στον τοίχο. Βεβαιωθείτε ότι ευθυγραμμίζετε τις οπές στο πλαίσιο με τις οπές στον τοίχο. Χρησιμοποιήστε τις παρεχόμενες βίδες για να στερεώσετε το πλαίσιο στην επιφάνεια του τοίχου.

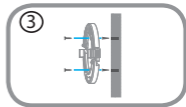

Βήμα 4:

Ευθυγραμμίστε την κάτω πλευρά της κάμερας με τις εγκοπές στο πλαίσιο. Βεβαιωθείτε ότι η κάμερα έχει "κουμπώσει" με ασφάλεια στη θέση της.

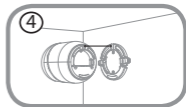





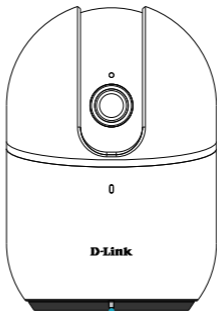



Πληροφορίες για το LED της κάμερας DCS-8515LH



Ένδειξη LED κατάστασης

-  Εκκίνηση συστήματος/Επιαναφορά σε ρυθμίσεις εργοστασίου
-  Γίνεται ενημέρωση firmware
-  Ενεργοποιήθηκε επικοινωνία Bluetooth
-  Γίνεται ζεύξη BLE/Ετοιμότητα για διαμόρφωση
-  Έγινε ασύρματη σύνδεση
-  Γίνεται μεταφορά δεδομένων

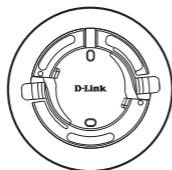
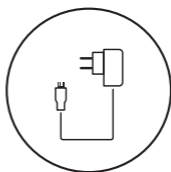

1

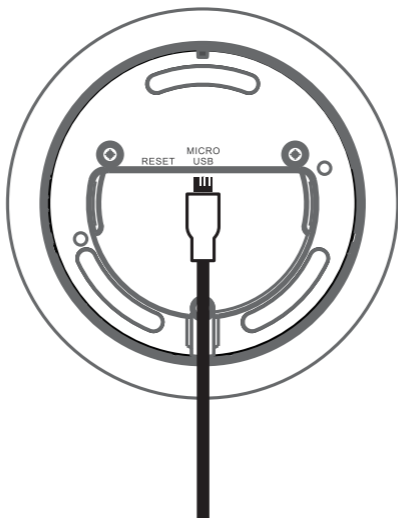

Priključite isporučeni USB strujni adapter u priključak napajanja na dnu kamere, pazeći da na odgovarajući način podesite putanju kabela.

2



Kada se kamera uključi, rotirat će lijevo i desno, gore i dolje, kako bi se kalibrirala. Pričekajte dok se boja LED lampice ne promijeni iz crvene u treperavu narančastu.

3



Skenirajte gore prikazani QR kod kako biste preuzeli **mydlink** aplikaciju za vaš Android ili iOS uređaj.

4



Novi korisnici: Dodirnite **Registracija** kako biste registrirali mydlink račun i zatim dodirnite **Dodaj uređaj** kako biste instalirali vašu kameru. Nastavite pratiti upute prikazane na zaslonu.

ILI



Postojeći korisnici: Prijavite se pomoću vašeg mydlink računa, dodirnite ikonu u gornjem lijevom kutu i zatim dodirnite **Dodaj uređaj** kako biste pokrenuli čarobnjak za postavljanje. Nastavite pratiti upute prikazane na zaslonu.

5

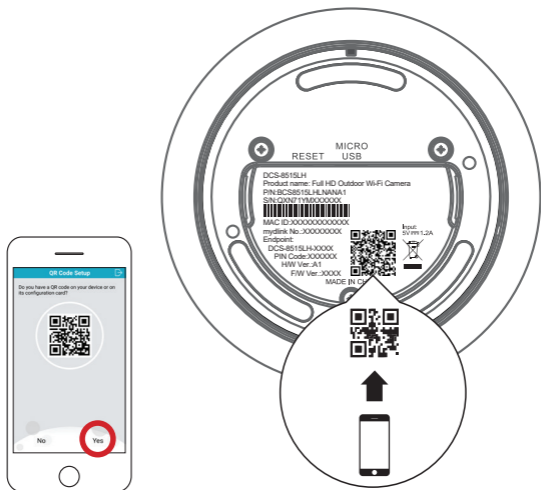

Kada to od vas bude zatraženo, odaberite „Da“ kako biste skenirali QR kod na dnu kamere, zatim nastavite pratiti upute prikazane na zaslonu kako biste dovršili postupak postavljanja.

6

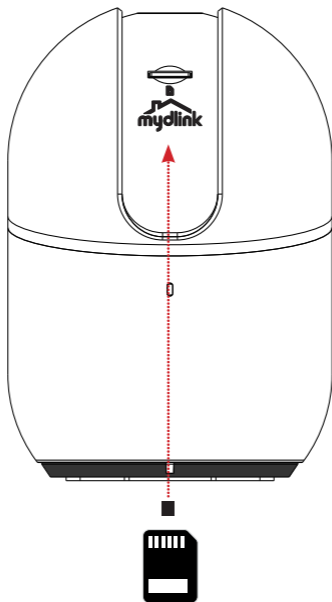

Pomjerite dio s lećom prema gore kako biste otkrili utor SD kartice. Tamo gdje microSD kartica može biti umetnuta radi spremanja video snimaka.

Napomena: Koristite mydlink aplikaciju kako biste promijenili nagib kamere prema gore radi otkrivanja utora.



Minimalni zahtjevi

Za instaliranje ovog proizvoda će vam trebati:

- 802.11 g/n bežični usmjernik
- Internetska veza
- Najnovija verzija mydlink aplikacije iz trgovina App Store ili Google Play. Pogledajte stranicu prodavaonice aplikacija kako biste provjerili je li vaš uređaj kompatibilan.
- Račun e-pošte (potreban za registraciju usluge mydlink)



Upute za montažu kamere

Prvi korak:

Postavite držač za montažu na željeno mjesto, pazeći da kabel napajanja također bude na željenom mjestu. Olovkom označite mjesta na kojima ćete izbušiti rupe.

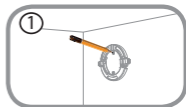

Drugi korak:

Pomoću svrdla od 6 mm izbušite dvije rupe duboke 25 mm na mjestima koja ste označili olovkom. Na zidovima od gipsa, mekog materijala ili betona, prvo umetnite plastične tiple koje će držati vijke.

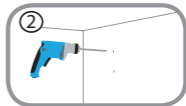

Treći korak:

Postavite držač preko rupa u zidu. Pazite da poravnate rupe na držaču s rupama u zidu. Upotrijebite isporučene vijke za pričvršćivanje držača na površinu zida.

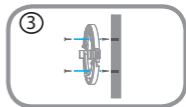

Četvrti korak:

Poravnajte dno kamere s utorima na nosaču. Uvjerite se da je kamera sigurno uskočila na svoje mjesto.

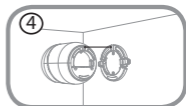





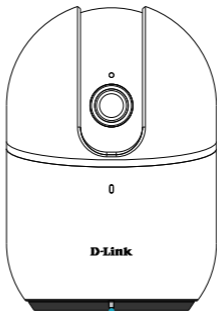



Podaci o LED lampici kamere DCS-8515LH



LED lampica stanja

-  Podizanje sustava / Resetiranje na tvorničke postavke
-  Ažuriranje firmvera
-  Bluetooth je omogućen
-  Uparivanje BLE-a / Spremno za postavljanje
-  Bežična mreža je povezana
-  Podaci se prenose

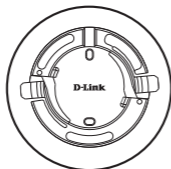
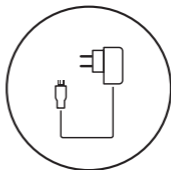

1

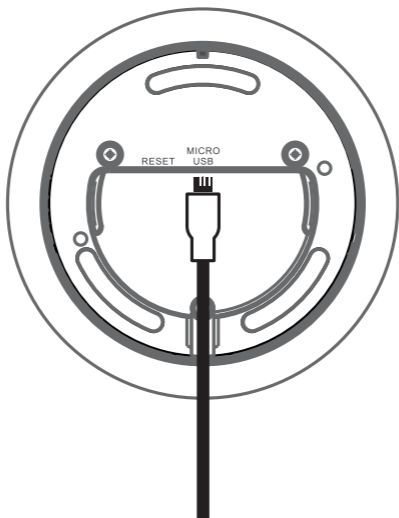

Priloženi napajalni adapter USB priključite v priključek za napajanje na spodnji strani kamere ter pazite, da pravilno obrnete kabel.

2

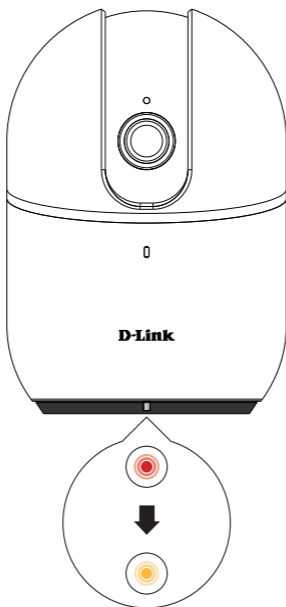

Ko se kamera vklopi, se zasuka v levo in desno ter navzgor in navzdol, da se umeri. Počakajte, da se lučka LED na sprednji strani spremeni iz rdeče v utripajočo oranžno.

3



Skenirajte zgornjo kodo QR, da prenesete aplikacijo **mydlink** za napravo Android ali iOS.

4



Novi uporabniki: Tapnite **Registracija**, da se registrirate za račun mydlink, nato pa tapnite **Dodaj napravo**, da namestite kamero. Nadaljujte z upoštevanjem zaslonskih navodil.

ALI



Obstoječi uporabniki: Prijavite se s svojim računom mydlink in tapnite ikono na zgornji levi strani, nato pa tapnite **Dodaj napravo**, da zaženete čarovnika za namestitev. Nadaljujte z upoštevanjem zaslonskih navodil.

5

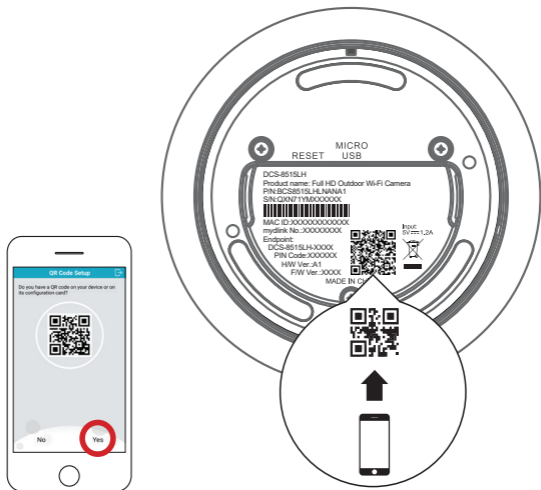

Ko se prikaže poziv, izberite »Da«, da skenirate kodo QR na dnu kamere, nato pa nadaljujte z upoštevanjem zaslonskih navodil, da dokončate postopek namestitve.

6

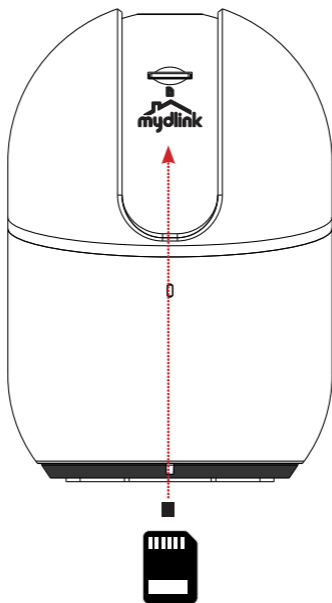

Če želite razkriti režo za kartico SD, premaknite del z lečo navzgor. Mesto vstavljanja kartice microSD za shranjevanje videoposnetkov.

Opomba: z aplikacijo mydlink nagnite kamero navzgor, da se prikaže reža.



Minimalne zahteve

Za namestitev tega izdelka potrebujete:

- brezžični usmerjevalnik 802.11 g/n,
- internetno povezavo,
- najnovejšo različico aplikacije mydlink iz trgovine App Store ali Google Play; na strani trgovine z aplikacijo preverite, ali je vaša naprava združljiva;
- e-poštni račun (za registracijo storitve mydlink).



Navodila za montažo kamere

1. korak:

Postavite podstavek na želeno mesto, pri tem pa pazite, da je na zelenem mestu tudi napajalni kabel. Luknjici označite s svinčnikom.

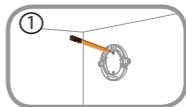

2. korak:

S 6-mm svedrom nad oznakama s svinčnikom izvrtajte 25 mm globoki luknjici. Za mavčne, suhomontažne ali betonske stene najprej vstavite plastični tok, ki podpira vijak.

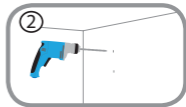

3. korak:

Podstavek postavite nad luknje v steni. Luknje na podstavku poravnajte z luknjami v steni. Uporabite priložene vijake za pritrditev podstavka na stensko površino.

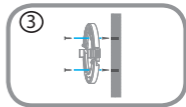

4. korak:

Spodnji del kamere poravnajte z zarezi na podstavku. Prepričajte se, da je kamera dobro pritrjena.

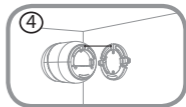





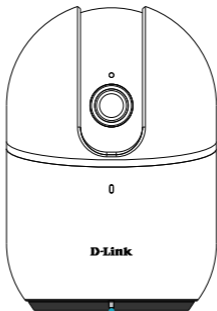



Informacije o lučkah LED kamere DCS-8515LH



LED stanja

-  Zaganjanje sistema/ponastavljanje na tovarniške vrednosti
-  Posodabljanje vdelane programske opreme
-  Funkcija Bluetooth je omogočena
-  Seznanjanje BLE/pripravljen za namestitvev
-  Brezžično omrežje je povezano
-  Poteka prenos podatkov

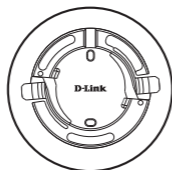
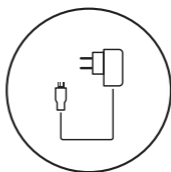

1

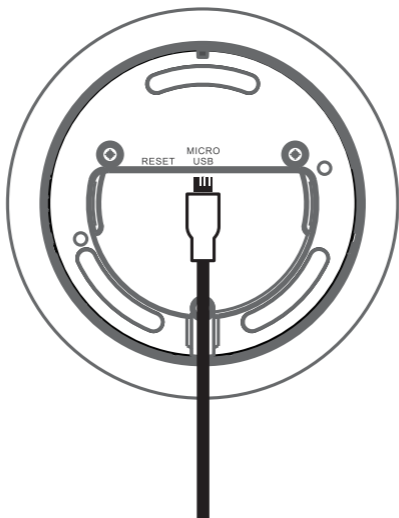

Introduceți încărcătorul USB inclus în portul de alimentare din partea de jos a camerei, asigurându-vă că așezați cablul corespunzător.

2

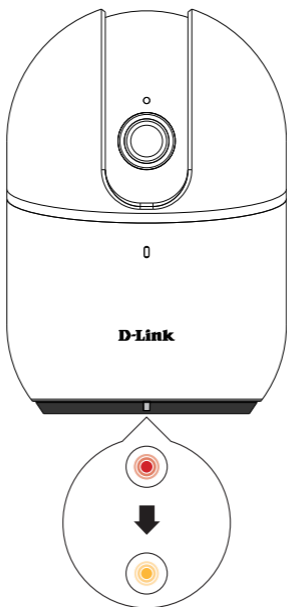

După ce camera este alimentată, se va roti la stânga și la dreapta, în sus și în jos pentru auto-calibrare. Așteptați până când LED-ul din față își schimbă culoarea din roșu în portocaliu intermitent.

3



Scanați codul QR de mai sus pentru a descărca aplicația **mydlink** pentru dispozitivul dvs. Android sau iOS.

4



Utilizatori noi: Atingeți **Înregistrare** pentru a vă înregistra pentru un cont mydlink, apoi atingeți **Adăugați un dispozitiv** pentru a instala camera. Urmați instrucțiunile de pe ecran.

SAU



Utilizatori existenți: Conectați-vă folosind contul dvs. mydlink și atingeți pictograma din stânga-sus, apoi atingeți **Adăugați un dispozitiv** pentru a începe expertul de configurare. Urmați instrucțiunile de pe ecran.

5

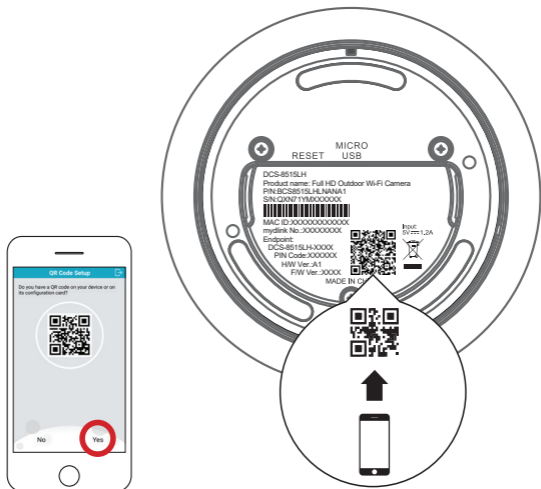

Când vi se solicită, selectați "Da" pentru a scana codul QR în partea de jos a camerei, apoi urmați instrucțiunile de pe ecran pentru a finaliza procesul de configurare.

6

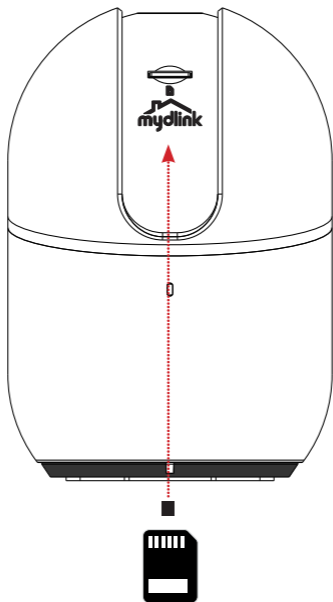

Ridicați partea lentilei pentru a descoperi nișa cardului SD. Unde se poate introduce un card microSD pentru a salva înregistrările video.

Notă: Utilizați aplicația mydlink pentru a înclina camera în sus pentru a fi vizibil slotul.



Cerințe minime

Pentru a instala acest produs, aveți nevoie de:

- Un router wireless 802.11 g/n
- O conexiune la Internet
- Ultima versiune a aplicației mydlink din App Store sau Magazinul Play. Consultați pagina aplicației mobile pentru a verifica dacă dispozitivul dvs. este compatibil.
- Un cont de e-mail (necesar pentru a vă înregistra la serviciul mydlink)



Instrucțiuni de montare cameră

Pasul 1:

Plasați suportul în locația dorită, asigurându-vă că și filetul cablului de alimentare se află în poziția dorită. Marcați orificiile cu un creion.

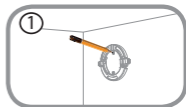

Pasul 2:

Folosind o bormașină cu un burghiu de 6 mm, faceți două găuri cu adâncimea de 25 mm în locurile marcate cu creionul. La un perete de rigips, ghips sau beton, introduceți mai întâi ancorele de plastic care vor sprijini șuruburile.

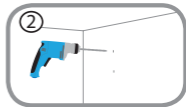

Pasul 3:

Fixați suportul de fixare peste orificiile din perete. Aliniați găurile din suportul de fixare cu cele din perete. Folosiți șuruburile din pachet pentru a prinde suportul de fixare de perete.

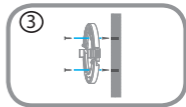

Pasul 4:

Aliniați partea de jos a camerei cu filetele de pe suportul de fixare. Asigurați-vă că camera a intrat bine la locul său.

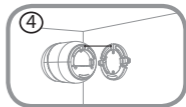





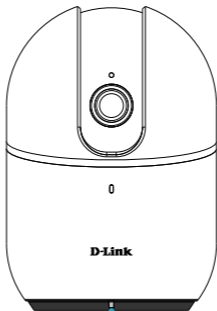



Informații LED cameră DCS-8515LH



LED stare

-  Pornire sistem / Resetare la valorile din fabrică
-  Actualizare firmware
-  Bluetooth activat
-  Asociere BLE / Pregătită de configurare
-  Wireless conectat
-  Se transferă date



TECHNICAL SUPPORT	dlink.com/support
TECHNISCHE UNTERSTÜTZUNG	
ASSISTANCE TECHNIQUE	
ASISTENCIA TÉCNICA	
SUPPORTO TECNICO	
TECHNISCHE ONDERSTEUNING	
POMOC TECHNICZNA	
TECHNICKÁ PODPORA	
TECHNICKÁ PODPORA	
TECHNIKAI TÁMOGATÁS	
TEKNISK SUPPORT	
TEKNISK SUPPORT	
TEKNISK STØTTE	
TEKNINEN TUKI	
ASSISTÊNCIA TÉCNICA	
ΤΕΧΝΙΚΗ ΥΠΟΣΤΗΡΙΞΗ	
TEHNIČKA PODRŠKA	
TEHNIČNA PODPORA	
SUPPORT TEHNIC	
ТЕХНИЧЕСКА ПОДДРЪЖКА	

