

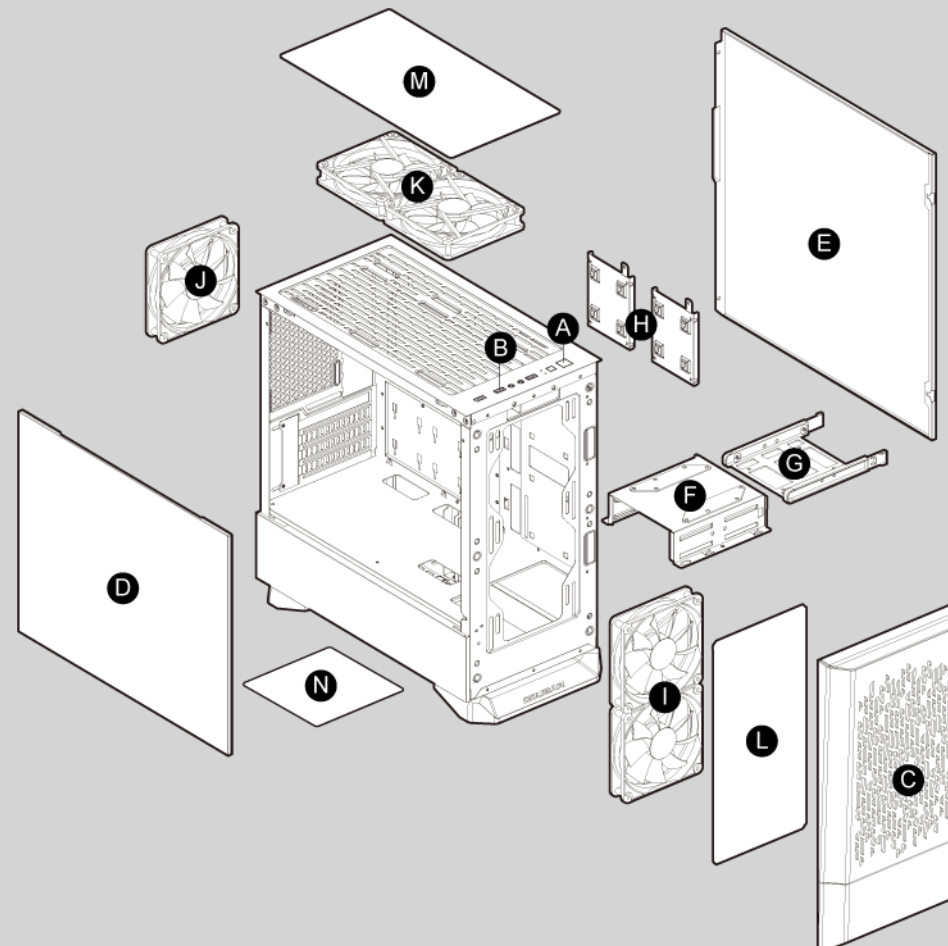

Assembly Drawing







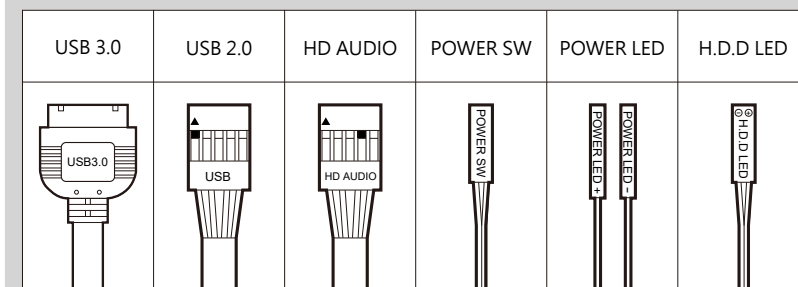















- A** Power button / RGB button
- B** USB 3.0 / USB 2.0 / HD audio ports
- C** Front panel
- D** Tempered glass side panel
- E** Right side panel
- F** 3.5" HDD cage (compatible for 2.5" HDD/SSD)
- G** 3.5" HDD tray (compatible for 2.5" HDD/SSD)
- H** 2.5" HDD/SSD trays
- I** 2 x 120mm / 2 x 140mm fans for front panel (120mm ARGB fans x 2 pre-installed)
- J** 120mm fan for rear panel (120mm ARGB fan pre-installed)
- K** 2 x 120mm / 2 x 140mm fans for top panel (optional)
- L** Air filter for front panel
- M** Air filter for top panel
- N** Air filter for bottom panel

Installing the Front I/O Connectors



ACCESSORY KIT

		Motherboard screws & 2.5" SSD screws	X 14
		Power supply screws	X 4
		3.5" HDD screws & PSU mounting bracket screws	X 11
		Stand-off for motherboard	X 1
		Fan screws	X 8
		2.5" SSD step screws (using with rubbers)	X 8
		Adapter for removing/installing stand-offs	X 1
		PSU mounting bracket (for the stability)	X 1
		Slot covers	X 1
		Cable ties	X 4

Model Name	MG140 AIR RGB (BLACK) / (WHITE)	
Model No.	CGR-5JM8B-AIR-RGB /CGR-5JM8W-AIR-RGB	
Case Form Factor	Mini Tower	
Motherboard Type	Mini ITX / Micro ATX	
Dimensions (WxHxD)	205 (W) x 410 (H) x 420 (D) mm 8.1 (W) x 16.1 (H) x 16.5 (D) in	
I/O Panel	USB 3.0 x 2, USB 2.0 x 1, Mic x 1 / Audio x 1, RGB Button	
3.5" Drive Bay	2	
2.5" Drive Bay	4+2 (converted from 3.5" drive bays) / (2 SSD trays included)	
Expansion Slots	4	
Cooling Fan Support	Front	120mm x 2 / 140mm x 2 (120mm ARGB fan x 2 pre-installed)
	Top	120mm x 2 / 140mm x 2
	Rear	120mm x 1 (120mm ARGB fan x 1 pre-installed)
Maximum Number of Fans	5 Max.	
Water Cooling Support	Front	280mm / 240mm / 140mm / 120mm
	Top	-
	Rear	120mm
Transparent Left Panel	4mm Tempered Glass	
Onboard Lighting System	Yes	
RGB Sync with M/B	Yes	
Max. Graphics Card Length	350 (mm) / 13.8 in	
Max. CPU Cooler Height	160 (mm) / 6.3 in	
Max. PSU Length	160 (mm) / 6.3 in	

Specifications might vary depending on the country or region of sale.

БЪЛГАРИЯ

• Подробни инструкции за употреба изтеглете от: <https://cougargaming.com/bg>



България QR код

ENGLISH

- Distinctive front panel with patterned air vents
- Integrated RGB system with 5V ARGB motherboard synchronization
- Support for Micro ATX / Mini ITX motherboards
- Massive tempered glass side window
- Up to 350mm graphics cards
- Up to five fans and 160mm CPU cooler
- Up to a 280mm water cooling radiator

DEUTSCH

- Markante Frontplatte mit gemusterten Lüftungsschlitzen
- Integriertes RGB-System mit 5V ARGB-Motherboard-Synchronisation
- Unterstützung für Micro ATX / Mini ITX-Motherboards
- Massives Seitenfenster aus gehärtetem Glas
- Bis zu 350 mm Grafikkarten
- Bis zu fünf Lüfter und 160 mm CPU-Kühler
- Bis zu 280 mm Wasserkühler

ESPAÑOL

- Panel frontal distintivo con salidas de aire estampadas
- Sistema RGB integrado con sincronización de placa base ARGB de 5 V
- Soporte para placas base Micro ATX / Mini ITX
- Ventana lateral de vidrio templado masivo
- Tarjetas gráficas de hasta 350 mm
- Hasta cinco ventiladores y enfriador de CPU de 160 mm
- Radiador de refrigeración por agua de hasta 280 mm

日本語

- パターン化された通気孔を備えた特徴的なフロントパネル
- 5V ARGBマザーボード同期を備えた統合RGBシステム
- MicroATX / MiniITXマザーボードのサポート
- 巨大な強化ガラスのサイドウィンドウ
- 最大350mmのグラフィックカード
- 最大5つのファンと160mmのCPUクーラー
- 最大280mmの水冷ラジエーター

PORTUGUÊS

- Painel frontal distinto com saídas de ar padronizadas
- Sistema RGB integrado com sincronização da placa-mãe 5V ARGB
- Suporte para placas-mãe Micro ATX / Mini ITX
- Janela lateral de vidro temperado maciço
- Placas gráficas de até 350 mm
- Até cinco ventiladores e cooler para CPU de 160 mm
- Radiador de refrigeração de água de até 280 mm

РУССКИЙ

- Отличительная передняя панель с узорчатыми вентиляционными отверстиями.
- Интегрированная система RGB с синхронизацией материнской платы 5V ARGB
- Поддержка материнских плат Micro ATX / Mini ITX.
- Массивное боковое окно из закаленного стекла.
- Видеокарты до 350 мм
- До пяти вентиляторов и 160-мм кулер для процессора
- Радиатор водяного охлаждения диаметром до 280 мм.

FRANÇAIS

- Pannneau avant distinctif avec bouches d'aération à motifs
- Système RVB intégré avec synchronisation de la carte mère ARGB 5V
- Prise en charge des cartes mères Micro ATX / Mini ITX
- Vitre latérale massive en verre trempé
- Cartes graphiques jusqu'à 350 mm
- Jusqu'à cinq ventilateurs et refroidisseur de processeur de 160 mm
- Jusqu'à un radiateur de refroidissement par eau de 280 mm

中文

- 前面板独特异形通风孔设计
- RGB整合系统支援5V ARGB主板灯效同步控制功能
- 支持Micro ATX / Mini ITX 主板
- 全景钢化玻璃侧窗
- 全景支持 350mm 显卡
- 最高支持5个风扇和160mm CPU散热器
- 最高支持280mm 水冷排

POLISH

- Charakterystyczny panel przedni z wzorzystymi otworami wentylacyjnymi
- Zintegrowany system RGB z synchronizacją płyty głównej 5 V ARGB
- Obsługa płyt głównych Micro ATX / Mini ITX
- Masywna szyba boczna z hartowanego szkła
- Karty graficzne do 350 mm
- Do pięciu wentylatorów i 160 mm chłodzenie procesora
- Do 280 mm chłodnicy wody chłodzącej

ITALIA

- Pannello frontale distintivo con prese d'aria a motivi geometrici
- Sistema RGB integrato con sincronizzazione scheda madre 5V ARGB
- Supporto per schede madri Micro ATX / Mini ITX
- Massiccio finestrino laterale in vetro temperato
- Schede grafiche fino a 350 mm
- Fino a cinque ventole e dispositivo di raffreddamento della CPU da 160 mm
- Radiatore di raffreddamento ad acqua fino a 280 mm

한국어

- 패턴이있는 통풍구가있는 독특한 전면 패널
- 5V ARGB 마더 보드 동기화를 지원하는 통합 RGB 시스템
- Micro ATX / Mini ITX 마더 보드 지원
- 대형 강화 유리 측면 창
- 최대 350mm 그래픽 카드
- 최대 5 개의 팬과 160mm CPU 쿨러
- 최대 280mm 수냉 라디에이터

• يجب تركيب كل قطعة بحذر و بمكانها المناسب.

• من يقوم بعملية التركيب الشخص المختص فقط.

تعليمات التركيب و الامان:

• عند التركيب أو التفكيك يجب التأكد من أن جميع الأسلاك مفصولة عن الكهرباء.

• يجب اتخاذ الاحتراوات اللازمة لمنع الصعق الكهربائي.

• يجب ارتداء الملابس المناسبة أثناء تركيب/تجميع الكمبيوتر.

COMPACT ARGB MINI TOWER CASE WITH MODERN PATTERNED AIR VENTS

We've made COUGAR PC cases even better. The new patterned air vents create a special outlook for your amazing build. Powerful airflow, mighty support for up to a 280mm radiator, a 350mm graphic card, and a 160mm CPU cooler deliver superior value for you.

PATTERNED AIR VENTS DESIGN

MG140 Air RGB's front panel features patterned air vents design. It is the chassis that integrates the new concept of minimalist aesthetic and cooling performance. The hollow areas also allow internal lighting to create mesmerizing light effects.

INCREDIBLE RGB LIGHTING

MG140 Air RGB comes with 3 ARGB fans. You are freely to control several amazing lighting effects with the dedicated RGB button. The built-in LED controller also adaptable with any compatible motherboards' 5V ARGB connection for system-wide lighting synchronization. The powerful lights come out of a stylish panel and the reflective surroundings helps reinforce the RGB effects.

TOP-NOTCH COOLING

MG140 Air RGB's compact layout allows you to install five fans, a 280mm water cooling radiator, and a 160mm CPU cooler. This immense cooling potential will enable you to choose components freely.

GREAT SUPPORT FOR COMPONENTS

Its advanced support for up to 350mm-long graphics cards, which allows you to enjoy the latest games with smooth framerates.

CLEAN AND TIDY LOOKS

With the full-length PSU cavity hides cables and a massive tempered glass left panel presents a clean and tidy build, you can easily showcase your pro-level stunning build!

GLOBAL WARRANTY POLICY

WARRANTY PERIODS OF COUGAR GAMING DEVICES

Product : COUGAR MG140 AIR RGB
Warranty : 1 Year
• This warranty gives you specific legal rights. You may also have other rights granted under local law. These rights may vary.
• Only for electrical components.

ДАТА ИЗГОТОВЛЕНИЯ ПРОДУКЦИИ

год и месяц изготовления продукции указаны в серийном номере продукта. (существует 2 способа определения даты изготовления, оба способа описаны ниже)

A После S/N: первые две цифры означают год, вторые две – месяц изготовления. Например, S/N: H1702000001 означает, что товар был произведен в феврале 2017 года.

B После S/N: если указаны буквы, то две буквы представляют цифры из таблицы ниже, и означают год, последующие две цифры – месяц изготовления. Например, S/N: DAG02REV1000001 означает, что товар был произведен в феврале 2017 года.

A	B	C	D	E	F	G	H	I	J
1	2	3	4	5	6	7	8	9	0

• Например, AG = 17 = 2017 год

Removing the side panels

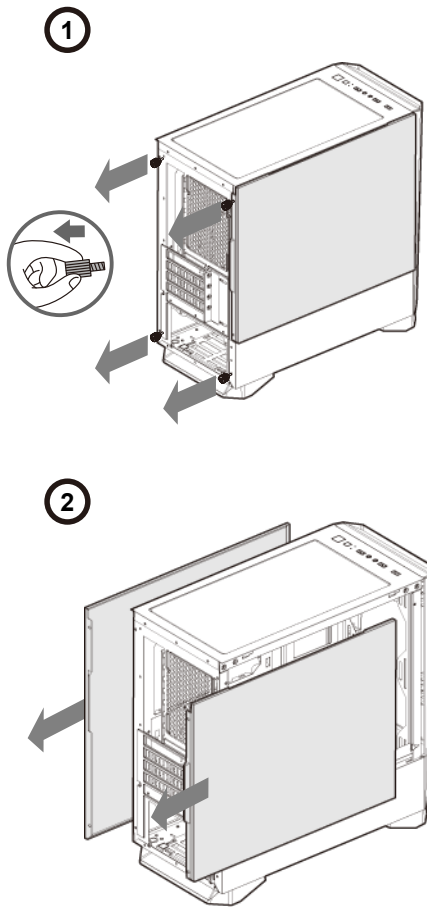

Installing water cooling radiators & cooling fans

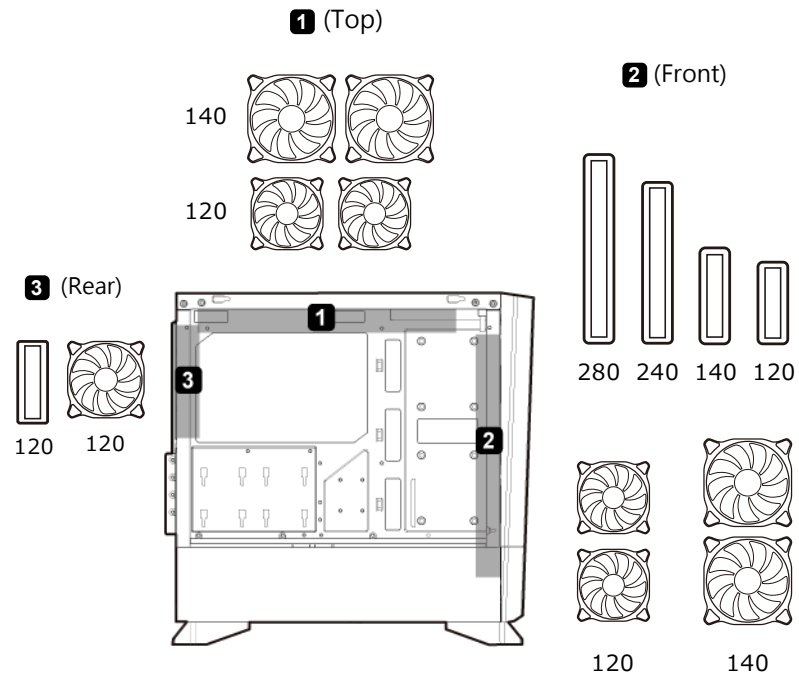

Installing 3.5" HDDs

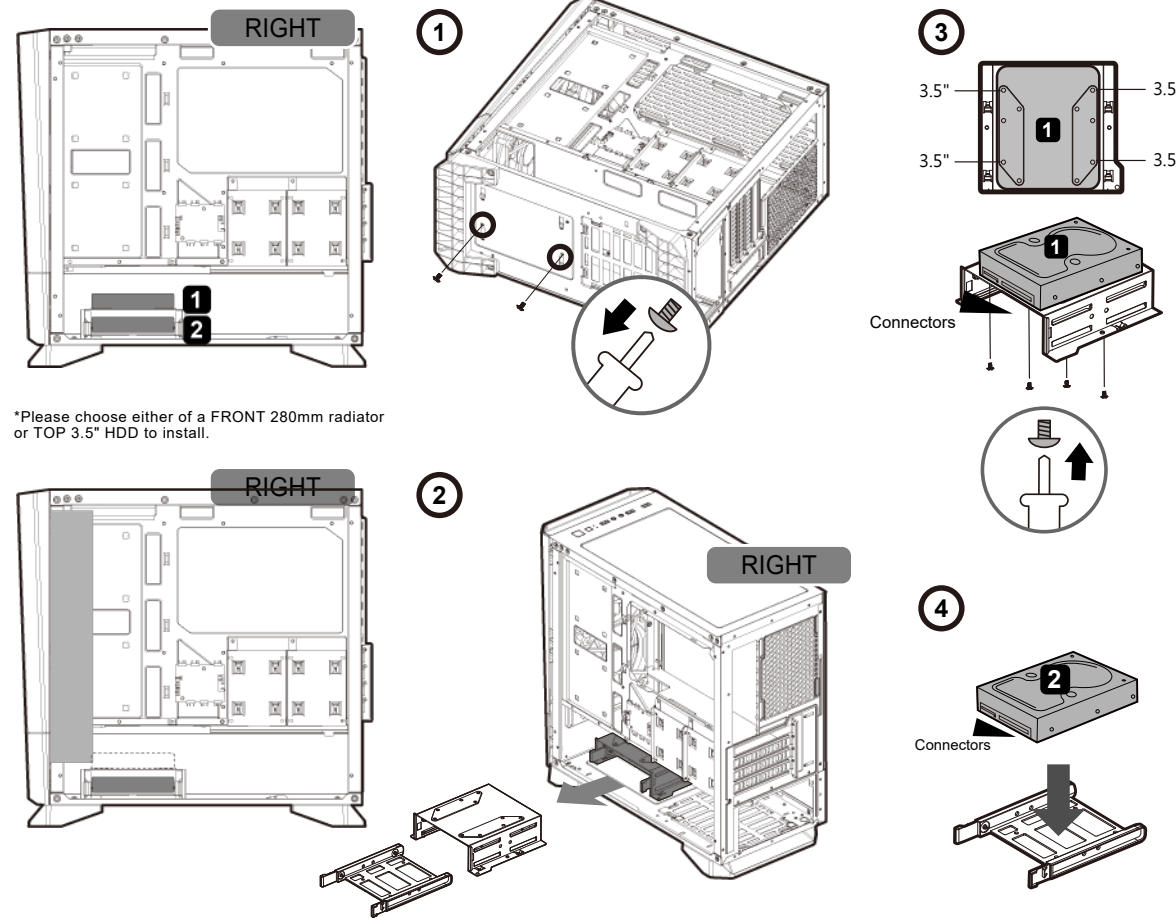

PSU mounting bracket (for the stability)

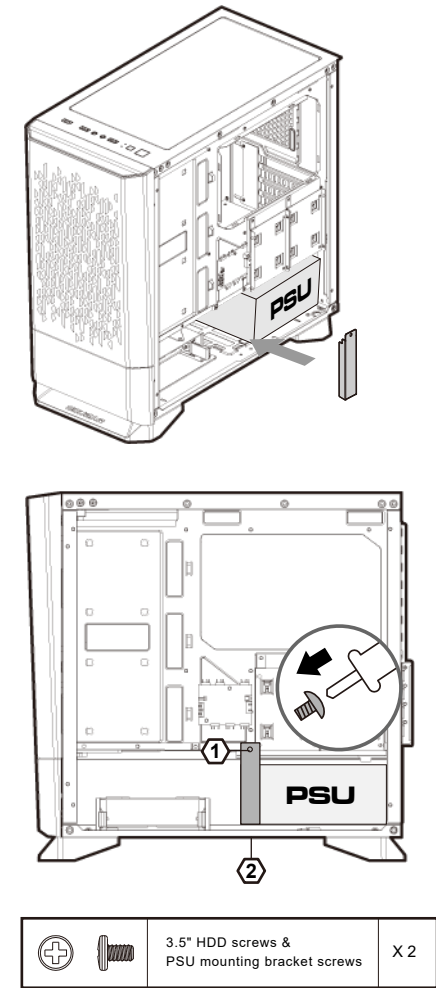

Installing 2.5" SSDs /HDDs

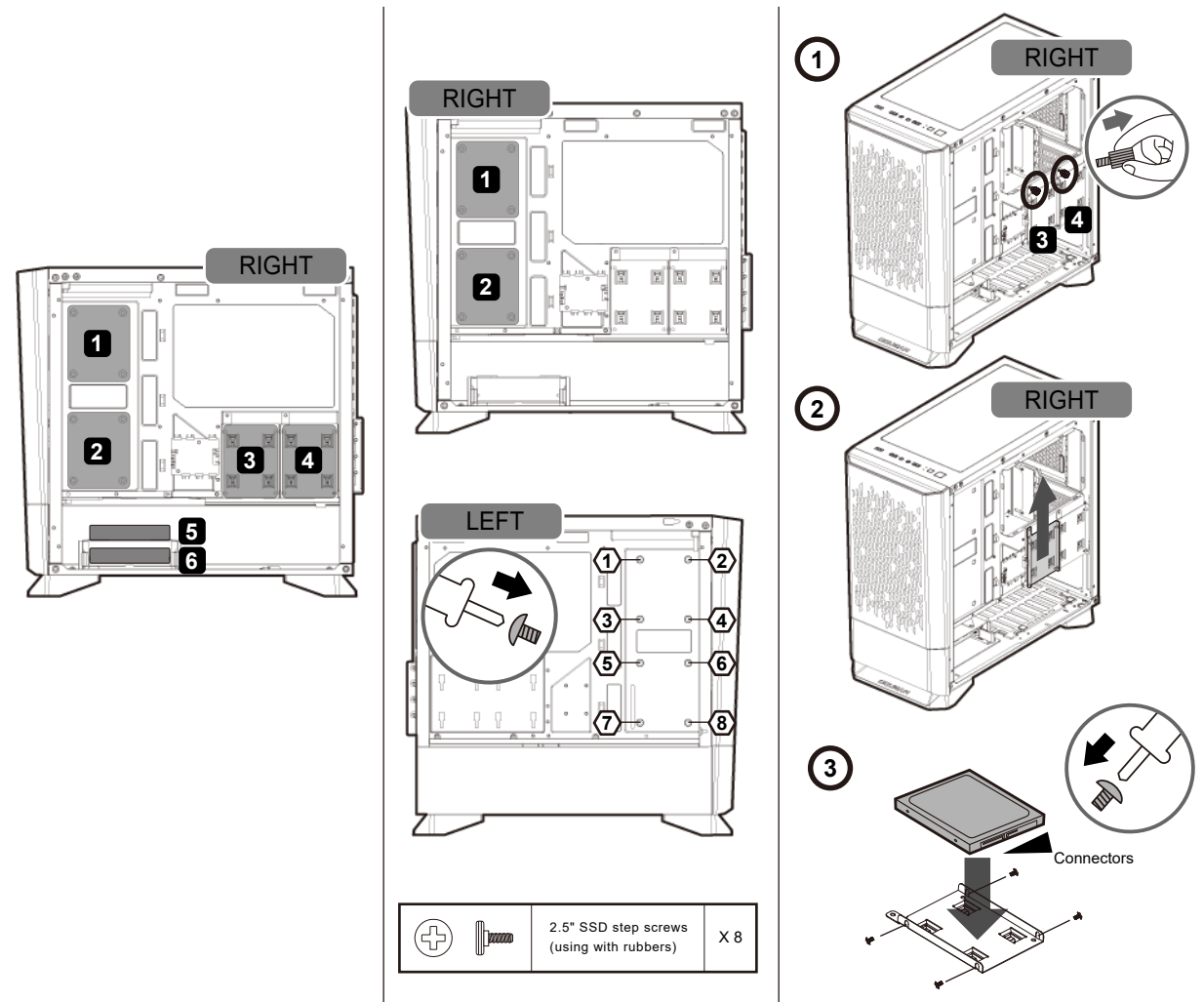

RGB & Fan control system

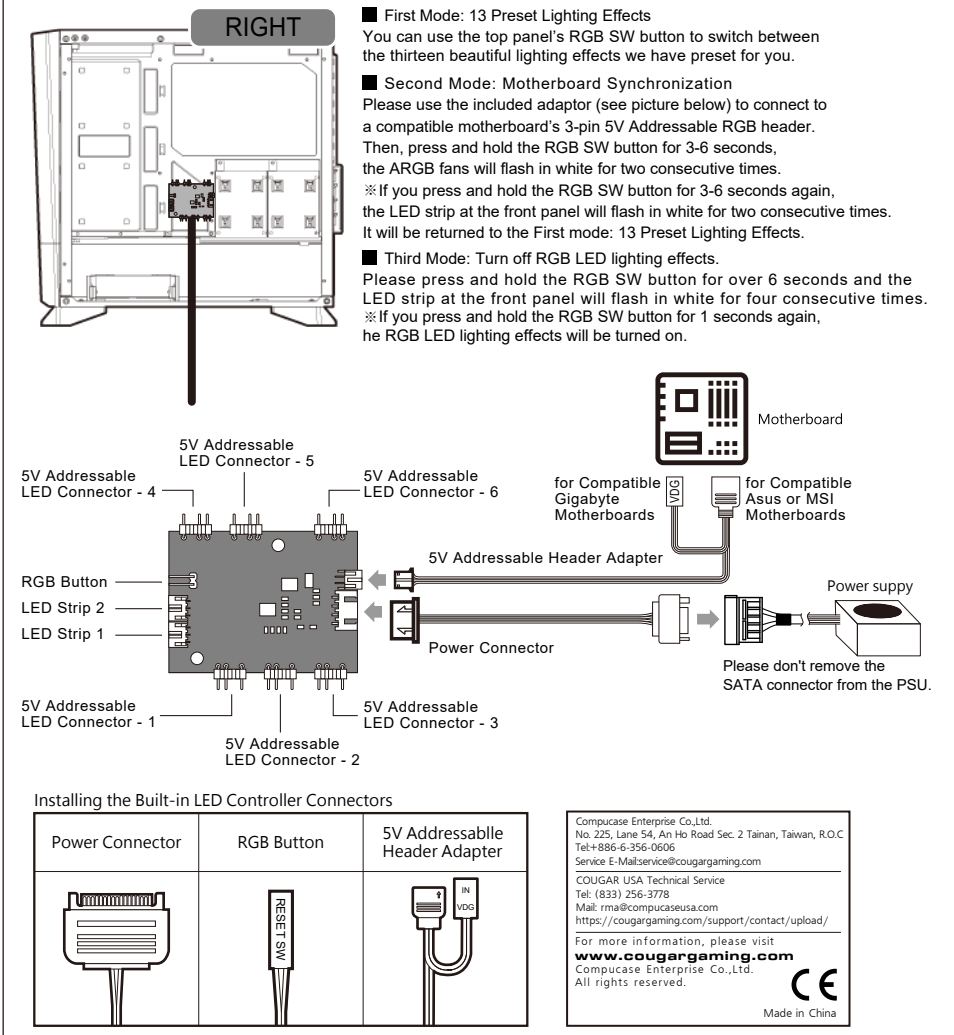

CompuCase Enterprise Co.,Ltd.
No. 225, Lane 54, An Ho Road Sec. 2 Tainan, Taiwan, R.O.C
Tel:+886-6-356-0606
Service E-Mail:service@cougargaming.com
COUGAR USA Technical Service
Tel: (833) 256-3778
Mail: rma@compucaseusa.com
https://cougargaming.com/support/contact/upload/
For more information, please visit
www.cougargaming.com
CompuCase Enterprise Co.,Ltd.
All rights reserved.

