

Canon

SPEEDLITE EL-1



Advanced User Guide

E

Contents

| | |
|---|----|
| Introduction. | 4 |
| Instruction Manual. | 5 |
| About This Guide. | 6 |
| Safety Instructions. | 8 |
| Nomenclature. | 10 |
| Getting Started and Basic Operations. | 26 |
| Charging the Battery. | 27 |
| Insert the Battery. | 31 |
| Attaching and Detaching the Speedlite to and from the Camera. | 33 |
| Turning on the Power. | 35 |
| Fully Automatic Flash Photography. | 40 |
| E-TTL II / E-TTL Autoflash by Shooting Mode. | 42 |
| Checking the Battery Information. | 47 |
| Advanced Flash Photography. | 49 |
| Flash Exposure Compensation. | 50 |
| FEB. | 52 |
| FE Lock. | 54 |
| High-Speed Sync. | 56 |
| Second-Curtain Sync. | 58 |
| Bounce. | 60 |
| Set the Flash Coverage. | 67 |
| Manual Flash. | 71 |
| Stroboscopic Flash. | 78 |
| Flash External Metering. | 82 |
| Continuous Shooting Priority Mode. | 87 |
| About the Modeling Lamp. | 88 |
| Modeling Flash. | 89 |
| Color Filter. | 90 |
| Clearing Speedlite Settings. | 92 |
| Flash Function Settings with Camera Controls. | 94 |

| | |
|---|------------|
| Flash Control from the Camera's Menu Screen..... | 95 |
| Radio Transmission Wireless Flash Shooting..... | 102 |
| Radio Transmission Wireless Flash Shooting..... | 103 |
| Radio Transmission Wireless Settings..... | 110 |
| Automatic Flash Photography with 1 Flash Receiver..... | 124 |
| Automatic Flash Photography with Receivers divided into 2 Groups..... | 133 |
| Automatic Flash Photography with Receivers divided into 3 Groups..... | 136 |
| Wireless Multiple Flash Shooting with a set Flash Ratio..... | 141 |
| Shooting in a Different Flash Mode for Each Group..... | 145 |
| Test Flash / Modeling Flash from a Receiver Unit..... | 150 |
| Remote Release from a Receiver Unit..... | 152 |
| Linked Shooting with Radio Transmission..... | 154 |
| Optical Transmission Wireless Flash Shooting..... | 159 |
| Optical Transmission Wireless Flash Shooting..... | 160 |
| Optical Transmission Wireless Settings..... | 164 |
| Automatic Flash Photography with 1 Flash Receiver..... | 173 |
| Automatic Flash Photography with Receivers divided into 2 Groups..... | 181 |
| Automatic Flash Photography with Receivers divided into 3 Groups..... | 184 |
| Wireless Multiple Flash Shooting with a set Flash Ratio..... | 188 |
| Manual Flash / Multiple Flash set in the Receiver unit..... | 191 |
| Customizing the Speedlite..... | 194 |
| Setting Custom and Personal Functions..... | 195 |
| Settings that can be changed with Custom Functions..... | 202 |
| Settings that can be changed with Personal Functions..... | 206 |
| Reference..... | 212 |
| EL-1 system..... | 213 |
| Flash Firing Restriction due to Temperature Increase..... | 215 |
| Troubleshooting..... | 219 |
| Specifications..... | 225 |
| Accessories..... | 232 |

Introduction

Canon Speedlite EL-1 is an external flash for the EOS that is compatible with the E-TTL II / E-TTL autoflash. The Speedlite can be used as an on-camera flash that attaches to the hot shoe of the camera (normal shooting), and as a sender / receiver unit during radio transmission / optical transmission wireless flash shooting. In addition to these functions, the Speedlite also has dust and water resistance equivalent to EOS-1D series cameras.

Be sure to read this manual before use.

To avoid botched pictures and accidents, first read the [Safety Instructions](#). Also, read this "Advanced User Guide" carefully to ensure that you use the flash correctly.

Read this instruction manual while also referring to your camera's instruction manual.

Before using the product, read this "Advanced User Guide" and the detailed guide of your camera to familiarize yourself with their operations.

*** This "Advanced User Guide" assumes that the Speedlite is used in combination with an EOS DIGITAL camera.**

Using the Speedlite in combination with an EOS film camera

When the Speedlite is used in combination with an EOS film camera with E-TTL II / E-TTL autoflash, pictures can be taken with the autoflash. When used in combination with a TTL autoflash EOS film camera, pictures cannot be taken with the autoflash.

Cautions when using continuous flash

Flashes will fire repeatedly in continuous shooting using a flash, multi-flash shooting, modeling flash, etc. Some people may experience seizures, etc. due to visual overstimulation from continuous flashes (including light reflected off brightly colored walls, etc.). Stop using flashes immediately if any symptoms emerge.

- [Instruction Manual](#)
- [About This Guide](#)
- [Safety Instructions](#)
- [Nomenclature](#)

Instruction Manual



The manual enclosed with the product is an "Instruction Manual" that summarizes the basic operations and functions of flash photography.

- **Advanced User Guide**

All uses of the Speedlite are described in this "Advanced User Guide".

Please check the latest detailed guide at the following site.

<https://cam.start.canon/A003/>





About This Guide





 [Icons in this Manual](#)

 [Assumptions in Operating Instructions](#)

Icons in this Manual

| | |
|---|--|
|  | Indicates the select dial. |
|  | Indicates that the respective function remains active for approx. 12 sec. or 16 sec. after you let go of the button. |

- In addition, icons used on the flash, such as the buttons and displays on the monitor etc., are used to describe the operation buttons and setting positions in the manual.

| | |
|---|---|
|  | Indicates a link to a related topic. |
|  | Describes the precautions to take to prevent shooting problems. |
|  | Describes supplementary information and explanations. |
|  | The ☆ to the right of the page title indicates that the function works when the camera is in the < Fv > < P > < Tv > < Av > < B > < M > shooting mode (Advanced Shooting Zone). |
|  | Provides troubleshooting information. |

Assumptions in Operating Instructions

- The operation procedures assume that both the Speedlite and the camera's power switches are turned ON (🔘).
- The icons used for buttons, dials, and symbols in the text match the icons found on the Speedlite and the camera.
- To set a function, press the joystick up / down / left / right or turn < 🌀 > to select the function.
- To end function setup, press the < ↩ > button.
- The operation procedures assume that the Custom Functions and Personal Functions of the Speedlite, and the menu and Custom Functions of the camera are at their default settings.

Safety Instructions

Be sure to read these instructions in order to operate the product safely.
Follow these instructions to prevent injury or harm to the operator of the product or others.

 **WARNING:** Denotes the risk of serious injury or death.

- Keep batteries out of the reach of children.
- Use only power sources specified in this instruction manual for use with the product.
- Do not disassemble or modify the product.
- Do not expose the product to strong shocks or vibration.
- Do not touch any exposed internal parts.
- Stop using the product in any case of unusual circumstances such as the presence of smoke or a strange smell.
- Do not use organic solvents such as alcohol, benzene or paint thinner to clean the product.
- Do not get the product wet. Do not insert foreign objects or liquids into the product.
- Do not use the product where flammable gases may be present.

This may cause electric shock, explosion or fire.

- Do not touch the product connected to a power outlet during lightning storms.

This may cause electric shock.

- Observe the following instructions when using commercially available batteries or provided battery packs.
 - Use batteries / battery packs only with their specified product.
 - Do not heat batteries / battery packs or expose them to fire.
 - Do not charge batteries / battery packs using non-authorized battery chargers.
 - Do not expose the terminals to dirt or let them come into contact with metallic pins or other metal objects.
 - Do not use leaking batteries / battery packs.
 - When disposing of batteries / battery packs, insulate the terminals with tape or other means.

This may cause electric shock, explosion or fire.

If a battery / battery pack leaks and the material contacts your skin or clothing, flush the exposed area thoroughly with running water. In case of eye contact, flush thoroughly with copious amounts of clean running water and seek immediate medical assistance.

- Observe the following instructions when using a battery charger.
 - Periodically remove any dust buildup from the power plug and power outlet using a dry cloth.
 - Do not plug in or unplug the product with wet hands.
 - Do not use the product if the power plug is not fully inserted into the power outlet.
 - Do not expose the power plug and terminals to dirt or let them come into contact with metallic pins or other metal objects.
 - Do not touch the battery charger or AC adapter connected to a power outlet during lightning storms.
 - Do not place heavy objects on the power cord. Do not damage, break or modify the power cord.
 - Do not wrap the product in cloth or other materials when in use or shortly after use when the product is still warm in temperature.
 - Do not leave the product connected to a power source for long periods of time.
 - Do not charge batteries / battery packs at temperatures outside the range of 5 - 40 °C (41 - 104 °F).

This may cause electric shock, explosion or fire.

- Do not allow the product to maintain contact with the same area of skin for extended periods of time during use.

This may result in low-temperature contact burns, including skin redness and blistering, even if the product does not feel hot.

- Follow any indications to turn off the product in places where its use is forbidden.

Not doing so may cause other equipment to malfunction due to the effect of electromagnetic waves and even result in accidents.



CAUTION:

Follow the cautions below. Otherwise physical injury or property damage may result.

- Do not fire the flash near the eyes.

It may hurt the eyes.

- Flash emits high temperatures when fired. Keep fingers, any other part of your body, and objects away from the flash unit while taking pictures.

This may cause burns or malfunction of the flash.

- Do not leave the product in places exposed to extremely high or low temperatures.

The product may become extremely hot/cold and cause burns or injury when touched.

- Do not touch any parts inside the product.

This may cause injury.

Nomenclature

- [LCD Panel](#)
- [Battery Charger LC-E6](#)
- [Battery Charger LC-E6E](#)
- [Accessories Provided](#)

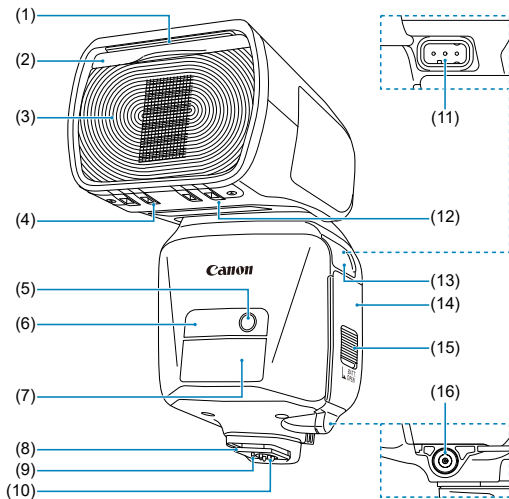

- | | |
|------|--|
| (1) | Catch light panel (stowed state) |
| (2) | Wide panel (stowed state) |
| (3) | Flash head (Light-emitting unit) |
| (4) | Color filter detector |
| (5) | External flash metering receiver |
| (6) | Optical transmission wireless receiver |
| (7) | AF-assist beam emitter |
| (8) | Mounting foot |
| (9) | Locking pin |
| (10) | Contacts |
| (11) | External power source socket |
| (12) | Bounce adapter detector |
| (13) | Terminal cover |
| (14) | Battery compartment lid |
| (15) | Battery compartment cover lock |
| (16) | Sync terminal |

**Note**



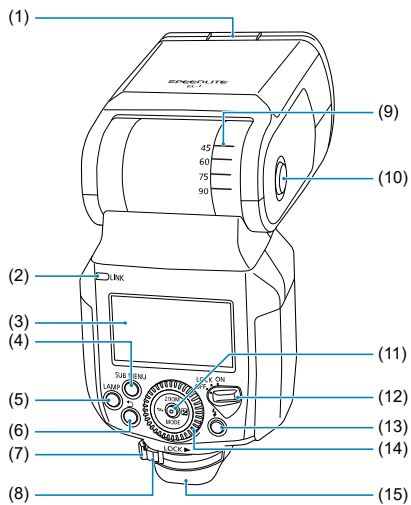





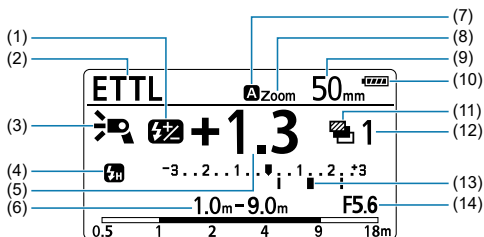







- Not equipped with remote release terminal (release cable SR-N3 cannot be used).



-
- (1) Bounce adapter / color filter attachment part
-
- (2) <LINK> Radio transmission confirmation lamp
-
- (3) LCD panel
-
- (4) <SUB MENU> Sub menu button
-
- (5) <LAMP> LAMP button
-
- (6) <↶> Undo button
-
- (7) Mounting foot lock lever
-
- (8) Lock-release button
-
- (9) Bounce angle index
-
- (10) Bounce lock-release button
-
- (11) Joystick
<ZOOM> Zoom
<MODE> Flash mode
<↔> Wireless / linked shooting setting
<☒> Flash exposure compensation / flash output setting
-
- (12) Power switch
<ON> Power ON
<LOCK> Button / Dial Lock (Power On)
<OFF> Power OFF
-
- (13) <⚡> Flash-ready lamp / test flash button
-
- (14) <⊙> Select dial
-
- (15) Dust-proof and drip-proof adapter
-

E-TTL II / E-TTL Autoflash (☑), Continuous Shooting Priority Mode (☑)



-
- (1) <  > Flash exposure compensation
-
- (2) < **E-TTL** > E-TTL II / E-TTL autoflash
 < **CSP** > Continuous shooting priority mode
-
- (3) <  > Standard
 <  > Guide number priority
 <  > Light distribution priority
 <  > Top bounce
 <  > Bottom bounce
 <  > Bounce adapter attached
 <  > Color filter attached
 <  > Temperature increase (flash firing restriction)
 <  > Modeling lamp lit
-
- (4) <  > First-curtain sync (normal shooting)
 <  > 2nd-curtain sync
 <  > High-speed sync
-
- (5) Flash exposure compensation amount
-
- (6) Effective flash range / shooting distance
 < **m** > Meter display
 < **ft** > Feet display
-
- (7) < **CHARGE** > Charge indicator
 < **A** > Automatic setting
 < **M** > Manual setting
-
- (8) < **Zoom** > Zoom display
 <  **WP** > Wide panel + bounce warning
 <  **WIDE** > Out of flash coverage range warning
-
- (9) Flash coverage (focal length)
-
- (10) Battery level display
-
- (11) <  > FEB
-
- (12) FEB sequence
-
- (13) Flash exposure level
-
- (14) < **F** > Aperture value
-

Manual Flash (🔒)

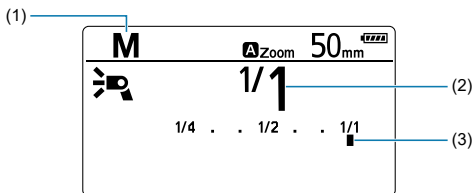

(1) <M> Manual flash

(2) Manual flash output

(3) Manual flash level



Note

- The displays shown are examples. Only the section corresponding to the settings will be displayed.
- When a button or dial is operated, the LCD panel is illuminated (🔒).

Stroboscopic Flash (🔒)

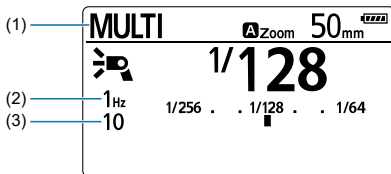

(1) <MULTI> Stroboscopic flash

(2) Flash frequency

(3) Number of flashes

Auto / Manual External Flash Metering (🔗)

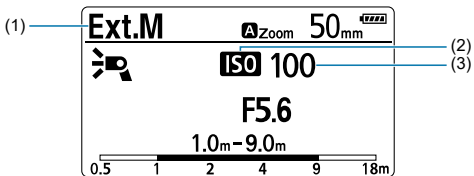

-
- (1) < **Ext.A** > Auto external flash metering
< **Ext.M** > Manual external flash metering
-
- (2) < **ISO** > ISO display
-
- (3) ISO speed
-

Radio Transmission Wireless Shooting / Optical Transmission Wireless Shooting (📡 / 📡)

● Sender unit(s)

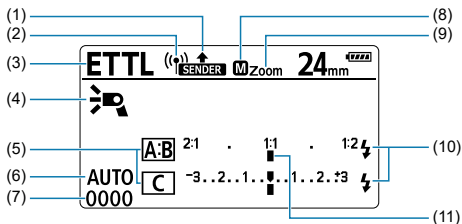

-
- (1) < **SENDER** > Sender setting
 < **SUB SENDER** > Sub sender setting*1
-
- (2) < 📡 > Radio transmission wireless
 < 📡 > Optical transmission wireless
-
- (3) Flash mode
 < **ETTL** > E-TTL II / E-TTL autoflash
 < **M** > Manual flash
 < **MULTI** > Stroboscopic flash
 < **Gr** > Group firing*1
-
- (4) < 📡 > Sender flash firing ON
 < 📡 > Sender flash firing OFF
-
- (5) Firing group control
-
- (6) < **Ch** > Transmission channel
 < **AUTO** > Transmission channel automatic setting*1
-
- (7) Wireless radio ID*1
-
- (8) < **CHARGE** > Sender / receiver charge indicator
-
- (9) < 📺 > Synchronization speed warning*1
-
- (10) < ⚡ > Receiver charging completed*1
-
- (11) Flash ratio
-

* 1: < 📡 > Radio transmission wireless only

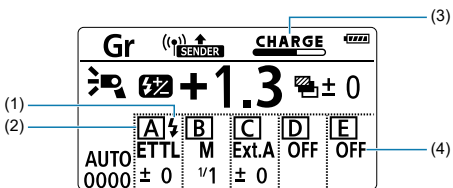

(1) < ⚡ > Receiver charging completed*1

(2) Firing group control

(3) Sender / receiver charge indicator

(4) Group firing mode*2

* 1: < (📻) > Radio transmission wireless only

* 2: < **Gr** > Group firing only

Note

- During radio transmission wireless shooting, when the sender and receiver are fully charged, < **CHARGE** > disappears.
- For < **Gr** > group firing, you can select the and the flash mode from < **ETTL** > < **M** > < **Ext.A** > < **OFF** > .

● Receiver unit

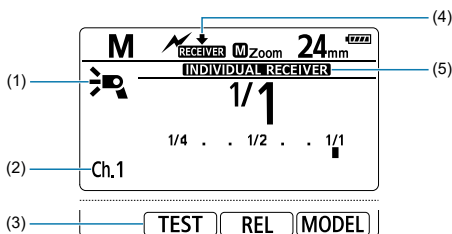

(1) < > Receiver

(2) < Ch > Transmission channel

(3) < **TEST** > Test flash*¹
 < **REL** > Remote release*¹
 < **MODEL** > Modeling flash*¹

(4) < **RECEIVER** > Receiver setting

(5) < **INDIVIDUAL RECEIVER** > Individual receiver*²

* 1: < > Radio transmission wireless only

* 2: < > Optical transmission wireless only

Radio Transmission: Linked Shooting (🔗)

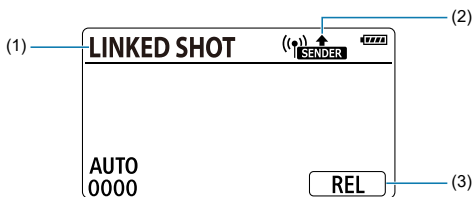

(1) < **LINKED SHOT** > Linked shooting

(2) < **SENDER** > Sender setting
< **RECEIVER** > Receiver setting

(3) < **REL** > Release*¹

* 1: < **SENDER** > Sender setting only

Battery Charger LC-E6

Charger for the Battery Pack LP-EL.

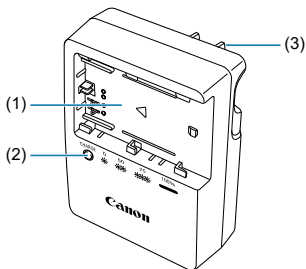

-
- (1) Battery mounting part
 - (2) Charge lamp
 - (3) Power plug
-

Battery Charger LC-E6E

Charger for the Battery Pack LP-EL.

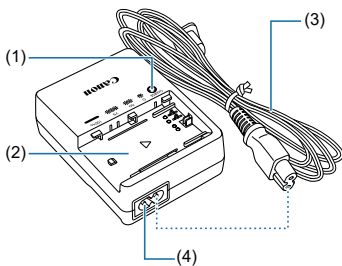

-
- (1) Charge lamp
 - (2) Battery pack slot
 - (3) Power cord
 - (4) Power cord socket
-

Accessories Provided

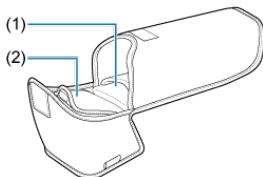

Speedlite case

- (1) Mini stand storage section
- (2) Bounce adapter / color filter housing unit

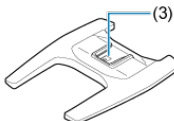

Mini stand

- (3) Mounting part



Bounce adapter SBA-EL



Color filter SCF-ELOR1



Color filter SCF-ELOR2

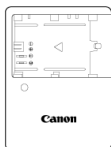

Battery Charger LC-E6/LC-E6E*



Battery Pack LP-EL

* Battery Charger LC-E6 or LC-E6E is provided (The LC-E6E comes with a power cord).

Getting Started and Basic Operations

This chapter describes the preparations before starting flash photography and the basic shooting operations.

Caution

Caution concerning continuous flashes

- To avoid degrading and damaging the flash head due to overheating, set the number of continuous full flashes to 55 or less. After firing continuously at full output for the above listed number of times, allow a rest time of at least 10 min. When the fan is stopped, the number of continuous full flashes decreases.
- If you fire the flash continuously at full output for the above listed number of times, and then fire the flash again repeatedly at short intervals, the safety function may activate and restrict flash firing. When the flash firing restriction level is 1, the firing interval is automatically set to about 8 seconds. If this happens, allow a rest time of at least 50 min.
- For details, see the section on [Flash Firing Restriction due to Temperature Increase](#).

- [Charging the Battery](#)
- [Insert the Battery](#)
- [Attaching and Detaching the Speedlite to and from the Camera](#)
- [Turning on the Power](#)
- [Fully Automatic Flash Photography](#)
- [E-TTL II / E-TTL Autoflash by Shooting Mode](#)
- [Checking the Battery Information](#)

Charging the Battery

1. Remove the attached protective cover.

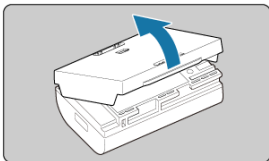

2. Attach the battery securely to the charger.

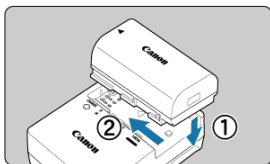

3. Recharge the battery.

For LC-E6

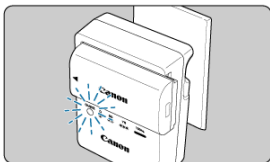
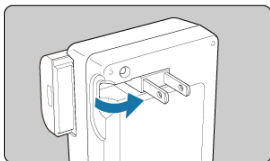

- As shown by the arrow, flip out the battery charger's prongs and insert the prongs into a power outlet.

For LC-E6E

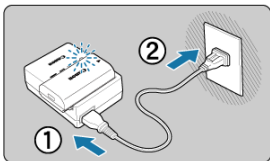

- Connect the power cord to the charger and insert the plug into a power outlet.
- Recharging starts automatically and the charge lamp blinks in orange.

| Charge Level | Charge Lamp | |
|---------------|-------------|-------------------------------|
| | Color | Display |
| 0-49% | Orange | Blinks once per second |
| 50-74% | | Blinks twice per second |
| 75% or higher | | Blinks three times per second |
| Fully charged | Green | Lit |

- **It takes approx. 2 hr. and 10 min. to fully recharge a completely exhausted battery at room temperature (23°C / 73°F).** The time required to recharge the battery will vary greatly depending on the ambient temperature and the battery's remaining capacity.

- For safety reasons, recharging in low temperatures (5-10°C / 41-50°F) will take longer (up to approx. 4 hr.).
- **The battery is not charged at the time of purchase.**
Please charge it before use.
- **Charging should be done on the day of use or a day earlier.**
Even when charged and stored, the capacity of the battery gradually decreases due to natural discharge.
- **When charging is completed, remove the battery and disconnect the plug from the outlet.**
- **You can know whether the battery is fully charged or depleted by the mounting direction of the protective cover.**
The attached protective cover can change its color when seen through the window <  > of the protection cover depending on the mounting direction. You can judge the status of the battery by pre-determining the charged and used colors.

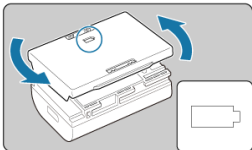

- **Remove the battery when not using the flash.**
If the battery is left in the flash for a long period of time, a small amount of current will flow, resulting in over-discharging and shortening the battery life. Attach the battery protection cover and store it. In addition, the performance may be reduced when the unit is stored with the battery fully charged.
- **The charger can be used overseas too.**
The charger is compatible with a household power supply of 100V to 240V 50/60 Hz. Use a commercially available power plug conversion adapter that is compatible with your country or region. Do not connect the charger to an electronic transformer for overseas travel as this may damage the charger.
- **If you can't use it immediately after charging it fully, this means the battery has reached the end of its life.**
Check the battery deterioration before purchasing a new battery.

 **Caution**

- When you disconnect the charger from the outlet, do not touch the charger plug for about 10 seconds.
- When the remaining battery level is 90% or more, charging will not be performed.

 **Note**

Battery storage

- Store in a cool, dry and well-ventilated place.
- Even when the battery is removed from the Speedlite, a very small amount of current may flow inside the battery. This results in over-discharging when the battery is left in this state for a long time, so you may not be able to use the battery even if you charge it.
- When storing the battery for a long time, charge it about once a year to about 50% before storing it.

Insert the Battery

Use the LP-EL battery pack for the power supply.

1. Open the cover.

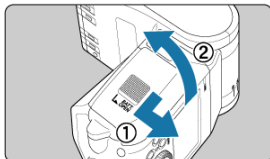

- While sliding the lock lever down, slide the lid to the right to open the battery compartment lid.

2. Insert the Battery.

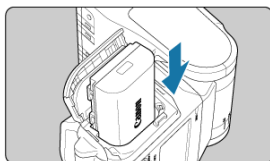

- Follow the indication and insert the battery from the side of the battery contact point.

3. Close the cover.

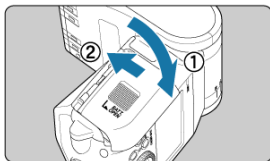

- Close the battery compartment lid and slide it to the left.
- When it clicks in place, the battery compartment cover is locked.

Firing interval and number of flashes

EL-1 alone

| Firing interval | | Number of flash firings |
|-------------------------|-------------------------|---------------------------|
| Quick flash | Normal flash | |
| Approx. 0.1 to 0.8 sec. | Approx. 0.1 to 0.9 sec. | Approx. 335 to 2345 times |

* The Quick flash function enables flash photography before the flash is fully charged (🔋).

CAUTION

- **When performing continuous flashes, do not touch the flash head, batteries, or the area near the battery compartment.**

When continuous flash or modeling flash is repeatedly fired at short intervals, do not touch the flash head, batteries, or the area near the battery compartment. The flash head, battery, and area near the battery compartment become hot, resulting in a risk of burns.

- **Do not touch the same part for a long period of time while using the Speedlite.**

Even if the product does not feel too hot, prolonged contact with the same body part may cause skin redness or blistering due to low-temperature contact burns.

Note

- When <🔋> is displayed or the LCD panel display turns off during recharging, charge the battery.

Attaching and Detaching the Speedlite to and from the Camera

1. Attach the Speedlite.

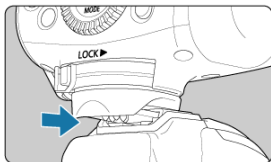

- Slip the Speedlite's mounting foot **all the way** into the camera's hot shoe.

2. Secure the Speedlite.

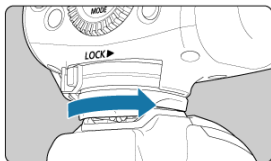

- Slide the mounting foot lock lever to the right.
- When the lock lever clicks in place, it is locked.

3. Detach the Speedlite.

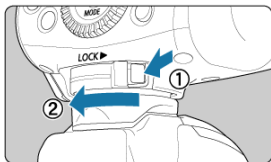

- While pressing the lock-release button, slide the lock lever to the left and detach the Speedlite from the camera.

 **Caution**

- Be sure to turn off the Speedlite before attaching or detaching it.

Turning on the Power

- ☑ [About the Quick Flash Function](#)
- ☑ [About the Auto Power OFF Function](#)
- ☑ [About the Lock Function](#)
- ☑ [About the LCD Panel Illumination](#)

1. Turn the power switch to <ON>.

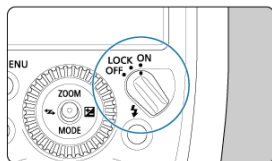

- Charging starts.
- When charging, < **CHARGE** > is displayed on the LCD panel. When flash recharge is complete, this indicator disappears and a beep sound is heard.

2. Check that the flash is ready.

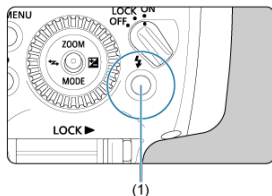

- The status of the flash-ready lamp changes from **off** → **red (flashing)** (Quick flash ready) → **red (lit)** (fully charged).
- You can press the test flash button (flash-ready lamp) (1) to fire a test flash.

Caution

- You cannot use the test flash when operating the flash timer on the camera.

Note

- The flash settings will remain in effect even after the power is turned off.
- You can set the beep not to sound when charging is completed ([P.Fn-06](#)).

About the Quick Flash Function

The Quick flash function enables flash photography when the flash-ready lamp is flashing in red (before the flash is fully charged). Quick flash is available regardless of the camera's drive mode setting. Although the flash output will be approx. 1/2 to 1/6 of the full output, it is useful for shooting with a shorter firing interval.

During manual flash photography, this function is available when the flash output is set to 1/4 to 1/8192. Note that you cannot use Quick flash during stroboscopic flash and wireless flash shooting.

Caution

- When Quick flash is fired during continuous shooting, underexposure may occur since the flash output decreases.

Note

- For more details on the < **CHARGE** > display when setting the radio transmission wireless sender unit, see "[About the LCD Panel Illumination](#)".
- You can disable Quick Flash ([P.Fn-02](#)).

About the Auto Power OFF Function

To save battery power, the power will turn off automatically after approx. 90 sec. of idle use. To turn on the Speedlite again, press the camera's shutter button halfway or press the test flash button (flash-ready lamp).

When set as the sender unit for radio transmission wireless flash shooting (☑) or set for linked shooting (☑), the time until auto power off takes effect is approx. 5 min.



Note

- Auto power off can be disabled ([C.Fn-01](#)).

About the Lock Function

By setting the power switch to <LOCK>, you can disable the flash's button and dial operations. This is useful when you want to prevent the flash function settings from being accidentally changed after you set them.

If you operate a button or dial, <LOCKED> is displayed on the LCD panel.



Note

- You can directly fire a test flash and the modelling light even if the power switch is in the <LOCK> position. Also, when a button or dial is operated, the LCD panel illuminates.

About the LCD Panel Illumination

When a button or dial is operated, the LCD panel illuminates for approx. 12 sec (12).
For more details on the LCD panel illumination when setting the radio transmission wireless sender unit, see "[About the LCD Panel Illumination](#)".



Note

- You can change the setting of the LCD panel illumination ([C.Fn-22](#)).

Fully Automatic Flash Photography

When you set the camera's shooting mode to < P > (Program AE) or "Fully Automatic", you can shoot with E-TTL II / E-TTL fully automatic flash shooting.

1. Select < MODE > with the joystick.

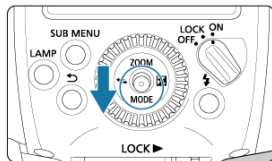

2. Select < E TTL >.

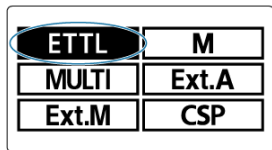

- Press the joystick up, down, left, or right, or turn <  > and select < E TTL >, then press the joystick vertically.

3. Focus on the subject.



- Press the shutter button halfway to focus.
- The shutter speed and aperture value are displayed in the viewfinder.
- Check that <  > is lit in the viewfinder.

4. Take the picture.

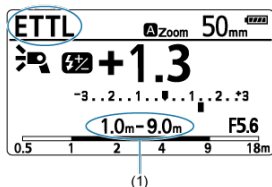

* <P> (Program AE) screen example.

- Check that the subject is in the effective flash range (1).
- When you press the shutter button completely, the flash will fire and the picture will be taken.

Note

- If the subject is dark (underexposed) when you check the picture taken, get closer to the subject and shoot again. You can also increase the ISO speed when using a digital camera.
- "Fully Automatic" indicates the <A+> <□> <CA> shooting mode.
- Even when attached to a camera that supports the E-TTL II autoflash system, <E-TTL> is displayed on the LCD panel.

E-TTL II / E-TTL Autoflash by Shooting Mode

[Auto Zoom Support for Image Sensor Size](#)

[Color Temperature Information Transmission](#)

[AF-Assist Beam](#)

Simply set the camera's shooting mode to < **Tv** > (shutter-priority AE), < **Av** > (aperture-priority AE), < **Fv** > (flexible AE) or < **M** > (manual exposure), and you can use E-TTL II / E-TTL autoflash suitable for each shooting mode.

| | |
|-----------|--|
| Tv | Select this mode when you want to set the shutter speed manually. The camera will then automatically set the aperture matching the shutter speed to obtain the standard exposure based on the metering of the camera. <ul style="list-style-type: none">● If the aperture value blinks, it means that the background exposure will be underexposed or overexposed. Adjust the shutter speed until the aperture value stops blinking. |
| Av | Select this mode when you want to set the aperture manually. The camera will then automatically set the shutter speed, matching the aperture to obtain the standard exposure based on the metering of the camera. <ul style="list-style-type: none">● Since a slow shutter speed will be used for low-light scenes, using a tripod is recommended.● If the shutter speed blinks, it means that the background exposure will be underexposed or overexposed. Adjust the aperture value until the shutter speed stops blinking. |
| Fv | Any shutter speed or aperture value can be set. <ul style="list-style-type: none">● If the aperture value blinks with any shutter speed setting, change the shutter speed so that the aperture value lights up.● If the shutter speed flashes at the set aperture value, change the aperture value so that the shutter speed lights up. |
| M | Select this mode if you want to set both the shutter speed and aperture value manually. Standard exposure of the main subject is obtained with the flash light. The exposure of the background is obtained with the shutter speed and aperture value combination you set. |

* If you use the < **DEP** > or < **A-DEP** > shooting mode, the result will be the same as using the < **P** > (Program AE) mode.

Flash Sync Speed and Aperture Value by Shooting Mode

| | Shutter speed | Aperture value |
|-----------|---|------------------------------------|
| P | Automatic setting (1/X sec. to 1/60 sec.)* ¹ | Automatic setting |
| Tv | Manually setting (1/X sec. to 30 sec.) | Automatic setting |
| Av | Automatic setting (1/X sec. to 1/60 sec.)* ¹ | Manual setting |
| Fv | Manual setting / automatic setting (1/X sec. -) | Automatic setting / manual setting |
| M | Manually setting (1/X sec. to 30 sec., Bulb) | Manual setting |

* 1/X second is the maximum flash synchronization shutter speed of each camera.

* 1: According to the setting in cameras that support slow shutter synchronization

Auto Zoom Support for Image Sensor Size

EOS DIGITAL cameras have three sizes of image sensors, and the effective shooting angle of view of the attached lens varies depending on the size of the image. The Speedlite automatically recognizes the image sensor size of the EOS DIGITAL camera and automatically sets the flash coverage that is ideal for the effective shooting angle of view of a lens for the focal length range of 24 - 200 mm.

Color Temperature Information Transmission

This function optimizes the white balance during flash photography by transmitting the color temperature information to the EOS DIGITAL camera when the flash fires. When you set the camera's white balance to < **AWB** > < **AWBW** > <  >, the function is enabled automatically. Refer to the specifications in your camera's Instruction Manual to find out if it is compatible with this function.

AF-Assist Beam



When it is difficult to autofocus on the subject in low-light or when contrast is low during viewfinder shooting, the infrared AF-assist beam built into the flash automatically flashes to help autofocus.

The AF-assist beam supports 28 mm and longer focal lengths of the lens and its effective range (at 28 mm focal length) is approx. 0.6 - 10 m / 2.0 - 32.8 ft. at the center in the viewfinder and approx. 0.6 - 5 m / 2.0 - 16.4 ft. at the periphery (AF points other than the center AF point).

! Caution

- If a peripheral AF point or a wide-angle or telephoto lens is used, achieving focus may be difficult with an EOS-dedicated, external Speedlite's AF-assist beam. In such a case, use the center AF point or an AF point close to the center.

📱 Note

- During Live View shooting, the AF-assist beam is emitted even when the AF method is set to **[Quick mode]**.
- AF-assist beam firing can be disabled ([C.Fn-08](#)).
- The AF-assist beam can be projected using the intermittent flash firing method ([P.Fn-01](#)).

Checking the Battery Information

You can check the status of the battery in use.

1. Press the <SUB MENU> button.

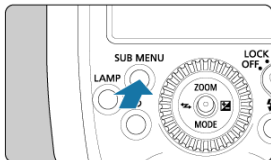

2. Display the information screen.

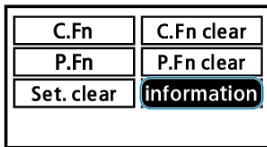

- Press the joystick up, down, left, or right, or turn <  > and select < **information** >, then press the joystick vertically.

3. Display the [Battery info.] screen.



- Press the joystick down or up and turn <  > to select < **Battery info.** >, then push the joystick vertically.

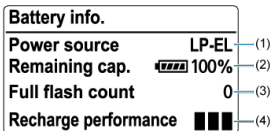

- (1) The battery in use is displayed.
- (2) In addition to displaying the remaining battery level, the remaining level will be displayed in 1% units.
- (3) The number of shots taken with the battery in use is displayed. The count is reset when charging is carried out.
- (4) The degradation status of the battery is displayed.

: Not degraded

: Battery is slightly degraded

: Battery replacement is recommended

Caution

- We recommend that you use the genuine Canon LP-EL battery pack. Using a non-genuine battery may result in a malfunction or a risk of not being able to exploit the original performance of the flash.

Note

- When the message [**Cannot communicate with battery Use this battery?**] appears, follow the instructions in the message.

Advanced Flash Photography

This chapter describes advanced shooting operations utilizing the flash functions.

Caution

- When the camera's shooting mode is set to a fully automatic mode or a Basic Zone mode, the functions with ☆ added to the right side of the page title cannot be set. If you set the camera's shooting mode to < **Fv** >, < **P** >, < **Tv** >, < **Av** >, < **M** > or < **bulb (B)** > (Advanced Shooting Zone), you can perform all the operations in this chapter.

- [Flash Exposure Compensation](#) ☆
- [FEB](#) ☆
- [FE Lock](#) ☆
- [High-Speed Sync](#) ☆
- [Second-Curtain Sync](#) ☆
- [Bounce](#)
- [Set the Flash Coverage](#) ☆
- [Manual Flash](#) ☆
- [Stroboscopic Flash](#) ☆
- [Flash External Metering](#) ☆
- [Continuous Shooting Priority Mode](#) ☆
- [About the Modeling Lamp](#)
- [Modeling Flash](#) ☆
- [Color Filter](#)
- [Clearing Speedlite Settings](#) ☆

With a similar procedure as exposure compensation, you can adjust the flash output. The flash exposure compensation amount can be set up to ± 3 stops in 1/3-stop increments.

1. Select  with the joystick.

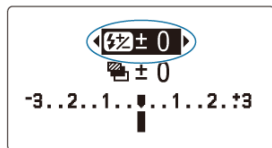
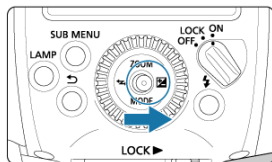

2. Set the flash exposure compensation amount.

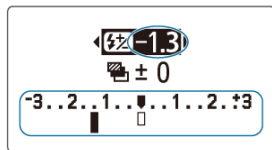
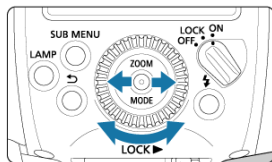

- Push the joystick to the left or right or turn <⊙> to set the amount of compensation, and push the joystick vertically.
- "0.3" indicates 1/3 stop and "0.7" indicates 2/3 stops.
- To cancel flash exposure compensation, return the compensation amount to "±0".
- After changing the value, the changed value will be set even if you push the joystick up and down.
- After changing the value, the changed value will not be set if the <↶> button is pressed.

Note

- Generally, set an increased exposure compensation for bright subjects and set a decreased exposure compensation for dark subjects.
- If the camera's exposure compensation is set in 1/2-stop increments, flash exposure compensation will be up to ±3 stops in 1/2-stop increments.
- When the flash exposure compensation is set on both the flash and the camera, priority is given to the flash setting.
- You can set the flash exposure compensation amount by turning <⊙> directly without selecting <⊠> with the joystick (C.Fn-13).

You can take three shots while automatically changing the flash output. This is called FEB (Flash Exposure Bracketing). The settable range is up to ± 3 stops in $1/3$ -stop increments.

1. Select  with the joystick.

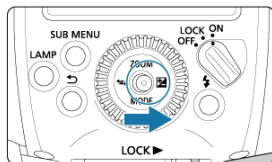

2. Push the joystick downward to select FEB.

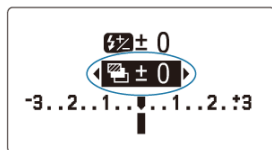

3. Set the FEB level.

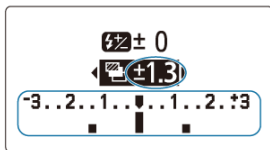
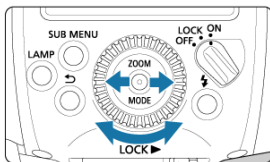

- Push the joystick to the left or right or turn to set the FEB level, then push the joystick vertically.
- "0.3" indicates 1/3 stop and "0.7" indicates 2/3 stops.
- When used together with flash exposure compensation, FEB shooting is performed based on the set flash exposure compensation amount. When the FEB range exceeds ± 3 stops, the end of the flash exposure level shows or .
- After changing the value, the changed value will be set even if you push the joystick up and down.
- After changing the value, the changed value will not be set if the button is pressed.

Note

- After the three shots are taken, FEB is canceled automatically.
- Before shooting with FEB, it is recommended to set the camera's drive mode to single shooting and check that the flash has been recharged. When the drive mode is set to continuous shooting, shooting automatically stops after three continuous shots are taken.
- You can use FEB together with flash exposure compensation or FE lock.
- If the camera's exposure compensation is set in 1/2-stop increments, flash exposure compensation will be up to ± 3 stops in 1/2-stop increments.
- You can set FEB to remain enabled after shooting the three shots ([C.Fn-03](#)).
- You can change the FEB shooting sequence ([C.Fn-04](#)).

The FE (Flash Exposure) lock locks the correct flash exposure setting for any part of the subject.

With <ETTL> or <CSP> is displayed in the panel, push the <M-Fn> or <★> (AE lock) and <FEL> buttons on the camera.

1. Focus on the subject.

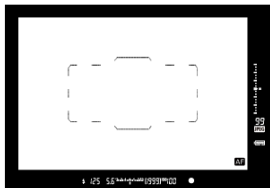

2. Press the <M-Fn> button (Ⓜ16).

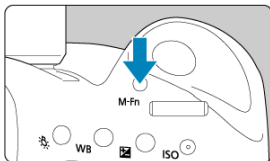

- With the subject at the center of the viewfinder, press the camera's <M-Fn> button.
- The Speedlite will fire a preflash and the required flash output for the subject is retained in memory.
- "FEL" will be displayed in the viewfinder for approx. 0.5 sec.
- Each time you press the <M-Fn> button, a preflash will be fired and the new flash output required at that time is retained in memory.



Note

- If a correct exposure cannot be obtained when FE lock is performed, <  > blinks in the viewfinder. Move closer to the subject or open the aperture, and perform FE lock again. You can also set a higher ISO speed and perform FE lock again when using a digital camera.
- If the target subject is too small in the viewfinder, FE lock may not be effective.

With high-speed sync, you can shoot with a flash even at shutter speeds that exceed the maximum flash sync shutter speed. This is effective when you want to shoot in the aperture-priority AE < **Av** > mode (open aperture) with background blur in locations such as outdoors in daylight.

1. Push the joystick vertically.

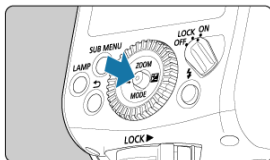



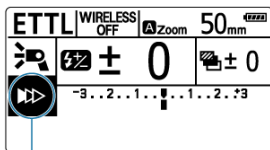

2. Select an item in (1).

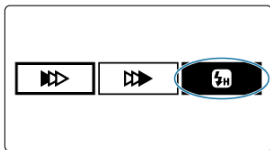

- Push the joystick up / down / left / right or turn < ⌚ > to select an item, and push the joystick vertically.

3. Select < >.





- Press the joystick to the left or right, turn <  > to select <  > to select, then push the joystick vertically.
- Check that <  > is lit in the viewfinder, then shoot.

Caution

- With high-speed sync, the faster the shutter speed, the lower the guide number becomes. You can check the effective flash range on the LCD panel.
- To avoid degrading and damaging the flash due to overheating, the number of sequential firings during continuous shooting may be reduced with high-speed sync flashes.

Note

- If the shutter speed is less than the maximum flash synchronization shutter speed, <  > will not be displayed in the viewfinder.
- To return to normal flash, select <  > (first curtain sync) in step 3 (<  > is not displayed on the screen after setting).

Shooting with a slow shutter speed and second-curtain sync captures the trail of the light sources of a moving subject, such as car lights, in a natural way. The flash fires right before the exposure finishes (shutter closes).

1. Push the joystick vertically.

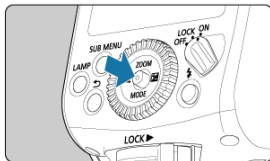

2. Select an item in (1).

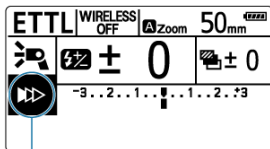

(1)

- Push the joystick up / down / left / right or turn <⊙> to select an item, and push the joystick vertically.

3. Select <⏪>.

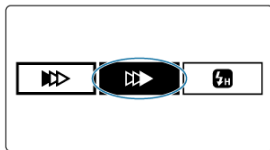

- Press the joystick to the left or right, turn <⊙> to select <⏪> to select, then push the joystick vertically.



Note

- The second-curtain sync works well when the camera's shooting mode is set to < **B** > (bulb shooting).
- When the flash mode is set to < **ETTL** >, the flash fires twice. The first flash is a preflash to determine the flash output. It is not a malfunction.
- To return to normal flash, select < **▶▶▶** > (first curtain sync) in step 3 (< **▶▶▶** > is not displayed on the screen after setting).

Bounce



 [< !\[\]\(e79299683882154d856e57ff98e54c81_img.jpg\) > Short Distance Flash Shooting](#)

 [Catchlight Shooting](#)

 [< !\[\]\(b89ecf30df3dbaee65fa9f1829524a6e_img.jpg\) > Bounce Photography with the Bounce Adapter](#)

By pointing the flash head toward a ceiling or wall, the flash light will bounce off the surface before illuminating the subject, making it possible to soften the shadows of the subject for a more natural-looking shot. This shooting method is called "Bounce flash photography".

Setting the orientation of the flash head

- You can turn the flash head while pressing the bounce lock-release button as shown. When you turn the flash head, the display changes to  >.
- When the flash head is turned with the flash coverage set to  > (automatic setting), the flash coverage is set at 50 mm and <---> is displayed.
- You can also set the flash coverage manually ().

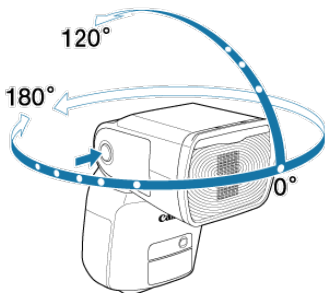



Note

- If the ceiling or wall to bounce the flash light on is too far away, shooting with the appropriate exposure may not be possible since the bounced flash may be too weak.
- If the picture appears dark, use a larger aperture opening (smaller f/number) and try again. You can also increase the ISO speed when using a digital camera.
- The ceiling or wall to bounce the flash light on should be plain white for high reflectance. If the bounce surface is not white, shooting with the appropriate exposure may not be possible, since a color cast may result in the picture or the bounced flash may be too weak.
- When Quick flash is fired with bounce flash, underexposure may occur since the flash output decreases.

< > Short Distance Flash Shooting

When you position the flash head down by 7° while pressing the bounce lock-release button, you can shoot subjects at a short distance in a range of approx. 0.5 to 2 m / 1.6 to 6.6 ft.

When the flash head is positioned down by 7° , the display changes to <  >.

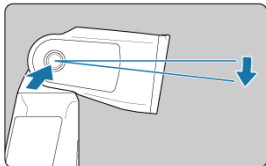

Catchlight Shooting

Using the catchlight panel when shooting a portrait enables you to capture reflected light in a person's eyes and create a more vivid expression.

1. Turn the flash head up 90°.
2. Pull up the wide panel.

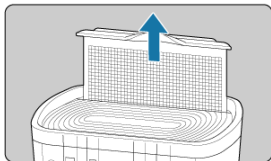

- Pull up the protruding area located in the center of the wide panel.
- The white catchlight panel is pulled out at the same time.

3. Push back the wide panel.

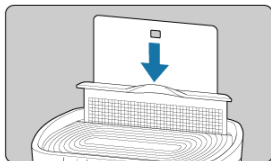

- Push back the wide panel only, keeping just the catchlight panel up.
- Shoot using the same method as bounce flash.

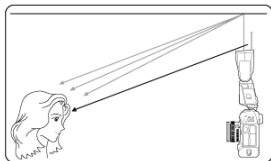

 **Caution**

- Position the flash head toward the front and 90° up. When the flash head is rotated to the left or right, the catchlight is not very effective.
- To effectively obtain the catchlight in a person's eyes, shoot within approx. 1.5 m / 4.9 ft. from the subject (at ISO 100 with f/2.8).
- Do not pull up the wide panel with excessive force. Doing so may detach the wide panel from the Speedlite.

< 3! > Bounce Photography with the Bounce Adapter

If you attach the provided bounce adapter to the Speedlite and bounce the flash light on the ceiling or wall, etc., you can spread the flash light across a larger area and suppress the shadows of the subject.

Also, if the flash head is turned 90° upward to bounce the flash light on the ceiling, etc., the diffused flash light emitted from the sides of the bounce adapter falls on the front of the subject (shooting distance guidance: within approx. 1.5 m / 4.9 ft., at ISO 100 with f/2.8), further suppressing the shadow of the subject. When shooting portraits, the catchlight effect can also be obtained.

1. Attach the bounce adapter.

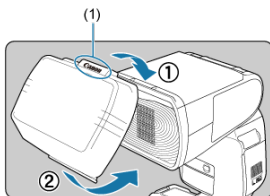

(1) "Canon" logo

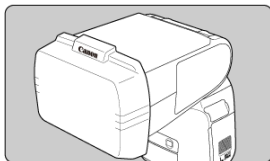

- Attach the adapter securely to the flash head until it clicks in place, as shown.
- Check that the display changes to < 3! >.
- When removing the adapter, follow the procedure in reverse order. Raise the removal tab on the lower side of the adapter, then remove the adapter from the flash head.

2. Take the picture.

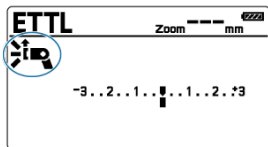

- Take the picture with the flash light bouncing off the ceiling, walls, or the like.

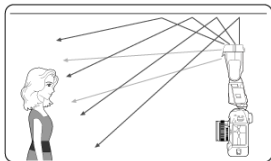

⚠ Caution

- When the bounce adapter is attached, or when the bounce adapter and the wide panel are used together, underexposure may result since the guide no. decreases. Take necessary countermeasures such as increasing the ISO speed on the camera or applying flash exposure compensation (☑).
- When Quick flash (☑) is fired with the bounce adapter attached, taking the picture after the flash-ready lamp is lit in red is recommended since the flash output may not be sufficient.
- The flash coverage is set automatically when the bounce adapter is attached. It cannot be changed arbitrarily.
- If you attach the bounce adapter to the flash when using an EOS DIGITAL camera released up to 2004, set the white balance to <AWB>. If you shoot with <☑> setting, an appropriate white balance may not be obtained.

📄 Note

- The flash light is further softened when the wide panel (☑) is used together with the bounce adapter.
- If the subject is dark (underexposed) when you check the shot image, perform the flash exposure compensation (☑). You can also increase the ISO speed when using a digital camera.

[Wide Panel](#)

Flash coverage (the range covered by the flash light) can be set automatically or manually. When set to < **A** > (automatic setting), the flash coverage is adjusted automatically according to the focal length (shooting angle of view) of the lens in use and the image sensor size (). With the < **M** > (manual setting), you can manually set flash coverage in the range of 24 to 200 mm.

1. Select < ZOOM > with the joystick.

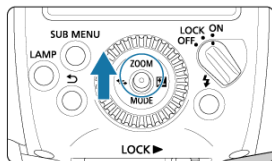

| | | | |
|-------------|-----|----|-----|
| AUTO | 24 | 28 | 35 |
| 50 | 70 | 80 | 105 |
| 135 | 200 | | |

2. Set the flash coverage.

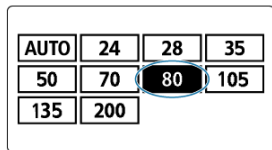
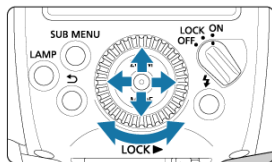

- Push the joystick up / down / left / right or turn < > to select the flash coverage, then push the joystick vertically.
- Select < **AUTO** > for automatic setting, or select a value (indicating the focal length mm) for manual setting.

Note

- When you set the flash coverage manually, set the same or a wider coverage than the angle of view for shooting to avoid darkening the periphery of the picture.
- When a lens with a focal length of less than 24 mm is attached, the < **WIDE** > warning is displayed on the LCD panel. When using a camera with the image sensor size smaller than full-frame, the < **WIDE** > warning is displayed when the actual shooting angle of view is wider than the angle of view of a 24 mm lens.
- When shooting with the sync terminals of the camera and the Speedlite connected by a commercially-available sync cord, set the flash coverage manually.

Wide Panel

When you use the flash's built-in wide panel, you can perform flash photography covering the angle of view of an ultra-wide angle lens with focal length as wide as 14 mm.

1. Pull out the wide panel.

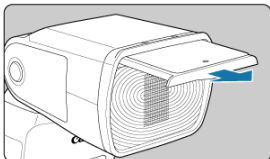

- Pull out the protruding area located in the center of the wide panel.
- The white catchlight panel is pulled out at the same time.

2. Push back the catchlight panel.

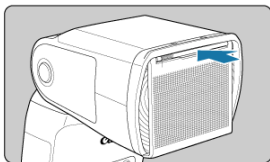

- Push back the catchlight panel only, keeping the wide panel down.

Caution

- Since underexposure may occur, the <  WP > warning is displayed on the LCD panel when using the wide panel with bounce flash.
- Do not pull out the wide panel with excessive force. Doing so may detach the wide panel from the Speedlite.
- Angle of view of EF15mm f/2.8 Fisheye or EF8-15mm f/4L Fisheye USM is not supported.



Note

- The flash coverage is set automatically when using the wide panel. It cannot be changed arbitrarily.

☑ [How to Set the Firing Output of the Manual Flash with the FE Memory Function](#)

☑ [Metered Manual Flash Exposure](#)

The flash output can be set in 1/3-stop increments from full flash (1/1) to 1/8192 flash. Use a flash meter (commercially-available) to determine the required flash output to obtain a correct flash exposure. Setting the camera's shooting mode to < **Av** > or < **M** > is recommended.

1. Select < **MODE** > with the joystick.

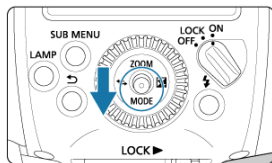

2. Set the flash mode to < **M** >.

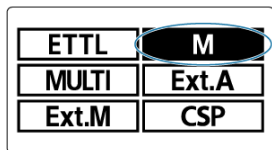

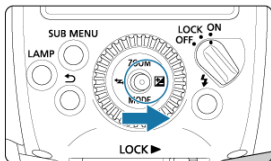

- Press the joystick up, down, left, or right, or turn <  > and select < **M** >, then press the joystick vertically.

3. Select <  > with the joystick.

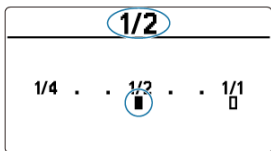

4. Set the flash output.



- Push the joystick to the left or right or turn <  > to set the flash output, then push the joystick vertically.

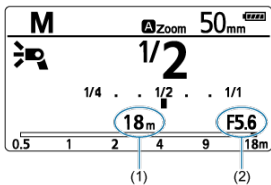

- When you press the camera's shutter button halfway, an indication of the shooting distance (1) and the aperture value (2) are displayed.

 **Note**

- If high-speed sync or optical transmission wireless is set, the setting range of the flash output will be 1/1 to 1/128.
- For guide number details with manual flash, see "[Specifications](#)".
- You can set the flash output by turning <  > directly without selecting < **MODE** > with the joystick ([C.Fn-13](#)).

How to Set the Firing Output of the Manual Flash with the FE Memory Function

You can set the firing output adjusted in firing mode < **ETTL** > as the firing output of the firing mode < **M** >.

1. Set the FE memory function.

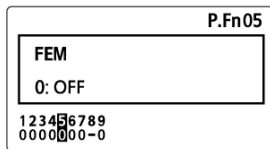

- Set the P.Fn-05 < **FEM** > setting in the personal functions to 1:ON (☑).

2. Shoot with the firing mode set to < **ETTL** >.

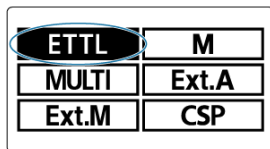

- Select < **MODE** > with the joystick.
- Press the joystick up, down, left, or right, or turn <  > and select < **ETTL** >, then press the joystick vertically.

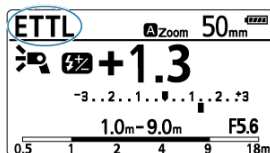

- Press the shutter button fully to shoot.

3. Set the flash mode to <M>.

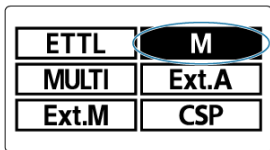

- Select <MODE> with the joystick.
- Press the joystick up, down, left, or right, or turn <⊙> and select <M>, then press the joystick vertically.

4. Check the flash output.

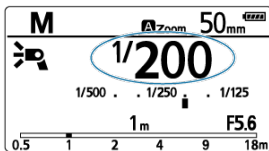

Caution

- To fire the flash with the < **ETTL** > setting, do so when the charging lamp is lit in red (fully charged).
- After shooting with the < **ETTL** > setting, if you make a change in the ISO sensitivity, aperture value or settings related to the firing output such as the light intensity, zoom, etc., we recommend that you shoot with the < **ETTL** > setting again.
- When the white balance of the camera is set to < **AWB** >, the color temperature difference between the flash and the surrounding ambient light is large, and when the flash compensation is set to the negative side and the [**E-TTL balance**] is set to [**Ambience priority**], the hue of the shot image may differ between the < **ETTL** > and < **M** > settings. If the color temperature difference is large, installing a color filter may improve the hue.
 - Fluorescent lamp (white daylight) → Color filter light
 - Tungsten lamp → Color filter dense
 - Sunlight → filter not required
- When you use the FE memory function in wireless multiple flash shooting, set the < **ETTL** > and < **M** > firing groups to the same configurations ahead of time. When < **ETTL** > is set to < **A:B C** >, set < **M** > to < **A:B:C** >.
- Depending on the shooting conditions, the < **ETTL** > of the effective flash range display and < **M** > of the shooting distance display may be different.

Note

- When P.Fn-05 < **FEM** > is set to 2:ON / **MODE** **ETTL** ↔ **M**, just push the joystick down to switch between < **ETTL** > and < **M** >.

Metered Manual Flash Exposure

When using an EOS-1D series camera, the flash exposure level can be manually set before shooting. This is effective when you are close to the subject. Use a 18% gray reflector (commercially available) and shoot as follows.

1. Configure the camera and Speedlite settings.

- Set the shooting mode of the camera to < **M** > or < **Av** >.
- Set the Speedlite's flash mode to < **M** >.

2. Focus on the subject.

- Focus on the subject manually.

3. Set up an 18% gray reflector.

- Place the gray reflector at the subject's position.
- Aim the camera so that the entire spot metering circle within the viewfinder center is over the gray reflector.

4. Press the <M-Fn>, < * >, or <FEL > button (ⓘ16).

- The Speedlite will fire a preflash and the required flash output for the correct flash exposure is retained in memory.
- On the right side of the viewfinder, the exposure level indicator will show the flash exposure level against the standard exposure.

5. Set the flash exposure level.

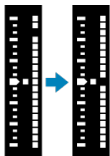

- Adjust the Speedlite's manual flash output and the aperture so that the flash exposure level aligns with the standard exposure index.

6. Take the picture.

- Remove the gray reflector and take the picture.



Note

- Metered manual flash exposure is available only with EOS-1D series cameras.

☑ [How to Determine the Shutter Speed](#)

When using stroboscopic flash with a slow shutter speed, you can shoot multiple successive movements within a single picture, similar to stop-motion pictures.

With stroboscopic flash, set the flash output, number of flashes, and flash frequency (number of flashes per second = Hz). For the maximum number of continuous flashes, see "[Maximum Number of Continuous Flashes](#)".

1. Select **<MODE>** with the joystick.

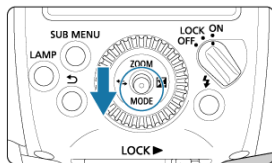

2. Set the flash mode to **<MULTI>**.

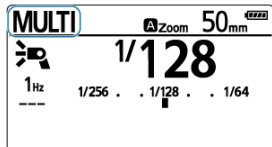
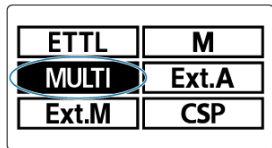

- Press the joystick up, down, left, or right, or turn **<⊙>** and select **<MULTI>**, then press the joystick vertically.

3. Push the joystick vertically to select an item.

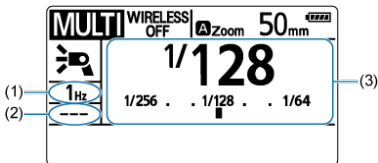
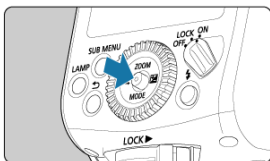

- Push the joystick up / down / left / right, or turn the \odot to choose either the firing frequency (1), firing count (2), or firing output (3), then push the joystick vertically.

4. Set the value.

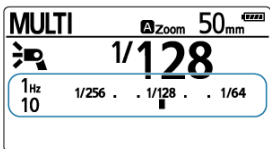
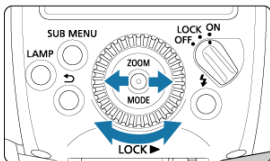

- Push the joystick to the left or right or turn \odot to set the value, then push the joystick vertically.
- Repeat Step 3 and 4 to set the flash frequency, number of flashes, and flash output.

How to Determine the Shutter Speed

To ensure that the shutter stays open until the end of the continuous flashes for stroboscopic flash, set the camera with a shutter speed calculated with the following equation.

Number of flashes + flash frequency = Shutter speed

For example, if the number of flashes is set to 10 (times) and flash frequency to 5 (Hz), set the shutter speed to 2 sec. or longer.

Caution

- To avoid degrading and damaging the flash head due to overheating, set repeated shooting with stroboscopic flash to 30 times or less. After shooting 30 times, allow a rest time of at least 10 min.
- If you shoot repeatedly more than 30 times, the safety function will activate and flash firing restriction will be carried out. If this happens, allow a rest time of at least 50 min.

Note

- When performing stroboscopic flash, combining a highly reflective subject with a dark background is most effective.
- We recommend using a tripod and a remote switch.
- Neither 1/1 power nor 1/2 power flash can be set.
- You can also perform stroboscopic flash even when the camera's shooting mode is set to <bulb (**B**)> (bulb shooting).
- When the number of flashes is displayed as "----", flashes are fired continuously until the shutter closes or the charge runs out. The [Maximum Number of Continuous Flashes](#) is shown in the table on the next page.
- High-speed sync () cannot be set during stroboscopic flash.

Maximum Number of Continuous Flashes

When the number of flashes is displayed as "----" (bar display), the maximum number of flashes is as shown in the table below.

| Flash output / Hz | 1 | 2 | 3 | 4 | 5 | 6-7 | 8-9 |
|-------------------|-----|-----|-----|-----|-----|-----|-----|
| 1/4 | 7 | 6 | 5 | 4 | 4 | 3 | 3 |
| 1/8 | 14 | 14 | 12 | 10 | 8 | 6 | 5 |
| 1/16 | 30 | 30 | 30 | 20 | 20 | 20 | 10 |
| 1/32 | 60 | 60 | 60 | 50 | 50 | 40 | 30 |
| 1/64 | 90 | 90 | 90 | 80 | 80 | 70 | 60 |
| 1/128 | 100 | 100 | 100 | 100 | 100 | 90 | 80 |
| 1/256 | 100 | 100 | 100 | 100 | 100 | 100 | 100 |
| 1/512 | 100 | 100 | 100 | 100 | 100 | 100 | 100 |
| 1/1024 | 100 | 100 | 100 | 100 | 100 | 100 | 100 |
| 1/2048 | 100 | 100 | 100 | 100 | 100 | 100 | 100 |
| 1/4096 | 100 | 100 | 100 | 100 | 100 | 100 | 100 |
| 1/8192 | 100 | 100 | 100 | 100 | 100 | 100 | 100 |

| Flash output / Hz | 10 | 11 | 12-14 | 15-19 | 20-50 | 60-199 | 250-500 |
|-------------------|-----|-----|-------|-------|-------|--------|---------|
| 1/4 | 2 | 2 | 2 | 2 | 2 | 2 | 2 |
| 1/8 | 4 | 4 | 4 | 4 | 4 | 4 | 4 |
| 1/16 | 8 | 8 | 8 | 8 | 8 | 8 | 8 |
| 1/32 | 20 | 20 | 20 | 18 | 16 | 12 | 10 |
| 1/64 | 50 | 40 | 40 | 35 | 30 | 20 | 15 |
| 1/128 | 70 | 70 | 60 | 50 | 40 | 40 | 30 |
| 1/256 | 100 | 100 | 100 | 100 | 80 | 80 | 60 |
| 1/512 | 100 | 100 | 100 | 100 | 100 | 100 | 100 |
| 1/1024 | 100 | 100 | 100 | 100 | 100 | 100 | 100 |
| 1/2048 | 100 | 100 | 100 | 100 | 100 | 100 | 100 |
| 1/4096 | 100 | 100 | 100 | 100 | 100 | 100 | 100 |
| 1/8192 | 100 | 100 | 100 | 100 | 100 | 100 | 100 |

☑ **<Ext.A>**: [Auto External Flash Metering](#)

☑ **<Ext.M>**: [Manual External Flash Metering](#)

The Speedlite's built-in external metering sensor measures the flash light reflected from the subject in real time and automatically stops the flash firing when the standard exposure is reached.

"Auto external flash metering" can be used with the EOS DIGITAL cameras released in and after 2007. "Manual external flash metering" can be used with all EOS cameras.

<Ext.A>: Auto External Flash Metering

You can shoot in fully automatic flash mode. The flash output is automatically adjusted according to the ISO speed and aperture set on the camera.

1. Select **<MODE>** with the joystick.

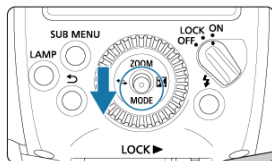

2. Set the flash mode to <Ext.A>.

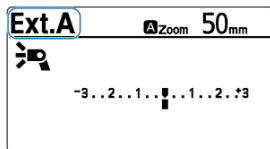
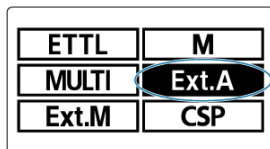

- Press the joystick up, down, left, or right, or turn <⊙> and select <Ext.A>, then press the joystick vertically.

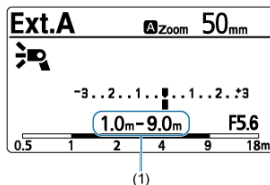

- When you press the camera's shutter button halfway, the effective flash range (1) is displayed.

Note

- When <Ext.A> is set, flash exposure compensation () and FEB shooting () can be performed.

<Ext.M>: Manual External Flash Metering

You can manually set the Speedlite with the ISO speed and aperture set on the camera. The flash output is automatically adjusted according to the ISO speed and aperture that you set.

1. Select <MODE> with the joystick.

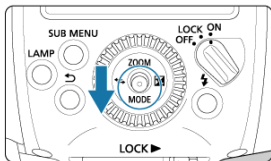

2. Set the flash mode to <Ext.M>.

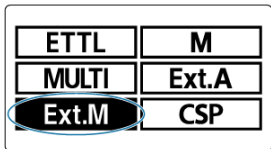

- Press the joystick up, down, left, or right, or turn <⊙> and select < Ext.M >, then press the joystick vertically.

3. Set the same ISO speed as on the camera.

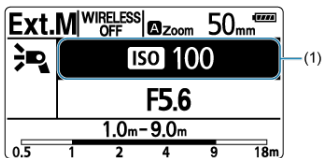

- Push the joystick vertically.
- Push the joystick up / down / left / right or turn < Ⓞ > to select item (1), then push the joystick vertically.

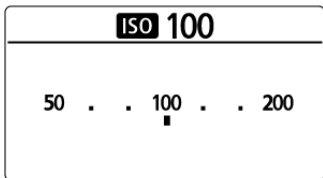

- Push the joystick to the left or right or turn < Ⓞ > to set the ISO speed, then push the joystick vertically.
- The ISO speed can be set within a range of ISO 25 to ISO 819200, in 1/3 increments.

4. Set the same aperture as on the camera.

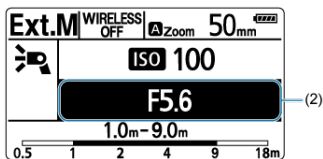

- Push the joystick up / down / left / right or turn < Ⓞ > to select item (2), then push the joystick vertically.

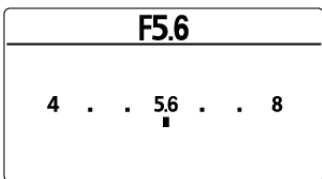

- Push the joystick to the left or right or turn < Ⓞ > to set the aperture value, then push the joystick vertically.
- The effective flash range corresponding to the preset ISO speed and aperture value is displayed.

 **Note**

- When shooting with the < **Ext.M** > setting and the sync terminals of the camera and the Speedlite connected by a commercially-available sync cord, you can shoot without attaching the flash to the camera.
- Even if you connect a different Speedlite to the Speedlite's sync terminal with a sync cord, it will not fire.

Depending on the camera, flash shooting may be carried out with the [CSP] (continuous shooting priority mode). In the continuous shooting priority mode, the flash output is automatically lowered by one stop compared to normal flash shooting, and the ISO speed is automatically raised by one stop instead. This is effective when taking continuous shots or when you want to save the battery power of the flash. For details, see the instruction manual of the camera that supports auto external flash metering.

1. Select <MODE> with the joystick.

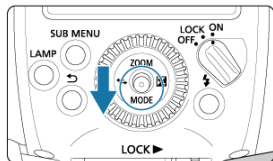

2. Set the flash mode.

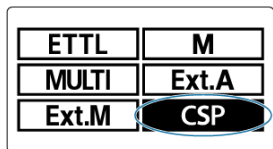

- Press the joystick up, down, left, or right, or turn <⊙> and select <CSP>, then press the joystick vertically.

Note

- If the aperture value is large or the distance to the subject is far, it will be difficult to achieve continuous flashes and reduce the battery consumption and so on.
- For cameras that do not support continuous shooting priority mode, the flash mode is set to <ETTL> when shooting.

About the Modeling Lamp

Press the <LAMP> button and the modeling lamp will light up for 5 minutes. Press again to turn off the light.

This is useful when you want to check how the subject will cast shadows due to the flash light.

The modeling lamp turns off automatically when you press the camera's shutter button fully.

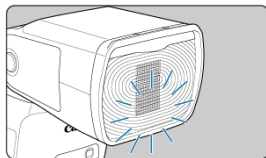
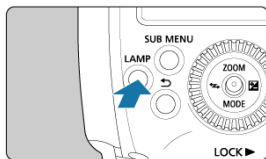

Caution

- Looking directly at the modeling lamp from a short distance can cause visual impairment.
- If you shoot with the modeling lamp lit, underexposure may result. Perform exposure compensation and flash exposure compensation where necessary.
- When the flash does not fire, such as when the flash is disabled or when shooting a movie, the modeling lamp does not turn off automatically even if you press the shutter button fully.
- A warning screen appears when the temperature of the modeling lamp rises (🔥).
- If the ambient temperature of the modeling lamp becomes too high, the lamp may dim or turn off.

Note

- You can change how the modeling lamp is lit (C.Fn-18).
- You can adjust the brightness and color temperature of the modeling lamp (P.Fn-08).
- You can select the lighting time of the modeling lamp (P.Fn-09).
- The brightness drops when you use a wide panel, bounce adapter, or color filter.

When you press the aperture button on the camera, the flash fires continuously for about 1 second. This function is called "modeling flash". This is useful for checking shadows cast on the subject by the flash light and the lighting balance during wireless flash shooting (C.Fn-02, C.Fn-03).

1. Press the depth-of-field preview button on the camera.

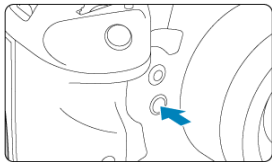

- The flash fires continuously for approx. 1 sec.

Caution

- To avoid degrading and damaging the flash head due to overheating, set the number of modeling flashes to 55 or less. After firing the modeling flash for the above listed number of times, allow a rest time of at least 50 minutes.
- If you fire the modeling flash for the above listed number of times, and then fire the flash again repeatedly at short intervals, the safety function will activate and flash firing restriction will be carried out. When the flash firing restriction level is 1, the firing interval is automatically set to about 8 seconds. If this happens, allow a rest time of at least 50 min.
- During Live View shooting, firing the modeling flash (by operating the camera) is not possible.
- Modeling flash cannot be fired (by an operation on the camera side) when the flash is used in combination with the EOS R6, EOS R5, EOS RP, EOS R, EOS M6 Mark II, EOS M50, EOS M6, EOS M5, EOS M3, EOS M2, EOS M, EOS Elan II/Elan II E/50/50E, EOS REBEL 2000/300, EOS REBEL G/500N, EOS REBEL K2/3000V, EOS REBEL XS N/REBEL G II/3000N/66, EOS IX, or EOS IX Lite/IX7. Set C.Fn-02 to 1 or 2 (C.Fn-02) and use the test flash button to perform modeling flash.

Note

- During normal flash shooting or when using the flash as the sender unit in radio transmission / optical transmission wireless shooting, you can fire the modeling flash with the test flash button (C.Fn-02).

Color Filter

When shooting with flash under incandescent illumination (a tungsten light source), reddish, unnatural colors may result on the subject's background where the flash light does not reach. By attaching the provided color filter to the flash, automatic correction is made by the camera's white balance function so that both the subject and background can be shot with appropriate white balance.

| Filter | Contrast | Correction effect | Application |
|-----------------------|----------|-------------------|--|
| Color filter (orange) | Light | Weak | Compensates for the effect of an incandescent light bulb |
| | Dense | Strong | |

1. Attach the color filter.

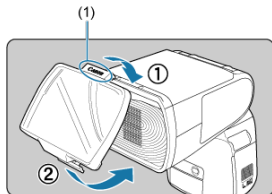

(1) "Canon" logo

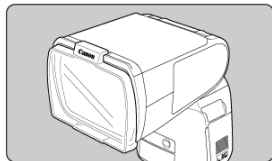

- Attach the filter securely to the flash head until it clicks in place as shown in the figure.
- Check that the display changes to $\langle \text{WB} \text{ icon} \rangle$.
- To remove the filter, follow the procedure in reverse order. Raise the attachment tab on the lower side of the filter and remove the filter from the flash head.

2. Take the picture.

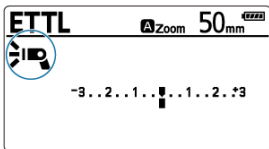

- Set the camera's white balance to $\langle \text{⚡} \rangle$, then take the picture.
- With EOS DIGITAL cameras released in and after 2012, you can also set the white balance to $\langle \text{AWB} \rangle$ for shooting (except with EOS REBEL T5/1200D).
- Check the resulting image and perform white balance correction on the camera as required.

⚠ Caution

- The flash guide number decreases when you use the color filter. When performing manual flash or stroboscopic flash, compensate the flash output by approx. +1/3 stop with the "Low density" filter and by approx. +1 stop with the "High density" filter.
- Do not use a commercially-available color filter in combination with the provided color filter.

📄 Note

- With cameras that are not compatible with color temperature information transmission (🔗), take a shot and set it for manual white balance using the color filter in the shooting environment, set the white balance to $\langle \text{☀} \rangle$, and shoot.
- When shooting with a flash with a color filter and wide angle lens attached, the peripheral light intensity may drop.
- If dirt or dust adheres to the color filter, wipe it off with a soft, dry cloth.
- You can also attach the bounce adapter (🔗) when using the color filter.
- If you want to shoot with the ambiance of tungsten-light (warm color cast), set the white balance compensation toward the amber side.

You can revert the settings of the Speedlite shooting functions and wireless shooting settings to their defaults.

1. Press the **<SUB MENU>** button.

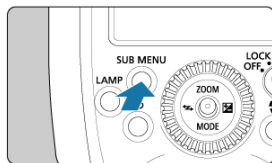

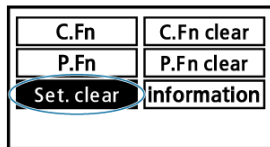

2. Select **<Set. clear>**.

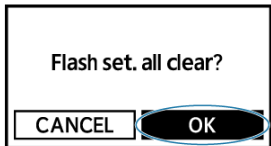
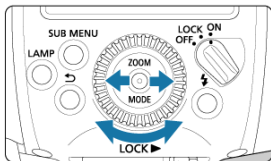

- Press the joystick up, down, left, or right, or turn **<⊙>** and select **<Set. clear>**, then press the joystick vertically.

3. Clear the settings.



- Press the joystick to the left or right, turn <  > to select < **OK** > to select, then push the joystick vertically.
- The Speedlite settings are cleared, and normal shooting and < **ETTL** > flash mode will be set.

Note

- Even when the settings have been cleared, the transmission channel and wireless radio ID for wireless shooting as well as the settings of the Custom Functions (C.Fn) and Personal Functions (P.Fn) will not be cleared.

Flash Function Settings with Camera Controls

This chapter describes how to set the flash functions from the camera's menu screen.

Caution

- When the camera's shooting mode is set to a fully automatic mode or a Basic Zone mode, the operations in this chapter are not available. Set the camera's shooting mode to < **Fv** > < **P** > < **Tv** > < **Av** > < **M** > < bulb (**B**) > (Advanced shooting zone).

- [Flash Control from the Camera's Menu Screen](#)

Flash Control from the Camera's Menu Screen

[☑ Flash Function Settings](#)

[☑ Settings Available on the Flash Function Settings Screen](#)

[☑ Flash C.Fn Settings](#)

When using EOS DIGITAL cameras released in and after 2007, you can set flash functions or Custom Functions from the camera's menu screen.

For camera operations, refer to the camera's Instruction Manual.

Flash Function Settings

1. Select [External Speedlite control].

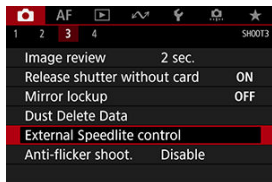

- Select [**External Speedlite control**] or [**Flash control**].

2. Select [Flash function settings].

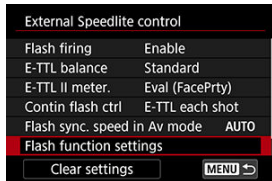

- Select [**Flash function settings**] or [**External flash func. setting**].
- The setting screen is displayed.

3. Set the function.

- The setting screen and items displayed vary depending on the camera.
- Select an item and set the function.

Example 1

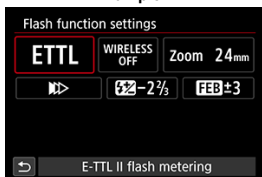

Example 2

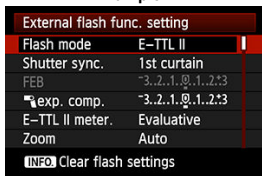

Settings Available on the Flash Function Settings Screen

● EOS DIGITAL cameras released in and after 2012

On the camera's [**Flash function settings**] or [**External flash func. setting**] screen, you can configure normal shooting, radio transmission wireless shooting, or optical transmission wireless shooting settings.

* Although the EOS REBEL T100/4000D/3000D, EOS REBEL T7/1500D/2000D, EOS REBEL T6/1300D and EOS REBEL T5/1200D was released from 2012 onwards, the settable functions are the same as with the EOS DIGITAL cameras released from 2007 to 2011.

● EOS DIGITAL cameras released from 2007 to 2011

EOS-1Ds Mark III, EOS-1D Mark IV/III, EOS 5D Mark II, EOS 7D, EOS 60D, EOS 50D, EOS 40D, EOS REBEL T3i/600D, EOS REBEL T2i/550D, EOS REBEL T1i/500D, EOS REBEL XSi/450D, EOS REBEL T3/1100D, EOS REBEL XS/1000D

On the camera's [**Flash function settings**] or [**External flash func. setting**] screen, you can configure the normal shooting or optical transmission wireless shooting settings. To use "Radio transmission wireless shooting", set the functions by operating the flash.

The configurable functions are as follows. The settings available vary by the camera used, flash mode, and wireless function settings, etc.

| Function | |
|------------------------------|---|
| Flash firing | Enable / Disable |
| E-TTL balance | Ambience priority / Standard / Flash priority |
| E-TTL II meter. | Eval (FacePrty) / Evaluative / Average |
| Contin flash ctrl | E-TTL each shot / E-TTL 1st shot |
| Flash sync. speed in Av mode | |
| Flash mode | E-TTL II flash metering (Autoflash) / Manual flash / MULTI flash (stroboscopic) / Auto external flash metering / Manual external flash metering / Continuous shooting priority mode |
| Wireless functions | Wireless:Off / Radio Transmission / Optical Transmission |
| Flash zoom (flash coverage) | |
| Shutter synchronization | First-curtain synchronization / Second-curtain synchronization / High-speed synchronization |
| Flash exposure compensation | |
| Flash exposure bracketing | |

● Flash firing

To perform flash photography, set to [**Enable**]. To use the flash's AF-assist beam only, set to [**Disable**].

- **E-TTL balance**

You can set the finish (taste) of the flash photo according to your preference. Depending on the settings, you can change the flash ratio between the ambient light and flash light.

- **E-TTL II meter.**

When this is set to [**Eval (FacePrty)**], the flash is adjusted to suit the subject. The continuous shooting speed during high-speed continuous shooting is lower than [**Evaluative**] or [**Average**]. When [**Evaluative**] is set, flash control is performed with priority given to firing during continuous shooting. If [**Average**] is set, the flash exposure will be averaged for the entire scene metered. Flash exposure compensation may be necessary depending on the scene.

- **Contin flash ctrl**

When this is set to [**E-TTL each shot**], the flash is adjusted for every shot. When this is set to [**E-TTL 1st shot**], the flash is adjusted only once before continuous shooting. The second and subsequent shots will also be taken with the flash output of the first shot. Effective when you want to prioritize the continuous shooting speed without changing the composition.

- **Flash sync. speed in Av mode**

You can set the flash synchronization speed when shooting in the < **Av** > aperture-priority AE mode with Speedlite.

- **Flash mode**

You can select the flash mode from [**E-TTL II flash metering**], [**Manual flash**], [**MULTI flash (stroboscopic)**], [**Auto external flash metering**], and [**Manual external flash metering**] or [**Continuous shooting priority mode**] to suit your desired flash photography.

- **Wireless functions**

You can set radio transmission wireless flash shooting and optical transmission wireless flash shooting. For details, refer to "[Radio Transmission Wireless Flash Shooting](#)" and "[Optical Transmission Wireless Flash Shooting](#)".

- **Flash zoom (flash coverage)**

You can set the Speedlite flash coverage. When [**Auto**] is selected, the flash coverage is set automatically according to the focal length of the shooting lens and the image sensor size of the camera (🔍).

● Shutter synchronization

You can select the flash firing timing / method from [**First-curtain synchronization**], [**Second-curtain synchronization**], or [**High-speed synchronization**]. To perform normal flash shooting, set [**First-curtain synchronization**].

● Flash exposure compensation

With a similar procedure as exposure compensation, you can adjust the flash output. The flash exposure compensation amount can be set up to ± 3 stops in 1/3-stop increments.

● Flash exposure bracketing

You can take three shots while automatically changing the flash output. The settable range is up to ± 3 stops in 1/3-stop increments.

● Clear settings

When [**Clear flash settings**] or [**Clear settings**] is selected, you can revert the settings of the flash to their default settings.



Caution

- If the flash coverage is automatically set such as when the bounce adapter is attached or the wide panel is used, setting [**Flash zoom**] (flash coverage) is not possible.



Note

- [**Built-in flash firing**] and [**E-TTL II meter.**] are displayed in step 2 or step 3 in the "[Flash Function Settings](#)" (Display layouts and procedures vary by camera model).
- When the flash exposure compensation is set on the flash, flash exposure compensation cannot be performed from the camera. If both are set at the same time, priority is given to the setting on the flash.

Flash C.Fn Settings

You can set Custom Functions for the flash from the camera's menu screen. The details displayed vary by the camera used. If C.Fn-21 to 23 are not displayed, set them by operating the Speedlite. For custom functions, refer to "[Settings that can be changed with Custom Functions](#)".

1. Select [Flash C.Fn settings].

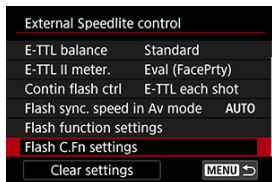

- Select [Flash C.Fn settings] or [External flash C.Fn setting].

2. Set the Custom Function.

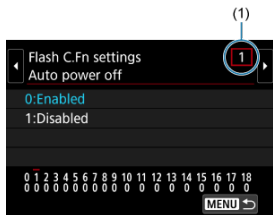

- Select the Custom Function number (1), then set the function.

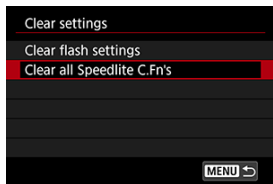

- To clear all the Custom Function settings, select [**Clear settings**] in step 1, and select [**Clear all Speedlite C.Fn's**] or [**Clear ext. flash C.Fn set.**].

⚠ Caution

- When using a camera released in 2011 or earlier, or with EOS REBEL T100/4000D/3000D, EOS REBEL T7/1500D/2000D, EOS REBEL T6/1300D or EOS REBEL T5/1200D, the C.Fn-21 to 23 settings are not cleared even if [**Clear all Speedlite C.Fn's**] or [**Clear ext. flash C.Fn set.**] is selected. When the procedure described in "Clearing All the Custom/Personal Functions" on page is performed (🔗), all the Custom Functions (except C.Fn-00) are cleared.
- Personal Functions ([P.Fn](#)) cannot be set or all cleared at once from the camera's menu screen. Set them by operating the flash.

Radio Transmission Wireless Flash Shooting

This chapter describes how to use strobe shooting using the radio transmission wireless sender / receiver function.

See the system map (🔗) for the accessories required for radio transmission wireless flash shooting.

⚠ Caution

- When the camera's shooting mode is set to a fully automatic mode or a Basic Zone mode, the operations in this chapter are not available. Set the camera's shooting mode to <Fv> <P> <Tv> <Av> <M> <bulb (B)> (Advanced shooting zone).
- When prioritizing radio transmission wireless flash shooting, do not operate the power switch, open the battery storage unit cover, etc. The wireless connection will be terminated.

📄 Note

- The EL-1 attached to the camera is called a "sender unit" while the Speedlite controlled wirelessly is called a "receiver unit".
- The EL-1 allows remote release (remote shooting) from the receiver unit (🔗). For details, refer to the Instruction Manual of the Speedlite that is equipped with the remote release function.

- [Radio Transmission Wireless Flash Shooting](#)
- [Radio Transmission Wireless Settings](#)
- [Automatic Flash Photography with 1 Flash Receiver](#)
- [Automatic Flash Photography with Receivers divided into 2 Groups](#)
- [Automatic Flash Photography with Receivers divided into 3 Groups](#)
- [Wireless Multiple Flash Shooting with a set Flash Ratio](#)
- [Shooting in a Different Flash Mode for Each Group](#)
- [Test Flash / Modeling Flash from a Receiver Unit](#)
- [Remote Release from a Receiver Unit](#)
- [Linked Shooting with Radio Transmission](#)

Radio Transmission Wireless Flash Shooting

- [☑ Positioning and Operation Range](#)
- [☑ Difference between Radio Transmission and Optical Transmission](#)
- [☑ Group Control](#)
- [☑ Restrictions on Functions Depending on the Camera Used](#)

Using a Canon Speedlite with a radio transmission wireless shooting function, you can easily perform wireless multiple flash shooting in the same way as normal E-TTL II / E-TTL autoflash strobe photography.

The system is designed so that the settings of the EL-1 (sender unit) are automatically applied to the wirelessly controlled Speedlite (receiver unit). Therefore, you do not need to operate the receiver unit during shooting.

Positioning and Operation Range

- Automatic Flash Photography with 1 Flash Receiver (📷)

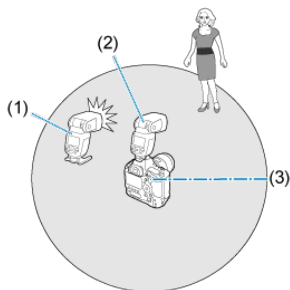

(1) **RECEIVER** EL-1

(2) **SENDER** EL-1

(3) Transmission distance: Approx. 30 m / 98.4 ft.

● Automatic Flash Photography with Receivers divided into Groups (☑, ☑)

You can divide the receiver units into two or three groups and perform E-TTL II / E-TTL autoflash shooting while changing the flash ratio (flash output rate).

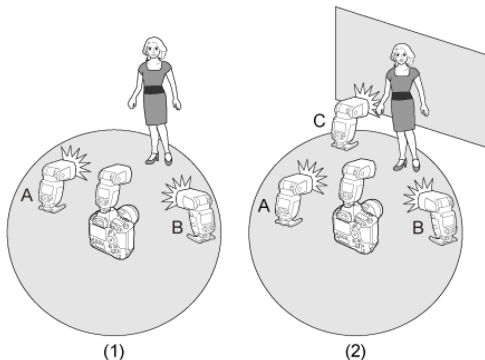

- (1) 2 (A, B) groups
(2) 3 (A, B, C) groups

⚠ Caution

- Before shooting, perform a test flash (☑) and test shooting.
- The transmission distance may be shorter depending on the conditions such as the positioning of the flashes, the surrounding environment, and weather conditions.

📄 Note

- Using the mini stand provided with the receiver unit, position the receiver unit.

● Shooting in a Different Flash Mode for Each Group (🔗)

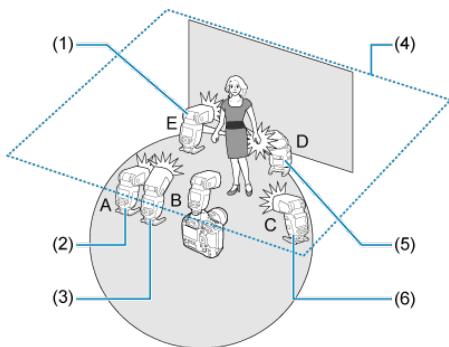

* The flash mode settings are indicated only as an example.

- (1) E-TTL II
- (2) E-TTL II
- (3) Manual flash
- (4) Ceiling
- (5) Manual flash
- (6) Manual flash

Difference between Radio Transmission and Optical Transmission

Wireless shooting using radio transmission provides some advantages over wireless shooting using optical transmission, such as less interference from obstacles and not having to point the receiver's wireless sensor toward the sender unit. The main functional differences are as follows.

| Function | Radio transmission | Optical transmission |
|-----------------------|--|-----------------------------------|
| Transmission distance | Approx. 30 m / 98.4 ft. | Approx. 15 m / 49.2 ft. (indoors) |
| Firing group control | Up to 5 groups * ¹ (A, B, C, D, E) | Up to 3 groups (A, B, C) |
| Receiver control | Up to 15 | No restriction |
| Channel | Auto, Ch. 1 - 15 | Ch. 1 - 4 |
| Wireless radio ID | 0000 - 9999 | - |
| Receiver controls | Test flash | ○ |
| | Modeling flash | ○ * ² |
| | Release | ○ * ³ |

* 1-3: Restrictions exist depending on the camera (*1: [Restrictions on Functions Depending on the Camera Used, Shooting in a Different Flash Mode for Each Group](#), *2: [Test Flash / Modeling Flash from a Receiver Unit](#), *3: [Remote Release from a Receiver Unit](#)).

Group Control

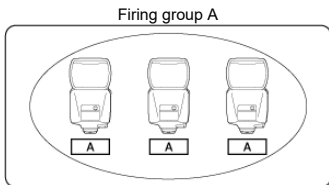

If you need more flash output or wish to perform more sophisticated lighting, you can increase the number of receiver units. Simply set an additional receiver unit to the firing group (A, B, or C) whose flash output you want to increase.

For example, if you set a firing group with three receiver units to < **A** >, the three units are treated and controlled as a single firing group A with a large flash output.

Caution

- To fire the 3 firing groups A, B and C together, select < **A:B C** >. With the < **A:B** > setting, firing group C does not fire.
- If you shoot with firing group C pointing directly toward the main subject, overexposure may result.

Note

- The flash ratio of 8:1 to 1:1 to 1:8 is equivalent to 3:1 to 1:1 to 1:3 (1/2-stop increments) when converted to the number of stops.

Restrictions on Functions Depending on the Camera Used

Depending on the camera, functions in radio transmission wireless strobe photography may be limited.

● EOS DIGITAL cameras released in and after 2012

When using the flash with EOS DIGITAL cameras released in and after 2012, you can shoot without any restrictions on the flash mode and flash synchronization speed, etc.

* Although EOS REBEL T100/4000D/3000D, EOS REBEL T7/1500D/2000D, EOS REBEL T6/1300D and EOS REBEL T5/1200D were released after 2012, restrictions on functions are the same as with EOS DIGITAL cameras released up to 2011 (See the following explanation for details).

● EOS cameras compatible with E-TTL and released up to 2011

When using the flash with the cameras listed below, radio transmission wireless shooting using E-TTL autofocus is not possible. Use manual flash (☑) or optical transmission wireless strobe photography (☑).

EOS-1Ds, EOS-1D, EOS-1V, EOS-3, EOS Elan II/Elan II E/50/50E,
EOS REBEL 2000/300, EOS REBEL G/500N,
EOS REBEL XS N/REBEL G II/3000N/66, EOS IX, EOS IX Lite/IX7

Also, when using the flash with an EOS DIGITAL camera or EOS film camera released up to 2011, the following restrictions apply.

(1) **The maximum flash synchronization shutter speed is one step slower.**

Check the maximum flash sync shutter speed ($X = 1/**$ sec.) of your camera and shoot with a shutter speed up to 1 stop slower than the maximum flash sync shutter speed (Example: At $X = 1/250$ seconds, radio transmission wireless strobe photography is possible within a range of $1/125$ to 30 seconds.).

If you lower the shutter speed by one step from the maximum flash synchronization shutter speed, the **< Tv >** warning icon will disappear.

(2) **High-speed sync shooting is not possible.**

(3) **Group firing (☑) is not possible.**

(4) **Modeling flash from the receiver (☑) and remote release from the receiver (☑) are not possible.**

(5) **It cannot be used as a "receiver camera" during linked shooting (☑).** It can only be used as a "sender camera".

Radio Transmission Wireless Settings

- [Sender Settings](#)
- [Receiver Settings](#)
- [Setting the Transmission Channel / Wireless Radio ID](#)
- [≤ LINK > Lamp and Connection Indication](#)
- [Sender Unit\(s\) Flash Firing ON / OFF](#)
- [Memory Function](#)

E-TTL II / E-TTL During radio transmission wireless shooting with autoflash photography, use the following steps to set the sender and receiver.

Sender Settings

1. Select <  > with the joystick.

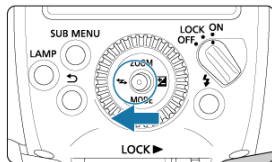

2. Set to < ((P)) **SENDER** >.

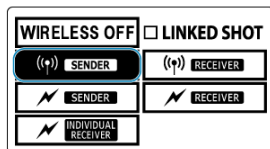

- Press the joystick up, down, left, or right, or turn < (O) > and select < ((P)) **SENDER** >, then press the joystick vertically.

3. Select the firing method.

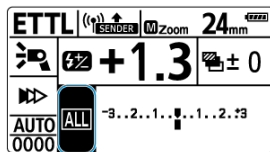

(1)

- Push the joystick vertically.
- Push the joystick up / down / left / right or turn < (O) > to select item (1), then push the joystick vertically.
- Push the joystick to the left or right, turn < (O) > to select from < **ALL** > < **A:B** > < **A:B C** >, then push the joystick vertically.

Receiver Settings

1. Set to < ((P)) **RECEIVER** >.

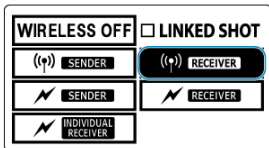

- Operate and set the flash you want to set as the receiver unit.
- Select < ((P)) **RECEIVER** > in the same way as for the sender unit setting.

⚠ Caution

- To perform normal flash shooting, select < **WIRELESS OFF** > to clear the wireless (sender / receiver) settings.

Setting the Transmission Channel / Wireless Radio ID

Use the following procedure to set the transmission channel and wireless radio ID of the sender unit. **Set the same channel and ID for both the sender unit and receiver unit.** For details on the receiver operation procedure, refer to the Instruction Manual of the Speedlite equipped with the radio transmission wireless receiver function.

Caution

- When establishing multiple radio transmission wireless flash systems in a place, interference between flash systems may occur even if the flashes are set to different transmission channels. Set different wireless radio IDs for each channel.

1. Push the joystick vertically.

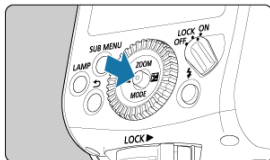

2. Select Item (1).

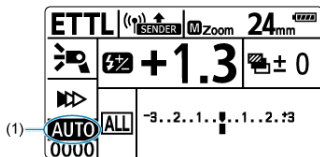

- Push the joystick up / down / left / right, or turn  to select a channel item, then push the joystick vertically.

3. Set a transmission channel.

| | | | |
|-------------|----|----|----|
| AUTO | 1 | 2 | 3 |
| 4 | 5 | 6 | 7 |
| 8 | 9 | 10 | 11 |
| 12 | 13 | 14 | 15 |

- Press the joystick up / down / left / right or turn < Ⓢ > to select from < **AUTO** > or Ch.1 to 15, then push the joystick vertically.

4. Select Item (2).

| | | | | |
|-------------|-------------|----------------------|-------|------|
| ETTL | (↑) | SENDER | MZoom | 24mm |
| 🔦 | 🔋 | +1.3 | 📏 | ± 0 |
| ▶▶ | | | | |
| AUTO | ALL | -3..2..1..0..1..2..3 | | |
| (2) — | 0000 | | | |

- Select the ID item using the same operation as the transmission channel setting, then push the joystick vertically.

5. Set the wireless radio ID.

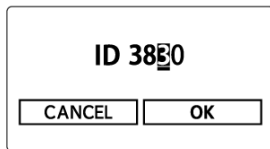

- Push the joystick to the left or right or turn < Ⓞ > to select the position (digit) to set, then push the joystick vertically.
- Push the joystick up or down or turn < Ⓞ > to select a number from 0 to 9, then push the joystick vertically.
- Set a 4-digit number with the same procedure and select < **OK** >.



- When transmission between the sender unit and receiver unit is established, the < **LINK** > lamp is lit in green.

Scanning and Setting the Sender Unit Transmission Channels

You can scan the radio reception status and set the sender unit's transmission channel automatically or manually. When the channel is set to "AUTO", the channel with the best reception signal is reset automatically. When setting the channel manually, you can reset the transmission channel while referring to the scan results.

● Scanning when "AUTO" is set

1. Press the <SUB MENU> button.

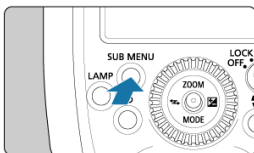

2. Run the scan.

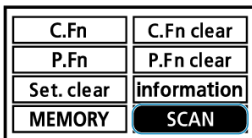

- Press the joystick up, down, left, or right, or turn < Ⓞ > and select < **SCAN** >, then press the joystick vertically.
- Choose < **OK** >.
- The scan is performed, and the channel with the best reception signal is reset.

● Scanning when a channel between Ch. 1 and 15 is set

1. Press the <SUB MENU> button.

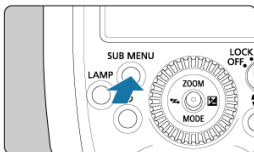

2. Run the scan.

- Press the joystick up, down, left, or right, or turn < Ⓞ > and select < **SCAN** >, then press the joystick vertically.
- Choose < **OK** >.
- The scan is performed and the reception status is displayed in a graph.
- The higher the peak of the channel in the graph, the better the radio reception signal.

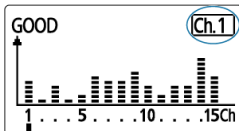

3. Set the channel.

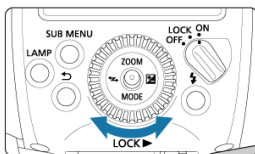

- Push the joystick up / down / left / right or turn < Ⓞ > to select from Ch.1 to 15.
- Push the joystick vertically to set the channel.

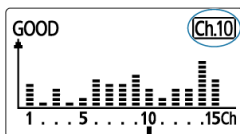

<LINK> Lamp and Connection Indication

You can check the transmission status by the lighting status of the <LINK> lamp or the icon on the LCD panel.

| Status | Description | Action |
|----------|-------------------------------|--|
| Lit | Transmission OK | — |
| Off | Not connected | Checking the channel and ID |
| Off | Too many units | Set the total number of sender and receiver units to 16 or less. |
| Blinking | Error | Turn the sender unit and receiver unit off and on again. |
| Lit | Transmission OK* ¹ | — |
| Lit | Transmission OK* ² | — |

* 1: When sender side is connected to the sub-sender

* 2: When the sender side is connected for continuous shooting

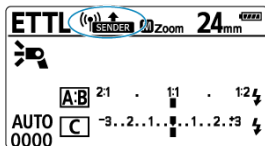

| Display | Description | Action |
|---------|-------------------------------|--|
| | Transmission OK | — |
| | Not connected | Checking the channel and ID |
| | Too many units | Set the total number of sender and receiver units to 16 or less. |
| | Error | Turn the sender unit and receiver unit off and on again. |
| | Transmission OK* ¹ | — |

* 1: When sender side is connected to the sub-sender

! Caution

- If the transmission channels of the sender unit and receiver unit are different, the receiver unit will not fire. Set both to the same number or set both to "AUTO".
- If the wireless radio IDs of the sender unit and receiver unit are different, the receiver unit does not fire. Set to the same number.

Sender Unit(s) Flash Firing ON / OFF

You can set whether or not to fire the sender unit as a wireless flash that controls the receiver unit. When sender flash firing is turned ON, the flash fires as firing group A.

1. Push the joystick vertically.

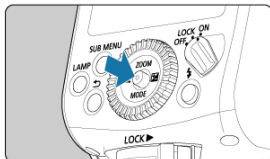

2. Select an item in (1).

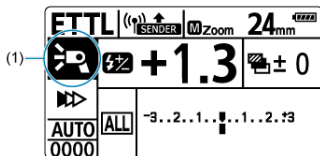

- Push the joystick up / down / left / right or turn <  > to select an item, and push the joystick vertically.

3. Set sender flash firing.

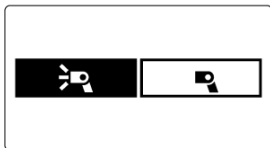

- Turn < Ⓞ > to select sender flash firing ON / OFF, then push the joystick vertically.
 - < ◻Ⓞ >: Sender flash firing ON
 - < ◻ >: Sender flash firing OFF

Memory Function

You can save the wireless settings to the sender unit and receiver unit and recall the settings later. Operate each sender or receiver unit individually to save or recall its settings.

1. Press the **<SUB MENU>** button.

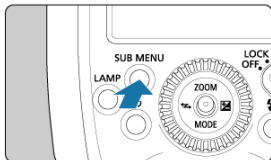

2. Select **<MEMORY>**.

| | |
|---------------|-------------|
| C.Fn | C.Fn clear |
| P.Fn | P.Fn clear |
| Set. clear | information |
| MEMORY | SCAN |

- Press the joystick up, down, left, or right, or turn **<⊙>** and select **<MEMORY>**, then press the joystick vertically.

3. Save or load the settings.

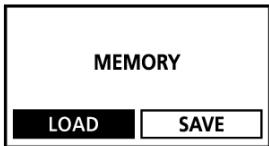

Save

- Press the joystick to the left or right, turn < Ⓞ > to select < **SAVE** > to select, then push the joystick vertically.
- Press the joystick to the left or right, turn < Ⓞ > to select < **OK** > to select, then push the joystick vertically.
- The settings are saved (stored in the memory).

Load

- Press the joystick to the left or right, turn < Ⓞ > to select < **LOAD** > to select, then push the joystick vertically.
- Press the joystick to the left or right, turn < Ⓞ > to select < **OK** > to select, then push the joystick vertically.
- The settings that were saved are set.

Automatic Flash Photography with 1 Flash Receiver

- [About the LCD Panel Illumination](#)
- [Multiple Flash Photography with Wireless Functions](#)
- [About Sender Unit\(s\)](#)

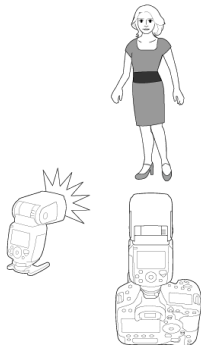

This section describes basic fully automatic wireless shooting when using a EL-1 attached to the camera (sender) and a EL-1 set as a receiver unit.

1. Set the sender unit.

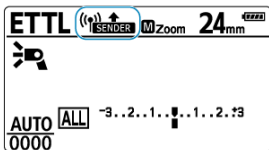

- Set the EL-1 attached to the camera to "Sender Unit" (☑).
- You can also use a device equipped with a radio transmission wireless sender function as a sender unit.

2. Set the receiver unit.

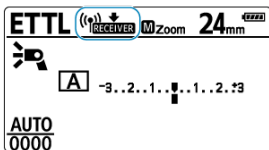

- Set the EL-1 to be controlled wirelessly from the sender as the receiver unit (☑).
- You can also use other EX-series Speedlites that are equipped with a radio transmission wireless receiver function.

3. Check the channel and ID.

- If the transmission channels and wireless radio IDs of the sender unit and receiver unit are different, set them to the same settings (☑).

4. Position the camera and flash.

- Position them within the range shown at "[Positioning and Operation Range](#)".

5. Use the joystick on the sender to select <MODE>.

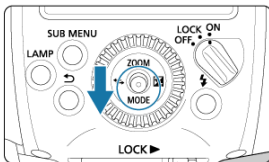

6. Set the flash mode to <ETTL>.

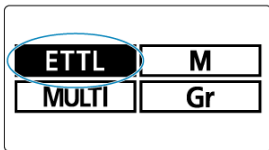

- Press the joystick up, down, left, or right, or turn <⊙> and select < **ETTL** >, then press the joystick vertically.
- The receiver unit is set automatically to < **ETTL** > during shooting, controlled by the sender unit.
- Check that the firing group control is set to < **ALL** >.

7. Check transmission status and charging.



- Check that the <LINK> lamp is lit in green.
- When the receiver flash is ready, the AF-assist beam emitter blinks at approx. 1-second intervals.
- When the sender unit is set to P.Fn-06-0 (Ⓜ), the sender unit's beep will sound when recharging of all flash units is completed.

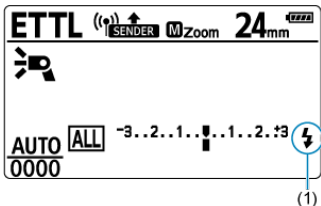

- Check that the <⚡> icon (1) is lit on the sender / receiver unit's LCD panel (<CHARGE> is not displayed).
- For details of the LCD panel illumination of the sender, refer to [About the LCD Panel Illumination](#).

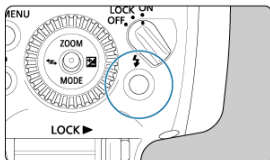

- Check that the sender unit's flash-ready lamp is lit.

8. Check the operation.

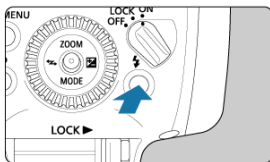

- Press the sender unit's test flash button.
- The Speedlite will fire. If it does not fire, check that it is placed within the transmission range (☑).



9. Take the picture.

- Set the camera and take the picture in the same way as with normal flash shooting.

⚠ Caution

- When the <LINK> lamp is off, radio transmission is not possible. Check the transmission channels and wireless radio IDs of the sender unit and receiver unit again. If you cannot connect with the same settings, turn the sender unit and receiver unit off and on again.

 **Note**

- The flash coverage of the sender unit and receiver unit is set to 24 mm. You can also set the flash coverage manually.
- It can also fire a flash on the sender ()
- You can press the depth-of-field preview button on the camera to fire the modeling flash ()
- When set as the sender unit, the time until auto power off takes effect is approx. 5 min.
- If the receiver unit's auto power off takes effect, press the sender unit's test flash button to turn on the receiver unit.
- You cannot use the test flash when operating the flash timer, etc. on the camera end.
- You can change the time until the receiver unit's auto power off takes effect ([C.Fn-10](#)).
- You can enable a beep to sound when recharging of all the flash units (sender / receiver units) is complete ([P.Fn-06](#)).
- You can disable the blinking of the AF-assistant beam emitter when the receiver unit is fully charged ([C.Fn-23](#)).

About the LCD Panel Illumination

During radio transmission wireless shooting, the light on the sender's display panel will either be on or off according to the charge status of the sender and receiver (flash group). The sender unit's LCD panel illumination is lit when the sender unit and receiver units are not fully charged. When the sender unit and receiver units are fully charged, the LCD panel illumination will turn off after approx. 12 sec.





When the charging of the sender unit and receiver unit starts as you take pictures, the sender unit's LCD panel will be illuminated again.

Caution

- If the sender unit or any of the receiver units (firing group) are not fully charged, < **CHARGE** > will be displayed on the sender unit's LCD panel. Check that < **CHARGE** > is not displayed on the LCD panel, and take a picture.

Multiple Flash Photography with Wireless Functions

Since the following functions set on the sender unit will be set automatically to the receiver units on this wireless system, you do not need to operate the receiver unit(s). For this reason, you can perform wireless flash photography in the same way as normal flash photography.

- [Flash Exposure Compensation](#) <  >
- [FEB](#) <  >
- [FE Lock](#)
- [High-Speed Sync](#) <  >
- [Second-Curtain Sync](#) <  >
- [Manual Flash](#)
 - [Wireless Multiple Flash Shooting with a set Flash Ratio](#)
- [Stroboscopic Flash](#)



Note

- You can also directly operate the receiver unit to individually set the flash exposure compensation and flash coverage on each receiver unit.
- If the sender is set to EL-1, it is possible to take radio transmission wireless slow sync photos with a 600EXII-RT, 600EX-RT, or 430EXIII-RT set as receivers.

About Sender Unit(s)

You can designate two or more sender units. When using multiple cameras with senders attached, you can switch cameras in wireless strobe shooting using the same lighting (receivers).

When two or more sender units are used, < **SUB SENDER** > is displayed on the LCD panel.

Caution

- When the < **LINK** > lamp turns off or <  **LINK** > is displayed on the LCD panel, it means that the unit is not connected yet. After checking the transmission channel and wireless radio ID, turn each receiver unit off and on again.
- Limit the total number of senders and receivers during radio transmission wireless shooting to 16 units.

Note

- You can shoot even when the sender unit is in the sub-sender state.

Automatic Flash Photography with Receivers divided into 2 Groups

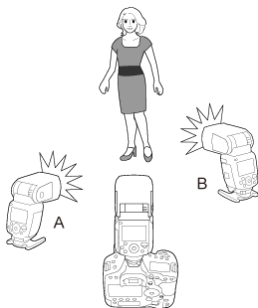

You can adjust the lighting balance (flash ratio) with receivers separated into 2 groups, A and B.

The total (sum) of light from firing groups A and B is automatically controlled to achieve a standard exposure.

1. Push the joystick vertically.

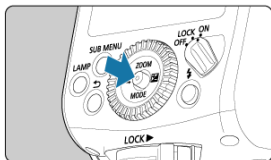

- Control the receivers and set each one.

2. Set the receiver firing group to (1).

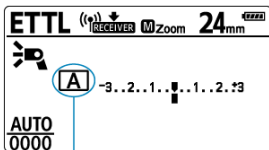

(1)

- Select either < A > or < B > for the firing group.
- Set 1 receiver to < A > and the other to < B >.

3. Set the sender firing group (2).

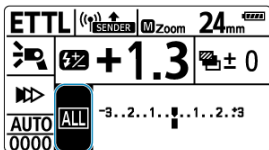

(2)

- Operate the sender to set steps 3-5.
- Push the joystick up / down / left / right or turn < Ⓞ > to select an item, and push the joystick vertically.

4. Set to < A:B >.

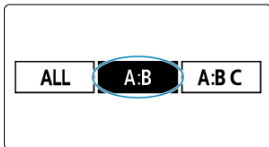

- Press the joystick to the left or right, turn < Ⓞ > to select < A:B > to select, then push the joystick vertically.

5. Set the A:B flash ratio.

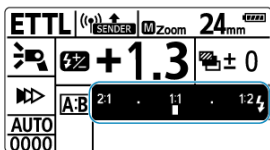

- Push the joystick vertically to select an item in the figure.
- Push the joystick to the left or right or turn < Ⓞ > to set the amount of compensation, and push the joystick vertically.

6. Take the picture.

- The receiver will fire at the set flash ratio.

Automatic Flash Photography with Receivers divided into 3 Groups

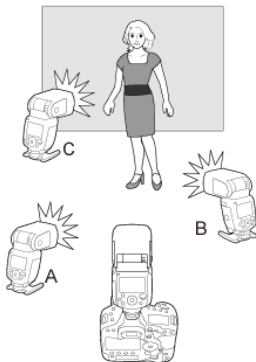

You can perform multiple flash shooting by adding firing group C to firing groups A and B. For an overview of flash control, see "[Group Control](#)". C is useful when you want lighting that eliminates the subject's background shadow.

1. Push the joystick vertically.

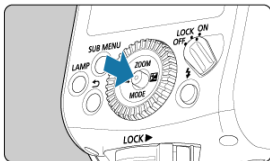

2. Select an item in (1).

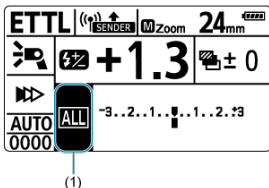

- Push the joystick up / down / left / right or turn < Ⓞ > to select an item, and push the joystick vertically.

3. Set to < A:B C >.

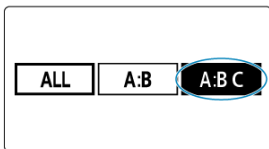

- Press the joystick to the left or right, turn < Ⓞ > to select < A:B C > to select, then push the joystick vertically.

4. Configuring after setting the firing groups to A, B, and C.

- Check that the same transmission channel and wireless radio ID are set for all receiver units and the sender unit.
- Set the receiver unit to add as A, B, or C respectively and place them in position.

5. Check the channel and ID.

- If the transmission channels and wireless radio IDs of the sender unit and receiver unit are different, set them to the same settings (Ⓞ).

6. Set the A:B flash ratio.

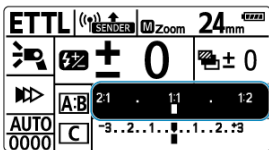

- Push the joystick vertically to select an item in the figure.
- Push the joystick to the left or right or turn < Ⓢ > to set the amount of compensation, and push the joystick vertically.

7. Setting the exposure compensation amount for firing group C.

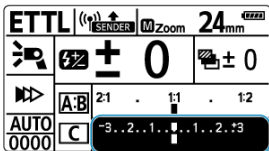

- Push the joystick vertically to select an item in the figure.
- Push the joystick to the left or right or turn < Ⓢ > to set the amount of compensation, and push the joystick vertically.

8. Check transmission status and charging.

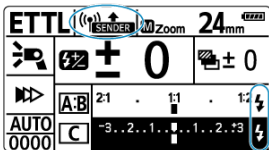

- Check that < (SENDER) > is not displayed on the sender unit's LCD panel.
- Check that the < battery icon > indicating that receiver charging is completed is lit on the sender unit's LCD panel (< **CHARGE** > is not displayed).
- For details of the LCD panel illumination of the sender unit, see "[About the LCD Panel Illumination](#)".

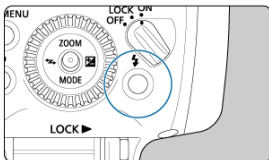

- Check that the sender unit's flash-ready lamp is lit.

9. Check the operation.

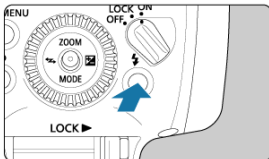

- Press the sender unit's test flash button.
- The Speedlite will fire. If it does not fire, check that it is placed within the transmission range (📶).

10. Take the picture.

- Set the camera and take the picture in the same way as with normal flash shooting.

Caution

- When <  > is displayed on the LCD panel, radio transmission cannot be performed. Check the transmission channels and wireless radio IDs of the sender unit and receiver unit again. If you cannot connect with the same settings, turn the sender unit and receiver unit off and on again.
- If you shoot with firing group C pointing directly toward the main subject, overexposure may result.

Note

- You can press the depth-of-field preview button on the camera to fire the modeling flash .
- When set as the sender unit, the time until auto power off takes effect is approx. 5 min.
- If the receiver unit's auto power off takes effect, press the sender unit's test flash button to turn on the receiver unit.
- You cannot use the test flash when operating the flash timer, etc. on the camera end.

Wireless Multiple Flash Shooting with a set Flash Ratio

This section describes wireless multiple flash shooting using manual flash. You can set the flash output in 1/3-stop increments for shooting in the range from full flash (1/1) to 1/8192 flash for each firing group. Set all the parameters on the sender unit.

1. Select **<MODE>** with the joystick.

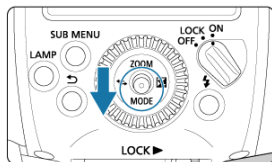

2. Set the flash mode to **<M>**.

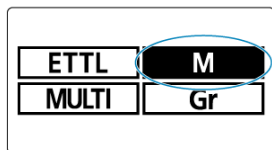

- Press the joystick up, down, left, or right, or turn **<⊙>** and select **<M>**, then press the joystick vertically.

3. Push the joystick vertically.

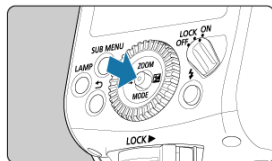

4. Select an item in (1).

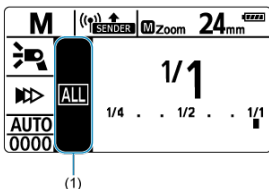

- Push the joystick up / down / left / right or turn < Ⓞ > to select an item, and push the joystick vertically.

5. Set the firing group.

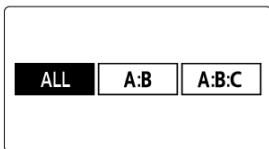

- Push the joystick to the left or right or turn < Ⓞ > to select the flash method from the following. You can use wireless multiple flash shooting with firing groups A, B, and C added.
 - All receiver units have the same flash output:< **ALL** >
 - Setting the flash ratio for firing groups A and B:< **A:B** >
 - Setting the flash ratio for firing groups A, B, and C:< **A:B:C** >

6. Select a firing group.

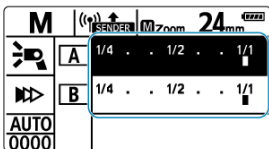

- If you selected < A:B > or < A:B:C > in Step 2, push the joystick vertically and then push the joystick up and down, or turn < Ⓢ > to select the group to set the flash output.

7. Set the flash output.

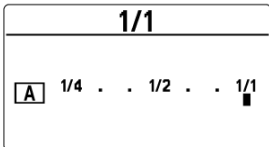

- Push the joystick vertically.
- Push the joystick to the left or right or turn < Ⓢ > to set the flash output, then push the joystick vertically.
- Repeat Step 3 and 4 to set the flash output of all the groups.

8. Take the picture.

- Each group fires at the set flash output.

⚠ Caution

- When high-speed sync or optical transmission wireless is set, the setting range will be 1/1 to 1/128.
- When a flash other than the EL-1 is used as a receiver, if a low flash firing level is set, the correct firing level may not be displayed on the receiver side.



Note

- When < > is set, set A, B, or C as the firing group for the receiver units. The flash will not fire if it is set to D or E.
- To fire multiple receiver units with the same flash output, select < > in step 2.

Shooting in a Different Flash Mode for Each Group

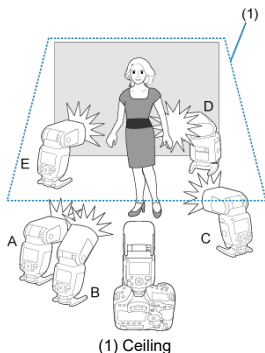

When using an EOS DIGITAL camera released in and after 2012, you can shoot in a different flash mode set for each firing group with up to 5 groups (A, B, C, D, and E). The flash modes that can be set are (1) E-TTL II / E-TTL autofocus, (2) manual flash, and (3) auto external flash metering. When the flash mode is (1) or (3), exposure is controlled to result in standard exposure for the main subject as a single group. This function is for advanced users who are very knowledgeable and experienced in lighting.

Caution

- Wireless multiple flash shooting using the <Gr> flash mode cannot be performed with cameras released up to 2011 or with EOS REBEL T100/4000D/3000D, EOS REBEL T7/1500D/2000D, EOS REBEL T6/1300D or EOS REBEL T5/1200D. Shooting with up to 3 groups (A, B, and C) will be applied (🔒).

1. Use the joystick on the sender to select <MODE>.

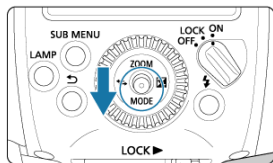

2. Set the flash mode to <Gr>.

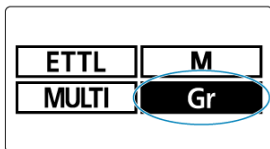

- Press the joystick up, down, left, or right, or turn <⊙> and select <Gr>, then press the joystick vertically.
- The receiver unit's flash mode is set automatically during shooting, controlled by the sender unit.

3. Set the firing group of the receiver unit.

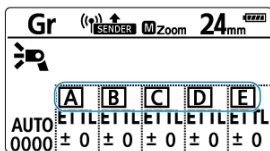

- Set the firing group (A, B, C, D, or E) for all the receiver units.

4. Set each firing group.

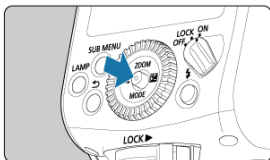

- Set the flash mode of each firing group by operating the sender unit.
- Push the joystick vertically.

| | | | | | |
|------------|------------|--------|----------------|------|------|
| Gr | (S) SENDER | M Zoom | 24mm | | |
| Flash icon | ± 0 | 0 | Flash icon ± 0 | | |
| ▶▶ | A | B | C | D | E |
| AUTO | ETTL | ETTL | ETTL | ETTL | ETTL |
| 0000 | ± 0 | ± 0 | ± 0 | ± 0 | ± 0 |

- Push the joystick up / down / left / right or turn < Ⓞ > to select a firing group, then push the joystick vertically.

Setting the flash mode

| | | |
|---|----------------|-----------------------|
| | Flash icon ± 0 | Flash icon ± 0 |
| A | ETTL ± 0 | -3..2..1..:..1..2..73 |
| B | ETTL ± 0 | -3..2..1..:..1..2..73 |
| C | ETTL ± 0 | -3..2..1..:..1..2..73 |
| D | ETTL ± 0 | -3..2..1..:..1..2..73 |
| E | ETTL ± 0 | -3..2..1..:..1..2..73 |

| | |
|-------|-----|
| ETTL | M |
| Ext.A | OFF |

- Push the joystick up / down / left / right or turn < Ⓞ > to select the flash mode from < **ETTL** > < **M** > < **Ext.A** >.

Setting the flash output and flash exposure compensation amount

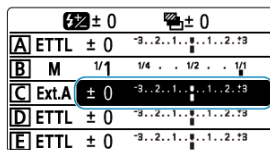
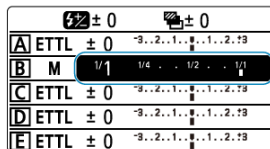

- Push the joystick up / down / left / right or turn < Ⓞ > to select an item, and push the joystick vertically.
- Push the joystick to the left or right or turn < Ⓞ > to set the flash output or flash exposure compensation amount, then push the joystick vertically.
- When using the < **M** > mode, set the flash output. When using < **ETTL** > < **Ext.A** > mode, set the flash exposure compensation amount as required.
- Repeat step 3 to set the firing function for all firing groups.

5. Check the charge status and then shoot.

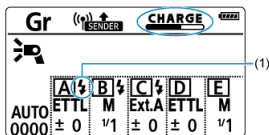

- When < **CHARGE** > is displayed, you can check the firing groups that are not fully charged by the indication on the screen on the left. For example, when firing group < **A** > is fully charged, (1) is displayed.
- When all firing groups are fully charged, < **CHARGE** > disappears.
- See Step 7 in "[Automatic Flash Photography with 1 Flash Receiver](#)" for other charge confirmations.
- Each receiver unit fires simultaneously in the respective flash mode set.

 **Caution**

- When setting the flash mode to < **Ext.A** >, make sure the receiver units are Speedlites supporting auto external flash metering. Firing in this flash mode is not possible if auto external flash metering is not supported.
- When the flash mode is set to < **ETTL** > < **Ext.A** >, exposure is controlled as a single group to obtain the standard exposure for the main subject.

 **Note**

- For < **Ext.A** >, see the Instruction Manual of the Speedlite that supports Auto external flash metering.
- The order of firing among firing groups does not need to be consecutive; for example, A, C, E can be set.
- If there is a group that you do not wish to fire, set it to < OFF > when setting the flash mode in Step 3.

Test Flash / Modeling Flash from a Receiver Unit

During radio transmission wireless shooting, test flash and modeling flash (☑) can be performed from the EL-1 set as the receiver unit.

1. Push the joystick vertically.

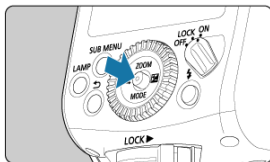

2. Fire the flash.

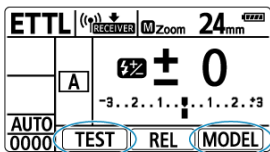

[Test flash firing]

- Press the joystick up, down, left, or right, or turn < Ⓞ > and select < **TEST** >, then press the joystick vertically.

[Modeling flash] (☑)

- Press the joystick up, down, left, or right, or turn < Ⓞ > and select < **MODEL** >, then press the joystick vertically.
- A flash signal is sent from the receiver unit to the sender unit, and a wireless system test flash or modeling flash is fired.

 **Caution**

- Modeling flash is not possible from a receiver unit with cameras released up to 2011 or with EOS REBEL T100/4000D/3000D, EOS REBEL T7/1500D/2000D, EOS REBEL T6/1300D or EOS REBEL T5/1200D.
- For the precautions related to modeling flash, see "[Modeling Flash](#)".
- When C.Fn-02-1 is set on the sender unit () , modeling flash will not be fired even if you select < **MODEL** >.

 **Note**

- If there are two or more sender units () , the flash signal is sent to the main sender.

Remote Release from a Receiver Unit

When using an EOS DIGITAL camera released in or after 2012, you can perform remote release (remote control shooting) from an EL-1 set as a receiver unit during radio transmission wireless shooting.

1. Push the joystick vertically.

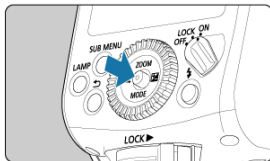

2. Take the picture.

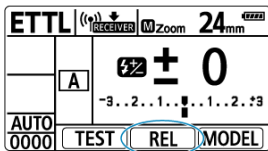

- Press the joystick up, down, left, or right, or turn <  > and select < **REL** >, then press the joystick vertically.
- A release signal is sent from the receiver unit to the sender unit, and the picture is taken.

Caution

- Remote release is not possible from a receiver unit in cameras released up to 2011 or EOS REBEL T100/4000D/3000D, EOS REBEL T7/1500D/2000D, EOS REBEL T6/1300D or EOS REBEL T5/1200D.
- Shooting is not possible when autofocus fails. It is recommended that you set the focus mode switch of the lens to < **MF** >, manually focus on the subject, then release.



Note

- Remote release is performed with "Single shooting" regardless of the camera's drive mode setting.
- If there are two or more sender units (📡), the flash signal is sent to the main sender.
- During remote release from the receiver, < **RELEASE** > will be displayed on the sender display panel.

Linked Shooting with Radio Transmission

When using an EOS DIGITAL camera released in or after 2012 (except EOS REBEL T100/4000D/3000D, EOS REBEL T7/1500D/2000D, EOS REBEL T6/1300D and EOS REBEL T5/1200D), you can perform linked shooting, which automatically releases the shutter of a receiver camera unit by linking it to the sender camera unit. You can perform linked shooting with up to 16 units, including both sender units and receiver units. This is useful when you want to shoot a subject from multiple angles at the same time.

To perform linked shooting, attach a Speedlite or a Speedlite Transmitter that supports radio transmission wireless shooting to the camera. When used with a camera released up to 2011 or with EOS REBEL T100/4000D/3000D, EOS REBEL T7/1500D/2000D, EOS REBEL T6/1300D or EOS REBEL T5/1200D, the unit can be used only as "sender camera unit". The unit cannot be used as a "receiver camera unit".

* Some cameras are not supported.

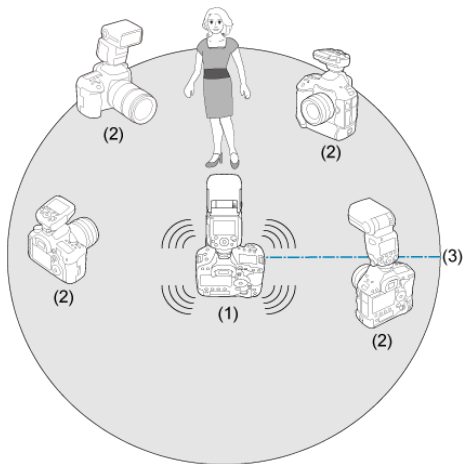

- (1) Sender camera unit
- (2) Receiver camera unit
- (3) Transmission distance: Approx. 30 m / 98.4 ft.

Note

- When an EL-1 set for linked shooting and a camera are combined, they are referred to respectively as a "sender camera unit" and a "receiver camera unit".

Before performing the operations below, attach a Speedlite or transmitter to all the cameras to be used for linked shooting. For details on setting other devices, refer to the Instruction Manual of the devices.

1. Select <  > with the joystick.

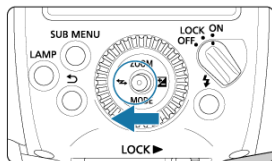

2. Set to normal shooting mode.

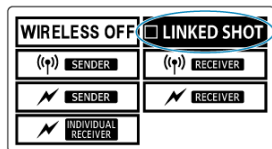

- Press the joystick up, down, left, or right, or turn <  > and select < LINKED SHOT >, then press the joystick vertically.

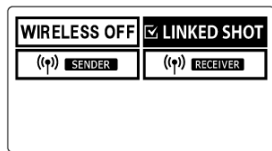

- Display changes to < LINKED SHOT >.

3. Set as sender unit / receiver unit.

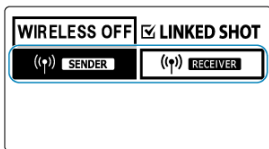

- Press the joystick up / down / left / right or turn < Ⓢ > to select < Ⓢ > **SENDER** > or < Ⓢ > **RECEIVER** >, then push the joystick vertically.

4. Set the transmission channel and wireless radio ID.

- Refer to "[Setting the Transmission Channel / Wireless Radio ID](#)" for details on how to set.

5. Set the camera's shooting functions.

6. Set all the Speedlites.

- Set all the Speedlites to perform linked shooting to "sender unit" or "receiver unit" in linked shooting.
- Set the transmitters in the same way if any are to be used in linked shooting.
- If you change the setting from "receiver unit" to "sender unit" in Step 2, the other Speedlites (or transmitters) set as "sender units" will automatically become "receiver units".

7. Install the receiver camera unit.



- Set up all the receiver camera units within approx. 30 m / 98.4 ft. of the sender camera unit.
- Check that the < **LINK** > lamps of the receiver units are lit in green.

8. Take the picture.





- Check that the < **LINK** > lamp of the sender unit is lit in green and take the picture.
- The receiver camera units are released with the release of the sender camera unit.
- Receiver units for which linked shooting has been performed are indicated by a < **RELEASE** > on the LCD panel.

Note

- When you want to clear linked shooting, operate the Speedlites one by one to change the setting to < **LINKED SHOT** > in step 1.
- You can use this function as a remote control for linked shooting without attaching a Speedlite to a camera. After pushing the joystick of the sender unit vertically, push the joystick up / down / left / right or turn <  > to select < **REL** > and release all the receiver camera units.
- During linked shooting, the time until auto power off takes effect is approx. 5 min. for both the sender and the receiver units. When the interval of linked shooting is 5 min. or longer, set the "Auto power off" to "OFF" on both the sender and the receiver units ([C.Fn-01-1](#)).
- When P.Fn-06-0 is set () , the beep will sound on each fully charged flash unit (sender / receiver).

Caution

- Setting the focus mode switches of the lenses attached to the receiver camera unit to **<MF>** and taking the picture with manual focusing is recommended. If focus cannot be achieved with autofocus, linked shooting is not possible with the corresponding receiver camera unit.
- There is a short time lag between the release of the receiver camera unit and the release timing of the sender camera unit. Perfectly simultaneous shooting is not possible.
- When set to P.Fn-03-1 , the flash can be fired during linked shooting, but if multiple flashes are fired simultaneously during linked shooting, the proper exposure may not be obtained or inconsistent exposure may occur.
- When **[Flash firing]** in **[External Speedlite control]** or **[Flash control]** is set to **[Disable]**  on the sender camera, linked shooting cannot be performed.
- When set to P.Fn-03-0 , if linked shooting is not possible while viewing the live view image, set **[Soft LV shooting]** or **[Silent LV shoot.]** in the menu of the sender camera unit to **[Disable]**. If **[Mode 1]** or **[Mode 2]** is set, the receiver camera units may not be released depending on the camera model used.
- The transmission distance may be shorter depending on the conditions such as the positioning of the flashes, the surrounding environment, and weather conditions.
- The linked shooting function is similar to linked shooting on the WFT series of wireless file transmitters. However, linked shooting cannot be performed in combination with the WFT series file transmitters. Moreover, the release time lag differs from linked shooting performed using the WFT series.

Caution

Linked Shooting Using Live View Function

- When set to P.Fn-03-0 , if the following cameras are combined and set as sender cameras, linked shooting in the Live View mode is not possible.
- Perform linked shooting after switching Live View shooting to viewfinder shooting or set the Speedlite to P.Fn-03-1.
EOS REBEL T6S/760D, EOS REBEL T6i/750D, EOS REBEL T5i/700D,
EOS REBEL T4i/650D, EOS REBEL T3i/600D, EOS REBEL T2i/550D,
EOS REBEL T1i/500D, EOS REBEL XSi/450D, EOS REBEL XS/1000D

Optical Transmission Wireless Flash Shooting

This chapter describes how to use strobe shooting using the optical transmission wireless sender / receiver function.

See the system map (🔗) for the accessories required for optical transmission wireless flash shooting.

⚠ Caution

- When the camera's shooting mode is set to a fully automatic mode or a Basic Zone mode, the operations in this chapter are not available. Set the camera's shooting mode to < **Fv** > < **P** > < **Tv** > < **Av** > < **M** > < **bulb (B)** > (Advanced shooting zone).

📄 Note

- EL-1 is used as the sender unit and receiver unit in the descriptions.
- The EL-1 attached to the camera is called a "sender unit" while the EL-1 controlled wirelessly is called a "receiver unit".

- [Optical Transmission Wireless Flash Shooting](#)
- [Optical Transmission Wireless Settings](#)
- [Automatic Flash Photography with 1 Flash Receiver](#)
- [Automatic Flash Photography with Receivers divided into 2 Groups](#)
- [Automatic Flash Photography with Receivers divided into 3 Groups](#)
- [Wireless Multiple Flash Shooting with a set Flash Ratio](#)
- [Manual Flash / Multiple Flash set in the Receiver Unit](#)

Optical Transmission Wireless Flash Shooting

[Positioning and Operation Range](#)

[Group Control](#)

Using a Canon Speedlite (receiver) with an optical transmission wireless shooting function, you can easily perform wireless multiple flash shooting in the same way as normal E-TTL II / E-TTL autoflash strobe photography.

The system is designed so that the settings of the EL-1 (sender unit) are automatically applied to the EL-1 (receiver unit) controlled wirelessly. Therefore, you do not need to operate the receiver unit during shooting.

Positioning and Operation Range

- Automatic Flash Photography with 1 Flash Receiver (📷)

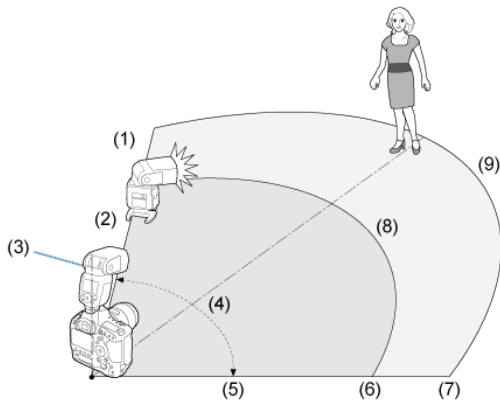

- (1) Indoors
- (2) Outdoors
- (3) **SENDER**
- (4) About 80°
- (5) Transmission range
- (6) About 8 m / 26.2 ft.
- (7) About 12 m / 39.4 ft.
- (8) About 10 m / 32.8 ft.
- (9) About 15 m / 49.2 ft.

● **Automatic Flash Photography with Receivers divided into Groups**
(☑, ☑)

You can divide the receiver units into two or three groups and perform E-TTL II / E-TTL autoflash shooting while changing the flash ratio (flash output rate).

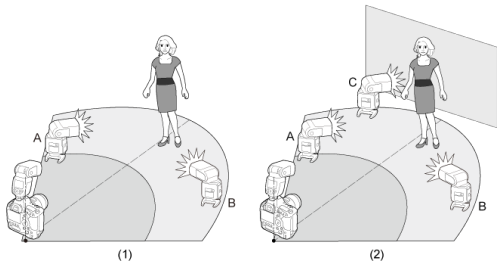

(1) 2 (A, B) groups

(2) 3 (A, B, C) groups

Caution

- If you shoot with firing group C pointing directly toward the main subject, overexposure may result.
- Before shooting, perform a test flash (☑) and test shooting.
- To avoid interfering with transmission, do not place any obstacles between the sender unit and receiver unit.

Note

- Using the mini stand provided with the receiver unit, position the receiver of the receiver unit towards the sender unit.
- When shooting indoors, the transmission may be reflected off the wall, which may cause the camera to be activated even when the layout is still preliminary.

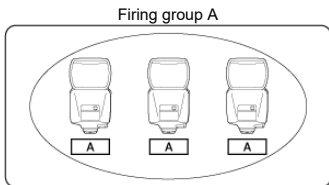

If you need more flash output or wish to perform more sophisticated lighting, you can increase the number of receiver units. Simply set an additional receiver unit to the firing group (A, B, or C) whose flash output you want to increase. There is no restriction on the number of units.

For example, if you set a firing group with three receiver units to $\langle \boxed{A} \rangle$, the three units are treated and controlled as a single firing group A with a large flash output.

⚠ Caution

- To fire the 3 firing groups A, B and C together, select $\langle \boxed{A:B:C} \rangle$. With the $\langle \boxed{A:B} \rangle$ setting, firing group C does not fire.
- If you shoot with firing group C pointing directly toward the main subject, overexposure may result.
- With certain EOS film cameras that support E-TTL autoflash, you cannot perform wireless multiple flash shooting with a flash ratio setting.

📄 Note

- The flash ratio of 8:1 to 1:1 to 1:8 is equivalent to 3:1 to 1:1 to 1:3 (1/2-stop increments) when converted to the number of stops.

Optical Transmission Wireless Settings

- ☑ [Sender Settings](#)
- ☑ [Receiver Settings](#)
- ☑ [Setting the Transmission Channel](#)
- ☑ [Sender Unit\(s\) Flash Firing ON / OFF](#)
- ☑ [Memory Function](#)

E-TTL II / E-TTL During optical transmission wireless flash shooting with autoflash photography, use the following steps to set the sender and receiver.

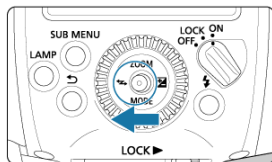

Sender Settings

1. Select <  > with the joystick.

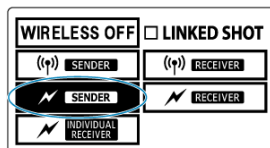

2. Set to <  **SENDER** >.



- Press the joystick up, down, left, or right, or turn <  > and select <  **SENDER** >, then press the joystick vertically.

3. Select the firing method.

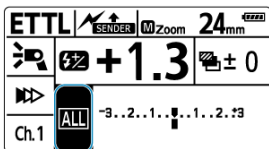

- Push the joystick vertically.
- Push the joystick up / down / left / right or turn < Ⓞ > to select item (1), then push the joystick vertically.
- Push the joystick to the left or right, turn < Ⓞ > to select from < ALL > < A:B > < A:BC >, then push the joystick vertically (⏏, ⏏).

Receiver Settings

1. Set to < ⚡ **RECEIVER** >.

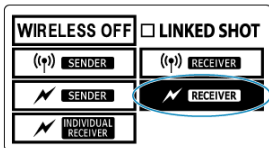

- Operate and set the flash you want to set as the receiver unit.
- Select < ⚡ **RECEIVER** > in the same way as for the sender unit setting.

! Caution

- To perform normal flash photography, select < **WIRELESS OFF** > to clear the sender settings.

Setting the Transmission Channel

Follow the procedure below to set the communication channel of the sender unit. **The channel set should be the same for the sender unit and receiver unit.** For details on the receiver operation procedure, refer to the Instruction Manual of the Speedlite equipped with the optical transmission wireless receiver function.

1. Push the joystick vertically.

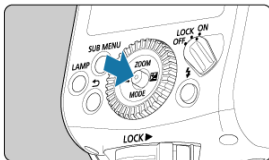

2. Select an item in (1).

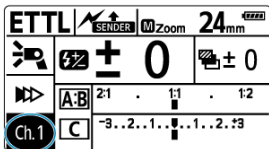

(1)

- Push the joystick up / down / left / right, or turn  to select a channel item, then push the joystick vertically.

3. Set a transmission channel.

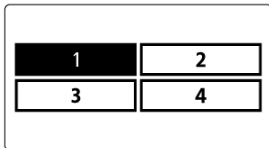

- Push the joystick up / down / left / right or turn  to select from Ch. 1 to 4, then push the joystick vertically.

 **Caution**

- If the transmission channels of the sender unit and receiver unit are different, the receiver unit will not fire. Set both to the same number.

Sender Unit(s) Flash Firing ON / OFF

You can set whether or not to fire the sender unit as a wireless flash that controls the receiver unit. When sender flash firing is turned ON, the flash fires as firing group A.

1. Push the joystick vertically.

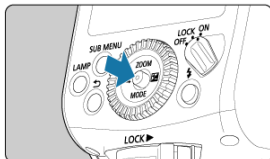

2. Select an item in (1).

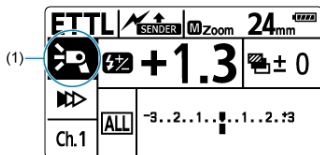

- Push the joystick up / down / left / right or turn <  > to select an item, and push the joystick vertically.

3. Set sender flash firing.

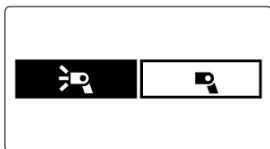

- Push the joystick to the left or right or turn <⊙> to select sender flash firing ON / OFF, then push the joystick vertically.
 - <⬅️📷>: Sender flash firing ON
 - <📷➡️>: Sender flash firing OFF

⚠️ Caution

- Even when sender flash firing is set to OFF, the flash firing for controlling the receiver unit (optical transmission) is performed. Therefore, depending on the shooting conditions, the flash fired for controlling the receiver unit may be captured in the picture.

Memory Function

You can save the wireless settings to the sender unit and receiver unit and recall the settings later. Operate each sender or receiver unit individually to save or recall its settings.

1. Press the **<SUB MENU>** button.

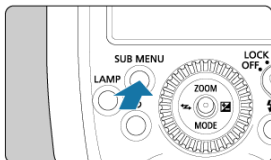

2. Select **<MEMORY>**.

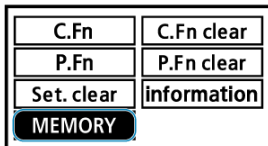

- Press the joystick up, down, left, or right, or turn **<⊙>** and select **<MEMORY>**, then press the joystick vertically.

3. Save or load the settings.

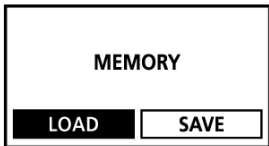

Save

- Press the joystick to the left or right, turn < Ⓞ > to select < **SAVE** > to select, then push the joystick vertically.
- Press the joystick to the left or right, turn < Ⓞ > to select < **OK** > to select, then push the joystick vertically.
- The settings are saved (stored in the memory).

Load

- Press the joystick to the left or right, turn < Ⓞ > to select < **LOAD** > to select, then push the joystick vertically.
- Press the joystick to the left or right, turn < Ⓞ > to select < **OK** > to select, then push the joystick vertically.
- The settings that were saved are set.

Automatic Flash Photography with 1 Flash Receiver

- [☑ Autoflash Photography Using Multiple Receiver Units](#)
- [☑ Multiple Flash Photography with Wireless Functions](#)
- [☑ About Sender Unit\(s\)](#)

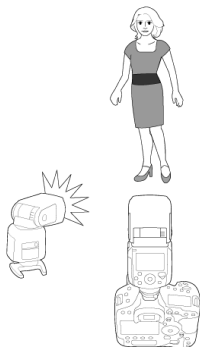

This section describes basic fully automatic wireless shooting when using a EL-1 attached to the camera (sender) and a EL-1 set as a receiver unit.

1. Set the sender unit.

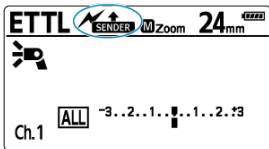

- Set the EL-1 attached to the camera to "Sender Unit" (☑).
- Devices equipped with the optical transmission wireless sender function can also be used as a sender unit.

2. Set the receiver unit.

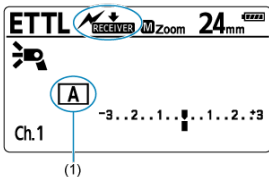

- Set the EL-1 to be controlled wirelessly from the sender as the receiver unit (A).
- You can also use other EX-series Speedlites that are equipped with an optical transmission wireless receiver function.
- You can use any of A, B, or C as the firing group (1).

3. Check the channel.

- If the communication channels of the sender and receiver units are different, set them to the same channel (A).

4. Position the camera and flash.

- Position them within the range shown at "[Positioning and Operation Range](#)".

5. Use the joystick on the sender to select <MODE>.

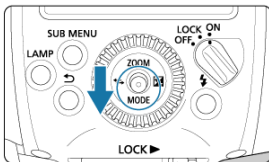

6. Set the flash mode to <ETTL>.

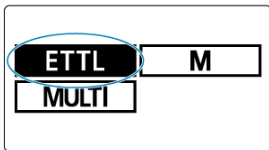

- Press the joystick up, down, left, or right, or turn <⊙> and select <ETTL>, then press the joystick vertically.
- The receiver unit is set automatically to <ETTL> during shooting, controlled by the sender unit.
- Check that the firing group control is set to <ALL>.

7. Check that the flash is ready.

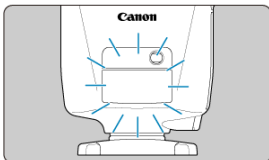

- When the receiver flash is ready, the AF-assist beam emitter blinks at approx. 1-second intervals.

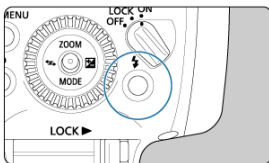

- Check that the sender unit's flash-ready lamp is lit.

8. Check the operation.

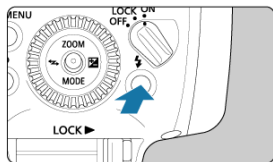

- Press the sender unit's test flash button.
- The Speedlite will fire. If it does not fire, check that it is placed within the transmission range (☑).

9. Take the picture.

- Set the camera and take the picture in the same way as with normal flash shooting.

⚠ Caution

- If there is a fluorescent light or computer monitor near a receiver unit, the presence of the light source may cause the receiver unit to malfunction and fire inadvertently.
- During optical transmission wireless shooting, even if the sender and receiver units (firing group) are not all fully charged, < **CHARGE** > will not be displayed on the sender unit's LCD panel as it is with radio transmission wireless shooting (with sender flash firing OFF). Also, there is no function for illuminating or turning off the sender unit's LCD panel according to the charge status of the sender unit and receiver units.
- When P.Fn-06-0 is set on the sender unit (☑), the beep will sound when the sender unit is fully charged (This beep does not indicate that charging of all flash units is completed as it does with radio transmission wireless shooting).



Note

- The flash coverage of the sender unit and receiver unit is set to 24 mm. You can also set the flash coverage manually.
- It can also fire a flash on the sender (☑).
- You can press the depth-of-field preview button on the camera to fire the modeling flash (☑).
- If the receiver unit's auto power off takes effect, press the sender unit's test flash button to turn on the receiver unit.
- You cannot use the test flash when operating the flash timer, etc. on the camera end.
- You can change the time until the receiver unit's auto power off takes effect (C.Fn-10).
- You can disable the blinking of the AF-assistant beam emitter when the receiver unit is fully charged (C.Fn-23).

Autoflash Photography Using Multiple Receiver Units

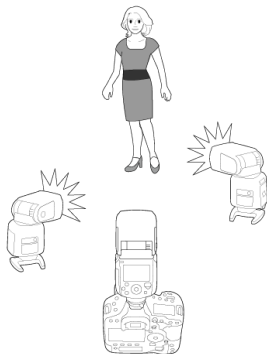

When you need more flash output or you want to perform lighting more easily, you can increase the number of receiver units and fire them as a single flash.

Add a receiver, and follow the same procedure listed in "Automatic flash photography with 1 flash receiver" (🔗). You can use any of A, B, or C as the firing group.

When the number of receiver units is increased or sender flash firing is set to ON, automatic control is performed to fire all flashes at the same flash output and to ensure that the total flash output results in the standard exposure.

Multiple Flash Photography with Wireless Functions

Since the following functions set on the sender unit will be set automatically to the receiver units on this wireless system, you do not need to operate the receiver unit(s). For this reason, you can perform wireless flash photography in the same way as normal flash photography.

- [Flash Exposure Compensation](#) <  >
- [FEB](#) <  >
- [FE Lock](#)
- [High-Speed Sync](#) <  >
- [Manual Flash](#)
 - [Wireless Multiple Flash Shooting with a set Flash Ratio](#)
- [Stroboscopic Flash](#)



Caution

- The flash frequency when performing stroboscopic flash during optical transmission wireless shooting can be set from 1 Hz to 199 Hz (settings from 250 Hz to 500 Hz are not available).



Note

- You can also directly operate the receiver unit to individually set the flash exposure compensation and flash coverage on each receiver unit.

About Sender Unit(s)

You can designate two or more sender units. When using multiple cameras with senders attached, you can switch cameras in wireless strobe shooting using the same lighting (receivers).

Automatic Flash Photography with Receivers divided into 2 Groups

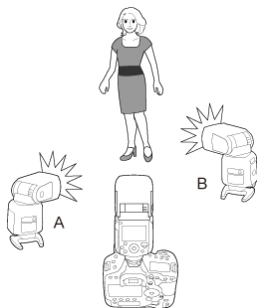

You can adjust the lighting balance (flash ratio) with receivers separated into 2 groups, A and B.

The total (sum) of light from firing groups A and B is automatically controlled to achieve a standard exposure.

1. Push the joystick vertically.

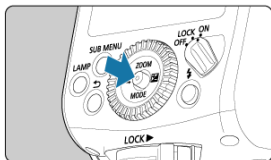

- Control the receivers and set each one.

2. Set the receiver firing group to (1).

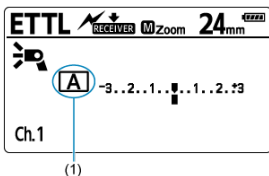

- Select either < A > or < B > for the firing group.
- Set 1 receiver to < A > and the other to < B >.

3. Set the sender firing group (2).

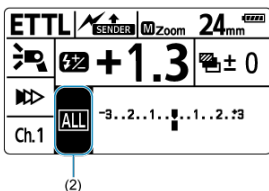

- Operate the sender to set steps 3-5.
- Push the joystick up / down / left / right or turn < Ⓞ > to select an item, and push the joystick vertically.

4. Set to < A:B >.

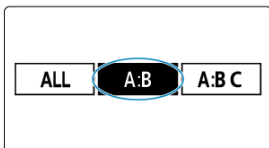

- Press the joystick to the left or right, turn < Ⓞ > to select < A:B > to select, then push the joystick vertically.

5. Set the A:B flash ratio.

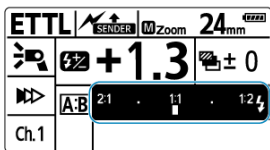

- Push the joystick vertically to select an item in the figure.
- Push the joystick to the left or right or turn < ⌚ > to set the amount of compensation, and push the joystick vertically.

6. Take the picture.

- The receiver will fire at the set flash ratio.

Automatic Flash Photography with Receivers divided into 3 Groups

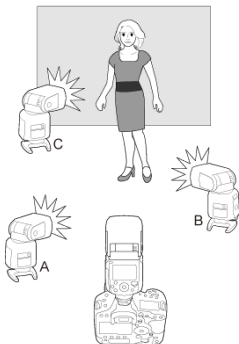

You can perform multiple flash shooting by adding firing group C to firing groups A and B. For an overview of flash control, see "[Group Control](#)".
C is useful when you want lighting that eliminates the subject's background shadow.

1. Push the joystick vertically.

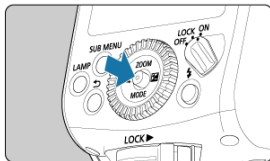

2. Select an item in (1).

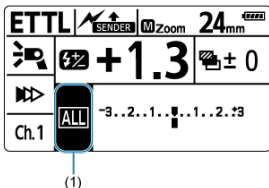

- Push the joystick up / down / left / right or turn < Ⓞ > to select an item, and push the joystick vertically.

3. Set to < A:B C >.

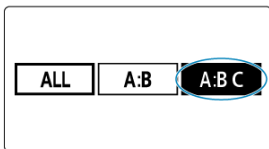

- Press the joystick to the left or right, turn < Ⓞ > to select < A:B C > to select, then push the joystick vertically.

4. Configuring after setting the firing groups to A, B, and C.

- Check whether all the receiver units are set to the same transmission channel as the sender unit.
- Set the receiver unit to add as A, B, or C respectively and place them in position.

5. Check the transmission channel.

- If the channels of the sender unit and receiver unit are different, set them to the same number (🔗).

6. Set the A:B flash ratio.

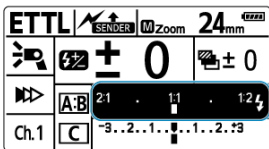

- Push the joystick vertically to select an item in the figure.
- Push the joystick to the left or right or turn < Ⓢ > to set the amount of compensation, and push the joystick vertically.

7. Setting the exposure compensation amount for firing group C.

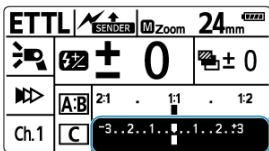

- Push the joystick vertically to select an item in the figure.
- Push the joystick to the left or right or turn < Ⓢ > to set the amount of compensation, and push the joystick vertically.

8. Check that the flash is ready.

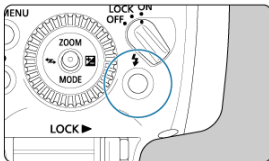

- Check that the sender unit's flash-ready lamp is lit.
- Check that the receiver unit is fully charged.

9. Check the operation.

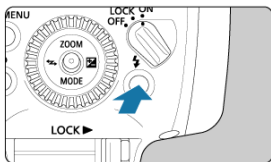

- Press the sender unit's test flash button.
- Firing groups A, B, and C will fire. If it does not fire, check that it is placed within the operation range.

10. Take the picture.

- Set the camera and take the picture in the same way as with normal flash shooting.

⚠ Caution

- To fire the 3 firing groups A, B and C together, select < **A:B C** >. With the < **A:B** > setting, firing group C does not fire.
- If you shoot with firing group C pointing directly toward the main subject, overexposure may result.
- With certain EOS film cameras that support E-TTL autoflash, you cannot perform wireless multiple flash shooting with a flash ratio setting.
- If there is a fluorescent light or computer monitor near a receiver unit, the presence of the light source may cause the receiver unit to malfunction and fire inadvertently.

📄 Note

- You can press the depth-of-field preview button on the camera to fire the modeling flash (📷).
- If the receiver unit's auto power off takes effect, press the sender unit's test flash button to turn on the receiver unit.
- You cannot use the test flash when operating the flash timer, etc. on the camera end.

Wireless Multiple Flash Shooting with a set Flash Ratio

This section describes wireless multiple flash shooting using manual flash. You can set the flash output in 1/3-stop increments for shooting in the range from full flash (1/1) to 1/128 flash for each firing group. Set all the parameters on the sender unit.

1. Select **<MODE>** with the joystick.

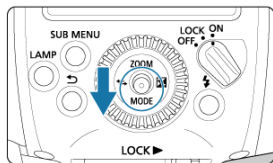

2. Set the flash mode to **<M>**.

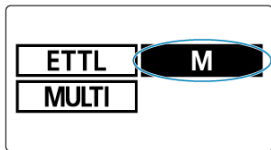

- Press the joystick up, down, left, or right, or turn **<⊙>** and select **<M>**, then press the joystick vertically.

3. Push the joystick vertically.

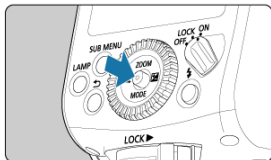

4. Select an item in (1).

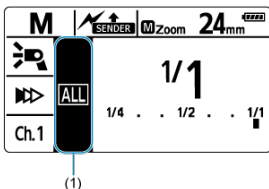

- Push the joystick up / down / left / right or turn < Ⓞ > to select an item, and push the joystick vertically.

5. Set the firing group.

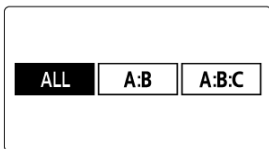

- Push the joystick to the left or right or turn < Ⓞ > to select the flash method from the following. You can use wireless multiple flash shooting with firing groups A, B, and C added.
 - All receiver units have the same flash output:< **ALL** >
 - Setting the flash ratio for firing groups A and B:< **A:B** >
 - Setting the flash ratio for firing groups A, B, and C:< **A:B:C** >

6. Select a firing group.

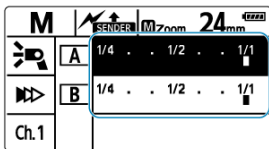

- If you selected < A:B > or < A:B:C > in Step 2, push the joystick vertically and then push the joystick up and down, or turn < Ⓢ > to select the group to set the flash output.

7. Set the flash output.

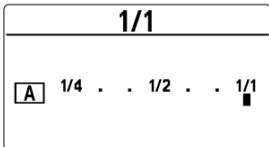

- Push the joystick vertically.
- Push the joystick to the left or right or turn < Ⓢ > to set the flash output, then push the joystick vertically.
- Repeat Step 3 and 4 to set the flash output of all the groups.

8. Take the picture.

- Each group fires at the set flash output.

Note

- When set to < ALL >, the firing group setting of the receiver unit can be either A, B, or C. All the groups fire at the set flash output.

Manual Flash / Multiple Flash set in the Receiver Unit

☑ [Manual Flash](#)

☑ [Stroboscopic Flash](#)

You can directly operate the receiver unit to manually set the manual flash or stroboscopic flash. This function is called "individual receiver". This is useful when, for example, you use the Speedlite Transmitter ST-E2 (sold separately) to perform wireless manual flash or stroboscopic flash.

1. Select < ⚡ > with the joystick.

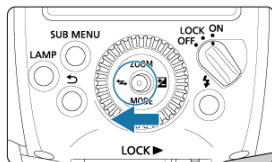

2. Set the individual receiver.

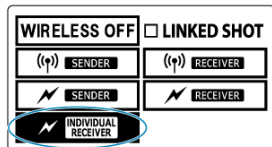

- Press the joystick up, down, left, or right, or turn < ⦿ > and select < ⚡ **INDIVIDUAL RECEIVER** >, then press the joystick vertically.
- < **INDIVIDUAL RECEIVER** > appears on the LCD panel.

3. Set the flash mode.

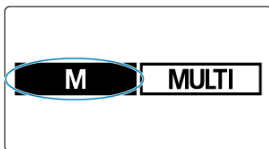

- Select < **MODE** > with the joystick.
- Push the joystick to the left or right or turn < Ⓞ > to select < **M** > or < **MULTI** >, then push the joystick vertically.

Manual Flash

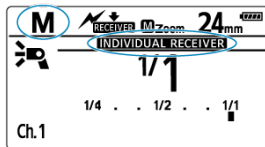

Set the manual flash output. For details on the setting procedure, see "[Manual Flash](#)".

Stroboscopic Flash

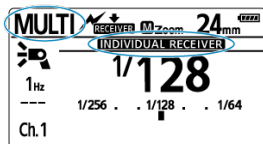

Set the stroboscopic flash settings. For details on the setting procedure, see "[Stroboscopic Flash](#)".

Caution

- The flash frequency when performing stroboscopic flash during optical transmission wireless shooting can be set from 1 Hz to 199 Hz (settings from 250 Hz to 500 Hz are not available).

Note

- A receiver unit that is set as an individual receiver unit cannot be subject to flash mode control from the sender unit. The receiver unit fires in the flash mode that is set by individual receiver.

Customizing the Speedlite

This chapter describes how to customize the Speedlite with the Custom Functions (C.Fn) and Personal Functions (P.Fn).

Caution

- When the camera's shooting mode is set to a fully automatic mode or a Basic Zone mode, the operations in this chapter are not available. Set the camera's shooting mode to < **Fv** > < **P** > < **Tv** > < **Av** > < **M** > < **bulb (B)** > (Advanced shooting zone).

- [Setting Custom and Personal Functions](#)
- [Settings that can be changed with Custom Functions](#)
- [Settings that can be changed with Personal Functions](#)

Setting Custom and Personal Functions

[C.Fn: Custom Functions](#)

[P.Fn: Personal Functions](#)

[Custom Function List](#)

[Personal Function List](#)

[Clearing all Custom / Personal Functions](#)

You can make precise adjustments to various flash functions to suit your picture-taking preferences with Custom Functions. The functions used to do this are called the Custom Functions and Personal Functions. In addition, Personal Functions are customized functions specific to the EL-1.

1. Press the <SUB MENU> button.

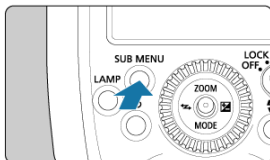

2. Display the Custom Functions screen.

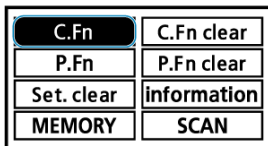

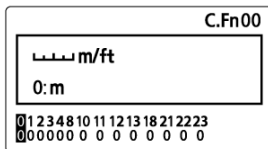

- Press the joystick up, down, left, or right, or turn < ⌂ > and select < **C.Fn** >, then press the joystick vertically.

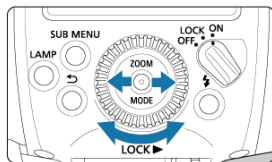

- The Custom Functions screen is displayed.

3. Select an item to set.



- Push the joystick to the left or right or turn <  > to select the item (number) to set.

4. Change the setting.

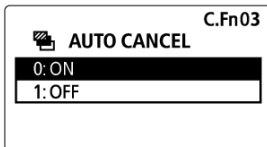

- Push the joystick vertically.
- Push the joystick up or down or turn <  > to select the desired setting, then push the joystick vertically.

1. Press the <SUB MENU> button.

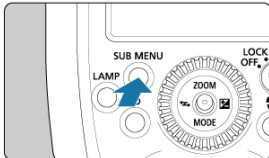

2. Display the Personal Functions screen.

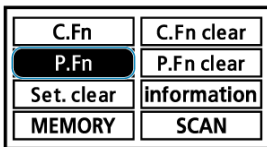





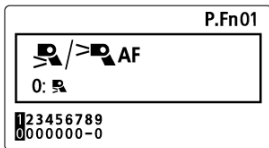









- Select < **P.Fn** > by following the same procedure as Step 2 of the custom functions, then push the joystick vertically.

3. Set the function.













- Set the Personal Functions in the same way as steps 3 and 4 for the Custom Functions.

Custom Function List

| Number | Item | |
|---------|---|--|
| C.Fn-00 | <  m/ft > | Distance indicator display |
| C.Fn-01 | <  > | Auto power off |
| C.Fn-02 | <  MODELING FLASH > | Modeling flash |
| C.Fn-03 | <  AUTO CANCEL > | FEB auto cancel |
| C.Fn-04 | <  > | FEB sequence |
| C.Fn-08 | <  AF > | AF-assist beam firing |
| C.Fn-10 | <  RECEIVER > | Receiver auto power off timer |
| C.Fn-11 | <  RECEIVER > | Receiver auto power off cancel |
| C.Fn-12 | <  > | Flash recycle with external power source |
| C.Fn-13 | <  > | Flash exposure compensation setting |
| C.Fn-18 | < MODELING LAMP > | Modeling lamp lit |
| C.Fn-21 | <  /  > | Light distribution |
| C.Fn-22 | <  > | LCD panel illumination |
| C.Fn-23 | <  RECEIVER > | Receiver charge confirmation |

Personal Function List

| Number | Item | |
|---------|--|---|
| P.Fn-01 | <  /  AF > | AF-assist beam firing method |
| P.Fn-02 | <  QUICK > | Quick flash |
| P.Fn-03 | <  LINKED SHOT > | Flash firing during linked shooting |
| P.Fn-04 | <  DIRECT > | Change settings with dial |
| P.Fn-05 | < FEM > | FE memory |
| P.Fn-06 | <  > | Beep |
| P.Fn-07 | <  > | Fan |
| P.Fn-08 | < MODELING LAMP   > | Modeling lamp (brightness, color) |
| P.Fn-09 | < MODELING LAMP  > | Modeling lamp (lit time) |

Clearing all Custom / Personal Functions

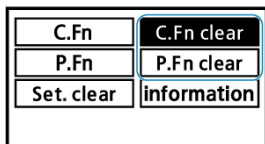

Select < **C.Fn clear** > or < **P.Fn clear** > on the screen above and select < **OK** > to cancel all custom functions or personal functions.

Caution

- Even if you clear all Custom Functions, C.Fn-00 will not be cleared.

Note

- You can set or clear all Custom Functions of the Speedlite on the camera's menu screen (📷).

Settings that can be changed with Custom Functions

C.Fn-00: m/ft (Distance indicator display)

You can select meters or feet for the distance indicator display on the LCD panel.

- **0: m (Meters (m))**
- **1: ft (Feet (ft))**

Note



- When the effective flash distance exceeds 18 m / 60 ft., the right end of the effective flash range on the LCD panel changes to  >.

C.Fn-01: (Auto power off)





When the Speedlite is not operated for approx. 90 seconds, the power turns off automatically to save energy. You can disable this function.

- **0: ON**
- **1: OFF**

Note

- During sender flash photography () in radio transmission wireless shooting or during linked shooting () , the time until auto power off takes effect is approx. 5 min.

C.Fn-02: MODELING FLASH (Modeling flash)

- **0:  (Enable: Depth-of-field preview button)**
Press the camera's depth-of-field preview button to fire the modeling flash.
- **1:  (Enable: Test flash button)**
Press the Speedlite's test flash button to fire the modeling flash.
- **2:  /  (Enable with both buttons)**
Press the camera's depth-of-field preview button or the Speedlite's test flash button to fire the modeling flash.
- **3: OFF (Disabled)**
Disables the modeling flash.

C.Fn-03: AUTO CANCEL (FEB auto cancel)

You can set whether or not to cancel FEB automatically after shooting three shots with FEB.

- **0: ON (Enabled)**
- **1: OFF (Disabled)**

C.Fn-04: (FEB sequence)

You can change the FEB shooting sequence. 0: Standard exposure, -: Decreased exposure (darker) and +: Increased exposure (brighter).

- **0: 0 → - → +**
- **1: - → 0 → +**

C.Fn-08: AF (AF-assist beam firing)

- **0: ON (Enabled)**
- **1: OFF (Disabled)**

This disables the emission of the AF-assist beam from the Speedlite.

Note

- The flash mark displayed when C.Fn-08 is set changes according to the P.Fn-01 () setting.

C.Fn-10: (Receiver auto power off timer)

When set as a radio transmission / optical transmission wireless receiver unit, the time until auto power off takes effect can be changed. When the receiver unit goes into the auto power off mode, < > is displayed on the LCD panel. Set this function for each receiver unit.

- **0: 60 min (60 minutes)**
- **1: 10 min (10 minutes)**



C.Fn-11: (Receiver auto power off cancel)

In radio transmission / optical transmission wireless shooting, when you press the test flash button of the sender unit, you can turn on the receiver units that are in the auto power off status.

You can change the time for the receiver units in auto power off status to accept this function. Set this function for each receiver unit.





- **0: 8 h (within 8 hours)**
- **1: 1 h (within 1 hour)**

C.Fn-12: (Flash recycle with external power source)

- **0:  +  (Flash unit and external power source)**
Charges using both internal and external power sources.

- **1:  (External power source only)**
The internal power source is needed to control the Speedlite. By using an external power source for charging firing of the Speedlite, you can minimize the depletion of the internal power source.

C.Fn-13: (Flash exposure compensation setting)

- **0:  +  (button + dial)**
- **1:  (Direct setting with dial)**
You can turn <  > directly to set the flash exposure compensation amount and flash output without selecting <  > with the joystick.

C.Fn-18: MODELING LAMP (Modeling lamp lit)

You can select how to turn on the modeling lamp.

- **0: <LAMP> (button)**
- **1: <  x2 > (press shutter button briefly twice)**

Note

- The <LAMP> button is valid even if it is set to 1.
- Although "Macro focusing lamp ON" appears in the camera menu screen, the setting that can be configured is "Modelling lamp ON".
- When the flash is used with the EOS D60 or EOS D30, it will not function correctly even if you briefly press the shutter button twice in a row. Turn the lamp ON / OFF with the <LAMP> button.

C.Fn-21: (Light distribution)

You can change the light distribution (flash coverage) characteristic of the flash relative to the shooting angle when the flash coverage is set to <  > (automatic setting).

- **0:  (Standard)**

The optimum flash coverage for the shooting angle of view is set automatically.

- **1:  (Guide number priority)**

Although the periphery of the picture is slightly darker than the 0 setting, this is effective when you want to give priority to the flash output. The flash coverage is set automatically to a slightly more telephoto position than the actual shooting angle of view. The display changes to <  >.

- **2:  (Light distribution priority)**

Although the possible flash photography distance becomes slightly shorter than the 0 setting, this is effective when you want to minimize light fall off at the periphery of the picture. The flash coverage is set automatically to a slightly wider position than the actual shooting angle of view. The display changes to <  >.

C.Fn-22: (LCD panel illumination)

When a button or dial is operated, the LCD panel illuminates. You can change this illumination setting.



- **0: 12 sec (illumination for 12 sec)**

- **1: OFF (Disable panel illumination)**

- **2: ON (Illumination always on)**

C.Fn-23: (Receiver charge confirmation)

When the receiver unit is fully charged during wireless flash photography, the AF-assist beam emitter of the receiver unit blinks. You can disable this blinking. Set this function for each receiver unit.



- **0:  = (AF-assist beam,  lamp)**

- **1:  ( lamp)**



Settings that can be changed with Personal Functions

P.Fn-01: AF (AF-assist beam projection method)

You can select the AF-assist beam projection method.

- **0:**  (Infrared AF-assist beam)
- **1:**  (Intermittent flash firing method)
Fire the AF-assist beam using the intermittent flash firing method ().

Caution

- The AF-assist beam is not projected during live view shooting.
- When a color filter is fitted, the AF-assist beam will not be projected by the () intermittent flash.
- For the EOS R series, an AF-assist beam is projected by the intermittent flash regardless of the projection method of the AF-assist beam and whether a color filter is fitted. However, an AF-assist beam may be projected by the camera instead of the flash depending on the surrounding brightness. Also, when a color filter is fitted and the setting is set to [**1:**  (**Intermittent flash firing method**)], an AF-assist beam is projected by the camera.
- For the EOS M series, an AF-assist beam is not projected by the flash.

P.Fn-02: QUICK (Quick flash)

You can set whether or not to fire the flash (fire the quick flash) when the flash-ready lamp is flashing in red (before the flash is fully charged) to shorten the charge waiting time.

- **0: ON (Enabled)**
- **1: OFF (Disabled)**

Caution

- When Quick flash () is fired during continuous shooting, underexposure may occur since the flash output decreases.

P.Fn-03: LINKED SHOT (Flash firing during linked shooting)

When performing linked shooting () , you can set whether or not to fire the flash attached to the camera. Set it on each flash to be used in linked shooting.

- **0: OFF (Disabled)**

The flash does not fire during linked shooting.

- **1: ON (Enabled)**

The flash fires during linked shooting.

Caution

- If you fire multiple Speedlites simultaneously during linked shooting, the appropriate exposure may not be obtained or uneven exposure may result.

P.Fn-04: DIRECT (Change settings with dial)

Push the joystick vertically to display the setting screen as shown in the figure and turn <  > to select whether to allow the following functions to be set directly.

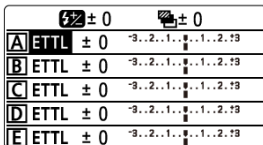
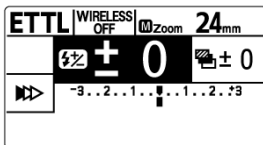

- **0: OFF (Disabled)**

This is the normal operation method.

- **1: ON (Enabled)**

You can select the items "flash exposure compensation amount", "manual flash output", "firing group control", "flash ratio", "firing mode during group firing", "firing group of receiver unit" and "FEB" with the joystick and set them directly simply by turning <  >. When the flash mode is set to < **MULTI** >, you can set the "flash frequency" and "number of flashes" directly, and when it is set to < **Ext.M** >, you can set the "ISO speed" and "aperture value" directly.

Caution

- To select an item in the settings screen when P.Fn-04-1 is set, push the joystick up / down / left / right.

P.Fn-05: FEM (FE memory)

You can select whether to update the manual mode flash output being maintained according to the flash output fired by the ETTL.

- **0: OFF**
- **1: ON**
- **2: ON / **MODE**ETTL↔M**

Note

- When P.Fn-05-2 is set, even if you push the joystick down to choose < **MODE** >, the mode will not change to a mode other than < **ETTL** > or < **M** >. If you want to choose another mode, display the settings screen by pushing the joystick vertically and push the joystick up / down / left / right, or turn <  > to choose an item and select the mode.

P.Fn-06: (Beep)

You can enable a beep to sound when flash recharge is complete.

- **0: ON**
In normal shooting (on-camera flash photography), the beep will sound when the flash unit is fully charged.
When the Speedlite is set as the sender during radio transmission wireless shooting, the beep will sound on the sender unit when all flash units (sender and receiver units) are fully charged. You can confirm recharging of the entire wireless system by the beep tone on the sender unit. For the receiver units, either 0 or 1 can be set for P.Fn-06. When the Speedlite is set as the sender during optical transmission wireless shooting, a receiver in radio transmission / optical transmission wireless shooting, or a sender / receiver in linked shooting, a beep will sound on each flash set to 0 at full charge ().
- **1: OFF**
The beep does not sound.

Caution

- When 0 is set, the beep will also sound when the temperature of the flash head rises and flash firing is restricted ().

P.Fn-07: (Fan)

You can set whether to operate the fan.

- **0: ON**
- **1: OFF**

Caution

- If the fan breaks down or the rpm is high, a warning is displayed and the fan stops.



- When shooting a video with the flash connected to the camera, the fan actuation sound may be recorded.
- You can force the fan to stop when P.Fn-07-1 is set.
- When P.Fn-07-1 is set, the number of continuous flashes is lower than when the fan is moving and the required rest time until the warning icon is cleared is extended.
- When P.Fn-07-0 is set, the fan will start when the firing or modeling lamp is lit. The fan may start even if the flash is not fired depending on the internal temperature of the flash.
- When the fan breaks down, the number of continuous firings () will be the same as when the fan is stopped regardless of the P.Fn-07 setting.

P.Fn-08: MODELING LAMP ☀️🌙 (Modeling lamp (brightness, color))

You can set the color and brightness of the modeling lamp.

Use the joystick to select < LAMP ☀️ > or < LAMP 🌙 >. Turn < ⌂ > to select your desired setting, then push the joystick vertically.

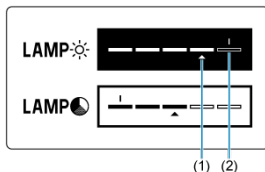

- (1) Selected cursor position
(2) Default indicator

- **LAMP ☀️**: Push the joystick to the left or right or turn < ⌂ > to set the brightness of the modeling lamp.
- **LAMP 🌙**: Push the joystick to the left or right or turn < ⌂ > to set the color temperature of the modeling lamp.

Note

- You can either push the joystick to the left or right when the modeling lamp is lit, or turn < ⌂ > and push the joystick vertically to change the brightness and color temperature.

P.Fn-09: MODELING LAMP ⌚ (Modeling lamp (lit time))

You can set the lit time of the modeling lamp.













- **0: 5 min**
- **1: 30 min**
- **2: Unlimited**

Reference

This chapter describes the flash system and lists down some of the frequently asked questions.

- [EL-1 System](#)
- [Flash Firing Restriction due to Temperature Increase](#)
- [Troubleshooting](#)
- [Specifications](#)
- [Accessories](#)

EL-1 System

| Wireless flash shooting | | |
|-----------------------------|---|---|
| Radio transmission | Speedlite / Transmitter equipped with a sender function (1)  (6)  | Speedlite equipped with a receiver function (1)  (7)  (5)   |
| Optical transmission | Camera / Speedlite / Transmitter equipped with sender function (8)  (1)  (8)  | Speedlite equipped with a receiver function (1)  (9)  (5)   |

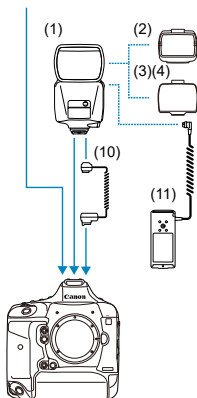

-
- (1) **Speedlite EL-1**
-
- (2) **Bounce adapter SBA-EL**
-
- (3) **Color filter SCF-ELOR1** (light)
-
- (4) **Color filter SCF-ELOR2** (dark)
-
- (5) **Mini stand**
-
- (6) **Devices equipped with radio transmission wireless sender function**
600EXII-RT, 600EX-RT, MT-26EX-RT, 430EX III-RT, ST-E3-RT
-
- (7) **Speedlites equipped with radio transmission wireless receiver function**
600EXII-RT, 600EX-RT, 430EX III-RT
-
- (8) **Devices equipped with optical transmission wireless sender function**
600EXII-RT, 600EX-RT, 600EX, 580EX II, 580EX, 550EX, EL-100, 90EX, MT-26EX-RT, MT-24EX, MR-14EX II, MR-14EX, ST-E2, and EOS digital cameras equipped with optical transmission wireless sender function using a built-in flash
-
- (9) **Speedlites equipped with optical transmission wireless receiver function**
600EXII-RT, 600EX-RT, 600EX, 580EX II, 580EX, 550EX, 430EX III-RT, 470EX-AI, 430EX III, 430EX II, 430EX, 420EX, 320EX, EL-100, 270EX II
-
- (10) **Off-camera shoe cord OC-E3**
The EL-1 can be used up to a distance of about 60 cm / 2 ft. away from the camera.
-
- (11) **Compact battery pack CP-E4N**
A small and lightweight external power source with superior portability. Equipped with dust and drip-proof features equivalent to the EL-1.
-

 **Caution**

- Using an external power source of a brand other than Canon may result in a malfunction.
- When using one of the Speedlites in (9) that does not have a function for switching the firing groups (A, B, C), you can use the Speedlite as a receiver in firing group A during optical transmission wireless shooting (you cannot use it as a receiver in firing group B or C).

 **Note**

- For the external power source, use of the Compact Battery Pack CP-E4N (sold separately) is recommended.

Flash Firing Restriction due to Temperature Increase

 [Temperature Increase Warning](#)

 [Number of Continuous Flashes and Rest Time](#)



When continuous flash, stroboscopic flash, or modeling flash is repeatedly fired in short intervals, the temperature of the flash head, batteries, and the area near the battery compartment may increase.

When you perform firing repeatedly, the firing interval increases in steps within the range of up to approx. 4 sec. to avoid degrading or damaging the flash head due to overheating. When you perform firing repeatedly even more in this state, flash firing is restricted automatically.

Furthermore, when flash firing is restricted, a warning icon is displayed to indicate the increase in temperature, and the firing interval (with which the flash photography can be performed) will be automatically set to approx. 8 sec. (level 1) or approx. 20 sec. (level 2).

Temperature Increase Warning

As the internal temperature of the flash unit increases, the warning is displayed in two levels. When you perform continuous firing repeatedly even more in the state in level 1, the state changes to level 2.

| Display / Tone | Level 1 (firing interval: About 8 seconds) | Level 2 (firing interval: About 20 seconds) |
|------------------------|---|---|
| Icon |  |  |
| LCD panel illumination | Lit | Blinking |
| Beep | When P.Fn-06 is set to 0: Warning beep on | |





Modeling lamp temperature increase warning

A warning screen appears when the temperature of the modeling lamp rises.

Press the joystick vertically or the <  > button to clear warning messages on the warning screen.



If the ambient temperature of the modeling lamp becomes too high, the lamp may dim or turn off.

| Display | Level 1 | | Level 2 | |
|------------|---|---|---|---|
| Icon |  |  |  |  |
| | On | Off | On | Off |
| Brightness | When setting maximum brightness: dimmed | | Off | |

Battery temperature increase warning

The mark below appears when the temperature of the battery rises. Subsequently, the display returns to the same state as the temperature increase warning (🔋).

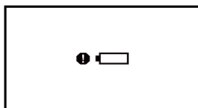

Number of Continuous Flashes and Rest Time

The following table shows the number of continuous flashes until the warning (level 1) is displayed, and the necessary rest time (guideline) until normal flash photography can be performed.

| Function | | Number of Continuous Flashes to Reach Level 1 Warning (Guideline) | | Necessary Interval Time (Guideline) |
|-------------------------------------|-----------|---|-------------------|-------------------------------------|
| | | Flash coverage | | |
| | | 14 mm - 135 mm | 150 mm - 200 mm | |
| Continuous full emission (🔒) | Fan drive | 170 times or more | 160 times or more | 50 min. or longer |
| | Fan stop | 50 times or more | | |
| Modeling flash (🔒) | Fan drive | 130 times or more | | |
| | Fan stop | 50 times or more | | |
| Stroboscopic flash (🔒) | | Varies depending on firing conditions | | - |

* Set to manual flash and measure according to our test standards

CAUTION

- **When performing continuous flashes, do not touch the flash head, batteries, or the area near the battery compartment.**

When continuous flash or modeling flash is repeatedly fired at short intervals, do not touch the flash head, batteries, or the area near the battery compartment. The flash head, battery, and area near the battery compartment become hot, resulting in a risk of burns.

Caution

- Do not open or close the battery compartment cover while flash firing is being restricted. Doing so is very dangerous since the flash firing restriction is canceled.
- Even when level 1 warning is not displayed, the firing interval will be extended as the flash head begins to heat up.
- If level 1 warning is displayed, allow a rest time for at least 50 min.
- Even if you stop flash firing after level 1 warning is displayed, level 2 warning may be displayed.
- When taking flash photography in <ETTL> flash mode or at high temperatures, the number of flashes may be restricted to fewer than those listed in the table.
- For cautions on the number of flash firings, see "[Continuous Flashes](#)", "[Stroboscopic Flash](#)" or "[Modeling Flash](#)".
- The flash may not fire in rare cases due to environmental factors such as temperature rise.
- The number of continuous flashes until the warning (Level 1) is displayed is the number of times the EL-1 is used on its own and when it is used in combination with the compact battery pack CP-E4N (sold separately). When an external power source other than the CP-E4N is used, the number of continuous flashes until the warning (level 1) is displayed becomes fewer.
- When the bounce adapter is used, when the color filter is used, and when both the bounce adapter and color filter are used together, the number of continuous flashes until the warning is displayed becomes slightly fewer.
- When P.Fn-06-1 is set (Ⓢ), the warning beep does not sound even when flash firing is restricted.
- When C.Fn-22-1 is set (Ⓢ), the warning by the LCD panel illumination will not be displayed even if the temperature of the flash head rises.
- When using Compact Battery Pack CP-E4N (sold separately), also refer to the CP-E4N Instruction Manual.

Troubleshooting

- [✔ Power Supply-Related](#)
- [✔ Normal Shooting](#)
- [✔ Radio Transmission Wireless Flash Shooting](#)
- [✔ Linked Shooting](#)
- [✔ Optical Transmission Wireless Flash Shooting](#)

If a problem occurs with the flash, first refer to this Troubleshooting Guide. If this Troubleshooting Guide does not resolve the problem, contact your dealer or nearest Canon Service Center.

Power Supply-Related

Batteries cannot be charged with the charger.

- When the remaining battery level is 90% or more, charging will not be performed.
- Do not use any battery other than genuine Canon Battery Pack LP-EL.

The charger's lamp blinks at high speed.

- If (1) the battery charger or battery has a problem or (2) communication with the battery failed (with a non-Canon battery pack), the protection circuit will stop charging, and the charge lamp will blink in orange at a constant high speed. In the case of (1), unplug the charger's power plug from the power outlet. Detach and reattach the battery to the charger. Wait a few minutes, then reconnect the power plug to the power outlet. If the problem persists, contact your nearest Canon Service Center.

The charger's lamp does not blink.

- If the internal temperature of the battery attached to the charger is high, the charger will not charge the battery for safety reasons (lamp off). During charging, if the battery's temperature becomes high for any reason, charging will stop automatically (lamp blinks). When the battery temperature goes down, charging will resume automatically.

[Cannot communicate with battery Use this battery?] appears.

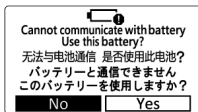

- The battery pack may be faulty. If it is faulty, replace it with a new battery pack.
- For safety, we recommend using LP-EL, genuine battery pack.
- If you continue using a battery pack that is no longer capable of communicating, the flash recharge time will increase for safety reasons.
- Take out and put back the batteries (🔧).
- If the electrical contacts are dirty, use a soft cloth to clean them.

The battery becomes exhausted quickly.

- Use a fully-charged battery (🔧).
- The battery performance may have degraded. Refer to [Checking the Battery Information](#) to check the degradation condition of the battery. If the battery performance is poor, replace the battery with a new one.
- The battery is depleted faster when you perform the following operations.
 - Fire the modeling flash repeatedly a few times
 - Keep the lit status of the modeling lamp for a while
 - Using the wireless function

The power turns off by itself.

- Auto power off has been activated. To ensure that the power supply does not turn off automatically, set C.Fn-01-1 in the Custom Function screen (🔧).

Normal Shooting

The power does not turn on.

- Check whether the battery compartment cover is closed (🔗).
- Replace the batteries with new ones.

The Speedlite does not fire.

- Insert the mounting foot into the camera's hot shoe all the way, slide the lock lever to the right, and secure the Speedlite to the camera (🔗).
- If the < **CHARGE** > indication remains displayed for approx. 15 sec. or longer, replace the batteries (🔗).
- If the electrical contacts of the Speedlite or camera are dirty, wipe the contacts (🔗) with a dry cloth, etc.
- When you perform continuous firing repeatedly over a short period of time, causing the temperature of the flash head to rise and flash firing to be restricted, the firing interval increases (🔗).
- If the internal temperature of the battery attached to the charger is high, the charger will not charge the battery for safety reasons. During charging, if the battery's temperature becomes high for any reason, charging will stop automatically. When the battery temperature goes down, charging will resume automatically (🔗).

The power turns off by itself.

- The Speedlite's auto power off has been activated (🔗). Press the shutter button halfway or press the test flash button (🔗).

Pictures are underexposed or overexposed.

- If the main subject looks very dark or very bright, set flash exposure compensation (🔗).
- If there is a highly reflective object in the picture, use FE lock (🔗).
- With high-speed sync, the faster the shutter speed, the lower the guide number becomes. Move closer to the subject (🔗).

The bottom of the picture looks dark.

- Move at least 0.5 m / 1.6 ft. away from the subject.
- When shooting within 1 m / 3.3 ft. of the subject, set the bounce angle down by 7° (🔗).
- Remove the lens hood if attached.

The picture periphery looks dark.

- Set the flash coverage to < **A** > (automatic setting) (🔗).
- When manually setting the flash coverage, set a flash coverage wider than the shooting angle of view (🔗).
- Make sure C.Fn-21-1 is not set (🔗).

The picture is very blurred.

- When the shooting mode is set to the < **Av** > aperture-priority AE mode and the scene is dark, slow sync is enabled automatically (the shutter speed becomes slower). Use a tripod, or set the shooting mode to the < **P** > program AE or fully automatic mode (🔗). Note that you can also set the sync speed in [**Flash sync. speed in Av mode**] (🔗).

The flash coverage is not set automatically

- Set the flash coverage to < **A** > (automatic setting) (🔗).
- Insert the mounting foot into the camera's hot shoe all the way, slide the lock lever to the right, and secure the Speedlite to the camera (🔗).

The flash coverage cannot be set manually.

- Remove the bounce adapter (🔗).
- Retract the wide panel (🔗).

Functions cannot be set.

- Set the camera's shooting mode to < **Fv** > < **P** > < **Tv** > < **Av** > < **M** > < bulb (**B**) > (Advanced Shooting Zone).
- Set the Speedlite's power switch to < **ON** > instead of < **LOCK** > (🔗).

Modeling lamp does not light up.

- Rest the unit for 30 minutes if the modeling lamp goes off. If the problem persists, contact your nearest Canon Service Center.

Radio Transmission Wireless Flash Shooting

The receiver unit does not fire or unexpectedly fires at full output.

- Set the sender unit to < (P) **SENDER** > and the receiver unit to < (P) **RECEIVER** > (☑).
- Set the transmission channels and wireless radio IDs of the sender unit and receiver unit to the same number (☑).
- Make sure the receiver unit is within the transmission range of the sender unit (☑).
- Run the transmission channel scan and set the channel with the best reception signal (☑).
- Position the receiver unit at a location with the clearest possible view of the sender unit.
- Turn the front side of the receiver's main body towards the sender unit.
- The camera's built-in flash cannot be used as the sender unit in radio transmission wireless shooting.

Pictures are overexposed.

- When performing autoflash photography with three firing groups A, B, and C, do not fire with firing group C pointing toward the main subject (☑).
- When shooting with the flash mode set for each firing group, do not fire multiple firing groups set in < **ETTL** > < **Ext.A** > against the main subject (☑).

< Tv > is displayed.

- Set the shutter speed one step slower than the maximum flash synchronization shutter speed (☑).

Cannot remote release from a receiver unit.

- Remote release is not possible from a receiver unit in cameras released up to 2011 or EOS REBEL T100/4000D/3000D, EOS REBEL T7/1500D/2000D, EOS REBEL T6/1300D or EOS REBEL T5/1200D.

The LCD panel illumination turns on and off.

- The sender unit's LCD panel illuminates or turns off according to the charge status of the receiver units (firing groups). See the section on "[About the LCD Panel Illumination](#)".

Linked Shooting

Standard exposure is not obtained. / Uneven exposure occurs.



- If you fire multiple Speedlites simultaneously during linked shooting, the appropriate exposure may not be obtained or uneven exposure may result. It is recommended to set only one Speedlite to fire or to use a self-timer to space out the timing of firing.

The unit cannot be used as a receiver camera unit.

- When used with a camera released up to 2011 or with EOS REBEL T100/4000D/3000D, EOS REBEL T7/1500D/2000D, EOS REBEL T6/1300D or EOS REBEL T5/1200D, the unit can be used only as "sender camera unit". The unit cannot be used as a "receiver camera unit".

Optical Transmission Wireless Flash Shooting

The receiver unit does not fire or unexpectedly fires at full output.

- Set the sender unit to <  **SENDER** > and the receiver unit to <  **RECEIVER** > (🔍).
- Set the transmission channels of the sender unit and receiver unit to the same numbers (🔍).
- Make sure the receiver unit is within the transmission range of the sender unit (🔍).
- Point the wireless sensor of the receiver unit toward the sender unit (🔍).
- Position the receiver unit at a location with the clearest possible view of the sender unit.
- If the sender unit and receiver unit are too close, the transmission may not take effect properly.
- When you use the built-in flash of the camera as a sender unit, raise the built-in flash of the camera and configure the **[Wireless functions]** settings in the **[Built-in flash settings]** of the camera.

The sender unit fires.

- Even when sender flash firing is set to OFF, the sender unit fires a small flash to control the receiver unit with optical transmission (🔍).

Pictures are overexposed.

- When performing autoflash photography with three firing groups A, B, and C, do not fire with firing group C pointing toward the main subject (🔍).

Specifications

Type

| | |
|--------------------|--|
| Type | Shoe-mount E-TTL II / E-TTL autoflash Speedlite |
| Compatible cameras | EOS series supporting E-TTL II / E-TTL autoflash * For details, refer to the Canon website. |

Flash head

| | | | | | | | | | | | | |
|--------------|--|------|-----------------------|------|------|------|------|------|------|-------|-------|-------|
| Guide number | Normal flash guide number Maximum guide number (at approx. ISO 100) | | | | | | | | | | | |
| | | | Flash coverage | | | | | | | | | |
| | Light distribution | Unit | 14mm ^{*1} | 24mm | 28mm | 35mm | 50mm | 70mm | 80mm | 105mm | 135mm | 200mm |
| | Standard | m | 14.1 | 27.3 | 27.9 | 31.9 | 36.6 | 42.9 | 46.9 | 51.1 | 54.0 | 60.0 |
| | Guide number priority | m | | 31.9 | 31.9 | 36.6 | 42.9 | 48.6 | 54.0 | 55.4 | 60.0 | 60.0 |
| | Light distribution priority | m | | 27.3 | 27.3 | 27.3 | 29.0 | 33.5 | 36.6 | 42.9 | 46.9 | 51.1 |
| | * 1: When using the wide panel. | | | | | | | | | | | |
| | High-speed sync guide number Maximum guide number (at approx. ISO 100) | | | | | | | | | | | |
| | | | Flash coverage | | | | | | | | | |
| | Shutter speed | Unit | 14mm | 24mm | 28mm | 35mm | 50mm | 70mm | 80mm | 105mm | 135mm | 200mm |
| 1/125 | m | 8.8 | 17.0 | 17.4 | 19.8 | 22.8 | 26.7 | 29.2 | 31.8 | 33.6 | 37.3 | |
| 1/250 | m | 7.5 | 14.5 | 14.8 | 16.9 | 19.4 | 22.7 | 24.8 | 27.1 | 28.6 | 31.8 | |
| 1/500 | m | 4.9 | 9.5 | 9.7 | 11.1 | 12.8 | 15.0 | 16.4 | 21.7 | 23.0 | 25.5 | |
| 1/1000 | m | 3.5 | 6.7 | 6.9 | 7.9 | 9.0 | 10.6 | 11.6 | 16.6 | 17.6 | 19.5 | |
| 1/2000 | m | 2.5 | 4.8 | 4.9 | 5.6 | 6.4 | 7.5 | 8.2 | 12.3 | 13.0 | 14.4 | |
| 1/4000 | m | 1.7 | 3.4 | 3.4 | 3.9 | 4.5 | 5.3 | 5.8 | 8.9 | 9.4 | 10.4 | |
| 1/8000 | m | 1.2 | 2.4 | 2.4 | 2.8 | 3.2 | 3.7 | 4.1 | 6.4 | 6.7 | 7.5 | |

Manual flash guide number

Maximum guide number (at approx. ISO 100)

| Flash output | Unit | Flash coverage | | | | | | | | | |
|--------------|------|----------------|------|------|------|------|------|------|-------|-------|-------|
| | | 14mm | 24mm | 28mm | 35mm | 50mm | 70mm | 80mm | 105mm | 135mm | 200mm |
| 1/1 | m | 14.1 | 27.3 | 27.9 | 31.9 | 36.6 | 42.9 | 46.9 | 51.1 | 54.0 | 60.0 |
| 1/2 | m | 10.0 | 19.3 | 19.7 | 22.6 | 25.9 | 30.3 | 33.2 | 36.1 | 38.2 | 42.4 |
| 1/4 | m | 7.1 | 13.7 | 14.0 | 16.0 | 18.3 | 21.5 | 23.5 | 25.6 | 27.0 | 30.0 |
| 1/8 | m | 5.0 | 9.7 | 9.9 | 11.3 | 12.9 | 15.2 | 16.6 | 18.1 | 19.1 | 21.2 |
| 1/16 | m | 3.5 | 6.8 | 7.0 | 8.0 | 9.2 | 10.7 | 11.7 | 12.8 | 13.5 | 15.0 |
| 1/32 | m | 2.5 | 4.8 | 4.9 | 5.6 | 6.5 | 7.6 | 8.3 | 9.0 | 9.5 | 10.6 |
| 1/64 | m | 1.8 | 3.4 | 3.5 | 4.0 | 4.6 | 5.4 | 5.9 | 6.4 | 6.8 | 7.5 |
| 1/128 | m | 1.2 | 2.4 | 2.5 | 2.8 | 3.2 | 3.8 | 4.1 | 4.5 | 4.8 | 5.3 |
| 1/256 *1 | m | 0.9 | 1.7 | 1.7 | 2.0 | 2.3 | 2.7 | 2.9 | 3.2 | 3.4 | 3.8 |
| 1/512 *1 | m | 0.6 | 1.2 | 1.2 | 1.4 | 1.6 | 1.9 | 2.1 | 2.3 | 2.4 | 2.7 |
| 1/1024 *1 | m | 0.4 | 0.9 | 0.9 | 1.0 | 1.1 | 1.3 | 1.5 | 1.6 | 1.7 | 1.9 |
| 1/2048 *1 | m | 0.3 | 0.6 | 0.6 | 0.7 | 0.8 | 0.9 | 1.0 | 1.1 | 1.2 | 1.3 |
| 1/4096 *1 | m | 0.2 | 0.4 | 0.4 | 0.5 | 0.6 | 0.7 | 0.7 | 0.8 | 0.8 | 0.9 |
| 1/8192 *1 | m | 0.2 | 0.3 | 0.3 | 0.4 | 0.4 | 0.5 | 0.5 | 0.6 | 0.6 | 0.7 |

* 1: It cannot be used when setting high-speed sync or optical transmission wireless

Flash coverage
(focal length; for
35mm full-frame)

| | |
|-------|---|
| 14mm | Wide panel: Manual * Not compatible with EF15mm f/2.8 Fisheye or EF8-15mm f/4L Fisheye USM shooting angles of view Zoom • A: Auto Flash coverage is set automatically, accounting for [Auto zoom for sensor size] and [Light distribution] settings at the lens focal length • M: Manual Flash coverage is set manually * [Auto zoom for sensor size] and [Light distribution] settings are not taken into account |
| 24mm | |
| 28mm | |
| 35mm | |
| 50mm | |
| 70mm | |
| 80mm | |
| 105mm | |
| 135mm | |
| 200mm | |

Bounce angle

| Bounce direction | | Bounce angle (approx.) | | | | | |
|------------------|-----|------------------------|-----|-----|------|------|------|
| Up | 0°* | 45° | 60° | 75° | 90°* | 120° | |
| Down | | 7° | | | | | |
| Left | 0°* | 60° | 75° | 90° | 120° | 150° | 180° |
| Right | | 60° | 75° | 90° | 120° | 150° | 180° |

* Position at which the bounce lock is engaged

| | | | | |
|--|--|--------------------------------|--------------|--------------------------------|
| Flash duration | Normal flash | | | |
| | Flash output | Flash duration (Approx., sec.) | Flash output | Flash duration (Approx., sec.) |
| | 1/1 | 1/960 | 1/128 | 1/37020 |
| | 1/2 | 1/1200 | 1/256 | 1/46840 |
| | 1/4 | 1/2600 | 1/512 | 1/57000 |
| | 1/8 | 1/4790 | 1/1024 | 1/80300 |
| | 1/16 | 1/8510 | 1/2048 | 1/82670 |
| | 1/32 | 1/14750 | 1/4096 | 1/91520 |
| | 1/64 | 1/26790 | 1/8192 | 1/107800 |
| Color temperature information transmission | Supported | | | |
| Color filter | A hard-type color filter (two types) is supported. | | | |

Exposure control

| Flash modes (Exposure control modes) | Flash modes and available functions | | | | | |
|--|--|--------------------------------|---------------------------------|---------|--------------------|----------------------|
| | Flash mode | Flash exposure compensation | FEB | FE lock | Wireless | |
| | | | | | Radio transmission | Optical transmission |
| | E-TTL II / E-TTL autoflash *1 | ○ | ○ | ○ | ○ | ○ |
| | Manual flash | | | | ○ | ○ |
| | Stroboscopic flash | | | | ○ | ○ |
| | Auto external flash metering | ○ | ○ | | ○ *2 | |
| | Manual external flash metering | | | | | |
| Continuous shooting priority mode | ○ | ○ | ○ | | | |
| Group firing *3 | ○ | ○ | ○ *4 | ○ | | |
| | * 1: Set automatically when the camera shooting mode is set to Basic Zone modes * 2: Only Group firing is available * 3: Can only be set when the Speedlite is used as a sender in radio transmission wireless operation * 4: Only groups set to E-TTL II / E-TTL autoflash | | | | | |
| Effective flash range | Dim interlocking range under the following conditions | | | | | |
| | <ul style="list-style-type: none"> • Sensor size: 35mm full-frame • Flash coverage: 50 mm • Aperture value: f/1.4 • ISO 100 • Light distribution: Standard | | | | | |
| | Firing conditions | | Effective flash range (approx.) | | | |
| | Normal flash (Flash-ready lamp: lit) | | 0.5 - 26.1 m 1.6 - 85.6 ft. | | | |
| | Quick flash (Flash-ready lamp: blinking) | | 0.5 - 16.0 m 1.6 - 52.5 ft. | | | |
| High-speed sync (Shutter speed: 1/250) | | 0.5 - 13.8 m 1.6 - 45.3 ft. | | | | |

| | | | | | |
|-----------------------------|---|-----------------------------------|------------------|------------------|-----------------|
| Flash exposure compensation | <p>±3 stops, in 1/3-stop or 1/2-stop *1 increments</p> <p>* The Speedlite's flash exposure compensation takes precedence if flash exposure compensation is performed by both the Speedlite and the camera. Users who prefer to enable flash exposure compensation by the camera should set flash exposure compensation by the Speedlite to 0.</p> <p>*1: Corresponds to exposure level increments on the camera</p> | | | | |
| FEB | <p>±3 stops, in 1/3-stop or 1/2-stop *1 increments</p> <p>* FEB is automatically deactivated after three shots</p> <p>* Can be used with flash exposure compensation and FE lock</p> <p>*1: Corresponds to exposure level increments on the camera</p> | | | | |
| FE lock | Supported | | | | |
| FE memory | Supported | | | | |
| Synchronization | Wireless | Flash mode | 1st-curtain sync | 2nd-curtain sync | High-speed sync |
| | OFF | E-TTL II / E-TTL autoflash | o | o | o |
| | | Manual flash | o | o | o |
| | | Stroboscopic flash | o | | |
| | | Auto external flash metering | o | | |
| | | Manual external flash metering | o | | |
| | | Continuous shooting priority mode | o | o | o |
| | Radio transmission (Sender) | E-TTL II / E-TTL autoflash | o | o *1 | o |
| | | Manual flash | o | o *1 | o |
| | | Stroboscopic flash | o | | |
| | | Group firing | o | o *1 | o |
| | Optical transmission (Sender) | E-TTL II / E-TTL autoflash | o | | o |
| | | Manual flash | o | | o |
| | | Stroboscopic flash | o | | |
| | *1: For details on cameras that support this feature, refer to the Canon website. | | | | |
| Modeling lamp | Supported | | | | |
| Modeling flash | <p>Supported</p> <p>* Flash fires continuously for approx. 1 sec.</p> | | | | |

Flash recharge

| | | | | |
|--|---------------------------|-------------------------------------|------------------------|---|
| Recharge time | Power supply | Recharge time (approx.) | | Flash count (approx.) |
| | | Normal flash | Quick flash | |
| | Battery Pack LP-EL | 0.1 - 0.9 sec. | 0.1 - 0.8 sec. | 335 - 2345 |
| * Based on Canon testing standards | | | | |
| Flash-ready indication | | Normal flash (fully charged) | Quick flash | Charging in progress |
| | Flash-ready lamp | Lit in red | Blinking in red (8 Hz) | Off |
| | LCD panel display | Not displayed | Not displayed | CHARGE Recharge level indicated in a range of 1-5 |
| | Beep *1 | o *2 | o *3 | - |
| * 1: With the relevant Personal Function (P.Fn-06, Beep) set to ON | | | | |
| * 2: With the relevant Personal Function (P.Fn-02, Quick flash) set to OFF | | | | |
| * 3: With the relevant Personal Function (P.Fn-02, Quick flash) set to ON | | | | |

AF-assist beam

| Infrared | <ul style="list-style-type: none"> Light emitted Near-infrared light Compatible AF system TTL secondary image-forming phase-difference AF Effective range <table border="1"> <thead> <tr> <th>AF points</th> <th>Effective range (approx.)</th> </tr> </thead> <tbody> <tr> <td>At center</td> <td>0.6 - 10.0 m / 2.0 - 32.8 ft.</td> </tr> <tr> <td>At periphery</td> <td>0.6 - 5.0 m / 2.0 - 16.4 ft.</td> </tr> </tbody> </table> <p>* Lens focal length: 28 mm or longer * AF points: Compatible with 1-191 points</p> | AF points | Effective range (approx.) | At center | 0.6 - 10.0 m / 2.0 - 32.8 ft. | At periphery | 0.6 - 5.0 m / 2.0 - 16.4 ft. |
|----------------------------------|--|-----------|---------------------------|-----------|-------------------------------|--------------|------------------------------|
| AF points | Effective range (approx.) | | | | | | |
| At center | 0.6 - 10.0 m / 2.0 - 32.8 ft. | | | | | | |
| At periphery | 0.6 - 5.0 m / 2.0 - 16.4 ft. | | | | | | |
| Intermittent flash firing method | <p>The AF-assist beam does not emit small series of flashes under the following conditions.</p> <ul style="list-style-type: none"> - When the Speedlite is used as a sender in optical transmission wireless operation - With color filter attached <ul style="list-style-type: none"> Light emitted Visible light Compatible AF system <ul style="list-style-type: none"> - TTL secondary image-forming phase-difference AF - Dual Pixel CMOS AF * In camera compatibility, some restrictions apply Effective range <table border="1"> <thead> <tr> <th>AF points</th> <th>Effective range (approx.)</th> </tr> </thead> <tbody> <tr> <td>At center</td> <td>0.6 - 10.0 m / 2.0 - 32.8 ft.</td> </tr> <tr> <td>At periphery</td> <td>0.6 - 5.0 m / 2.0 - 16.4 ft.</td> </tr> </tbody> </table> <p>* Lens focal length: 24 mm or longer * Direction emitted: Straight forward</p> | AF points | Effective range (approx.) | At center | 0.6 - 10.0 m / 2.0 - 32.8 ft. | At periphery | 0.6 - 5.0 m / 2.0 - 16.4 ft. |
| AF points | Effective range (approx.) | | | | | | |
| At center | 0.6 - 10.0 m / 2.0 - 32.8 ft. | | | | | | |
| At periphery | 0.6 - 5.0 m / 2.0 - 16.4 ft. | | | | | | |

Wireless functions for radio transmission

| | | |
|-------------------------|---|--|
| Wireless settings | Sender | Supported * Secondary and additional units serve as sub-senders and display a "SUB SENDER" icon * Sub-senders cannot be remotely controlled by a receiver unit |
| | Receiver | Supported |
| Communication functions | Compliance standards | IEEE 802.15.4, ARIB STD-T66 |
| | Communication method | Primary modulation: OQPAK Secondary modulation: DS-SS |
| | Transmission frequency | 2405 - 2475 MHz |
| | Channel | Channel 1 - 15 Setting: Auto / Manual |
| | Wireless radio ID | 0000 - 9999 Setting: Manual |
| | Transmission range *1 *2 | Approx. 30 m / 98.4 ft. |
| | Groups | Up to 5 groups (A - E) * Sender units are set to Group A |
| | Max. sender units | Up to 15 * Secondary and additional units serve as sub-senders |
| | Max. receiver units | Up to 15 |
| Linked functions | <p>Supports linked shooting with automatic shutter release of up to 16 cameras (sender: 1; receivers: 15) linked to shutter release on the sender camera.</p> <p>* Shooting is not simultaneous, because receiver cameras shoot slightly after the sender camera shutter release timing</p> | |

Wireless functions for optical transmission

| | | |
|-------------------------|-------------------------------------|---|
| Wireless settings | Sender | Supported |
| | Receiver | Supported |
| | Individual receiver | Supported |
| Communication functions | Communication method | Optical pulses |
| | Channel | Channel 1 - 4 |
| | Transmission range (approx.) | From front of flash head <ul style="list-style-type: none"> • Indoors: 0.7 - 15 m / 2.3 - 49.2 ft. • Outdoors: 0.7 - 10 m / 2.3 - 32.8 ft. |
| | Reception angle (approx.) | <ul style="list-style-type: none"> • Horizontally: 45° • Upward: 27°; Downward: 20° |
| | Groups | Up to 3 groups (A - C) |
| | Max. sender units | Unlimited |
| | Max. receiver units | Unlimited |

Power source

| Battery pack | Battery Pack LP-EL * AA/LR6 alkaline batteries and Ni-MH batteries cannot be used | | | | | | | | | | | | | | | | | | | | | | | |
|--|---|-----------------|-----------------|------|-------------------------|-----------|-----------------|--|-----------|--|-----------|----------------|------------------------|-----------|---|-----------|-----------------|-----------|-----------------|---|-----------|---------------|-----------|---------------|
| Battery level indicator | Provided (display in 5 levels) | | | | | | | | | | | | | | | | | | | | | | | |
| External power source | Supported | | | | | | | | | | | | | | | | | | | | | | | |
| Maximum flash count | Approx. 335 - 2345 * With a fully charged Battery Pack LP-EL | | | | | | | | | | | | | | | | | | | | | | | |
| Radio transmission wireless shooting time | Approx. 17 hours continuously * With sender flash firing disabled, and using a fully charged Battery Pack LP-EL | | | | | | | | | | | | | | | | | | | | | | | |
| Auto power off | Idle time before auto power off | | | | | | | | | | | | | | | | | | | | | | | |
| | <table border="1"> <thead> <tr> <th>Status</th> <th>Custom Function</th> <th>Time</th> </tr> </thead> <tbody> <tr> <td>During normal operation</td> <td>C.Fn-01-0</td> <td rowspan="2">Approx. 90 sec.</td> </tr> <tr> <td>When set as a sender in optical wireless operation</td> <td>C.Fn-01-0</td> </tr> <tr> <td>When set as a sender in radio wireless operation</td> <td>C.Fn-01-0</td> <td rowspan="2">Approx. 5 min.</td> </tr> <tr> <td>During linked shooting</td> <td>C.Fn-01-0</td> </tr> <tr> <td rowspan="2">When set as a receiver in radio or optical wireless operation</td> <td>C.Fn-10-0</td> <td>Approx. 60 min.</td> </tr> <tr> <td>C.Fn-10-1</td> <td>Approx. 10 min.</td> </tr> <tr> <td rowspan="2">Standby before power ON after auto power off when set as a receiver</td> <td>C.Fn-11-0</td> <td>Approx. 8 hr.</td> </tr> <tr> <td>C.Fn-11-1</td> <td>Approx. 1 hr.</td> </tr> </tbody> </table> | Status | Custom Function | Time | During normal operation | C.Fn-01-0 | Approx. 90 sec. | When set as a sender in optical wireless operation | C.Fn-01-0 | When set as a sender in radio wireless operation | C.Fn-01-0 | Approx. 5 min. | During linked shooting | C.Fn-01-0 | When set as a receiver in radio or optical wireless operation | C.Fn-10-0 | Approx. 60 min. | C.Fn-10-1 | Approx. 10 min. | Standby before power ON after auto power off when set as a receiver | C.Fn-11-0 | Approx. 8 hr. | C.Fn-11-1 | Approx. 1 hr. |
| | Status | Custom Function | Time | | | | | | | | | | | | | | | | | | | | | |
| | During normal operation | C.Fn-01-0 | Approx. 90 sec. | | | | | | | | | | | | | | | | | | | | | |
| | When set as a sender in optical wireless operation | C.Fn-01-0 | | | | | | | | | | | | | | | | | | | | | | |
| | When set as a sender in radio wireless operation | C.Fn-01-0 | Approx. 5 min. | | | | | | | | | | | | | | | | | | | | | |
| | During linked shooting | C.Fn-01-0 | | | | | | | | | | | | | | | | | | | | | | |
| | When set as a receiver in radio or optical wireless operation | C.Fn-10-0 | Approx. 60 min. | | | | | | | | | | | | | | | | | | | | | |
| C.Fn-10-1 | | Approx. 10 min. | | | | | | | | | | | | | | | | | | | | | | |
| Standby before power ON after auto power off when set as a receiver | C.Fn-11-0 | Approx. 8 hr. | | | | | | | | | | | | | | | | | | | | | | |
| | C.Fn-11-1 | Approx. 1 hr. | | | | | | | | | | | | | | | | | | | | | | |
| The Speedlite is reactivated in response to the following operations. | | | | | | | | | | | | | | | | | | | | | | | | |
| <ul style="list-style-type: none"> Pressing the camera shutter button halfway Pressing the test flash button | | | | | | | | | | | | | | | | | | | | | | | | |

Dimensions / Weight

| | | |
|------------|-----------|--|
| Dimensions | Product | W × H × D (approx.) |
| | Body | 84.4 × 149.0 × 136.4 mm / 3.32 × 5.87 × 5.37 in. |
| Weight | Product | Weight (approx.) |
| | Body only | 572 g / 20.18 oz. |

Operation environment

| | |
|---------------------------|-----------------------|
| Working temperature range | 0 - 45°C / 32 - 113°F |
| Working humidity | 85 % or less |

- All specifications above are based on Canon's testing standards.
- Product specifications and the exterior are subject to change without notice.

Accessories

Use of genuine Canon accessories is recommended

This product is designed to achieve optimum performance when used with genuine Canon accessories. Therefore, using this product with genuine accessories is highly recommended. Canon shall not be liable for any damage to this product and / or accidents such as malfunction, fire, etc. caused by the failure of non-genuine Canon accessories (e.g., a leakage and/or explosion of a battery). Please note that repairs arising out of the malfunction of non-genuine accessories will not be covered by the warranty for repairs, although you may request such repairs on a chargeable basis.

Caution

- Battery Pack LP-EL battery is dedicated to Canon products only. Using it with an incompatible battery charger or product may result in malfunction or accidents for which Canon cannot be held liable.