

brother

Reference Guide

Brief explanations for routine operations

DCP-L8410CDW
MFC-L8690CDW
MFC-L8900CDW
MFC-L9570CDW

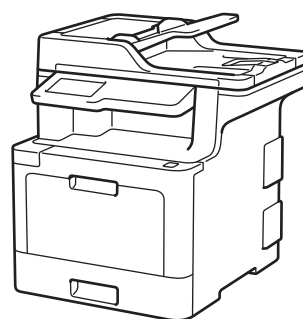

Brother recommends keeping this guide next to your Brother machine for quick reference.



Online User's Guide

This *Reference Guide* contains basic instructions and information for your Brother machine. For more advanced instructions and information, see the *Online User's Guide* at support.brother.com/manuals



User's Guides and Where to Find Them

Which Guide?	What's in It?	Where Is It?
Product Safety Guide	Read this Guide first. Please read the Safety Instructions before you set up your machine. See this Guide for trademarks and legal limitations.	Printed / In the box
Quick Setup Guide	Follow the instructions for setting up your machine, and installing the drivers and software for the operating system and connection type you are using.	Printed / In the box
Reference Guide	Learn the basic Fax, Copy and Scan operations and basic machine maintenance. See troubleshooting tips.	Printed / In the box
Online User's Guide	This guide includes the additional contents of the <i>Reference Guide</i> . In addition to information about the Print, Scan, Copy, Fax, mobile device functions, Brother ControlCenter operations and troubleshooting, other useful information is included about using the machine on a network.	Brother Solutions Center ¹
Mobile Print/Scan Guide for Brother iPrint&Scan	This Guide provides useful information about printing from your mobile device, and scanning from your Brother machine to your mobile device when connected to a Wi-Fi® network.	Brother Solutions Center ¹

¹ Visit support.brother.com/manuals.

Important Note

- This documentation is for both MFC and DCP models. Read 'XXX-XXXX' as 'MFC/DCP-XXXX' (where XXXX is the name of your model).

The Online User's Guide Helps You Get the Most Out of Your Machine

We hope that you find this guide helpful. To learn more about your machine's features, please take a look at our *Online User's Guide*. It offers:

Quicker Navigation!

- ✓ Search box
- ✓ Navigation index in a separate panel

Comprehensive Format!

- ✓ Every topic in one guide

Simplified Layout!

- ✓ Step-by-step instructions
- ✓ Feature summary at the top of the page



1. Search Box
2. Navigation
3. Summary
4. Step-by-Step Instructions

To View Online User's Guides

To view the *Online User's Guide* and other available guides, visit support.brother.com/manuals.

(Windows®)

You can also access your machine's guides using Brother Utilities. The Brother Utilities tool is included in the standard installation and, when installed, you can find it either as a shortcut on your desktop, or from the Windows® **Start** menu.

Questions or Problems? Take a Look at our FAQs, Solutions, and Videos Online.

Go to your model's **FAQs & Troubleshooting** page on the Brother Solutions Center at support.brother.com

- Provides several ways to search
- Displays related questions for more information
- Receives regular updates based on customer feedback

Control Panel Overview

The control panel may vary depending on your model.

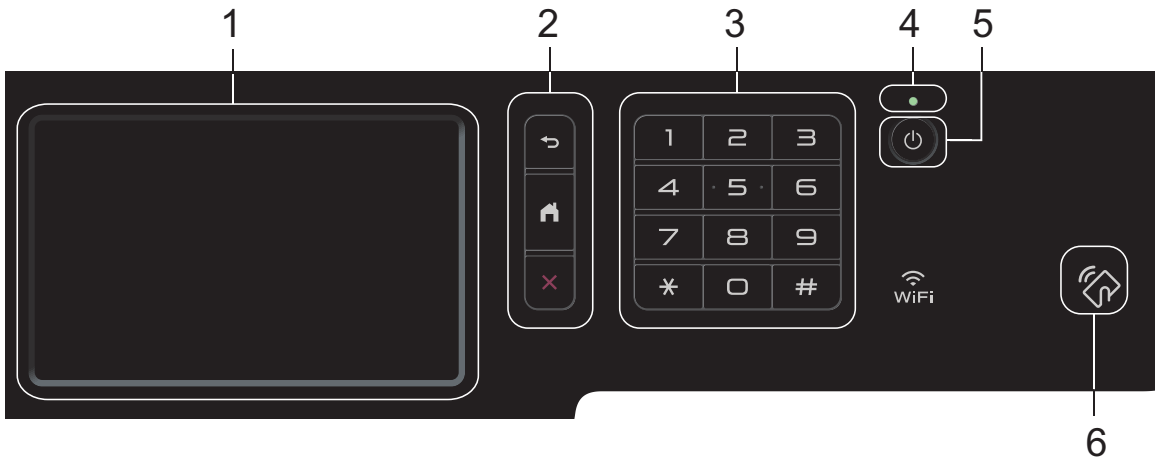

1. Touchscreen Liquid Crystal Display (LCD)

Access menus and options by pressing them on the Touchscreen.

2. Menu Buttons



(Back)

Press to go back to the previous menu.



(Home)

Press to return to the Main Home screen.



(Cancel)

Press to cancel an operation.



3. Dial Pad (Numerical buttons)

Press the Numerical buttons to dial telephone or fax numbers and to enter the number of copies.

4. LED Power Indicator

The LED lights up depending on the machine's power status.

5. Power On/Off

- Turn the machine on by pressing .
- Turn the machine off by pressing and holding down . The LCD displays [Shutting Down] for a few seconds before going off. If you have an external telephone or TAD connected, it is always available.

6. Near Field Communication (NFC) Reader (MFC-L8900CDW/MFC-L9570CDW)

You can use card authentication by touching the IC card to the NFC Reader on the control panel.

If your Android™ device supports the NFC feature, you can print from your device or scan documents to your device in the same way.

How to Navigate the Touchscreen LCD

Press your finger on the LCD to operate it. To display and access all the options, swipe left, right, up, down or press ◀▶ or ▲▼ on the LCD to scroll through them.

IMPORTANT

DO NOT press the LCD with a sharp object, such as a pen or stylus. It may damage the machine.

NOTE

DO NOT touch the LCD immediately after plugging in the power cord or turning on the machine. Doing this may cause an error.

Touchscreen LCD Overview

DCP-L8410CDW/ MFC-L8690CDW

You can select from two types of screens to set as the Main Home screen: Home screens and Shortcuts screens. When a Home screen is displayed, swipe left or right or press ◀ or ▶ to display the other Home screens.

The Main Home screen displays the machine's status when the machine is idle. When displayed, this screen indicates that your machine is ready for the next command.

If Active Directory® Authentication or LDAP Authentication is enabled, the machine's control panel is locked.

The available features vary depending on your model.

Home screen: Screen 1

The Home screens provide access to features, such as Fax, Copy and Scan.

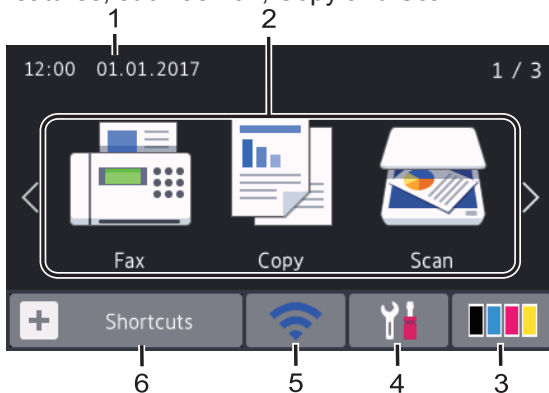

Home screen: Screen 2

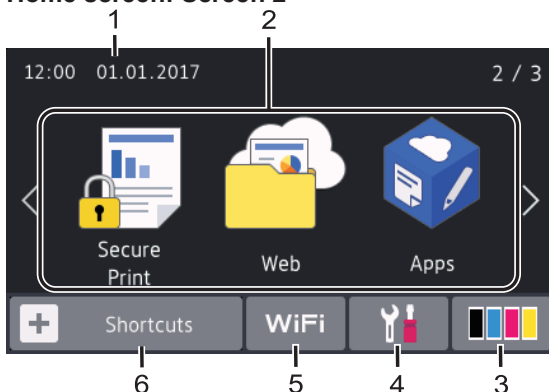

Home screen: Screen 3

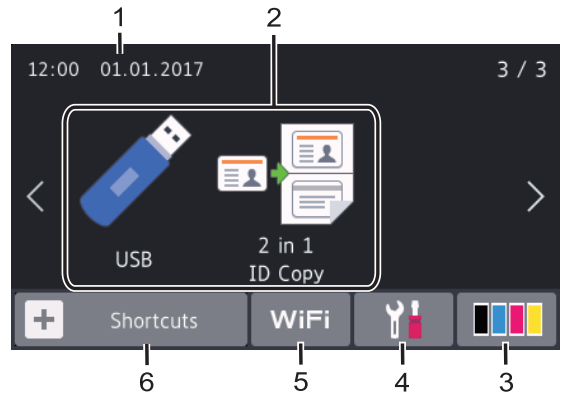

Shortcuts screen

Create Shortcuts for frequently-used operations, such as sending a fax, copying, scanning and using Web Connect.





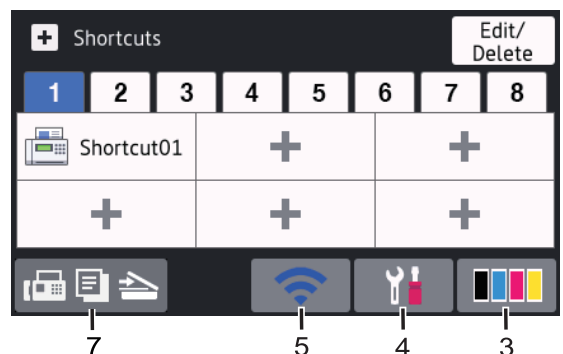

Eight Shortcuts tabs are available with six Shortcuts on each Shortcuts tab. A total of 48 Shortcuts are available.



1. Date & Time

Displays the date and time set on the machine.

2. Modes

-  [Fax]
Press to access Fax mode.
-  [Copy]
Press to access Copy mode.
-  [Scan]
Press to access Scan mode.
-  [Secure Print]
Press to access the [Secure Print] option.

•  [Web]

Press to connect the Brother machine to an Internet service.

•  [Apps]

Press to connect the Brother machine to the Brother Apps service.

•  [USB]

Press to access the USB menu and select [Scan to USB] or [Direct Print] options.

•  [2 in 1 ID Copy]

Press to access the 2 in 1 ID Copy option.

3.  (Toner)

Displays the remaining toner life. Press to access the [Toner] menu.

4.  (Settings)

Press to access the [Settings] menu. If Setting Lock has been turned on, a lock  icon appears on the LCD. You must unlock the machine to change settings.

5.  or  (Wireless Status)

Press to configure wireless settings. If you are using a wireless connection, a four-level indicator displays the current wireless signal strength.

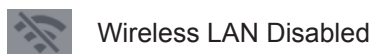

6.  [Shortcuts]

Press to access the [Shortcuts] screen.

7.  (Home screen)

Press to access the Home screens.

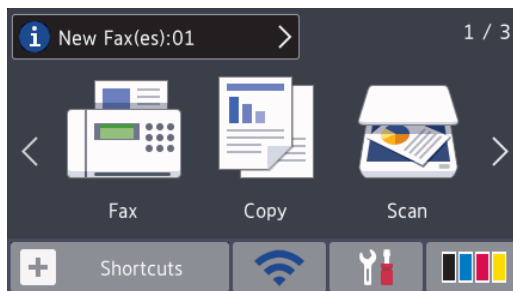

New Fax

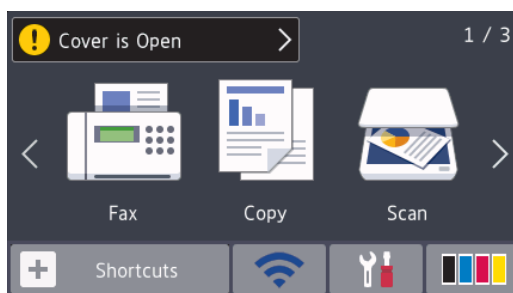

When [Fax Preview] is set to [On], the number of new faxes you received into the memory appears at the top of the screen.

Warning icon



The warning icon  appears when there is an error or maintenance message. Press the message area to view it, and then press  to return to the Main Home screen.

NOTE

This product adopts the font of ARPHIC TECHNOLOGY CO.,LTD.

MFC-L8900CDW/ MFC-L9570CDW

Your machine has eight tabbed screens (referred to as Home screens). Each Home screen can hold up to eight icons which can be used for functions, machine settings and shortcuts. A total of 64 icons can be placed on the Home screens as needed.

The Main Home screen can be selected from the Home screens.

Use the [Admin Settings] menu to names on the tabs and rearrange the icons.



1. Date & Time

Displays the date and time set on the machine.

This area is also used to display error or maintenance messages.

2. (Wired LAN Status)

Press to configure the Wired LAN settings.

The icon displays the current wired network status.



Wired LAN Disabled
(Grey)



Wired LAN Enabled
(White)



No cable connection or Wireless LAN connected

3. or (Wireless Status)

Press to configure wireless settings.

If you are using a wireless connection, a four-level indicator displays the current wireless signal strength.



0

Max



Wireless LAN Disabled

4. (Toner)

Displays the remaining toner life. Press to access the [Toner] menu.









5. (Admin Settings)

Press to access the [Admin Settings] menu.

For more information, see the *Online User's Guide: Customisation of Your Machine*.

6. Function Icons, Setting Icons and Shortcut Icons

The following descriptions explain basic icons and features. The available features vary depending on your model.

-  [All Settings]
Press to access the machine's settings menu.
-  [Fax]
Press to access Fax mode.
-  [Copy]
Press to access Copy mode.
-  [Scan]
Press to access Scan mode.
-  [Secure Print]
Press to access the [Secure Print] option.
-  [USB]
Press to access the USB menu and select [Scan to USB] or [Direct Print] options.
-  [Web]
Press to connect the Brother machine to an Internet service.
-  [Apps]
Press to connect the Brother machine to the Brother Apps service.
-  [2 in 1 ID Copy]
Press to access the 2 in 1 ID Copy option.

-  (Shortcuts)

Press to access the created Shortcuts for frequently-used operations, such as sending a fax, copying, scanning and using Web Connect.

7. Tabs Scroll Buttons

Press to display and access all the tabs.

8. Home Tabs

Press to display the screen for the Home.

New Fax

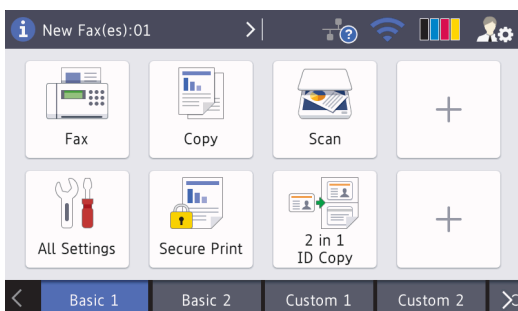

When [Fax Preview] is set to [On], the number of new faxes you received into the memory appears at the top of the screen.

Warning icon

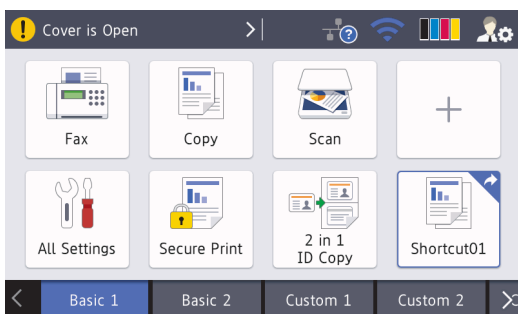

The warning icon  appears when there is an error or maintenance message. Press the message area to view it, and then press  to return to the Main Home screen.

NOTE

This product adopts the font of ARPHIC TECHNOLOGY CO.,LTD.

2

Load Paper

Load Paper in the Paper Tray

Use the paper tray when printing on the following media:

Plain paper
Thin paper
Recycled paper
Letterhead
Coloured Paper

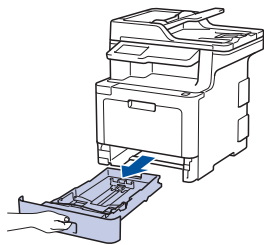

- Adjust the guides
- Fan the paper
- Do not exceed this mark

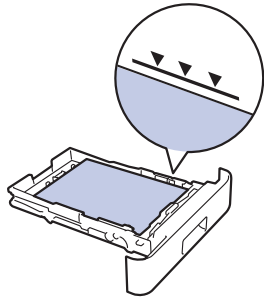

For more information, see the *Online User's Guide: Load Paper in the Paper Tray*.

Load Paper in the Multi-purpose Tray (MP Tray)

Use the MP tray when printing on the following media:

Plain paper
Thin paper
Recycled paper
Bond paper
Letterhead
Coloured Paper
Thick paper
Labels ¹
Envelopes ¹
Glossy Paper ²

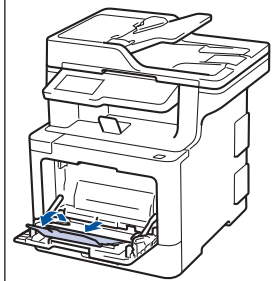

- Adjust the guides
- Fan the paper
- Do not exceed this mark

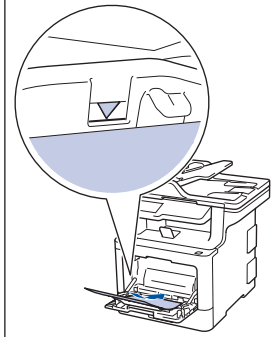

- ¹ Open the back cover (face up output tray) before printing to let the printed paper exit onto the face up output tray.
- ² When you print on glossy paper, set only a single sheet on the MP tray.

For more information, see the *Online User's Guide: Load and Print Using the Multi-purpose Tray (MP Tray)*.







Use this section to resolve problems you may encounter when using your Brother machine.

Identify the Problem

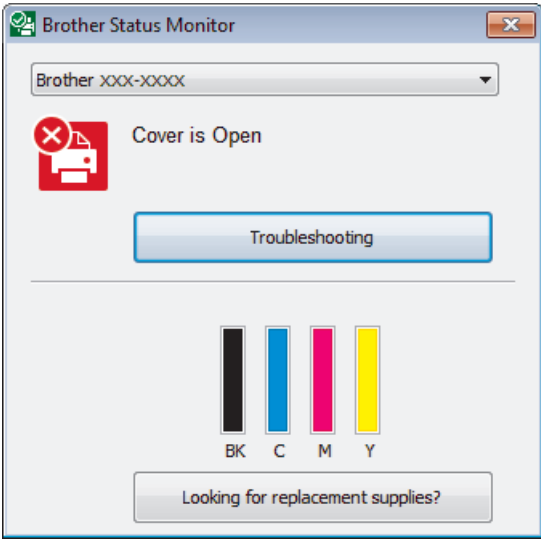
Even if there seems to be a problem with your machine, you can correct most problems yourself.

First, check the following:

- The machine's power cord is connected correctly and the machine's power is on.
- All of the machine's orange protective parts have been removed.
- (For network models) The access point (for wireless network), router, or hub is turned on and its link indicator is blinking.
- Paper is inserted correctly in the paper tray.
- The interface cables are securely connected to the machine and the computer.
- Check the LCD or the machine's status in **Brother Status Monitor** on your computer.

Find the Error	Find the Solution
<p>Using the Status Monitor</p>  <ul style="list-style-type: none"> • Double-click the  icon in the task tray. • (Windows®) If you select the Load Status Monitor on Startup check box, the Status Monitor will launch automatically each time you start your computer. 	<ul style="list-style-type: none"> • A green icon indicates the normal stand-by condition. <ul style="list-style-type: none">  • A yellow icon indicates a warning. <ul style="list-style-type: none">  • A red icon indicates an error has occurred. <ul style="list-style-type: none">  • A grey icon indicates the machine is offline. <ul style="list-style-type: none">  • Click the Troubleshooting button to access Brother's troubleshooting website.

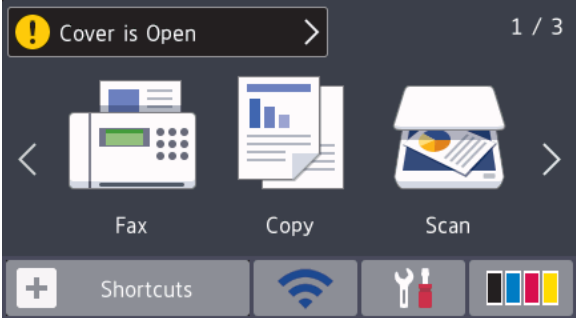
Find the Error	Find the Solution
<p>Using the LCD</p>  <p>The screenshot shows a dark-themed LCD interface. At the top, a yellow warning icon is followed by the text 'Cover is Open' and a right-pointing arrow. To the right of this message is the page indicator '1 / 3'. Below the message are three large icons: a printer labeled 'Fax', a document with a bar chart labeled 'Copy', and a scanner labeled 'Scan'. At the bottom of the screen are four smaller icons: a plus sign labeled 'Shortcuts', a Wi-Fi symbol, a wrench and screwdriver, and a color calibration bar with black, cyan, magenta, and yellow squares.</p>	<ol style="list-style-type: none">1. Follow the messages on the LCD.2. If you cannot resolve the error, see the <i>Online User's Guide: Error and Maintenance Messages</i> or see: FAQs & Troubleshooting on the Brother Solutions Center at support.brother.com.

Error and Maintenance Messages

For information on the most common error and maintenance messages, see the *Online User's Guide*.

To view the Online User's Guide and other available guides, visit support.brother.com/manuals.

Document and Paper Jams

An error message indicates where the paper is stuck in your machine.

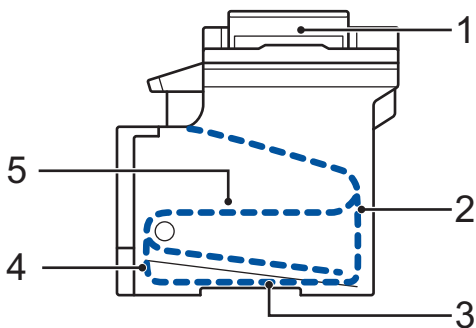

Error messages:

1. Document Jam
2. Jam Rear
3. Jam 2-sided
4. Jam Tray
5. Jam Inside

Solutions for Wireless Connection

If you cannot connect your Brother machine to the wireless network, see the following:

- *Online User's Guide: Print the WLAN Report*
- *Quick Setup Guide: Alternative wireless setup*

To view the Online User's Guide and other available guides, visit support.brother.com/manuals.

Information for Compliance with Commission Regulation 801/2013

Model name	Power consumption Networked Standby ¹
DCP-L8410CDW	Approximately 1.4 W
MFC-L8690CDW	Approximately 1.4 W
MFC-L8900CDW	Approximately 1.6 W
MFC-L9570CDW	Approximately 1.6 W

¹ All network ports activated and connected

How to enable/disable Wireless LAN

(DCP-L8410CDW/MFC-L8690CDW/MFC-L8900CDW/MFC-L9570CDW)

To turn the wireless network connection on or off, press  [Settings] > [All Settings] > [Network] > [WLAN] > [WLAN Enable] > [On] or [Off].



If your machine displays the [All Settings] menu on the Home screen, skip the [Settings] menu.

Print and Scan Using Your Mobile Device

Brother iPrint&Scan allows you to use features of your Brother machine directly from your mobile device, without using a computer. The *Mobile Print/Scan Guide for Brother iPrint&Scan* contains information on printing from your mobile device. Go to your model's **Manuals** page on the Brother Solutions Center at support.brother.com to see the guide.

Supplies

When the time comes to replace supplies, such as the toner or drum, an error message will appear on your machine's control panel or in the Status Monitor. For more information about the supplies for your machine, visit www.brother.com/original/index.html or contact your local Brother dealer.

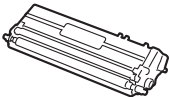

The supply model name will vary depending on your country and region.

Supply Items	Supply Model Name	Approximate Life (Page Yield)	Applicable Models
Toner Cartridge 	Standard Toner: <ul style="list-style-type: none"> Black: TN-421BK Cyan: TN-421C Magenta: TN-421M Yellow: TN-421Y 	<ul style="list-style-type: none"> Black: Approximately 3,000 pages^{1 2} Cyan / Magenta / Yellow: Approximately 1,800 pages^{1 2} 	DCP-L8410CDW/ MFC-L8690CDW/ MFC-L8900CDW
	High Yield Toner: <ul style="list-style-type: none"> Black: TN-423BK Cyan: TN-423C Magenta: TN-423M Yellow: TN-423Y 	<ul style="list-style-type: none"> Black: Approximately 6,500 pages^{1 2} Cyan / Magenta / Yellow: Approximately 4,000 pages^{1 2} 	DCP-L8410CDW/ MFC-L8690CDW/ MFC-L8900CDW

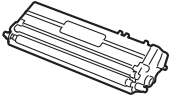
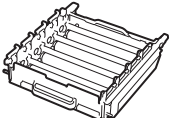
Supply Items	Supply Model Name	Approximate Life (Page Yield)	Applicable Models
Toner Cartridge (Continued) 	Super High Yield Toner: <ul style="list-style-type: none"> • Black: TN-426BK • Cyan: TN-426C • Magenta: TN-426M • Yellow: TN-426Y 	<ul style="list-style-type: none"> • Black: Approximately 9,000 pages ^{1 2} • Cyan / Magenta / Yellow: Approximately 6,500 pages ^{1 2} 	MFC-L8900CDW
	Ultra High Yield Toner: <ul style="list-style-type: none"> • Black: TN-910BK • Cyan: TN-910C • Magenta: TN-910M • Yellow: TN-910Y 	<ul style="list-style-type: none"> • Black: Approximately 9,000 pages ^{1 2} • Cyan / Magenta / Yellow: Approximately 9,000 pages ^{1 2} 	MFC-L9570CDW
	Inbox Toner: (Supplied with your machine)	<ul style="list-style-type: none"> • Black: Approximately 3,000 pages ^{1 2} • Cyan / Magenta / Yellow: Approximately 1,800 pages ^{1 2} 	DCP-L8410CDW/ MFC-L8690CDW/ MFC-L8900CDW
		<ul style="list-style-type: none"> • Black: Approximately 6,500 pages ^{1 2} • Cyan / Magenta / Yellow: Approximately 6,500 pages ^{1 2} 	MFC-L9570CDW
Drum Unit 	<ul style="list-style-type: none"> • DR-421CL 	<ul style="list-style-type: none"> • Approximately 30,000 pages ³ 	DCP-L8410CDW/ MFC-L8690CDW/ MFC-L8900CDW/ MFC-L9570CDW

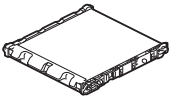
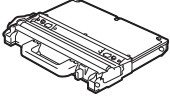
Supply Items	Supply Model Name	Approximate Life (Page Yield)	Applicable Models
Belt Unit 	<ul style="list-style-type: none"> • BU-330CL 	<ul style="list-style-type: none"> • Approximately 50,000 pages ⁴ 	DCP-L8410CDW/ MFC-L8690CDW/ MFC-L8900CDW/ MFC-L9570CDW
Waste Toner Box 	<ul style="list-style-type: none"> • WT-320CL 	<ul style="list-style-type: none"> • Approximately 50,000 pages ² 	DCP-L8410CDW/ MFC-L8690CDW/ MFC-L8900CDW/ MFC-L9570CDW

- 1 Approximate cartridge yield is declared in accordance with ISO/IEC 19798.
- 2 A4 or Letter size 1-sided pages
- 3 Approximately 30,000 pages based on 1 page per job and 50,000 pages based on 3 pages per job [A4/Letter simplex pages]. The number of pages may be affected due to a variety of factors including but not limited to media type and media size.
- 4 Approximately 50,000 pages based on 1 page per job and 130,000 pages based on 3 pages per job [A4/Letter simplex pages]. The number of pages may be affected due to a variety of factors including but not limited to media type and media size.

 **BROTHER CREATIVECENTER**

If you are using Windows[®], double-click the **Brother Creative Center** icon  on your desktop to access our **FREE** website designed as a resource to help you easily create and print customised materials for business and home use with photos, text and creativity.

Macintosh users can access Brother CreativeCenter at this web address:
www.brother.com/creativecenter

brother

Visit us on the World Wide Web
www.brother.com



D00E4T001-00
UK
Version 0