



TASSIMO

my way 2



TAS65xxGB

en Instruction manual

1



BOSCH

1 English



en Safety instructions



en At a glance



en Troubleshooting

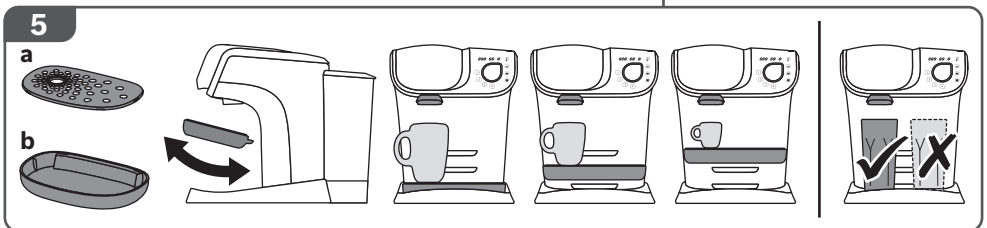
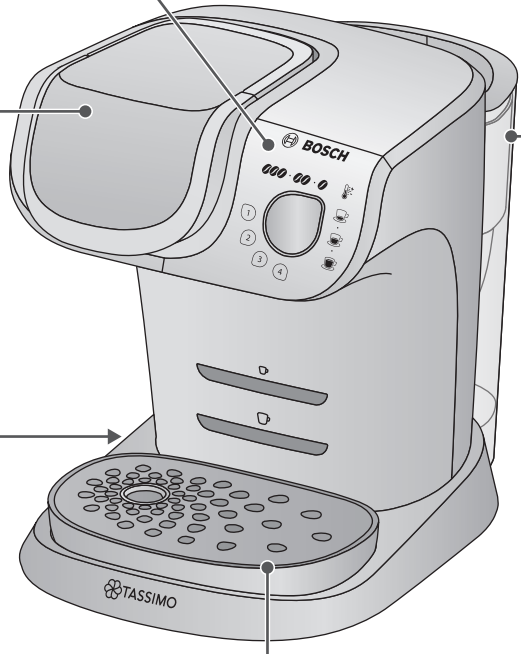
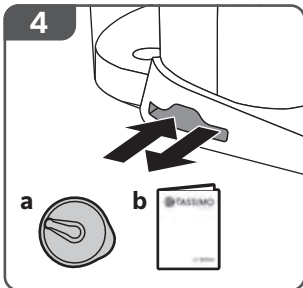
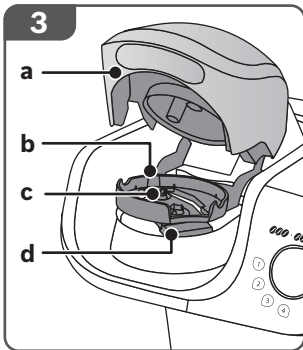
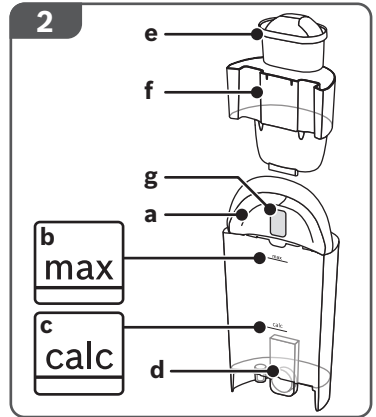
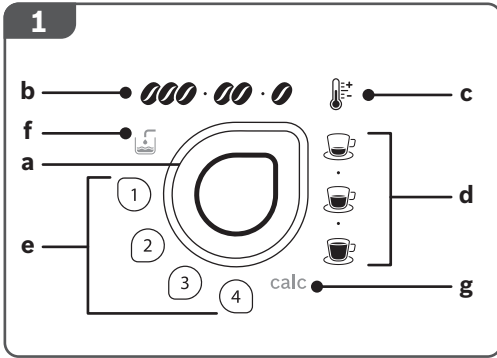



en Risk of electric shock!



en Risk of burns!

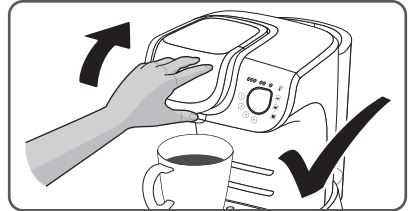
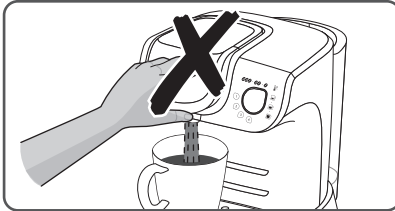
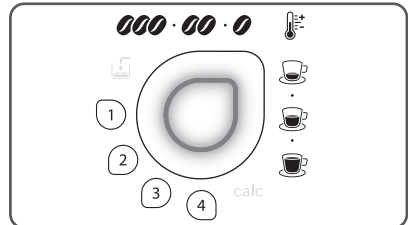
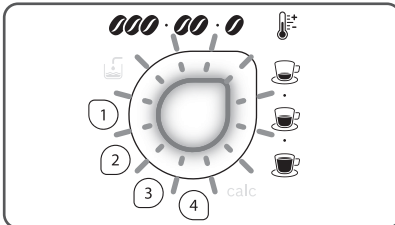



Safety instructions

Intended use

Check the appliance after unpacking it. Do not connect the appliance if it has been damaged in transit.

This appliance is intended for domestic use only.

Only use the appliance indoors at room temperature and up to 2000 m above sea level.

Important safety information

Please read parts 1 and 2 of these manuals carefully before using the product and keep them for future reference.

Pass them on to all users.

This appliance may be used by children aged 8 years and older and by persons with reduced physical, sensory or mental capabilities or who lack experience and/or knowledge if they are supervised or have been given instruction in the safe use of the appliance and have understood the dangers involved. Children may not play with the appliance.

Cleaning and user maintenance shall not be made by children unless they are older than 8 years and supervised.

Keep children under 8 years of age away from the appliance and connecting cable and do not allow them to use the appliance.

For optimum results, fill the tank only with cool, fresh, non-carbonated water each day.

Do not use chemically softened water.

Never leave the appliance unattended while it is in operation!

Risk of electric shock!

- Operate and connect the appliance only in accordance with the instructions given on the nameplate.
- The appliance may only be connected to a power supply with alternating current via a correctly installed socket with earthing. Ensure that the protective conductor system of the domestic supply has been correctly installed.
- Before cleaning the appliance, pull out the mains plug.
- Only use your TASSIMO appliance if the power cable and appliance show no signs of damage.
- Disconnect the appliance from the mains as soon as a fault is detected.
- Any repairs, such as replacing a damaged power cable, may only be carried out by our Customer Services team in order to avoid potential danger.



Safety instructions

- Never immerse the appliance or power cable in water.
- Avoid spillage on the connector.
- Please note the special information on cleaning in the instructions.

Risk of burns!

- Never attempt to open the brewing unit during operation. Please note that any escaping liquids will be very hot. The T DISC, the piercing unit and the beverage outlet may be very hot immediately after brewing. Allow to cool first.
- Do not use T DISCs that are damaged.
- Only use each T DISC once.
- After the use the heating element surfaces can be subjected to residual heat.
- Freshly prepared beverages are very hot. Leave to cool a little if necessary.

Risk of fire!

- The appliance gets hot.
- Never operate the appliance in a cupboard.

Risk of injury!

- A misuse of the appliance can potentially lead to injury.
- Under no circumstances you should drink the descaling liquid.

Risk of suffocation!

- Do not allow children to play with packaging material.
- Store small parts safely as they can be easily swallowed.

Caution!

- **Cleaning surfaces which come into contact with foodstuffs!** Please note the special information on cleaning in the illustrated instructions.



At a glance

Before reading on, please unfold the illustrations page at the start of the booklet.

1 Control panel

- a **Start/Stop** button with status display
- b Display/buttons for drink intensity
- c Display/button for drink temperature
- d Display/buttons for drink size
- e Display/buttons for saving and calling up individual settings
- f Display "Fill water tank"
- g Display/button „Descal“ calc

2 Removable water tank

- a Lid with handle (removable)
- b **max** mark
- c "Descaling" calc mark
- d Float
- e BRITA MAXTRA+ filter cartridge
- f Filter cartridge holder
- g BRITA cartridge replacement indicator

3 Brewing unit

- a Lid
- b T DISC support (removable)
- c T DISC piercing unit with beverage outlet (removable)
- d T DISC reading window

4 Storage compartment

- a Orange Service T DISC
- b Brief cleaning/descaling instructions

5 Cup stand (removable and height adjustable)

- a Drip gate
- b Drip tray



Info

Bosch is the manufacturer of the TASSIMO machine. Therefore, it cannot provide any delivery guarantee for the TASSIMO T DISCs. TASSIMO T DISCs are available from specialist retailers. Visit www.tassimo.com to discover the large variety of beverages available. Here you can discover and order the right TASSIMO accessories online.



Accessories

Accessories	Order number Webshop
Descaling tabs	TCZ6004 / 00311530 www.tassimo.com www.bosch-home.com
Orange Service T DISC	00576837 www.bosch-home.com
Water filter BRITA MAXTRA+	17000917 www.bosch-home.com



Disposal

Dispose of packaging in an environmentally-friendly manner. This appliance is labelled in accordance with European Directive 2012/19/EU concerning used electrical and electronic appliances (waste electrical and electronic equipment – WEEE). The guideline determines the framework for the return and recycling of used appliances as applicable throughout the EU.

Dispose of the used filter cartridge in accordance with local regulations.

Please ask your specialist retailer about current disposal facilities.



Troubleshooting

The following table contains solutions to problems or faults which may occur during operation of the appliance and that can be easily rectified at home. If you are not satisfied with the solutions provided here, please contact our Customer Service department.

Further customer service information can also be found online:



www.bosch-home.com

www.tassimo.com

Problem	Cause	Solution
No LED is lit.	The appliance is in idle mode.	Press Start/Stop button.
The controls do not respond to touch.	Technical fault.	Unplug the mains plug. Wait for approx. 5 minutes. Re-insert the mains plug into the socket.
	The control panel is dirty.	Unplug the mains plug. Clean the display elements/controls with a soft, damp cloth. Re-insert the mains plug into the socket.
The appliance is not working and none of the display elements are lighting.	The appliance has no power supply.	Check to see whether the appliance is connected to the mains.
The brewing starts, however there is no beverage dispensed.	The water tank is not inserted correctly.	Check that the water tank is correctly inserted.
	The water tank was removed during the brewing stage or there is air in the system.	Start the cleaning process with the orange Service T DISC. Please refer here to the section First Time Use , Steps 2 – 14.
	The float in the water tank is stuck.	Clean the water tank and free the float.
The brewing will not start.	No T DISC inserted.	Check that a T DISC has been inserted.
	The appliance does not recognise the T DISC bar code. The displays/buttons for drink intensity, drink temperature and drink size are flashing.	Clean the T DISC reading window with a soft, damp cloth.
		Smooth out the foil of the T DISC with your finger so that the bar code can be read.
		Use a new T DISC.
	If the problem persists, contact the TASSIMO careline.	
The brewing unit is not closed properly.	Clean the brewing unit with a soft, damp cloth, paying particular attention to the lid area.	
The appliance was not plugged in when the T DISC was inserted.	Check that the appliance is plugged into the power supply before inserting the T DISC.	



Troubleshooting

Problem	Cause	Solution
The brewing unit cannot be closed.	The piercing unit and/or the T DISC support have not been correctly inserted.	Press the piercing unit into its holder using both thumbs and check the position of the T DISC support.
	The T DISC has not been correctly inserted.	Replace the damaged T DISC with a new one. Place the T DISC with the printed side facing downwards so that the tab is resting in the intended slot.
	The brewing unit is not closed properly.	Clean the brewing unit with a soft, damp cloth, paying particular attention to the lid area. Press the lid down until it audibly clicks into place.
The brewing unit cannot be opened.	The brewing unit is still locked.	Only open the brewing unit when the status display Y has stopped flashing and remains lit continuously.
		Unplug the mains plug. If the brewing unit stays locked, contact the TASSIMO careline.
Fill water tank  lights up.	There is not enough water in the water tank.	Fill the tank with cold, fresh water as far as the max mark. Reinsert the water tank.
Fill water tank  lights up even though there is enough water in the water tank.	The float in the water tank is stuck.	Clean the water tank and free the float.
	The water tank is not inserted correctly.	Check that the water tank is correctly inserted.
Fill water tank  and Descale calc are flashing simultaneously and it is not possible to prepare drinks.	There is a fault on the machine.	Unplug the mains plug. Please contact the TASSIMO careline.
Descale calc lights up or starts flashing.	The appliance needs to be descaled.	Descale the appliance. Please refer here to the section Descaling .
Descale calc lights up or starts flashing even though decalcified water has been used.	Even decalcified water contains low amounts of calcium carbonate.	Descale the appliance. Please refer here to the section Descaling .
The quality of the crema has deteriorated.	The beverage outlet is sticky or dirty.	Clean the beverage outlet. Please refer here to the section Cleaning .
	Build-up of limescale in the appliance.	Clean the brewing unit with the orange Service T DISC. Please refer here to the section Cleaning . Descale the appliance. Please refer here to the section Descaling .



Troubleshooting

Problem	Cause	Solution
Water is dripping from the brewing unit.	The T DISC is damaged or leaky. The T DISC has not been pierced correctly.	Do not use T DISCs that are damaged. Only use each T DISC once. Wait until the brewing stage has come to an end and the appliance has cooled down. Remove the T DISC and clean the brewing unit. Please refer here to the section Cleaning .
	The piercing unit has not been inserted correctly.	Press the piercing unit into its holder using both thumbs (until an audible click is heard).
On the surface below the cup stand there is water.	This is condensation.	Condensation may appear and is not caused by any fault with the appliance. Wipe the water away with a cloth.
The beverage quantity does not meet your requirements.	The T DISC bar code provides the recommended volume for every beverage selected. This volume can also be adapted to personal requirements.	Use the drink size buttons (☕-☕-☕) to set your individual drink volume before you begin brewing. Reduced quantity: During the brewing process, press the Start/Stop button to interrupt this stage. Increased quantity: Press and hold the Start/Stop button until the required beverage quantity has been reached.
	Build-up of limescale in the appliance could cause reduced quantity.	Descal the appliance. Please refer here to the section Descaling .
The orange Service T DISC is damaged or lost.		The following accessories can be obtained via Bosch customer service, www.bosch-home.com and www.tassimo.com (see the end of this instruction manual for contact details): Orange Service T DISC (item no. 00576837), descaling tabs (item no. TCZ6004)
Descaling tabs are required.		
Not all the settings (drink intensity ☕, drink temperature ☕, or drink size ☕) are available.	There are different setting options depending on the type of drink.	
The cartridge replacement indicator no longer works.		Press and hold the “Start” button of the indicator for at least 5 seconds. If the cartridge replacement indicator still does not work, please contact the TASSIMO careline.



Important Information

- Always store spare filter cartridges sealed in the original packaging in a cool dry place.
- The BRITA MAXTRA+ Universal water filter cartridge is designed for use only with municipally treated tap water (note: this water is constantly controlled and according to legal regulations safe to drink) or with water from private supplies that has been tested as safe to drink. If an instruction is received from the authorities that mains water must be boiled, the BRITA filtered water must also be boiled. When the instruction to boil water is no longer in force, the entire coffee machine must be cleaned and a new cartridge inserted.
- Please filter cold tap water only.
- Clean the unit (water tank and funnel) regularly.
- For certain groups of people (e.g. those with impaired immunity and for babies), it is generally recommended that tap water should be boiled; this also applies to filtered water. Irrespective of the water used, you should use utensils with stainless steel. This product of our BRITA partner meets these requirements. In particular, people who are sensitive to nickel should use appliances with elements made of stainless steel.
- For reasons of hygiene, the MAXTRA+ Universal cartridge contents are subject to special treatment with silver. A very small amount of silver may be transferred to the water. This transference would be within the World Health Organisation (WHO).
- During the filtering process, there may be a slight increase in potassium content. However, one litre of BRITA filtered water contains less potassium than e.g. an apple. If you have kidney disease and/or follow a potassium-restricted diet we recommend that you consult your doctor before using a BRITA water filter. Or call BRITACare Customer Service on +44 (0) 844 742 4800 for further information.
- Should your TASSIMO by Bosch machine not be used for a prolonged period (e.g. holiday), we recommend that you discard any water left inside the water tank and leave the cartridge inside the funnel. Before using the machine again, take out the cartridge, clean the water tank and funnel thoroughly, and flush the cartridge as described in the TASSIMO by Bosch instructions for use.
- BRITA filtered water is dedicated for human consumption. It is a perishable food and as such please consume within one day.
- Like each natural product, the consistency of the BRITA MAXTRA+ Micro Carbon Pearls is subject to natural variances. This can lead to a slight abrasion of small carbon particles into your filtered water, noticeable as black bits. These particles have no negative health effects. If ingested, they will not harm the human body. In case you observe carbon particles, BRITA recommends to flush the cartridge several times or until the black bits disappear.
- BRITA cannot accept responsibility or liability if you do not respect our recommendations for the use and exchange of the BRITA filter cartridge.



Guarantee

en Guarantee

The guarantee conditions for this appliance are as defined by our representative in the country in which it is sold. Details regarding these conditions can be obtained from the dealer from whom the appliance was purchased. The bill of sale or receipt must be produced when making any claim under the terms of this guarantee.



Customer Service

GB Great Britain

BSH Home Appliances Ltd.

Grand Union House

Old Wolverton Road

Wolverton

Milton Keynes MK12 5PT

To arrange an engineer visit, to order spare parts and accessories or for product advice please visit

www.bosch-home.co.uk

Or call

Tel.: 0344 892 8979*

* Calls are charged at the basic rate, please check with your telephone service provider for exact charges



Infoline

GB TASSIMO careline

For information, questions or locations of authorised Bosch service centres nearest you, please contact TASSIMO:

Phone: **0800 0328833**

www.tassimo.co.uk