



Installation Instructions

1. Specifications
2. Chassis Parts
3. Control Panel Functions
4. 3.5"/2.5" HDD Installation
5. Cooling System Installation
6. 140 /120mm Fans Installation
7. Addressable RGB fan installation for Motherboard

Specifications

Model	
Model Name:	APOLLO 430
Model Number	CSAZ-430B-DF1 / CSAZ-430B-DF2 / CSAZ-430W-DF1 / CSAZ-430W-DF2
Specifications	
Type	ATX Mid Tower
Color	Black/Black(interior), White/White(interior)
Side Panel Window	Left Side panel: Tempered Glass with rubber mounts
Max CPU Cooler Height	UP to 155mm
Max Video Card Length	Up to 370mm long video card
Power Supply	Not Included
Motherboard Compatibility	ATX - Micro ATX
Expansion	
External 5.25" Drive Bays	0
Internal 2.5" Drive Bays	Up to 6
Internal 3.5" Drive Bays	Up to 2
Expansion Slots	7
Top Ports	Power button, reset button, HD Audio, USB 3.0 x 2
Physical Specifications	
Case Dimension (HxWxD)	480x205x420mm/18.9x8.1x16.5 inches
Weight	7.9kg/17.4lbs
Features	
Tempered Glass Sides Window	High-quality tempered glass side window allows for clear visuals to inner components
Addressable RGB Light Effects	Addressable RGB fan in the rear and addressable RGB light stripe in the front. All Addressable RGB light devices sync with the motherboard, allowing the motherboard software to directly control the lighting.
Available Fan Ports	3x120mm or 2x140mm Fan ports in the front 2x120mm or 2x140mm Fan ports on the top 1x120mm Fan port in the rear (1x120mm Hurricane II Addressable RGB Fan included for model CSAZ-430B-DF1 / CSAZ-430W-DF1) (1x120mm Addressable RGB Fan included for model CSAZ-430B-DF2 / CSAZ-430W-DF2)
Water Cooling	Supports radiators up to 240mm in the Front Supports radiators up to 240mm on the Top
Dust Filters	Removable (magnetic) dustproof net on the top and front, iron net on bottom of chassis.
Power Supply Support	Bottom mounted ATX Power Supply



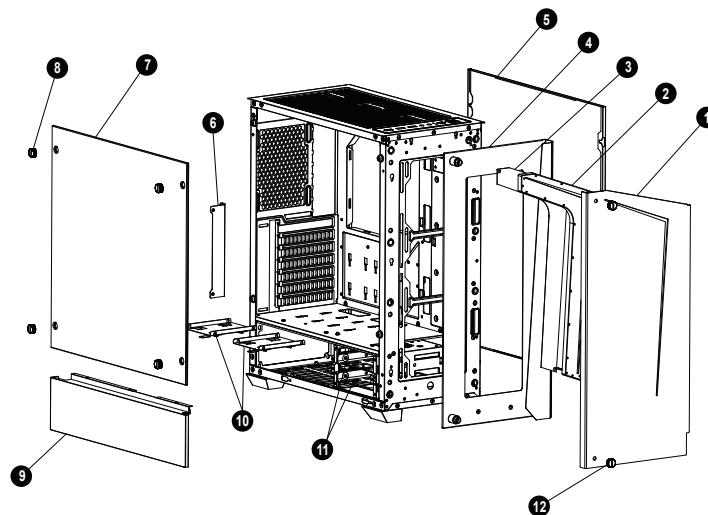



Chassis Parts

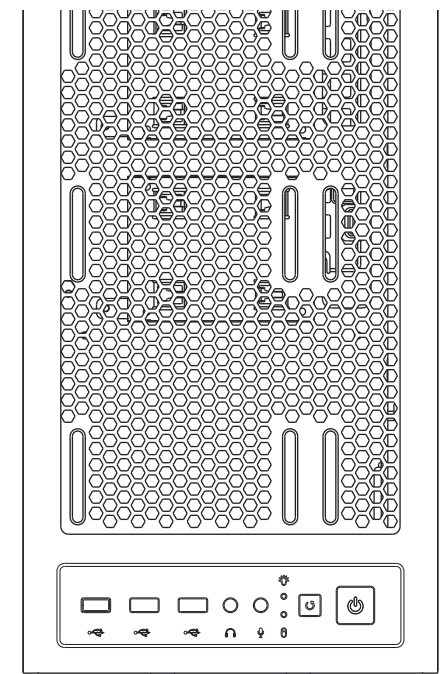

1	Iron front panel
2	LED lens
3	Lamp mylar film
4	Rear panel of the front
5	Right side metal panel
6	PCI slot cover
7	Left side tempered glass panel
8	Screws for side glass panel X4
9	Left side metal panel
10	2.5"SSD brackets X2
11	3.5"HDD brackets X2
12	Screws for the iron front panel X2

Control panel functions



	Power		Reset
	USB3.0(Blue)		Mic
	USB3.0(Blue)		Audio

