

## TUF GAMING B650-PLUS WIFI

**ASUS**

# Motherboard

E20213  
First Edition  
July 2022

**Copyright © 2022 ASUSTeK COMPUTER INC. All Rights Reserved.**

No part of this manual, including the products and software described in it, may be reproduced, transmitted, transcribed, stored in a retrieval system, or translated into any language in any form or by any means, except documentation kept by the purchaser for backup purposes, without the express written permission of ASUSTeK COMPUTER INC. ("ASUS").

Product warranty or service will not be extended if: (1) the product is repaired, modified or altered, unless such repair, modification or alteration is authorized in writing by ASUS; or (2) the serial number of the product is defaced or missing.

ASUS PROVIDES THIS MANUAL "AS IS" WITHOUT WARRANTY OF ANY KIND, EITHER EXPRESS OR IMPLIED, INCLUDING BUT NOT LIMITED TO THE IMPLIED WARRANTIES OR CONDITIONS OF MERCHANTABILITY OR FITNESS FOR A PARTICULAR PURPOSE. IN NO EVENT SHALL ASUS, ITS DIRECTORS, OFFICERS, EMPLOYEES OR AGENTS BE LIABLE FOR ANY INDIRECT, SPECIAL, INCIDENTAL, OR CONSEQUENTIAL DAMAGES (INCLUDING DAMAGES FOR LOSS OF PROFITS, LOSS OF BUSINESS, LOSS OF USE OR DATA, INTERRUPTION OF BUSINESS AND THE LIKE), EVEN IF ASUS HAS BEEN ADVISED OF THE POSSIBILITY OF SUCH DAMAGES ARISING FROM ANY DEFECT OR ERROR IN THIS MANUAL OR PRODUCT.

SPECIFICATIONS AND INFORMATION CONTAINED IN THIS MANUAL ARE FURNISHED FOR INFORMATIONAL USE ONLY, AND ARE SUBJECT TO CHANGE AT ANY TIME WITHOUT NOTICE, AND SHOULD NOT BE CONSTRUED AS A COMMITMENT BY ASUS. ASUS ASSUMES NO RESPONSIBILITY OR LIABILITY FOR ANY ERRORS OR INACCURACIES THAT MAY APPEAR IN THIS MANUAL, INCLUDING THE PRODUCTS AND SOFTWARE DESCRIBED IN IT.

Products and corporate names appearing in this manual may or may not be registered trademarks or copyrights of their respective companies, and are used only for identification or explanation and to the owners' benefit, without intent to infringe.

# Contents

Safety information.....	iv
About this guide.....	v
Package contents.....	vi
TUF GAMING B650-PLUS WIFI specifications summary.....	vi

## Chapter 1 Product Introduction

1.1 Before you proceed.....	1-1
1.2 Motherboard overview .....	1-1
1.3 Central Processing Unit (CPU).....	1-8
1.4 System memory.....	1-10
1.5 M.2 installation.....	1-12
1.6 Wi-Fi moving antenna installation .....	1-14

## Chapter 2 BIOS and RAID Support

2.1 Knowing BIOS.....	2-1
2.2 BIOS Setup program .....	2-2
2.3 ASUS EZ Flash 3.....	2-3
2.4 ASUS CrashFree BIOS 3.....	2-4
2.5 RAID configurations.....	2-5

## Appendix

Notices .....	A-1
ASUS contact information.....	A-11
Service and Support .....	A-11

# Safety information

## Electrical safety



- To prevent electrical shock hazard, disconnect the power cable from the electrical outlet before relocating the system.
- When adding or removing devices to or from the system, ensure that the power cables for the devices are unplugged before the signal cables are connected. If possible, disconnect all power cables from the existing system before you add a device.
- Before connecting or removing signal cables from the motherboard, ensure that all power cables are unplugged.
- Seek professional assistance before using an adapter or extension cord. These devices could interrupt the grounding circuit.
- Ensure that your power supply is set to the correct voltage in your area. If you are not sure about the voltage of the electrical outlet you are using, contact your local power company.
- If the power supply is broken, do not try to fix it by yourself. Contact a qualified service technician or your retailer.

## Operation safety

- Before installing the motherboard and adding devices on it, carefully read all the manuals that came with the package.
- Before using the product, ensure all cables are correctly connected and the power cables are not damaged. If you detect any damage, contact your dealer immediately.
- To avoid short circuits, keep paper clips, screws, and staples away from connectors, slots, sockets and circuitry.
- Avoid dust, humidity, and temperature extremes. Do not place the product in any area where it may become wet.
- Place the product on a stable surface.
- If you encounter technical problems with the product, contact a qualified service technician or your retailer.
- Your motherboard should only be used in environments with ambient temperatures between 0°C and 40°C.

## Button/Coin Batteries Safety Information



 <b>WARNING</b>	
<b>KEEP OUT OF REACH OF CHILDREN</b> Swallowing can lead to chemical burns, perforation of soft tissue, and death. Severe burns can occur within 2 hours of ingestion. Seek medical attention immediately.	

## About this guide

This user guide contains the information you need when installing and configuring the motherboard.

## How this guide is organized

This guide contains the following parts:

- **Chapter 1: Product Introduction**

This chapter describes the features of the motherboard and the new technology it supports. It includes descriptions of the switches, jumpers, and connectors on the motherboard.

- **Chapter 2: BIOS and RAID Support**

This chapter tells how to boot into the BIOS, upgrade BIOS using the EZ Flash Utility and support on RAID.

## Where to find more information

Refer to the following sources for additional information and for product and software updates.

1. **ASUS website**

The ASUS website ([www.asus.com](http://www.asus.com)) provides updated information on ASUS hardware and software products.

2. **Optional documentation**

Your product package may include optional documentation, such as warranty flyers, that may have been added by your dealer. These documents are not part of the standard package.

## Conventions used in this guide

To ensure that you perform certain tasks properly, take note of the following symbols used throughout this user guide.



**CAUTION:** Information to prevent damage to the components and injuries to yourself when trying to complete a task.



**IMPORTANT:** Instructions that you **MUST** follow to complete a task.



**NOTE:** Tips and additional information to help you complete a task.

## Package contents

Check your motherboard package for the following items.

<b>Motherboard</b>	1 x TUF GAMING B650-PLUS WIFI motherboard
<b>Cables</b>	2 x SATA 6Gb/s cables
<b>Miscellaneous</b>	1 x ASUS Wi-Fi moving antennas
	2 x Rubber Package(s) for M.2
	1 x Screw package for M.2 SSD
<b>Documentation</b>	1 x TUF Certification card
	1 x User guide



If any of the above items is damaged or missing, contact your retailer.

## TUF GAMING B650-PLUS WIFI specifications summary

<b>CPU</b>	AMD Socket AM5 for AMD Ryzen™ 7000 Series Desktop Processors* * Refer to <a href="http://www.asus.com">www.asus.com</a> for CPU support list.
<b>Chipset</b>	AMD B650 Chipset
<b>Memory</b>	4 x DIMM, Max. 128GB, DDR5 6400+(OC)/ 6200(OC)/ 6000(OC)/ 5800(OC)/ 5600/ 5400/ 5200/ 5000/ 4800 ECC & Non-ECC, Un-buffered Memory* Supports AMD EXTended Profiles for Overclocking (EXPO™) OptiMem II * Supported memory types, data rate(Speed), and number of DRAM module vary depending on the CPU and memory configuration, for more information refer to <a href="http://www.asus.com">www.asus.com</a> for memory support list. ** Non-ECC, Un-buffered DDR5 Memory supports On-Die ECC function.
<b>Graphics</b>	1 x DisplayPort* 1 x HDMI® port** * Supports max. 8K@60Hz as specified in DisplayPort 1.4. ** Supports 4K@60Hz as specified in HDMI 2.1. ***VGA resolution support depends on processors' or graphic cards' resolution.
<b>Expansion Slots</b>	AMD Ryzen™ 7000 Series Desktop Processors* 1 x PCIe 4.0/3.0 x16 slot AMD B650 Chipset 1 x PCIe 4.0/3.0 x16 slot (supports x4 mode) 2 x PCIe 4.0/3.0 x1 slots * Please check the PCIe bifurcation table at <a href="https://www.asus.com/support/FAQ/1037507/">https://www.asus.com/support/FAQ/1037507/</a> .
<b>Storage</b>	Total supports 3 x M.2 slots and 4 x SATA 6Gb/s ports* AMD Ryzen™ 7000 Series Desktop Processors M.2_1 slot (Key M), type 2242/2260/2280 (supports PCIe 5.0 x4 mode) M.2_2 slot (Key M), type 2242/2260/2280/22110 (supports PCIe 4.0 x4 mode)

(continued on the next page)

## TUF GAMING B650-PLUS WIFI specifications summary

Storage	<p><b>AMD B650 Chipset</b>  M.2_3 slot (Key M), type 2242/2260/2280 (supports PCIe 4.0 x4 mode)**  4 x SATA 6Gb/s ports</p> <p>* <b>AMD RAIDXpert2 Technology</b> supports both PCIe RAID 0/1/10 and SATA RAID 0/1/10.</p> <p>** <b>M.2_3 shares bandwidth with PCIeX16_2. PCIeX16_2 will be suspended once M.2_3 is populated.</b></p>
Ethernet	<p>1 x Realtek 2.5Gb Ethernet  TUF LANGuard</p>
Wireless & Bluetooth	<p>Wi-Fi 6  2x2 Wi-Fi 6 (802.11 a/b/g/n/ac/ax)  Supports 2.4/5GHz frequency band  Bluetooth v5.2</p>
USB	<p><b>Rear USB (Total 8 ports)</b>  1 x USB 3.2 Gen 2x2 port (1 x USB Type-C®)  3 x USB 3.2 Gen 2 ports (2 x Type-A + 1 x USB Type-C®)  4 x USB 2.0 ports (4 x Type-A)</p> <p><b>Front USB (Total 7 ports)</b>  1 x USB 3.2 Gen 1 connector (supports USB Type-C®)  1 x USB 3.2 Gen 1 header supports additional 2 USB 3.2 Gen 1 ports  2 x USB 2.0 headers support additional 4 USB 2.0 ports</p>
Audio	<p><b>Realtek ALC S1200A 7.1 Surround Sound High Definition Audio CODEC*</b></p> <ul style="list-style-type: none"> <li>- Supports: Jack detection, Multi-streaming, Front Panel Jack-retasking</li> <li>- Supports up to 24-Bit/192kHz playback</li> </ul> <p><b>Audio Features</b></p> <ul style="list-style-type: none"> <li>- Audio Shielding</li> <li>- Power pre-regulator reduces power input noise to ensure consistent performance</li> <li>- Premium audio capacitors</li> <li>- Dedicated audio PCB layers</li> <li>- Audio cover</li> <li>- Unique de-pop circuit</li> </ul> <p>* <b>Due to limitations in HDA bandwidth, 32-Bit/192 kHz is not supported for 7.1 Surround Sound audio.</b></p> <p>** <b>A chassis with an HD audio module in the front panel is required to support 7.1 Surround Sound audio output.</b></p>
Back Panel I/O Ports	<p>1 x USB 3.2 Gen 2x2 port (1 x USB Type-C®)  3 x USB 3.2 Gen 2 ports (2 x Type-A + 1 x USB Type-C®)  4 x USB 2.0 ports (2 x Type-A)  1 x DisplayPort  1 x HDMI® port  1 x Wi-Fi Module  1 x Realtek 2.5Gb Ethernet port  5 x Audio jacks  1 x BIOS FlashBack™ button</p>

(continued on the next page)

## TUF GAMING B650-PLUS WIFI specifications summary

<b>Internal I/O Connectors</b>	<p><b>Fan and cooling related</b></p> <ul style="list-style-type: none"><li>1 x 4-pin CPU Fan header</li><li>1 x 4-pin CPU OPT Fan header</li><li>1 x 4-pin AIO Pump header</li><li>4 x 4-pin Chassis Fan headers</li></ul> <p><b>Power related</b></p> <ul style="list-style-type: none"><li>1 x 24-pin Main Power connector</li><li>1 x 8-pin +12V Power connector</li><li>1 x 4-pin +12V Power connector</li></ul> <p><b>Storage related</b></p> <ul style="list-style-type: none"><li>3 x M.2 slots (Key M)</li><li>4 x SATA 6Gb/s ports</li></ul> <p><b>USB</b></p> <ul style="list-style-type: none"><li>1 x USB 3.2 Gen 1 connector (supports USB Type-C®)</li><li>1 x USB 3.2 Gen 1 header supports additional 2 USB 3.2 Gen 1 ports</li><li>2 x USB 2.0 headers support additional 4 USB 2.0 ports</li></ul> <p><b>Miscellaneous</b></p> <ul style="list-style-type: none"><li>3 x Addressable Gen 2 headers</li><li>1 x Aura RGB header</li><li>1 x Clear CMOS header</li><li>1 x COM Port header</li><li>1 x Front Panel Audio header (AAFP)</li><li>1 x 20-3 pin System Panel header with Chassis intrude function</li><li>1 x Thunderbolt™ header</li></ul>
<b>Special Features</b>	<p><b>ASUS TUF PROTECTION</b></p> <ul style="list-style-type: none"><li>- DIGI+ VRM (- Digital power design with DrMOS)</li><li>- Enhanced DRAM Overcurrent Protection</li><li>- ESD Guards</li><li>- TUF LANGuard</li><li>- Overvoltage Protection</li><li>- SafeSlot+</li><li>- Stainless-Steel Back I/O</li></ul> <p><b>ASUS Q-Design</b></p> <ul style="list-style-type: none"><li>- M.2 Q-Latch</li><li>- Q-DIMM</li><li>- Q-LED (CPU [red], DRAM [yellow], VGA [white], Boot Device [yellow green])</li><li>- Q-Slot</li></ul> <p><b>ASUS Thermal Solution</b></p> <ul style="list-style-type: none"><li>- M.2 heatsink</li><li>- VRM heatsink design</li></ul> <p><b>ASUS EZ DIY</b></p> <ul style="list-style-type: none"><li>- BIOS FlashBack™ button</li><li>- BIOS FlashBack™ LED</li><li>- Pre-mounted I/O shield</li><li>- SafeDIMM</li></ul>

(continued on the next page)



## TUF GAMING B650-PLUS WIFI specifications summary

<b>Special Features</b>	<b>Aura Sync</b> - Aura RGB header - Addressable Gen 2 headers
<b>Software Features</b>	<b>ASUS Exclusive Software</b> Armoury Crate - Aura Creator - Aura Sync - Fan Xpert 4 - Power Saving - Two-Way AI Noise Cancelation AI Suite 3 - TurboV EVO - DIGI+ VRM - PC Cleaner TUF GAMING CPU-Z DTS Audio Processing MyASUS Norton Anti-virus software (Free Trial version) WinRAR <b>UEFI BIOS</b> ASUS EZ DIY - ASUS CrashFree BIOS 3 - ASUS EZ Flash 3 - ASUS UEFI BIOS EZ Mode
<b>BIOS</b>	256 Mb Flash ROM, UEFI AMI BIOS
<b>Manageability</b>	WOL by PME, PXE
<b>Operating System</b>	Windows® 11 Windows® 10 64-bit
<b>Form Factor</b>	ATX Form Factor 12 inch x 9.6 inch (30.5 cm x 24.4 cm)



- Specifications are subject to change without notice. Please refer to the ASUS website for the latest specifications.
- MyASUS offers a variety of support features such as helping to troubleshoot issues, optimizing product performance, integrating ASUS software, and recovery drive creation. Please scan the QR Code for installation guide and FAQ.





# Product Introduction

1

## 1.1 Before you proceed

Take note of the following precautions before you install motherboard components or change any motherboard settings.



- Unplug the power cord from the wall socket before touching any component.
- Before handling components, use a grounded wrist strap or touch a safely grounded object or a metal object, such as the power supply case, to avoid damaging them due to static electricity.
- Hold components by the edges to avoid touching the ICs on them.
- Whenever you uninstall any component, place it on a grounded antistatic pad or in the bag that came with the component.
- Before you install or remove any component, ensure that the ATX power supply is switched off or the power cord is detached from the power supply. Failure to do so may cause severe damage to the motherboard, peripherals, or components.

## 1.2 Motherboard overview

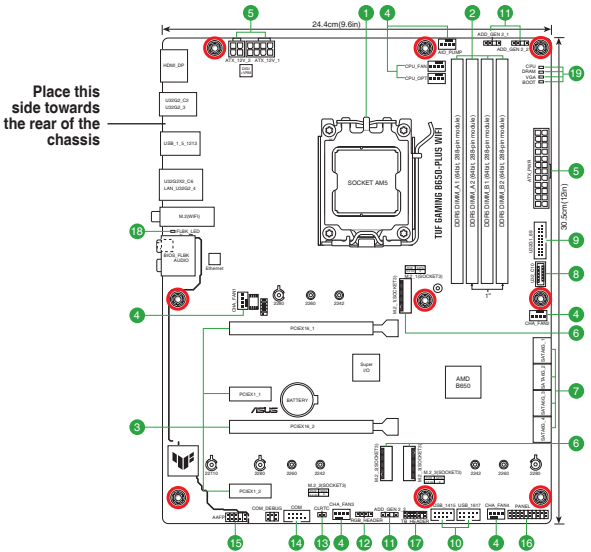

Unplug the power cord before installing or removing the motherboard. Failure to do so can cause you physical injury and damage motherboard components.



The pin definitions in this chapter are for reference only. The pin names depend on the location of the header/jumper/connector.

## 1.2.1 Layout contents

### 1. CPU socket

The motherboard comes with a Socket AM5 designed for AMD Ryzen™ 7000 Series Desktop Processors.



For more details, refer to **Central Processing Unit (CPU)**.

### 2. DDR5 DIMM slots

The motherboard comes with Dual Inline Memory Modules (DIMM) slots designed for DDR5 (Double Data Rate 5) memory modules.



For more details, refer to **System memory**.

### 3. Expansion slots

This motherboard supports two PCIe x16 graphics cards and two PCIe x1 network cards, SCSI cards and other cards that comply with the PCI Express specification.



- Additional PCIe bifurcation and M.2 settings for RAID function are also supported when a Hyper M.2 x16 series card is installed.
- For full details on the PCIe bifurcation, you may visit the support site at <https://www.asus.com/support/FAQ/1037507/>.
- The Hyper M.2 x16 series card is sold separately.
- Adjust the PCIe bifurcation under BIOS settings.

### 4. Fan headers

The Fan headers allow you to connect fans to cool the system.

Header	Max. Current	Max. Power	Default Speed	Shared Control
CPU_FAN	1A	12W	Q-Fan Controlled	A
CPU_OPT	1A	12W	Q-Fan Controlled	A
CHA_FAN1	1A	12W	Q-Fan Controlled	-
CHA_FAN2	1A	12W	Q-Fan Controlled	-
CHA_FAN3	1A	12W	Q-Fan Controlled	-
CHA_FAN4	1A	12W	Q-Fan Controlled	-
AIO_PUMP	1A	12W	Full-Speed	-

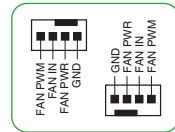

### 5. Power connectors

These Power connectors allow you to connect your motherboard to a power supply. The power supply plugs are designed to fit in only one orientation. Find the proper orientation and push down firmly until the power supply plugs are fully inserted.



Ensure to connect the 8-pin power plug.



- We recommend that you use a PSU with a higher power output when configuring a system with more power-consuming devices. The system may become unstable or may not boot up if the power is inadequate.
- If you want to use two high-end PCI Express x16 cards, use a PSU with 1000W power or above to ensure the system stability.

## 6. M.2 slots (Key M)

The M.2 slots allow you to install M.2 devices such as M.2 SSD modules.



- **AMD Ryzen™ 7000 Series Desktop Processors:**
  - M.2\_1 slot supports PCIe 5.0 x4 mode M Key design and type 2242/2260/2280 storage devices.
  - M.2\_2 slot supports PCIe 4.0 x4 mode M key design and type 2242/2260/2280/22110 storage devices.
- **AMD B650 Chipset:**
  - M.2\_3 slot supports PCIe 4.0 x4 mode M key design and type 2242/2260/2280 storage devices.

## 7. SATA 6Gb/s ports

The SATA 6Gb/s ports allow you to connect SATA devices such as optical disc drives and hard disk drives via SATA cables.

## 8. USB 3.2 Gen 1 Type-C® connector

The USB 3.2 Gen 1 connector (USB Type-C®) allows you to connect a USB 3.2 Gen 1 module for an additional USB 3.2 Gen 1 Type-C® port. The connector provides a data transfer speed of up to 5 Gb/s.

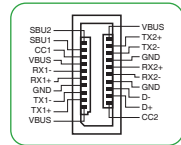

The USB 3.2 Gen 1 Type-C® module is purchased separately.

## 9. USB 3.2 Gen 1 header

The USB 3.2 Gen 1 header allows you to connect a USB 3.2 Gen 1 module for additional USB 3.2 Gen 1 ports. The USB 3.2 Gen 1 header provides data transfer speeds of up to 5 Gb/s.



The USB 3.2 Gen 1 module is purchased separately.

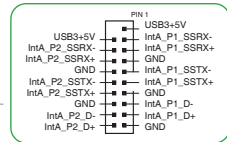

## 10. USB 2.0 headers

The USB 2.0 headers allow you to connect a USB module for additional USB 2.0 ports. The USB 2.0 headers provide data transfer speeds of up to 480 Mb/s.



DO NOT connect a 1394 cable to the USB connectors. Doing so will damage the motherboard!



The USB 2.0 module is purchased separately.

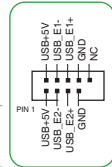

## 11. Addressable Gen 2 headers

The Addressable Gen 2 headers allow you to connect individually addressable RGB WS2812B LED strips or WS2812B based LED strips.



The Addressable Gen 2 headers support WS2812B addressable RGB LED strips (5V/Data/Ground), with a maximum power rating of 3A (5V), and the addressable headers on this board can handle a combined maximum of 500 LEDs.

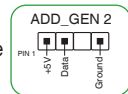



---

Before you install or remove any component, ensure that the power supply is switched off or the power cord is detached from the power supply. Failure to do so may cause severe damage to the motherboard, peripherals, or components.

---



- Actual lighting and color will vary with LED strip.
  - If your LED strip does not light up, check if the addressable RGB LED strip is connected in the correct orientation, and the 5V connector is aligned with the 5V header on the motherboard.
  - The addressable RGB LED strip will only light up when the system is powered on.
  - The addressable RGB LED strip is purchased separately.
- 

## 12. Aura RGB header

The RGB header allows you to connect RGB LED strips.

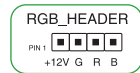

---

The RGB headers support 5050 RGB multi-color LED strips (12V/G/R/B), with a maximum power rating of 3A (12V), and no longer than 3m.

---



---

Before you install or remove any component, ensure that the ATX power supply is switched off or the power cord is detached from the power supply. Failure to do so may cause severe damage to the motherboard, peripherals, or components.

---



- Actual lighting and color will vary with LED strip.
  - If your LED strip does not light up, check if the RGB LED extension cable and the RGB LED strip are connected in the correct orientation, and the 12V connector is aligned with the 12V header on the motherboard.
  - The LED strip will only light up when the system is powered on.
  - The LED strip is purchased separately.
- 

## 13. Clear CMOS header

The Clear CMOS header allows you to clear the Real Time Clock (RTC) RAM in the CMOS, which contains the date, time, system passwords, and system setup parameters.

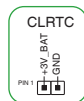

**To erase the RTC RAM:**

1. Turn OFF the computer and unplug the power cord.
  2. Use a metal object such as a screwdriver to short the two pins.
  3. Plug the power cord and turn ON the computer.
  4. Hold down the <Del> key during the boot process and enter BIOS Setup to re-enter data.
- 



---

If the steps above do not help, remove the onboard button cell battery and short the two pins again to clear the CMOS RTC RAM data. After clearing the CMOS, reinstall the battery.

---

## 14. COM Port header

The COM (Serial) Port header allows you to connect a COM port module. Connect the COM port module cable to this header, then install the module to a slot opening on the system chassis.

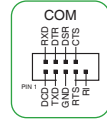

## 15. Front panel audio header

This header is for a chassis-mounted front panel audio I/O module that supports HD Audio. Connect one end of the front panel audio I/O module cable to this header.



We recommend that you connect a high-definition front panel audio module to this header to avail of the motherboard's high-definition audio capability.

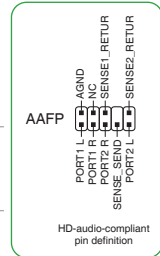

## 16. System Panel header

This header supports several chassis-mounted functions.

- **System Power LED header (PLED)**

The 2-pin and/or 3-1 pin headers allow you to connect the System Power LED. The System Power LED lights up when the system is connected to a power source, or when you turn on the system power, and blinks when the system is in sleep mode.

- **Storage Device Activity LED header (HDD\_LED)**

The 2-pin header allows you to connect the Storage Device Activity LED. The Storage Device Activity LED lights up or blinks when data is read from or written to the storage device or storage device add-on card.

- **System Warning Speaker header (SPEAKER)**

The 4-pin header allows you to connect the chassis-mounted system warning speaker. The speaker allows you to hear system beeps and warnings.

- **Power Button/Soft-off Button header (PWRSW)**

The 3-1 pin header allows you to connect the system power button. Press the power button to power up the system, or put the system into sleep or soft-off mode (depending on the operating system settings).

- **Reset button header (RESET)**

The 2-pin header allows you to connect the chassis-mounted reset button. Press the reset button to reboot the system.

- **Chassis intrusion header (CHASSIS)**

The 2-pin header allows you to connect the chassis-mounted intrusion detection sensor or switch. The chassis intrusion sensor or switch sends a high-level signal to the header when a chassis component

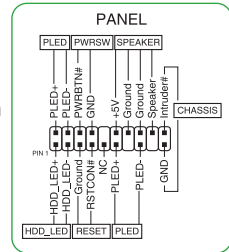

## 17. Thunderbolt™ header

The Thunderbolt™ header allows you to connect an add-on Thunderbolt™ I/O card that supports Intel®'s Thunderbolt™ Technology, allowing you to connect Thunderbolt™-enabled devices to form a daisy chain-configuration.



- The add-on Thunderbolt™ I/O card and Thunderbolt™ cables are purchased separately.
- Please visit the official website of your purchased Thunderbolt card for more details on compatibility.



The Thunderbolt™ card can only be used when installed to the PCIEX16\_2 slot. Ensure to install your Thunderbolt™ card to the PCIEX16\_2 slot.

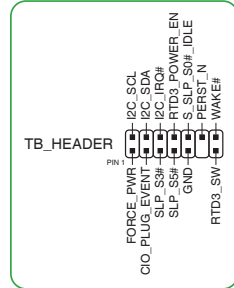

## 18. BIOS FlashBack™ LED

The BIOS FlashBack™ LED lights up or blinks to indicate the status of the BIOS FlashBack™.



Scan the QR code for more information on BIOS FlashBack™ function.



## 19. Q-LEDs

The Q-LEDs check key components (CPU, DRAM, VGA, and booting devices) during the motherboard booting process. If an error is found, the critical component's LED stays lit up until the problem is solved.



The Q-LEDs provide the most probable cause of an error code as a starting point for troubleshooting. The actual cause may vary from case to case.



## 1.2.2 Rear panel connectors

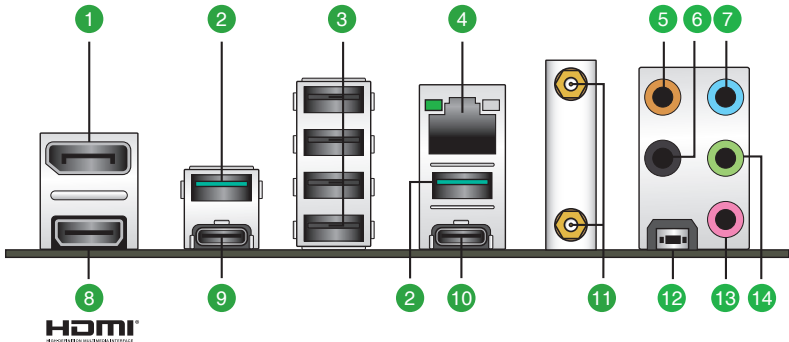

1. **DisplayPort.** This port is for a DisplayPort-compatible device.
2. **USB 3.2 Gen 2 (up to 10Gbps) ports (teal blue, Type A).** These Universal Serial Bus 3.2 (USB 3.2) ports are for USB 3.2 Gen 2 devices.
3. **USB 2.0 ports.** These Universal Serial Bus (USB) ports are for USB 2.0 devices.
4. **2.5Gb Ethernet port.** This port allows 2.5Gbps Ethernet connection to a Local Area Network (LAN) through a network hub. Refer to the table one the next page for the Ethernet port LED indications.

### Realtek 2.5Gb Ethernet port LED indications

Activity Link LED		Speed LED		ACT/LINK LED	SPEED LED
Status	Description	Status	Description	 LAN port	
OFF	No link	OFF	No link		
GREEN	Linked	OFF	100 Mbps / 10 Mbps connection		
BLINKING	Data activity	GREEN	2.5 Gbps connection		
		ORANGE	1 Gbps connection		

5. **Center / Subwoofer port (orange).** This port connects the center/subwoofer speakers.
6. **Rear Speaker Out port (black).** This port connects the rear speakers in a 4 channel, 5.1 channel, or 7.1 channel audio configuration.
7. **Line In port (light blue).** This port connects the tape, CD, DVD player, or other audio sources.
8. **HDMI® port.** This port is for a High-Definition Multimedia Interface (HDMI®) connector, and is HDCP compliant allowing playback of HD DVD, Blu-ray, and other protected content.
9. **USB 3.2 Gen 2 port (USB Type-C®).** This Universal Serial Bus 3.2 (USB 3.2) port is for a USB 3.2 Gen 2 Type-C® device.

10. **USB 3.2 Gen 2x2 (up to 20Gbps) port (USB Type-C®).** This Universal Serial Bus 3.2 (USB 3.2) port is for a USB 3.2 Gen 2x2 Type-C® device.

11. **Wi-Fi 6 ports.** These ports connect to Wi-Fi antennas.



Refer to the **1.6 Wi-Fi moving antenna installation** section for details.

12. **BIOS FlashBack™ button.** Press the BIOS FlashBack™ button for three seconds until the FlashBack™ LED blinks three times, indicating that the BIOS FlashBack™ function is enabled.

13. **Microphone port (pink).** This port connects a microphone.

14. **Line Out port (lime).** This port connects a headphone or a speaker. In 4-channel, 5.1-channel, and 7.1-channel configurations, the function of this port becomes Front Speaker Out.



Refer to the audio configuration table below for the function of the audio ports in 2, 4, 5.1, or 7.1-channel configuration.

### Audio 2, 4, 5.1 or 7.1-channel configuration

Port	2-channel	4-channel	5.1-channel	7.1-channel
Light Blue (Rear panel)	—	—	—	Side Speaker Out
Lime (Rear panel)	Front Speaker Out	Front Speaker Out	Front Speaker Out	Front Speaker Out
Pink (Rear panel)	—	—	—	—
Black (Rear panel)	—	Rear Speaker Out	Rear Speaker Out	Rear Speaker Out
Orange (Rear panel)	—	—	Center/Subwoofer	Center/Subwoofer

## 1.3 Central Processing Unit (CPU)

The motherboard comes with an AM5 socket designed for AMD Ryzen™ 7000 Series Desktop Processors.



Unplug all power cables before installing the CPU.

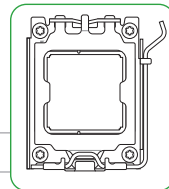

- The AM5 socket has a different pinout design. Ensure that you use a CPU designed for the AM5 socket. The CPU fits in only one correct orientation. **DO NOT** force the CPU into the socket to prevent bending the connectors on the socket and damaging the CPU.
- ASUS will not cover damages resulting from incorrect CPU installation/removal, incorrect CPU orientation/placement, or other damages resulting from negligence by the user.

# Installing the CPU

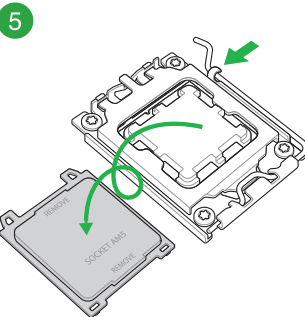
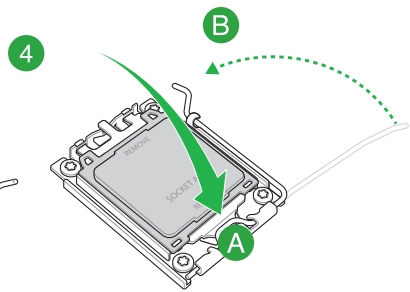
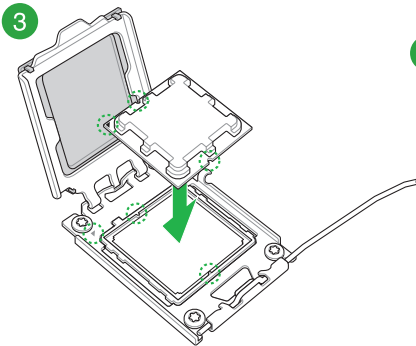
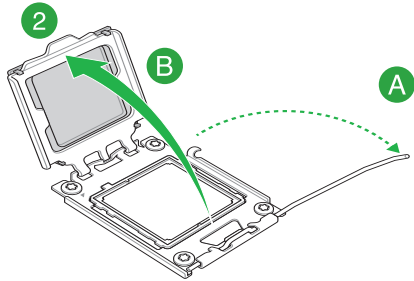
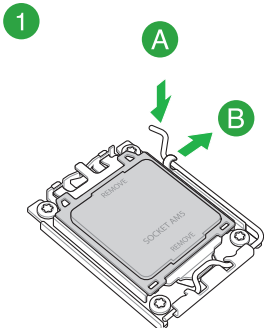
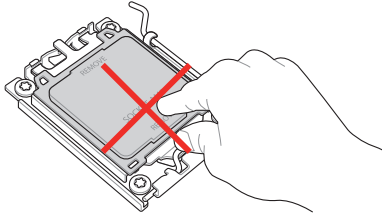

# 1.4 System memory

The motherboard comes with Dual Inline Memory Modules (DIMM) slots designed for DDR5 (Double Data Rate 5) memory modules.



A DDR5 memory module is notched differently from a DDR, DDR2, DDR3 or DDR4 module. DO NOT install a DDR, DDR2, DDR3 or DDR4 memory module to the DDR5 slot.

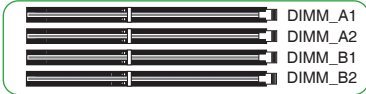

Channel	Sockets
Channel A	DIMM_A1 & DIMM_A2
Channel B	DIMM_B1 & DIMM_B2



- You may install varying memory sizes in Channel A and Channel B. The system maps the total size of the lower-sized channel for the dual-channel configuration. Any excess memory from the higher-sized channel is then mapped for single-channel operation.
- A DDR5 memory module is notched differently from a DDR, DDR2, DDR3 or DDR4 module. DO NOT install a DDR, DDR2, DDR3 or DDR4 memory module to the DDR5 slot.



- The default memory operation frequency is dependent on its Serial Presence Detect (SPD), which is the standard way of accessing information from a memory module. Under the default state, some memory modules for overclocking may operate at a lower frequency than the vendor-marked value.
- For system stability, use a more efficient memory cooling system to support a full memory load.
- Always install DIMMs with the same CAS latency. For optimal compatibility, we recommend that you install memory modules of the same version or date code (D/C) from the same vendor. Check with the retailer to get the correct memory modules.
- Refer to [www.asus.com](http://www.asus.com) for the Memory QVL (Qualified Vendors Lists), and memory frequency support depends on the CPU types.

## Recommended memory configurations

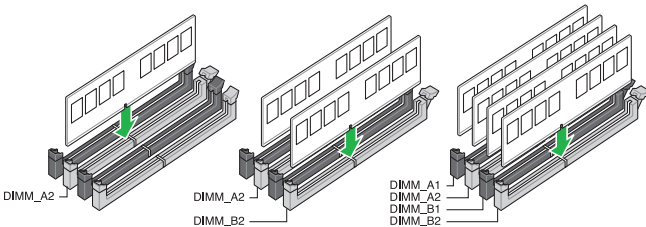

## Installing a DIMM

1

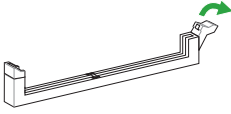

2

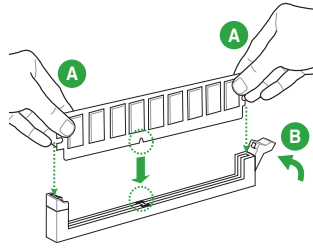

## To remove a DIMM

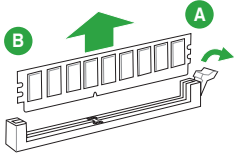

# 1.5 M.2 installation



- Use a Phillips screwdriver when removing or installing the screws or screw stands mentioned in this section.
- The M.2 is purchased separately.

1. Completely loosen the screws on the heatsink(s).
2. Remove the heatsink(s).

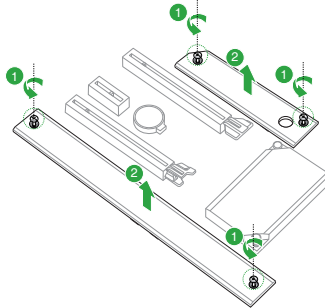

3. Install your M.2 to your M.2 slot(s).

For 2280, 22110 length

- A. (optional) Remove the pre-installed removable M.2 Q-Latch screw at the 2280 length screw hole.



Follow step A only when you wish to install an 22110 length M.2 to M.2\_2

- B. (optional) Install the bundled rubber for M.2 if you are installing a single sided M.2 storage device. DO NOT install the bundled rubber for M.2 when installing a double-sided M.2 storage device. The rubber installed by default is compatible with double sided M.2 storage devices.
- C. Rotate and adjust the M.2 Q-latch so that the handle points away from the M.2 slot.
- D. Install your M.2 to the M.2 slot.
- E. Rotate the M.2 Q-Latch clockwise to secure the M.2 in place.

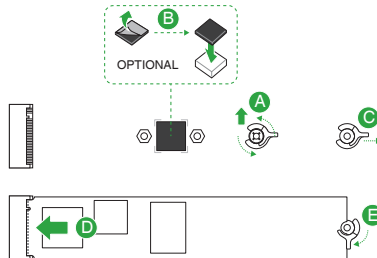

For 2242, 2260 length

- A. Install the bundled screw stand to the M.2 length screw hole you wish to install your M.2 to.
- B. Install your M.2 to the M.2 slot.
- C. Secure your M.2 using the bundled screw stand's screw.

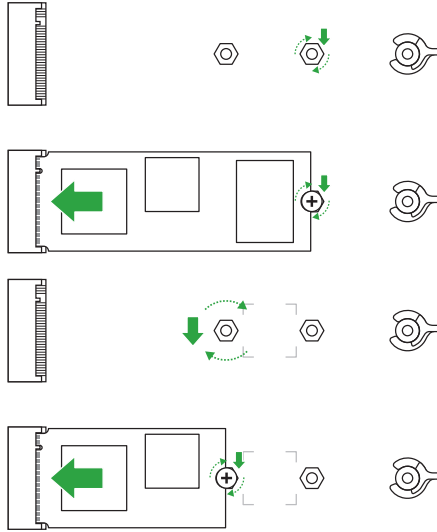

- This M.2 rubber pad is optional for when installing a single sided M.2 storage device. Ensure to install the bundled M.2 rubber pad before installing your single sided M.2 storage device.
- DO NOT install the bundled M.2 rubber pads when installing a double-sided M.2 storage device. The rubber pad installed by default is compatible with double sided M.2 storage devices.

4. Remove the plastic film from the thermal pads on the bottom of the heatsinks.



If the thermal pad on the M.2 heatsink becomes damaged and needs to be replaced, we recommend replacing it with a thermal pad with a thickness of 1.25mm.

5. Replace the heatsink(s).
6. Secure the heatsink(s) using the screws removed previously.

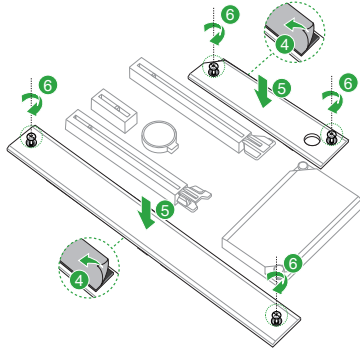

## 1.6 Wi-Fi moving antenna installation

### Installing the ASUS Wi-Fi moving antenna

Connect the bundled ASUS Wi-Fi moving antenna connector to the Wi-Fi ports at the back of the chassis.

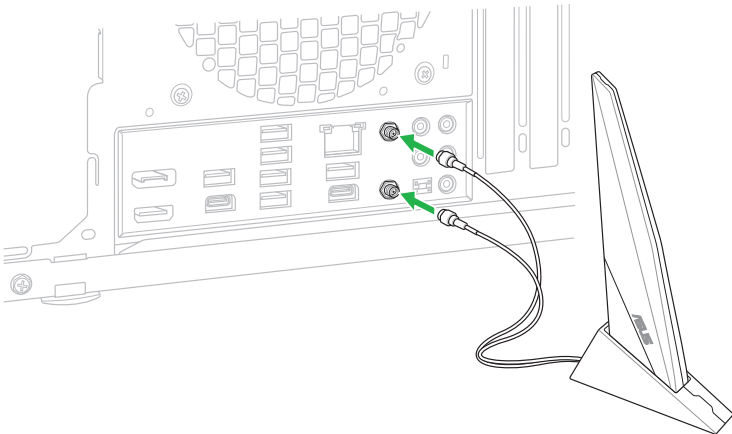

- Ensure that the ASUS Wi-Fi moving antenna is securely installed to the Wi-Fi ports.
- Ensure that the antenna is at least 20 cm away from all persons.



The illustration above is for reference only. The I/O port layout may vary with models, but the Wi-Fi antenna installation procedure is the same for all models.



# BIOS and RAID Support

# 2



For more details on BIOS and RAID configurations, please refer to [www.asus.com/support](https://www.asus.com/support).

## 2.1 Knowing BIOS



The new ASUS UEFI BIOS is a Unified Extensible Interface that complies with UEFI architecture, offering a user-friendly interface that goes beyond the traditional keyboard-only BIOS controls to enable a more flexible and convenient mouse input. You can easily navigate the new UEFI BIOS with the same smoothness as your operating system. The term "BIOS" in this user manual refers to "UEFI BIOS" unless otherwise specified.

BIOS (Basic Input and Output System) stores system hardware settings such as storage device configuration, overclocking settings, advanced power management, and boot device configuration that are needed for system startup in the motherboard CMOS. In normal circumstances, the default BIOS settings apply to most conditions to ensure optimal performance. **DO NOT change the default BIOS settings** except in the following circumstances:

- An error message appears on the screen during the system bootup and requests you to run the BIOS Setup.
- You have installed a new system component that requires further BIOS settings or update.



Inappropriate BIOS settings may result in instability or boot failure. **We strongly recommend that you change the BIOS settings only with the help of a trained service personnel.**



BIOS settings and options may vary due to different BIOS release versions. Please refer to the latest BIOS version for settings and options.



For more information on BIOS configurations, please refer to <https://www.asus.com/support>, or download the BIOS manual by scanning the QR code.



## 2.2 BIOS Setup program

Use the BIOS Setup to update the BIOS or configure its parameters. The BIOS screens include navigation keys and brief onscreen help to guide you in using the BIOS Setup program.

### Entering BIOS at startup

To enter BIOS Setup at startup, press <Delete> or <F2> during the Power-On Self Test (POST). If you do not press <Delete> or <F2>, POST continues with its routines.

### Entering BIOS Setup after POST

To enter BIOS Setup after POST:

- Press <Ctrl>+<Alt>+<Delete> simultaneously.
- Press the reset button on the system chassis.
- Press the power button to turn the system off then back on. Do this option only if you failed to enter BIOS Setup using the first two options.

After doing either of the three options, press <Delete> key to enter BIOS.



- 
- Ensure that a USB mouse is connected to your motherboard if you want to use the mouse to control the BIOS setup program.
  - If the system becomes unstable after changing any BIOS setting, load the default settings to ensure system compatibility and stability. Select the **Load Optimized Defaults** item under the **Exit** menu or press hotkey <F5>.
  - If the system fails to boot after changing any BIOS setting, try to clear the CMOS and reset the motherboard to the default value.
  - The BIOS setup program does not support Bluetooth devices.
- 

### BIOS menu screen

The BIOS Setup program can be used under two modes: **EZ Mode** and **Advanced Mode**. You can change modes from **Setup Mode** in **Boot menu** or by pressing the <F7> hotkey.

## 2.3 ASUS EZ Flash 3

The ASUS EZ Flash 3 feature allows you to update the BIOS without using an OS-based utility.



---

Ensure to load the BIOS default settings to ensure system compatibility and stability. Select the **Load Optimized Defaults** item under the **Exit** menu or press hotkey **<F5>**.

---

### To update the BIOS:



- This function can support devices such as a USB flash disk with FAT 32/16 format and single partition only.
  - DO NOT shut down or reset the system while updating the BIOS to prevent system boot failure!
- 

1. Insert the USB flash disk that contains the latest BIOS file to the USB port.
2. Enter the Advanced Mode of the BIOS setup program. Go to the **Tool** menu to select **ASUS EZ Flash 3 Utility** and press **<Enter>**.
3. Press the Left/Right arrow keys to switch to the **Drive** field.
4. Press the Up/Down arrow keys to find the USB flash disk that contains the latest BIOS, and then press **<Enter>**.
5. Press the Left/Right arrow keys to switch to the **Folder** field.
6. Press the Up/Down arrow keys to find the BIOS file, and then press **<Enter>** to perform the BIOS update process. Reboot the system when the update process is done.

## 2.4 ASUS CrashFree BIOS 3

The ASUS CrashFree BIOS 3 utility is an auto recovery tool that allows you to restore the BIOS file when it fails or gets corrupted during the updating process. You can restore a corrupted BIOS file using a USB flash drive that contains the BIOS file.

### Recovering the BIOS

1. Download the latest BIOS version for this motherboard from <https://www.asus.com/support/>.
2. Rename the BIOS file as **ASUS.CAP** or **TGB650PW.CAP** and copy the renamed BIOS file to a USB flash drive.
3. Turn on the system.
4. Insert the USB flash drive containing the BIOS file to a USB port.
5. The utility automatically checks the devices for the BIOS file. When found, the utility reads the BIOS file and enters ASUS EZ Flash 3 automatically.
6. The system requires you to enter BIOS Setup to recover the BIOS setting. To ensure system compatibility and stability, we recommend that you press <F5> to load default BIOS values.



---

DO NOT shut down or reset the system while updating the BIOS! Doing so can cause system boot failure!

---

## 2.5 RAID configurations

The motherboard comes with the RaidXpert2 Configuration Utility that supports Volume, RAIDABLE, RAID 0, RAID 1, and RAID 10 (depends on system licensing) configurations.



---

For more information on configuring your RAID sets, please refer to the **RAID Configuration Guide** which you can find at <https://www.asus.com/support>, or by scanning the QR code.

---



### RAID definitions

**Volume** provides the ability to link-together storage from one or several disks, regardless of the size of the space on those disks. This configuration is useful in scavenging space on disks unused by other disks in the array. This configuration does not provide performance benefits or data redundancy, disk failure will result in data loss.

**RAIDABLE** arrays (also known as RAID Ready) are a special type of Volume (JBOD) that allows the user to add more storage space or create a redundant array after a system is installed. RAIDABLE arrays are created using Option ROM, UEFI, or rcadm.



---

The ability to create RAIDABLE arrays may vary per system.

---

**RAID 0 (Data striping)** optimizes two identical hard disk drives to read and write data in parallel, interleaved stacks. Two hard disks perform the same work as a single drive but at a sustained data transfer rate, double that of a single disk alone, thus improving data access and storage. Use of two new identical hard disk drives is required for this setup.

**RAID 1 (Data mirroring)** copies and maintains an identical image of data from one drive to a second drive. If one drive fails, the disk array management software directs all applications to the surviving drive as it contains a complete copy of the data in the other drive. This RAID configuration provides data protection and increases fault tolerance to the entire system. Use two new drives or use an existing drive and a new drive for this setup. The new drive must be of the same size or larger than the existing drive.

**RAID 10** is data striping and data mirroring combined without parity (redundancy data) having to be calculated and written. With the RAID 10 configuration you get all the benefits of both RAID 0 and RAID 1 configurations. Use four new hard disk drives or use an existing drive and three new drives for this setup.



# Appendix

## Notices

### FCC Compliance Information

Responsible Party: Asus Computer International

Address: 48720 Kato Rd., Fremont, CA 94538, USA

Phone / Fax No: (510)739-3777 / (510)608-4555

This device complies with part 15 of the FCC Rules. Operation is subject to the following two conditions: (1) This device may not cause harmful interference, and (2) this device must accept any interference received, including interference that may cause undesired operation.

This equipment has been tested and found to comply with the limits for a Class B digital device, pursuant to part 15 of the FCC Rules. These limits are designed to provide reasonable protection against harmful interference in a residential installation. This equipment generates, uses and can radiate radio frequency energy and, if not installed and used in accordance with the instructions, may cause harmful interference to radio communications. However, there is no guarantee that interference will not occur in a particular installation. If this equipment does cause harmful interference to radio or television reception, which can be determined by turning the equipment off and on, the user is encouraged to try to correct the interference by one or more of the following measures:

- Reorient or relocate the receiving antenna.
- Increase the separation between the equipment and receiver.
- Connect the equipment into an outlet on a circuit different from that to which the receiver is connected.
- Consult the dealer or an experienced radio/TV technician for help.

### RF exposure warning

This equipment must be installed and operated in accordance with provided instructions and the antenna(s) used for this transmitter must be installed to provide a separation distance of at least 20 cm from all persons and must not be co-located or operating in conjunction with any other antenna or transmitter. End-users and installers must be provide with antenna installation instructions and transmitter operating conditions for satisfying RF exposure compliance.

### HDMI Trademark Notice

The terms HDMI, HDMI High-Definition Multimedia Interface, and the HDMI Logo are trademarks or registered trademarks of HDMI Licensing Administrator, Inc.

## Compliance Statement of Innovation, Science and Economic Development Canada (ISED)

This device complies with Innovation, Science and Economic Development Canada licence exempt RSS standard(s). Operation is subject to the following two conditions: (1) this device may not cause interference, and (2) this device must accept any interference, including interference that may cause undesired operation of the device.

Operation in the band 5150–5250 MHz is only for indoor use to reduce the potential for harmful interference to co-channel mobile satellite systems.

CAN ICES-003(B)/NMB-003(B)

## Déclaration de conformité de Innovation, Sciences et Développement économique Canada (ISED)

Le présent appareil est conforme aux CNR d'Innovation, Sciences et Développement économique Canada applicables aux appareils radio exempts de licence. L'exploitation est autorisée aux deux conditions suivantes : (1) l'appareil ne doit pas produire de brouillage, et (2) l'utilisateur de l'appareil doit accepter tout brouillage radioélectrique subi, même si le brouillage est susceptible d'en compromettre le fonctionnement.

La bande 5150–5250 MHz est réservée uniquement pour une utilisation à l'intérieur afin de réduire les risques de brouillage préjudiciable aux systèmes de satellites mobiles utilisant les mêmes canaux.

CAN ICES-003(B)/NMB-003(B)

## VCCI: Japan Compliance Statement

### Class B ITE

この装置は、クラスB情報技術装置です。この装置は、家庭環境で使用することを目的としていますが、この装置がラジオやテレビジョン受信機に近接して使用されると、受信障害を引き起こすことがあります。

取扱説明書に従って正しい取り扱いをして下さい。

VCCI-B

## Japan JATE

本製品は電気通信事業者（移動通信会社、固定通信会社、インターネットプロバイダ等）の通信回線（公衆無線LANを含む）に直接接続することができません。本製品をインターネットに接続する場合は、必ずルーター等を経由し接続してください。

## KC: Korea Warning Statement

B급 기기 (가정용 방송통신기자재)

이 기기는 가정용(B급) 전자파적합기기로서 주로 가정에서 사용하는 것을 목적으로 하며, 모든 지역에서 사용할 수 있습니다.

\*당해 무선설비는 전파혼신 가능성이 있으므로 인명안전과 관련된 서비스는 할 수 없습니다.



# Google™ License Terms

Copyright© 2022 Google Inc. All Rights Reserved.

Licensed under the Apache License, Version 2.0 (the "License"); you may not use this file except in compliance with the License. You may obtain a copy of the License at:

<http://www.apache.org/licenses/LICENSE-2.0>

Unless required by applicable law or agreed to in writing, software distributed under the License is distributed on an "AS IS" BASIS, WITHOUT WARRANTIES OR CONDITIONS OF ANY KIND, either express or implied.

See the License for the specific language governing permissions and limitations under the License.

## NCC: Taiwan Wireless Statement

取得審驗證明之低功率射頻器材，非經核准，公司、商號或使用者均不得擅自變更頻率、加大功率或變更原設計之特性及功能。低功率射頻器材之使用不得影響飛航安全及干擾合法通信；經發現有干擾現象時，應立即停用，並改善至無干擾時方得繼續使用。前述合法通信，指依電信管理法規定作業之無線電通信。低功率射頻器材須忍受合法通信或工業、科學及醫療用電波輻射性電機設備之干擾。

應避免影響附近雷達系統之操作。

## Japan RF Equipment Statement

### 屋外での使用について

本製品は、5GHz帯域での通信に対応しています。電波法の定めにより5.2GHz、5.3GHz帯域の電波は屋外で使用が禁じられています。

### 法律および規制遵守

本製品は電波法及びこれに基づく命令の定めるところに従い使用してください。日本国外では、その国の法律または規制により、本製品の使用ができないことがあります。このような国では、本製品を運用した結果、罰せられることがあります。当社は一切責任を負いかねますのでご了承ください。

## Précautions d'emploi de l'appareil:

- a. Soyez particulièrement vigilant quant à votre sécurité lors de l'utilisation de cet appareil dans certains lieux (les avions, les aéroports, les hôpitaux, les stations-service et les garages professionnels).
- b. Évitez d'utiliser cet appareil à proximité de dispositifs médicaux implantés. Si vous portez un implant électronique (stimulateurs cardiaques, pompes à insuline, neurostimulateurs...), veuillez impérativement respecter une distance minimale de 15 centimètres entre cet appareil et l'implant pour réduire les risques d'interférence.
- c. Utilisez cet appareil dans de bonnes conditions de réception pour minimiser le niveau de rayonnement. Ce n'est pas toujours le cas dans certaines zones ou situations, notamment dans les parkings souterrains, dans les ascenseurs, en train ou en voiture ou tout simplement dans un secteur mal couvert par le réseau.
- d. Tenez cet appareil à distance du ventre des femmes enceintes et du bas-ventre des adolescents.

# Declaration of compliance for product environmental regulation

ASUS follows the green design concept to design and manufacture our products, and makes sure that each stage of the product life cycle of ASUS product is in line with global environmental regulations. In addition, ASUS disclose the relevant information based on regulation requirements.

Please refer to <http://csr.asus.com/Compliance.htm> for information disclosure based on regulation requirements ASUS is complied with:

## EU REACH and Article 33

Complying with the REACH (Registration, Evaluation, Authorisation, and Restriction of Chemicals) regulatory framework, we published the chemical substances in our products at ASUS REACH website at <http://csr.asus.com/english/REACH.htm>.

## EU RoHS

This product complies with the EU RoHS Directive. For more details, see <http://csr.asus.com/english/article.aspx?id=35>.

## India RoHS

This product complies with the “India E-Waste (Management) Rules, 2016” and prohibits use of lead, mercury, hexavalent chromium, polybrominated biphenyls (PBBs) and polybrominated diphenyl ethers (PBDEs) in concentrations exceeding 0.1% by weight in homogenous materials and 0.01% by weight in homogenous materials for cadmium, except for the exemptions listed in Schedule II of the Rule.

## Vietnam RoHS

ASUS products sold in Vietnam, on or after September 23, 2011, meet the requirements of the Vietnam Circular 30/2011/TT-BCT.

Các sản phẩm ASUS bán tại Việt Nam, vào ngày 23 tháng 9 năm 2011 trở về sau, đều phải đáp ứng các yêu cầu của Thông tư 30/2011/TT-BCT của Việt Nam.

## Türkiye RoHS

AEEE Yönetmeliğine Uygundur

## ASUS Recycling/Takeback Services

ASUS recycling and takeback programs come from our commitment to the highest standards for protecting our environment. We believe in providing solutions for you to be able to responsibly recycle our products, batteries, other components as well as the packaging materials. Please go to <http://csr.asus.com/english/Takeback.htm> for detailed recycling information in different regions.



---

DO NOT throw the motherboard in municipal waste. This product has been designed to enable proper reuse of parts and recycling. This symbol of the crossed out wheeled bin indicates that the product (electrical and electronic equipment) should not be placed in municipal waste. Check local regulations for disposal of electronic products.

---



---

DO NOT throw the mercury-containing button cell battery in municipal waste. This symbol of the crossed out wheeled bin indicates that the battery should not be placed in municipal waste.

---

# France sorting and recycling information



## Safety Precautions

Accessories that came with this product have been designed and verified for the use in connection with this product. Never use accessories for other products to prevent the risk of electric shock or fire.

## 安全上のご注意

付属品は当該専用品です。他の機器には使用しないでください。機器の破損もしくは、火災や感電の原因となることがあります。

### Simplified UKCA Declaration of Conformity

ASUSTek Computer Inc. hereby declares that this device is in compliance with the essential requirements and other relevant provisions of The Radio Equipment Regulations 2017 (S.I. 2017/1206). Full text of UKCA declaration of conformity is available at <https://www.asus.com/support/>.

The WiFi operating in the band 5150-5350MHz shall be restricted to indoor use for the country listed below:

# UK

### UKCA RF Output table (The Radio Equipment Regulations 2017)

Wi-Fi 6 (Model: RTL8852BE):

Function	Frequency	Maximum Output Power (EIRP)
WiFi	2412 - 2472 MHz	17.60 dBm
	5150 - 5350 MHz	20.06 dBm
	5470 - 5725 MHz	19.88 dBm
	5725 - 5850 MHz	9.71 dBm
Bluetooth	2402-2480 MHz	13.20 dBm

Wi-Fi 6 (Model: MT7921):

Function	Frequency	Maximum Output Power (EIRP)
WiFi	2412 - 2472MHz	17.99 dBm
	5150 - 5350MHz	20.57 dBm
	5470 - 5725MHz	17.06 dBm
	5725 - 5850MHz	10.05 dBm
Bluetooth	2402 - 2480MHz	14.37 dBm

\* Receiver category 1

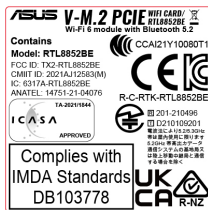

\* Receiver category 1

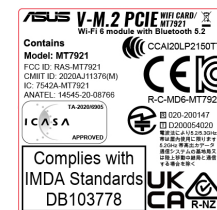

\* The actual Wi-Fi module that comes with this motherboard may vary, please refer to the label on the product for more details.

### Simplified EU Declaration of Conformity

ASUSTek Computer Inc. hereby declares that this device is in compliance with the essential requirements and other relevant provisions of Directive 2014/53/EU. Full text of EU declaration of conformity is available at <https://www.asus.com/support/>

The WiFi operating in the band 5150-5350MHz shall be restricted to indoor use for countries listed in the table below:

### Déclaration simplifiée de conformité de l'UE

ASUSTek Computer Inc. déclare par la présente que cet appareil est conforme aux critères essentiels et autres clauses pertinentes de la directive 2014/53/UE. La déclaration de conformité de l'UE peut être téléchargée à partir du site internet suivant : <https://www.asus.com/support/>

Dans la plage de fréquence 5150-5350 MHz, le Wi-Fi est restreint à une utilisation en intérieur dans les pays listés dans le tableau ci-dessous:

### Vereinfachte EU-Konformitätserklärung

ASUSTek COMPUTER INC erklärt hiermit, dass dieses Gerät mit den grundlegenden Anforderungen und anderen relevanten Bestimmungen der Richtlinie 2014/53/UE übereinstimmt. Der gesamte Text der EU-Konformitätserklärung ist verfügbar unter: <https://www.asus.com/support/>

Der WLAN-Betrieb im Band von 5150-5350 MHz ist für die in der unteren Tabelle aufgeführten Länder auf den Innenbereich beschränkt:

### Dichiarazione di conformità UE semplificata

ASUSTek Computer Inc. con la presente dichiara che questo dispositivo è conforme ai requisiti essenziali e alle altre disposizioni pertinenti con la direttiva 2014/53/UE. Il testo completo della dichiarazione di conformità UE è disponibile all'indirizzo: <https://www.asus.com/support/>

L'utilizzo della rete Wi-Fi con frequenza compresa nell'intervallo 5150-5350MHz deve essere limitato all'interno degli edifici per i paesi presenti nella seguente tabella:

### Упрощенное заявление о соответствии европейской директиве

ASUSTek Computer Inc. заявляет, что устройство соответствует основным требованиям и другим соответствующим условиям директивы 2014/53/UE. Полный текст декларации соответствия ЕС доступен на <https://www.asus.com/support/>

Работа WiFi в диапазоне частот 5150-5350 должна быть ограничена использованием в помещениях для стран, перечисленных в таблице ниже:

### إعلان التوافق المبسط الصادر عن الاتحاد الأوروبي

تقر شركة ASUSTek Computer Inc هذا الجهاز بتوافق مع المتطلبات الأساسية والأحكام الأخرى ذات الصلة الخاصة بتوجيه 2014/53/UE. يتوفر النص الكامل لإعلان التوافق الصادر عن الاتحاد الأوروبي على: <https://www.asus.com/support/>

يجب حصر استخدام WiFi العاملة بـ 5150-5350 ميغا هرتز على الاستخدام المنزلي للبلدان المدرجة بالجدول.

### Опростена декларация за съответствие на ЕС

С настоящото ASUSTek Computer Inc. декларира, че това устройство е в съответствие със съществените изисквания и другите приложими постановления на свързаната Директива 2014/53/ЕС. Пълният текст на ЕС декларация за съвместимост е достъпен на адрес <https://www.asus.com/support/>

WiFi, работеща в диапазона 5150-5350MHz, трябва да се ограничи до употреба на закрито за страните, посочени в таблицата по-долу:

### Declaração de Conformidade UE Simplificada

ASUSTek Computer Inc. declara que este dispositivo está em conformidade com os requisitos essenciais e outras disposições relevantes relacionadas às diretivas 2014/53/UE. O texto completo da declaração de conformidade CE está disponível em <https://www.asus.com/support/>

O WiFi operando na banda 5150-5350MHz deve ser restrito para uso interno para os países listados na tabela abaixo:

### Pojednostavljena EU Izjava o sukladnosti

ASUSTek Computer Inc. ovim izjavljuje da je ovaj uređaj sukladan s bitnim zahtjevima i ostalim odgovarajućim odredbama direktive 2014/53/EU. Cijeli tekst EU izjave o sukladnosti dostupan je na <https://www.asus.com/support/>. WiFi koji radi na opsegu frekvencija 5150-5350 MHz bit će ograničen na upotrebu u zatvorenom prostoru u zemljama na donjem popisu:

### Zjednodušené prohlášení o shodě EU

Splňuje ASUSTek Computer Inc. tímto prohlášení, že toto zařízení splňuje základní požadavky a další příslušná ustanovení směrnice 2014/53/ EU. Plné znění prohlášení o shodě EU je k dispozici na adrese <https://www.asus.com/support/>

V zemích uvedených v tabulce je provoz sítě Wi-Fi ve frekvenčním rozsahu 5 150 - 5 350 MHz povolen pouze ve vnitřních prostorech:

### Forenklet EU-overensstemmelseerklæring

ASUSTek Computer Inc. erklærer hermed at denne enhed er i overensstemmelse med hovedkravene og øvrige relevante bestemmelser i direktivet 2014/53/UE. Hele EU-overensstemmelseerklæringen kan findes på <https://www.asus.com/support/>

Wi-Fi, der bruger 5150-5350 MHz skal begrænses til indendørs brug i lande, der er anført i tabellen:

### Vereenvoudigd EU-conformiteitsverklaring

ASUSTek Computer Inc. verklaart hierbij dat dit apparaat voldoet aan de essentiële vereisten en andere relevante bepalingen van Richtlijn 2014/53/UE. De volledige tekst van de EU-conformiteitsverklaring is beschikbaar op <https://www.asus.com/support/>

De WiFi op 5150-5350MHz zal beperkt zijn tot binnengebruik voor in de tabel vermelde landen:

### Lihtsustatud EU vastavusdeklaratsioon

Käesolevaga kinnitab ASUSTek Computer Inc. et seade vastab direktiivi 2014/53/UE olulistele nõuetele ja teistele asjakohastele sätetele. EL vastavusdeklaratsiooni täistekst on saadaval veebisaidil <https://www.asus.com/support/>

Sagedusvahemikus 5150-5350 MHz töötava WiFi kasutamise on järgmistes riikides lubatud ainult siseruumides:

### Eurooppa - EY:n vaatimustenmukaisuusvakuutus

ASUSTek Computer Inc. ilmoittaa täten, että tämä laite on direktiivin 2014/53/UE olennaisista vaatimuksista ja muiden asiaankuuluvien lisäysten mukainen. Koko EY:n vaatimustenmukaisuusvakuutuksen teksti on luettavissa osoitteessa <https://www.asus.com/support/>

5 150 - 5 350 MHz:in taajuudella toimiva WiFi on rajoitettu sisäkäyttöön taulukossa luettelussa maissa:

### تبہیت از نسخہ شدہ بیانیہ اتحایہ اروپا

ASUSTek Computer Inc از اینجا اعلام می کند که این دستگاه با نیازهای اساسی و سایر مقررات مربوط به بیانیہ 2014/53/UE، متن کامل پیروی از این بیانیہ اتحایہ اروپا بر این آدرس موجود است: <https://www.asus.com/support/>

عبارت 5150-5350 مگاهرتز برای WiFi باید برای استفاده در فضای داخل ساختمان برای کشورهای فهرست شده در جدول، محدود شود.

### Απλοποιημένη Δήλωση Συμμόρφωσης ΕΕ

Διά του παρόντος η ASUSTek Computer Inc. δηλώνει ότι αυτή η συσκευή είναι συμμόρφω με τις βασικές προϋποθέσεις και άλλες ουσιαστικές διατάξεις της Οδηγίας 2014/53/ΕΕ. Το πλήρες κείμενο της δήλωσης συμμόρφωσης της ΕΕ είναι διαθέσιμο στη διεύθυνση <https://www.asus.com/support/>

To WiFi που λειτουργεί στη ζώνη 5150-5350MHz περιορίζεται για χρήση σε εσωτερικούς χώρους για τα χώρες που αναφέρονται στον παρακάτω πίνακα:

### ההרת האימות והולטורית מקוברת עבור האיחוד האירופי

ASUSTek Computer Inc. מצהירה בהתאם לדרישות החיוביות ולשאר הסעיפים הרלוונטיים של תקנה 2014/53/UE, ניתן לקרוא את תוכן ההמלצה של ההרת האימות והולטורית עבור האיחוד האירופי בתוכנית: <https://www.asus.com/support/>

יש להגביל שימוש Wi-Fi הפועלת בתדירות 5150-5350MHz לשמוש בתוך מבנים סגורים בארצות המפורטות ברשימה הבאה:

### Egyeszerősített EU megfeleléségi nyilatkozatok

Az ASUSTek Computer Inc. ezennel kijelenti, hogy ez az eszköz megfelel az 2014/53/EU sz. irányelv alapvető követelményeinek és egyéb vonatkozó rendelkezésének. Az EU megfeleléségi nyilatkozat teljes szövegét a következő weboldalon tekintheti meg: <https://www.asus.com/support/>

Az 5150-5350 MHz-es sávban működő Wi-Fi-t beltéri használatra kell korlátozni az alábbi táblázatban felsorolt országokban:

### Pernyataan Kesesuaian UE yang Disederhanakan

ASUSTek Computer Inc. dengan ini menyatakan bahwa perangkat ini memenuhi persyaratan utama dan ketentuan relevan lainnya yang terdapat pada Peraturan 2014/53/UE. Teks lengkap pernyataan kesesuaian UE tersedia di: <https://www.asus.com/support/>

WiFi yang Beroperasi pada 5150-5350 MHz akan terbatas untuk penggunaan dalam ruangan di negara yang tercantum dalam tabel

### Vienkāršota ES atbilstības paziņojums

ASUSTek Computer Inc. ar šo paziņojumu, ka šī ierīce atbilst Direktīvas 2014/53/ES būtiskajām prasībām un citiem citiem saistošajiem nosacījumiem. Pilns ES atbilstības paziņojuma teksts pieejams šeit: <https://www.asus.com/support/>

Wi-Fi darbība 5150-5350 MHz ir jāierobežo lietošanai telpās valstīs, kuras norādītas tālāk.

### Suaprapastina ES atitikties deklaracija

Šiame dokumente bendrovė „ASUSTek Computer Inc.“ pareiškia, kad šis prietaisas atitinka pagrindinius reikalavimus ir kitas susijusias Direktyvos 2014/53/ES nuostatas. Visas ES atitikties deklaracijos tekstas pateikiamas čia: <https://www.asus.com/support/>

Toliau nurodytose šalyse „WiFi“ ryšiu, veikiančiu 5 150–5 350 MHz dažniu juostoje, galima naudotis tik patalpose:

### Forenklet EU-samsvarserklaring

ASUSTek Computer Inc. erklærer herved at denne enheten er i samsvar med hovedsaklige krav og andre relevante forskrifter i direktivet 2014/53/EU. Fullstendig tekst for EU-samsvarserklaringen finnes på: <https://www.asus.com/support/>

Wi-Fi-området 5150–5350 MHz skal begrenses til innendørs bruk for landene som er oppført i tabellen:

### Uproszczone deklaracja zgodności UE

Firma ASUSTek Computer Inc. niniejszym oświadcza, że urządzenie to jest zgodne z zasadniczymi wymogami i innymi właściwymi postanowieniami dyrektywy 2014/53/UE. Pełny tekst deklaracji zgodności UE jest dostępny pod adresem <https://www.asus.com/support/>

W krajach wymienionych w tabeli działanie sieci Wi-Fi w paśmie 5150–5350 MHz powinno być ograniczone wyłącznie do pomieszczeń:

### Declaração de Conformidade Simplificada da UE

A ASUSTek Computer Inc. declara que este dispositivo está em conformidade com os requisitos essenciais e outras disposições relevantes da Diretiva 2014/53/UE. O texto integral da declaração de conformidade da UE está disponível em <https://www.asus.com/support/>

A utilização das frequências WiFi de 5150 a 5350MHz está restrita a ambientes interiores nos países apresentados na tabela:

### Declaratie de conformitate UE, versiune simplificată

Prin prezenta, ASUSTek Computer Inc. declară că acest dispozitiv este în conformitate cu regulamentele esențiale și cu celelalte prevederi relevante ale Directivei 2014/53/UE. Textul complet al declarației de conformitate UE este disponibil la adresa <https://www.asus.com/support/>

Pentru țările listate în tabelul de mai jos, rețelele WiFi care funcționează în banda de frecvență de 5.150-5.350 MHz trebuie utilizate doar în interior:

### Pojednostavljena Deklaracija o uslaglašenosti EU

ASUSTek Computer Inc. ovim izjavljuje da je ovaj uređaj usaglašen sa osnovnim zahtevima i drugim relevantnim odredbama Direktive 2014/53/EU. Geo tekst Deklaracije o uslaglašenosti EU dostupan je na lokaciji <https://www.asus.com/support/>

WiFi koji radi u frekventnom opsegu od 5150 MHz do 5350 MHz ograničen je isključivo na upotrebu u zatvorenom prostoru za zemlje navedene u tabeli ispod:

### Zjednodušené vyhlásenie o zhode platné pre EÚ

Spoločnosť ASUSTek Computer Inc. týmto vyhlasuje, že toto zariadenie je v súlade so základnými požiadavkami a ďalšími príslušnými ustanoveniami smernice č. 2014/53/EÚ. Plné znenie vyhlásenia o zhode pre EÚ je k dispozícii na lokalite <https://www.asus.com/support/>

Činnosť WiFi v pásme 5150–5350 MHz bude obmedzená na použitie vo vnútornom prostredí pre krajiny uvedené v tabuľke nižšie:

### Poenostavljena izjava EU o skladnosti

ASUSTek Computer Inc. tukaj izjavlja, da je ta naprava skladna s temeljnimi zahtevami in drugimi relevantnimi določili Direktive 2014/53/EU. Polno besedilo izjave EU o skladnosti je na voljo na <https://www.asus.com/support/>

WiFi, ki deluje v pasovnem območju 5150–5350 MHz, mora biti v državah, navedenih v spodnjem seznamu, omejen na notranjo uporabo:

### Declaración de conformidad simplificada para la UE

Por la presente, ASUSTek Computer Inc. declara que este dispositivo cumple los requisitos básicos y otras disposiciones pertinentes de la directiva 2014/53/UE. En <https://www.asus.com/support/> está disponible el texto completo de la declaración de conformidad para la UE.

La conexión WiFi con una frecuencia de funcionamiento de 5150-5350 MHz se restringirá al uso en interiores para los países enumerados en la tabla:

### Förenklad EU-försäkran om överensstämmelse

ASUSTek Computer Inc. deklarerar härmed att denna enhet överensstämmer med de grundläggande kraven och andra relevanta bestämmelser i direktiv 2014/53/EU. Fullständig text av EU-försäkran om överensstämmelse finns på <https://www.asus.com/support/>

WiFi som används 5150-5350 MHz kommer att begränsas för användning inomhus i de länder som anges i tabellen:

### ประกาศเกี่ยวกับความสอดคล้องของสหภาพยุโรปแบบย่อ

ASUSTek Computer Inc. ขอประกาศในที่นี้ว่าอุปกรณ์นี้มีความสอดคล้องกับตาม

ข้อกำหนดที่จำเป็นและเงื่อนไขที่เกี่ยวข้องอื่น ๆ ของบทบัญญัติซึ่งกำหนด 2014/53/EU เนื้อหาที่สมบูรณ์ของประกาศความสอดคล้องกับ EU มีอยู่ที่ <https://www.asus.com/support/>

การทำงานของ WiFi ที่ 5150-5350MHz ถูกจำกัดให้ใช้ในอาคารสำหรับประเทศที่แสดงในตาราง

### Basitleştirilmiş AB Uyumluluk Bildirimi

ASUSTek Computer Inc. bu aygıtın 2014/53/EU Yönergesinin temel gereksinimlerine ve diğer ilgili hükümlerine uygun olduğunu bildirir. AB uyumluluk bildiriminin tam metni şu adreste bulunabilir:

<https://www.asus.com/support/>

5150-5350 MHz aralındaki WiFi çalışması, tabloda listelenen ülkeler için iç mekân kullanımıyla kısıtlanacaktır.

### Спрощена декларація про відповідність нормам ЄС

ASUSTek Computer Inc. заявляє, що цей пристрій відповідає основним вимогам та іншим відповідним вимогам Директиви 2014/53/ЕU. Повний текст декларації відповідності нормам ЄС доступний на <https://www.asus.com/support/>

Робота Wi-Fi на частоті 5150-5350 МГц обмежується використанням у приміщенні для країн, поданих у таблиці нижче:



AT	BE	BG	CZ	DK	EE	FR
DE	IS	IE	IT	EL	ES	CY
LV	LI	LT	LU	HU	MT	NL
NO	PL	PT	RO	SI	SK	TR
FI	SE	CH	HR	UK(NI)		

### CE RED RF Output table (Directive 2014/53/EU)

Wi-Fi 6 (Model: RTL8852BE):

Function	Frequency	Maximum Output Power (EIRP)
WiFi	2412 - 2472 MHz	17.60 dBm
	5150 - 5350 MHz	20.06 dBm
	5470 - 5725 MHz	19.88 dBm
Bluetooth	5725 - 5850 MHz	9.71 dBm
	2402 - 2480 MHz	13.20 dBm

\* Receiver category 1



Wi-Fi 6 (Model: MT7921):

Function	Frequency	Maximum Output Power (EIRP)
WiFi	2412 - 2472MHz	17.99 dBm
	5150 - 5350MHz	20.57 dBm
	5470 - 5725MHz	17.06 dBm
	5725 - 5850MHz	10.05 dBm
Bluetooth	2402 - 2480MHz	14.37 dBm

\* Receiver category 1

**ASUS V-M.2 PCIe WiFi 6/Bluetooth 5.2**  
 Model: MT7921  
 CCAI20LP215077

Contains  
 Model: MT7921  
 FCC ID: RAS-MT7921  
 CMIIT ID: 2020AJ11376(M)  
 IC: 1542A-MT7921  
 ANATEL: 14545-20-08766

CEC  
 R-C-MID6-MT7921

ICASA  
 1A-20200990

Complies with  
 IMDA Standards  
 DB103778

UK  
 CA  
 R-NZ

\* The actual Wi-Fi module that comes with this motherboard may vary, please refer to the label on the product for more details.

# Warranty

## EN: ASUS Guarantee Information

- ASUS offers a voluntary manufacturer's Commercial Guarantee.
- ASUS reserves the right to interpret the provisions of the ASUS Commercial Guarantee.
- This ASUS Commercial Guarantee is provided independently and in addition to the statutory Legal Guarantee and in no way affects or limits the rights under the Legal Guarantee.

For all the guarantee information, please visit <https://www.asus.com/support>.

## F: Garantie ASUS

- ASUS fournit une garantie commerciale en tant que garantie volontaire du fabricant.
- ASUS se réserve le droit d'interpréter et de clarifier les informations relatives à la garantie commerciale ASUS.
- Cette garantie commerciale ASUS est fournie indépendamment et parallèlement à la garantie légale, elle n'affecte ou ne limite d'aucune façon les droits acquis par la garantie légale.

Pour plus d'informations sur la garantie, consultez le site <https://www.asus.com/fr/support/>.

## G: ASUS Garantieinformationen

- ASUS bietet eine freiwillige Waregarantie des Herstellers an.
- ASUS behält sich das Recht zur Auslegung der Bestimmungen in der ASUS Waregarantie vor.
- Diese ASUS Waregarantie wird unabhängig und zusätzlich zur rechtmäßigen gesetzlichen Garantie gewährt und beeinträchtigt oder beschränkt in keiner Weise die Rechte aus der gesetzlichen Garantie.

Die vollständigen Garantieinformationen finden Sie unter <https://www.asus.com/de/support/>.

## I: Informativa sulla Garanzia ASUS

- ASUS offre una Garanzia Commerciale volontaria del produttore.
- ASUS si riserva il diritto di interpretare le disposizioni della Garanzia Commerciale ASUS.
- La presente Garanzia Commerciale ASUS viene fornita in modo indipendente e in aggiunta alla Garanzia Legale prevista per legge e non pregiudica o limita in alcun modo i diritti previsti dalla Garanzia Legale.

Per tutte le informazioni sulla garanzia, visitare <https://www.asus.com/it/support>.

## R: Информация о гарантии ASUS

- ASUS предлагает добровольную гарантию от производителя.
- ASUS оставляет за собой право интерпретирования положений гарантии ASUS.
- Настоящая гарантия ASUS никоим образом не ограничивает Ваши права, предусмотренные локальным законодательством.

Для получения полной информации о гарантии посетите <https://www.asus.com/ru/support/>.

## DA: ASUS garantioplysninger

- ASUS tilbyder en valgfri handelsmæssig garanti.
- ASUS forbeholder sig retten til at forfølge bestemmelseerne i ASUS' handelsmæssige garanti.
- Denne handelsmæssige garanti fra ASUS tilbydes uafhængigt, som en tilføjelse til den lovbestemte juridiske garanti og den påviker eller begrænser på ingen måde rettigehederne i den juridiske garanti.

Alle garantioplysningerne kan findes på <https://www.asus.com/dk/support/>.

## BG: Информация за гаранцията от ASUS

- ASUS предлага доброволна търговска гаранция от производителя.
- ASUS си запазва правото да търкува условията на търговската гаранция на ASUS.
- Тази търговска гаранция на ASUS се предлага независимо от и в допълнение на законовата гаранция. Тя по никакъв начин не оказва влияние върху правата на потребителя в законовата гаранция и по никакъв начин не ги ограничават.

За цялостна информация относно гаранцията, моля, посетете <https://www.asus.com/bg/support>.

## CZ: Informace o záruce společnosti ASUS

- Společnost ASUS nabízí dobrovolnou komerční záruku výrobce.
- Společnost ASUS si vyhrazuje právo vykládat ustanovení komerční záruky společnosti ASUS.
- Tato komerční záruka společnosti ASUS je poskytována nezávisle a jako doplněk zákonné záruky a žádným způsobem neovlivňuje ani neomezuje práva vyplývající ze zákonné záruky.

Všechny informace o záruce najdete na adrese <https://www.asus.com/cz/support/>.

## CR: Informacije o ASUS jamstvu

- ASUS dragovoljno nudi komercijalno proizvođačko jamstvo.
- ASUS zadržava prava na tumačenje odredbi ASUS komercijalnog jamstva.
- Ovo ASUS komercijalno jamstvo daje se neovisno i kao dodatak zakonskom jamstvu i ni na koji način ne ograničuje prava iz okvira zakonskog jamstva.

Sve informacije o jamstvu potražite na <https://www.asus.com/support>.

## DU: ASUS-garantie-informatie

- SUS biedt een vrijwillige commerciële garantie van de fabrikant.
- ASUS behoudt zich het recht voor om de bepalingen van de commerciële garantie van ASUS uit te leggen.
- Deze commerciële garantie van ASUS wordt onafhankelijk en als aanvulling op de statutaire Wettelijke garantie geboden en beïnvloedt of beperkt in geen geval de rechten onder de wettelijke garantie.

Voor alle informatie over de garantie, gaat u naar <https://www.asus.com/nl/support/>.

## EE: Teave ASUS-e garanti kohta

- ASUS pakub vabatahtlikku tasulist tootjagarantii.
- ASUS jätab endale õiguse tõlgendada ASUS-e tasulise garantii tingimusi.
- See ASUS-e tasuline garanti on sõltumatu isagarantii seadusega kehtestatud garanti ega mõjuta mingil määral seadusega kehtestatud garantiid ning seadusega kehtestatud garanti piiranguid.

Vaadake garantiiga seotud teavet veebisaidil <https://www.asus.com/ee/>.

## GK: Πληροφορίες εγγύησης ASUS

- Η ASUS προσφέρει μια εθελοντική Εμπιστική εγγύηση κατασκευαστή.
- Η ASUS διατηρεί το δικαίωμα ερμηνείας των διατάξεων της Εμπιστικής εγγύησης ASUS.
- Αυτή η Εμπιστική εγγύηση ASUS παρέχεται ανεξάρτητα και επιπροσθέτως της θεσμικής Νομικής εγγύησης και σε καμία περίπτωση δεν επηρεάζει ή περιορίζει τα δικαιώματα βάσει της Νομικής εγγύησης.

Για όλες τις πληροφορίες εγγύησης, επισκεφθείτε τη διεύθυνση <https://www.asus.com/gr/el/>.

## HUG: ASUS garanciális információk

- Az ASUS önkéntes gyártói kereskedelmi garantációt kínál.
- Az ASUS fenntartja magának a jogot, hogy értelmezze az ASUS kereskedelmi garanciára vonatkozó rendelkezéseket.
- Ezt a kereskedelmi garanciát az ASUS függetlenül és a törvényes garancia mellett nyújtja és semmilyen módon nem befolyásolja, vagy korlátozza a jogi garancia nyújtotta jogokat.

A garanciára vonatkozó teljes körű információkért látogasson el a <https://www.asus.com/hu/support/> oldalra.

## LV: ASUS garantijas informācija

- ASUS piedāvā brīvprātīgu ražotāja komerciālo garantiju.
- ASUS patur tiesības interpretēt ASUS komerciālās garantijas noteikumus.
- Šī ASUS komerciālā garantija tiek piedāvāta neatkarīgi un papildus likumā noteiktajai juridiskajai garantijai, un tā nekādā veidā neietekmē vai neierobežo juridiskajai garantijai noteiktās tiesības.

Lai iegūtu informāciju par garantiju, apmeklējiet vietni <https://www.asus.com/lv/>.

## LT: Informacija apie ASUS garantiją

- ASUS siūlo savanorišką komercinę garantiją garantijai.
- ASUS pasilieka teisę savo nuostūria aiškinti šios komercinės ASUS garantijos nuostatas.
- Ši komercinė ASUS garantija suteikiama nepriklausoma, be įstatyminės teisinės garantijos, ir jokiu būdu nepaveikia ar nepaįriboja teisinės garantijos suteikiamų teisių.

Norėdami gauti informaciją apie garantiją, apsilankykite <https://www.asus.com/lt/>.

## PL: Informacje o gwarancji firmy ASUS

- Firma ASUS oferuje dobrowolną gwarancję handlową producenta.
- Firma ASUS zastrzeżę sobie prawo do interpretacji warunków gwarancji handlowej firmy ASUS.
- Niniejsza gwarancja handlowa firmy ASUS jest udzielana niezależnie, jako dodatek do wymaganej ustawowo gwarancji prawnej i w żaden sposób nie wpływa na prawa przysługujące na mocy gwarancji prawnej ani ich nie ogranicza.

Wszelkie informacje na temat gwarancji można znaleźć na stronie <https://www.asus.com/pl/support>.

#### PG: Informações de Garantia ASUS

- A ASUS oferece uma Garantia Comercial voluntária do fabricante.
- A ASUS reserva o direito de interpretar as disposições da Garantia Comercial da ASUS.
- Esta Garantia Comercial da ASUS é fornecida de forma independente além da Garantia Legal estatutária e não afeta nem limita de qualquer forma os direitos estabelecidos na Garantia Legal.

Para consultar todas as informações sobre a garantia, visite <https://www.asus.com/pl/support/>.

#### RO: Informații despre garanția ASUS

- ASUS oferă o garanție comercială voluntară a producătorului.
- ASUS își rezervă dreptul de a interpreta prevederile garanției comerciale ASUS.
- Această garanție comercială ASUS este oferită independent și în plus față de garanția obligatorie legală și nu afectează sau limitează în niciun fel drepturile acordate conform garanției legale.

Pentru toate informațiile legate de garanție, vizitați <https://www.asus.com/ro/support>.

#### SL: Informacije o garanciji ASUS

- ASUS ponuja prostovoljno tržno garancijo proizvajalca.
- ASUS si pridržuje pravico do razlage določb tržne garancije družbe ASUS.
- Ta tržna garancija družbe ASUS je na voljo neodvisno in kot dodatek zakonsko predpisani pravni garanciji ter na noben način ne vpliva na pravice, ki jih zagotavlja pravna garancija, oziroma jih omejuje.

Vse informacije o garanciji najdete na spletnem mestu <https://www.asus.com/sr/support>.

#### SK: Informácie o záruke ASUS

- ASUS ponúka dobrovoľnú obchodnú záruku výrobcu.
- ASUS si vyhradzuje právo interpretovať ustanovenia obchodnej záruky ASUS.
- Táto obchodná záruka ASUS je poskytnutá nezávisle a navyše k zákonnej záruke a v ziadnom prípade neovplyvňuje ani neobmedzuje tieto práva podľa tejto zákonnej záruky.

Všetky další informace o záruce najdete na <https://www.asus.com/sk/support>.

#### ES: Información de garantía de ASUS

- ASUS ofrece una garantía comercial voluntaria del fabricante.
- ASUS se reserva el derecho de interpretar las disposiciones de esta garantía comercial de ASUS.
- Esta garantía comercial de ASUS se proporciona de forma independiente y adicional a la garantía estatutaria y de ninguna manera afecta a los derechos bajo la garantía legal ni los limita.

Para obtener toda la información sobre la garantía, visite <https://www.asus.com/ES/support/>.

#### TR: ASUS Garanti Bilgileri

- ASUS, gönüllü olarak üretici Ticari Garantisini sunar.
- ASUS, ASUS Ticari Garantisinin hükümlerini yorumlama hakkını saklı tutar.
- Bu ASUS Ticari Garantisini, bağımsız olarak ve hukuki Yasal Garanti'ye ek olarak sağlamak ve hibiz şeklide Yasal Garanti kapsamındaki hakları etkilemez veya sınırlamaz.

Tüm garanti bilgileri için lütfen <https://www.asus.com/tr/support/> adresini ziyaret edin.

#### FI: ASUS-takuutiedot

- ASUS tarjoaa vapaaehtoisien valmistajan kaupallisen takuun.
- ASUS pidättää oikeuden tulkita ASUS-kaupallisen takuun ehdot.
- Tämä ASUS-kaupallinen takuu tarjotaan itsenäisesti lakisääteisten oikeudellisten takuun lisäksi eikä se vaikuta millään tavoin laillisen takuun oikeuksiin tai rajoita niitä.

Saadaksesi kaikki takuutiedot, siirry osoitteeseen <https://www.asus.com/fi/support>.

#### NW: Informasjon om ASUS-garanti

- ASUS tilbyr som produsent en frivillig kommersiell garanti.
- ASUS forbeholder seg retten til å tolke bestemmelsene i ASUS sin kommersielle garanti.
- ASUS sin kommersielle garanti gir uavhengig og i tillegg til den lovbestemte juridiske garantien, og verken påvirker eller begrenser rettighetene under den juridiske garantien på noen måte.

Du finner fullstendig informasjon om garanti på <https://www.asus.com/no/support/>.

#### SB: Informacije o ASUS garanciji

- ASUS nudi dobrovoljno proizvođačku komercijalnu garanciju.
- ASUS zadržava pravo da tumači odredbe svoje ASUS komercijalne garancije.
- Ova ASUS komercijalna garancija daje se nezavisno, kao dodatak zakonskoj pravnoj garanciji, i ni ka koji način ne utiče na i ne ograničava prava data pravnom garancijom.

Za sve informacije o garanciji, posetite <https://www.asus.com/support/>.

#### SW: ASUS garantiinformasjon

- ASUS erbjuder en frivillig kommersiell tillverkninggaranti.
- ASUS förbehåller sig rätten att tolka bestämmelserna i ASUS kommersiella garanti.
- Denna kommersiella garanti från ASUS tillhandahålls separat och som tillägg till den lagstadgade garantin, och påverkar eller begränsar på intet sätt rättsigheterna under den lagstadgade garantin.

För all garantiinformation, besök <https://www.asus.com/se/support/>.

#### UA: Інформація про Гарантію ASUS

- ASUS пропонує добровільну Комерційну Гарантію виробника.
- ASUS застерігає за собою право тлумачити положення Комерційної Гарантії ASUS.
- Цю Комерційну Гарантію надано незалежно і на додаток до обов'язкової Законної Гарантії; вона жодним чином не впливає на права за Законовою Гарантією і не обмежує їх.

Всю інформацію про гарантію подано тут: <https://www.asus.com/ua/support>.

#### MX: Garantía y Soporte

Esta Garantía aplica en el país de compra. Usted acepta que en esta garantía:

- Los procedimientos de servicio pueden variar en función del país.
- Algunos servicios y/o piezas de reemplazo pueden no estar disponibles en todos los países.
- Algunos países pueden tener tarifas y restricciones que se apliquen en el momento de realizar el servicio, visite el sitio de soporte de ASUS en <https://www.asus.com/mx/support/> para ver más detalles.
- Si tiene alguna queja o necesidad de un centro de reparación local o el periodo de garantía del producto ASUS, por favor visite el sitio de Soporte de ASUS en <https://www.asus.com/mx/support/> para mayores detalles.

#### Información de contacto ASUS

Esta garantía está respaldada por:  
ASUSTeK Computer Inc.  
Centro de Atención ASUS +52 (55) 1496-3663

#### BP: Informações de garantia ASUS

Esta garantia aplica-se ao período definido pela garantia legal (90 dias) mais o período de garantia comercial oferecido pela ASUS. Por exemplo: 12M significa 12 meses de garantia no total (3 meses de garantia legal mais 9 meses de garantia contratual), 24 meses significa 24 meses de garantia no total (3 meses de garantia legal mais 21 meses de garantia contratual) e 36 meses significa 36 meses de garantia no total (3 meses de garantia legal e 33 de garantia contratual) a contar da data da garantia declarada (Data de Início da Garantia).

Para todas as informações de garantia, visite <https://www.asus.com/br/br/support/>.

#### ID: Informasi Garansi ASUS

Garansi ini berlaku di negara tempat pembelian.

Periode Garansi tertera pada kemasan/kotak dari Produk dan Masa Garansi dimulai sejak tanggal pembelian Produk ASUS dengan kondisi baru.

Silahkan pindai Kode QR di bagian bawah halaman terakhir untuk Kartu Garansi versi Web dalam format PDF untuk lebih informasi jelas mengenai jaminan garansi Produk ASUS.

- Informasi Dukungan ASUS, silakan kunjungi <https://www.asus.com/id/support>.
- Informasi Lokasi Layanan, silakan kunjungi <https://www.asus.com/id/support/Service.Center/Indonesia>.
- Layanan Call Center: 1500128

#### Vì: Thông tin đảm bảo của ASUS

- ASUS cung cấp Bảo hành thương mại tự nguyện của nhà sản xuất.
- ASUS bảo lưu quyền giải thích các điều khoản của Bảo hành thương mại của ASUS.
- Bảo hành thương mại này của ASUS được cung cấp độc lập và ngoài Bảo đảm pháp lý theo luật định và không có cách nào hình thành nên hoặc giới hạn các quyền theo Bảo lãnh pháp lý.

Để biết tất cả các thông tin bảo hành, vui lòng truy cập <https://www.asus.com/vn/support>.





## **ASUS contact information**

### **ASUSTeK COMPUTER INC.**

Address: 1F., No. 15, Lide Rd., Beitou Dist., Taipei City 112, Taiwan

### **ASUS COMPUTER INTERNATIONAL (America)**

Address: 48720 Kato Rd., Fremont, CA 94538, USA

### **ASUS COMPUTER GmbH (Germany and Austria)**

Address: Harkortstrasse 21-23, 40880 Ratingen, Germany

### **ASUSTeK (UK) LIMITED**

Address: 1st Floor, Sackville House, 143-149 Fenchurch Street, London, EC3M 6BL,  
England, United Kingdom

## **Service and Support**

Visit our multi-language website at <https://www.asus.com/support>.

