



Questo manuale d'istruzione è fornito da trovaprezzi.it. Scopri tutte le offerte per [Apple iPhone SE 2022 5G Ricondizionato 64GB](#) o cerca il tuo prodotto tra le [migliori offerte di Ricondizionati Telefonia e Smartphone](#)



Questo manuale d'istruzione è fornito da trovaprezzi.it. Scopri tutte le offerte per [Apple iPhone SE 2022 5G 64GB](#) o cerca il tuo prodotto tra le [migliori offerte di Cellulari e Smartphone](#)



iPhone SE (3rd generation)

Repair Manual

Contents

3 [Introduction](#)

Basics

6 [Internal View](#)
7 [Orderable Parts](#)
8 [Screws](#)
9 [Tools](#)

Safety

12 [Battery Safety](#)
15 [Broken Glass](#)

Procedures

17 [First Steps](#)
18 [SIM Tray](#)
19 [Display](#)
41 [Camera](#)
47 [Taptic Engine](#)
60 [Battery](#)
71 [Speaker](#)

Introduction

This manual includes technical instructions for replacing genuine Apple parts in iPhone and is intended for individual technicians with the knowledge, experience, and tools required to repair electronic devices.

Important

- Read the entire manual first. If you're not comfortable performing the repairs as instructed in this manual, don't proceed.
- Always use the latest version of this document available at support.apple.com/manuals/repair+manual.



Warning

- Failure to follow the repair instructions or to use genuine Apple parts or proper tools may cause fire or other safety issues and lead to personal injury or death.
- iPhone 7 and later are classified as Class 1 Laser products per IEC 60825-1 Ed. 3. These devices comply with 21 CFR 1040.10 and 1040.11, except for conformance with IEC 60825-1 Ed. 3., as described in Laser Notice No. 56, dated May 8, 2019. These devices contain one or more lasers. Use other than as described in the user guide, repair, or disassembly may cause damage, which could result in hazardous exposure to infrared laser emissions that are not visible.



Caution

Failure to follow the repair instructions or to use genuine Apple parts or proper tools may damage the iPhone, parts, or other property, or compromise the device's functionality or water resistance.

Warranty information

Damage caused by repairs performed outside of Apple or the Apple Authorized Service network is not covered by Apple's warranty or AppleCare plans. Such damage may cause future repairs to be subject to out-of-warranty costs or render the device ineligible for future repairs by Apple or Apple Authorized Service Providers.

Tools and parts

Hardware tools

Apple tools are designed to apply the appropriate heat, force, and torque during repairs, and to withstand high-volume professional use.

- The display press applies the appropriate amount of pressure to secure new adhesive during display installation. The display press is used with a repair tray designed for the device's specific dimensions.
- The battery press applies the appropriate amount of pressure to secure new adhesive during battery installation. The battery press is used with a repair tray designed for the device's specific dimensions.

Ordering tools and parts

You can learn how to order genuine Apple parts and tools at support.apple.com/self-service-repair. During the purchase process, enter the manual ID **GPCNKY** to indicate that you've read this manual in its entirety and agree that you have the knowledge and experience to perform your intended repair.

Software tools

A System Configuration step may be required at the end of your repair. System Configuration is a postrepair software tool that completes the repair for genuine Apple parts. Running System Configuration has a number of purposes that vary based on the part replaced.

What System Configuration does	Why it's important
Transfers factory calibration values	Certain parts like displays, cameras, and ambient light sensors have calibration values that are customized to each individual part during manufacturing. Transferring these values ensures maximum performance and quality after a repair.
Links Secure Element and biometric authentication parts	After repair of a logic board or a biometric authentication part (Touch ID or Face ID), linking the biometric sensors to the Secure Enclave on the logic board is required to ensure device security.
Ensures repair integrity	After a hardware repair, software checks are performed to ensure repair integrity. Repair integrity means that a genuine Apple part has been correctly installed.
Assigns wireless region	To comply with regional communications regulations, a wireless region must be assigned to your logic board.
Updates firmware	Keeping firmware up to date ensures that the device has all the latest security and performance features.

System Configuration requires a strong Wi-Fi network capable of 1.0 Mbps download and upload speeds, with less than 400 ms latency and less than 2% packet loss. Estimated data usage to run System Configuration is 6–22 MB.

The device must be running the latest version of iOS and not a beta version.

Learn how to initiate the System Configuration process at support.apple.com/self-service-repair.

Alerts

Failure to follow alerts could result in fire, injury, data loss, or damage to the device, parts, or other property.



Warning

Instructions for reducing risk of personal injury



Caution

Instructions for reducing risk of data loss or device hardware damage

Important

Supplemental information for successfully completing procedures; neither a Warning nor a Caution

Internal View

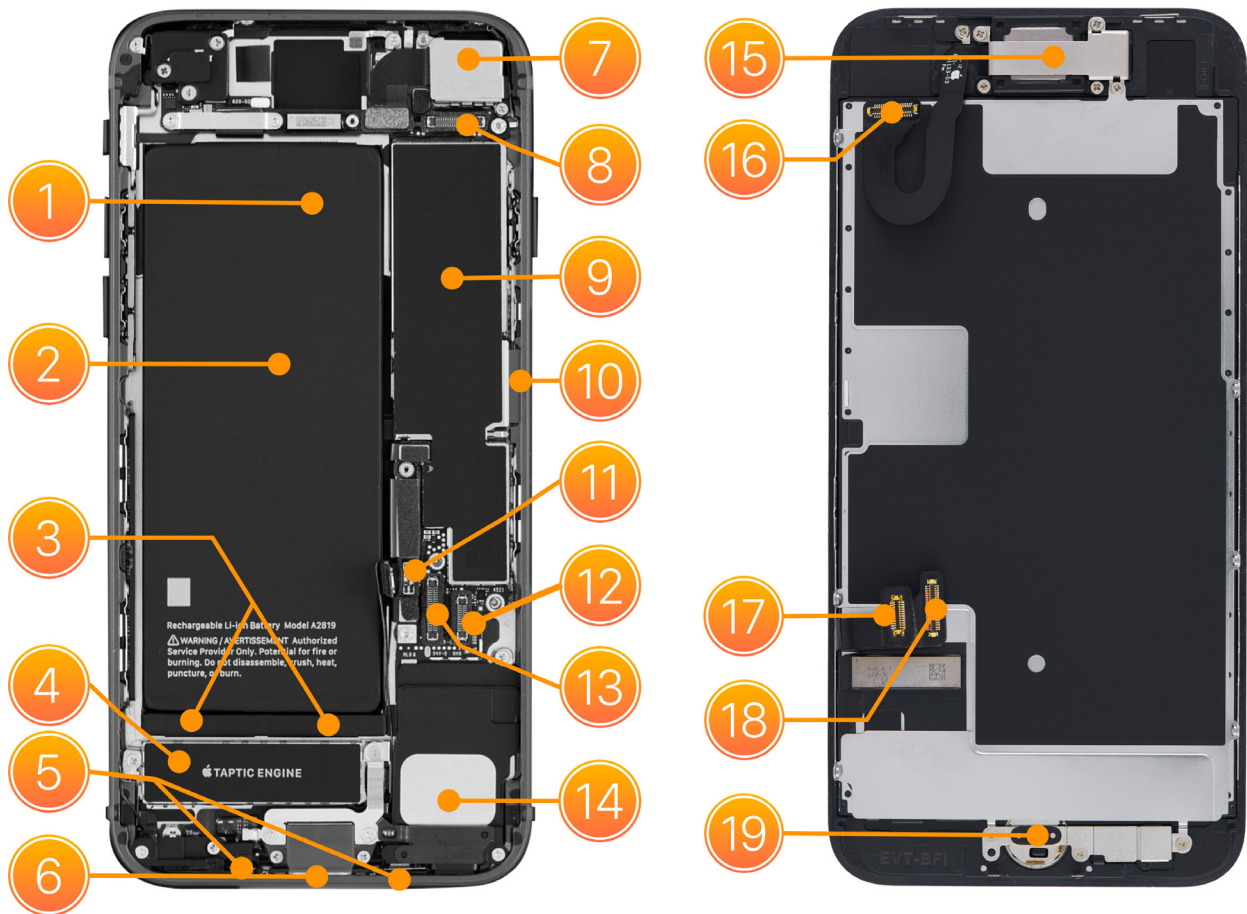

- | | |
|--------------------------------------------------------------------------------------------------------------------------------------------------------------------------------------------------------------------------------------------------------------------------------------------------------------------------------------------------------------------------------|------------------------------------------------------------------------------------------------------------------------------------------------------------------------------------------------------------------------------------------------------------------------------------------------------------------------------------------------------------------------------------------------------------------------------------|
| <ol style="list-style-type: none"> 1. Top battery adhesive tabs 2. Battery 3. Bottom battery adhesive tabs 4. Taptic Engine 5. Bottom microphones 6. Lightning connector 7. Camera 8. FaceTime HD camera/receiver/ambient light sensor connector 9. Logic board 10. SIM reader | <ol style="list-style-type: none"> 11. Battery connector 12. Home button/Touch ID sensor connector 13. Display/Multi-Touch connector 14. Speaker 15. Receiver 16. FaceTime HD camera/receiver/ambient light sensor flex cable 17. Home button/Touch ID sensor flex cable 18. Display/Multi-Touch flex cable 19. Home button/Touch ID sensor |
|--------------------------------------------------------------------------------------------------------------------------------------------------------------------------------------------------------------------------------------------------------------------------------------------------------------------------------------------------------------------------------|------------------------------------------------------------------------------------------------------------------------------------------------------------------------------------------------------------------------------------------------------------------------------------------------------------------------------------------------------------------------------------------------------------------------------------|

Orderable Parts

Name	Numbers	Screws
Battery	661-25890	—
Battery/display connector cowling	923-01988	923-01989 (2) upper left, lower left 923-01990 (2) middle, lower right
Camera	661-25683	—
Camera connector cowling	923-04091	923-01986 (3)
Camera cowling	923-07178	923-01987 (1) upper left (super screw) 923-02006 (1) lower right
Display	661-26353 LL661-26353 (U.S.)	—
Display adhesive	923-02012	—
Grounding clip	923-04230	—
Security screws	—	923-02005 (2) midnight 923-02007 (2) red, starlight
SIM tray	923-07314 midnight 923-07315 starlight 923-07316 red	—
Speaker	923-07174	923-04083 (1) lower right 923-04084 (1) left (super screw) 923-04085 (1) upper right
Taptic Engine	923-07176	923-04090 (1) left 923-01994 (1) right (super screw)
Taptic Engine connector cowling	923-07177	923-01993 (1) top 923-01995 (1) lower right 923-01996 (1) lower left

Screws

Warning

- Never reinstall a screw after it has been removed. Install only new screws. iPhone screw grooves are covered in adhesive that can't be reused.
- Use only the torque driver indicated to install new screws during reassembly. Both overtightened screws and loose screws can damage parts.

Note: You can use any torque driver to remove screws.



Torque driver (black, 0.35 kgf cm)
Torque driver (blue, 0.65 kgf cm)
Torque driver (green, 0.45 kgf cm)

- Crosshead screw
- Super screw*
- Trilobe screw
- Security screw

- Single screw
- Screw with super screw underneath

*A super screw has a threaded hole that holds another screw.

Tools

Tools with part numbers are available for purchase from the Self Service Repair Store. Tools without part numbers can be purchased from electronics supply retailers.

923-02231
4.7-inch back protective cover



923-01094
4.7-inch display protective cover



923-02836
4.7-inch repair tray



923-01924
4.7-inch support frame



923-01915
Adhesive cutter



923-01916
Adhesive cutter replacement wheel



923-02657
Battery press

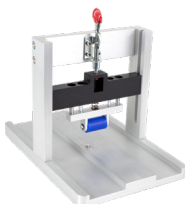

Cut-resistant gloves



661-08916
Display press



ESD mat

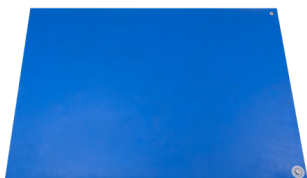

ESD-safe cleaning solution



ESD-safe tweezers



ESD wrist strap with clip or plug



Ethanol wipes¹



Heat-resistant gloves



IPA wipes



923-01290
Micro stix[®] bit



Nitrile or lint-free gloves



922-5065
Nylon probe (black stick)







Safety glasses with side shields



Sand²



<p>Sand container³</p> 	<p>923-02066 Super screw bit</p> 	<p>923-0248 Torque driver (black, 0.35 kgf cm) kit⁴</p> 
<p>923-0448 Torque driver (blue, 0.65 kgf cm)</p> 	<p>923-00105 Torque driver (green, 0.45 kgf cm)</p> 	<p>UDO923 Universal display removal fixture⁵</p> 

¹ Ethanol wipes must contain at least 90% ethanol and no additives except isopropyl alcohol.

² Clean, dry, untreated sand (8–10 cups)

³ Sand container (wide-mouthed, quick pour, nonbreakable plastic container with a flip-top lid)

⁴ The black torque driver kit includes a black torque driver (0.35 kgf cm), Torx® security bit (923-0247), and JCIS bit (923-0246).

⁵ The universal display removal fixture (UDO923) includes both the universal display removal fixture (923-01385) and universal display removal adapter (923-00652).

Battery Safety

Warning

- This device contains a built-in lithium-ion rechargeable battery with soft battery cells. Battery safety is the number one concern when repairing a device with a built-in lithium-ion battery.
- Only technicians with the knowledge, experience, and tools required to repair electronic devices should replace a battery.
- Improper battery replacement, improper handling of parts, failure to discharge the battery before repair, or failure to follow the provided instructions could cause battery overheating, swelling, venting, leaking, or a battery thermal event. These events could result in fire, injury, death, data loss, or damage to the device, parts, or other property.
- To avoid these potentially harmful events, follow the battery safety guidelines and work in a safety-focused workspace with the tools listed below. It's important to be prepared for all possible outcomes.

How to set up a workspace for battery safety

Tools

- Clean, dry, untreated sand (8–10 cups)
- Sand container (wide-mouthed, quick pour, nonbreakable plastic container with a flip-top lid)
- Heat-resistant gloves
- Safety glasses with side shields
- ESD-safe cleaning solution

Workspaces used to repair Apple devices should meet the following criteria:

- Nonflammable and electrostatic discharge (ESD)-safe work bench
- At least 2 feet away from paper and other combustible materials
- Sand container within reach (2 feet) on both sides of the workspace, not above the workspace
- Adequate ventilation



How to handle a battery thermal event

A battery thermal event is a rapid chemical chain reaction that occurs inside a battery cell. The energy stored in the battery is released suddenly, which can cause outgassing and fire. A battery thermal event can be triggered by physical damage to the battery, improper replacement or repair, or temperatures outside the battery's operating range.

Act immediately if you notice any of the following signs of a battery thermal event:

- The lithium-ion battery or a device that contains one begins to smoke or emit sparks or soot.
- The battery pouch suddenly and quickly puffs out.
- The lithium-ion battery or a device that contains one begins to emit hissing or popping sounds.

Don't use water or an ABC or carbon dioxide fire extinguisher on a battery thermal event or a device that is undergoing one. Water and ABC or carbon dioxide fire extinguishers won't stop the reaction.

Do smother the battery or device immediately with plenty of clean, dry sand. Dump the sand all at once. Timing is critical — the faster you pour all the sand, the sooner the reaction will be contained.

Do contact local fire authorities if further assistance is needed.

Do leave the room for 30 minutes after the reaction is contained. Ventilate the area. Don't return until the area is clear of smoke.

Do wait 30 minutes before touching the device. Wear the heat-resistant gloves and safety glasses with side shields to remove the device from the sand.

Do wipe the affected area with water first. Then wipe the area with an ESD-safe cleaning solution.

Do dispose of the damaged battery or device (including any debris removed from the sand) according to local environmental laws and guidelines.

How to handle batteries

Warning

Fully discharge the battery before you begin a repair. A discharged battery is less susceptible to a battery thermal event. If you can't determine the battery level, don't repair the device.

Perform the following steps to discharge the battery:

- Disconnect all external cables.
- Remove all cases and covers.
- Turn on the flashlight from the Lock Screen, in Control Center, or by asking Siri. Wait until the device has turned off and the flashlight is no longer illuminated.

Caution

The flashlight produces heat. Keep the iPhone in a well-ventilated area while the flashlight is illuminated.

Best practices

- To avoid noxious fumes or a battery thermal event, don't puncture, strike, or crush a lithium-ion battery or a device that contains one.
- Keep your workspace clear of foreign objects and sharp materials.
- Be careful when using sharp tools near the battery.
- Don't leave loose screws, extra screws, or small parts inside the device.
- Don't use tools that conduct electricity.
- Don't throw or drop the battery.
- Don't expose the battery to excessive heat or sunlight, or temperatures outside the battery's operating range.
- Handle and dispose of waste batteries in accordance with local laws and regulations.

Broken Glass

Warning

iPhone displays and some back covers are made of glass. The glass could break if the iPhone is dropped on a hard surface, receives a substantial impact, or is crushed, bent, or deformed. Don't attempt to remove chipped or cracked glass shards.

Tools

- Back protective cover
- Cut-resistant gloves
- Display protective cover
- Safety glasses with side shields
- Support frame
- Vacuum cleaner

If the iPhone glass is broken, perform the following steps before you begin a repair:

1. Put on safety glasses with side shields and the cut-resistant gloves.
2. Use a vacuum cleaner to remove glass pieces from your workspace and the iPhone.
3. Attach a protective cover to the broken glass to prevent injury or scattering of glass. Each protective cover has a release liner underneath. Slowly pull the release liner out from under the protective cover while pressing the cover onto the enclosure.
4. Fold the release liner. Use the shiny side of the release liner to firmly press the protective cover onto the broken glass and smooth out any air bubbles.



5. Wait at least 12 minutes for the bond between the protective cover and the glass to strengthen.
6. If the back glass is broken, place the iPhone into the support frame.

If the iPhone has any of the following conditions, stop the repair:

- There's no glass or insufficient glass for the protective cover to adhere to.
- The protective cover doesn't adhere to the iPhone.
- The iPhone doesn't fit in the support frame.

You can find a service option at support.apple.com/repair.

First Steps

Always perform the following steps before starting a repair:

- [Back up the iPhone.](#)
- [Discharge the battery fully.](#)
- [Turn off the iPhone.](#)
- Disconnect all cables.
- Remove all cases and covers.
- Clear and clean your workspace.
- Put on an ESD wrist strap and attach it to a properly grounded ESD mat.



Caution

ESD (electrostatic discharge, or the release of static electricity) can damage electronic components.

Be aware of the following while performing a repair:

- The manual for this model may show images of other models, but the procedures are the same. Ensure that you use the correct tools for the model you're repairing.
- Take your time. Thoroughly read all instructions and alerts.
- Magnetizing the torque drivers will make it easier to work with small screws.
- The end of each flex cable must align with its connector. Press the end of each flex cable to its connector until it clicks to ensure that it's secure.



Warning

Loose screws, extra screws, or small parts inside the device can damage the battery and cause safety issues. Set aside all parts and screws removed during the repair and account for them at the end of the repair.

SIM Tray

Tools

- SIM-eject tool or paper clip

Removal

1. [Find your model to locate the SIM tray.](#)
2. Insert a paper clip or SIM-eject tool into the hole next to the SIM tray.
3. Push the paper clip or SIM-eject tool toward the enclosure to eject the SIM tray.
4. Remove the SIM tray.

Reassembly

1. Press the SIM tray back into the side of the enclosure.

Display

Before You Begin

Warning

- Read [Battery Safety](#) and follow workspace and battery handling guidelines before you begin.
- Read [Broken Glass](#) before you begin.

Tools

- 4.7-inch repair tray
- Adhesive cutter
- Display press
- ESD-safe tweezers
- Ethanol wipes or isopropyl alcohol (IPA) wipes
- JCIS bit
- Nylon probe (black stick)
- Torque driver (black, 0.35 kgf cm)
- Torque driver (blue, 0.65 kgf cm)
- Torque driver (green, 0.45 kgf cm)
- Torx security bit
- Universal display removal adapter
- Universal display removal fixture

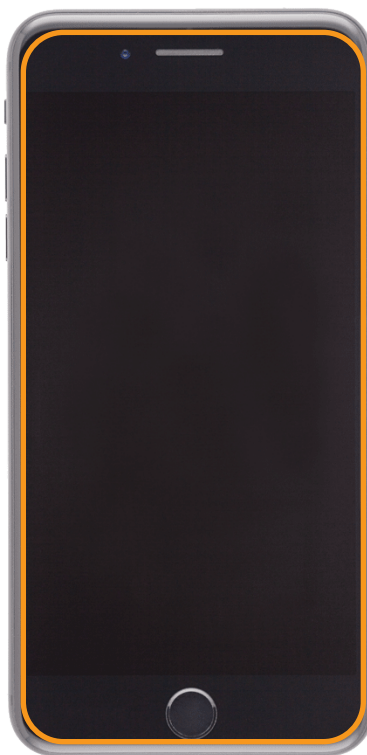

Important

This procedure requires [System Configuration](#). After you've completed all removal and reassembly steps, learn how to initiate the System Configuration process at support.apple.com/self-service-repair.

Removal

1. Use a torque driver and the Torx security bit to remove the two security screws, one from each side of the Lightning connector. Set aside the screws.
2. Fully insert the levers of the universal display removal fixture into the universal display removal adapter. Then tighten the thumb screws on the adapter.
3. Insert the iPhone into the fixture with the display faceup and the Lightning connector toward the adapter.
4. Slide the top handle to move the top suction cup as close to the Home button as you can without touching it. Slide the bottom handle to align the bottom suction cup with the top suction cup. Press the iPhone down to secure the suction cups to the enclosure.



5. Press and hold the release button on the adapter (1) to pull down the lever (2). Then flip both handles to secure the suction cups to the iPhone (3).

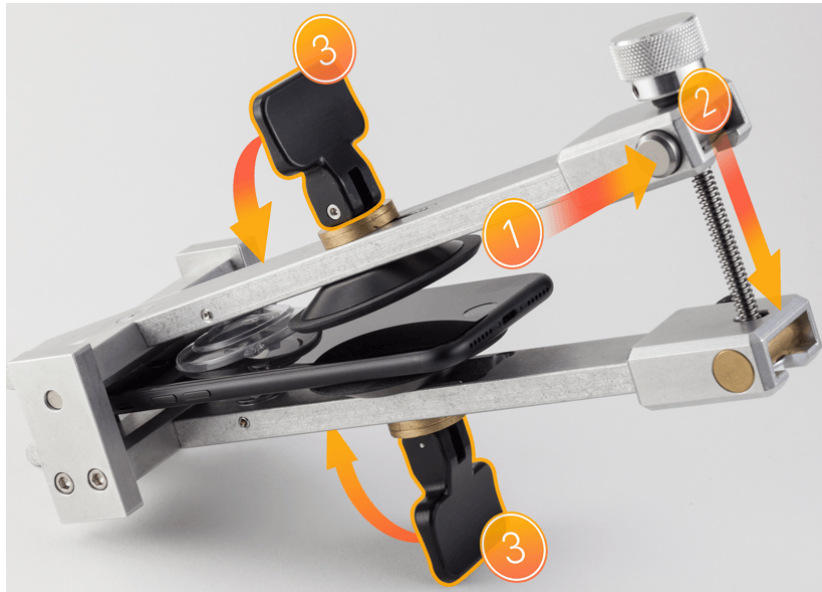

6. Press and hold the release button on the adapter and slowly separate the levers until you feel resistance.

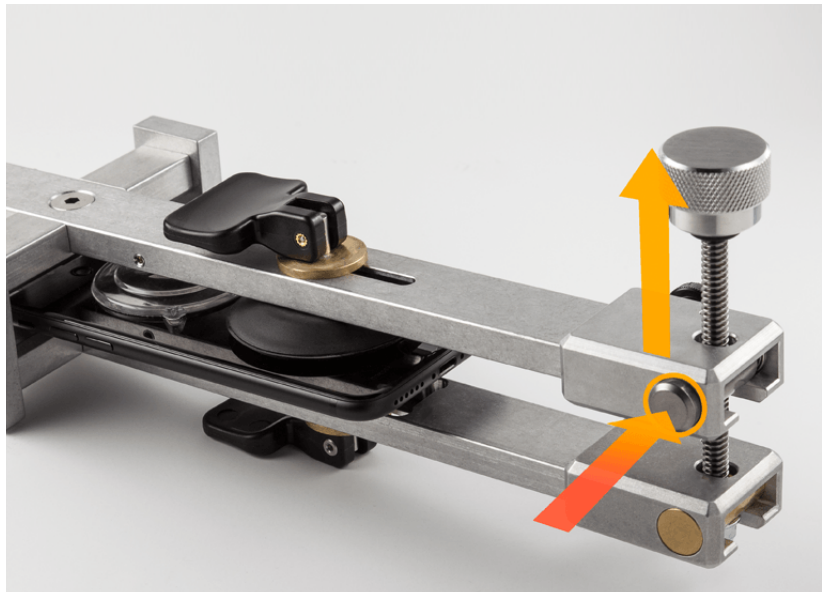

7. Slowly turn the knob on the adapter until the display begins to separate from the enclosure.

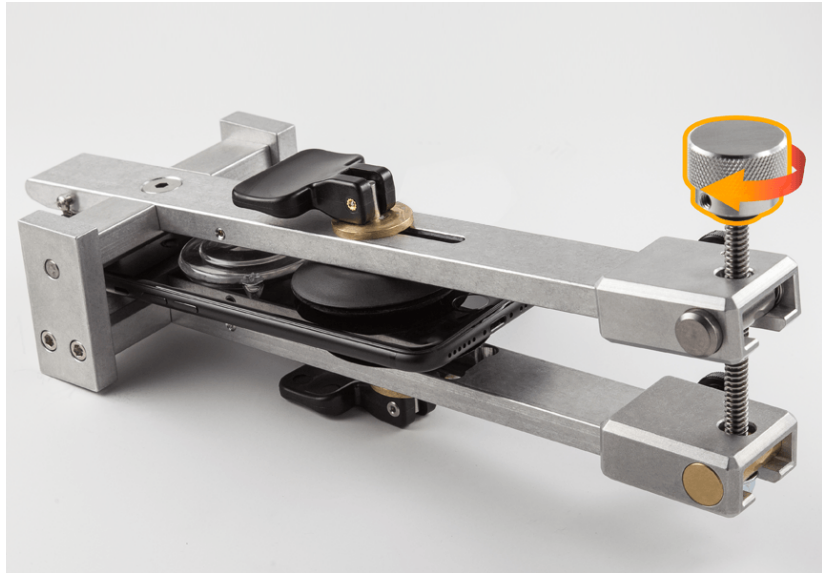

8. Insert the wheel of the adhesive cutter between the display and the enclosure. Run the cutter around the bottom and both sides of the iPhone until the display partially releases from the enclosure.

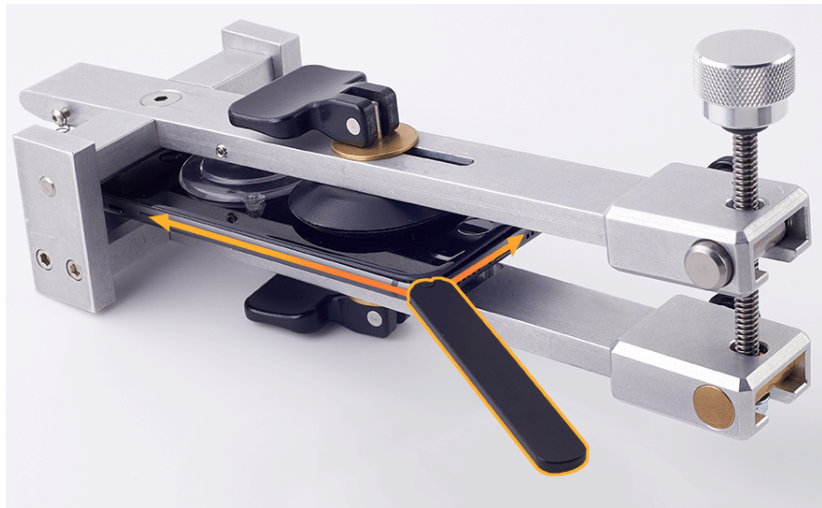

9. Press and hold the release button on the adapter to pull up the lever (1). Then flip the handles to release the two black suction cups (2). Pull the tabs on the clear suction cups to release the iPhone (3).

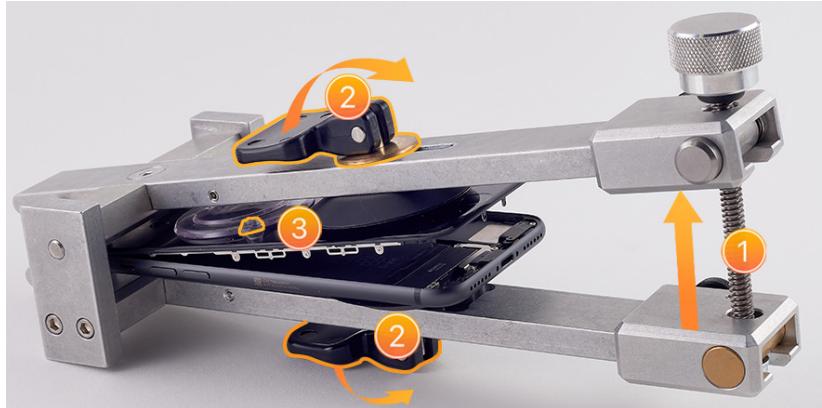

10. Remove the iPhone from the fixture and set it on a clean, flat surface.

11. Gently slide the display toward the bottom of the iPhone to release the internal display clips. Then tilt up the bottom of the display.

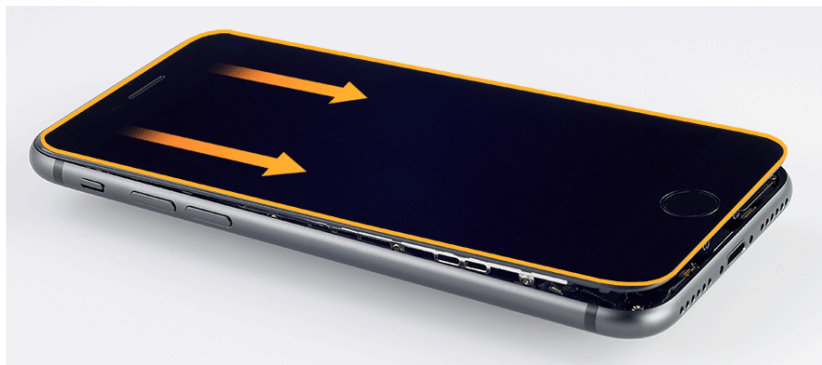

 **Caution**

Don't pry the display.

12. Insert the wheel of the adhesive cutter into the top of the iPhone between the display and the enclosure. Run the cutter around the top and sides of the iPhone until the display is free.



 **Caution**

To avoid damaging the flex cables, don't tilt up the display more than 5 degrees.



13. Tilt up the display as shown.

! **Caution**

- To avoid damaging the enclosure or display, ensure that the internal display clips are released before you tilt up the display.
- Don't damage the flex cables as you tilt up the display.

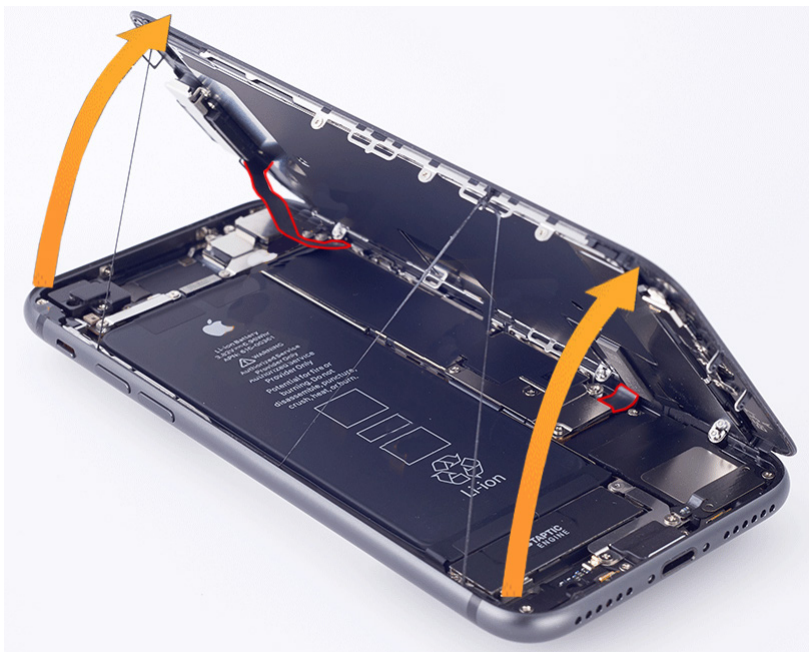

! **Warning**

If the battery is dented, punctured, or otherwise damaged, stop the repair. You can find a service option at support.apple.com/repair.

14. Insert the suction cup into the repair tray. Place the iPhone into the repair tray with the Lightning connector facing the cutout. Gently press along the edges of the display to secure it to the suction cup.



15. Use a torque driver and the JCIS bit to remove the four crosshead screws from the battery/display connector cowl. Set aside the screws.

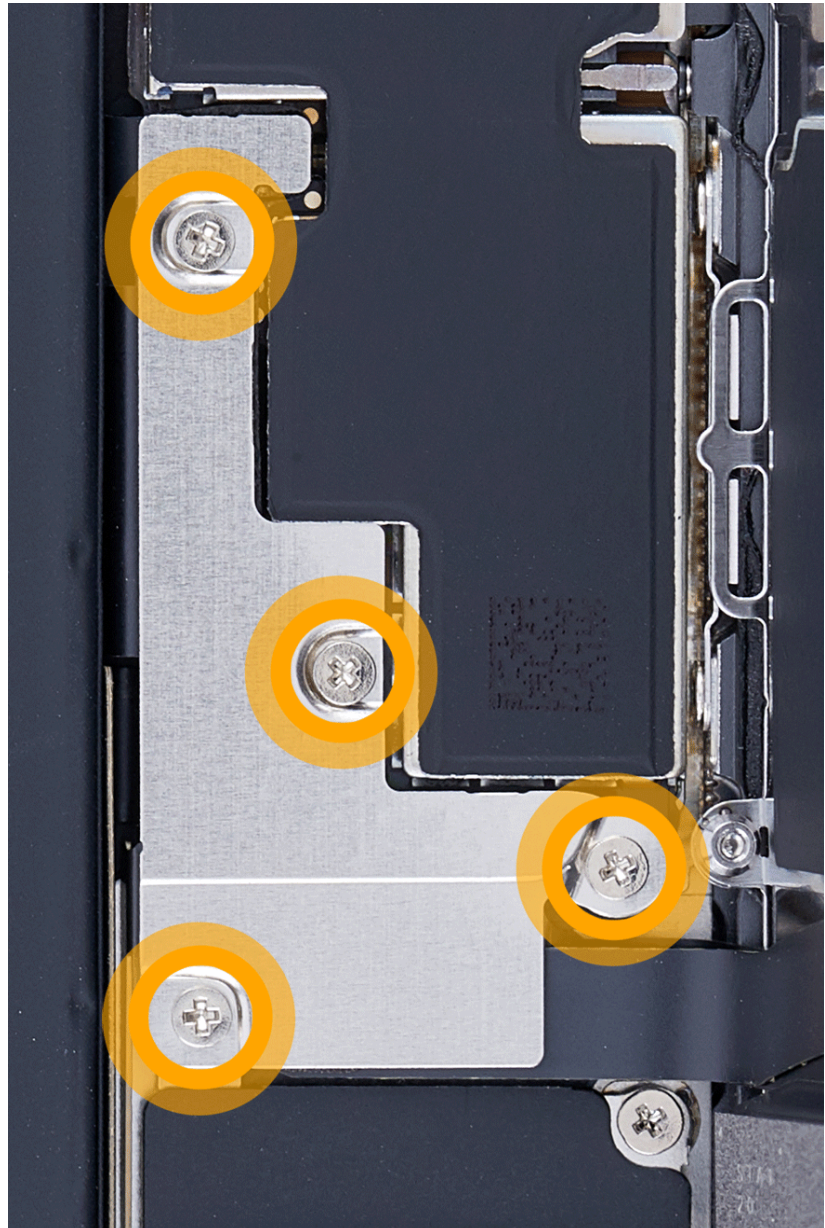

16. Remove the battery/display connector cowl and save it for reassembly.

17. Use the black stick to lift the end of the battery flex cable off the connector.

 **Caution**

You must disconnect the battery flex cable first to ensure that the iPhone remains turned off.

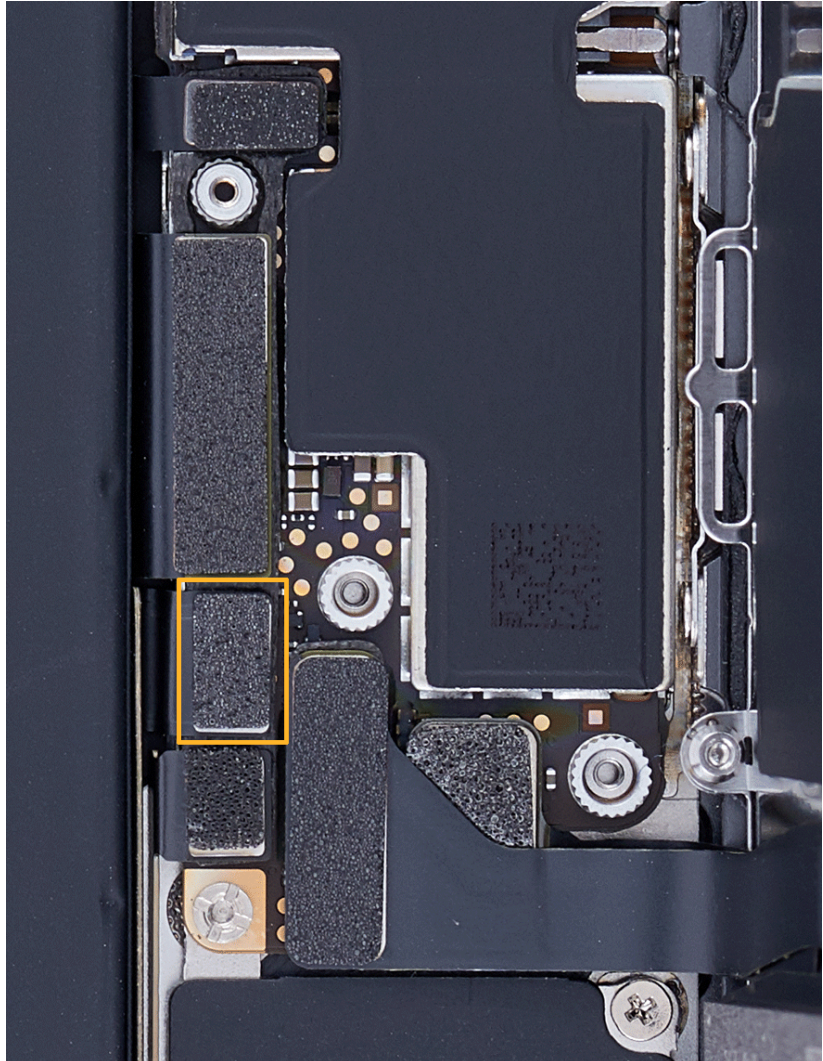

18. Use the black stick to gently lift the ends of the display flex cable (1) and Home button flex cable (2) off the connectors.

Note: The Home button flex cable lies under the display flex cable.

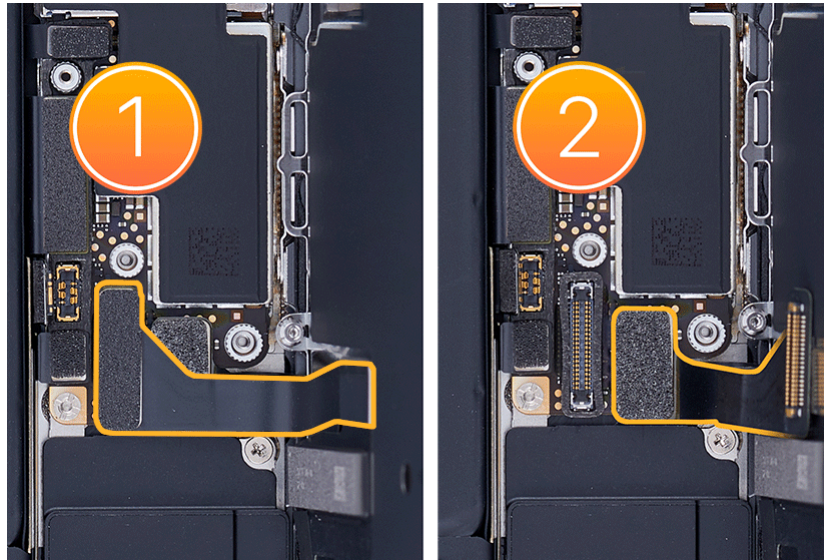

19. Use a torque driver and the JCIS bit to remove the three crosshead screws from the camera connector cowling. Set aside the screws.

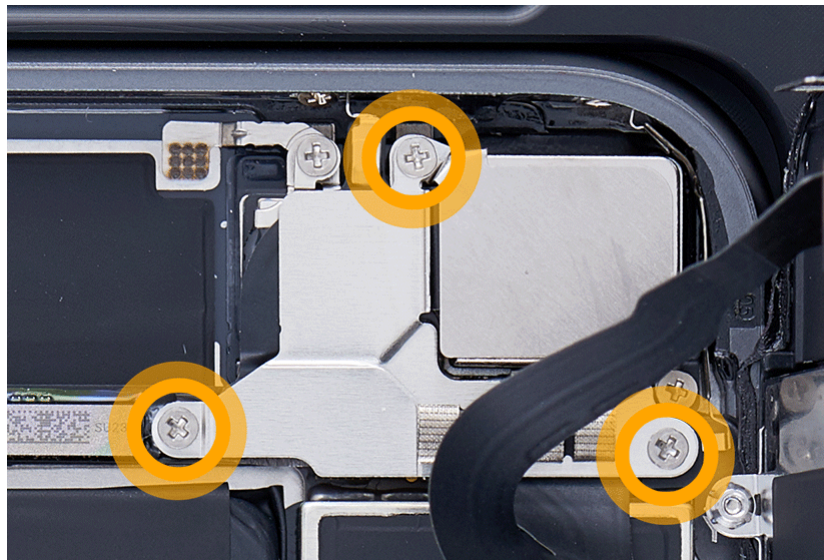

20. Remove the camera connector cowling and save it for reassembly.

21. Use the black stick to lift the end of the FaceTime HD camera flex cable off the connector.

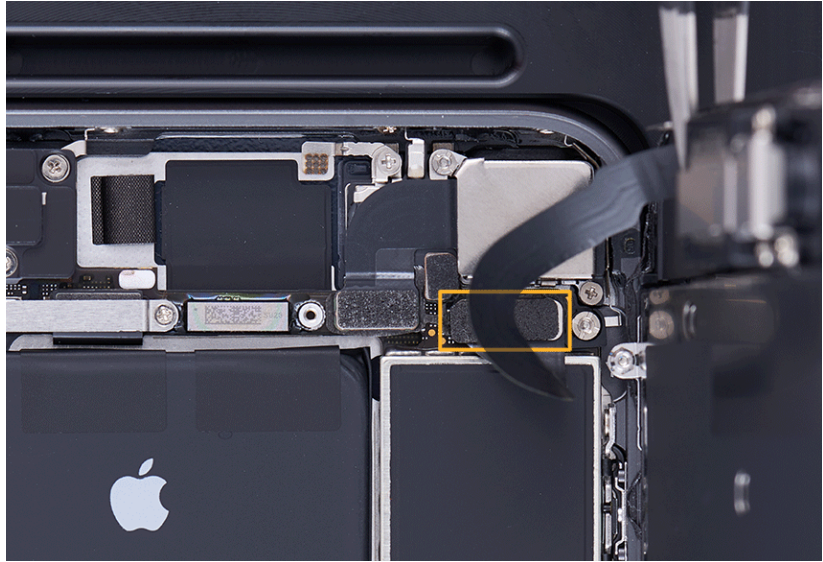

22. Hold the display by the edges. Pull the tab on the suction cup to release it from the display. Set the display facedown on a clean, flat surface.

23. Use the black stick to remove all adhesive from the display and the enclosure.



24. Use ethanol wipes or IPA wipes to clean all adhesive residue from the enclosure and display.



! **Caution**

Squeeze any excess liquid from the ethanol or IPA wipe before cleaning the display. Ensure that liquid from the wipe doesn't puddle in the corners of the display or seep under the backplate.

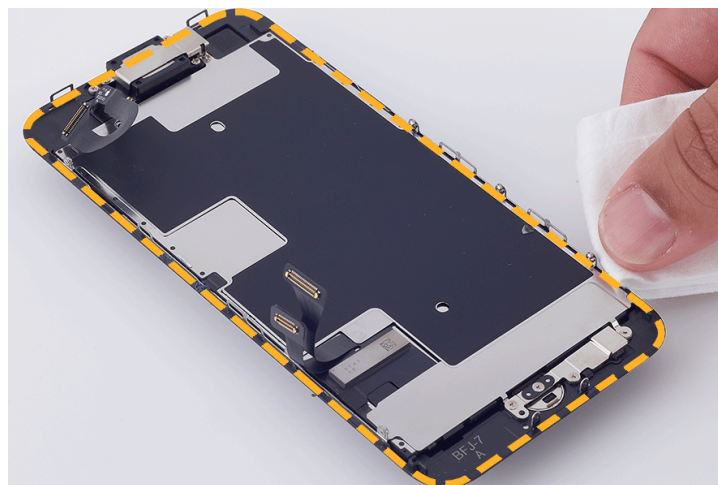
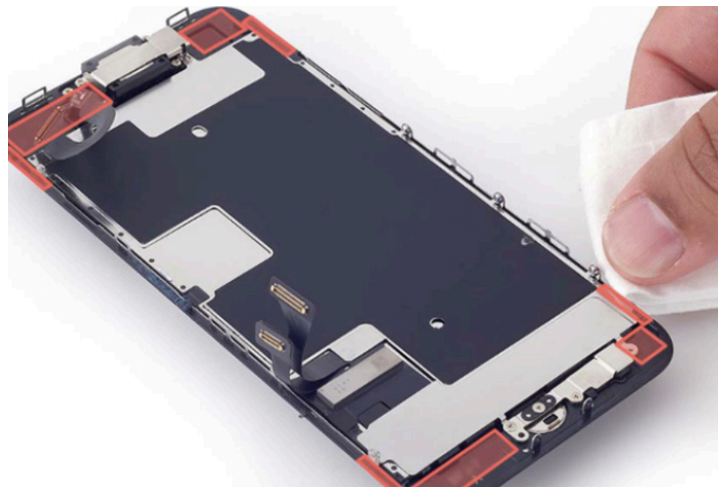

Reassembly

1. Inspect the internal display clips. Ensure that they're at a 90-degree angle and aren't bent or damaged.



Important

- If the clips are bent or damaged, you may need to replace the display.
- If you're installing a replacement display, peel the protective liner from the top and underside of it.



⚠ Warning

Inspect the enclosure for loose or extra screws and small parts, which can damage the battery and cause safety issues.

2. Align the adhesive over the enclosure with the top right hole over the camera and the bottom tab on the right.

⚠ Caution

Ensure that you've removed all adhesive residue from the display and the enclosure before you apply the replacement display adhesive.



3. The replacement display adhesive has a top release liner, a middle release liner, and a bottom release liner. Grasp the tab on the bottom release liner. Then slowly pull the bottom release liner (1) out from under the adhesive (2) while pressing the adhesive onto the enclosure.

Important

Don't remove the top release liner yet.

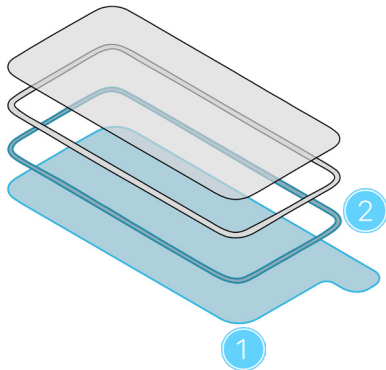

1 Bottom release liner

2 Adhesive

Note: The replacement display adhesive for your model may look different from the illustration, but the steps are the same.



4. Use the black stick to press the display adhesive onto the perimeter of the enclosure.

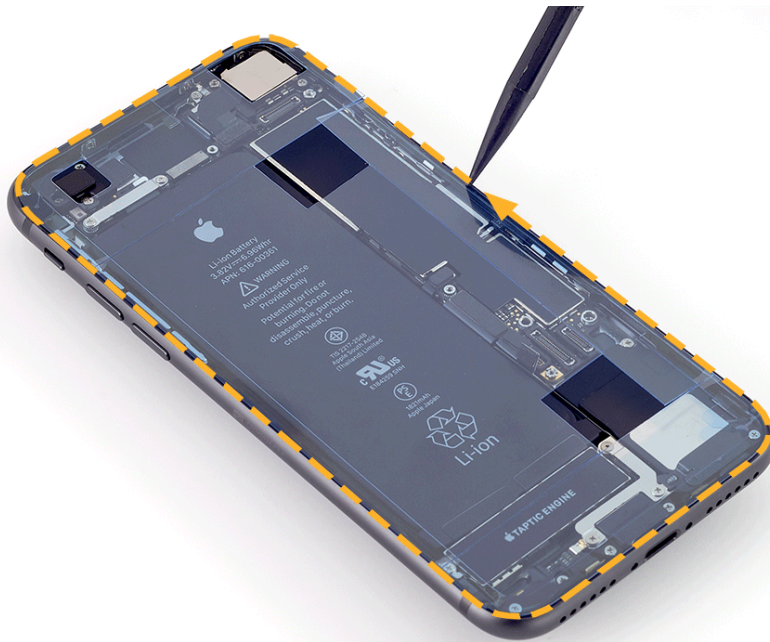

5. Remove the center section of the top release liner first (1). Then remove the three sections running along the top (2), right (3), and bottom (4).

Important

Don't remove the middle release liner yet.

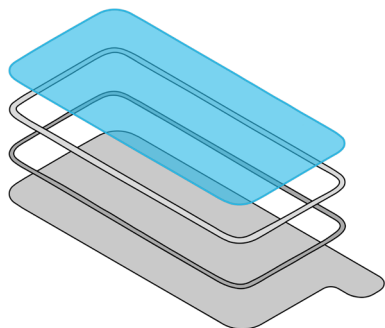

Top release liner

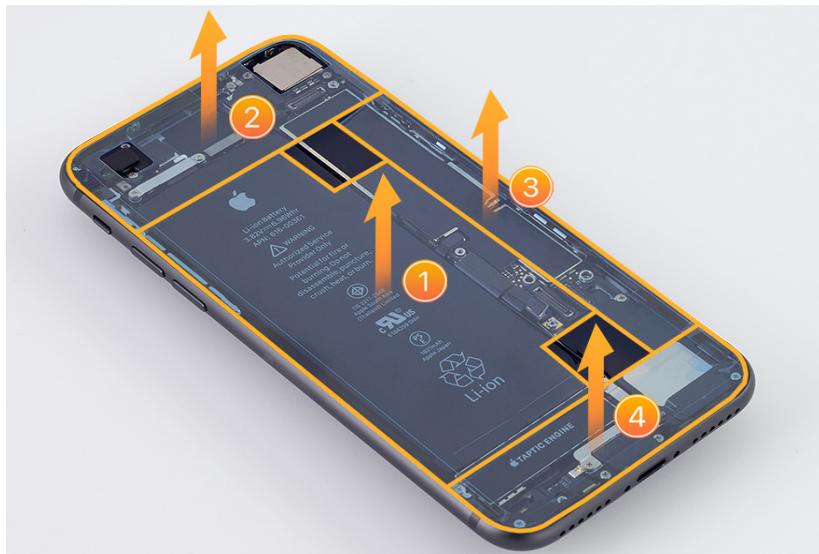

6. Place the enclosure into the repair tray with the Lightning connector facing the cutout.

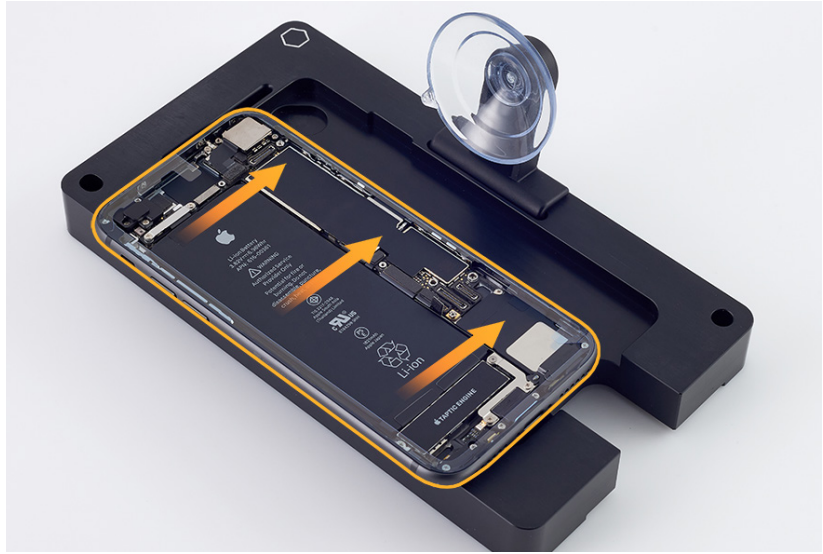

7. Align the right edge of the display with the right edge of the enclosure. Hold the display by the edges and gently press it to the suction cup.

8. Gently press the end of the FaceTime HD camera flex cable to the connector. Press evenly along the length of the connector.

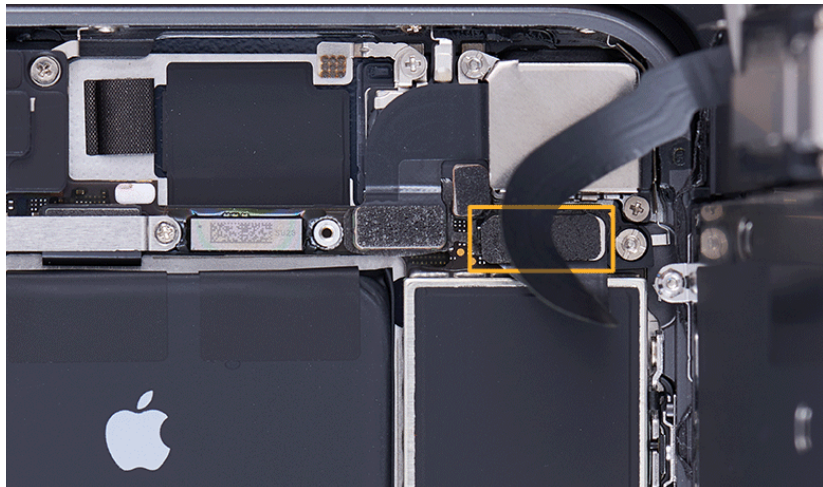

9. Position the camera connector cowling over the ends of the flex cables.

10. Use the black torque driver and JCIS bit to install three new crosshead screws into the camera connector cowling.

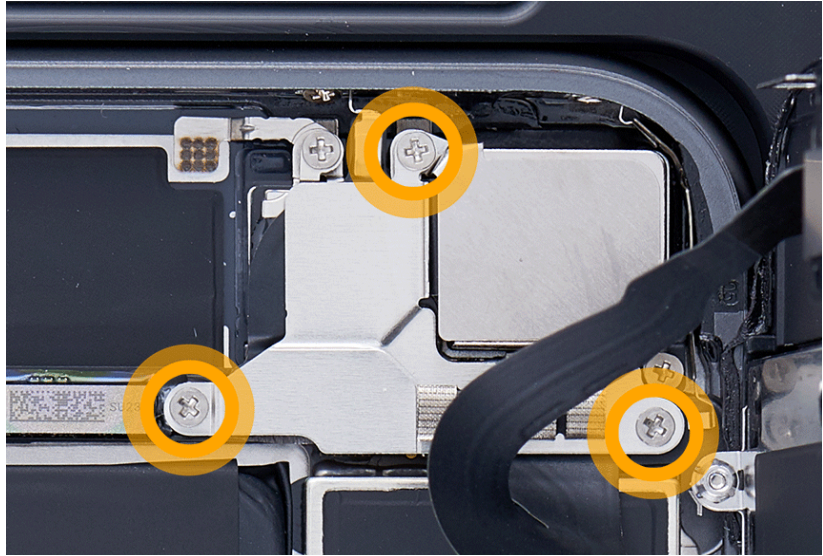

11. Gently press the ends of the Home button flex cable (1) and display flex cable (2) to the connectors. Press evenly along the length of each connector.

Note: The display flex cable covers the Home button flex cable.

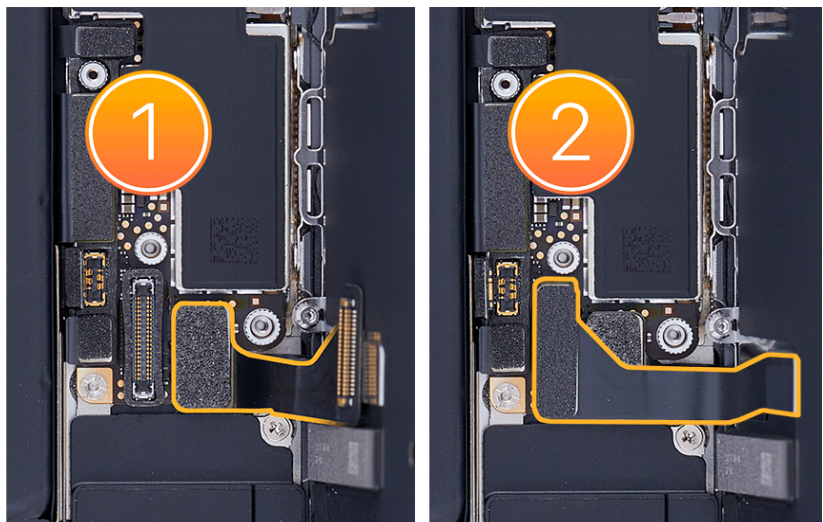

12. Press the end of the battery flex cable to the connector.



13. Position the battery/display connector cowling over the ends of the flex cables.

14. Use the green torque driver and JCIS bit to install four new crosshead screws into the battery/display connector cowling.

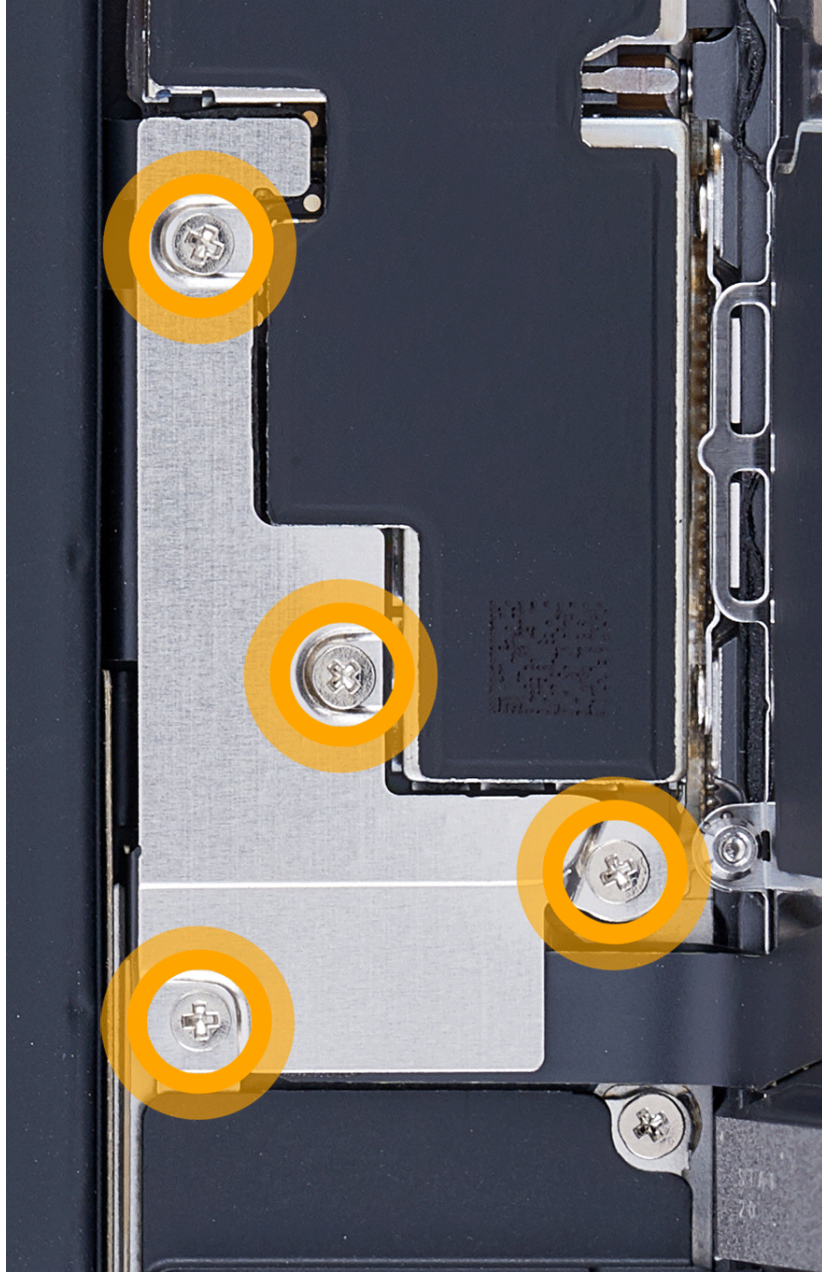

15. Peel the left strip of the middle release liner counterclockwise starting near the camera at the top of the enclosure.

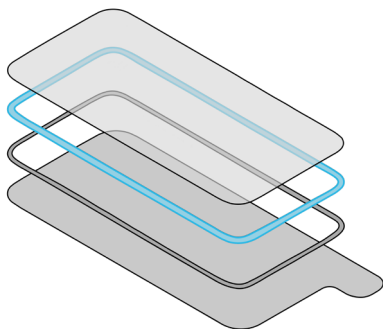

Middle release liner

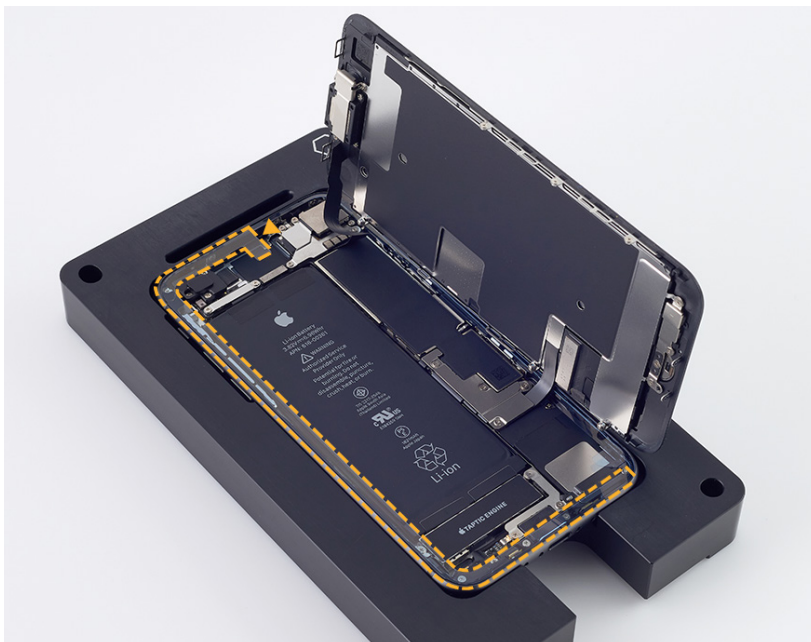

16. Hold the display by the edges. Pull the tab on the suction cup to release it from the display. Remove the suction cup from the repair tray.

Warning

Inspect the enclosure for loose or extra screws and small parts, which can damage the battery and cause safety issues.

17. Rest the internal display clips on the enclosure, leaving a slight gap between the display and the enclosure. Peel the right strip of the middle release liner counterclockwise starting near the speaker at the bottom of the enclosure.

Caution

Don't let the display touch the exposed adhesive.



18. Inspect the display adhesive to ensure that it's in the correct position and not damaged or wrinkled. If the adhesive is damaged, remove it and apply replacement adhesive.

19. Press the four corners of the display as shown. Then press along the edges until you hear a click and the display is flush with the enclosure.

 **Caution**

Ensure that the flex cables aren't trapped between the display and the enclosure.

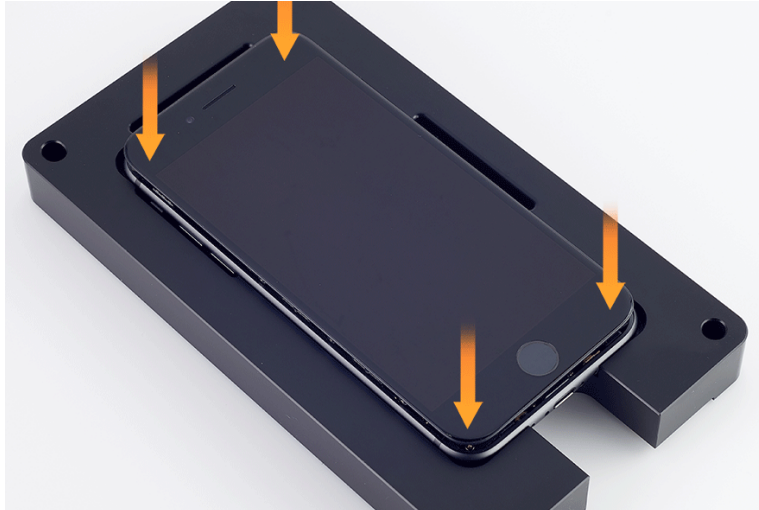

20. Place the repair tray and iPhone into the display press. Pull down the lever until the display press locks.



21. Wait until the timer on the display press beeps. Then hold down the lever (1), pull out the release knob (2), and lift up the lever (3).

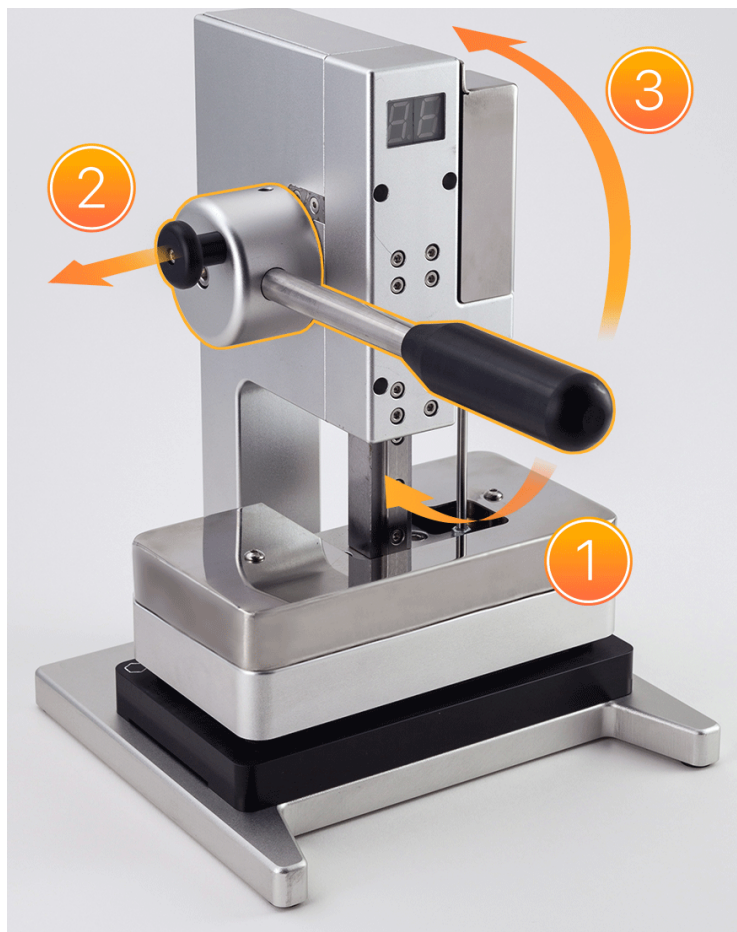

22. Remove the iPhone from the display press and the repair tray.

23. Use the blue torque driver and Torx security bit to install two new security screws, one on each side of the Lightning connector.



Important

- System Configuration is required if you've installed a replacement display or battery. Disregard notifications about iPhone features on the Lock Screen until you complete System Configuration.
- After you've completed all removal and reassembly steps, learn how to initiate the System Configuration process at support.apple.com/self-service-repair.

Camera

Before You Begin

Warning

Read [Battery Safety](#) and follow workspace and battery handling guidelines before you begin.

Remove the following part before you begin:

- [Display](#)

Tools

- ESD-safe tweezers
- JCIS bit
- Nitrile or lint-free gloves
- Nylon probe (black stick)
- Super screw bit
- Torque driver (green, 0.45 kgf cm)

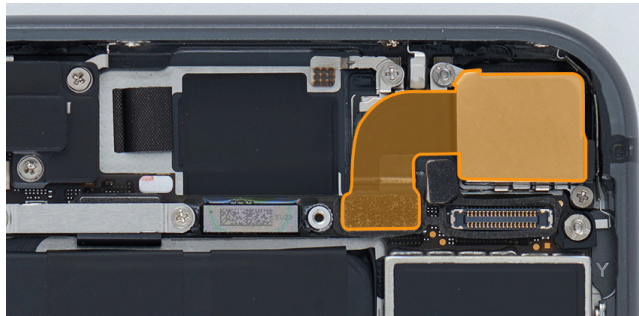

Removal

1. Use a torque driver and the JCIS bit to remove the crosshead screw from the camera cowling. Set aside the screw.

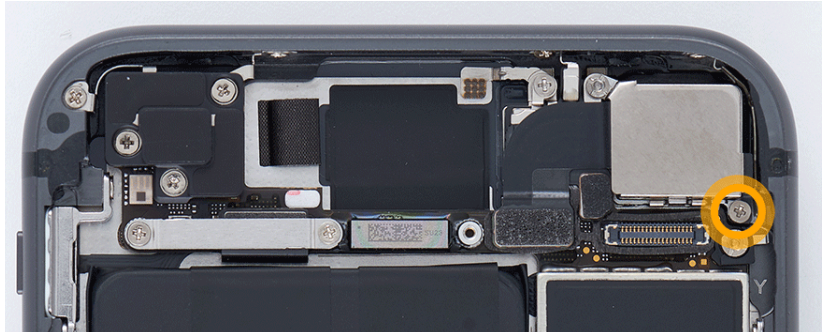

2. Use a torque driver and the super screw bit to remove the super screw from the camera cowling. Set aside the super screw.

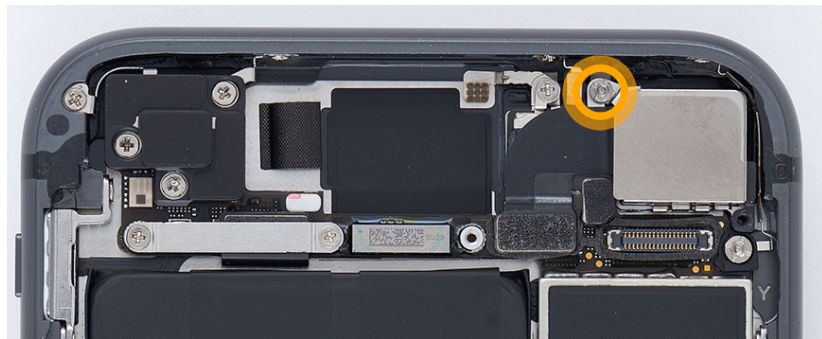

3. Remove the camera cowling and save it for reassembly.



4. Use the flat end of the black stick to lift the end of the camera flex cable off the connector.



5. Remove the camera from the enclosure.



Reassembly

1. Put on the gloves to prevent contamination of the camera lens. Then hold the replacement camera with the lens facedown and remove the protective cover from the camera lens.
2. Rest the camera in the enclosure. Don't press the camera into the enclosure yet.



3. Press the end of the camera flex cable to the connector (1). Gently press the camera into the enclosure (2).

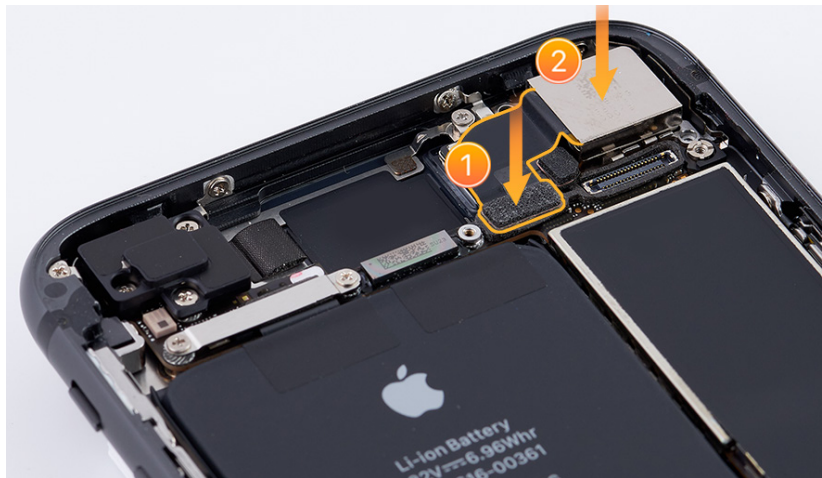

4. Position the camera cowling on the camera.

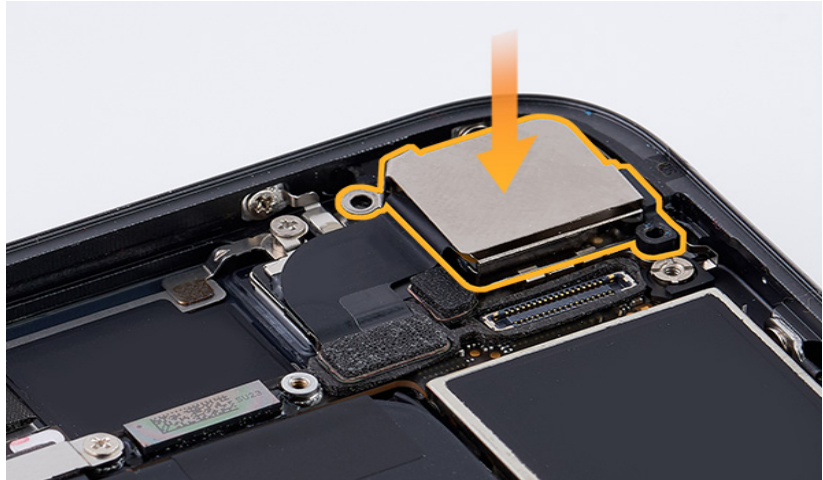

5. Use the green torque driver and super screw bit to partially install one new super screw into the camera cowling. Don't fully tighten the super screw yet.

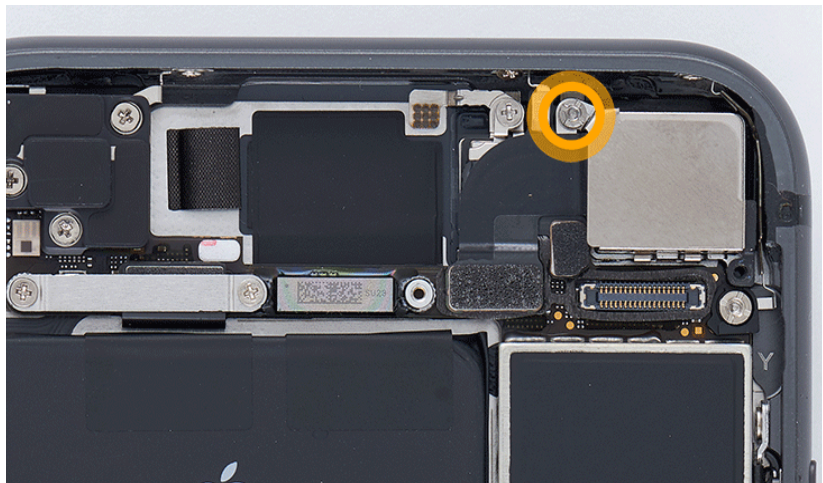

6. Use the green torque driver and JCIS bit to partially install one new crosshead screw into the camera cowling.

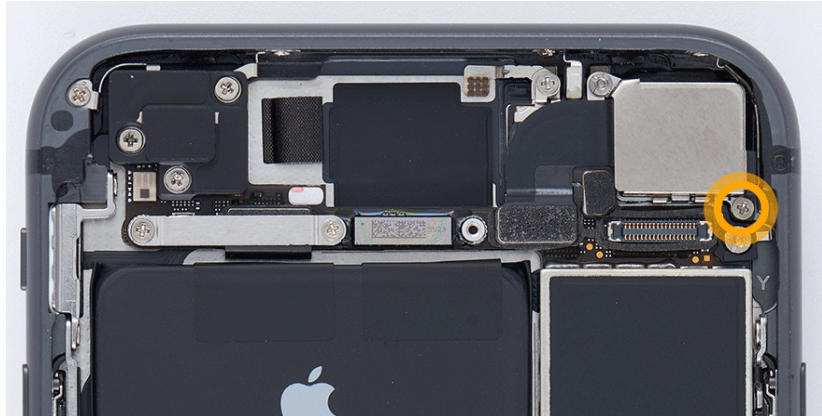

7. Fully torque the two screws into the camera cowling.

Reinstall the following part to complete reassembly:

- [Display](#)

Taptic Engine

Before You Begin

Warning

Read [Battery Safety](#) and follow workspace and battery handling guidelines before you begin.

Remove the following part before you begin:

- [Display](#)

Tools

- ESD-safe tweezers
- JCIS bit
- Micro stix bit
- Nylon probe (black stick)
- Super screw bit
- Torque driver (black, 0.35 kgf cm)
- Torque driver (green, 0.45 kgf cm)



Removal

1. Use a torque driver and the Micro stix bit to remove the trilobe screw from the Taptic Engine connector cowling. Set aside the screw.

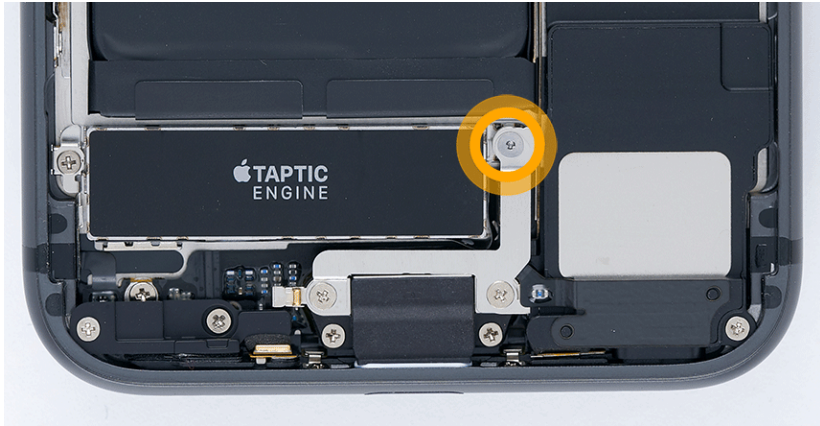

2. Use a torque driver and the JCIS bit to remove the two crosshead screws from the Taptic Engine connector cowling. Set aside the screws.

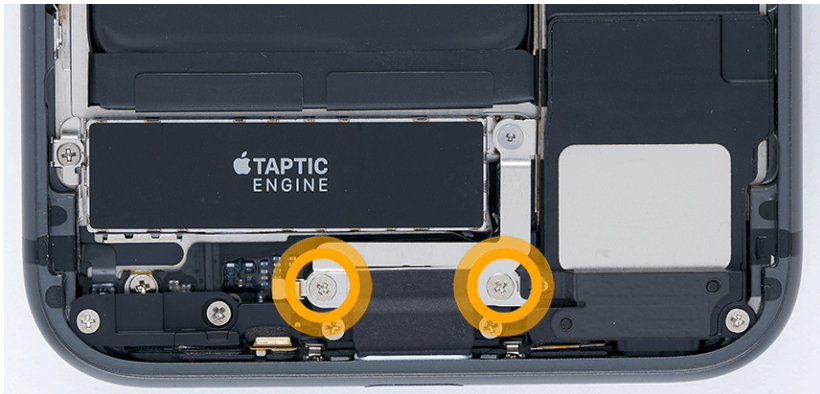

3. Remove the Taptic Engine connector cowling and save it for reassembly.

4. Use a torque driver and the JCIS bit to remove the crosshead screw from the Taptic Engine. Set aside the screw.



5. Use ESD-safe tweezers to remove the grounding clip. Save the grounding clip for reassembly.

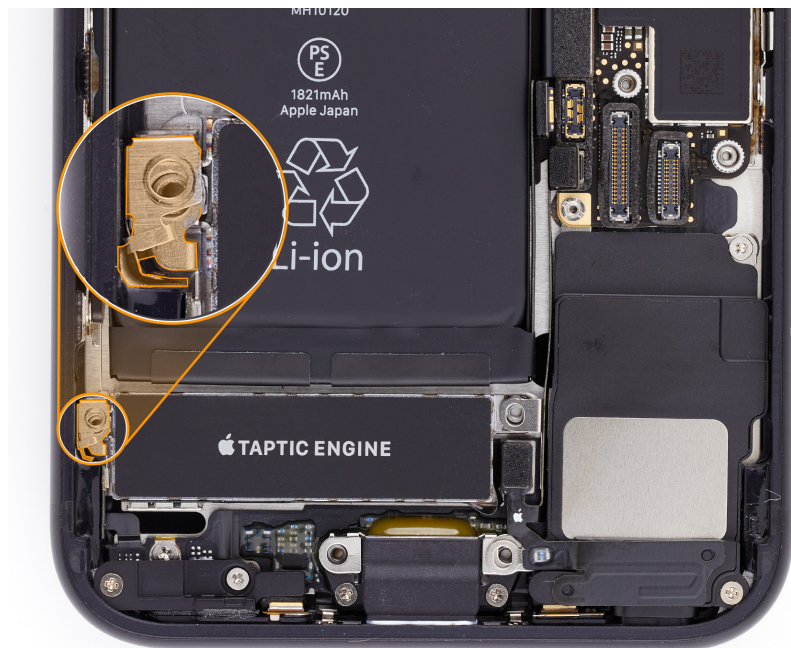

6. Use the black stick to lift the upper end of the Wi-Fi antenna off the upper connector.



7. The lower end of the Wi-Fi antenna (1) is attached to the lower antenna flex cable. Use the black stick to press and hold the lower antenna flex cable (2). At the same time, use ESD-safe tweezers to lift the end of the Wi-Fi antenna off the connector and move the antenna gently to the right (3).

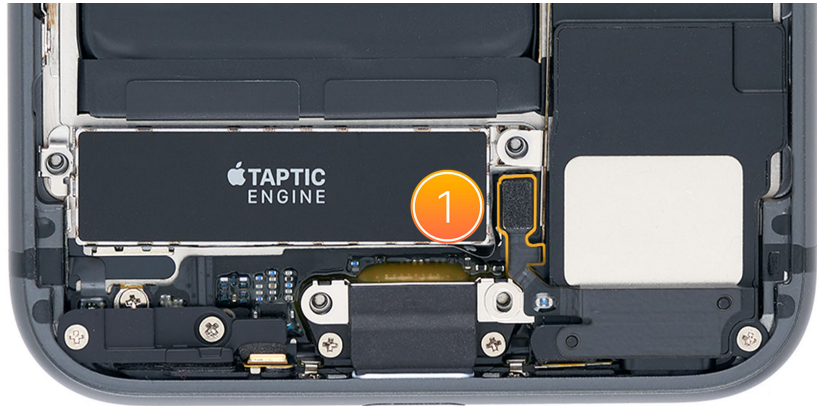

 **Caution**

To avoid damaging the Wi-Fi antenna, don't bend it beyond 90 degrees.

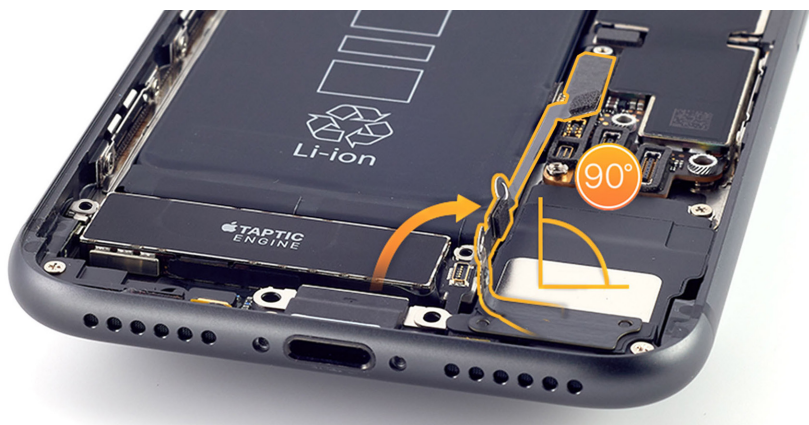

- 8. Gently hold the Wi-Fi antenna as shown to access the super screw underneath. Use a torque driver and the super screw bit to remove the super screw from the Taptic Engine. Set aside the super screw

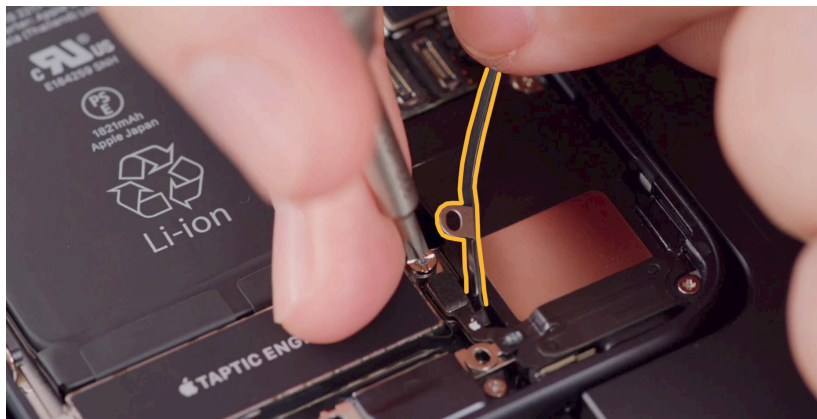

- 9. The Taptic Engine flex cable lies under the lower antenna flex cable. Use the black stick to gently lift the end of the lower antenna flex cable off the top of the Taptic Engine flex cable.

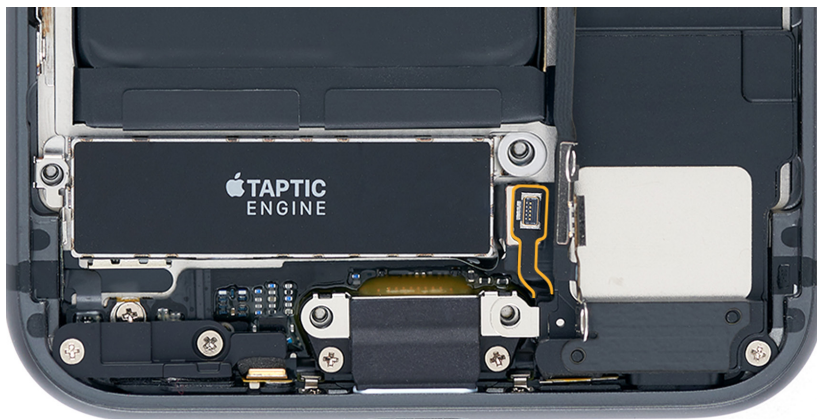

 **Caution**

To avoid damaging the lower antenna flex cable, don't bend it beyond 60 degrees.

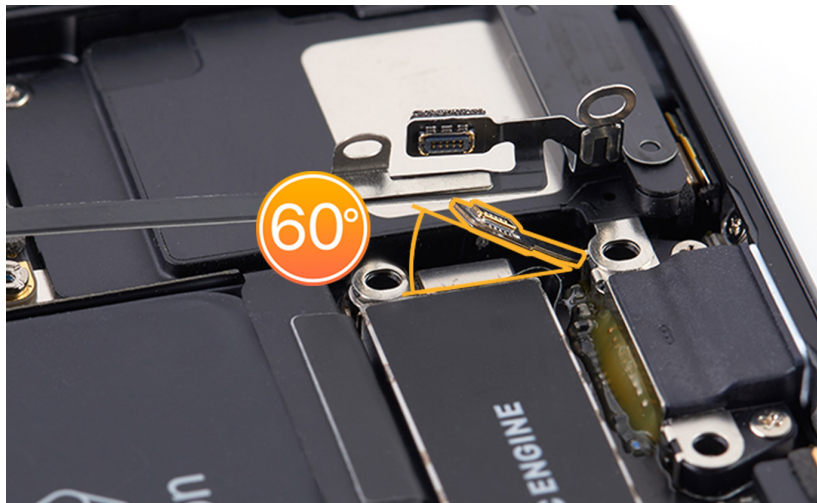

10. Use the black stick to gently lift the end of the Taptic Engine flex cable off the Taptic Engine/dock connector.

 **Caution**

Only the lower end of the Taptic Engine/dock connector is attached to the enclosure. To avoid damaging or detaching the connector, don't move it excessively.

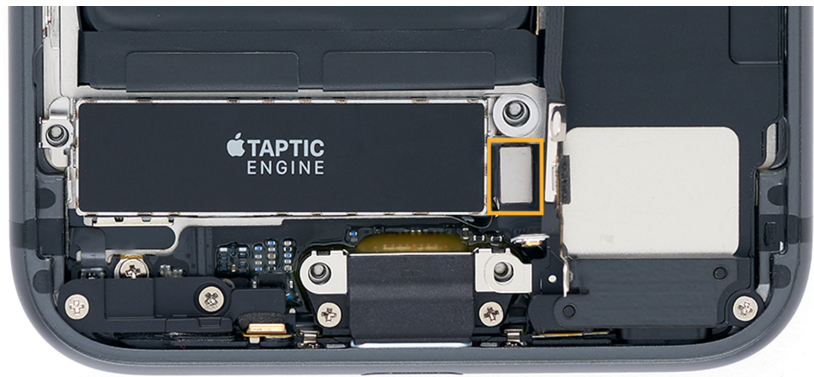

11. Tilt up the right side of the Taptic Engine (1) and slide it to the right to remove it from the enclosure (2).

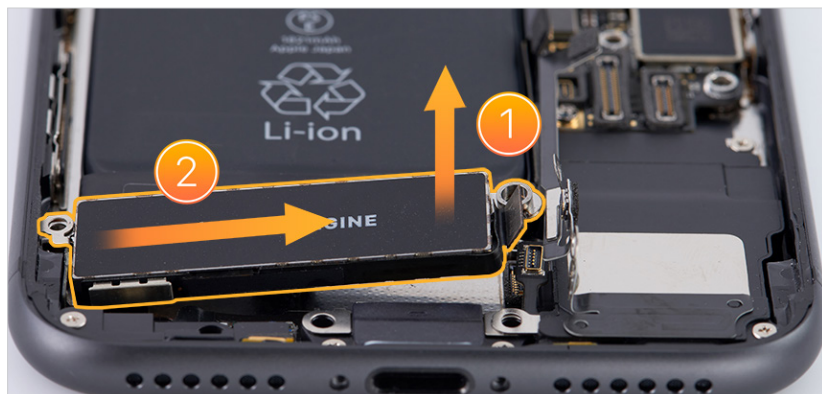

Reassembly

1. Slide the left side of the Taptic Engine into the enclosure (1) and lower the Taptic Engine into position (2).



2. Use ESD-safe tweezers to grasp the grounding clip as shown and reinstall it into the enclosure. If the grounding clip is broken or bent, replace it with a new one.



3. Use the green torque driver and JCIS bit to install one new crosshead screw into the Taptic Engine.



4. Use the green torque driver and super screw bit to install one new super screw into the Taptic Engine.

Important

Ensure that the super screw is beneath the Wi-Fi antenna.

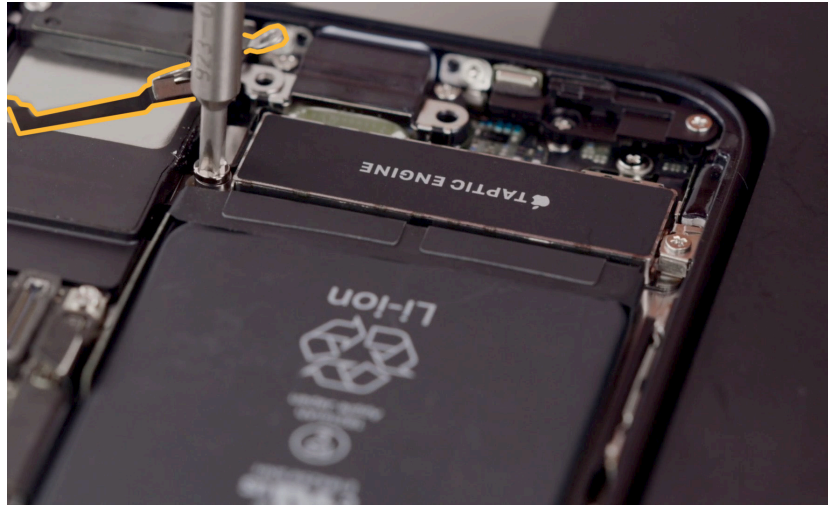

5. Inspect the Taptic Engine/dock connector to ensure that it's attached to the coaxial connector on the enclosure.

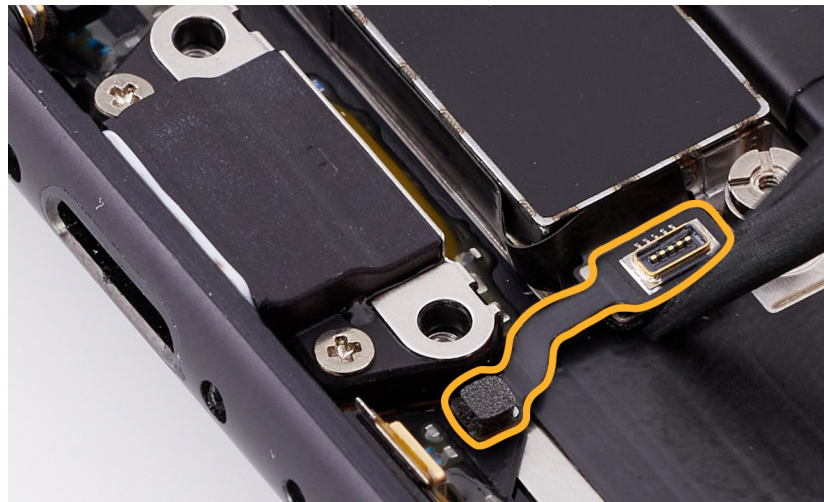

6. Press the end of the Taptic Engine flex cable to the Taptic Engine/dock connector.

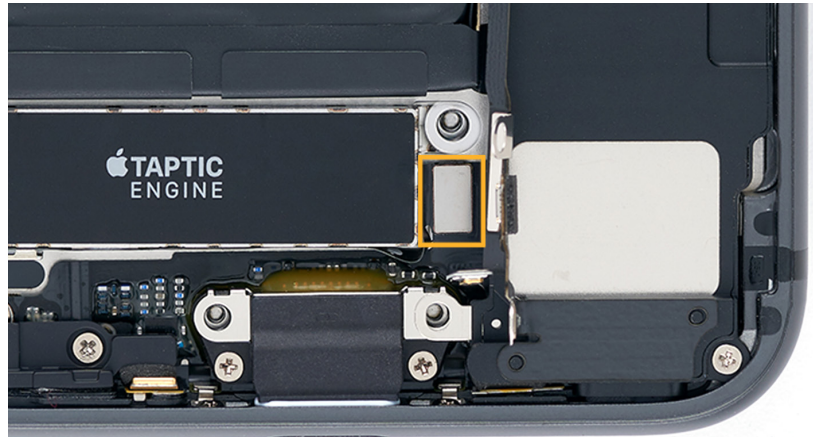

7. Adhere the end of the lower antenna flex cable to the top of the Taptic Engine flex cable.



8. Press the lower end of the Wi-Fi antenna to the top of the lower antenna flex cable.



9. Press the upper end of the Wi-Fi antenna to the upper connector.



10. Position the Taptic Engine connector cowling in the enclosure.

11. Use the green torque driver and JCIS bit to install two new crosshead screws into the Taptic Engine connector cowling.



12. Use the black torque driver and Micro stix bit to install one new trilobe screw into the Taptic Engine connector cowling.

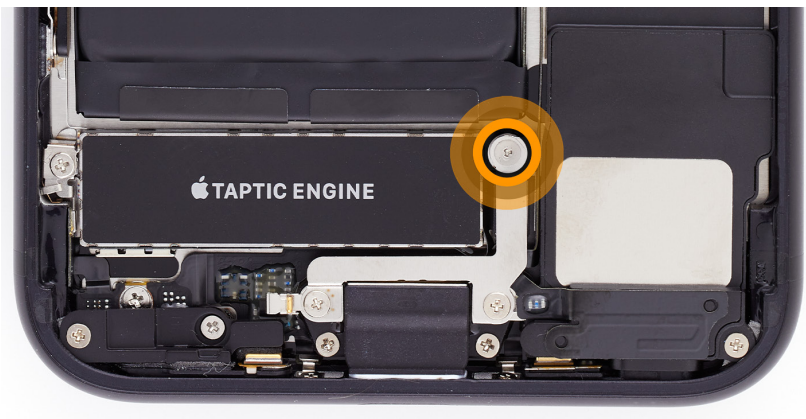

Reinstall the following part to complete reassembly:

- [Display](#)

Battery

Before You Begin

Warning

- A battery should be replaced only by individual technicians with the knowledge and experience to repair electronic devices. Improper battery replacement, improper handling of parts, or failure to follow the provided instructions could result in fire, injury, data loss, or damage to the device, parts, or other property.
- Read [Battery Safety](#) and follow workspace and battery handling guidelines before you begin.

Remove the following parts before you begin:

- [Display](#)
- [Taptic Engine](#)

Tools

- 4.7-inch repair tray
- Battery press
- ESD-safe cleaning solution
- ESD-safe tweezers
- Ethanol wipes or isopropyl alcohol (IPA) wipes
- Heat-resistant gloves
- Nylon probe (black stick)
- Safety glasses with side shields
- Sand
- Sand container



Important

This procedure requires [System Configuration](#). After you've completed all removal and reassembly steps, learn how to initiate the System Configuration process at support.apple.com/self-service-repair.

Removal

1. Place the enclosure in the repair tray with the Lightning connector facing the cutout. Use ESD-safe tweezers to gently peel the two adhesive tabs from the bottom of the battery.



2. Hold down the iPhone with one hand. With the other hand, grasp one adhesive tab and slowly pull it toward the bottom of the iPhone. As the adhesive strip stretches, grasp it closer to the battery and continue pulling until you've removed the entire strip.



Caution

Don't pull the adhesive strip against parts or screws.

Important

If the battery adhesive tab or strip breaks off and you can still see it, attempt to retrieve it with your fingers and repeat step 2. If you can't see the tab or strip, continue to step 3.

- Repeat step 2 to remove the other adhesive strip from the bottom of the battery. If you remove the entire strip, continue to step 4.

Important

If the second bottom battery adhesive tab or strip breaks off and you can still see it, attempt to retrieve it with your fingers and repeat step 2. If you can't see the tab or strip, continue to step 4.

- Use ESD-safe tweezers to gently peel the two adhesive tabs from the top of the battery.

Note: The center of the top battery adhesive tab is perforated. The battery tab separates into two tabs as you lift one side.

Warning

Don't scrape or puncture the battery with the tweezers.

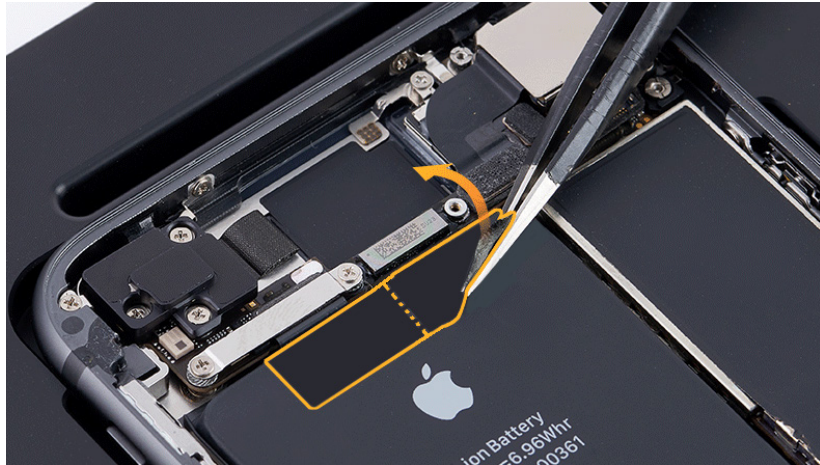

5. Hold down the iPhone with one hand. Use ESD-safe tweezers to grasp one adhesive tab and slowly pull it upward. Twist the tweezers to wrap the adhesive strip around them until you've removed the entire strip.

**Caution**

Don't pull the adhesive strip against parts or screws.

**Important**

If the battery adhesive tab or strip breaks off and you can still see it, attempt to retrieve it with the tweezers and repeat step 5. If you can't see the tab or strip, continue to step 6.

6. Repeat step 5 to remove the remaining battery adhesive strip from the top of the battery. If you remove the entire strip, continue to step 7.

Important

If the battery adhesive tab or strip breaks off and you can still see it, attempt to retrieve it with the tweezers and repeat step 5. If you can't see the tab or strip, continue to step 7.

- If all four battery adhesive strips were fully removed, continue to step 9. If at least one strip was fully removed, continue to step 8.

 **Warning**

If all four strips were broken and can't be retrieved, don't forcibly pry the battery. Stop the repair. You can find a service option at support.apple.com/repair.

 **Caution**

When using the black stick to remove the battery from the enclosure, don't damage the flex cables. Don't scrape, rip, tear, or otherwise damage the polyester film or other areas (1). If damage occurs, replace the iPhone.

- Insert the flat end of the black stick into one of the insertion points marked by an arrow (2). Ensure that the black stick is inserted into a point where the battery strip has been fully removed. Don't insert the black stick into a point where the battery tab or strip is broken.

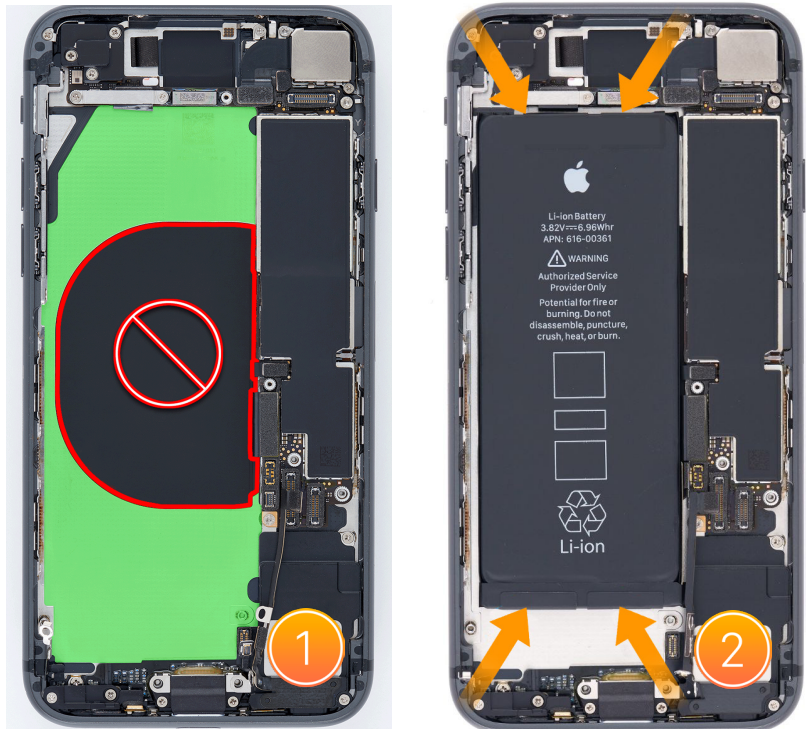

- Use the black stick to tilt the battery up just enough to grasp it underneath.

 **Caution**

To avoid damage, don't press the black stick on the edge of the enclosure.

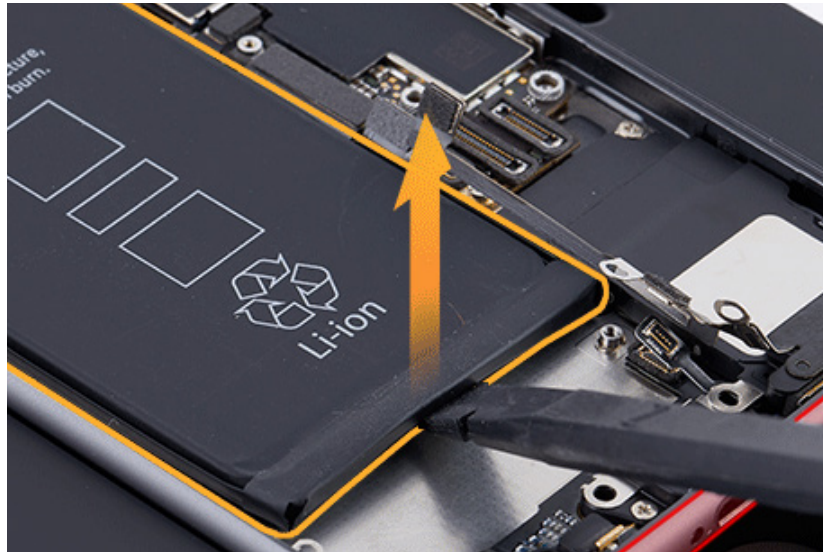

- Remove the battery from the enclosure. Then inspect the enclosure for damage. If the enclosure is damaged, replace the iPhone.

 **Warning**

If you can't remove the battery, stop the repair. You can find a service option at support.apple.com/repair.

Reassembly

1. Use ethanol wipes or IPA wipes on the area shown in green to remove any remaining adhesive residue from the enclosure.

Caution

Don't use ethanol wipes or IPA wipes on the area outlined in red. Ethanol or isopropyl alcohol may damage the polyester film and wireless charging unit.

Warning

Inspect the enclosure for loose or extra screws and small parts, which can damage the battery and cause safety issues.

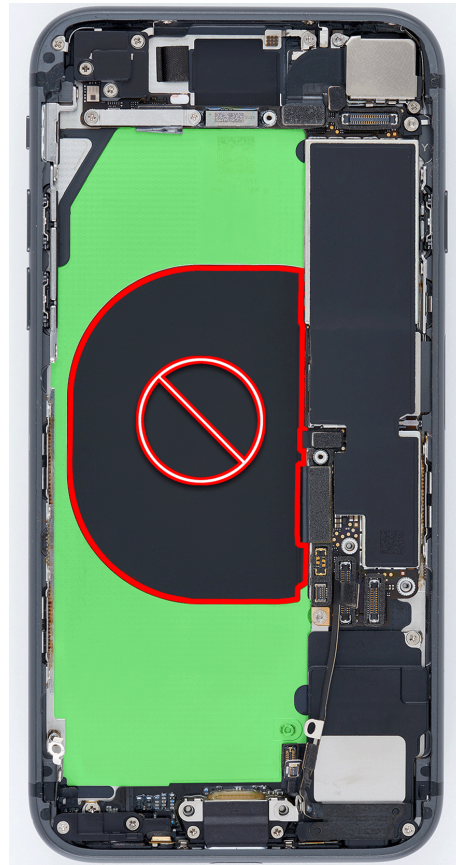

2. Peel the pink release liner from the underside of the replacement battery.

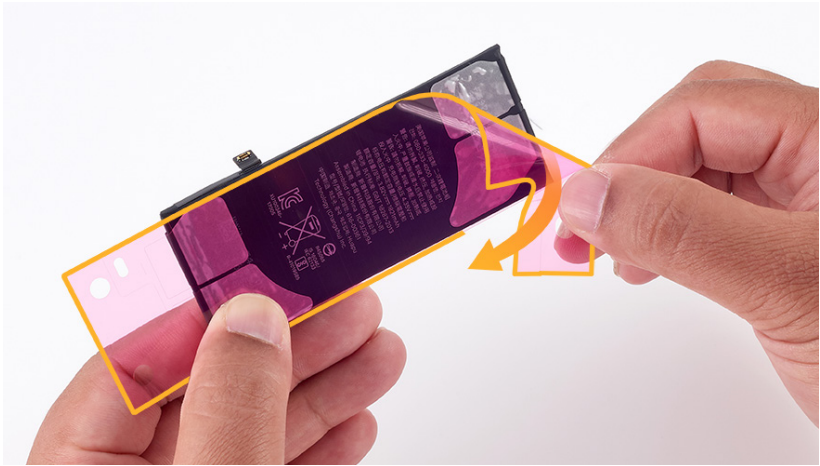

3. Rest the right edge of the battery in the enclosure. Press the end of the battery flex cable to the connector.

 **Caution**

Temporarily connecting the battery flex cable prevents cable damage and ensures correct battery position.

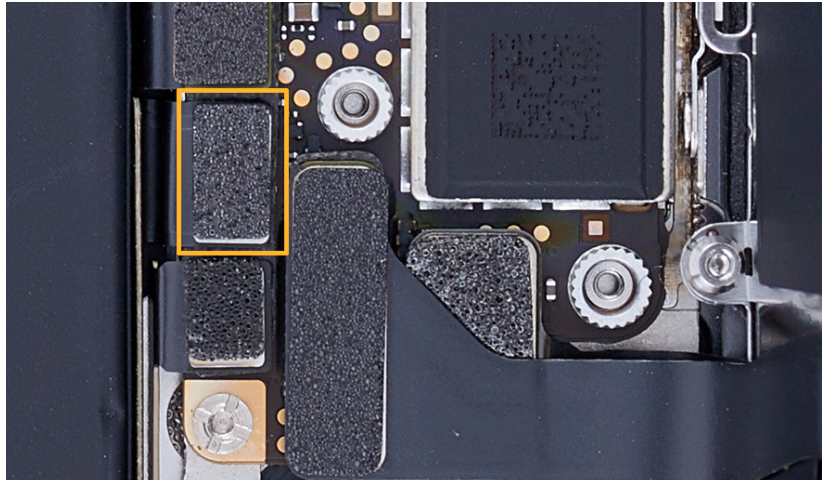

4. Tilt down the left side of the battery.



5. The repair tray has a slot in the center. Position the repair tray and enclosure into the battery press with the slot over the pin as shown.

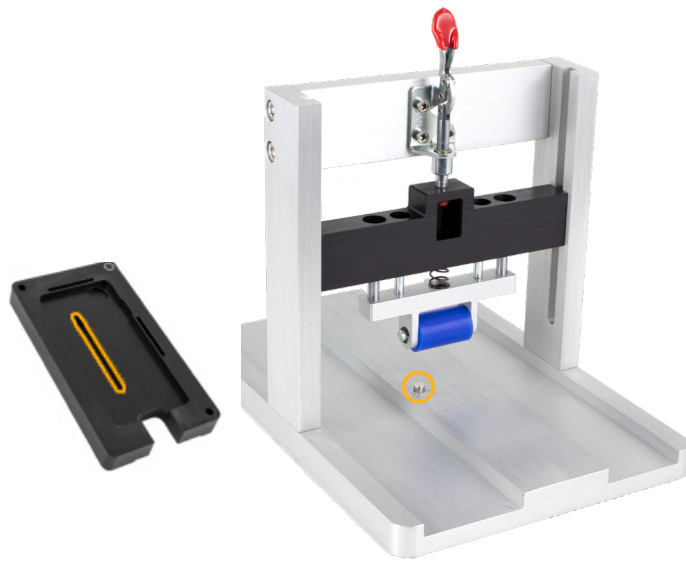

6. Flip down the red lever to lower the roller onto the battery.

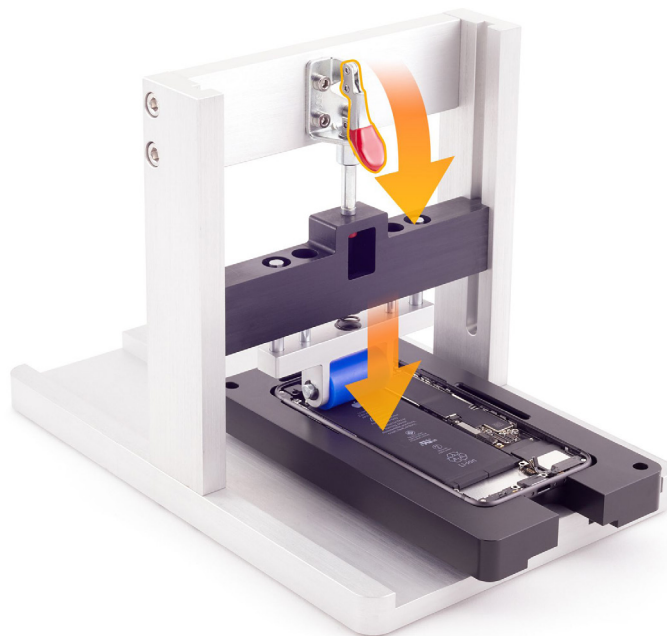

- Slide the repair tray back and forth through the battery press three times to adhere the battery to the enclosure.

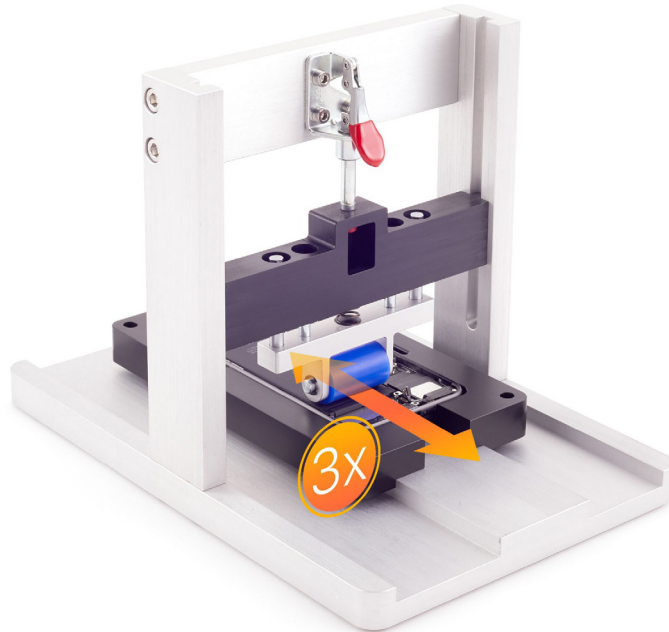

- Flip up the red lever.

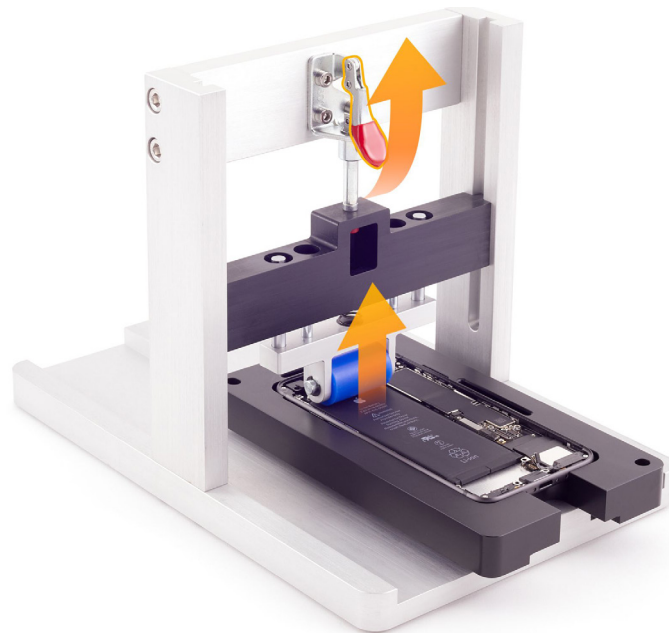

- Remove the repair tray from the battery press.

10. Use the black stick to lift the end of the battery flex cable off the connector.

 **Caution**

Leave the battery flex cable off the connector until display reassembly.

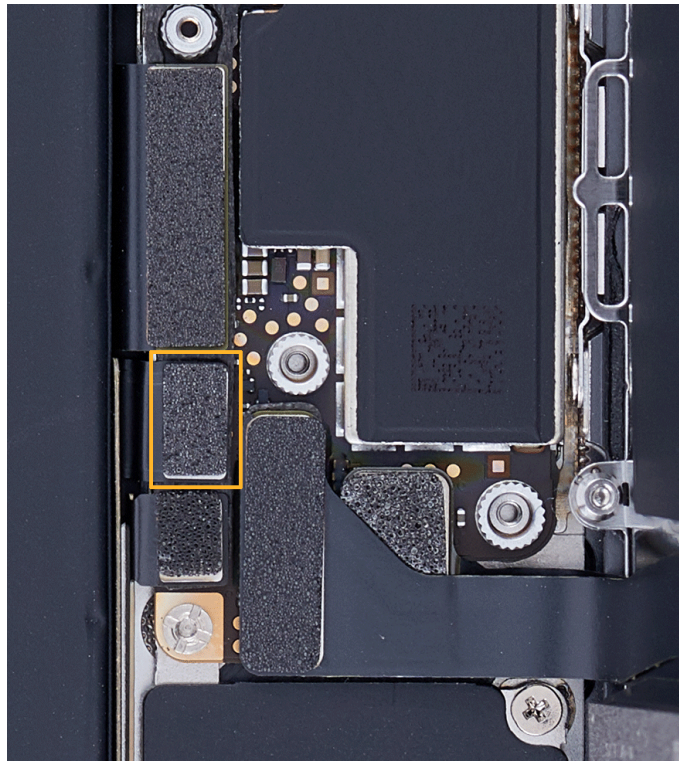

Reinstall the following parts to complete reassembly:

- [Taptic Engine](#)
- [Display](#)

 **Warning**

Gently shake the iPhone. If the battery sounds loose, remove the [display](#), repeat battery reassembly steps 5 through 10, and reinstall the [display](#). If you still hear a rattle, replace the battery with another new battery.

Important

After you've completed all removal and reassembly steps, learn how to initiate the System Configuration process at support.apple.com/self-service-repair.

Speaker

Before You Begin

Warning

Read [Battery Safety](#) and follow workspace and battery handling guidelines before you begin.

Remove the following parts before you begin:

- [Display](#)
- [Taptic Engine](#)

Tools

- ESD-safe tweezers
- JCIS bit
- Micro stix bit
- Nylon probe (black stick)
- Super screw bit
- Torque driver (green, 0.45 kgf cm)



Removal

1. Use a torque driver and the JCIS bit to remove two crosshead screws from the speaker. Set aside the screws.



2. Use a torque driver and the super screw bit to remove the super screw from the speaker. Set aside the screw.



3. Gently insert the black stick under the lower right corner of the logic board (1). Lift the logic board just enough to slide the speaker under it and release the speaker from the speaker port (2). Lift the speaker out of the enclosure.

 **Caution**

Don't bend the logic board or lift it more than necessary to make room for the top of the speaker.

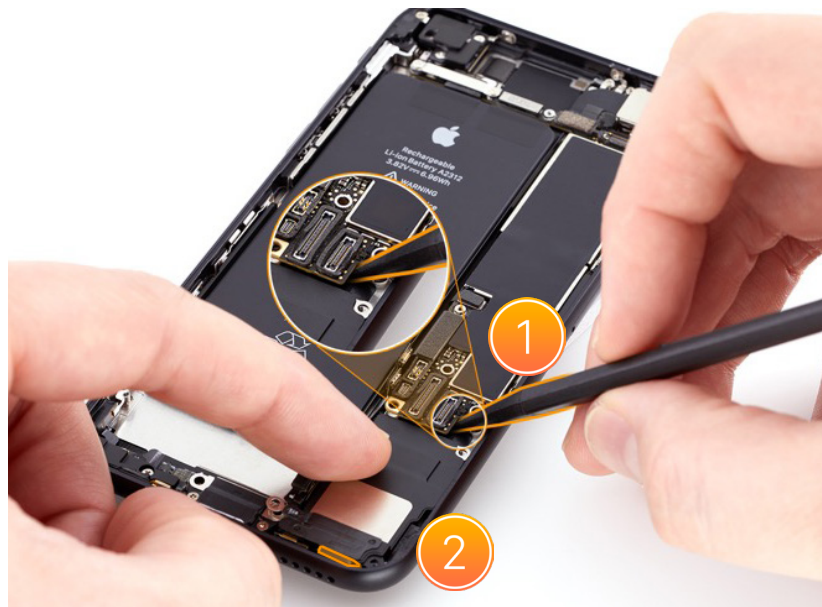

 **Caution**

At the top left corner of the speaker is a tab that slides between the logic board and the enclosure. Remove the speaker gently to avoid breaking the tab or bending the logic board.



Reassembly

1. Follow [Taptic Engine](#) reassembly steps 1 through 4 to partially reinstall the Taptic Engine.

2. Gently move the Taptic Engine/dock connector back and forth to ensure that it's attached to the coaxial connector on the enclosure.



3. Ensure that the Taptic Engine/dock connector is parallel to the right side of the enclosure.



! **Caution**

- When you reinstall the speaker, ensure that the tab on the speaker goes under the logic board and above the screw hole.
- Reinstall the speaker gently to avoid breaking the tab or bending the logic board.

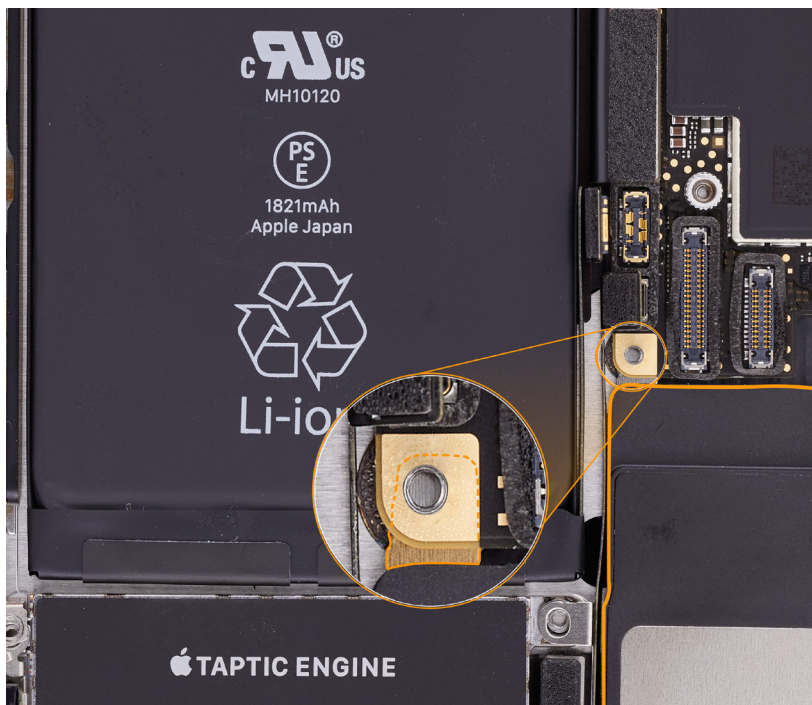

4. Insert the black stick under the lower right corner of the logic board. Tilt the top of the speaker down and slide it slightly under the logic board (1). Lay the bottom of the speaker in the enclosure. Then slide the bottom of the speaker into the speaker port (2).



5. Use the green torque driver and super screw bit to install one new super screw into the speaker.



6. Use the green torque driver and JCIS bit to install two new crosshead screws into the speaker.



7. Inspect the Taptic Engine/dock connector to ensure that it's attached to the coaxial connector on the enclosure.

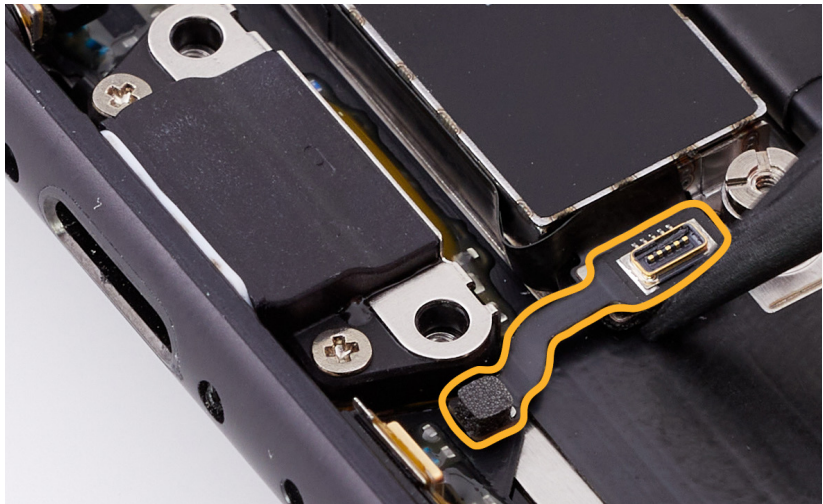

8. Press the end of the Taptic Engine flex cable to the Taptic Engine/dock connector.

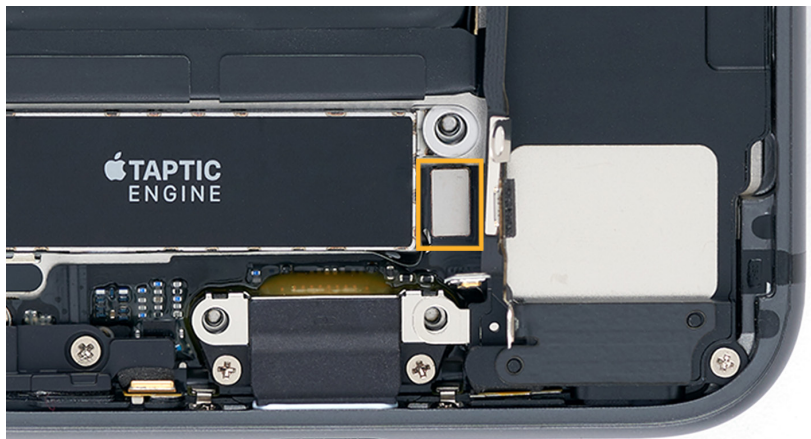

9. Adhere the end of the lower antenna flex cable to the top of the Taptic Engine flex cable.



10. Press the lower end of the Wi-Fi antenna to the top of the lower antenna flex cable (1). Press the upper end of the Wi-Fi antenna to the upper connector (2).



11. Follow [Taptic Engine](#) reassembly steps 10 through 12 to reinstall the Taptic Engine connector cowling.

Reinstall the following part to complete reassembly:

- [Display](#)

Micro stix® is a registered trademark of OSG CORPORATION. Torx® is a registered trademark of Acument Intellectual Properties, LLC.