

AOC

AGON



LCD Monitor User Manual AG254FG

Safety	1
National Conventions	1
Power	2
Installation	3
Cleaning	4
Other	5
Setup	6
Contents in Box	6
Setup Stand & Base	7
Adjusting the monitor	8
Connecting the Monitor	9
Wall Mounting	10
Adaptive-Sync function (Available for selective models)	11
G-SYNC function	11
HDR	12
Adjusting	13
Hotkeys	13
Quick Switch	14
OSD Key Guide (Menu)	15
OSD Setting	17
Game Setting	18
Luminance	19
G-SYNC® Processor	20
Color Setup	21
Audio	22
Light FX	23
Extra	24
OSD Setup	25
LED Indicator	26
Troubleshoot	27
Specification	28
General Specification	28
Preset Display Modes	29
Pin Assignments	30
Plug and Play	31

Safety

National Conventions

The following subsections describe notational conventions used in this document.

Notes, Cautions, and Warnings

Throughout this guide, blocks of text may be accompanied by an icon and printed in bold type or in italic type. These blocks are notes, cautions, and warnings, and they are used as follows:



NOTE: A NOTE indicates important information that helps you make better use of your computer system.



CAUTION: A CAUTION indicates either potential damage to hardware or loss of data and tells you how to avoid the problem.





WARNING: A WARNING indicates the potential for bodily harm and tells you how to avoid the problem. Some warnings may appear in alternate formats and may be unaccompanied by an icon. In such cases, the specific presentation of the warning is mandated by regulatory authority.

Power

 The monitor should be operated only from the type of power source indicated on the label. If you are not sure of the type of power supplied to your home, consult your dealer or local power company.

 The monitor is equipped with a three-pronged grounded plug, a plug with a third (grounding) pin. This plug will fit only into a grounded power outlet as a safety feature. If your outlet does not accommodate the three-wire plug, have an electrician install the correct outlet, or use an adapter to ground the appliance safely. Do not defeat the safety purpose of the grounded plug.

 Unplug the unit during a lightning storm or when it will not be used for long periods of time. This will protect the monitor from damage due to power surges.

 Do not overload power strips and extension cords. Overloading can result in fire or electric shock.

 To ensure satisfactory operation, use the monitor only with UL listed computers which have appropriate configured receptacles marked between 100-240V AC, Min. 5A.

 The wall socket shall be installed near the equipment and shall be easily accessible.

 For use only with the attached power adapter

Manufacturers: TPV ELECTRONICS(FUJIAN)CO.,LTD. Model: ADPC20120

Installation

! Do not place the monitor on an unstable cart, stand, tripod, bracket, or table. If the monitor falls, it can injure a person and cause serious damage to this product. Use only a cart, stand, tripod, bracket, or table recommended by the manufacturer or sold with this product. Follow the manufacturer's instructions when installing the product and use mounting accessories recommended by the manufacturer. A product and cart combination should be moved with care.

! Never push any object into the slot on the monitor cabinet. It could damage circuit parts causing a fire or electric shock. Never spill liquids on the monitor.

! Do not place the front of the product on the floor.

! If you mount the monitor on a wall or shelf, use a mounting kit approved by the manufacturer and follow the kit instructions.

! Leave some space around the monitor as shown below. Otherwise, air-circulation may be inadequate hence overheating may cause a fire or damage to the monitor.

! To avoid potential damage, for example the panel peeling from the bezel, ensure that the monitor does not tilt downward by more than -5 degrees. If the -5 degree downward tilt angle maximum is exceeded, the monitor damage will not be covered under warranty.

See below the recommended ventilation areas around the monitor when the monitor is installed on the wall or on the stand:

Installed with stand

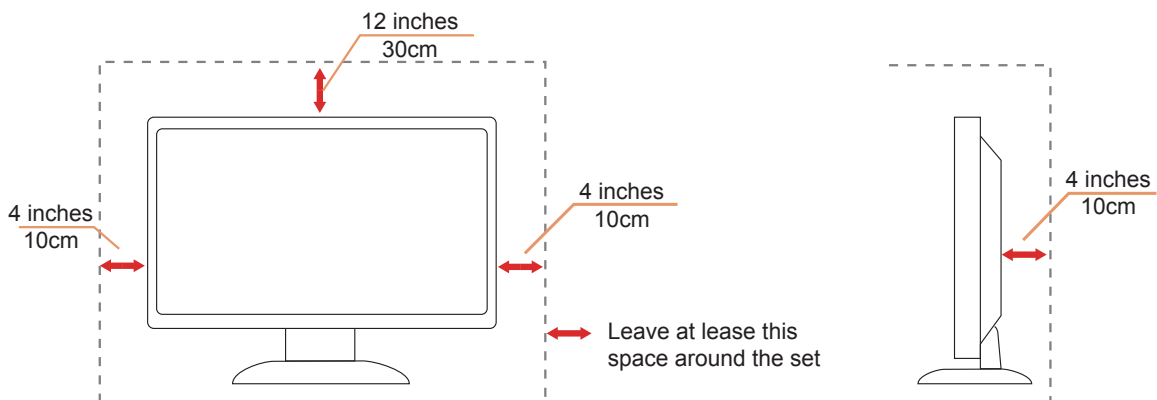

Cleaning

 Clean the cabinet regularly with cloth. You can use soft-detergent to wipe out the stain, instead of strong-detergent which will cauterize the product cabinet.

 When cleaning, make sure no detergent is leaked into the product. The cleaning cloth should not be too rough as it will scratch the screen surface.

 Please disconnect the power cord before cleaning the product.



Other

 If the product is emitting a strange smell, sound or smoke, disconnect the power plug IMMEDIATELY and contact a Service Center.

 Make sure that the ventilating openings are not blocked by a table or curtain.

 Do not engage the LCD monitor in severe vibration or high impact conditions during operation.

 Do not knock or drop the monitor during operation or transportation.

Setup

Contents in Box

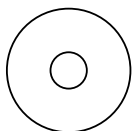
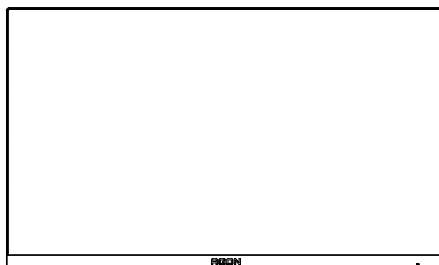

CD Manual



Warranty card

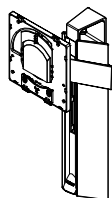

Stand



Screwdriver

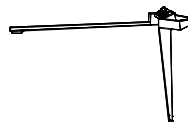

Base



Wire clip

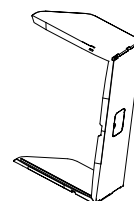

Shading Hood Packet



Adaptor



Power Cable



Quick Switch Keypad



DP Cable



HDMI Cable



USB Cable



Micphone Cable

* Not all signal cables will be provided for all countries and regions. Please check with the local dealer or AOC branch office for confirmation.

Setup Stand & Base

Please setup or remove the base following the steps as below.

Setup:

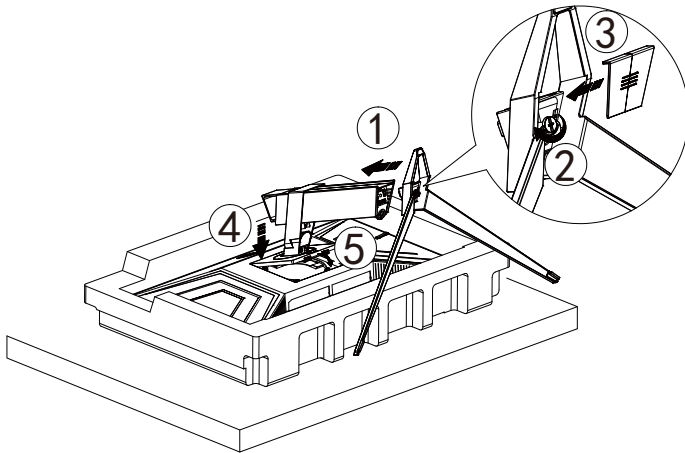

Remove:

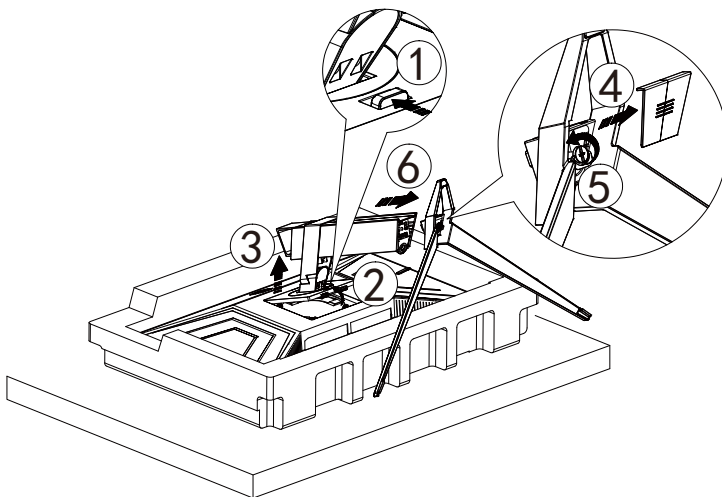

Adjusting the monitor

For optimal viewing it is recommended to look at the full face of the monitor, then adjust the monitor's angle to your own preference.

Hold the stand so you will not topple the monitor when you change the monitor's angle.

You are able to adjust the monitor as below:

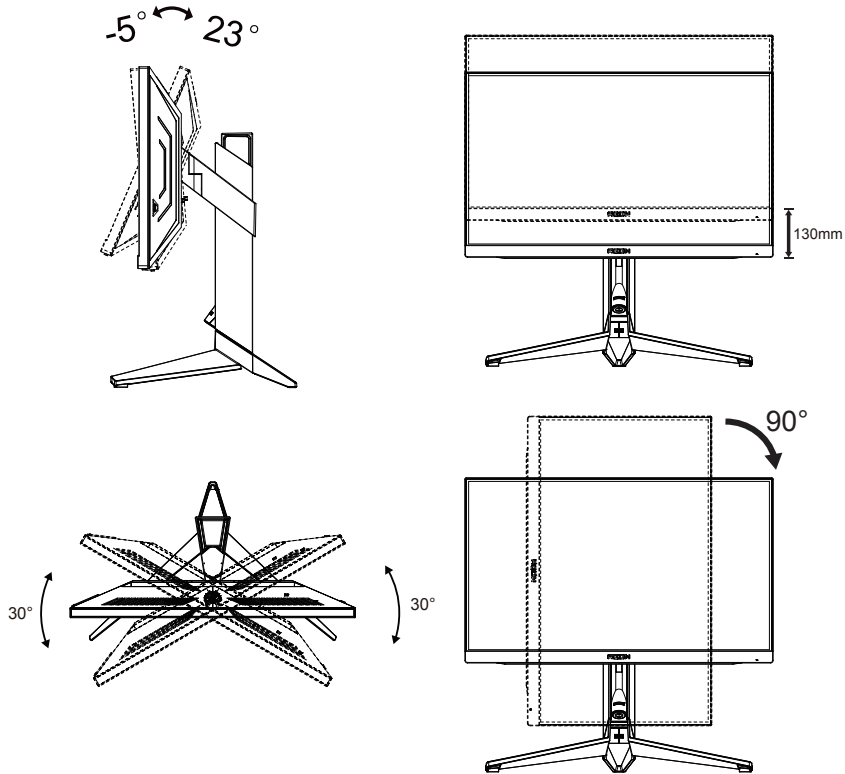

 **NOTE:**

Do not touch the LCD screen when you change the angle. It may cause damage or break the LCD screen.

Warning:

1. To avoid potential screen damage, such as panel peeling, ensure that the monitor does not tilt downward by more than -5 degrees.
2. Do not press the screen while adjusting the angle of the monitor. Grasp only the bezel.

Connecting the Monitor

Cable Connections In Back of Monitor and Computer:

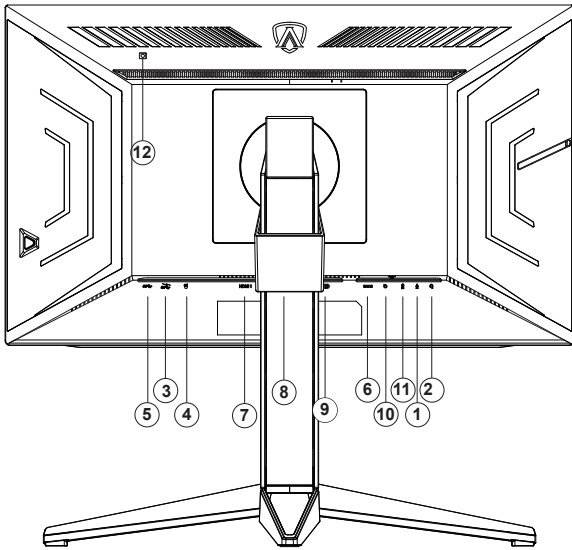

1. Microphone in
2. Earphone (Combined with Microphone)
3. USB3.2 Gen1 downstream + fast charging
4. USB3.2 Gen1 downstream(Reflex Latency Analyzer)(Green port)
5. USB3.2 Gen1 upstream
6. AC in
7. HDMI1
8. HDMI2
9. DP
10. Quick Switch port
11. Microphone out (Connect to PC)
12. Luminance (Light) sensor

Connect to PC

1. Connect the power cord to the back of the display firmly.
2. Turn off your computer and unplug its power cable.
3. Connect the display signal cable to the video connector on the back of your computer.
4. Plug the power cord of your computer and your display into a nearby outlet.
5. Turn on your computer and display.

If your monitor displays an image, installation is complete. If it does not display an image, please refer Troubleshooting.

To protect equipment, always turn off the PC and LCD monitor before connecting.

Wall Mounting

Preparing to Install An Optional Wall Mounting Arm.

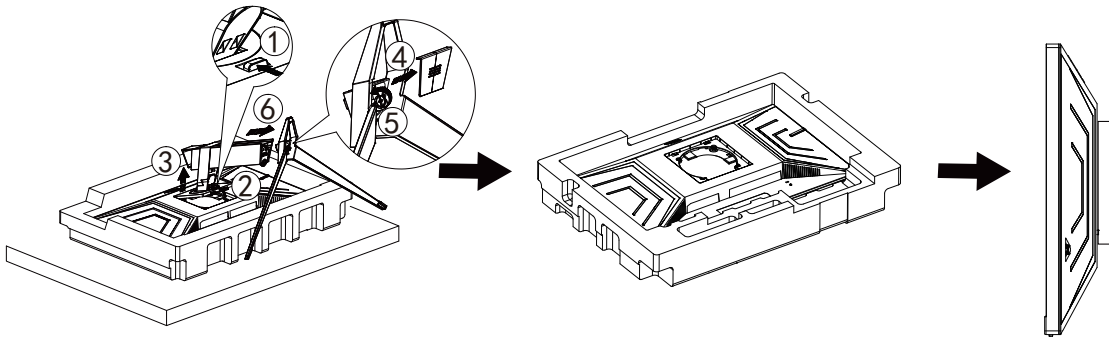

This monitor can be attached to a wall mounting arm you purchase separately. Disconnect power before this procedure. Follow these steps:

1. Remove the base.
2. Follow the manufacturer's instructions to assemble the wall mounting arm.
3. Place the wall mounting arm onto the back of the monitor. Line up the holes of the arm with the holes in the back of the monitor.
4. Reconnect the cables. Refer to the user's manual that came with the optional wall mounting arm for instructions on attaching it to the wall.

Noted: VESA mounting screw holes are not available for all models, please check with the dealer or official department of AOC.

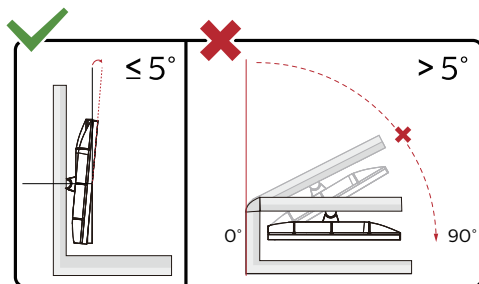

* Display design may differ from those illustrated.

Warning :

1. To avoid potential screen damage, such as panel peeling, ensure that the monitor does not tilt downward by more than -5 degrees.
2. Do not press the screen while adjusting the angle of the monitor. Grasp only the bezel.

Adaptive-Sync function (Available for selective models)

1. Adaptive-Sync function is working with DP/HDMI
2. Compatible Graphics Card: Recommend list is as the below, also could be checked by visiting www.AMD.com
 - Radeon™ RX Vega series
 - Radeon™ RX 500 series
 - Radeon™ RX 400 series
 - Radeon™ R9/R7 300 series (R9 370/X, R7 370/X, R7 265 except)
 - Radeon™ Pro Duo (2016)
 - Radeon™ R9 Nano series
 - Radeon™ R9 Fury series
 - Radeon™ R9/R7 200 series (R9 270/X, R9 280/X except)

G-SYNC function

Compatible Graphics Card: GeForce GTX 1070 Boost or higher (for a list of compatible graphics cards, please visit www.nvidia.com/G-SYNC)

Driver: GeForce 331.58 or higher OS: Windows 10 64b (other version of Windows are not supported by the provided HDR driver!)

HDR

It is compatible with input signals in HDR400 format.

The display may automatically activate the HDR function if the player and content are compatible. Please contact the device manufacturer and the content provider for information on the compatibility of your device and content. Please select "OFF" for the HDR function when you have no need for automatic activation function.

Note:

1. No special setting is needed for the DisplayPort/HDMI interface in WIN10 versions lower (older) than V1703.
2. Only the HDMI interface is available and the DisplayPort interface cannot function in WIN10 version V1703.
3. The display resolution is set to 1920x1080, and HDR is preset to ON. Under these conditions, the screen may slightly dim, indicating HDR has been activated.

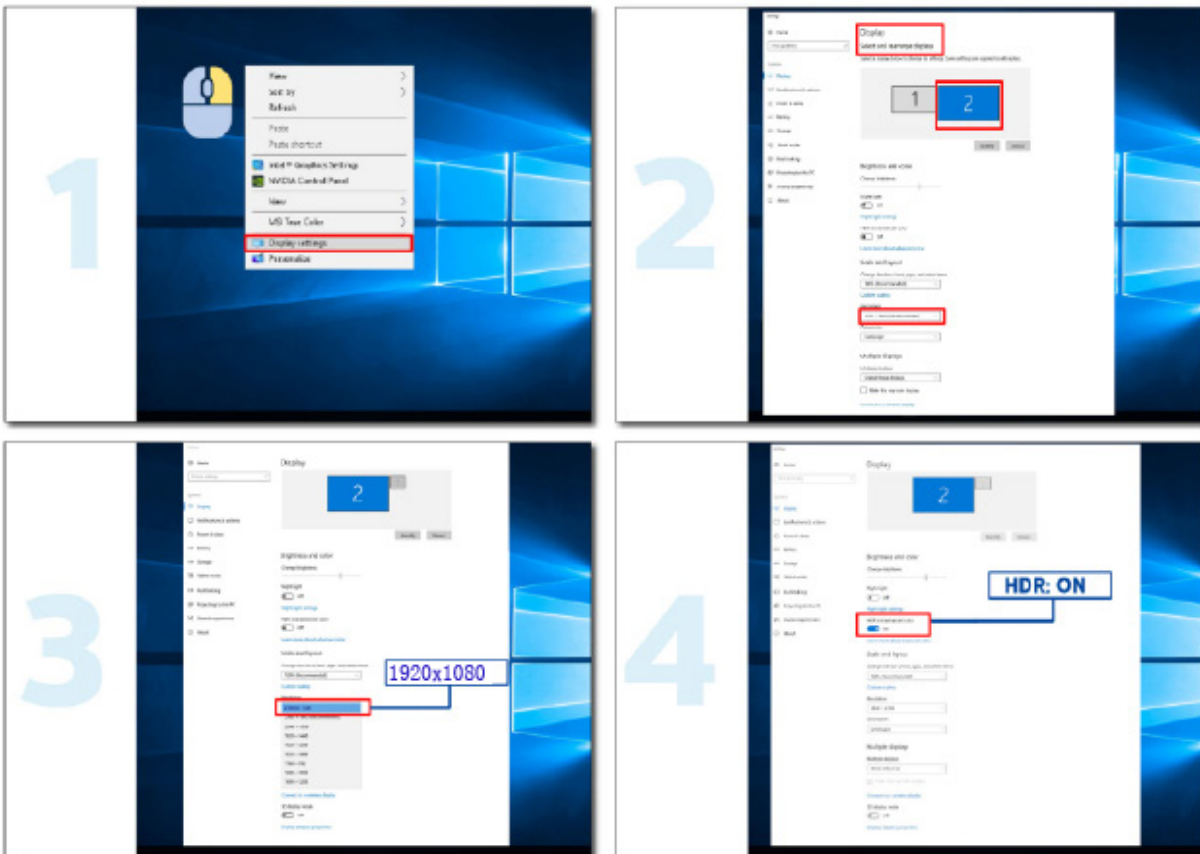

Adjusting

Hotkeys

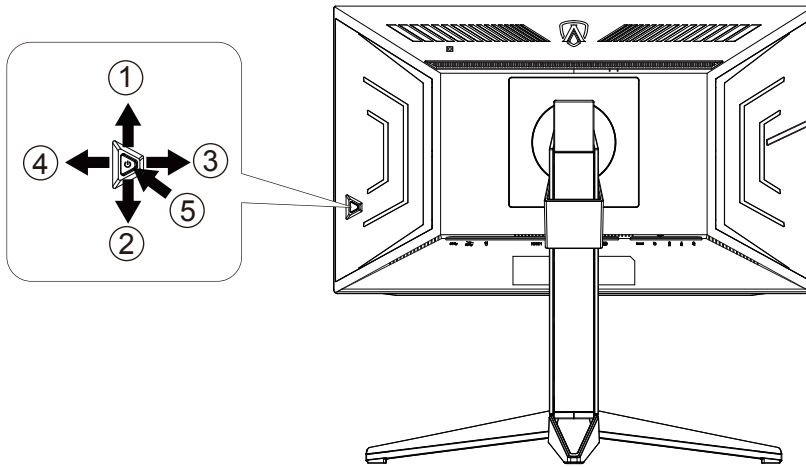

1	Source/Up
2	Dial Point/Down
3	Game Mode/Left
4	Light FX /Right
5	Power/ Menu/Enter

Power/Menu/Enter

Press the Power button to turn on the monitor.

When there is no OSD, Press to display the OSD or confirm the selection. Press about 2 seconds to turn off the monitor.

Dial Point/Down

When there is no OSD, press Dial Point button to show / hide Dial Point.

Game Mode/Left

When there is no OSD, press "Left" key to open game mode function, then press "Left" or "Right" key to select game mode (FPS, RTS, Racing, Gamer 1, Gamer 2 or Gamer 3) basing on the different game types.

Light FX/Right

When there is no OSD, press "Right" key to active Light FX function.

Source/Up

When the OSD is closed, press Source/Auto/Up button will be Source hot key function.

Quick Switch

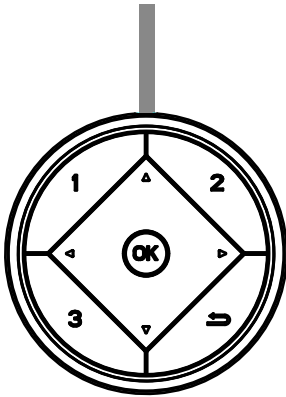

◀:

When there is no OSD, press the ◀ button to open game mode function, then press ◀ or ▶ key to select game mode (FPS, RTS, Racing, G-SYNC Esports, Gamer 1, Gamer 2 or Gamer 3) basing on the different game types.

▶:

When there is no OSD, press "Right" key to active Light FX function.

Menu/OK:

When there is no OSD, Press to display the OSD or confirm the selection.

▲:

When the OSD is closed, press ▲ button will be Source hot key function.

▼:

When there is no OSD, press Dial Point button to show / hide Dial Point.

1:

Press the 1 button to select Gamer 1 mode

2:

Press the 2 button to select Gamer 2 mode

3:

Press the 3 button to select Gamer 3 mode



Press to exit OSD.

OSD Key Guide (Menu)



Enter : Use Enter key to enter the next OSD level
Move : Use Left / Up / Down key to move OSD selection
Exit : Use Right key to exit OSD



Enter : Use Enter key to enter the next OSD level
Move : Use Right / Up / Down key to move OSD selection
Exit : Use Left key to exit OSD



Enter : Use Enter key to enter the next OSD level
Move : Use Up / Down key to move OSD selection
Exit : Use Left key to exit OSD

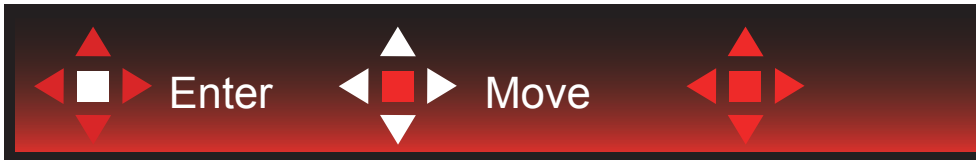

Move : Use Left / Right / Up / Down Key to move OSD selection



Exit : Use Left key to exit OSD to previous OSD level
Enter : Use Right key to enter next OSD level
Select : Use Up / Down key to move OSD selection



Enter : Use Enter key to apply the OSD setting and back to previous OSD level
Select : Use Down key to adjust OSD setting



Select : Use Up / Down key to adjust OSD setting



Enter : Use Enter key to exit OSD to previous OSD level

Select : Use Left / Right key to adjust OSD setting

OSD Setting

Basic and simple instruction on the control keys.

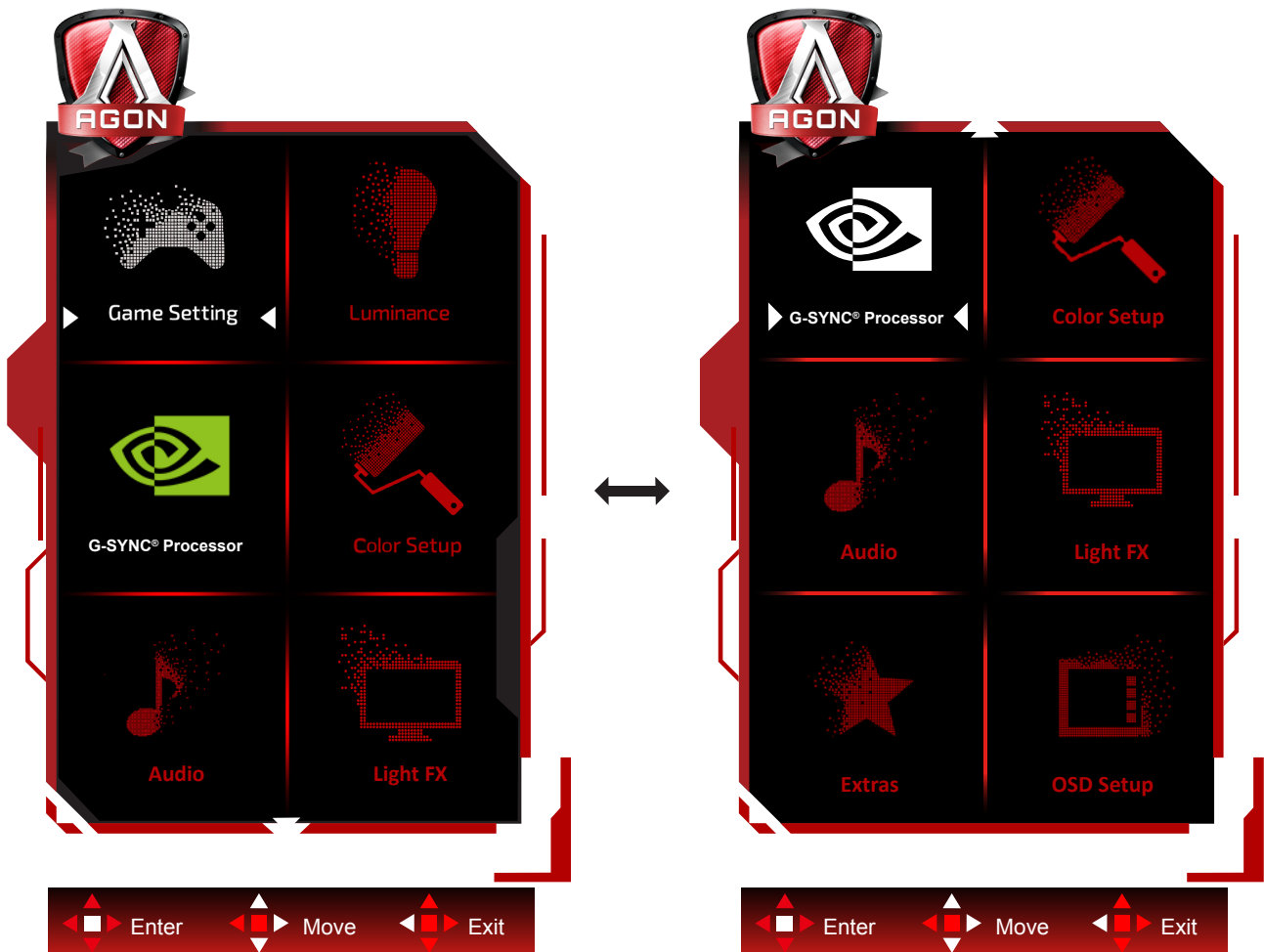

- 1). Press the MENU-button to activate the OSD window.
- 2). Follow Key Guide to move or select (adjust) OSD settings
- 3). OSD Lock/Unlock Function: To lock or unlock the OSD, press and hold the Down-button for 10s while OSD function is not active.

Notes:

If the product has only one signal input, the item of "Input Select" is disable to adjust.

Game Setting

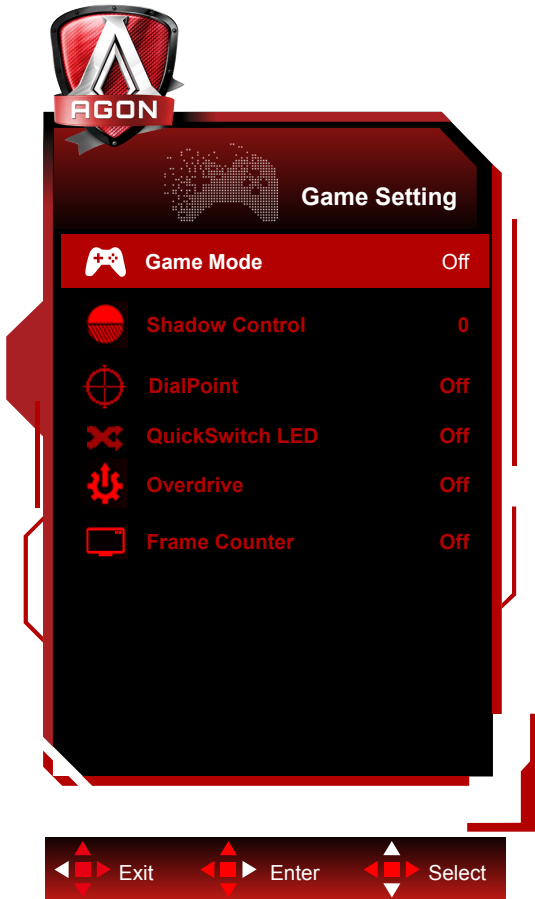

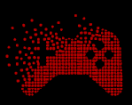
	Game Mode	FPS	For playing FPS (first Person Shooters) games. Improves dark theme black level details.
		RTS	For playing RTS (Real Time Strategy). Improves the image quality.
		Racing	For playing Racing games, Provides fastest response time and high color saturation.
		G-SYNC Esports	NVIDIA preference Settings. Improves quality.
		Gamer 1	User's preference settings saved as Gamer 1.
		Gamer 2	User's preference settings saved as Gamer 2.
		Gamer 3	User's preference settings saved as Gamer 3.
		Off	No optimization by Smart image game
	Shadow Control	0-3	Shadow Control Default is 0, then end-user can adjust from 0 to 3 or 0 to increase contrast for clear picture. 1. If picture is too dark to be saw the detail clearly, adjusting from 0 to 3 for clear picture.. 2. If picture is too white to be saw the detail clearly, adjusting from 3 to 0 for clear picture
	DialPoint	On / Off	The "Dial Point" function places an aiming indicator in the center of screen for helping gamers to play First Person Shooter (FPS) games with an accurate and precise aiming.
QuickSwitch LED	On / Off	Disable or Enable QuickSwitch LED	
Overdrive	Weak/Medium/Strong/Off	Adjust the response time.	
Frame Counter	Off / Right-Up / Right-Down / Left-Down / Left-Up	Display V frequency on the corner selected (Frame counter feature only works with NVIDIA graphic card.)	

Luminance

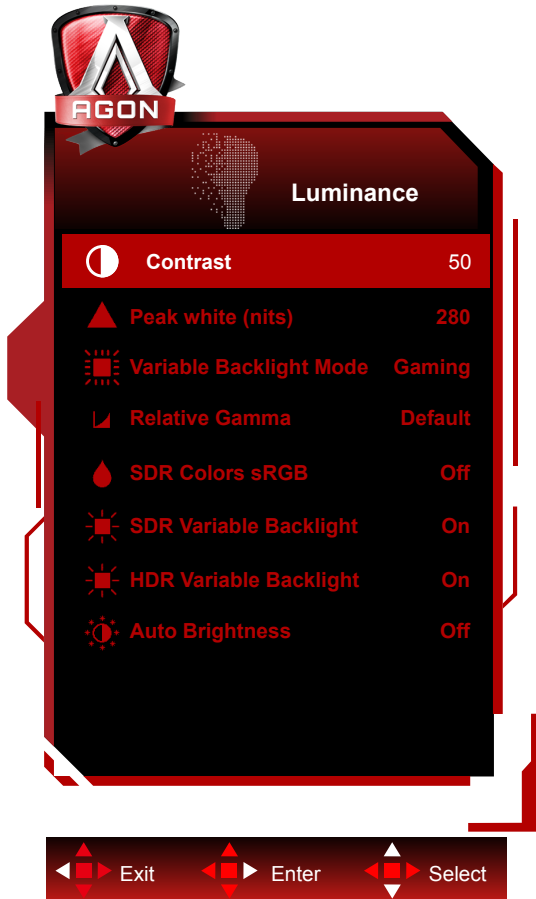

	Contrast	0-100	Contrast from Digital-register.
	Peak white (nits)	40-450	Peak white setting.(Only for SDR)
	Ref. white (nits)	40-450	Ref. white setting.(Only for HDR)
	Variable Backlight Mode	Gaming/Hybrid/Desktop	Variable Backlight Mode setting
	Relative Gamma	-0.4/-0.2/ Default/+0.2/+0.4	Relative Gamma setting.
	SDR Colors sRGB	Off/On	Disable or Enable SDR Colors sRGB.
	SDR Variable Backlight	Off/On	Disable or Enable SDR Variable Backlight.
	HDR Variable Backlight	Off/On	Disable or Enable HDR Variable Backlight.
Auto Brightness	Off/On	Enable automatic brightness. (By Luminance (Light) sensor)	

G-SYNC® Processor

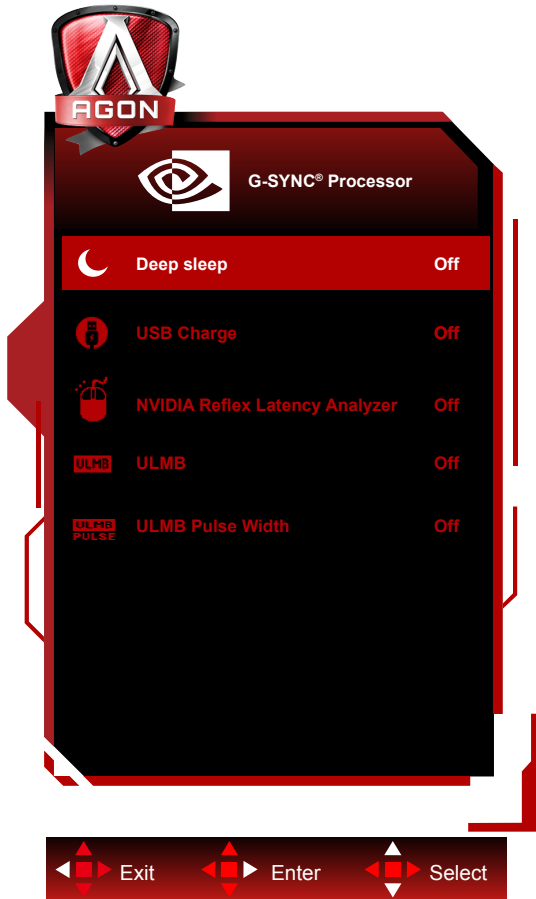



	Deep sleep	OFF/ON	Set the “allow deep sleep mode” to ON or OFF. The deep sleep mode will turn the FPGA completely off after a certain amount of time when either the user presses the monitor DC power off button or the PC puts the monitor to sleep.	
	USB Charge	OFF/ON	USB function By Model setting	
	NVIDIA Reflex Latency Analyzer (with Mouse Logo)	PC+Display Latency	OFF/ON	
		Monitoring Sensitivity	Low/Medium/High	
		Show Monitoring Rectangle	OFF/ON	
		Rectangle Preset	Centered/Right Handed/Left Handed	
		Rectangle Location		
	Rectangle Size			
ULMB	ON/OFF	Return ULMB capability for the timing associated with the timing index.		
ULMB Pulse Width	10~100	ULMB PWM setting		

Note:

With Nvidia® Ultra Low Motion Blur(ULMB) technology, objects in motion look sharper than they do during standard operation -even at high refresh rates such as 144Hz,240Hz.

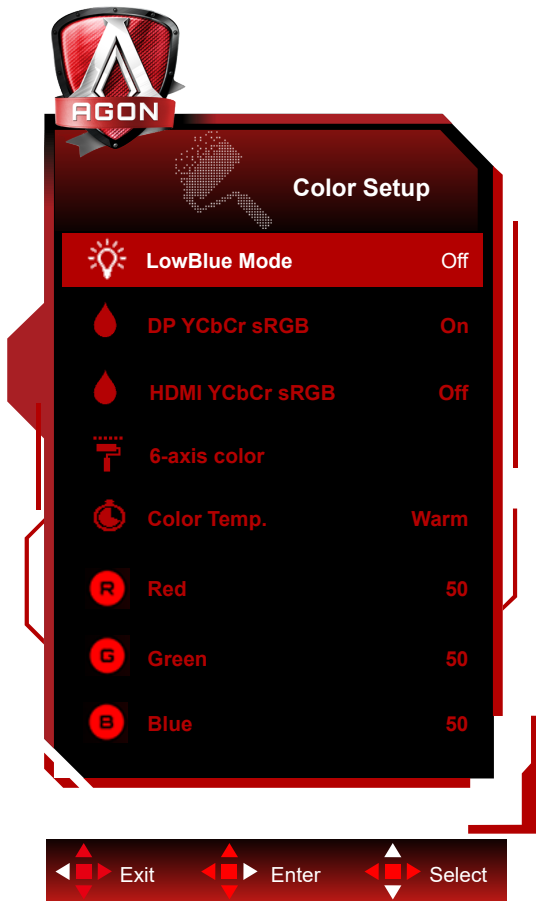
Color Setup



	LowBlue Mode	Off / Multimedia / Internet / Office / Reading	Decrease blue light wave by controlling color temperature.	
	DP YCbCr sRGB	Off/On	Disable or Enable DP YCbCr sRGB.	
	HDMI YCbCr sRGB	Off/On	Disable or Enable HDMI YCbCr sRGB.	
	6-axis color	Red color	0-255	
		Green color	0-255	
		Blue color	0-255	
		Cyan color	0-255	
		Yellow color	0-255	
		Magenta color	0-255	
	Color Temp.	Warm		Recall Warm Color Temperature from EEPROM.
		Normal		Recall Normal Color Temperature from EEPROM.
		Cool		Recall Cool Color Temperature from EEPROM.
		User		Red Gain from Digital-register Green Gain Digital-register. Blue Gain from Digital-register
Red	0-100		Red gain from Digital-register.	
Green	0-100		Green gain from Digital-register.	
Blue	0-100		Blue gain from Digital-register.	

DP YCbCr sRGB

Gamma curve selection for YCbCr formats on DP input in SDR mode; get/set methods (returns off or on):

When enabled (default), the DP input will use sRGB gamma to display YCbCr inputs.

When disabled, the DP input will use BT1886 gamma to display YCbCr inputs.

Default is: ON

HDMI YCbCr sRGB

Gamma curve selection for YCbCr formats on HDMI input in SDR mode; get/set methods (returns off or on):

When enabled, the HDMI input will use sRGB gamma to display YCbCr inputs.

When disabled (default), the HDMI input will use BT1886 gamma to display YCbCr inputs.

Default is: OFF

Audio

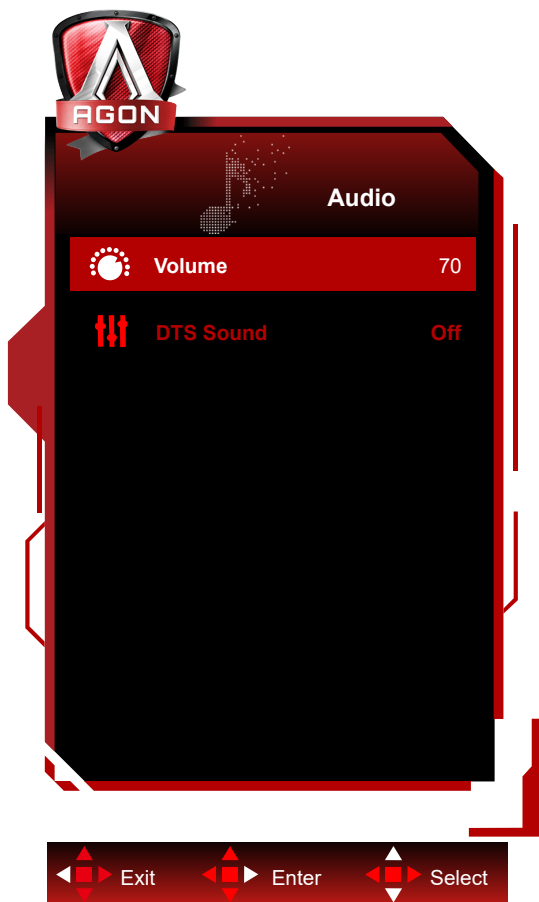

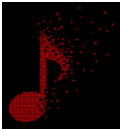
	Volume	0-100	Adjust volume setting
	DTS Sound	Off/On	DTS On/Off.

Light FX

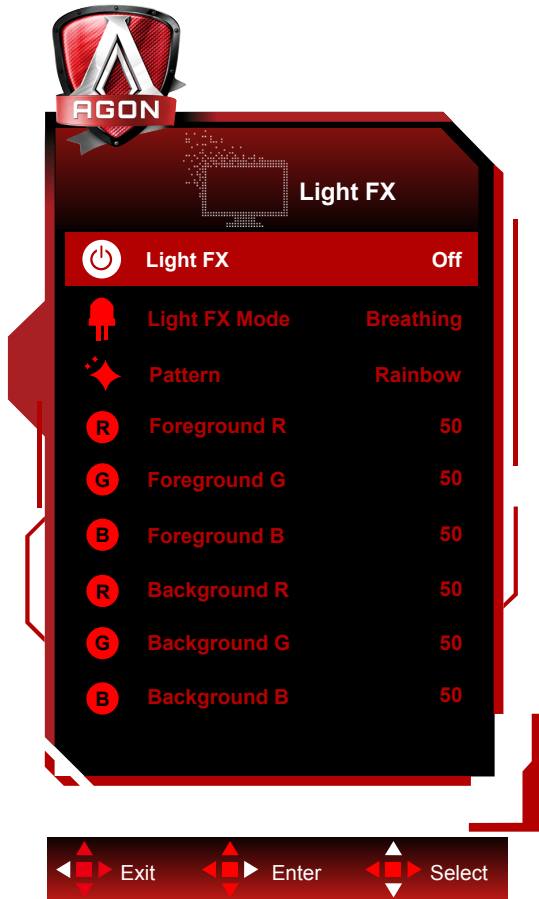

	Light FX	Off / Low / Medium / Strong	Select the intensity of Light FX.
	Light FX Mode	Static / Dark Point Sweep / Gradient Shift / Spread Fill / Drip Fill / Spreading Drip Fill / Breathing / Light Point Sweep / Zoom / Rainbow / Water Wave / Flashing / Demo	Select Light FX Mode
	Pattern	Red / Green / Blue / Rainbow / User Define	Select Light FX Pattern
	Foreground R	0-100	User can adjust Light FX foreground color, when Pattern setting to user define
	Foreground G		
	Foreground B		
	Background R	0-100	User can adjust Light FX background color, when Pattern setting to user define
	Background G		
Background B			

Extra

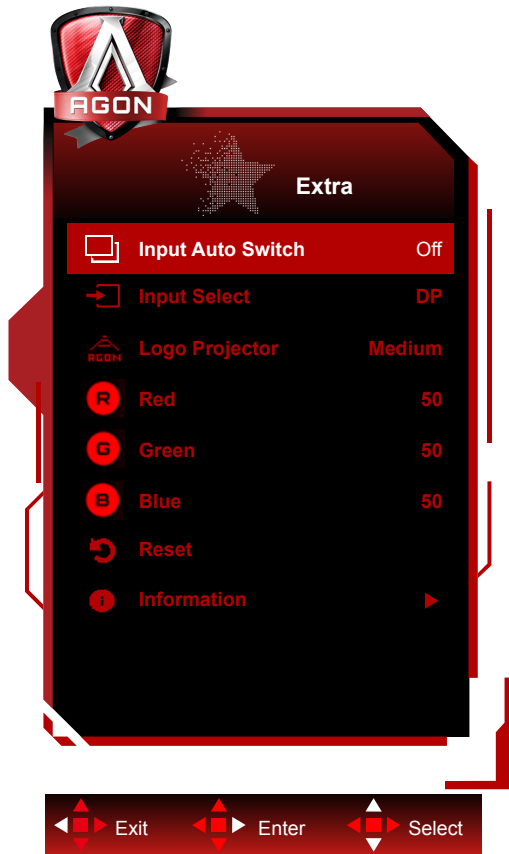

	Input Auto Switch	Off/On	Disable or Enable Input Auto Switch.	
	Input Select	HDMI1/HDMI2/DP	Select Input Signal Source	
	Logo Projector	Off/Weak/Medium/Strong	It's projection logo function.	
	Red	0 ~ 100	Red gain from Digital-register.	
	Green	0 ~ 100	Green gain from Digital-register.	
	Blue	0 ~ 100	Blue gain from Digital-register.	
	Reset	Yes or No	Reset the menu to default	
	Information	Resolution	Ex. 1920x1080	
		V. Frequency	Ex: 360Hz	
		Mode	Ex. (Normal/G-Sync).	
Format		Format: (1) - (2) (1)Unknown/RGB444/YCbCr444/YCbCr422 (2)Unknown/sRGB/BT601/BT709/BT2020 "		
Range		Unknown/Full/Limited		
EOTF		Unknown/SDR-sRGB/SDR-BT1886/ HDR-ST2084		
OD Active				
Mouse	Analyzer Enable/Disable			

OSD Setup

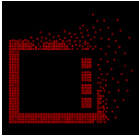

	Language		Select the OSD language
	Timeout	10-120	Adjust the OSD Timeout
	H. Position	0-100	Adjust the horizontal position of OSD
	V. Position	0-100	Adjust the vertical position of OSD
	Transparence	0-100	Adjust the transparence of OSD
	Break Reminder	on /off	Break reminder if the user continuously work for more than 1hrs

LED Indicator

Status	LED Color
Full Power Mode	White
Active-off Mode	Orange

Troubleshoot

Problem & Question	Possible Solutions
Power LED Is Not ON	Make sure the power button is ON and the Power Cord is properly connected to a grounded power outlet and to the monitor.
No images on the screen	<ul style="list-style-type: none"> ● Is the power cord connected properly? Check the power cord connection and power supply. ● Is the cable connected correctly? (Connected using the DP cable) Check the DP cable connection. (Connected using the HDMI cable) Check the HDMI cable connection. ● If the power is on, reboot the computer to see the initial screen (the login screen), which can be seen. If the initial screen (the login screen) appears, boot the computer in the applicable mode (the safe mode for Windows 7/8/10) and then change the frequency of the video card. (Refer to the Setting the Optimal Resolution) If the initial screen (the login screen) does not appear, contact the Service Center or your dealer. ● Can you see "Input Not Supported" on the screen? You can see this message when the signal from the video card exceeds the maximum resolution and frequency that the monitor can handle properly. Adjust the maximum resolution and frequency that the monitor can handle properly. ● Make sure the AOC Monitor Drivers are installed.
Picture Is Fuzzy & Has Ghosting Shadowing Problem	Adjust the Contrast and Brightness Controls. Press to auto adjust. Make sure you are not using an extension cable or switch box. We recommend plugging the monitor directly to the video card output connector on the back.
Picture Bounces, Flickers Or Wave Pattern Appears In The Picture	Move electrical devices that may cause electrical interference as far away from the monitor as possible. Use the maximum refresh rate your monitor is capable of at the resolution you are using.
Monitor Is Stuck In Active Off-Mode"	The Computer Power Switch should be in the ON position. The Computer Video Card should be snugly fitted in its slot. Make sure the monitor's video cable is properly connected to the computer. Inspect the monitor's video cable and make sure no pin is bent. Make sure your computer is operational by hitting the CAPS LOCK key on the keyboard while observing the CAPS LOCK LED. The LED should either turn ON or OFF after hitting the CAPS LOCK key.
Missing one of the primary colors (RED, GREEN, or BLUE)	Inspect the monitor's video cable and make sure that no pin is damaged. Make sure the monitor's video cable is properly connected to the computer.
Picture has color defects (white does not look white)	Adjust RGB color or select desired color temperature.
Horizontal or vertical disturbances on the screen	Use Windows 7/8/10 shut-down mode to adjust CLOCK and FOCUS. Press to auto-adjust.

Specification

General Specification

Panel	Model name	AG254FG		
	Driving system	TFT Color LCD		
	Viewable Image Size	62.2 cm diagonal		
	Pixel pitch	0.2829mm(H) x 0.2802mm(V)		
	Display Color	16.7M Colors		
Others	Horizontal scan range	30~280kHz (HDMI) 30~400kHz (DP)		
	Horizontal scan Size(Maximum)	543.168 mm		
	Vertical scan range	48~240Hz (HDMI) 1~360Hz (DP)		
	Vertical Scan Size(Maximum)	302.616 mm		
	Optimal preset resolution	1920 x 1080@60Hz		
	Max resolution	1920 x 1080@240Hz (HDMI) 1920 x 1080@360Hz (DP)		
	Plug & Play	VESA DDC2B/CI		
	Power Source	20Vdc, 6.0A		
	Power Consumption	Typical (default brightness and contrast)	38W	
	Max. (Brightness = 100, contrast =100)	≤100W		
	Standby mode	≤0.5W		
Physical Characteristics	Connector Type	HDMI/ DP/ USB/ Earphone out/ Microphone In		
	Signal Cable Type	Detachable		
Environmental	Temperature	Operating	0°~ 40°	
		Non-Operating	-25°~ 55°	
	Humidity	Operating	10% ~ 85% (non-condensing)	
		Non-Operating	5% ~ 93% (non-condensing)	
	Altitude	Operating	0~ 5000 m (0~ 16404ft)	
		Non-Operating	0~ 12192m (0~ 40000ft)	



Preset Display Modes

STANDARD	RESOLUTION	HORIZONTAL FREQUENCY(kHz)	VERTICAL FREQUENCY(Hz)
VGA	640 x 480 (60p Hz)	31.469	59.94
DOS MODE	720 x 480 (60p Hz)	29.855	59.71
SD	720 x 576 (50p Hz)	31.25	50
SVGA	800 x 600 (60p Hz)	37.879	60.317
XGA	1024 x 768 (60p Hz)	48.363	60.004
HD	1280 x 720 (60p Hz)	44.772	59.885
Full HD	1920 x 1080 (60p Hz)	67.5	60
Full HD	1920 x 1080 (120p Hz)	137.259	119.982
Full HD	1920 x 1080 (144p Hz)	158.113	144.001
Full HD	1920 x 1080 (240p Hz)	274.519	239.964
Full HD (for DP)	1920 x 1080 (360p Hz)	399.6	360

Pin Assignments



19-Pin Color Display Signal Cable

Pin No.	Signal Name	Pin No.	Signal Name	Pin No.	Signal Name
1.	TMDS Data 2+	9.	TMDS Data 0-	17.	DDC/CEC Ground
2.	TMDS Data 2 Shield	10.	TMDS Clock +	18.	+5V Power
3.	TMDS Data 2-	11.	TMDS Clock Shield	19.	Hot Plug Detect
4.	TMDS Data 1+	12.	TMDS Clock-		
5.	TMDS Data 1Shield	13.	CEC		
6.	TMDS Data 1-	14.	Reserved (N.C. on device)		
7.	TMDS Data 0+	15.	SCL		
8.	TMDS Data 0 Shield	16.	SDA		

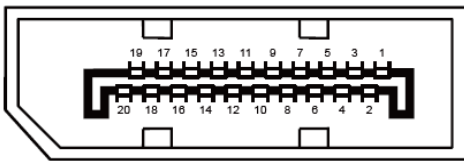

20-Pin Color Display Signal Cable

Pin No.	Signal Name	Pin No.	Signal Name
1	ML_Lane 3 (n)	11	GND
2	GND	12	ML_Lane 0 (p)
3	ML_Lane 3 (p)	13	CONFIG1
4	ML_Lane 2 (n)	14	CONFIG2
5	GND	15	AUX_CH(p)
6	ML_Lane 2 (p)	16	GND
7	ML_Lane 1 (n)	17	AUX_CH(n)
8	GND	18	Hot Plug Detect
9	ML_Lane 1 (p)	19	Return DP_PWR
10	ML_Lane 0 (n)	20	DP_PWR

Plug and Play

Plug & Play DDC2B Feature

This monitor is equipped with VESA DDC2B capabilities according to the VESA DDC STANDARD. It allows the monitor to inform the host system of its identity and, depending on the level of DDC used, communicate additional information about its display capabilities.

The DDC2B is a bi-directional data channel based on the I2C protocol. The host can request EDID information over the DDC2B channel.



For DTS patents, see <http://patents.dts.com>. Manufactured under license from DTS Licensing Limited. DTS, the Symbol, & DTS and the Symbol together are registered trademarks, and DTS Sound is a trademark of DTS, Inc. © DTS, Inc. All Rights Reserved.