

x530L Series

Stackable Gigabit Layer 3+ Ethernet Switches

AlliedWare Plus™ v5.4.9

AT-x530L-52GPX

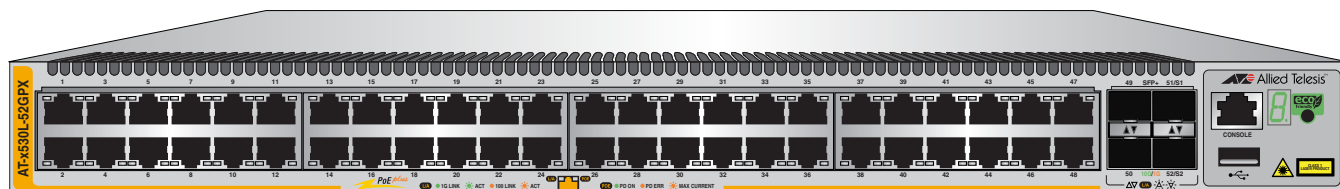

Installation Guide for Stand-alone Switches

Copyright © 2019 Allied Telesis, Inc.

All rights reserved. No part of this publication may be reproduced without prior written permission from Allied Telesis, Inc.

Allied Telesis, VCStack, and the Allied Telesis logo are trademarks of Allied Telesis, Incorporated. All other product names, company names, logos or other designations mentioned herein are trademarks or registered trademarks of their respective owners.

Allied Telesis, Inc. reserves the right to make changes in specifications and other information contained in this document without prior written notice. The information provided herein is subject to change without notice. In no event shall Allied Telesis, Inc. be liable for any incidental, special, indirect, or consequential damages whatsoever, including but not limited to lost profits, arising out of or related to this manual or the information contained herein, even if Allied Telesis, Inc. has been advised of, known, or should have known, the possibility of such damages.

Electrical Safety and Emissions Standards

This product meets the following standards.

U.S. Federal Communications Commission

Radiated Energy

Note: This equipment has been tested and found to comply with the limits for a Class A digital device pursuant to Part 15 of FCC Rules. These limits are designed to provide reasonable protection against harmful interference when the equipment is operated in a commercial environment. This equipment generates, uses, and can radiate radio frequency energy and, if not installed and used in accordance with this instruction manual, may cause harmful interference to radio communications. Operation of this equipment in a residential area is likely to cause harmful interference in which case the user will be required to correct the interference at his own expense.

Note: Modifications or changes not expressly approved of by the manufacturer or the FCC, can void your right to operate this equipment.

Industry Canada

This Class A digital apparatus complies with Canadian ICES-003.

Cet appareil numérique de la classe A est conforme à la norme NMB-003 du Canada.

RFI Emissions: FCC Class A, EN55032 Class A, EN61000-3-2, EN61000-3-3, VCCI Class A, C-TICK, CE

Warning: In a domestic environment this product may cause radio interference in which case the user may be required to take adequate measures.

EMC (Immunity): EN55024

Electrical Safety: EN60950-1 (TUV), UL 60950-1 (CUL_{US})



Laser Safety

EN60825

Translated Safety Statements

Important: Safety statements that have the  symbol are translated into multiple languages in the *Translated Safety Statements* document at www.alliedtelesis.com/library.

Remarque: Les consignes de sécurité portant le symbole  sont traduites dans plusieurs langues dans le document *Translated Safety Statements*, disponible à l'adresse www.alliedtelesis.com/library.

Contents

Preface:	11
Document Conventions	12
Contacting Allied Telesis	13
Chapter 1: Overview	15
Front and Rear Panels	16
Management Panel	17
Features	18
AT-x530L-52GPX Model	18
Twisted Pair Ports	18
Power Over Ethernet	19
SFP+ Transceiver Ports	19
LEDs	19
Installation Options	20
Management Software and Interfaces	20
Management Methods	20
Twisted Pair Ports	21
Speed	21
Duplex Mode	22
Wiring Configuration	22
Maximum Distance	22
Cable Requirements	23
Port Pinouts	23
LEDs	23
Power Over Ethernet	25
PoE Standards	25
Powered Device Classes	26
Power Budget	26
Port Prioritization	26
Wiring Implementation	27
SFP+ Transceiver Ports	29
SFP and SFP+ Transceivers	29
LEDs	29
eco-friendly Button	31
VCStack Feature	32
Switch ID LED	33
USB Port	35
Console Port	36
Power Supply	37
Chapter 2: Beginning the Installation	39
Reviewing Safety Precautions	40
Choosing a Site for the Switch	44
Unpacking the Switch	45
Chapter 3: Installing the Switch on a Table	47
Installing the Bumper Feet	48
Chapter 4: Installing the Switch in an Equipment Rack	51
Installing the Switch in an Equipment Rack	52
Required Items	52

Switch Orientations in the Equipment Rack.....	52
Installing the Switch	53
Chapter 5: Installing the Switch on a Wall	57
Switch Orientations on a Wall.....	58
Installation Guidelines.....	59
Tools and Material	60
Plywood Base for a Wall with Wooden Studs.....	61
Installing a Plywood Base.....	64
Installing the Switch on a Plywood Base	65
Installing the Switch on a Concrete Wall.....	67
Chapter 6: Powering On the Switch	71
Powering On the Switch.....	72
Monitoring the Initialization Processes.....	75
Chapter 7: Configuring the Switch for Stand-alone Operations	79
Determining the Stand-alone or Stacking Status of the Switch	80
Starting a Local Management Session	81
Disabling the VCStack Feature.....	83
Saving Your Changes and Rebooting the Switch.....	85
Specifying Ports in the Command Line Interface for Stand-alone Switches.....	86
Chapter 8: Cabling the Networking Ports	87
Cabling Twisted Pair Ports.....	88
Guidelines to Handling SFP and SFP+ Transceivers	89
Installing SFP or SFP+ Transceivers in the Switches.....	90
Installing AT-SP10TW Direct Connect Twinax Cables in the Switches.....	93
Chapter 9: Troubleshooting	95
Appendix A: Technical Specifications	99
Physical Specifications	100
Environmental Specifications.....	101
Power Specifications.....	102
Certifications	103
RJ-45 Twisted Pair Port Pinouts	104
RJ-45 Style Serial Console Port Pinouts	106
USB Port	107

Figures

Figure 1: AT-x530L-52GPX Front Panel.....	16
Figure 2: AT-x530L-52GPX Back Panel.....	16
Figure 3: Management Panel.....	17
Figure 4: AT-x530L-52GPX Twisted Pair Ports.....	23
Figure 5: Link and Activity LEDs for the 1 Gbps/10 Gbps SFP+ Ports.....	29
Figure 6: Switch ID LED.....	33
Figure 7: Switch ID LED Description.....	34
Figure 8: Switch Shipping Box.....	45
Figure 9: Accessory Kit Items.....	46
Figure 10: Parts of the Bumper Feet.....	48
Figure 11: Holes for Bumper Feet.....	48
Figure 12: Inserting the Rivet Housing into the Bumper Foot.....	49
Figure 13: Placing the Bumper Foot on a Base Corner Hole.....	49
Figure 14: Inserting the Rivet into the Bumper Foot.....	50
Figure 15: Bracket Holes on the Switch.....	52
Figure 16: Switch Orientations in an Equipment Rack.....	53
Figure 17: Example of Attaching the Brackets to the Switch.....	54
Figure 18: Installing the Switch in an Equipment Rack.....	55
Figure 19: Positioning the AT-x530L-52GPX Switch on the Wall.....	58
Figure 20: Switch on the Wall with a Plywood Base.....	61
Figure 21: Installing the Plywood Base to the Wall.....	62
Figure 22: Installing the Switch on the Plywood Base.....	63
Figure 23: Installing Four Brackets on the AT-x530L-52GPX Switches.....	65
Figure 24: Securing the AT-x530L-52GPX Switches to the Plywood Base.....	66
Figure 25: Marking the Locations of the Bracket Holes on a Concrete Wall.....	68
Figure 26: Installing the Switch on a Concrete Wall.....	69
Figure 27: Installing the Power Cord Retaining Clip.....	72
Figure 28: Connecting the AC Power Cords.....	73
Figure 29: Lowering the Power Cord Retaining Clips.....	73
Figure 30: Connecting the Power Cords to an AC Power Source.....	74
Figure 31: Switch Initialization Messages.....	75
Figure 32: Switch Initialization Messages (Continued).....	76
Figure 33: Switch Initialization Messages (Continued).....	77
Figure 34: Connecting the Management Cable to the Console Port.....	81
Figure 35: SHOW STACK Command.....	83
Figure 36: Moving to the Global Configuration Mode.....	84
Figure 37: Disabling VCStack.....	84
Figure 38: Returning to the Privileged Exec Mode.....	85
Figure 39: Saving the Changes with the WRITE Command.....	85
Figure 40: PORT Parameter in the Command Line Interface.....	86
Figure 41: Removing the Dust Plug from an SFP Port.....	90
Figure 42: Installing an SFP Transceiver.....	91
Figure 43: Removing the Dust Cover from an SFP or SFP+ Transceiver.....	91
Figure 44: Positioning the SFP or SFP+ Handle in the Upright Position.....	92
Figure 45: Connecting a Fiber Optic Cable to an SFP or SFP+ Transceiver.....	92
Figure 46: Installing AT-SP10TW Cables.....	94
Figure 47: RJ-45 Socket Pin Layout (Front View).....	104

Tables

Table 1: Basic Features	18
Table 2: AT-x530L-52GPX Switch Twisted Pair Port Specifications	21
Table 3: AT-x530L-52GPX Twisted Pair Ports 1 - 48 LED Functions	23
Table 4: IEEE Powered Device Classes	26
Table 5: Link and Activity Status LEDs for the 1 Gbps and 10 Gbps Ports	30
Table 6: PORT Parameter Format	86
Table 7: Product Dimensions	100
Table 8: Product Weights	100
Table 9: Ventilation Requirements	100
Table 10: Environmental Specifications	101
Table 11: Maximum Power Consumption	102
Table 12: Input Voltage	102
Table 13: Heat Dissipation	102
Table 14: Product Certifications	103
Table 15: Pin Signals at 10M/100M	104
Table 16: Pin Signals at 1 Gbps	105
Table 17: RJ-45 Style Serial Console Port Pin Signals	106
Table 18: USB Port Pin Signals	107

Preface

This guide contains the installation instructions for the x530L Series of stackable Gigabit, Layer 3+ Ethernet switches. This preface contains the following sections:

- “Document Conventions” on page 12
- “Contacting Allied Telesis” on page 13

Note

This guide explains how to install the switches as stand-alone units. For instructions on how to build a stack with Virtual Chassis Stacking (VCStack™), refer to the *x530L Series Installation Guide for Virtual Chassis Stacking*.

Document Conventions

This document uses the following conventions:

Note

Notes provide additional information.



Caution

Cautions inform you that performing or omitting a specific action may result in equipment damage or loss of data.



Warning

Warnings inform you that performing or omitting a specific action may result in bodily injury.

Contacting Allied Telesis

If you need assistance with this product, you can contact Allied Telesis technical support by going to the Support & Services section of the Allied Telesis web site at **www.alliedtelesis.com/support**. You can find links for the following services on this page:

- ❑ 24/7 Online Support — Enter our interactive support center to search for answers to your product questions in our knowledge database, to check support tickets, to learn about Return Merchandise Authorizations (RMAs), and to contact Allied Telesis technical experts.
- ❑ USA and EMEA phone support — Select the phone number that best fits your location and customer type.
- ❑ Hardware warranty information — Learn about Allied Telesis warranties and register your product online.
- ❑ Replacement Services — Submit an RMA request via our interactive support center.
- ❑ Documentation — View the most recent installation and user guides, software release notes, white papers, and data sheets for your products.
- ❑ Software Downloads — Download the latest software releases for your managed products.

For sales or corporate contact information, select your region and country and then go to **www.alliedtelesis.com/contact**.

Chapter 1

Overview

This chapter contains the following sections:

- “Front and Rear Panels” on page 16
- “Management Panel” on page 17
- “Features” on page 18
- “Twisted Pair Ports” on page 21
- “Power Over Ethernet” on page 25
- “SFP+ Transceiver Ports” on page 29
- “eco-friendly Button” on page 31
- “VCStack Feature” on page 32
- “Switch ID LED” on page 33
- “USB Port” on page 35
- “Console Port” on page 36
- “Power Supply” on page 37

Note

This guide explains how to install the switch as a stand-alone unit. For instructions on how to build a stack with Virtual Chassis Stacking (VCStack™), refer to the *x530L Series Installation Guide for Virtual Chassis Stacking*.

Front and Rear Panels

The front panel of the AT-x530L-52GPX switch is shown in Figure 1.

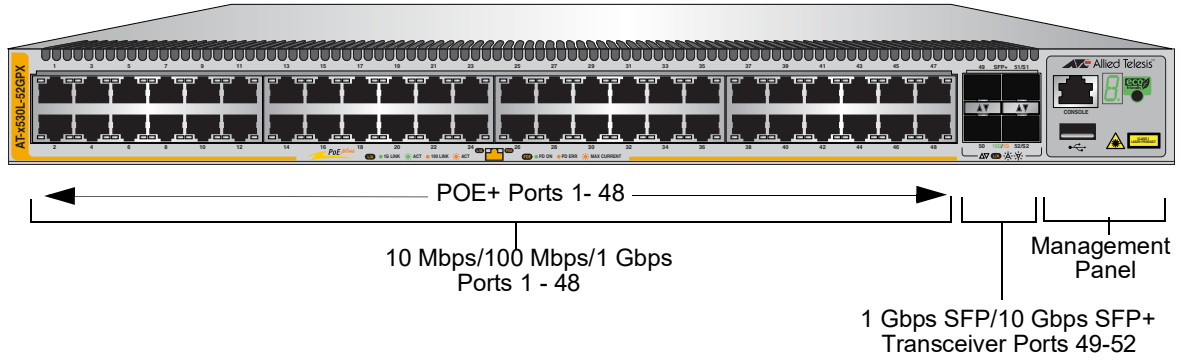

Figure 1. AT-x530L-52GPX Front Panel

The back panel of the AT-x530L-52GPX switch is shown in Figure 2.

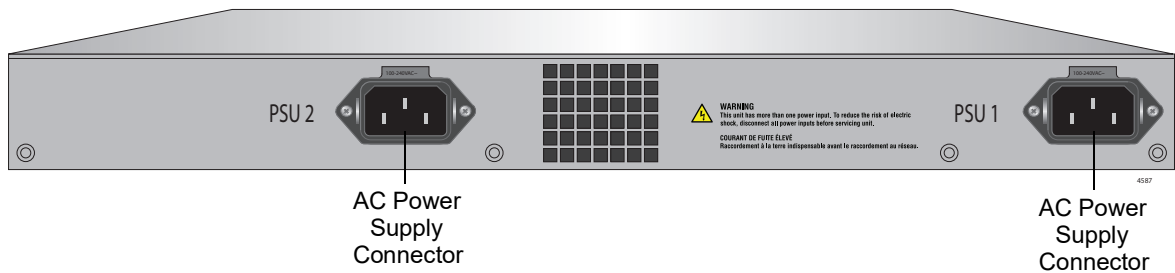

Figure 2. AT-x530L-52GPX Back Panel

Management Panel

Figure 3 identifies the components on the management panel.

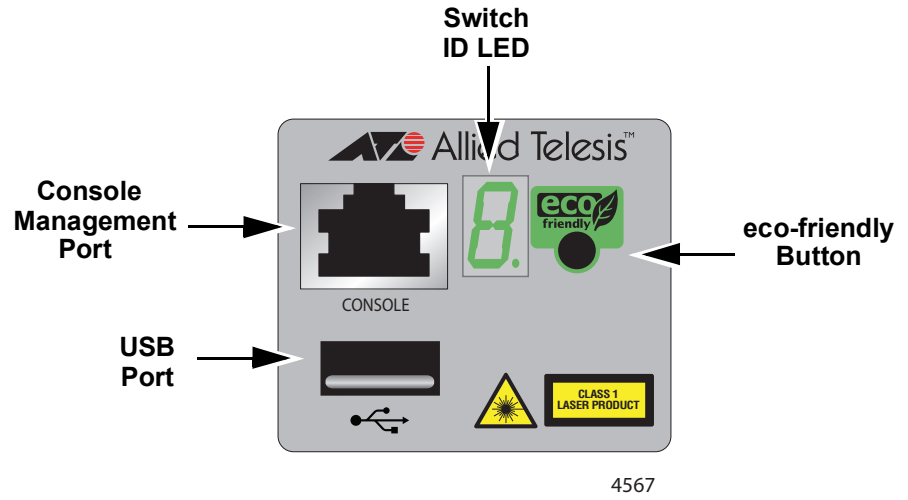

Figure 3. Management Panel

Features

The AT-x530L-52GPX switch is a stackable Gigabit, Layer 3+ Ethernet switch. The following sections list the features.

AT-x530L-52GPX Model

Table 1 lists the basic features for the switch model.

Table 1. Basic Features

Feature	AT-x530L-52GPX (PoE+)
10 Mbps, 100 Mbps and 1 Gbps PoE+ Twisted Pair Ports	48
1 Gbps SFP and 10 Gbps SFP+ Transceiver Ports	4
VCStack	Yes

Each switch model comes with two pre-installed power supplies. They are not field-replaceable.

Twisted Pair Ports

The forty-eight twisted pair ports on the AT-x530L-52GPX switch have the following features:

- Ports 1 to 48 support 10 Mbps, 100 Mbps and 1 Gbps operation
- 100 meters (328 feet) maximum operating distance per port
- Auto-Negotiation for speed
- Half-duplex mode at 10/100 Mbps
- Full-duplex mode at 10/100/1000 Mbps
- Auto-MDI/MDI-X at 10/100/1000 Mbps
- Power over Ethernet (PoE+) supported on all 48 ports
- Port Link/Activity (L/A) and Power over Ethernet (PoE) LEDs

Power Over Ethernet

The basic features of PoE+ on the twisted pair ports on the AT-x530L-52GPX switch is:

- Supported on all ports
- Supports PoE (15.4 watts maximum) and PoE+ (30 watts maximum) powered devices
- 740W maximum power budget
- Supports powered device classes 0 to 4
- Port prioritization
- Mode A wiring
- IEEE802.3af/at compliant

SFP+ Transceiver Ports

The four SFP+ transceiver ports (49-52) in the AT-x530L-52GPX support the following types of transceivers:

- 1 Gbps SX/LX SFP transceivers
- 10 Gbps SR/LR SFP+ fiber optic transceivers
- 10 Gbps AT-SP10TW direct connect twinax cables with SFP+ transceiver-style connectors

Note

For a current list of supported transceiver modules refer to the *x530L Series Data Sheet*

The following restrictions on SFP+ transceivers apply:

- 100 Mbps transceivers are not supported
- Supports full-duplex mode only

SFP and SFP+ transceivers must be purchased separately. For a list of supported transceivers, refer to the product data sheet on the Allied Telesis web site.

LEDs

The port LEDs are:

- Link/activity LEDs for the twisted pair ports on all switches
- Link/activity LEDs for the SFP and SFP+ transceiver ports on all switches
- PoE+ LEDs for the twisted pair ports on all switches
- Switch ID number LED

Installation Options

The installation options are:

- Desk or tabletop
- 19-inch equipment rack
- Wood or concrete wall

Management Software and Interfaces

The management software and interfaces are:

- AlliedWare Plus Management Software
- Command line interface (CLI)
- Web browser interface

Management Methods

The following methods are used for managing the switch:

- Local management through the Console port
- Remote Telnet or Secure Shell management
- Remote HTTP or HTTPS web browser management
- SNMPv1, v2c, and v3

Twisted Pair Ports

The specifications of the twisted pair ports are listed in Table 2.

Table 2. AT-x530L-52GPX Switch Twisted Pair Port Specifications

Specification	Description
Port Speed	Ports 1 - 48: 10 Mbps, 100 Mbps or 1 Gbps. 10 Mbps: Set the port speed manually. 100 Mbps: Set the port speed manually or with Auto-Negotiation at 100 Mbps. 1 Gbps: The port speed is set with Auto-Negotiation only. The default is Auto-Negotiation for all ports.
Duplex Mode	Ports 1 - 48: 10 Mbps: Full- or half-duplex mode. 100 Mbps: Full- or half-duplex mode. 1 Gbps: Full-duplex mode only. Supports Auto-Negotiation at 10 Mbps and 100 Mbps.
Maximum Distance	100 meters (328 feet).
Power over Ethernet	PoE (15.4W maximum per port) and PoE+ (30W maximum per port).
Maximum Power Budget	740W (370W per power supply).
PoE Mode	Mode A.
Connector	8-pin RJ-45.

Speed On the AT-x530L-52GPX switch, ports 1 to 48 operate at 10 Mbps, 100 Mbps or 1 Gbps. The ports must be set to Auto-Negotiation to operate at 1 Gbps. 10 Mbps and 100 Mbps can be set with Auto-Negotiation or manually. Auto-Negotiation is the default setting.

Note

The ports must be set to Auto-Negotiation to function at 1 Gbps and are not compatible with devices that are not IEEE 802.3u-compliant.

Duplex Mode

The twisted pair ports can operate in either half- or full-duplex mode at 10 Mbps and 100 Mbps, and full-duplex only at higher speeds.

The duplex mode of a port operating at 10 Mbps or 100 Mbps, like port speed, can be set manually using the management software or automatically with Auto-Negotiation (IEEE 802.3u), the default setting.

The speed and duplex mode settings of a port can be set independently of each other. For example in the case of a 10 Mbps or 100 Mbps port, it can be configured such that its speed is set manually while its duplex mode is established through Auto-Negotiation.

Note

Switch ports default to half-duplex mode when connected to 100 Mbps network devices that do not support Auto-Negotiation. If a network device supports full-duplex only, a duplex mode mismatch can occur, resulting in poor network performance. To prevent this, disable Auto-Negotiation and set the duplex mode manually on ports connected to 10 Mbps or 100 Mbps devices that support full-duplex only.

Wiring Configuration

The wiring configuration of a port operating at 10 Mbps or 100 Mbps can be MDI or MDI-X. The wiring configurations of a switch port and a network device connected with straight-through twisted pair cabling must be opposite, such that one device is using MDI and the other MDI-X. For example, a switch port must be set to MDI-X if it is connected to a network device set to MDI.

The wiring configurations of the ports can be set manually or automatically by the switch with auto-MDI/MDI-X (IEEE 802.3ab-compliant). This feature enables the switch to automatically negotiate with network devices to establish their proper settings.

The MDI and MDI-X settings do not apply when ports are operating at a speed of 1 Gbps.

Maximum Distance

The ports have a maximum operating distance of 100 meters (328 feet).

- Cable Requirements** The category of twisted pair cable requirements are as follows:
- ❑ 10 or 100 Mbps ports: Standard TIA/EIA 568-B-compliant Category 3 unshielded cabling
 - ❑ 1 Gbps ports: Standard TIA/EIA 568-A-compliant Category 5 or TIA/EIA 568-B-compliant Enhanced Category 5 (Cat 5e) unshielded cabling

Port Pinouts Refer to Table 17 on page 106 for the port pinouts of the 100 Mbps and 1 Gbps twisted pair ports.

LEDs Each twisted pair port has two LEDs that display the port status.

AT-x530L-52GPX

The LEDs indicate Link/Activity (L/A) and PoE (PD ON/PD ERR/MAX CURRENT) information. These LEDs are shown in Figure 4.

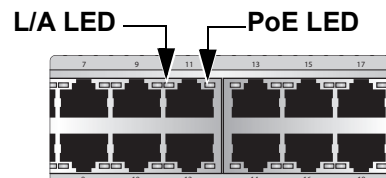

Figure 4. AT-x530L-52GPX Twisted Pair Ports

The states of the AT-x530L-52GPX LEDs are described in Table 3.

Table 3. AT-x530L-52GPX Twisted Pair Ports 1 - 48 LED Functions

LED	Ports	State	Description
L/A	1 - 48	Solid Green	The port has established a 1 Gbps link to a network device.
		Flashing Green	The port is transmitting or receiving data at 1 Gbps.
		Solid Amber	The port has established a 10 Mbps or 100 Mbps link to a network device.
		Flashing Amber	The port is transmitting or receiving data at 10 Mbps or 100 Mbps.
		Off	Possible causes of this state are: <ul style="list-style-type: none"> - The port has not established a link with another network device. - The LEDs are turned off. To turn on the LEDs, use the eco-friendly button.

Table 3. AT-x530L-52GPX Twisted Pair Ports 1 - 48 LED Functions (Continued)

LED	Ports	State	Description
PoE	1 - 48	Solid Green	PD On - The switch is delivering power to a powered device connected to the port.
		Solid Amber	PD Error - The switch has shut down PoE on the port because of a fault condition.
		Flashing Amber	PD Max Current - The switch has detected a powered device on the port but is not delivering power to it because doing so would exceed its available power budget.
		OFF	No PD - This LED state can result from the following conditions: <ul style="list-style-type: none"> - The port is not connected to a powered device or the device is powered off. - The port is disabled in the management software. - PoE is disabled on the port. - The LEDs are turned off. To turn on the LEDs, use the eco-friendly button.

Power Over Ethernet

The AT-x530L-52GPX switch features PoE on twisted pair ports. With PoE, the switch supplies DC power to network devices over the same twisted pair cables that carry the network traffic.

PoE can make it easier to install networks. The selection of a location for a network device can be limited by whether there is a power source nearby. This often limits equipment placement or requires the added time and cost of having additional electrical sources installed. With PoE, you can install PoE-compatible devices wherever they are needed without having to worry about whether there are power sources nearby.

A device that provides PoE to network devices is referred to as *power sourcing equipment* (PSE). It functions as a central power source for other network devices.

Devices that receive their power from a PSE are called *powered devices* (PD). Examples include wireless access points, IP telephones, webcams, and even other Ethernet switches.

The AT-x530L-52GPX switch automatically determines whether devices connected to its ports are powered devices. Ports that are connected to network nodes that are not powered devices (that is, devices that receive their power from another power source) function as regular Ethernet ports, without PoE. The PoE feature remains activated on the ports but no power is delivered to the devices.

PoE Standards

The AT-x530L-52GPX switch supports these PoE standards:

- ❑ PoE (IEEE 802.3af): This standard provides up to 15.4 watts at the switch port for powered devices that require up to 13.0 watts.
- ❑ PoE+ (IEEE 802.3at): This standard provides up to 30.0 watts at the switch port for powered devices that require up to 25.5 watts.

Powered Device Classes

Powered devices are grouped into the five classes listed in Table 4. The classes are based on the amount of power the devices require. The switch supports all five classes.

Table 4. IEEE Powered Device Classes

Class	Maximum Power Output from a Switch Port	PD Power Range
0	15.4W	0.44W to 13.0W
1	4.0W	0.44W to 3.84W
2	7.0W	3.84W to 6.49W
3	15.4W	6.49W to 13.0W
4	30.0W	13.0W to 25.5W

Power Budget

The AT-x530L-52GPX switch has two power supplies. Each power supply provides 370W for a total PoE of 740W. This is the total maximum amount of power that the switch can supply to powered devices on the 48 PoE+ twisted pair ports. Under normal operating conditions, the power budget enables the switch to support 48 Class 4 devices with the maximum 25.5W on all PoE+ ports, simultaneously. However, if one of the two power supplies fails or is powered off the power budget decreases by half from 740W to 370W.

Port Prioritization

The power requirements of the PoE devices determine the maximum number of devices the switch can support at one time. So long as the total power requirements of the power devices is less than the power budget of the switch, the switch can supply power to all the devices. But if the total power requirements exceed the power budget, the switch denies power to one or more ports using a mechanism referred to as port prioritization.

To determine whether the power requirements of the PoE devices you plan to connect to the switch exceed its power budget, refer to their documentation for their power requirements and add the requirements together. The switch should be able to power all the devices simultaneously as long as the total is below its power budget. If the total exceeds the available power budget, you should consider reducing the number of PoE devices so that all of the devices receive power. Otherwise, the switch powers a subset of the devices, based on port prioritization.

There are three priority levels:

- Critical
- High
- Low

Ports set to the Critical level, the highest priority level, are guaranteed power before any of the ports assigned to the other two priority levels. Ports assigned to the other priority levels receive power only if all the Critical ports are receiving power. Ports that are connected to your most critical powered devices must be assigned to this level. If there is not enough power to support all the ports set to the Critical priority level, power is provided to the ports based on port number, in ascending order.

The High level is the second highest level. Ports set to this level receive power only if all the ports set to the Critical level are already receiving power. If there is not enough power to support all of the ports set to the High priority level, power is provided to the ports based on port number, in ascending order.

The lowest priority level is Low. This is the default setting. Ports set to this level only receive power if all of the ports assigned to the other two levels are already receiving power. As with the other levels, if there is not enough power to support all of the ports set to the Low priority level, power is provided to the ports based on port number, in ascending order.

Power allocation is dynamic. Ports supplying power to powered devices can cease power transmission if the switch power budget is at maximum usage and new powered devices, connected to ports with higher priorities become active.

Wiring Implementation

The IEEE 802.3af standard defines two methods for delivering DC power over twisted pair cable by a switch to powered devices. These methods are known as Modes A and B, and identify the individual wires that carry the DC power within the cable from the switch to powered devices.

Twisted pair cabling typically consists of eight wires. With 100Base-TX devices, the wires connected to pins 1, 2, 3, and 6 on the RJ-45 connectors carry the network traffic while the wires connected to pins 4, 5, 7, and 8 are unused. At higher speeds, all eight wires are used to carry network data.

It takes four wires to deliver DC power to a powered device. With Mode A, power is delivered on pins 1, 2, 3, and 6. These are the same pins in 10Base-T and 100Base-TX devices that carry the network data. With Mode B, power is provided over the spare wires.

The ports on the AT-x530L-52GPX switch deliver power using Mode A.

Powered devices that comply with the IEEE 802.3af standard are required to support both Modes A and B. Legacy devices that do not comply with the standard will work with the switch if they are powered on pins 1, 2, 3, and 6.

SFP+ Transceiver Ports

The AT-x530L-52GPX switch has four ports (ports 49 - 52) for 1 Gbps/10 Gbps SFP or SFP+ transceivers.

SFP and SFP+ Transceivers

See “SFP+ Transceiver Ports” on page 19 for a description and guidelines of the SFP+ transceivers.

SFP or SFP+ transceivers must be purchased separately. For a list of supported transceivers, refer to the product data sheet on the Allied Telesis web site.

LEDs

Each transceiver port has one LED. The LEDs are located between the ports. Refer to Figure 5.

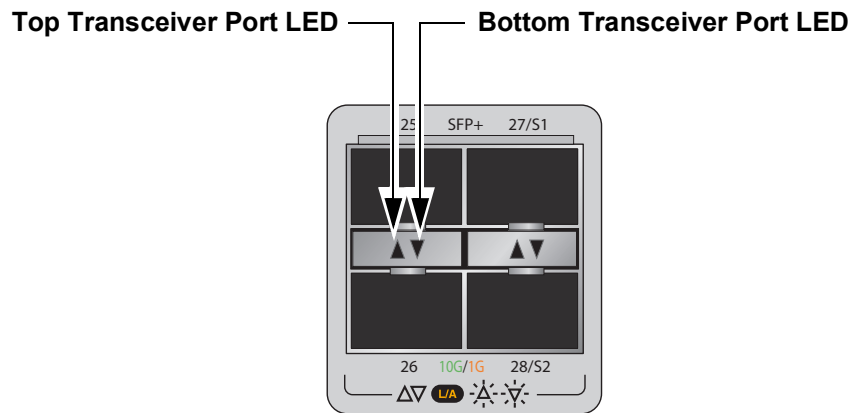

4566

Figure 5. Link and Activity LEDs for the 1 Gbps/10 Gbps SFP+ Ports

The LEDs display link status and activity. The possible LED states are described in Table 5.

Table 5. Link and Activity Status LEDs for the 1 Gbps and 10 Gbps Ports

State	Description
Solid Green	The transceiver has established a 10 Gbps link to a network device.
Flashing Green	The transceiver is transmitting or receiving data in 10 Gbps.
Solid Amber	The transceiver has established a 1 Gbps link to a network device.
Flashing Amber	The transceiver is transmitting or receiving data in 1 Gbps.
Off	Possible causes of this state are: <ul style="list-style-type: none">- The port is empty.- The transceiver has not established a link to a network device.- A non-supported module is installed.- The LEDs are turned off. To turn on the LEDs, use the eco-friendly button.

eco-friendly Button

The eco-friendly button on the front panel of the switch is used to toggle the port LEDs on or off. You can turn off the LEDs to conserve electricity when you are not monitoring the device. You can also toggle the LEDs with the ECOFRIENDLY LED and NO ECOFRIENDLY LED commands in the Global Configuration mode of the command line interface of the AlliedWare Plus management software.

The switch is operating in a low power mode when the LEDs are turned off. Operating the switch in the low power mode does not interfere with the network operations of the device.

The management software on the switch has a command that blinks the LEDs so that you can quickly and easily identify a specific unit among the devices in an equipment rack. It is the FINDME command. The command works on the switch even if you turned off the LEDs with the eco-friendly button or NO ECOFRIENDLY LED command.

Note

Before checking or troubleshooting the network connections to the ports on the switch, you must always check to be sure that the LEDs are on by either pressing the eco-friendly button or issuing the ECOFRIENDLY LED and NO ECOFRIENDLY LED commands in the Global Configuration mode in the command line interface.

VCStack Feature

You can use the switches as stand-alone units or join up to four units with the VCStack feature. The switches of a VCStack act as a single virtual unit. They synchronize their actions so that switching operations (such as spanning tree protocols, virtual LANs, and static port trunks) span across all of the units and ports. Two advantages of stacks are:

- ❑ You can manage multiple units simultaneously, which can simplify network management.
- ❑ You have more flexibility in how you configure some of the features. For instance, a static port trunk on a stand-alone switch can consist of ports from the same switch. In contrast, a static trunk on a stack can have ports from different switches in the same stack.

Note

This guide explains how to install the device as a stand-alone unit. For instructions on VCStack, refer to the *x530L Series Installation Guide for Virtual Chassis Stacking*.

Switch ID LED

The switch ID LED, shown in Figure 6, displays the ID number of the switch. A stand-alone switch has the ID number 0. Switches in a VCStack have the numbers 1 to 8. See Chapter 6, “Powering On the Switch” on page 71.

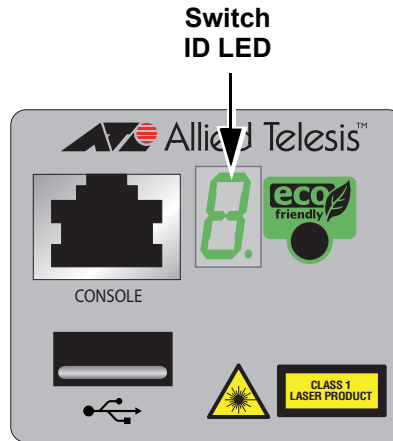

4567

Figure 6. Switch ID LED

The states of the LED when the switch is not operating in the low power mode are shown in Figure 7.

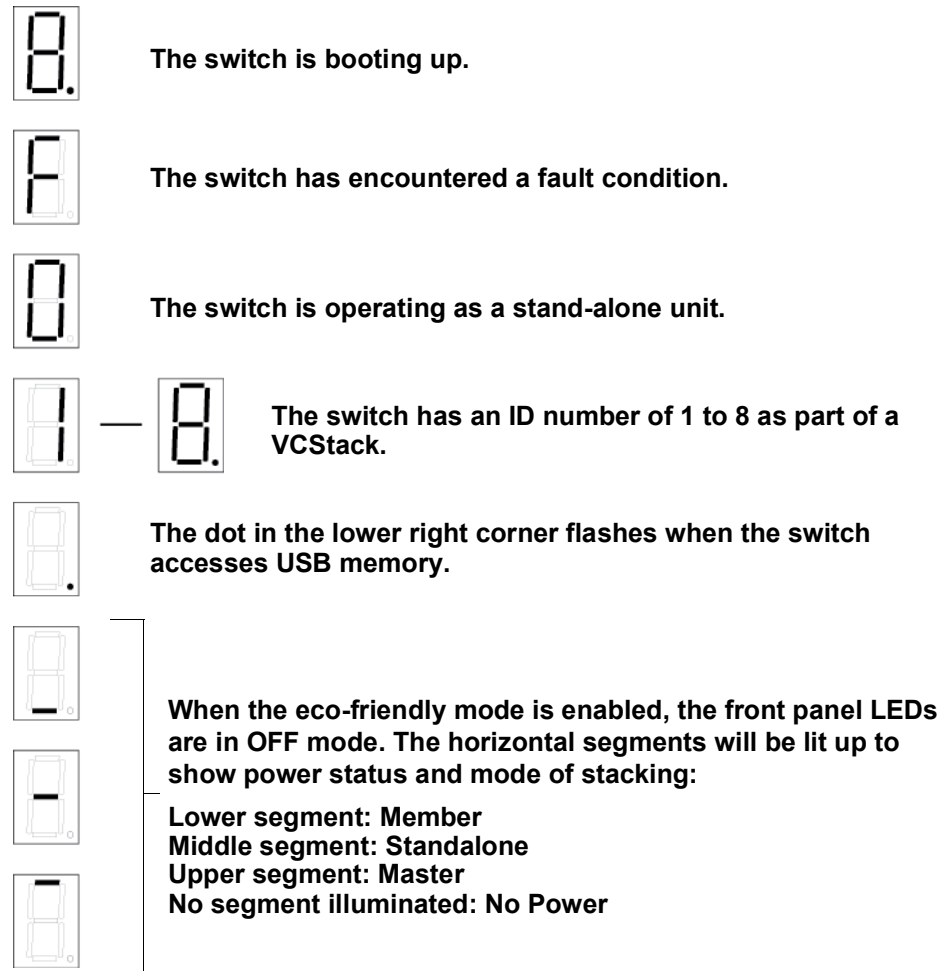

Figure 7. Switch ID LED Description

The switch displays the letter “F” for fault on the ID LED if it detects one of the following problems:

- A cooling fan has failed.
- The internal temperature of the switch has exceeded the normal operating range and the switch may shut down.

Note

You can use the SNMP or the command line management interface to determine the type of fault or faults.

USB Port

The USB port on the management panel is used for the following functions:

- Store configuration files on flash drives.
- Restore configuration files to switches that have lost or corrupted settings.
- Configure replacement units by downloading configuration files from a flash drive.
- Update the management firmware.

The port is USB 2.0-compatible.

Console Port

The Console port is an RS232 serial management port. You use the port to access the AlliedWare Plus management software on the switch to configure the feature settings or monitor status or statistics. This type of management is commonly referred to as local management because you have to be at the physical location of the switch and use the management cable included with the unit. The switch does not have to have an IP address for local management.

To establish a local management session with the switch, use the provided management cable to connect a terminal or a computer with a terminal emulation program to the Console port, which has an RJ-45 style (8P8C) connector. The cable has RJ-45 style (8P8C) and DB-9 (D-sub 9-pin) connectors.

The Console port has the following settings:

- Default baud rate: 9,600 bps (range is 9,600 to 115,200 bps)
- Data bits: 8
- Parity: None
- Stop bits: 1
- Flow control: None

Note

These settings are for a DEC VT100 or ANSI terminal, or an equivalent terminal emulation program.

Power Supply

All x530L Series switches come with dual pre-installed AC power supplies. Refer to “Power Specifications” on page 102 for the input voltage ranges.



Warning

The power cord is used as a disconnection device. To de-energize equipment, disconnect the power cord.  E3

Note

Power supplies are not field-replaceable.

Chapter 2

Beginning the Installation

The chapter contains the following sections:

- “Reviewing Safety Precautions” on page 40
- “Choosing a Site for the Switch” on page 44
- “Unpacking the Switch” on page 45

Reviewing Safety Precautions

Please review the following safety precautions before beginning the installation procedure.

Important: Safety statements that have the  symbol are translated into multiple languages in the *Translated Safety Statements* document at www.alliedtelesis.com/library.

Remarque: Les consignes de sécurité portant le symbole  sont traduites dans plusieurs langues dans le document *Translated Safety Statements*, disponible à l'adresse www.alliedtelesis.com/library.



Warning

Class 1 Laser product.  L1



Warning

Laser Radiation.
Class 1M Laser product.



Warning

Do not stare into the laser beam.  L2



Warning

Do not look directly at the fiber optic ends or inspect the cable ends with an optical lens.  L6



Warning

To prevent electric shock, do not remove the cover. No user-serviceable parts inside. This unit contains hazardous voltages and should only be opened by a trained and qualified technician. To avoid the possibility of electric shock, disconnect electric power to the product before connecting or disconnecting the LAN cables.  E1



Warning

Do not work on equipment or cables during periods of lightning activity.  E2



Warning

Power cord is used as a disconnection device. To de-energize equipment, disconnect the power cord. ⚡ E3



Warning

Class I Equipment. This equipment must be earthed. The power plug must be connected to a properly wired earth ground socket outlet. An improperly wired socket outlet could place hazardous voltages on accessible metal parts. ⚡ E4

Note

Pluggable Equipment. The socket outlet shall be installed near the equipment and shall be easily accessible. ⚡ E5



Caution

Air vents must not be blocked and must have free access to the room ambient air for cooling. ⚡ E6



Warning

Operating Temperatures. This product is designed for a maximum ambient temperature of 50° C. ⚡ E52

Note

All Countries: Install product in accordance with local and National Electrical Codes. ⚡ E8



Warning

Only trained and qualified personnel are allowed to install or replace this equipment. ⚡ E14



Caution

Circuit Overloading: Consideration should be given to the connection of the equipment to the supply circuit and the effect that overloading of circuits might have on overcurrent protection and supply wiring. Appropriate consideration of equipment nameplate ratings should be used when addressing this concern. ⚡ E21



Caution

Risk of explosion if battery is replaced by an incorrect type. Replace only with the same or equivalent type recommended by the manufacturer. Dispose of used batteries according to the manufacturer's instructions.

Attention: Le remplacement de la batterie par une batterie de type incorrect peut provoquer un danger d'explosion. La remplacer uniquement par une batterie du même type ou de type équivalent recommandée par le constructeur. Les batteries doivent être éliminées conformément aux instructions du constructeur.  E22



Warning

Mounting of the equipment in the rack should be such that a hazardous condition is not created due to uneven mechanical loading.  E25



Warning

The chassis may be heavy and awkward to lift. Allied Telesis recommends that you get assistance when mounting the chassis in an equipment rack.  E28

Note

Use dedicated power circuits or power conditioners to supply reliable electrical power to the device.  E27



Warning

This unit might have more than one power cord. To reduce the risk of electric shock, disconnect all power cords before servicing the unit.  E30

Note

If installed in a closed or multi-unit rack assembly, the operating ambient temperature of the rack environment may be greater than the room ambient temperature. Therefore, consideration should be given to installing the equipment in an environment compatible with the manufacturer's maximum rated ambient temperature (Tmra).  E35

**Caution**

Installation of the equipment in a rack should be such that the amount of air flow required for safe operation of the equipment is not compromised.  E36

**Warning**

Reliable earthing of rack-mounted equipment must be maintained. Particular attention must be given to supply connections other than direct connections to the branch circuits (e.g., use of power strips).  E37

**Warning**

To reduce the risk of electric shock, the PoE ports on this product must not connect to cabling that is routed outside the building where this device is located.  E40

**Warning**

This product may have multiple AC power cords installed. To de-energize this equipment, disconnect all power cords from the device.  E41

**Caution**

An Energy Hazard exists inside this equipment. Do not insert hands or tools into open chassis ports or plugs.  E44

**Warning**

This equipment must be installed in a Restricted Access location.  E45

**Caution**

The unit does not contain serviceable components. Please return damaged units for servicing.  E42

**Warning**

The temperature of an operational SFP or SFP+ transceiver may exceed 70° C (158° F). Exercise caution when removing or handling a transceiver with unprotected hands.  E43

Choosing a Site for the Switch

Observe these requirements when planning the installation of the switch.

- ❑ Before installing the switch in an equipment rack, check that the rack is safely secured so that it will not tip over. Devices in a rack should be installed starting at the bottom, with the heavier devices near the bottom of the rack.
- ❑ Before installing the switch on a table, check that the table is level and stable.
- ❑ The power outlets should be located near the switch and be easily accessible.
- ❑ The site should allow for easy access to the ports on the front of the switch, so that you can easily connect and disconnect cables, and view the port LEDs.
- ❑ The site should allow for adequate air flow around the unit and through the cooling vents on the front and rear panels. (The ventilation direction is from front to back.)
- ❑ The site must not expose the switch to moisture or water.
- ❑ The site must be a dust-free environment.
- ❑ The site must have dedicated power circuits or power conditioners to supply reliable electrical power to the network devices.
- ❑ Do not install the switch in a wiring or utility box because it might overheat and fail from inadequate air flow.



Warning

Switches should not be stacked on a table or desktop. They could present a physical safety hazard if you need to move or replace switches. *ES* E91

Unpacking the Switch

The main items provided in the shipping box for the switch are:

- ❑ AT-x530L-52GPX Switch
- ❑ Accessory kit (refer to Figure 9 on page 46)

Note

Retain the original packaging material in case you need to return the unit to Allied Telesis.

Figure 8 shows the items provided in the shipping box for the switch.

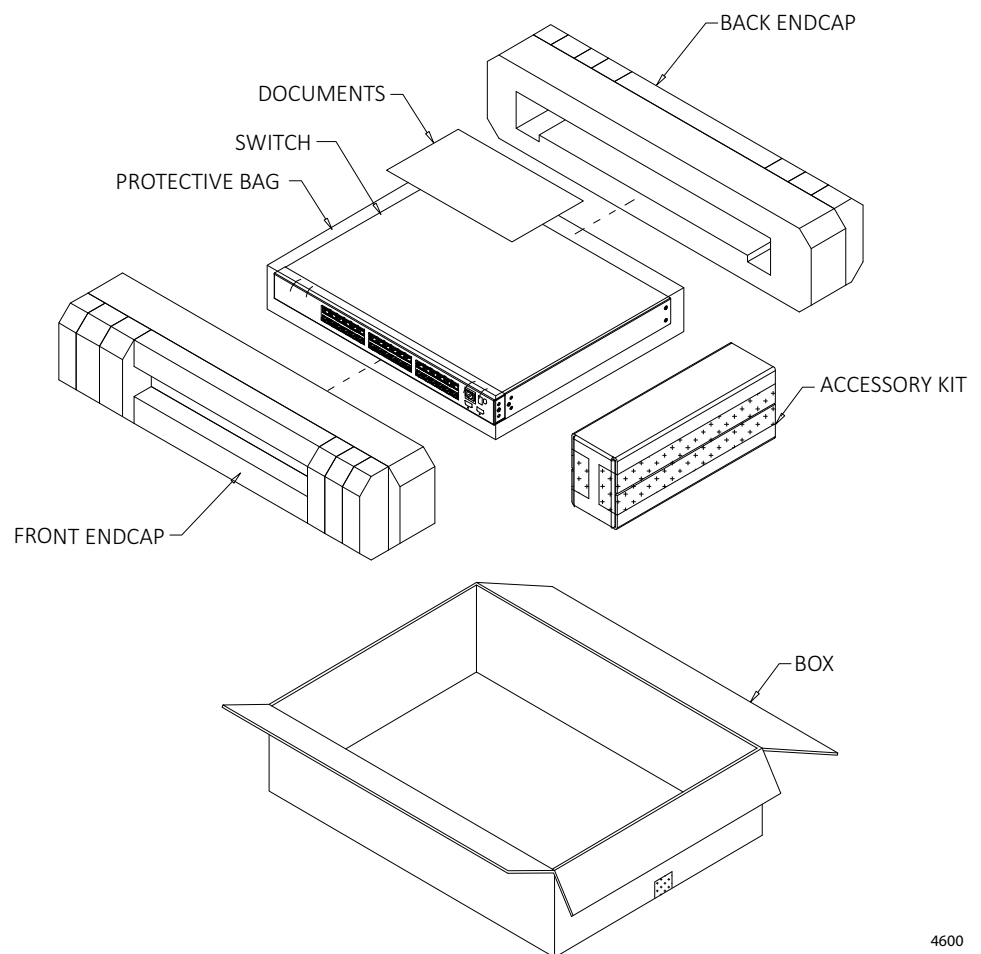

Figure 8. Switch Shipping Box

4600

Figure 9 lists the items that are included in the accessory kit. Contact your Allied Telesis sales representative for assistance if any item is missing or damaged.



One 2m (6.6 ft) local management cable with RJ-45 (8P8C) and DB-9 (D-sub 9-pin) connectors.

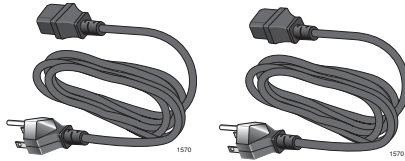

Two regional AC power cords.

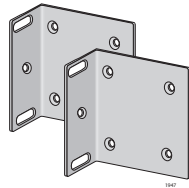

Wall/equipment rack brackets:
4 for AT-x530L-52GPX.

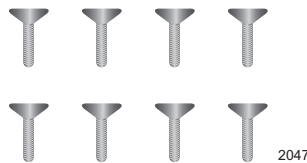

Screws to attach the wall/equipment rack brackets:
16 for AT-x530L-52GPX.
Length: 6.0mm (0.2 in.)
Diameter: 4.0mm (0.2 in.)

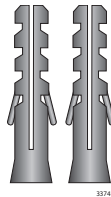

Anchors for concrete walls:
4 for AT-x530L-52GPX.
Length: 29.6mm (1.2 in.)
Diameter: 6.0mm (0.2 in.)

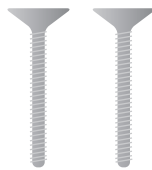

Screws for wood or concrete walls:
4 for AT-x530L-52GPX.
Length: 32mm (1.3 in.)
Diameter: 4mm (0.2 in.)

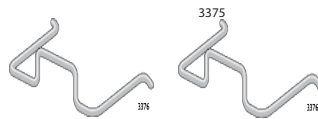

Two power cord retaining clips

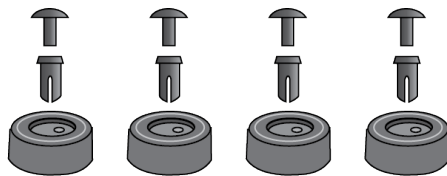

Four rubber bumper feet

Figure 9. Accessory Kit Items

Chapter 3

Installing the Switch on a Table

This chapter contains the instructions for installing the switch on a table or desktop.

**Warning**

Switches should not be stacked on a table or desktop. They could present a physical safety hazard if you need to move or replace switches.  E91

**Warning**

The switch is heavy. Always ask for assistance when moving or lifting the device so as to avoid injuring yourself or damaging the equipment.

Installing the Bumper Feet

The switch comes with four bumper feet in the accessory kit. The feet, which are reusable, are used when installing the switch on a table. If they are already assembled, disassemble them by removing the rivets and rivet housings from the bumper feet. Refer to Figure 10.

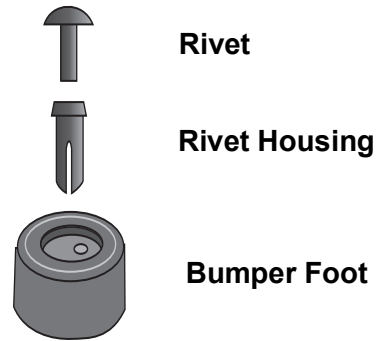

Figure 10. Parts of the Bumper Feet

The holes in the base of the switch for the bumper feet are shown in Figure 11 on page 48.

Note

Although you cannot stack the switches on top of each other, they can be placed next to each other.

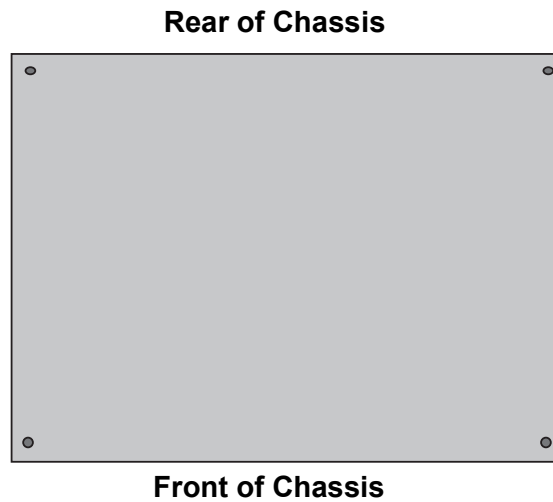

Figure 11. Holes for Bumper Feet

Note

The following procedure assumes that you have already reviewed the information and performed the procedures in Chapter 2, “Beginning the Installation” on page 39.

To install the switch on a table, perform the following procedure:

1. Place the switch upside down on a table.
2. Inset a rivet housing into a bumper foot. Refer to Figure 12.

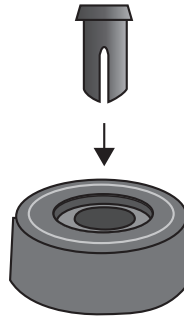

Figure 12. Inserting the Rivet Housing into the Bumper Foot

3. Place the bumper foot with rivet housing onto one of the holes in the base of the switch. Refer to Figure 13.

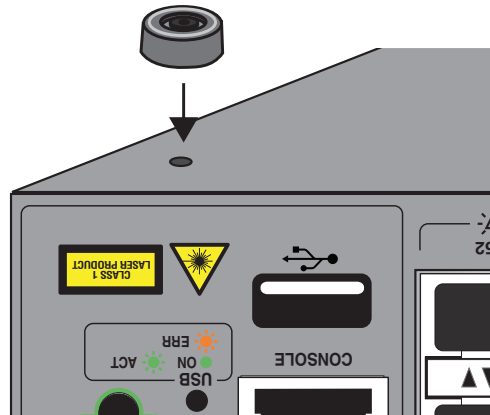

Figure 13. Placing the Bumper Foot on a Base Corner Hole

4. Insert the rivet to secure the bumper foot to the base. Refer to Figure 14.

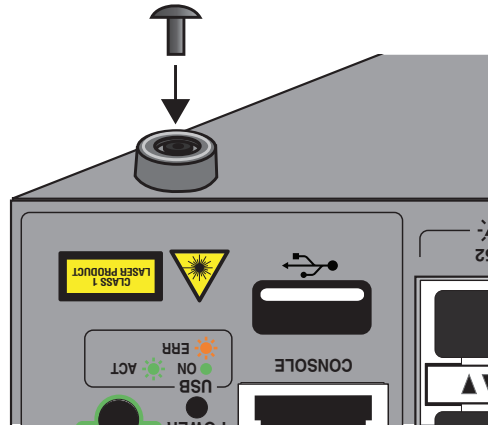

Figure 14. Inserting the Rivet into the Bumper Foot

5. Repeat steps 2 to 4 to install the remaining bumper feet.
6. Turn the switch over and place it on a flat, secure desk or table, leaving ample space around it for ventilation.
7. After placing the switch on the table or desktop, go to Chapter 6, "Powering On the Switch" on page 71.

Chapter 4

Installing the Switch in an Equipment Rack

This chapter provides instructions for installing the switch in an equipment rack. This chapter contains the following section:

- “Installing the Switch in an Equipment Rack” on page 52

Installing the Switch in an Equipment Rack

This section contains the procedure for installing a switch in a standard 19-inch equipment rack using the brackets supplied with the unit.

Required Items

The following items are required to install the switch in an equipment rack:

- Two equipment rack brackets (included with the switch)
- Eight M4x6mm bracket screws (included with the switch)
- Cross-head screwdriver (not provided)
- Four standard equipment rack screws (not provided)

Switch Orientations in the Equipment Rack

The switch has two sets of four screw holes on the left and right sides, for attaching the brackets. Refer to Figure 15.

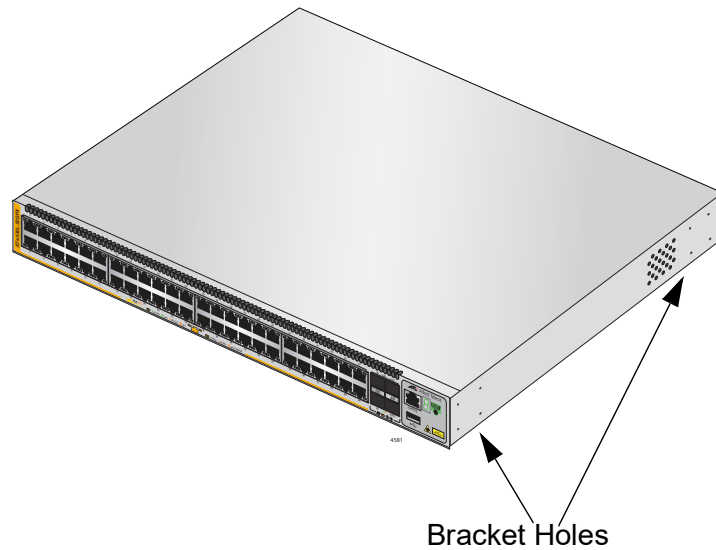

Figure 15. Bracket Holes on the Switch

You can use the different sets of holes on the switch to install the switch in the equipment rack in a variety of orientations. You can install it with the front panel flush with, extending in front of, or recessed behind the front of the equipment rack. The illustrations in Figure 16 show the switch orientation with the front panel even with the front of the equipment rack.

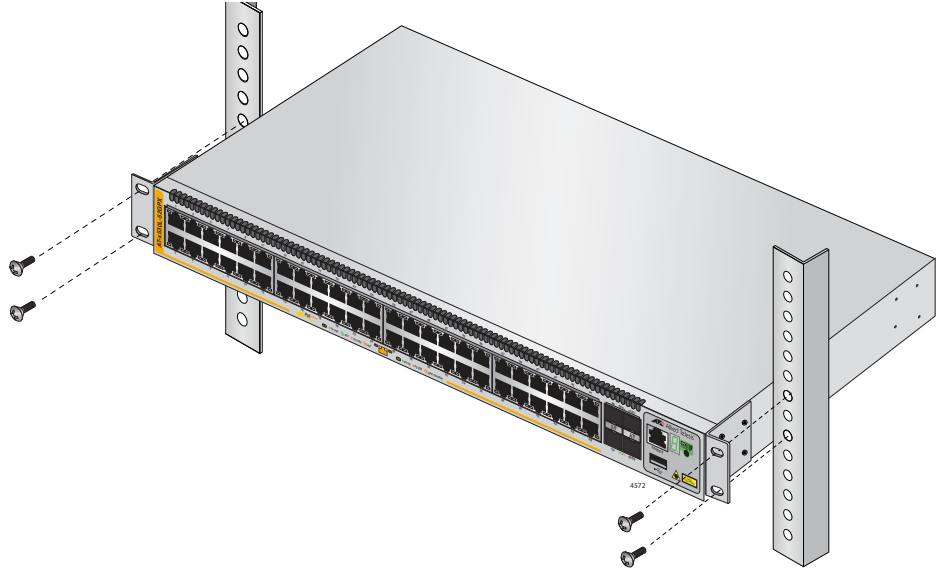

Figure 16. Switch Orientations in an Equipment Rack

Installing the Switch

If you have not chosen an orientation for the switch in the equipment rack, review “Switch Orientations in the Equipment Rack” on page 52.

Please review the installation guidelines in “Choosing a Site for the Switch” on page 44 before installing the switch in an equipment rack.



Caution

The chassis can be heavy and awkward to lift. Allied Telesis recommends that you get assistance when mounting the chassis in an equipment rack. *GE* E28

To install the switch in a 19-inch equipment rack, perform the following procedure:

1. Place the switch on a level, secure surface.
2. Attach the two brackets to the sides of the switch in the selected position, using the eight M4x6mm screws supplied with the unit. The illustration in Figure 17 shows the installation of the brackets such that the front panel of the switch is even with the front of the equipment rack.

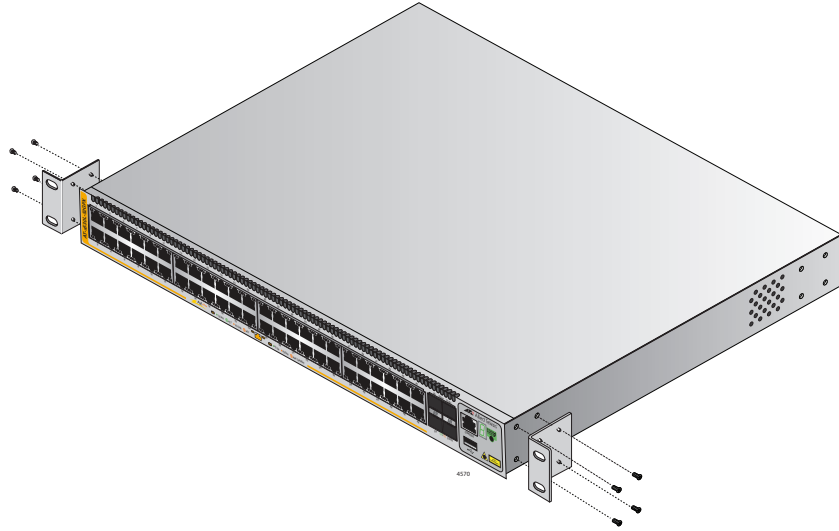

Figure 17. Example of Attaching the Brackets to the Switch

3. Have another person hold the switch at the desired location in the equipment rack while you secure it using four standard equipment rack screws (not provided). Refer to Figure 18.

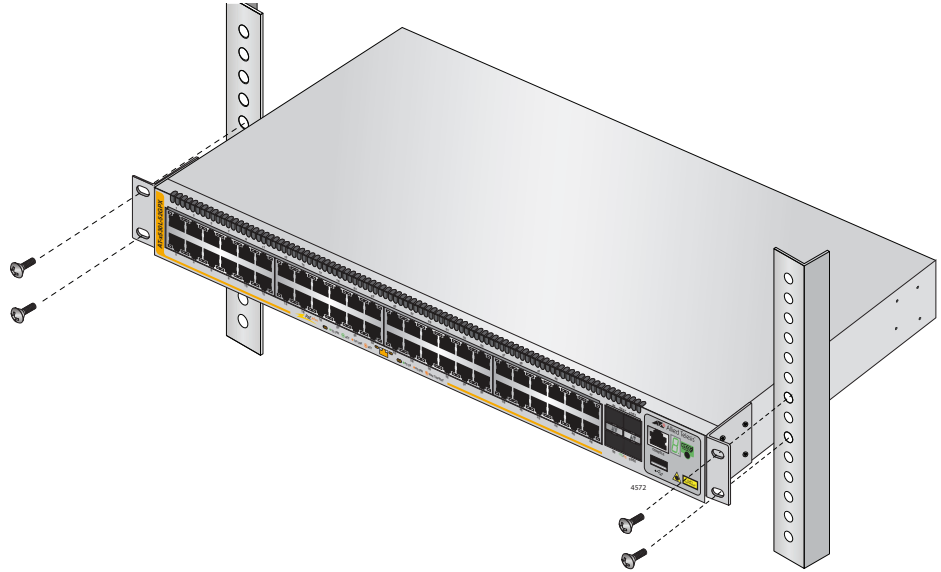

Figure 18. Installing the Switch in an Equipment Rack

4. Go to Chapter 6, “Powering On the Switch” on page 71.

Chapter 5

Installing the Switch on a Wall

The procedures in this chapter are listed here:

- “Switch Orientations on a Wall” on page 58
- “Installation Guidelines” on page 59
- “Plywood Base for a Wall with Wooden Studs” on page 61
- “Installing a Plywood Base” on page 64
- “Installing the Switch on a Plywood Base” on page 65
- “Installing the Switch on a Concrete Wall” on page 67

Switch Orientations on a Wall

Install the switch on a wall with the front panel on the up, left or right as shown in Figure 19. Do not install the switch with the front panel facing down.

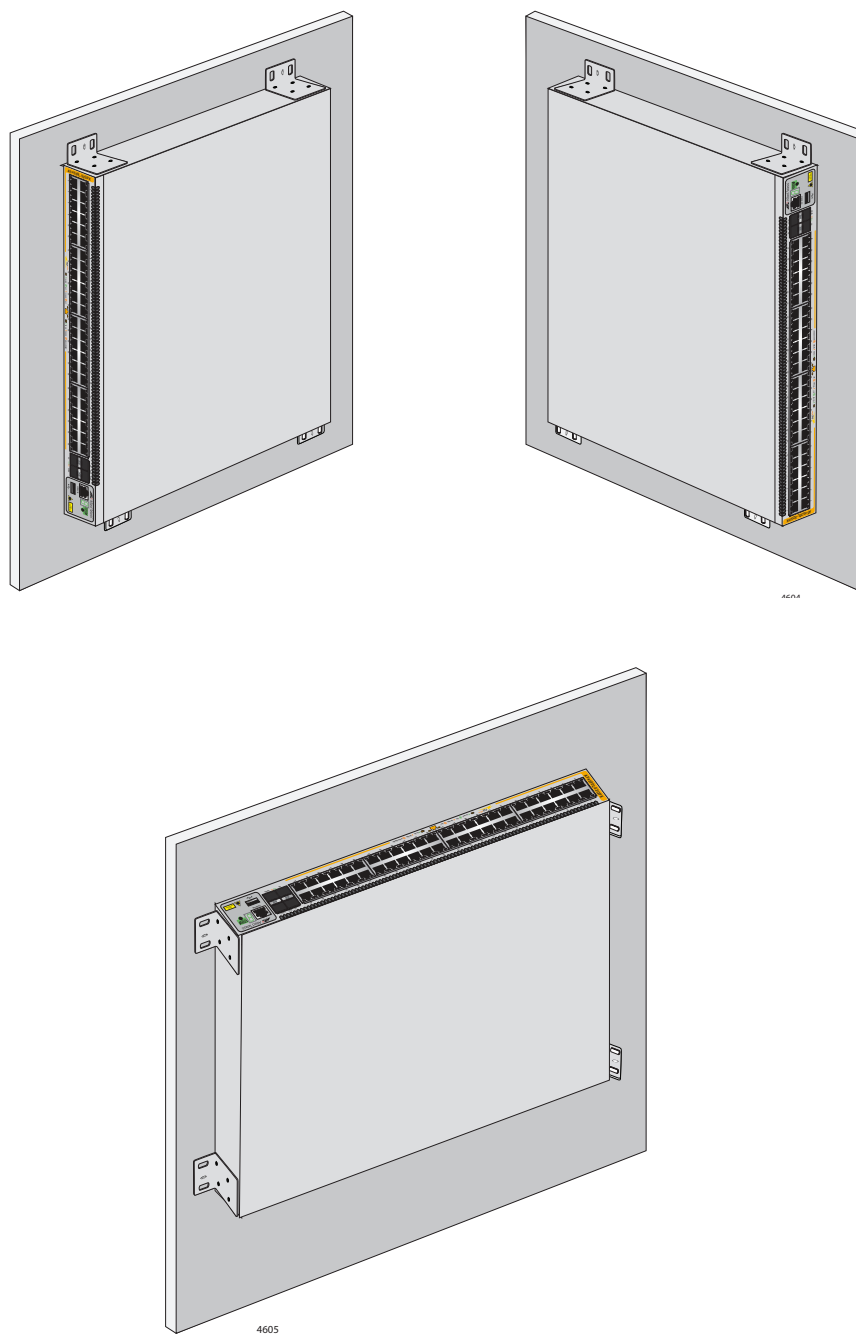

Figure 19. Positioning the AT-x530L-52GPX Switch on the Wall

Installation Guidelines

Here are the guidelines for installing the switch on a wall:

- ❑ Install the switch on a wall that has wooden studs or on a concrete wall.
- ❑ If you are installing the switch on a wall with wooden studs, use a plywood base to support the switch. For more information, refer to “Plywood Base for a Wall with Wooden Studs” on page 61. A plywood base is not required for a concrete wall.
- ❑ Do not install the switch on a wall that has metal studs. Metal studs may not be strong enough to safely support the device.
- ❑ Do not install the switch on sheetrock or similar material. Sheetrock is not strong enough to safely support the device.



Warning

The device is heavy. Always ask for assistance before moving or lifting it to avoid injuring yourself or damaging the equipment.



Warning

The device should be installed on a wall by a qualified building contractor. Serious injury to yourself or others or damage to the equipment can result if it is not properly fastened to the wall. *GS*
E105

Tools and Material

The following tools and material are required for installing the switch on a wall.

Included with the switch:

- Four wall/equipment rack brackets:
- Sixteen screws for attaching wall/equipment rack brackets:
Length: 6.0mm (0.2 in.) Diameter: 4.0mm (0.2 in.)
- Four anchors for concrete walls:
Length: 29.6mm (1.2 in.) Diameter: 6.0mm (0.2 in.)
- Four screws for wood or concrete walls
Length: 32mm (1.3 in.) Diameter: 4mm (0.2 in.)
- Two power cord retaining clips
- Four rubber bumper feet

Not included with the switch:

- Cross-head screwdriver.
- Stud finder for a wooden wall, capable of identifying the middle of wall studs and hot electrical wiring.
- Drill and 1/4-inch carbide drill bit (for a concrete wall).
Refer to “Installing the Switch on a Concrete Wall” on page 67.
- Plywood base (if you are installing the switch on a wall with wooden studs). Refer to “Plywood Base for a Wall with Wooden Studs” on page 61 for illustrations.
- Four screws for attaching the plywood base to the wall.



Caution

The supplied screws and anchors might not be appropriate for all walls. A qualified building contractor can determine the hardware requirements for your wall prior to installing the switch.  E88

Plywood Base for a Wall with Wooden Studs

If you are installing the switch on a wall that has wooden studs, use plywood base for the device. (A plywood base is not required for a concrete wall.) Refer to Figure 20.

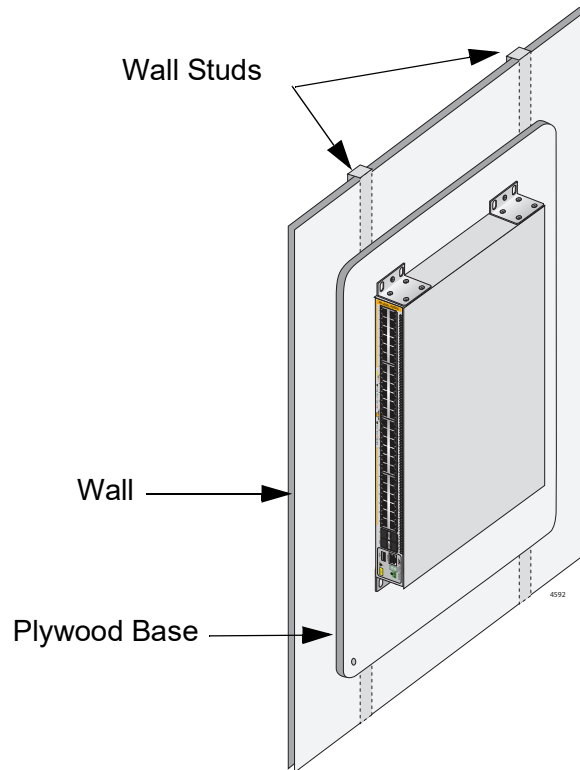

Figure 20. Switch on the Wall with a Plywood Base

Mount the plywood base to two studs in the wall. The recommended minimum dimensions of the plywood base for the switch are:

- ❑ Width: 55.9 centimeters (22 inches)
- ❑ Height: 61.0 centimeters (24 inches)
- ❑ Thickness: 2.5 centimeters (1 inch)

The dimensions assume the wall studs are 41 centimeters (16 inches) apart. You might need to adjust the width of the base if the distance between the studs in your wall is different than the industry standard.

To install the switch on the wall:

1. Install the plywood base on the wall and then install the switch on the base. Refer to Figure 21.

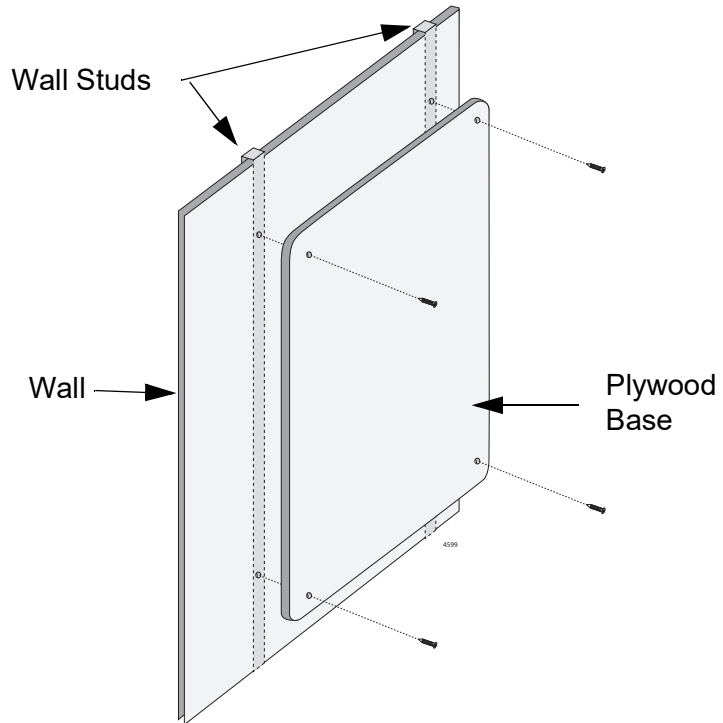

Figure 21. Installing the Plywood Base to the Wall

2. Install the switch on the plywood base. Refer to Figure 22.

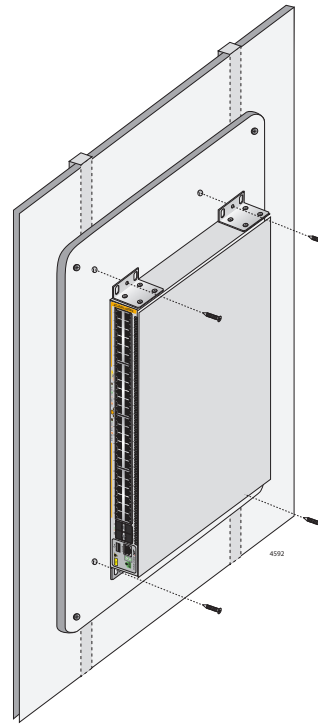

Figure 22. Installing the Switch on the Plywood Base

Installing a Plywood Base

A plywood base is recommended when installing the switch on a wall that has wooden studs. Refer to “Plywood Base for a Wall with Wooden Studs” on page 61. Consult a qualified building contractor for installation instructions for the plywood base. The installation guidelines are listed here:

- ❑ Use a stud finder to identify the middle of studs and hot electrical wiring in the wall.
- ❑ Attach the base to two wall studs with a minimum of four screws.
- ❑ The selected wall location for the base must provide sufficient space from other devices or walls so that you can access the front and back panels, and for adequate air flow for ventilation.

Installing the Switch on a Plywood Base

After the plywood base for the switch has been installed on the wall, install the switch. See “Reviewing Safety Precautions” on page 40 and “Choosing a Site for the Switch” on page 44 before performing this procedure. Allied Telesis recommends a minimum of two people for this procedure.



Warning

The device is heavy. Always ask for assistance before moving or lifting it to avoid injuring yourself or damaging the equipment.



Warning

The device should be installed on the wall by a qualified building contractor. Serious injury to yourself or others or damage to the equipment can result if it is not properly fastened to the wall. *ES*
E105

To install the switch on the plywood base, perform the following procedure:

1. Place the switch on a table.
2. For the AT-x530L-52GPX switches, install 4 wall/equipment rack brackets to the sides of the unit with the 16 M4x6mm screws included with the switch. Refer to Figure 23.

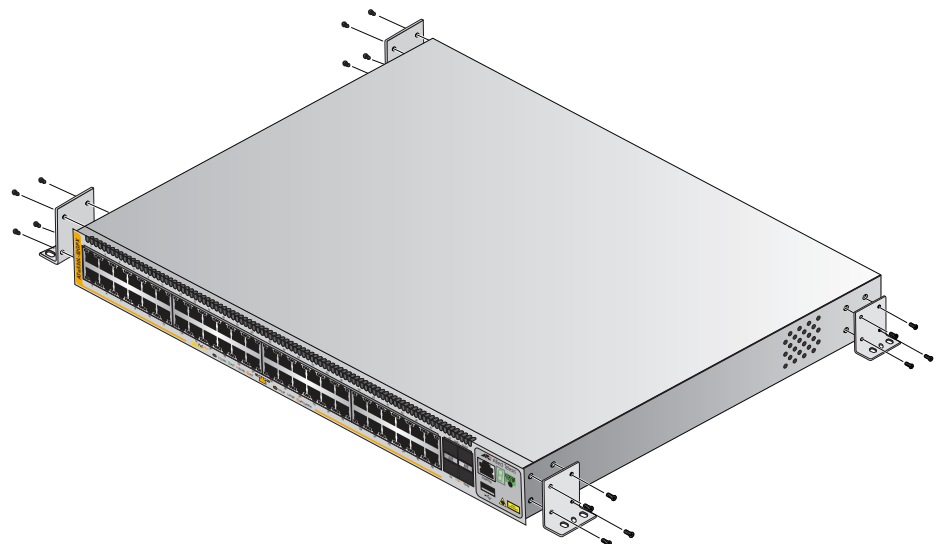

Figure 23. Installing Four Brackets on the AT-x530L-52GPX Switches

3. After attaching the brackets, have another person hold the switch on the plywood base on the wall while you secure it with the M4x32.3mm screws included with the switch. Refer to Figure 24 for the AT-x530L-52GPX switches.

Follow these guidelines as you position the switch on the wall:

- ❑ Position it so that the front panel is facing up, left or right. Refer to Figure 24. Do not install it with the front panel facing down.
- ❑ Provide sufficient space from other devices or walls so that you can access the front and back panels, and for adequate air flow for ventilation.

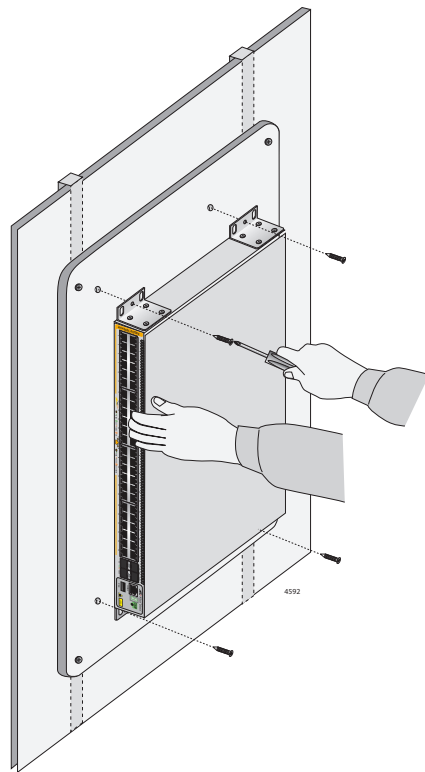

Figure 24. Securing the AT-x530L-52GPX Switches to the Plywood Base

4. Go to Chapter 6, “Powering On the Switch” on page 71.

Installing the Switch on a Concrete Wall

This section contains the instructions for installing the switch on a concrete wall. Please review the information in the following sections before performing the procedure:

- “Switch Orientations on a Wall” on page 58
- “Installation Guidelines” on page 59



Warning

The device is heavy. Always ask for assistance before moving or lifting it to avoid injuring yourself or damaging the equipment.



Warning

The device should be installed on the wall by a qualified building contractor. Serious injury to yourself or others or damage to the equipment can result if it is not properly fastened to the wall. *GR*
E105

To install the switch on a concrete wall, perform the following procedure:

1. Place the switch on a table.
2. For the AT-x530L-52GPX switches, install 4 wall/equipment rack brackets to the sides of the unit with the 16 M4x6mm screws included with the switch. Refer to Figure 23 on page 65.
3. After attaching the brackets, have another person hold the switch on the concrete wall at the selected location for the device while you use a pencil or pen to mark the wall with the locations of the four screw holes in the four brackets (one screw per bracket). Refer to Figure 25 on page 68.

Please follow these guidelines as you position the switch on the wall:

- Position it so that the front panel is facing up, left or right. Refer to Figure 24 on page 66. Do not install the switch with the front panel facing down.
- Provide sufficient space from other devices or walls so that you can access the front and back panels, and for adequate air flow and ventilation.

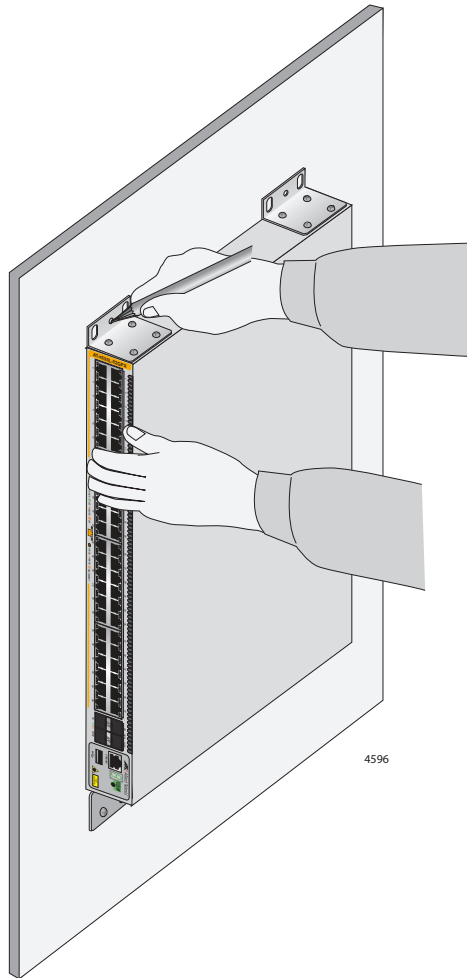

Figure 25. Marking the Locations of the Bracket Holes on a Concrete Wall

4. Place the switch on a table.
5. Use a drill and a 1/4-inch carbide drill bit to pre-drill the holes you marked in step 3. Please review the following guidelines:
 - Prior to drilling, set the drill to hammer and rotation mode. The modes break up the concrete and clean out the hole.
 - Clean out the holes with a brush or compressed air.
6. Insert the anchors into the holes.

7. Have another person hold the switch at the selected wall location while you secure it to the wall with the M4x32mm screws provided. Refer to Figure 26.

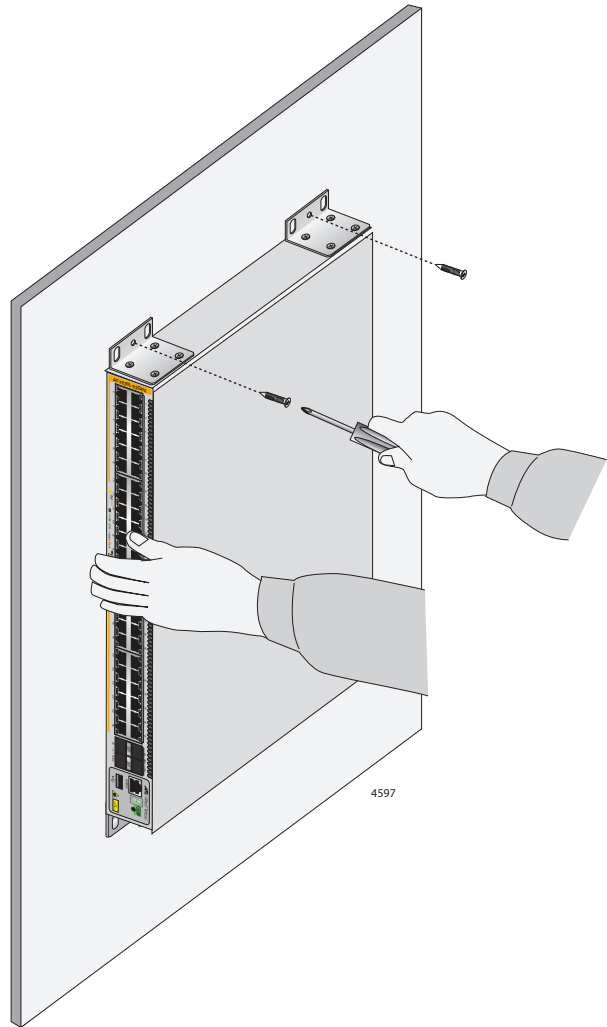

Figure 26. Installing the Switch on a Concrete Wall

8. Go to Chapter 6, “Powering On the Switch” on page 71.

Chapter 6

Powering On the Switch

This chapter contains the following procedures:

- “Powering On the Switch” on page 72
- “Monitoring the Initialization Processes” on page 75

Powering On the Switch

Before powering on the switch, review the information in “Power Specifications” on page 102 for the power specifications.



Warning

The power cord is used as a disconnection device. To de-energize equipment, disconnect the power cord. ⚡ E3

Note

Pluggable Equipment. The socket outlet shall be installed near the equipment and shall be easily accessible. ⚡ E5

To power on the switch, perform the following procedure:

1. Install the power cord retaining clip on the AC power connector on the rear panel of the switch. Refer to Figure 27.

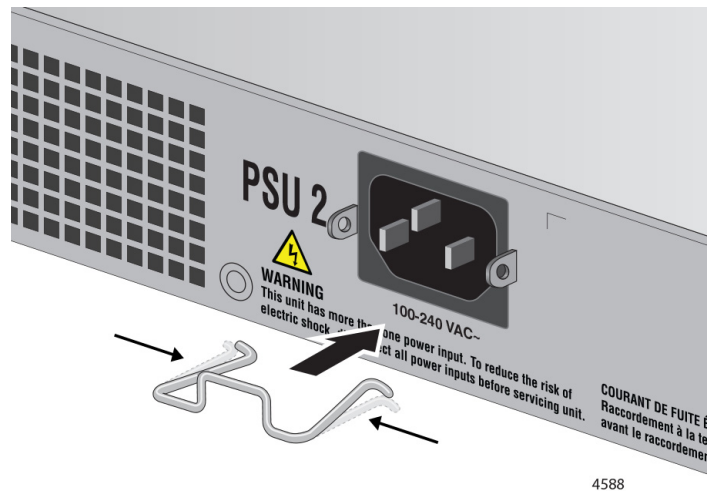

Figure 27. Installing the Power Cord Retaining Clip

2. Connect the AC power cord to the AC power connector on the rear panel. Refer to Figure 28 on page 73.

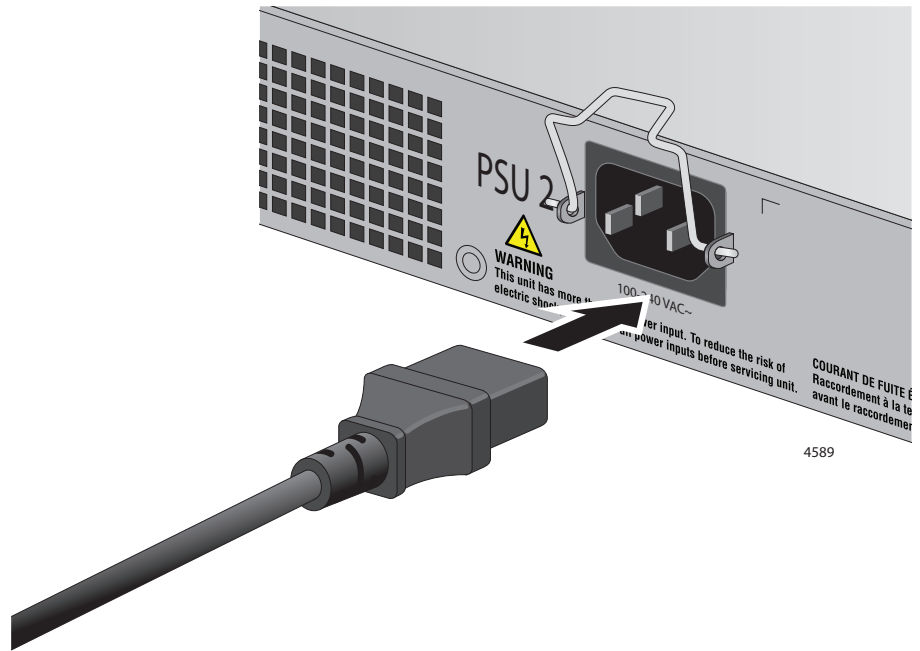

Figure 28. Connecting the AC Power Cords

3. Lower the power cord retaining clips to secure the cords to the switch. Refer to Figure 29.

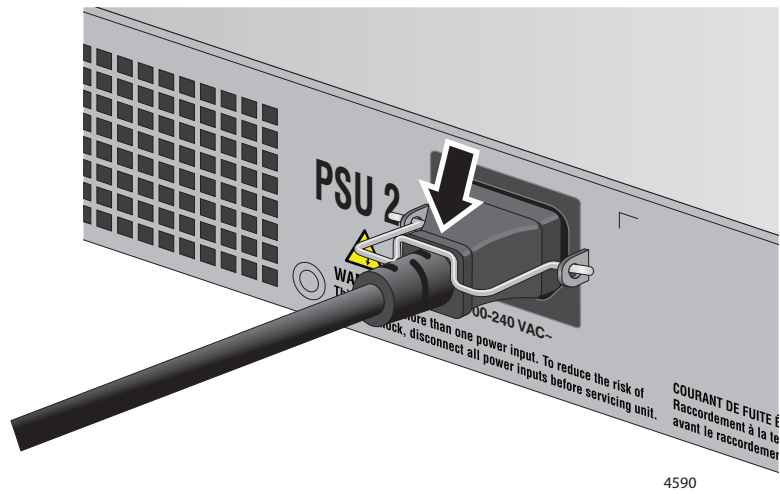

Figure 29. Lowering the Power Cord Retaining Clips

4. Connect the power cords to an appropriate AC power source. Refer to Figure 30 on page 74.

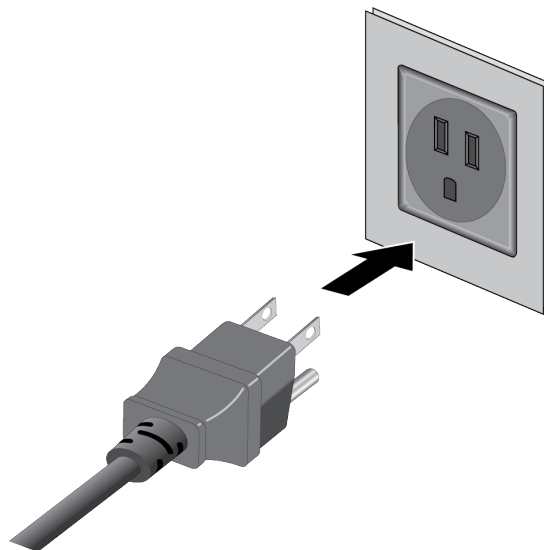

Figure 30. Connecting the Power Cords to an AC Power Source

Note

The illustration shows a North American power cord. Your power cords may be different.

5. Do one of the following:
 - To monitor the switch as it initializes the management software, go to “Monitoring the Initialization Processes” on page 75.
 - Wait two minutes for the switch to initialize its management software and then go to Chapter 7, “Configuring the Switch for Stand-alone Operations” on page 79.

Monitoring the Initialization Processes

It takes about two minutes for the switch to initialize its management software programs and features, and load the default configuration. You can monitor the bootup sequence by connecting a terminal or computer with a terminal emulator program to the Console port. (The Console port settings are provided in “Starting a Local Management Session” on page 81.) The switch displays the messages in Figure 31 through Figure 33 on the Console port as it initializes the management software.

```

Bootloader 6.2.12 loaded
Press <Ctrl+B> for the Boot Menu
Reading flash:x530L-5.4.9-rc1.rel...
Verifying release... OK
Booting...
Starting base/first...           [ OK ]
Mounting virtual filesystems...  [ OK ]

      _____
     / \      / / \_____ \
    / \ \    / / | _____ |
   / \ \ |  / / | | _____ |
  / \ \ \  / / | | \ _____ /
 / \ \ \ \ / / | | \ _____ /
/ \ \ \ \ / / | | \ _____ /

Allied Telesis Inc.
AlliedWare Plus (TM) v5.4.9
Current release filename: x530L-5.4.9-rc1.rel...
Built: Mon Nov 26 01:57:50 UTC 2018
Mounting static filesystems...   [ OK ]
Attaching to /dev/mtd0...       [ OK ]
Mounting file system...         [ OK ]
Checking for last gasp debug output... [ OK ]
Checking NVS filesystem...      [ OK ]
Mounting NVS filesystem...      [ OK ]
Initializing random number generator... [ OK ]
Starting base/hwrandom...       [ OK ]
Starting base/jitterentropy-rngd... [ OK ]
Starting base/dbus...           [ OK ]
Starting base/linux...          [ OK ]
Starting base/syslog...         [ OK ]

```

Figure 31. Switch Initialization Messages

```

Starting base/loopback... [ OK ]
Starting base/poe_done... [ OK ]
Starting base/portmapper... [ OK ]
Received event syslog.done
Starting base/modules... [ OK ]
Received event modules.done
Starting base/reboot-stability... [ OK ]
Checking system reboot stability... [ OK ]
Starting base/apteryx... [ OK ]
Starting base/crond... [ OK ]
Starting base/appmond... [ OK ]
Starting base/clockcheck... [ OK ]
Starting network/execd... [ OK ]
Starting base/inet... [ OK ]
Received event apteryx.done
Starting hardware/early_host_info... [ OK ]
Starting base/alfred... [ OK ]
Starting base/kernond... [ OK ]
Starting base/apteryx-sync... [ OK ]
Starting base/logconf... [ OK ]
Received event apteryx-sync.done
Starting hardware/platformd... [ OK ]
Starting hardware/plugman... [ OK ]
Starting hardware/timeout... [ OK ]
Starting hardware/hardware-done... [ OK ]
Received event board.inserted
Received event hardware.done
Starting base/external-media... [ OK ]
Starting network/startup... [ OK ]
Starting network/hostcfg... [ OK ]
Received event hostcfg.done
Starting network/cmplplatformd... [ OK ]
Starting base/eventwatch... [ OK ]
Starting network/startup... [ OK ]
Starting hardware platform_eventd... [ OK ]
Starting network/licd... [ OK ]
Starting network/stackd... [ OK ]
Starting network/election.timeout... [ OK ]
Starting network/corosync... [ OK ]
Received event network.enabled

```

Figure 32. Switch Initialization Messages (Continued)

```
Initializing HA processes:  
atmf_agentd, execd, exfx, hostd, atmfd, auth, epsr  
hsl, imi, imiproxyd, lldpd, loopprot, mstp, nsm  
pim6d, ripngd, rmon, sflowd, vrrpd, bgpd, irdpd  
lacp, ospf6d, ospfd, pdmd, pimd, ripd, udldd
```

```
Received event network.initialized
```

```
Assigning Active workload to HA processes:  
hsl, irdpd, lacpd, loopprot, mstpd, nsm, ospfd  
ripd, rmond, sflowd, vrrpd, authd, epsrd, imi  
imiproxyd, lldpd
```

```
Received event network.activated
```

```
Loading default configuration
```

```
..
```

```
done!
```

```
Received event network.configured
```

Figure 33. Switch Initialization Messages (Continued)

After the switch has initialized its management software, go to Chapter 7, “Configuring the Switch for Stand-alone Operations” on page 79.

Chapter 7

Configuring the Switch for Stand-alone Operations

This chapter contains the following procedures:

- ❑ “Determining the Stand-alone or Stacking Status of the Switch” on page 80
- ❑ “Starting a Local Management Session” on page 81
- ❑ “Disabling the VCStack Feature” on page 83
- ❑ “Saving Your Changes and Rebooting the Switch” on page 85
- ❑ “Specifying Ports in the Command Line Interface for Stand-alone Switches” on page 86

Determining the Stand-alone or Stacking Status of the Switch

After powering on the switch and waiting two minutes for it to initialize the management software, examine the switch ID LED on the front panel. If the LED is displaying the number “1” or higher, the VCStack feature is enabled on the unit. You need to disable it to use the switch in stand-alone mode. For instructions, start with “Starting a Local Management Session” on page 81. The VCStack feature is enabled by default.

If the LED is displaying “0”, the VCStack feature is already disabled and the switch is operating as a stand-alone unit. Go to Chapter 8, “Cabling the Networking Ports” on page 87.



Caution

You must reset the switch to disable the VCStack feature. Some network traffic can be lost if the device is already connected to a live network.  E89

Note

The initial management session of the switch must be from the Console port.

Starting a Local Management Session

This procedure requires a VT100 terminal or a VT100 terminal emulator program and the management cable that comes with the switch. To start a local management session on the switch, perform the following procedure:

1. Connect the RJ-45 connector of the management cable to the console port on the front panel of the switch, as shown in Figure 34.

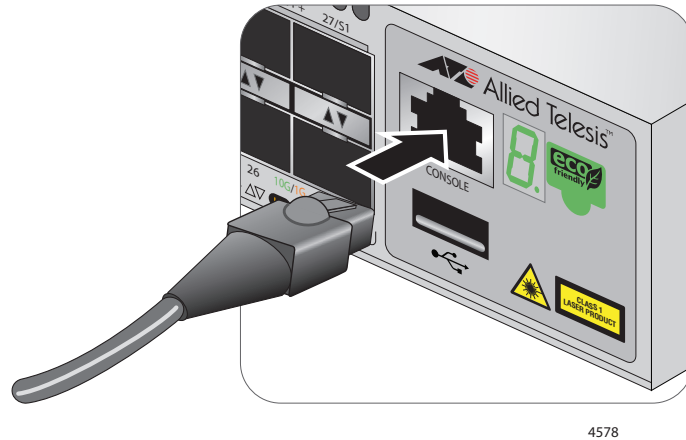

Figure 34. Connecting the Management Cable to the Console Port

2. Connect the other end of the cable to an RS-232 port on a terminal or computer with a terminal emulator program.
3. Configure the terminal or terminal emulator program as follows:
 - Default baud rate: 9,600 bps (range is 9,600 to 115,200 bps)
 - Data bits: 8
 - Parity: None
 - Stop bits: 1
 - Flow control: None

Note

The port settings are for a DEC VT100 or ANSI terminal, or an equivalent terminal emulator program.

4. Press Enter.

You are prompted for a user name and password.

5. When prompted, type a user name and password to log on the switch. If this is the initial management session, enter “manager” as the user name and “friend” as the password. The user name and password are case sensitive.

The local management session starts when the User Exec mode prompts.

```
awp1us>
```

Note

The User Exec mode is the first level in the command mode interface. For complete information on the modes and commands, refer to the *Software Reference for x530L Series Switches, AlliedWare Plus Operating System* at www.alliedtelesis.com.

6. If you need to disable the VCStack feature, perform the procedure in “Disabling the VCStack Feature” on page 83.

Disabling the VCStack Feature

The following procedures explain how to disable the VCStack feature to use the switch as a stand-alone unit.



Caution

Disabling the VCStack feature requires resetting the switch. Some network traffic can be lost if the switch is connected to a live network. *E89*

To disable the VCStack feature, perform the following procedure:

1. Start a local management session on the switch. For instructions, refer to “Starting a Local Management Session” on page 81.
2. To display the status of the VCStack feature on the switch, at the User Exec mode prompt, type the command SHOW STACK.

```
awplus> show stack
Virtual Chassis Stacking summary information
ID      Pending ID  MAC address      Priority  Status  Role
1       -            eccd:6dd1:64a2  128     Ready   Active Master
Operational Status      Standalone Unit
Stack MAC address       eccd:6dd1:64a2
awplus>
```

Figure 35. SHOW STACK Command

3. If the Operational Status of the switch is “Stacking Hardware Disabled,” the VCStack feature is already disabled on the unit. If this is the case, go to Chapter 8, “Cabling the Networking Ports” on page 87.

However, if the Operational Status is “Standalone Unit” as shown in Figure 35, the VCStack feature is active on the unit. (The “Standalone Unit” status means the switch is functioning as a stack of one switch.) You must disable the feature to use the switch as a stand-alone unit. Continue with the next step.

4. To move to the Global Configuration mode, type the commands ENABLE and CONFIGURE TERMINAL.

```
awplus> enable
awplus# configure terminal
Enter configuration commands, one per line. End with CNTL/Z
awplus(config)#
```

Figure 36. Moving to the Global Configuration Mode

5. To disable the VCStack feature, type the command NO STACK <id> ENABLE in the following format:

```
no stack <id> enable
```

The *id* parameter is the ID number of the switch, displayed on the ID LED. Replace the *id* parameter with the number on the ID LED. For example, if the ID number of the switch is 1, the default value, enter the command as follows:

```
awplus(config)# no stack 1 enable
```

```
Warning; This will disable the stacking hardware on member-1.
Are you sure you want to continue? (y/n):
```

6. To disable VCStack on the switch type Y, or type N to cancel the procedure.

```
awplus(config)#18:04:12 awplus vcs[2119]: Deactivating
Stacking Ports on stack member 1.
```

Figure 37. Disabling VCStack

7. Press the Enter key to re-display the Global Configuration mode prompt.
8. Go to “Saving Your Changes and Rebooting the Switch” on page 85.

Saving Your Changes and Rebooting the Switch

After disabling the VCStack feature, save your configuration changes and reboot the switch. Changes to the status of the VCStack feature do not take affect until after you reboot the unit.

To save your configuration changes and reboot the switch, perform the following procedure:

1. To return to the Privileged Exec mode, from the Global Configuration mode, type the command EXIT.

```
awplus(config)# exit
awplus#
```

Figure 38. Returning to the Privileged Exec Mode

2. To save your change in the configuration file, type the command WRITE.

```
awplus# write
Building configuration ...
[OK]
awplus#
```

Figure 39. Saving the Changes with the WRITE Command

If this is the initial management session, the switch automatically creates the Default.cfg configuration file and stores the change in the file.

3. To reboot the switch, type the command REBOOT.
4. To confirm, type “Y” for yes.
5. Wait two minutes for the switch to initialize the management software and then examine the Switch ID LED again. The switch is ready for normal network operation as a stand-alone unit if its ID number is “0.” If the number is not “0,” repeat the procedures in this chapter, being sure to save your configuration changes with the WRITE command.
6. Go to Chapter 8, “Cabling the Networking Ports” on page 87.

Specifying Ports in the Command Line Interface for Stand-alone Switches

The individual ports on the switches are specified in the command line interface with the PORT parameter. The format of the parameter is shown in Figure 40.

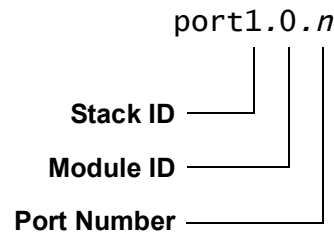

Figure 40. PORT Parameter in the Command Line Interface

The three parts of the PORT parameter are described in Table 6.

Table 6. PORT Parameter Format

Number	Description
Stack ID	Designates the switch's ID number. The correct value is "1" for a stand-alone switch. Do not enter 0, the value displayed on the Switch ID LED.
Module ID	Designates the module number of a port. The x530L Series switches do not have modules, Consequently, this value is always 0 (zero).
Port Number	Designates a port number.

The following is an example of the PORT parameter on a stand-alone switch. It uses the INTERFACE command to enter the Port Interface mode for ports 15 and 17:

```
awplus> enable
awplus# configure terminal
awplus(config)# interface port1.0.15,port1.0.17
```

For instructions on the command line interface and the PORT parameter, refer to the *Software Reference for x530L Series Switches, AlliedWare Plus Operating System*.

Chapter 8

Cabling the Networking Ports

This chapter contains the following procedures:

- ❑ “Cabling Twisted Pair Ports” on page 88
- ❑ “Guidelines to Handling SFP and SFP+ Transceivers” on page 89
- ❑ “Installing SFP or SFP+ Transceivers in the Switches” on page 90
- ❑ “Installing AT-SP10TW Direct Connect Twinax Cables in the Switches” on page 93

Cabling Twisted Pair Ports

Here are the guidelines to cabling the twisted pair ports on the switches:

- ❑ The category of twisted pair cable requirements are as follows:
 - 10 or 100 Mbps ports: Standard TIA/EIA 568-B-compliant Category 3 unshielded cabling
 - 1 Gbps ports: Standard TIA/EIA 568-A-compliant Category 5 or TIA/EIA 568-B-compliant Enhanced Category 5 (Cat 5e) unshielded cabling
- ❑ PoE is enabled by default on the AT-x530L-52GPX switch ports.
- ❑ The connectors on the cables must fit snugly into the ports, and the tabs must lock the connectors into place.
- ❑ The default speed setting for the ports is Auto-Negotiation. This setting is appropriate for ports connected to network devices that also support Auto-Negotiation.
- ❑ The ports must be set to the default setting of Auto-Negotiation to operate at 1000 Mbps.
- ❑ The twisted pair ports can operate in either half- or full-duplex mode when operating at 10 Mbps or 100 Mbps. However, if any of the twisted pair ports operate at 1 Gbps or higher, then the duplex mode is always full-duplex.
- ❑ Do not attach cables to ports of static or Link Aggregation Control Protocol (LACP) port trunks until after you configure the trunks on the switch. Otherwise, the ports will form network loops that can adversely affect network performance.

Guidelines to Handling SFP and SFP+ Transceivers

Review the following guidelines before installing SFP or SFP+ transceivers in the switches:

- ❑ The transceivers are hot-swappable. You can install them while the switch is powered on.
- ❑ For a list of supported transceivers, refer to the product data sheet on the Allied Telesis web site.
- ❑ The operational specifications and fiber optic cable requirements of the transceivers are provided in the documents included with the devices.
- ❑ Install a transceiver before connecting the fiber optic cable.
- ❑ Fiber optic transceivers are dust sensitive. Always keep the plug in the optical bores when a fiber optic cable is not installed, or when you store the transceiver. When you do remove the plug, keep it for future use.
- ❑ Unnecessary removal and insertion of a transceiver can lead to premature failure.



Caution

Transceivers can be damaged by static electricity. Be sure to observe all standard electrostatic discharge (ESD) precautions, such as wearing an antistatic wrist strap, to avoid damaging the devices. ⚡ E92

Installing SFP or SFP+ Transceivers in the Switches

This section contains installation instructions for SFP or SFP+ transceivers in ports 49 to 52 in the AT-x530L-52GPX switches.

The following illustrations show a transceiver with a duplex LC connector. The connectors on your transceivers may be different.

To install transceivers, perform the following procedure:

1. Select a port for the transceiver.
2. If the port has a dust cover, remove it. Refer to Figure 41.

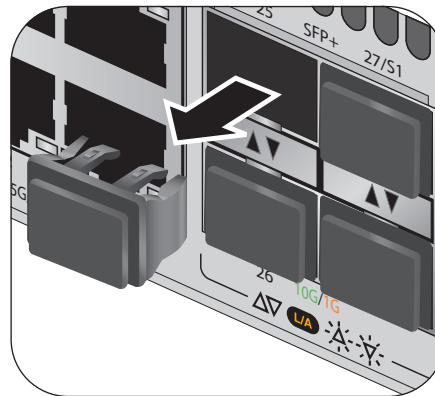

4573

Figure 41. Removing the Dust Plug from an SFP Port

3. Remove the transceiver from its shipping container and store the packaging material in a safe location.

4. If you are installing the transceiver in a top port, position the transceiver with the Allied Telesis label facing up. If you are installing the transceiver in a bottom port, position the transceiver with the label facing down. Refer to Figure 42.

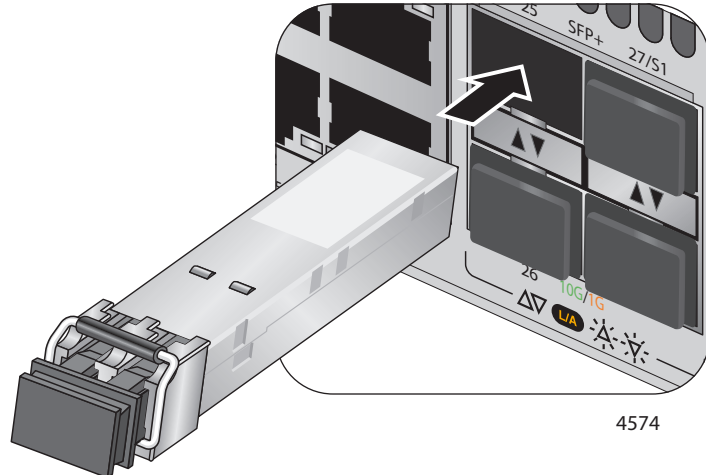

Figure 42. Installing an SFP Transceiver

5. Slide the transceiver into the port until it clicks into place.

Note

If you are ready to attach the fiber optic cable to the transceiver, continue with the next step. Otherwise, repeat steps 1 through 5 to install the remaining transceivers in the switch.

6. Remove the dust cover from the transceiver, as shown in Figure 43.

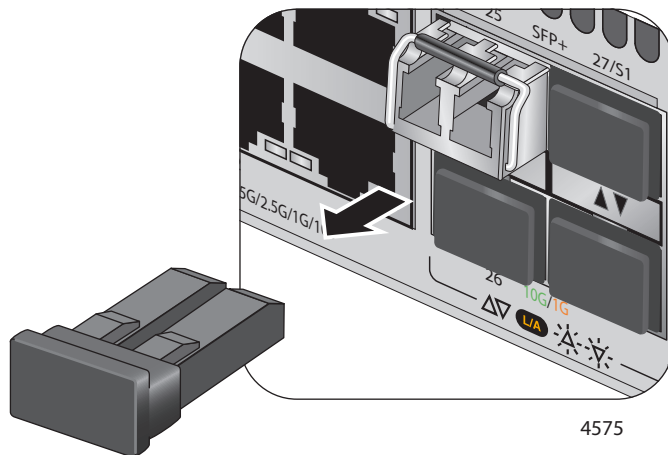

Figure 43. Removing the Dust Cover from an SFP or SFP+ Transceiver

7. Verify the position of the handle on the transceiver. If the transceiver is in a top port, the handle must be in the upright position, as shown in Figure 44. If the transceiver is in a bottom port, the handle must be in the down position.

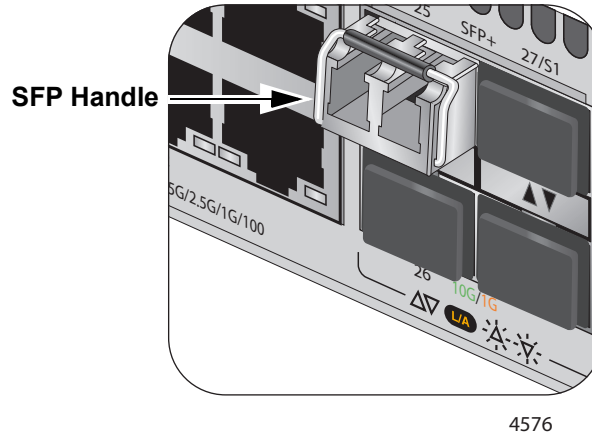

Figure 44. Positioning the SFP or SFP+ Handle in the Upright Position

8. Connect the fiber optic cable to the transceiver, as shown in Figure 45. The connector on the cable must fit snugly into the port, and the tab must lock the connector into place.

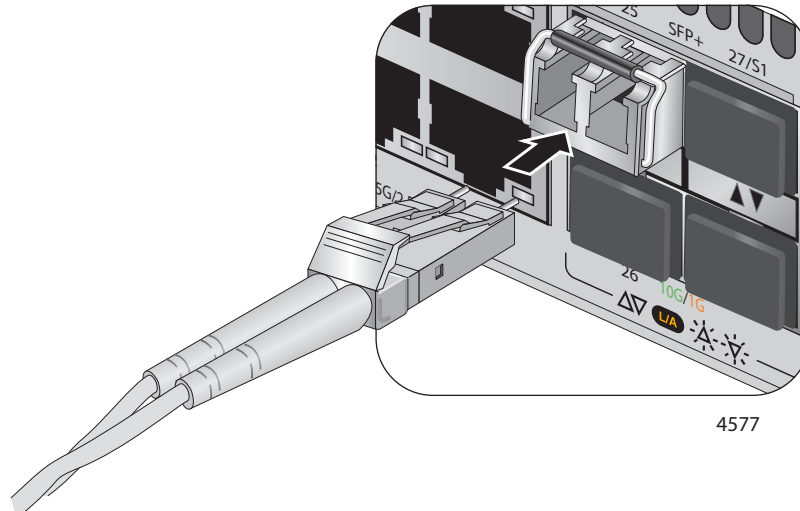

Figure 45. Connecting a Fiber Optic Cable to an SFP or SFP+ Transceiver

9. Repeat this procedure to install additional transceivers.

Installing AT-SP10TW Direct Connect Twinax Cables in the Switches

The SFP/SFP+ transceiver ports of the switches support AT-SP10TW1 and AT-SP10TW3 direct connect twinax cables. They come in lengths of 1 and 3 meters, respectively, and have SFP+ transceivers on both ends. The cables are an economical way to add 10 Gbps connections over short distances.

Note

The AT-x530L-52GPX switch does not support the AT-SP10TS7 direct connect cable.

To install AT-SP10TW cables in the switches, perform the following procedure:

1. Select a port for the transceiver.
2. If the port has a dust cover, remove the cover. Refer to Figure 41 on page 90.
3. Remove the transceiver from its shipping container and store the packaging material in a safe location.
4. To install the transceiver in a port in the top row, position the transceiver with the Allied Telesis label facing up. To install the transceiver in a port in the bottom row, position the transceiver with the label facing down. Refer to Figure 46.

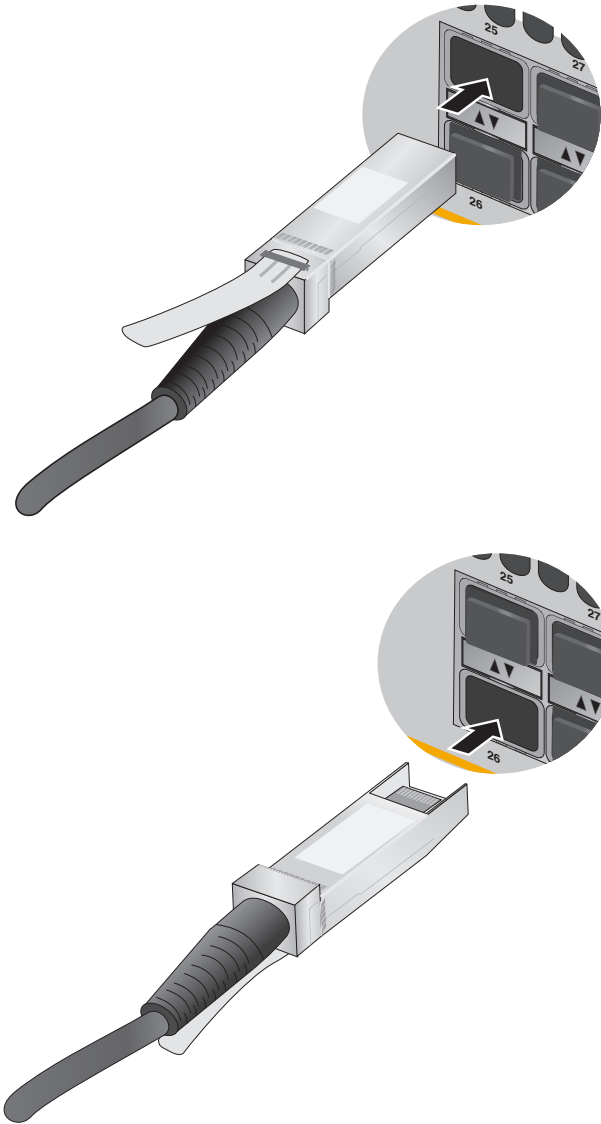

Figure 46. Installing AT-SP10TW Cables

5. Slide the transceiver into the port until it clicks into place.
6. Connect the other end of the cable into an SFP+ port on another network device.
7. Repeat this procedure to install additional transceivers.

Note

To remove the connector and cable from the port, gently push on the connector, pull on the release tab, and slide the connector from the port.

Chapter 9

Troubleshooting

This chapter contains suggestions on how to troubleshoot problems with the switch.

Note

For further assistance, please contact Allied Telesis Technical Support at www.alliedtelesis.com/support.

Problem 1: All the port LEDs and Switch ID LED are off, and the fans are not operating.

Solutions: The unit is not receiving power. Try the following:

- Verify that the power cord is securely connected to the power source and the AC connector on the back panel of the switch.
- Verify that the power outlet has power by connecting another device to it.
- Try connecting the unit to another power source.
- Try a different power cord.
- Verify that the voltage from the power source is within the required levels for your region. The power requirements for the switch are listed in “Power Specifications” on page 102.

Problem 2: All of the port LEDs are off even though the ports are connected to active network devices.

Solution: The switch might be operating in the low power mode. To toggle on the LEDs, press the eco-friendly button on the front panel of the switch. You can also toggle the LEDs off and on with the ECOFRIENDLY LED and NO ECOFRIENDLY LED commands in the command line interface.

Problem 3: A twisted pair port on the switch is connected to an active network device but the port's LINK/ACT LED is off.

Solutions: The port is unable to establish a link to a network device. Try the following:

- ❑ Verify that the network device connected to the twisted pair port is powered on and is operating properly.
- ❑ Try connecting another network device to the twisted pair port with a different cable. If the twisted pair port is able to establish a link, then the problem is with the cable or the other network device.
- ❑ Verify that the twisted pair cable does not exceed 100 meters (328 feet).
- ❑ Verify that you are using the appropriate category of twisted pair cable. Refer to "Cable Requirements" on page 23.
- ❑ Verify that the port is connected to the correct twisted pair cable.

Note

Twisted pair ports may require five to ten seconds to establish a link.

Problem 4: The LINK/ACT LED for an SFP or SFP+ transceiver is off.

Solutions: The fiber optic port on the transceiver is unable to establish a link to a network device. Try the following:

- ❑ Verify that the remote network device connected to the fiber optic port is operating properly.
- ❑ Verify that the fiber optic cable is securely connected to the port on the transceiver and to the port on the remote network device.
- ❑ Check that the transceiver is fully inserted in the port.
- ❑ Verify that the operating specifications of the fiber optic ports on the transceiver and remote network device are compatible.
- ❑ Verify that the correct type of fiber optic cabling is being used.
- ❑ Verify that the port is connected to the correct fiber optic cable.
- ❑ Try connecting another network device to the fiber optic port using a different cable. If the port is able to establish a link, then the problem is with the cable or with the other network device.
- ❑ Use the switch management software to verify that the port is enabled.
- ❑ If the remote network device is a managed device, use the management firmware to determine whether the port is enabled.
- ❑ Test the attenuation of both directions on the fiber optic cable with a fiber optic tester to determine whether the optical signal is too weak (sensitivity) or too strong (maximum input power).

Problem 5: The AT-x530L-28GPX or AT-x530L-52GPX switch is not providing power to a PoE or PoE+ device.

Solutions: Try the following:

- ❑ Review the powered device documentation to confirm that the device supports Mode A of the IEEE 802.3at standard. Mode A is one of two modes that define the connector pins that deliver the power from the port in the switch to the powered device. In Mode A, the power is carried on pins 1, 2, 3, and 6 on the RJ-45 port, the same pins that carry the network traffic. The second mode, Mode B, defines pins 4, 5, 7, and 8 as the power carriers. The AT-x530L-52GPX switch does not support Mode B. Most powered devices are designed to accept power by either mode, but some legacy devices may only support one mode. This can be verified by reviewing the device's documentation or data sheet. Legacy devices that only support Mode B will not work with the switch.
- ❑ Use the SHOW SYSTEM ENVIRONMENT command to confirm that both power supplies are operating normally. The switch might not be able to support all powered devices if one of the power supplies is powered off or has failed. For more information, refer to "Power Budget" on page 26.
- ❑ Check that the power device power requirements do not exceed 30W. This can be verified by reviewing the device documentation or data sheet.
- ❑ Verify that you are using the appropriate category of twisted-pair cable by referring to "Twisted Pair Ports" on page 21.
- ❑ Use the management software on the switch to determine whether PoE is enabled on the port. The default setting for PoE is enabled.
- ❑ Use the management software on the switch to determine whether the PoE power setting for the port has been reduced to a value below the power requirements of the device.
- ❑ Try connecting the device to a different port on the switch.

Problem 6: The switch functions intermittently.

Solutions: Check the system hardware status through the management software:

- ❑ Use the SHOW SYSTEM ENVIRONMENT command in the Privileged Exec mode to verify that the input voltage from the power source to the switch is stable and within the approved operating range. The unit will shut down if the input voltage fluctuates above or below the approved operating range.
- ❑ Use the SHOW SYSTEM ENVIRONMENT command in the Privileged Exec mode to verify that the fan is operating correctly.
- ❑ Verify that the location of the switch allows for adequate airflow. The unit will shut down if it is overheating.

Problem 7: The Switch ID LED on the front of the switch is flashing the letter “F.”

Solutions: One or more of the following problems has occurred:

- ❑ A cooling fan has failed.
- ❑ The switch might be overheating and may have to shut down.

Contact your Allied Telesis sales representative for assistance.

Appendix A

Technical Specifications

This appendix contains the following sections:

- "Physical Specifications" on page 100
- "Environmental Specifications" on page 101
- "Power Specifications" on page 102
- "Certifications" on page 103
- "RJ-45 Twisted Pair Port Pinouts" on page 104
- "RJ-45 Style Serial Console Port Pinouts" on page 106
- "USB Port" on page 107

Physical Specifications

Dimensions

Table 7 lists the dimensions of the switches.

Table 7. Product Dimensions

Model	Dimension (L x H x D)
AT-x530L-52GPX	44.05 cm x 4.37 cm x 42.06cm (17.344 in. x 1.72 in. x 16.56 in.)

Weights

Table 8 lists the weights of the switches.

Table 8. Product Weights

AT-x530L-52GPX	6.71 kg (14.8 lb)
----------------	-------------------

Ventilation

Table 9 lists the ventilation requirements.

Table 9. Ventilation Requirements

Recommended Minimum Ventilation on All Sides	10 cm (4.0 in)
--	----------------

Environmental Specifications

Table 10 lists the environmental specifications of the switches.

Table 10. Environmental Specifications

Operating Temperature	0° C to 50° C (32° F to 122° F)
Storage Temperature	-25° C to 70° C (-13° F to 158° F)
Operating Humidity	5% to 90% noncondensing
Storage Humidity	5% to 95% noncondensing
Maximum Operating Altitude	3,000 m (9,842 ft)
Maximum Nonoperating Altitude	4,000 m (13,100 ft)
Product Noise Level	Less than 42 dB @ 30C or less
Installation Requirement	Tabletop, wall or rack mount

Power Specifications

This section contains the maximum power consumption values, input voltages, and heat dissipation values.

Maximum Power Consumption

Table 11 lists the maximum power consumption for the switches.

Table 11. Maximum Power Consumption

AT-x530L-52GPX	950 watts
----------------	-----------

Input Voltages

Table 12 lists the input voltage for the switches.

Table 12. Input Voltage

AT-x530L-52GPX	100-240 VAC, 50/60 Hz, 6 A (per input) (x2)
----------------	--

Heat Dissipation

Table 13 lists the heat dissipation for the switches.

Table 13. Heat Dissipation

AT-x530L-52GPX	3241 BTU/hr
----------------	-------------

Certifications

Table 14 lists the product certificates.

Table 14. Product Certifications

EMI (RFI Emissions)	FCC Class A, EN55032 Class A, EN61000-3-2, EN61000-3-3, VCCI Class A, RCM
EMC (Immunity)	EN55024
Electrical and Laser Safety	EN60950-1 (TUV), UL 60950-1 (CULUS), CSA-C22-2 No. 60950-1 (CULUS), EN60825-1 (TUV), UL 62368-1
Compliance Marks	CE, cUL _{US} , TUV
RoHS and WEEE	Complies with RoHS 6 Complies with China RoHS

RJ-45 Twisted Pair Port Pinouts

Figure 47 illustrates the pin layout of the RJ-45 connectors on the front panel of the switch.

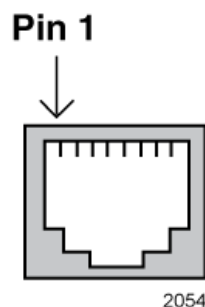

Figure 47. RJ-45 Socket Pin Layout (Front View)

Table 15 and Table 16 on page 105 list the pin signals.

Table 15. Pin Signals at 10M/100M

Pin	10 Mbps/ 100 Mbps MDI Signal	10 Mbps/ 100 Mbps MDI-X Signal
1	TX+	RX+
2	TX-	RX-
3	RX+	TX+
4	Not used	Not used
5	Not used	Not used
6	RX-	TX-
7	Not used	Not used
8	Not used	Not used

Table 16. Pin Signals at 1 Gbps

Pin	1 Gbps MDI Signal	1 Gbps MDI-X Signal
1	BI_DA+	BI_DB+
2	BI_DA-	BI_DB-
3	BI_DB+	BI_DA+
4	BI_DC+	BI_DD+
5	BI_DC-	BI_DD-
6	BI_DB-	BI_DA-
7	BI_DD+	BI_DC+
8	BI_DD-	BI_DC-

RJ-45 Style Serial Console Port Pinouts

Table 17 lists the pin signals of the RJ-45 style serial console port.

Table 17. RJ-45 Style Serial Console Port Pin Signals

Pin	Signal
1	RTS#
2	Not used
3	Transmit Data
4	Ground
5	Ground
6	Receive Data
7	Not used
8	CTS

USB Port

Table 18 lists the pin signals of the USB port.

Table 18. USB Port Pin Signals

Pin	Signal
1	+5V
2	DATA-
3	DATA+
4	NC
5	GND

